

ADJUSTMENT

Equipment Required

- Audio signal generator.
- Level meter.
- Oscilloscope.
- Digital frequency counter, 0 – 100 kHz.
- FM multiplex signal generator.
- Circuit tester.

FM RF Tracking (PSTU031COX)

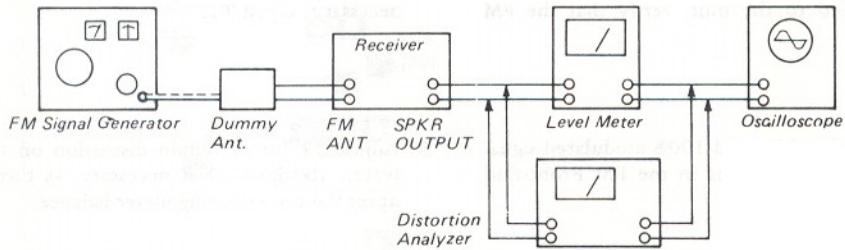

- 1) Apply 90 MHz, 1 kHz and 100% modulated, 65 dBf signal with 76 kHz deviation to the FM antenna terminal.
- 2) Tune the unit to 90 MHz.
- 3) Observe the oscilloscope connected to the Speaker output terminal for symmetrical sine wave. If failed, adjust T5.
- 4) Adjust T1 through T4 for maximum level meter reading (connected in parallel with the scope).
- 5) Adjust the signal generator for 106 MHz, and retune the unit. Adjust CT8 to tune in.
- 6) Adjust CT1, CT2, CT4 and CT6 for maximum level meter reading.
- 7) Repeat above procedure again until no further improvement is obtained.

FM IF Amplifier (PSTU041COX)

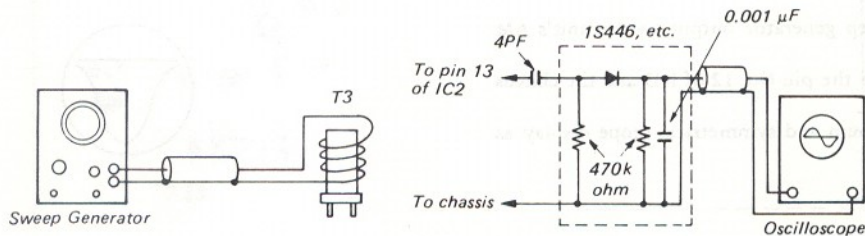

- 1) Mute the FM local oscillator by shorting CV8.
- 2) Apply 10.7 MHz signal from the sweep generator to T3 in the manner shown as above.
- 3) Adjust T6 and T7 for correct figure as provided below. It may be necessary to increase or decrease the sweep generator output for adjustment convenience.



Correct



Incorrect, as too low



Incorrect, as too narrow

Pilot Signal (76 kHz) (PSTU032COX – 380R/PSTU038COX – 390R)

- 1) Apply 98 MHz, 65 dBf signal to the unit with no modulation.
- 2) Adjust RV4 for 76 kHz ± 200 Hz reading on the frequency

counter connected between TP (test point) and chassis ground. The deviation within ± 200 Hz is acceptable.

Stereo Separation

- 1) Apply 98 MHz, 65 dBf left channel composite signal to the unit modulated with 1 kHz, 9% pilot signal with 6.75 kHz deviation.
- 2) Connect a digital voltmeter to the right channel speaker output terminal.
- 3) Adjust RV5 for minimum leakage (minimum level) on the voltmeter.

- 4) Apply 98 MHz, 65 dBf right channel composite signal to the unit modulated same as step 1).
- 5) Move digital voltmeter to the left channel speaker output terminal.
- 6) Observe the right channel leakage appeared on the left channel output. If necessary, readjust RV5 for equal and minimum level at both channels.

FM Center-Tuning Meter

- 1) Remove the signal generator output from the unit.
- 2) With no signal supplied to the unit, verify that the FM

Center-tuning meter reads exact center of the scale. If necessary, adjust T1.

FM Distortion

- 1) Apply 98 MHz, 65 dBf, 1 kHz and 100% modulated signal to the unit, using same manner as in the FM Front-End set-up.

- 2) Adjust T2 for minimum distortion on the distortion analyzer. Readjust T1 if necessary, as turning T2 core may upset the center-tuning meter balance.

Signal Strength Meter

- 1) Apply 98 MHz, 90 dBf signal to the unit.
- 2) Tune the unit to 98 MHz.

- 3) Adjust RV2 for about 90% reading on the signal-strength meter.

FM Mute Circuit

- 1) Apply 98 MHz, 20 dBf signal to the unit.
- 2) Tune the unit to 98 MHz.

- 3) Place the Mute switch in on.
- 4) Adjust RV1, turning slowly until the signal is muted.

AM IF Amplifier

- 1) Apply 455 kHz sweep generator output to the unit's AM Antenna terminal.
- 2) Connect the scope to the pin No. 12 of IC3 and the chassis ground.
- 3) Adjust T4 for maximum and symmetrical scope display as shown below.



AM Tracking

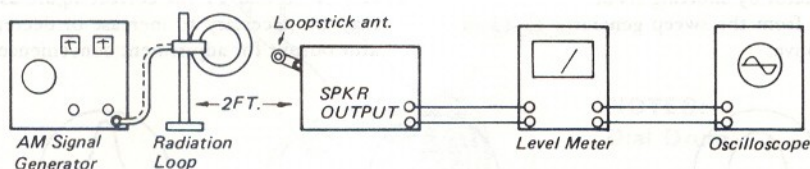

Scott 380R,390R

- 1) Apply 600 kHz, 30% modulated with 1 kHz to the AM bar antenna, as shown above. (Distance between the AM bar antenna and emitting loop should be about 2 feet).
- 2) Adjust the signal generator output so that a sine wave appears on the scope.
- 3) Adjust T6 for maximum audio output on the digital voltmeter connected parallel with the scope. When turning the core it may be necessary to reduce the signal generator output so that signal strength is only slightly above the noise level. This minimizes AGC action and will provide maximum alignment accuracy.
- 4) Adjust the AM loopstick antenna core for maximum output on the voltmeter.
- 5) Shift the generator frequency to 1400 kHz with same modulation condition. Retune the unit.
- 6) Adjust CT5 (dial frequency adjustment) + CT3 + CT7 (tracking) for maximum audio output.
- 7) Repeat above procedure at both frequencies, until no further improvement is obtained.
- 8) Verify the dial frequency indication on 1000 kHz.

Adjustment Location (RF Section)

PSTU032COX (380R)

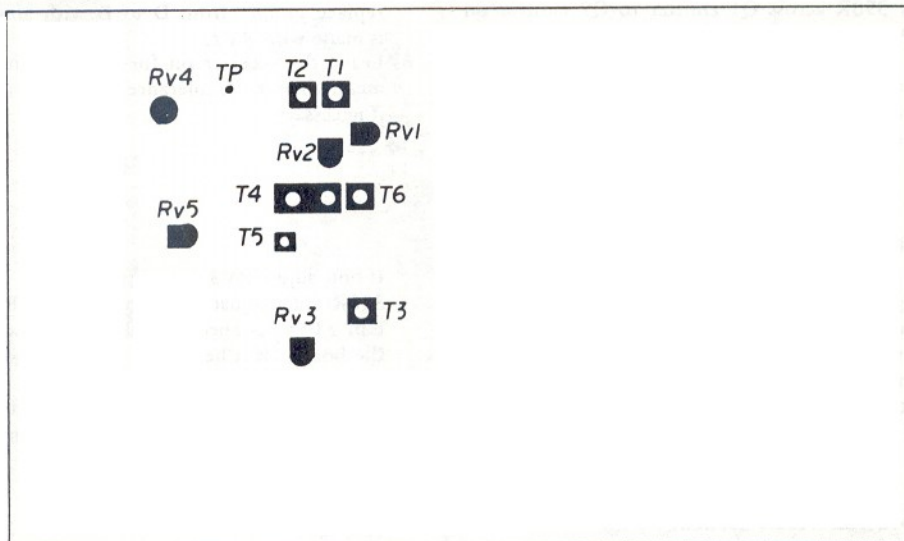

PSTU038COX (390R)

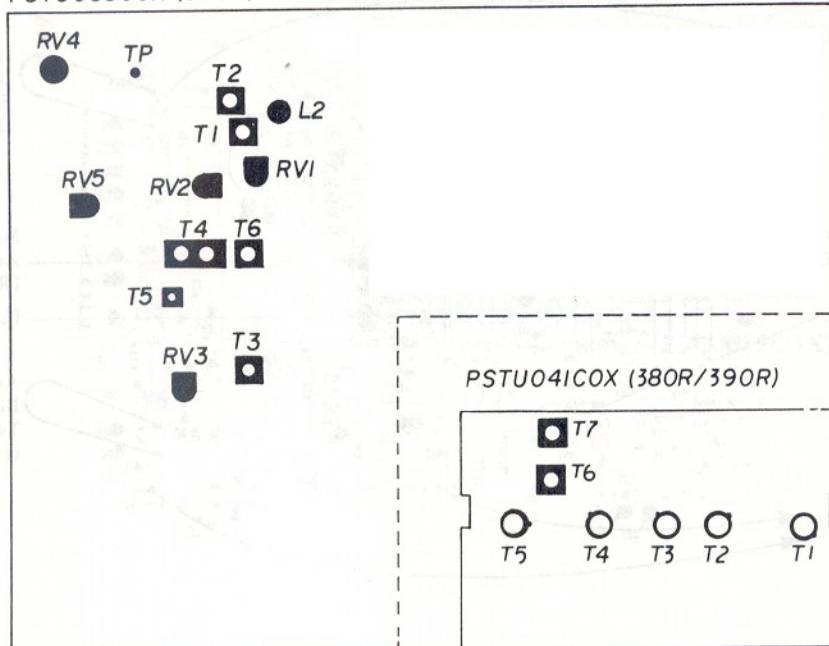

Audio Adjustment (PSMA030COX)

Equipment Required

- Audio signal generator.
- DC voltmeter.
- Speaker load resistor, 8 ohm, 200W, noninductive.
- Digital voltmeter or milliammeter.

Bias Adjustment

The following adjustments are the same for both the left and right channels.

- 1) Connect 8 Ohm resistors to the speaker A terminals, and set the Speaker Mode switch to A position.
- 2) Turn the Volume control fully counterclockwise.
- 3) Turn RV1 fully counterclockwise.
- 4) Depending on available equipment, use A or B.

A. Set digital voltmeter to most sensitive range. Connect probes, for 390R across Q1 emitter to Q7 emitter on PC board PTZQ008COX, for 380R across R37 and R39 (voltmeter bias test point, left channel). Turn unit on. Let it idle at least one minute. Adjust RV1 for 30 mV across the resistors.

B. With unit off, remove jumper between PC board ter-

minals E and E, and connect ammeter, set to 100 mA range.

Turn unit on and let it idle for at least one minute. Adjust RV1 for 60 mA.

- 5) Perform the same procedure for the right channel, except measure voltage across Q2 emitter to Q8 emitter on PC board PTZQ008COX for 390R, and across R38 and R40 for 380R (voltmeter bias test point, right channel) or replace jumper from D to D with ammeter. Adjustment is made with RV2.
- 6) Leave the receiver on for about 30 minutes, then recheck measurement. A tolerance of $\pm 25\%$ is acceptable. Readjust if necessary.

Power Meter Calibration

- 1) Connect the audio signal generator to the receiver and apply 1 kHz signal to Aux input, left channel.
- 2) Connect voltmeter across the left channel load resistor.
- 3) Turn power on.
- 4) Adjust the signal generator output so as to obtain 2.83 volts on the voltmeter.
- 5) 380R: Check that the left channel meter indicates 1 watt.

If not, adjust RV3.

390R: a. Adjust RV1 on PC board PSLD025COX to obtain 2.05V, connecting voltmeter between TP1 and TP2 on the board. b. Check that the LED indicating 1 watt turns on. If not, adjust RV3.

- 6) Perform above steps on the right channel, adjusting RV4 for 380R, RV2 and RV4 for 390R, if necessary.

Adjustment Location (Audio Section)

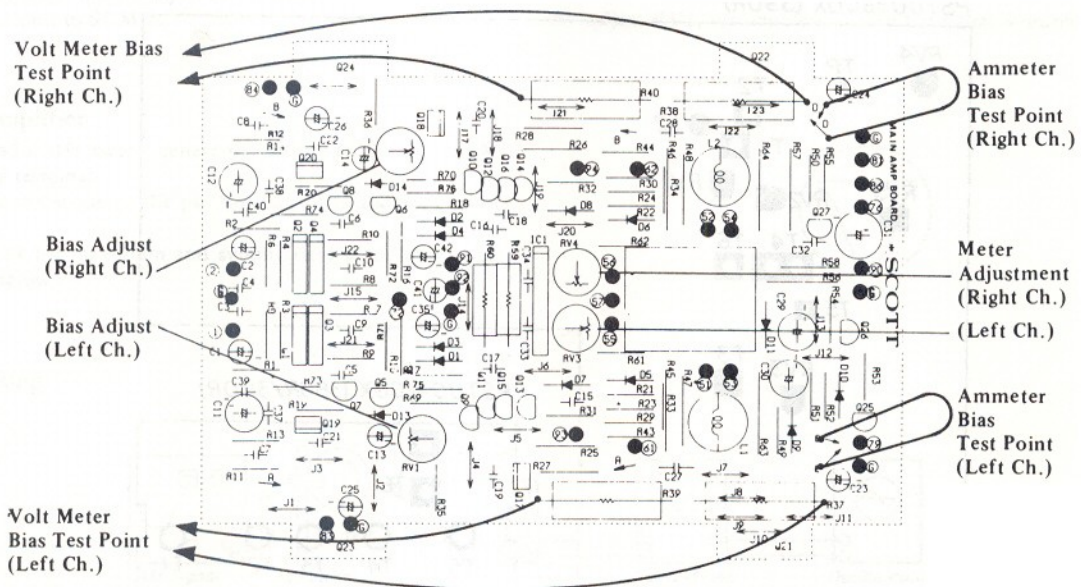

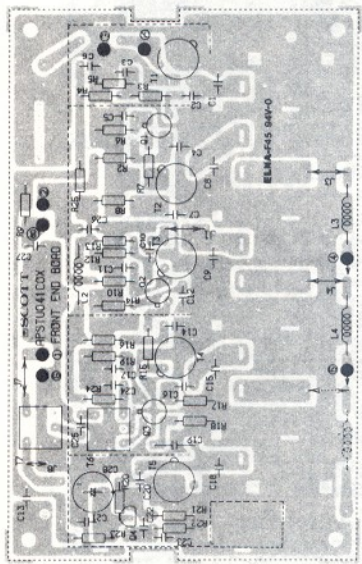

FM Front-End [PSTU041COX]
(380R/390R)

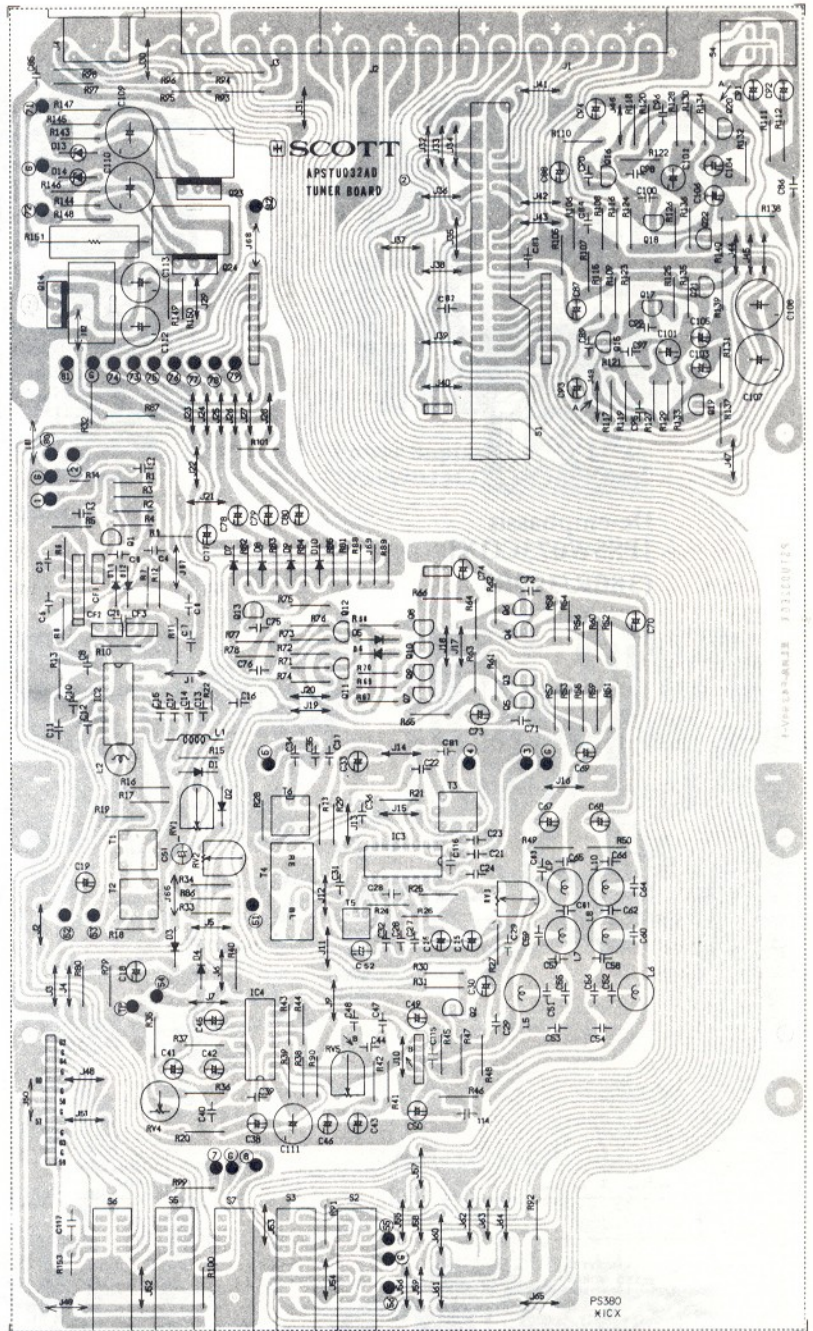

FM IF/Det-AM Tuner/Preamplifier [PSTU032COX] (380R)

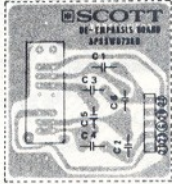

De-emphasis
[PSSW073COX]
(380R/390R)

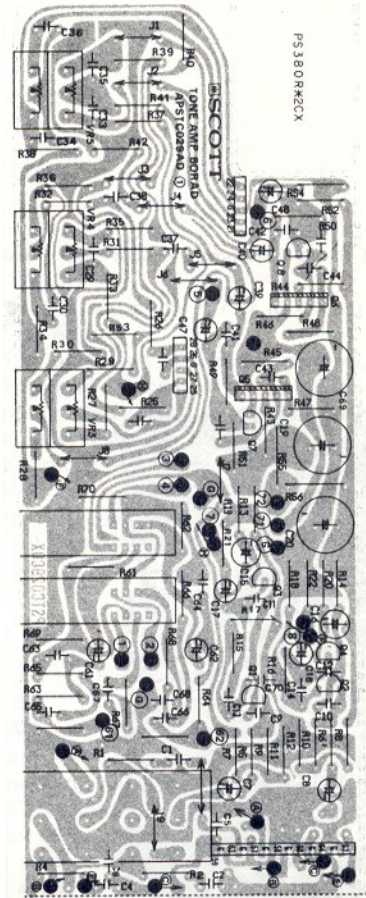

Control Amplifier
[PSTC029COX]
(380R)

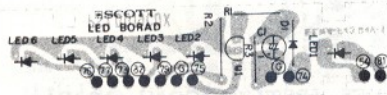

Program LED
[PSLD019COX]
(380R)

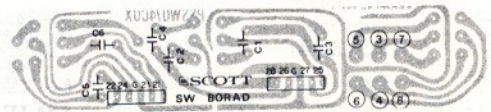

Turn-over
[PSSW074COX]
(380R)

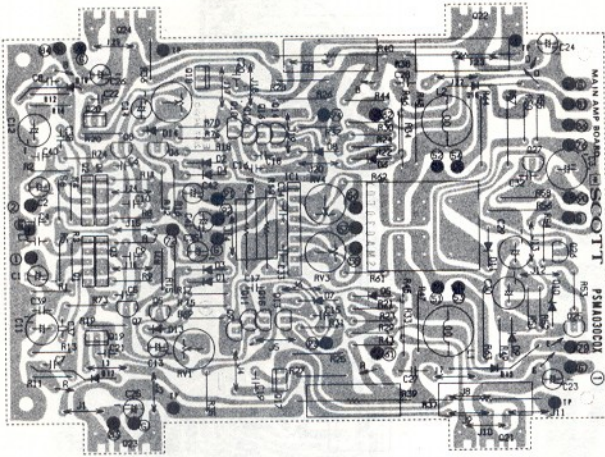

Power Amplifier [PSMA030COX] (380R/390R)

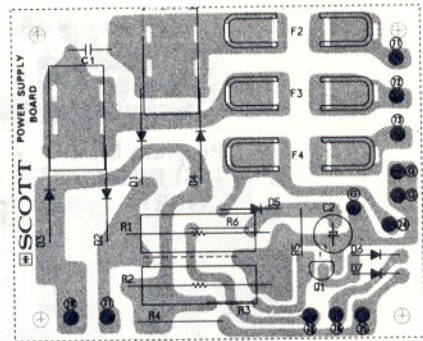

Power Supply [PSPW033COX] (380R)

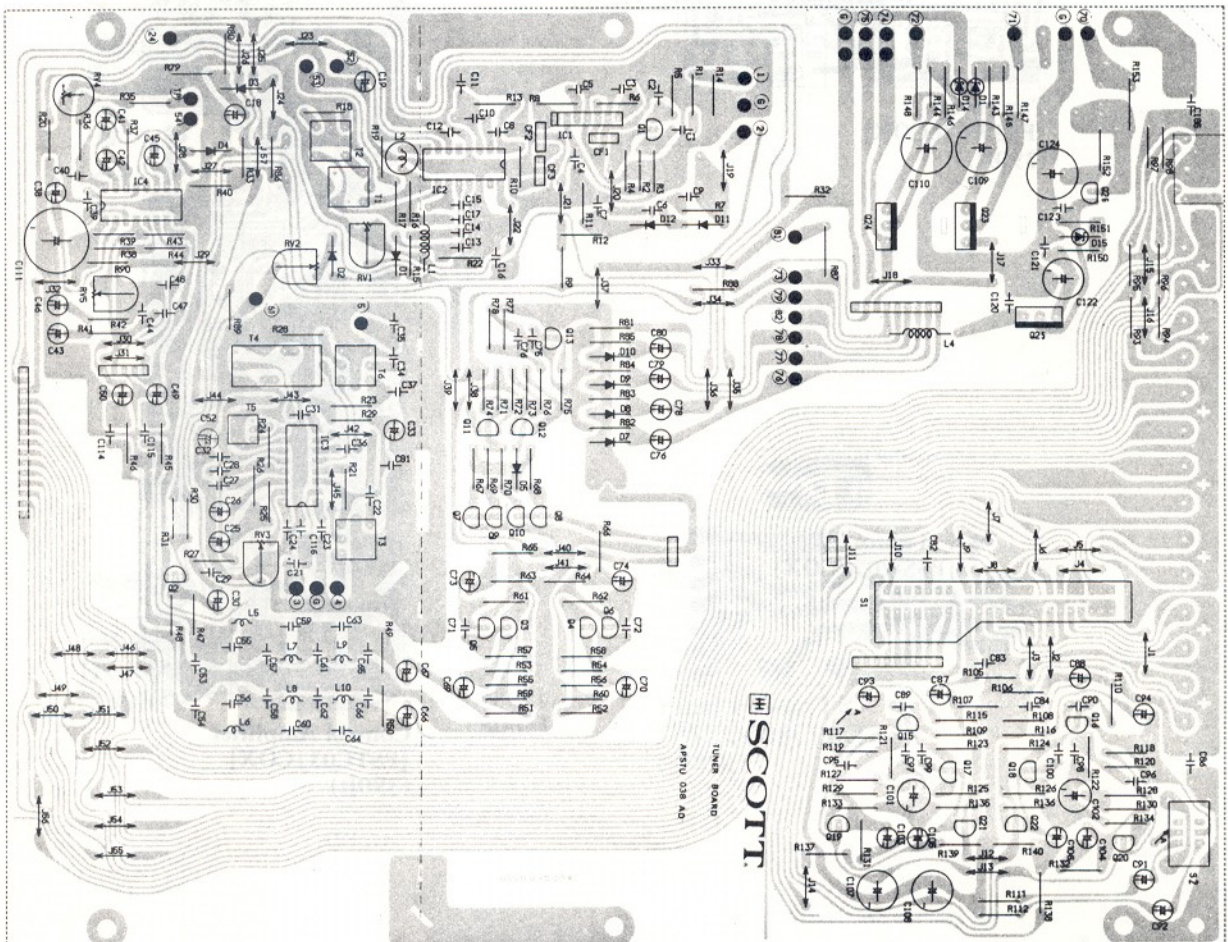

FM IF/Det-AM Tuner/Preamplifier [PSTU038COX] (390R)



Program LED
[PSLD026COX]
(390R)

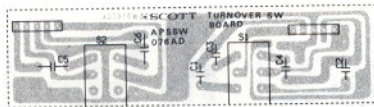

Turn-over
[PSSW076COX]
(390R)



FM Mute SW
[PSSW077COX]
(390R)

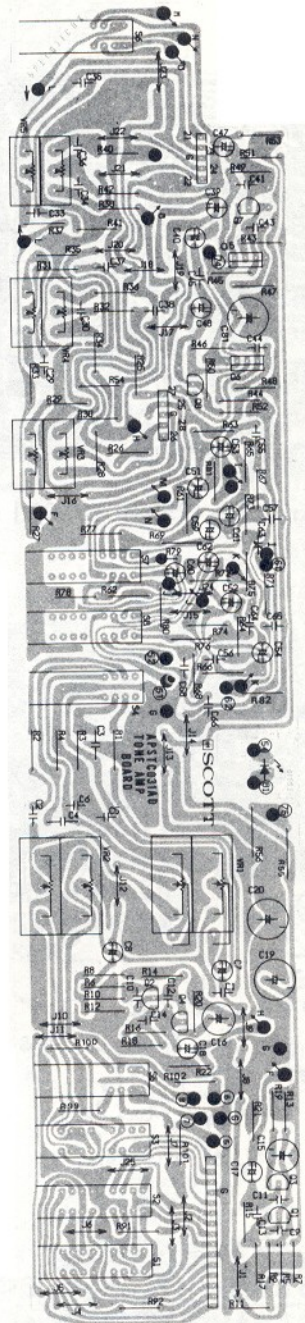

Control Amplifier
[PSTC031COX]
(390R)

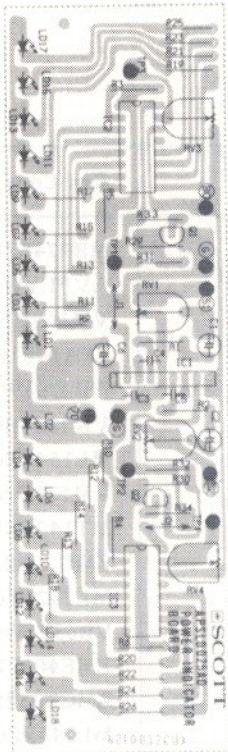

**Level LED
[PSLD025COX]
(390R)**

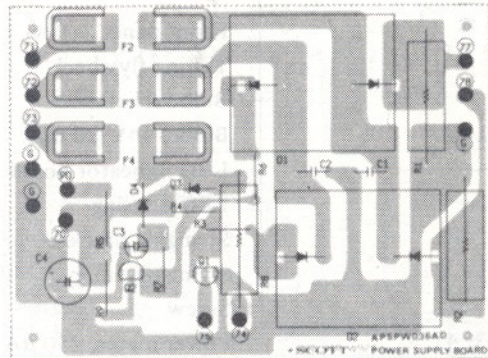

Power Supply [PSPW036COX] (390R)



**FM Stereo LED
[PSLD016COX]
(390R)**

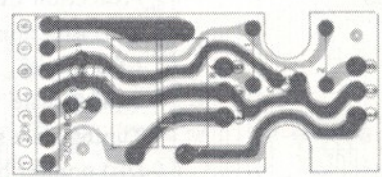

**Final Power TR
[PSZQ008COX]
(390R)**

REPLACEMENT PARTS LIST

Mechanical: 380R

Exploded View No.	Description	Part Code	
(PL1-6)	Front panel	MB974SZ004	
	Tuning flywheel	AVFLYWL009	
	Bulbe relief	VM165RX001	
	Bulbe, 14V/80 mA	ZPA148103U	
	LED indicator board	PSLD019COX	
	LED housing	VK226SB001	
	Stringing bracket	ML154SZ001	
	Stringing pulley	VM173DN001	
(M3, 4)	Screw	MT142SN001	
	Power meter, 250 μ A	ZMD2052K01	
	Meter mount bridge	ML742SZ011	
(M2)	Meter housing	VB632SW001	
(M1)	Center tune meter, $\pm 250 \mu$ A	ZMF4052K02	
(M1)	Signal strength meter, 500 μ A	ZMG2052N02	
	Stringing bracket	ML241SZ003	
	Coil spring	MW141LY002	
	Bearing	VF221DN001	
	Pointer guide	MS926SZ001	
	Control amplifier board	PSTC029COX	
	Turn-over switch board	PSLD019COX	
	(J7)	Headphone jack	YJS03S016Z
	(S1)	Power/Speaker switch, UL listed	SU025108VA
		Shade	VK261SB001
(LD1)	Tuning escutcheon	ME96EAA005	
	LED relief	MT165BC001	
	Protection LED	QLAGD4505R	
	LED isolation	VM162RX001	
	LED socket	YSZ020002U	
	Tuning scale	VS943AC001	
	Tuning scale support	VS945VM001	
	Dial pointer bracket	VK131NB001	
	Dial pointer	MJ311Bc002	
	Power supply chassis	MU865SZ003	
(PT)	Power transformer	TPAA5A004Y	
(C3, 4)	Electrolytic capacitor, 10,000 μ F/63WV	CEJ1H10306	
	Wiring bridge	MP363SS001	
	Power supply board	PSPW033COX	
	PC board mounting piece	VX311NN001	
(F2, 3)	Fuse, 7A	ZFBQ70201Z	
(F4)	" 1A	ZFBQ10203Z	
	Heatsink mount bracket	MS867SZ003	
	Chassis bridge, left	MU853SZ001	
	Heatsink	MH776AA001	
	Power amplifier board	PSMA030COX	

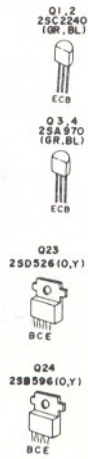
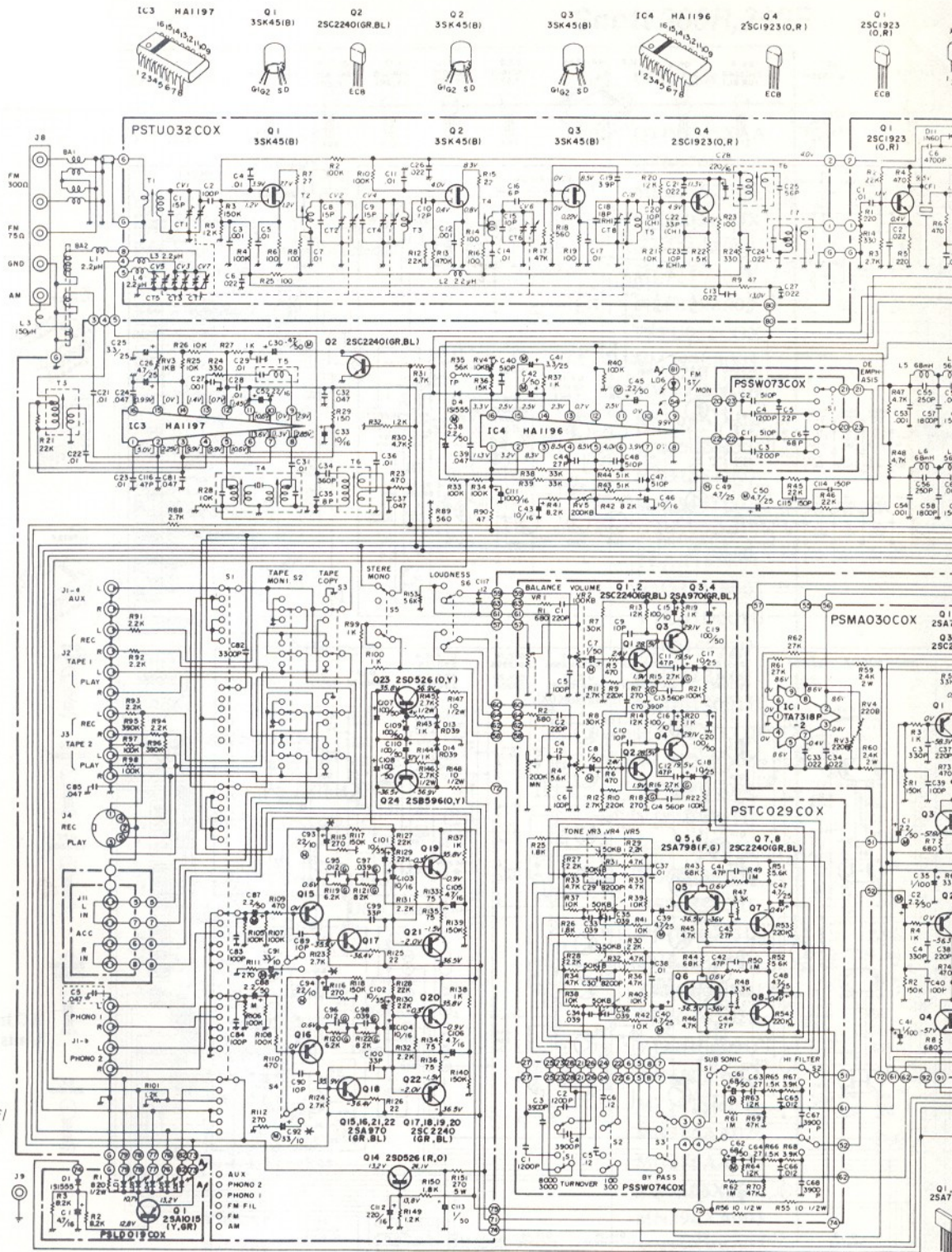

*C91, 92, 93, 94 are replaced with 100µF/6.3V for US/Canada version units.



NOTE: 1. ALL VOLTAGES MEASURED FROM COMMON NEGATIVE CHASSIS GROUND WITH VTVM AT NO SIGNAL
 2. CAPACITORS VALUES ARE IN µF UNLESS OTHERWISE NOTED P= PICO FARAD
 3. RESISTORS VALUES ARE IN OHM K=K OHM 4. VOLTAGES IN () WHEN MUTE ON
 5. VOLTAGES IN () WHEN AM



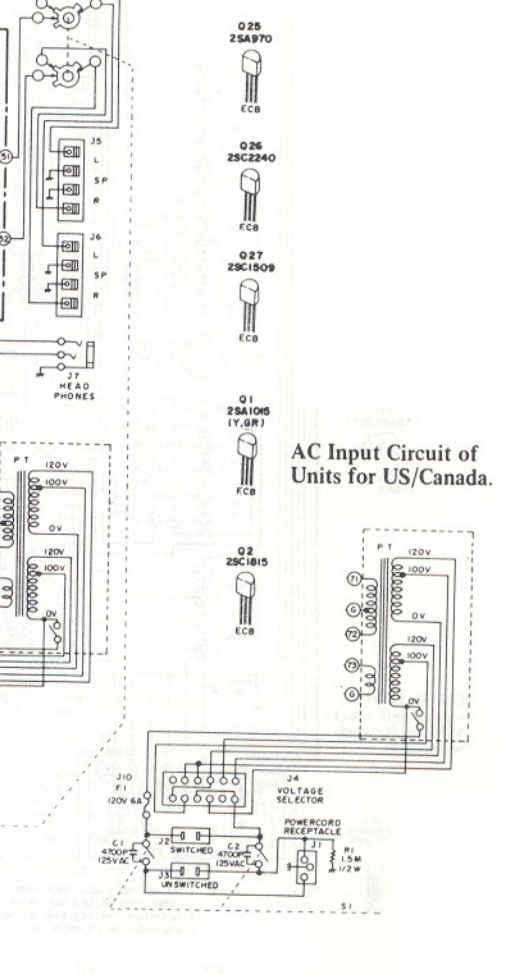
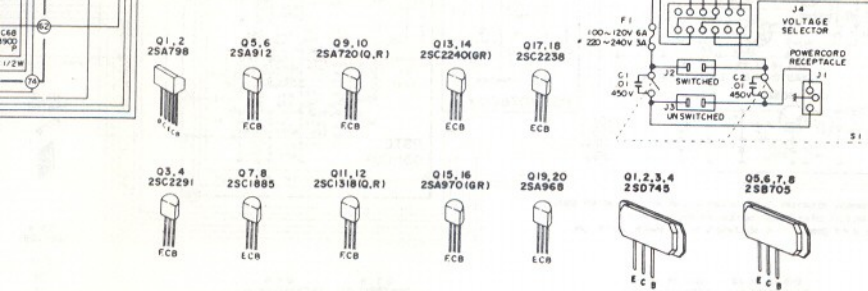
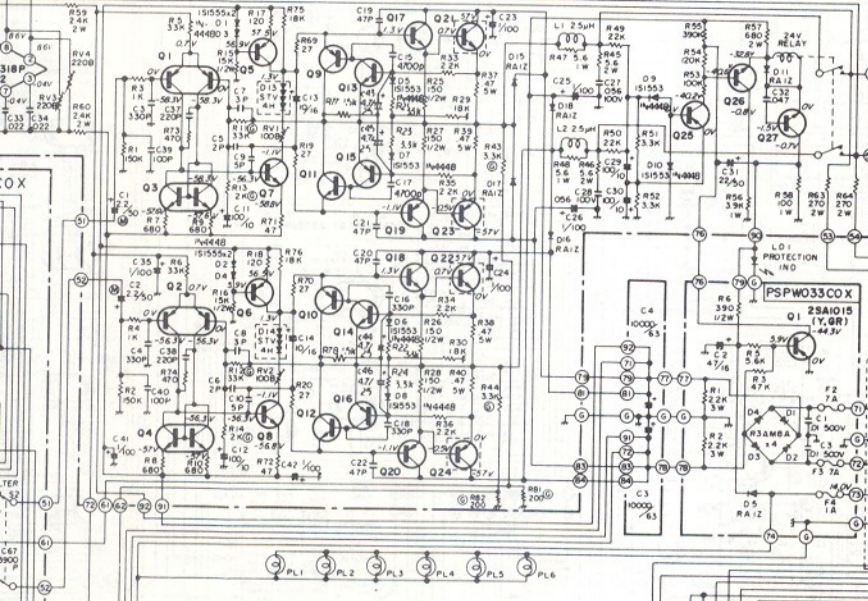
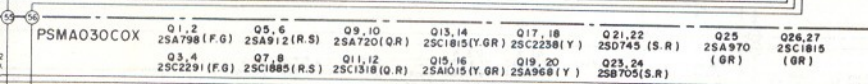
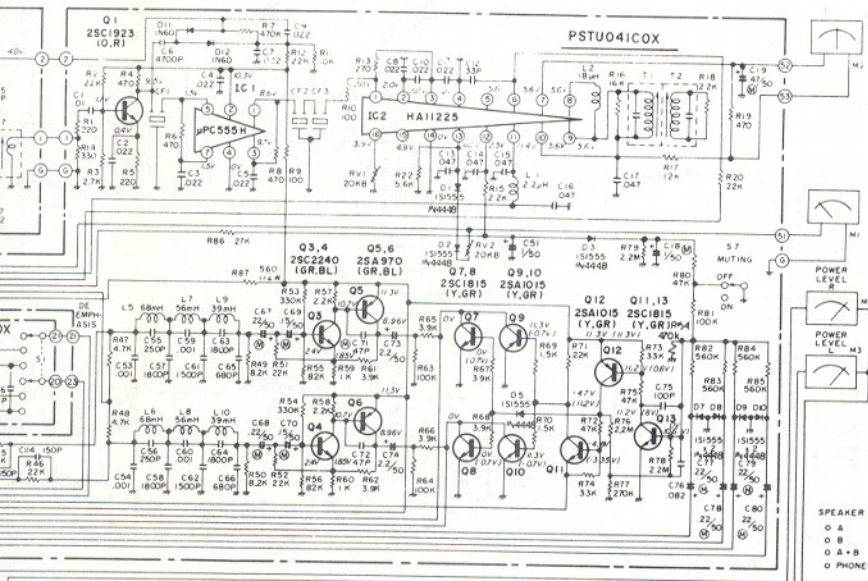
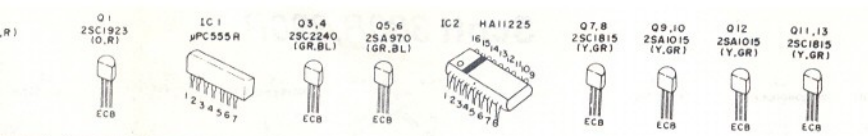

AC Input Circuit of Units for US/Canada.

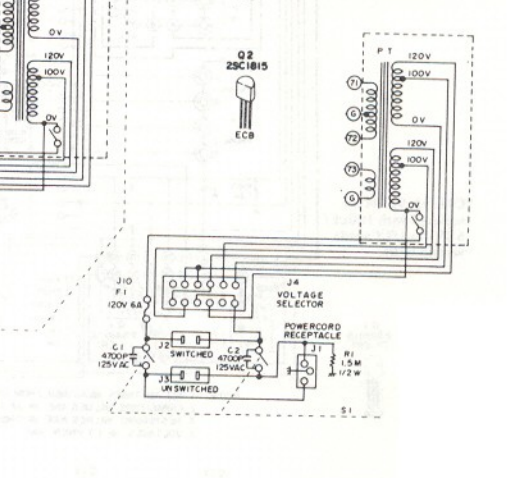

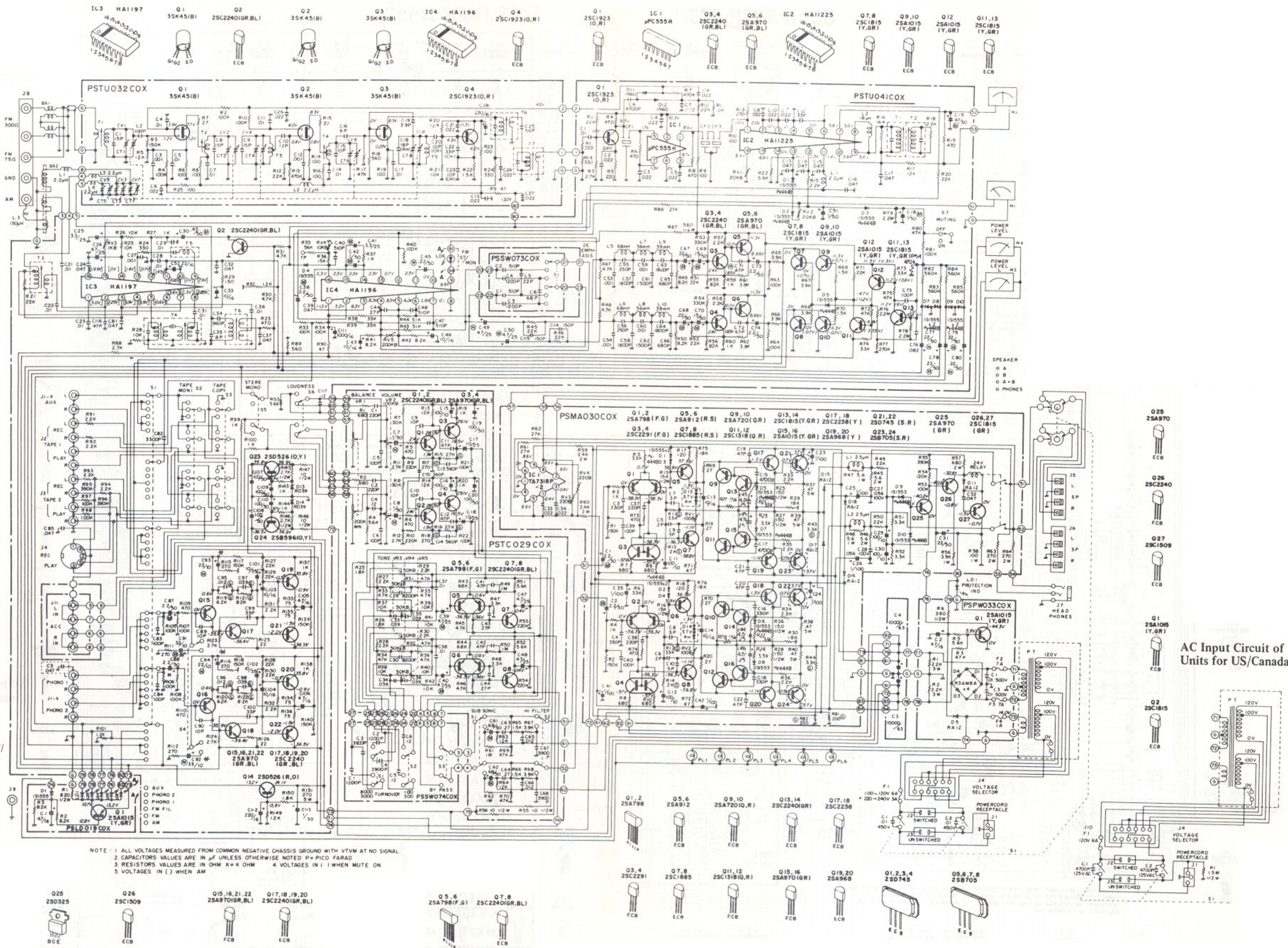

*C91, 92, 93, 94 are replaced with 100µF/6.3V for US/Canada version units.

NOTE: 1. ALL VOLTAGES MEASURED FROM COMMON NEGATIVE CHASSIS GROUND WITH VTVM AT NO SIGNAL
 2. CAPACITORS VALUES ARE IN µF UNLESS OTHERWISE NOTED P= PICO FARAD
 3. RESISTORS VALUES ARE IN OHM K=K OHM M=MEG OHM 4. VOLTAGES IN () WHEN MUTE ON
 5. VOLTAGES IN () WHEN AM

AC Input Circuit of Units for US/Canada.

Scott 380R, 390R

390R

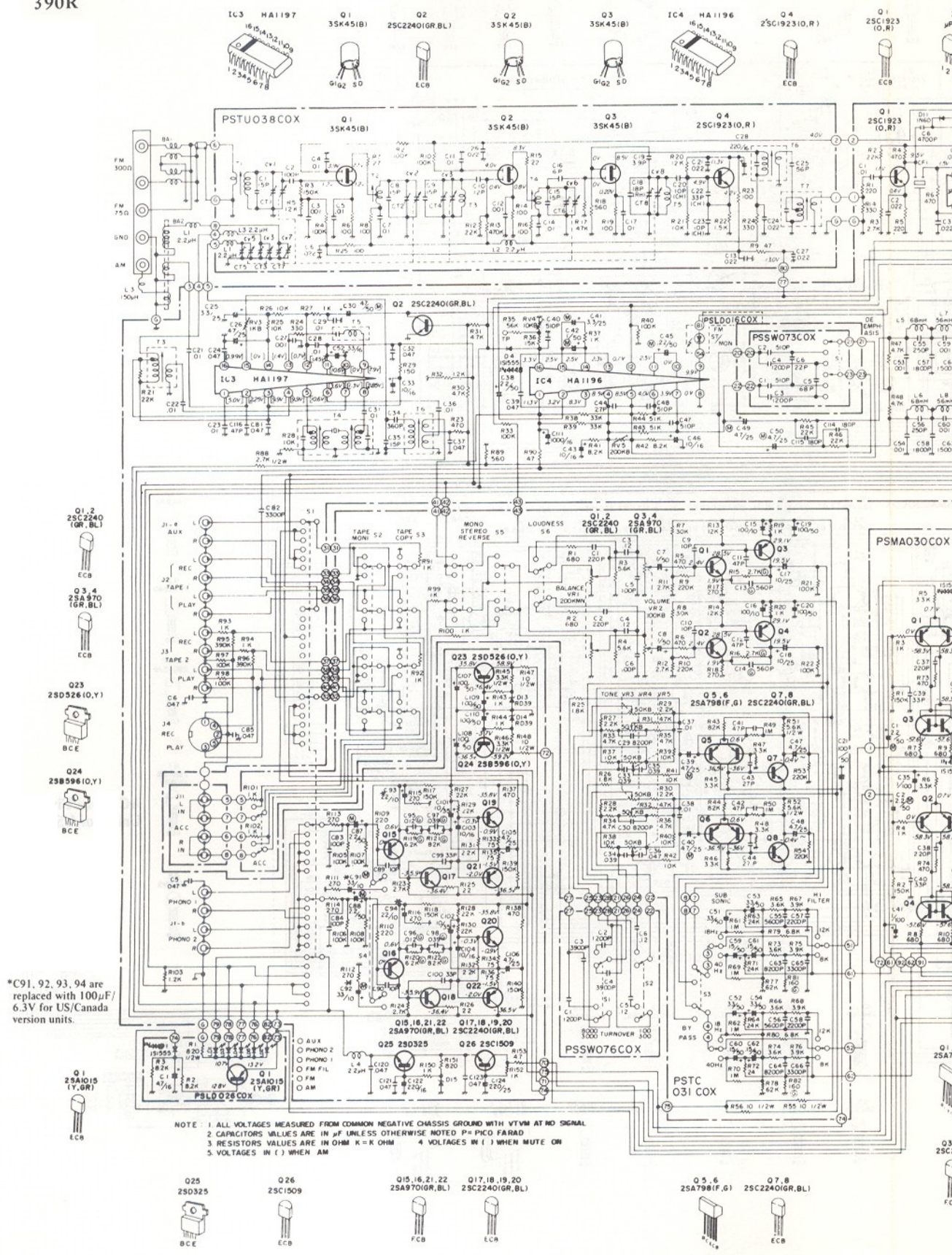

*C91, 92, 93, 94 are replaced with 100µF/6.3V for US/Canada version units.

NOTE: 1. ALL VOLTAGES MEASURED FROM COMMON NEGATIVE CHASSIS GROUND WITH VTM AT NO SIGNAL.
 2. CAPACITORS VALUES ARE IN µF UNLESS OTHERWISE NOTED P= PICO FARAD
 3. RESISTORS VALUES ARE IN OHM K=R OHM 4. VOLTS IN () WHEN MUTE ON
 5. VOLTS IN () WHEN AM

Q1
25A1015
(Y,GR)
ECB

Q1, 2
25C2240
(GR, BL)
ECB

Q3, 4
25A970
(GR, BL)
ECB

Q23
25D526 (I, Y)
BCE

Q24
25B596 (I, Y)
BCE

Q25
25D325
BCE

Q26
25C1509
ECB

Q15, 16, 21, 22
25A970 (GR, BL)
FCB

Q17, 18, 19, 20
25C2240 (GR, BL)
ECB

Q5, 6
25A798 (F, G)
ECB

Q7, 8
25C2240 (GR, BL)
ECB

Q3,
25C2240
FCB

- Q1 25C1923 (O,R)
- IC1 μ PC555H
- Q3,4 25C2240 (GR,BL)
- Q5,6 25A970 (GR,BL)
- IC2 HA11225
- Q7,8 25C1815 (Y,GR)
- Q9,10 25A1015 (Y,GR)
- Q12 25A1015 (Y,GR)
- Q11,13 25C1815 (Y,GR)
- Q1,2 25C1685(R)

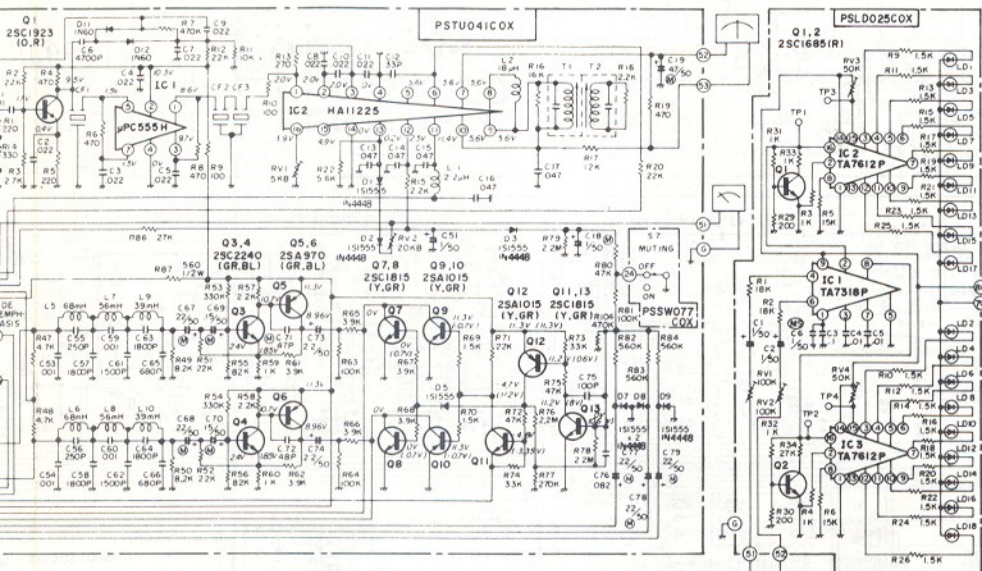

- IC2 TA7612P
- IC1 TA7318P
- IC3 TA7612P

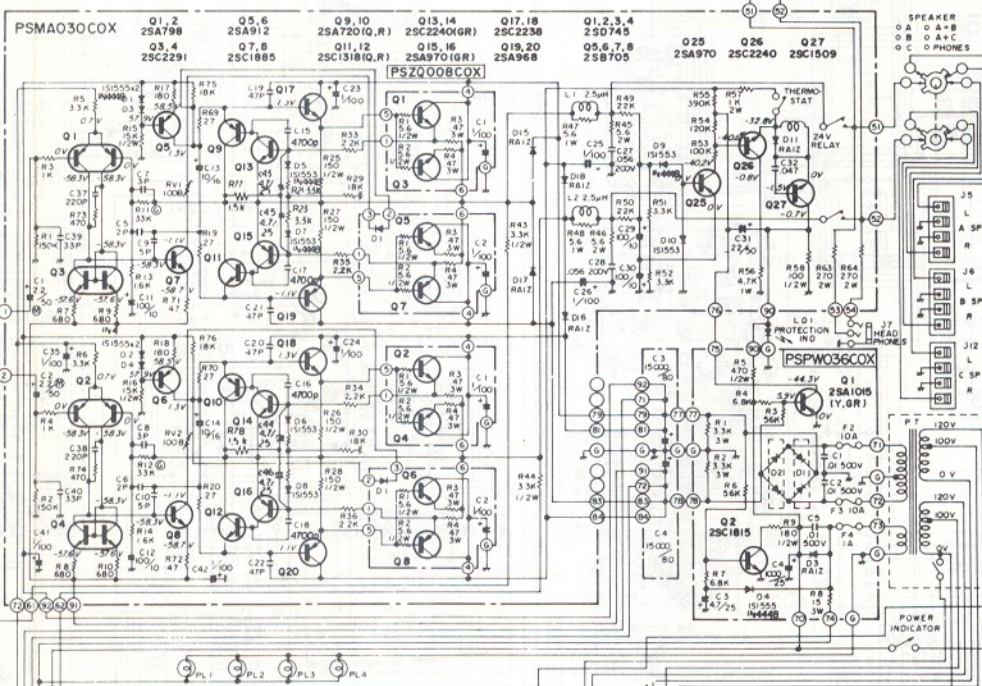

- Q25 25A970
- Q26 25C2240
- Q27 25C1509
- Q1 25A1015 (Y,GR)
- Q2 25C1815

AC Input Circuit of Units for US/Canada.

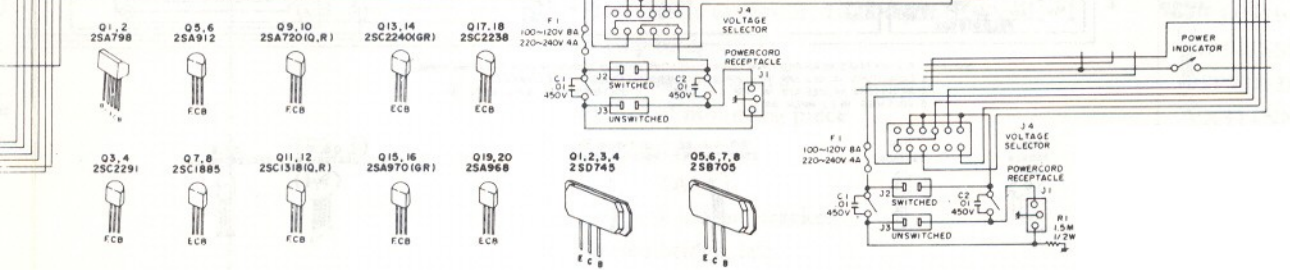

- Q1,2 25A798
- Q5,6 25A912
- Q9,10 25A720(Q,R)
- Q13,14 25C2240(GR)
- Q17,18 25C2238
- Q3,4 25C2291
- Q7,8 25C1885
- Q11,12 25C1318(Q,R)
- Q15,16 25A970(IGR)
- Q19,20 25A968
- Q1,2,3,4 25D745
- Q5,6,7,8 25B705

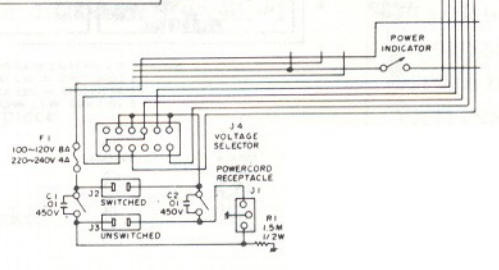
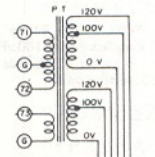

Scott 380R, 390R

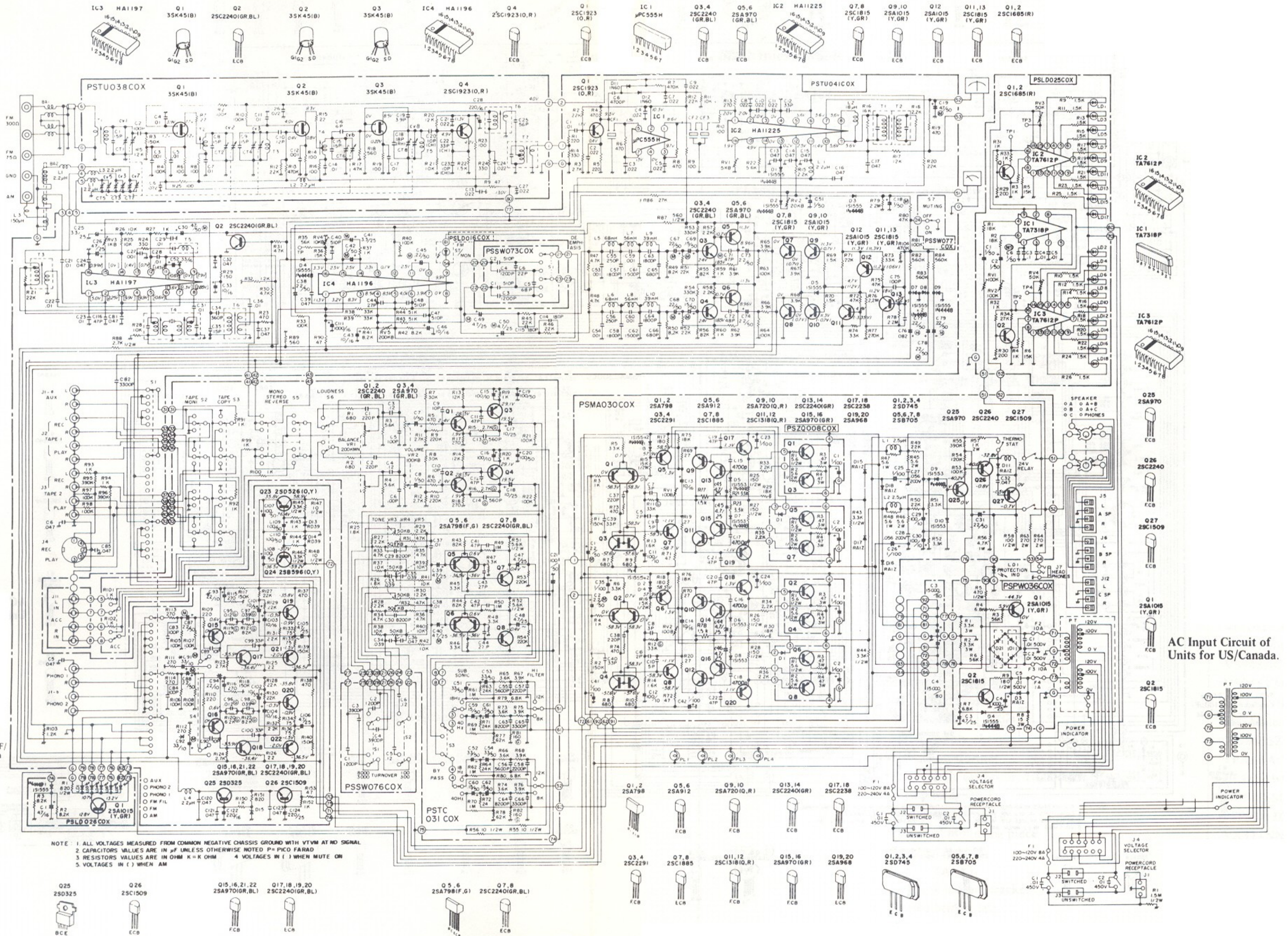

NOTE: 1. ALL VOLTAGES MEASURED FROM COMMON NEGATIVE CHASSIS GROUND WITH VTVM AT NO SIGNAL
 2. CAPACITORS VALUES ARE IN μ F UNLESS OTHERWISE NOTED P= PICO FARAD
 3. RESISTOR VALUES ARE IN OHM K=K OHM 4. VOLTAGES IN () WHEN MUTE OR
 5. VOLTAGES IN () WHEN AM

*C91, 92, 93, 94 are replaced with 100 μ F/6.3V for US/Canada version units.

AC Input Circuit of Units for US/Canada.

Scott 380R, 390R

Exploded View No.	Description	Part Code
(Q21, 22)	Transistor, 2SD745	QTD0745XAA
(Q23, 24)	" 2SB705	QTB0705XAA
	Chassis bridge, left	MU852SZ005
	Front end board	PSTU031COX
	#48 board mounting bracket	ML721SZ010
	"	ML721SZ011
	VC bracket	ML662SZ003
	Tuner board	PSTU032COX
	VC pulley	VM297SB003
	Coil spring	MW362LY004
	Remote shaft	MT865AD016
	Shaft coupling	VM460DN001
	Clamp	MX315SZ001
	Stringing bracket	ML554SZ001
	Rear panel	MB972SM017
(BA2)	Ferrite antenna	TEAR155E01
	Rubber sponge	VM230MB001
(J8)	Antenna terminal	YTD05D001U
(J11)	Accessory in/out RCA jacks	YJP04S011U
	Shorting bar	MU132BN001
(J9)	Ground thumb screw	YTD01S001U
	De-emphasis board	PSSW073COX
	#66 mounting bracket	ML322SZ006
(J5, 6)	Speaker output terminal	YTS04U007U
(J4)	Voltage selector receptacle	YJZ10S001U
(P1)	" plug	YPZ06S004U
	Voltage identification, Europe:	MS636SE001
	US/Canada:	MS766SE001
(J2, 3)	AC accessory outlet	YJA020005U
(J10)	Fuse holder	YHF1S3001U
(F1)	Fuse, US/Canada: 6A	ZFBQ60202U
	Europe: 3A	ZFBQ30202Z
(J1)	AC power receptacle	YJA03S002U
	Front escutcheon	AM380R**01
	Shade	MZ191SM001
	Knob, Tuning	MN386AA026
	" Power/Speaker	MN376AA019
	" levers	VN360SX001
	" Volume	MN296XA003
	" Balance	MN296XA002
	" Tone	MN276XA020
	" Turn-over	VN265SP004
	Bottom plate	MS986SZ016
	Foot	VM280EB001
	Cabinet cover top	MB983SX002

Exploded View No.	Description	Part Code
	Cabinet board side, right	VS879WT003
	" left	VS879WT004
	Cabinet grounding piece	MS723SS002
	Washer	MS707SB001

Electrical Parts on Main Chassis: 380R

Symbol No.	Description	Part Code
BA1	300 ohm balance coil	TV750301A2
C1, 2	US/Canada: Ceramic capacitor, 4,700p*, 125V AC Europe: Oil-paper capacitor, 0.01*, 450V AC	CKDX472PMM CNST103MAN
C5	Ceramic capacitor, 0.047	CKDB473ZFM
L1, 2	RFC, 2.2 μ H	LCADA3038A
L3	" 150 μ H	LF151KA01T
D13, 14	Quadruple diode block, STV-4H	QVFSTV4HXD

Miscellaneous: 380R

Description	Part Code
Operation manual, US/Canada:	KT380R**AX
Europe:	KT380R**AE
Carton	KP380R**01
Cushoning	KN380R**01
Accessory dipole	ZAT0015002

PSTU041COX [Tuner Front-End] : 380R/390R

Symbol No.	Description	Part Code
L2-4	RFC, 2.2 μ H	LCADA3038A
CV1-8	VC, 5-gang/3-gang	CVA3533G01
T1	RFT, RF input	TRA7JZ010S
T2, 3	" 2nd RF input	TR10MQ003M
T4	" Mixer input	TR10MQ002M
T5	" FM local osc	TR10MQ005M
T6, 7	" 10.7 MHz	TR10MA013S
Q1-3	FET, 3SK45	QTL0045XAB
Q4	Transistor, 2SC1923	QTC1923XAT
C1, 8, 9	Ceramic capacitor, 15p	CCDB150KOM
C2	" 100p	CCDB101KOM
C3, 12	" 0.001	CKDB102KBM
C4, 5, 11, 17, 7	" 0.01	CKFB103ZFT

* Capacitors listed are in micro-farad with voltage handling capability of 50V, unless otherwise specified.

Scott 380R, 390R

Symbol No.	Description	Part Code
C6, 13, 21, 24, 26, 27	Ceramic capacitor, 0.022	CKFB223ZFT
C10	" 12p	CCDB120KOM
C15, 20, 23	" 10p	CCDB100DCM
C16	" 6p	CCDB060COM
C18	" 18p	CCDB180KPM
C19	Minic capacitor, 3.9p	CG2H3R9KNN
C22	Ceramic capacitor, 33p	CCDB330KCM
C25	" 56p	CCDB560KOM
C28	Electrolytic capacitor, 220/16	CEED221ALX

PSTU032COX [Tuner] : 380R

Symbol No.	Description	Part Code
J1	Phono 1/2, Aux input RCA jack, 6P	YJP06S007U
J2, 3	Tape 1/2 in/out RCA jack	YJP04S016U
J4	Tape in/out receptacle, DIN-standardized	YJD05S011Z
S1	Function rotary switch	SH060606ZA
S2, 3	Tape Mon/Copy lever switch	SL040304ZB
S4	Phono Sens switch	SS020233ZA
S5-7	St/Mono lever switch	SL020215ZB
RV1	Trimming VR, 10k (B)	RPGNB10301
RV2	" 20k (B)	RPGNB20301
RV3	" 1k (B)	RPGNB10201
RV4	" 10k (B), dust-proof	RPJNB10302
RV5	" 200k (B)	RPGNB20401
IC1	IC, mu-PC555H, IF amp	QQM00555BA
IC2	" HA11225, IF/Quadrature	QQM11225AB
IC3	" HA1197, mpx demodulator	QQMA1197AB
IC4	" HA1196, AM tuner	QQMA1196AB
Q1	Transistor, 2SC1923	QTC1923XAT
Q2-4, 17-20	" 2SC2240	QTC2240XAT
Q5, 6, 15, 16, 21, 22	" 2SA970	QTA0970XAT
Q7, 8, 11, 13	" 2SC1815	QTC1815XAT
Q9, 10, 12	" 2SA1015	QTA1015XAT
Q14, 23	" 2SD526	QTD0526XAT
Q24	" 2SB596	QTB0596XAT
D1-5, 7-10	Silicon diode, 1N4448	QDSN4448XZ
D11, 12	Germanium diode, 1N60	QDG1N60XXT
D13, 14	Zenner diode, RD39EB4	QDZRD39EDA
L1	RFC, 2.2 μ H	LCADA3038A
L2	" 18 μ H	LF180JC01K
L5, 6	" 68 mH	LF683JC01K
L7, 8	" 56 mH	LF563JC01K

Symbol No.	Description	Part Code
L9, 10	RFC, 39 mH	LF393JC01K
CF1	Ceramic filter, 2-element, 10.7 MHz	FB10R7F14M
CF2, 3	"	FB10R7F15M
T1	RFT, quadrature	TR10MM013M
T2	" "	TR10MM014M
T3	" AM tuner	TR10MN006M
T4	RFT+ filter, AM IF, 455 kHz	FBR455A18Q
T5	RFT	TR07BM001M
T6	" AM local osc	TR10MZ002M
R87	M-oxide film resistor, 560**, 1/2W	RGHANJ561N
R145, 146	" 2.7k, 1/2W	RGHANJ272N
R147, 148	" 10, 1/2W	RXHANJ100N
R151	Cement resistor, 270, 5W	RF05SK27KB
C1, 21-23, 31, 36	Ceramic capacitor, 0.01	CKFB103ZFT
C2-5, 7-11	" 0.022	CKFB223ZFT
C6	" 4,700p	CKGB472ZFT
C12, 99, 100	" 33p	CCGB330KOT
C13-17, 24, 32, 37, 39, 81, 85	" 0.047	CKFB473ZFT
C18	Electrolytic capacitor, 0.1	CEEGR10ZMN
C19, 30	" 0.47	CEEGR47ZMN
C20	Ceramic capacitor, 47p	CCDB470KOM
C25	Electrolytic capacitor, 3-3/25	CEVE3R3ALX
C26	" 4.7/25	CEVE4R7ALX
C27	Ceramic capacitor, 0.001	CKGB102KBT
C28, 29	Mylar capacitor, 0.01	CQMB103KEH
C33, 43, 46, 103, 104	Electrolytic capacitor, 10/16	CEVD100ALX
C34	Styroflex capacitor, 360p	CQSC361JCF
C35	Ceramic capacitor, 8p	CCGB080DOT
C38	Electrolytic capacitor, 2.2 (non-pol.)	CEEG2R2NLX
C40, 47, 48	Styroflex capacitor, 510p	CQSC511JCF
C41	Electrolytic capacitor, 3.3/25	CEEE3R3ZMN
C42	" 1	CEEG010ZMN
C44	Ceramic capacitor, 27p	CCGB270KOT
C45, 73, 74	Electrolytic capacitor, 2.2	CEEGR22ZMN
C49, 50	" 4.7/25	CEEE4R7ZMN
C51, 113	" 1	CEAG010ALX
C52	" 3.3/16	CEAD330ALX
C53, 54	Ceramic capacitor, 1,000p	CKGB102KBT
C55, 56	Styroflex capacitor, 250p	CQSC251JCF
C57, 58	Mylar capacitor, 0.0018	CQMB182KEH
C59, 60	Styroflex capacitor, 1,000p	CQSC102JCF
C61, 62	Mylar capacitor, 1,500p	CQMB152KEH
C63, 64	Styroflex capacitor, 1,800p	CQSC182JCF

Scott 380R,390R

Symbol No.	Description	Part Code
C65, 66	Styroflex capacitor, 680p	CQSC681JCF
C67, 68, 77-80	Electrolytic capacitor, 0.22	CEEGR22ZMN
C69, 70	" 0.15	CEEGR15ZMN
C71, 72, 116	Ceramic capacitor, 47p	CCGB470KOT
C75	" 100p	CCGB101KOT
C76	Mylar capacitor, 0.082	CQMB823KEH
C82	" 3,300p	CQMB332KEH
C83, 84	Ceramic capacitor, 100p	CCGB101KOT
C87, 88	Electrolytic capacitor, 2.2	CEEG2R2ZMN
C89, 90	Ceramic capacitor, 10p	CCGB100DOT
C92, 92	Electrolytic capacitor, 33/10	CEEC330ZMN
C93, 94	" 22/10	CEEC220ZMN
C95, 96	Mylar capacitor, 0.012	CQMB123GEH
C97, 98	" 0.039	CQMB393GEH
C101, 102	Electrolytic capacitor, 10/35	CEVF100ALX
C105, 106	" 4.7/16	CEAD4R7NLC
C107-110	" 100	CEEG101ALX
C111	" 1,000/16	CEED102ALX
C112	" 220/16	CEED221ALX
C115	Ceramic capacitor, 150p	CCDB151KOM
C117	Mylar capacitor, 0.12	CQMB124KEH

PSSW073COX [De-emphasiss] : 380R/390R

Symbol No.	Description	Part Code
S1	Slide switch	SS040305ZL
C1, 2	Styroflex capacitor, 510p ±5%	CQSC511JCF
C3, 4	Mylar capacitor, 1,200p ±5%	CQMB122JEH
C5	Ceramic capacitor, 68p	CCGB680KOT
C6	" 22p	CCGB220KOT

PSTC029COX [Control Amplifier] : 380R

Symbol No.	Description	Part Code
VR1, 2	VR, 200k (MN) + 100k (B), Volume/Balance	RVGA204X07
VR3-5	" 50k (B), Tone	RVQA503B05
S1	Slide switch, Sub-sonic	SL020215ZB
S2	" Hi-Filter	SL020218ZB
Q1, 2, 8	Transistor, 2SC2240	QTC2240XAT
Q3, 4	" 2SA970	QTA0970XAT
Q5, 6	" 2SA798	QTA0798XEE
R55	M-oxide film resistor, 10**, 1/2W	RXHANJ100N

** Resistors listed are in Ohm.

Symbol No.	Description	Part Code
C1, 2	Ceramic capacitor, 220p	CCFB221KOT
C4	Mylar capacitor, 0.12	CQMB124KEH
C5, 6	Ceramic capacitor, 100p	CCGB101KOT
C7, 8	Electrolytic capacitor, 1	CEEG010ZMN
C9, 10	Ceramic capacitor, 10p	CCGB100DOT
C11, 12, 41, 42	" 47p	CCGB470KOT
C13, 14	" 560p	CCFB561KOT
C15, 16	Electrolytic capacitor, 100/10	CEVC101ALX
C17, 18	" 10/25	CEVE100ALX
C19, 20	" 100	CEEG101ALX
C29, 30	Mylar capacitor, 0.0082	CQMB822KEH
C33-36	" 0.039	CQMB393KEH
C37, 38	" 0.01	CQMB103KEH
C39, 40, 47, 48	Electrolytic capacitor, 4.7/25	CEEE4R7ZMN
C43, 44	Ceramic capacitor, 27p	CCGB270KOT
C61, 62	Electrolytic capacitor, 0.68	CEEGR68ZMN
C63, 64	Mylar capacitor, 0.27	CQMB274KEH
C65, 66	" 0.012	CQMB123KEH
C67, 68	" 0.0039	CQMB392KEH
C70	Ceramic capacitor, 390p	CCDB391KOM

PSLD19COX [LED Indicator] ; 380R

Symbol No.	Description	Part Code
Q1	Transistor, 2SA1015	QTA1015XAT
D1	Silicon diode, 1N4448	QDSN4448XZ
LD1-6	LED, Aux	QLAR5531KR
R1	M-Oxide film resistor, 820, 1/2W	RGHANJ821N
C1	Electrolytic capacitor, 4.7/16	CEEE4R7ALX

PSSW074COX [Turn-over Control] : 380R

Symbol No.	Description	Part Code
C1, 2	Push switch, 3-gang	SP03DAX10A
C3, 4	Mylar capacitor, 1,200p	CQMB122KEH
C5, 6	" 3,900p	CQMB392KEH
	" 0.12	CQMB124KEH

PSMA030COX [Power Amplifier] : 380R

Symbol No.	Description	Part Code
IC1	IC, TA7318P-2	QQM07318AT
Q1, 2	Transistor, 2SA798	QTA0798XEE
Q3, 4	" 2SC2291	QTC2291XAE
Q5, 6	" 2SA912	QTA0912XAN
Q7, 8	" 2SC1885	QTC1885XAN
Q9, 10	" 2SA720	QTA0720XBN
Q11, 12	" 2SC1318	QTC1318XDN
Q13, 14, 26, 27	" 2SC1815	QTC1815XAT
Q15, 16	" 2SA1015	QTA1015XAT
Q17, 18	" 2SC2238	QTC2238XBT
Q19, 20	" 2SA968	QTA0968XBT
Q25	" 2SA970	QTA0970XBT
D1-10	Silicon diode, 1N4448	QDSN4448XZ
D11, 15-18	" RA-1Z	QDSRA1ZXXD
L1, 2	RFC, 2.5 μ H	LA3QH1323B
RY1	Relay, speaker protection	ZRA444103U
RV-1, 2	Trimming resistor, 100 (B)	RPJNB10103
RV-3, 4	" 220 (B)	RPJNB22101
R37-40	Cement resistor, 0.47, 5W	RF05SKR47B
R48	M-oxide film resistor, 5.6, 1W	RX1ANJ5R6N
R56	" 3.9k, 1W	RG1ANJ392N
R57	" 680, 2W	RG2ANJ681N
R58	" 100, 1/2W	RGHANJ101N
R59, 60	" 2.4k, 2W	RG2ANJ242N
R63	" 270, 2W	RG2ANJ271N
C1, 2	Electrolytic capacitor, 2.2	CEAG2R2ZMN
C3, 4	Ceramic capacitor, 330p	CCFB331KOT
C5, 6	" 2p	CCGB020COT
C7, 8	" 3p	CCGB030DOT
C9, 10	Ceramic capacitor, 5p	CCGB050COT
C11, 12	Electrolytic capacitor, 100/10	CEWC101ALX
C13, 14	" 10/16	CEWD100ALX
C15-18	Ceramic capacitor, 4,700p	CKGB472ZFT
C19-22	" 47p	CCGB470KOT
C23-26, 35, 41, 42	Electrolytic capacitor, 1/100	CEWK010ALX
C27, 28	Mylar capacitor, 0.056/100	CQMC563KEH
C29, 30	Electrolytic capacitor, 100/10	CEWC101ALX
C31	" 22	CEAG220AMN
C32	Mylar capacitor, 0.047	CQMB473KTH
C33, 34	" 0.022	CQMB223KTH
C37, 38	Ceramic capacitor, 220p	CCFB221KOT
C39, 40	" 100p	CCGB101KOT
C43-46	Electrolytic capacitor, 4.7/25	CEAE4R7ALX

PSPW033COX [Power Supply] : 380R

Symbol No.	Description	Part Code
R1, 2	M-oxide film resistor, 2.2k, 3W	RG3ANJ222N
R6	" 390, 1/2W	RGHANJ391N
C1	Ceramic capacitor, 0.01, 500V	CKDE103PEM
C2	Electrolytic capacitor, 47/16	CEED470ALX
C3	Ceramic capacitor, 0.01, 500V	CKDE103PEM
Q1	Transistor, 2SA1015	QTA1015XAT
D1-4	Silicon diode, SR3AM-8A	QDSR3AM8AE
D5	" RA-1Z	QDSRA1ZXXD
	Fuse housing	YHF0P0003Z

390R Mechanical

Exploded View No.	Description	Part Code
	Escutcheon	AM390R**01
	Knob, Power/Speaker Mode	MN376AA019
	" Turn-over	VN265SP004
	" Volume	MN276XA020
	" Balance	MN296XA003
	" "	MN296XA002
	" lever switches	VN360SX001
	" Tuning	MN386AA026
	Shade	MZ191SM002
	Dial pointer	MJ311BC002
	Pointer bracket	VK131NB001
	Shade	VK261SB002
	Pointer rail	MS926SZ002
	Dial scale	VS948AC001
	Plate at dial back	VS945VM002
	LED bezel	MT165BC001
	LED holder	VK226SB001

Scott 380R,390R

Exploded View No.	Description	Part Code
	Stereo indicator board	PSLD026COX
	L-bracket	ML721SZ014
	Protection LED (LD1)	QLAGD4505R
	LED relief	VM162RX001
	Front panel	MB974SZ006
	Stringing pulley	ML241SZ003
	"	VM173DN001
	Pulley shaft	MT142SN001
	Bulbe relief	VM165RX001
	Bulbe, 14V/80 mA (PL1-4)	ZPA148103U
	Signal meter (M1), 500 μ A	ZMG2052N02
	Center-tune meter (M2), $\pm 250 \mu$ A	ZMF4052K02
	Meter bracket	ML742SZ011
	Meter housing	VB632SW001
	AC Power switch (S1)	SU027201AB
	Headphone jack (J7)	YJS03S016Z
	PC board bracket	ML331SZ005
	Power level LED board	PSLD025COX
	Program LED board	PSLD026COX
	Stringing pulley	ML154SZ001
	Tuning flywheel	AVFLYWL009
	Control amplifier board	PSTC031COX
	Spacer	MT163BD012
	Push switch (S2), Power LED	SP01AAX26A
	Turn-over board	PSSW076COX
	Coil spring	MW141LY002
	Shaft relief	VF221DN001
	Remote shaft	MT865AD017
	Coupler	VM460DN001
	Clamp	MX315SZ001
	Input terminal board	PSSW077COX
	Chassis bridge	MU863SZ003
	Stringing pulley	ML554SZ001
	VC board bracket	ML821SZ005
	Bracket	ML662SZ003
	Dial drum	VM297SB004
	Coil spring	MW362LY005
	VC board bracket	ML821SZ006
	Tuner board	PSTU031COX
	Chassis bridge	MU863SZ002
	Bracket	ML261SZ002
	Strain relief	VF177EB001
	Power amplifier board	PSMA030COX
	Heatsink bracket	MS867SZ003

Exploded View No.	Description	Part Code
	Heatsink	MH776AA007
	Transistor (Q5-8), 2SB705	QTB0705XAA
	" (Q1-4), 2SD745	QTD0745XAA
	Power transistor board	PSZD008COX
	"	PSZD008COX
	Power supply chassis	MU876SZ001
	Grounding block	ML642BD001
	PC board spacer	VX311NN001
	Power supply board	PSPW036COX
	Fuse (F4), 1A	ZFBQ10202U
	" (F2, 3), 10A	ZFBQ10303U
	Electrolytic capacitor (C3, 4) 15,000/80	CEJ1J15301
	Power transformer (PT)	TPAB1A001Y
	PT bracket	MB774SZ005
	Rear panel	MB974SE001
	Speaker output terminal (J5, 6, 12)	YTS04S007U
	Switch bracket	ML322SZ006
	De-emphasis board	PSSW073COX
	Accessory in/out RCA jack (J11)	YJP04S007U
	Antenna terminal (J8)	YTD05D001U
	Ground terminal (J9)	YTD01S002U
	Loopstick antenna (BA2)	TEAR155E01
	Rubber sponge	VM230MB001
	Fuse holder (J10)	YHF1S3001U
	Fuse (F1), 100-120V: 8A	ZFBQ80202U
	220-240V: 4A	ZFBQ40205V
	AC power receptacle (J1)	YJA03S002U
	Accessory AC outlet	YJA020005U
	Main selector jack (J4)	YJZ10S001U
	" plug (P1)	YPZ06S004U
	AC main identification plate (Europe)	MS636SE001
	Bottom plate	MS986SZ018
	Rubber leg	VM283NB001
	Cabinet top	MB983SX005
	Cabinet grounding bracket	MS723SS003
	Washer	MS707SB001
	Spacer	MT164SZ005
	Dial escutcheon	ME96EAA009
	Rubber sponge	VQ211MB001
	Cabinet side, right	VS879WT007
	" left	VS879WT008
	Thermostat (Europe only)	ZFFP15301A
	LED socket (LD1)	YSZ020002U
	AC main identification plate (US/Canada)	MS766SE017

Electrical Parts on Main Chassis: 390R

Symbol No.	Description	Part Code
Q1-4	Transistor, 2SD745	QTD0745XAA
Q5-8	" 2SB705	QTB0705XAA
BA1	300 Ohm balance coil	TV750301A2
C1, 2	US/Canada: Ceramic capacitor, 0.047, 125VAC	CKDX472PMM
	Europe: Oil-paper capacitor, 0.01, 450VAC	CKDB473ZFM
C5, 6	Ceramic capacitor, 0.047	CKDB473ZFM
C7	Electrolytic capacitor, 47/16	CEAD470ALX
L1, 2	RFC, 2.2 μ H	LCADA3038A
L3	" 150 μ H	LF151KA01T

Miscellaneous Parts: 390R

Description	Part Code
Operation manual, US/Canada:	KT390R**XX
Europe:	KT390R**XE
Carton	KP390R**01
Cushoning	KN390R**02
Accessory dipole	ZAT0015002
AC cord set	ACAC034ULA

PSMA030COX [Power Amplifier] : 390R

Symbol No.	Description	Part Code
Q1, 2	Transistor, 2SA798	QTA0798XEE
Q3, 4	" 2SC2291	QTC2291XAE
Q5, 6	" 2SA912	QTA0912XAN
Q7, 8	" 2SC1885	QTC1885XAN
Q9, 10	" 2SA720	QTA0720XBN
Q11, 12	" 2SC1318	QTC1318XDN
Q13, 14, 26	" 2SC2240	QTC2240XCT
Q15, 16, 25	" 2SA970	QTA0970XBT
Q17, 18	" 2SC2238	QTC2238XBT
Q19, 20	" 2SA968	QTA0968XBT
Q27	" 2SC1509	QTC1509XBN
D1-10	Silicon diode, 1N4448	QDSN4448XZ
D11, 15-18	RA-1Z	QDSRA1ZXXD
L1, 2	RFC, 2.5 μ H	LA3QH1323B
RY1	Relay, speaker protection	ZRA444103U
RV1, 2	Trimming resistor, 100 (B)	RPJNB10103
R15, 16	M-oxide film resistor, 15k, 1/2W	RGHANJ153N
R25-28	" 150, 1/2W	RGHANJ151N
R43, 44	" 3.3k, 1/2W	RXHANJ332N

Symbol No.	Description	Part Code
R45, 46	M-oxide film resistor, 5.6, 2W	RX2ANJ5R6N
R47, 48	" 5.6, 1W	RX1ANJ5R6N
R63, 64	" 270, 2W	RG2ANJ271N
R57	" 1k, 2W	RG2ANJ102N
R56	" 4.7k, 1W	RG1ANJ472N
C1, 2	Electrolytic capacitor, 2.2	CEAG2R2ZMN
C5, 6	Ceramic capacitor, 2p	CCGB020COT
C7, 8	" 3p	CCGB030DOT
C9, 10	" 5p	CCGB050COT
C11, 12	Electrolytic capacitor, 100/10	CEWC101ALX
C13, 14	" 10/16	CEWD100ALX
C15-18	Ceramic capacitor, 4,700p	CKGB472ZFT
C22	" 47p	CCGB470KOT
C23-26, 35, 41, 42	Electrolytic capacitor, 1/100	CEWK010ALX
C29, 30	" 100/10	CEWC101ALX
C31	" 22	CEAG220AMN
C32	Mylar capacitor, 0.047	CQMB473KTH
C27, 28	" 0.056	CQMD563KEH
C3, 4, 39, 40	Ceramic capacitor, 33p	CCGB330KOT
C37, 38	" 220p	CCFB221KOT
C43-46	Electrolytic capacitor, 4.7/25	CEAE4R7ALX

PSTU038COX [Control Amplifier] : 390R

Symbol No.	Description	Part Code
J1	Phono 1/2, Aux input RCA jack	YJP06S007U
J2, 3	Tape 1/2 RCA jack	YJP04S016U
J4	Tape in/out receptacle, DIN-standardized	YJD05S011Z
S-1	Function select, rotary switch	SH060606ZA
S-2	Phono Sens switch	SS020233ZA
RV-1	Trimming resistor, 5k (B)	RPGNB50201
RV-2	" 20k (B)	RPGNB20301
RV-3	" 1k (B)	RPGNB10201
RV-4	" 10k (B), dust-proof	RPJNB10302
RV-5	" 200k (B)	RPGNB20401
IC-1	IC, mu-PC555H, IF amp	QQM00555BA
IC-2	" HA11225, FM IF, quadrature	QQM11225AB
IC-3	" HA1197, mpx demodulate	QQMA1197AB
IC-4	" HA1196, AM tuner	QQMA1196AB
Q-1	Transistor, 2SC1923	QTC1923XAT
Q-2-4, 17-20	" 2SC2240	QTC2240XAT
Q5, 6, 15, 16	" 2SA970	QTA0970XAT
Q7, 8, 11, 13	" 2SC1815	QTC1815XAT

Scott 380R,390R

Symbol No.	Description	Part Code
Q9, 10, 12	Transistor, 2SC1015	QTC1015XAT
Q23	" 2SD526	QTD0526XAT
Q24	" 2SB596	QTB0596XAT
Q25	" 2SD325	QTD0325XAC
D-1-9	Silicon diode, 1N4448	QDSN4448XZ
D-10, 12	Germanium diode, 1N60	QDG1N60XXT
D-13, 14	Zenner diode, RD39EB4	QDZRD39EDA
D-15	" RD-13E	QDZRD13EXA
L-1, 4	RFC, 2.2 μ H	LCADA3038A
L-2	" 18 μ H	LF180JC01K
L-5, 6	" 68 mH	LF683JC01K
L-7, 8	" 56 mH	LF563JC01K
L-9, 10	" 39 mH	LF393JC01K
CF-1	Ceramic filter, SFE10.7MA, 10.7 MHz	FB10R7F14M
CF-2, 3	" SFE10.7MU, "	FB10R7F15M
T-1	RFT, FM detect	TR10MM013M
T-2	" "	TR10MM014M
T-3	" AM RF	TR10MN006M
T-4	RFT + filter, AM IF, 455 kHz	FBR455A18Q
T-5	RFT, AM IF, 455 kHz	TR07BM001M
T-6	" AM local osc	TR10MZ002M
R87	M-oxide film resistor, 560, 1/2W	RGHANJ561N
R88	" 2.7k, 1/2W	RGHANJ272N
R145, 146	" 3.3k, 1/2W	RGHANJ332N
R147, 148	" 10, 1/2W	RGHANJ100N
C1, 21-23, 28, 29, 31, 36	Ceramic capacitor, 0.01	CKFB103ZFT
C2-5, 7-11	" 0.022	CKFB223ZFT
C6	" 4,700p	CKGB4727FT
C12, 20, 99, 100	" 33p	CCGB330KOT
C13-17, 24, 32, 37, 39, 81, 85, 120, 121, 123	" 0.047	CKFB473ZFT
C18	Electrolytic capacitor, 0.1	CEEGR10ZMN
C25, 41	" 3.3/25	CEVE3R3ALX
C26, 49, 50,	" 4.7/25	CEVE4R7ALX
C27	Ceramic capacitor, 0.001	CKGB102KBT
C28	Mylar capacitor, 0.01	CQMB103KEH
C30	Electrolytic capacitor, 4.7	CEEGR47ZMN
C33, 43, 46, 103, 104	" 10/16	CEVD100ALX
C34	Styroflex capacitor, 360p	CQSC361JCF
C35	Ceramic capacitor, 5p	CCGB050DOT
C38	Electrolytic capacitor, 2.2 (non-pol.)	CEEG2R2NLX
C40, 47, 48	Styroflex capacitor, 510p	CQSC511JCF
C42	Electrolytic capacitor, 1	CEEG010ZMN
C44	Ceramic capacitor, 47p	CCGB270KOT

Symbol No.	Description	Part Code
C45	Electrolytic capacitor, 0.22	CEEGR22ZMN
C51	" 1	CEAG010ALX
C52	" 33/16	CEED330ALX
C53, 54	Ceramic capacitor, 1,000p	CKGB102KBT
C55, 56	Styroflex capacitor, 250p	CQSC251JCF
C57, 58	Mylar capacitor, 0.0018	CQMB182KEH
C59, 60	Styroflex capacitor, 1,000p	CQSC102JCF
C61, 62	Mylar capacitor, 1,500p	CQMB152KEH
C63, 64	Styroflex capacitor, 1,800p	CQSC182JCF
C65, 66	" 680p	CQSC681JCF
C67, 68, 77-79	Electrolytic capacitor, 0.22	CEEGR22ZMN
C69, 70	" 0.15	CEEGR15ZMN
C71, 72	Ceramic capacitor, 47p	CCGB470KOT
C73, 74	Electrolytic capacitor, 2.2	CEEGR22ZMN
C75	Ceramic capacitor, 100p	CCGB101KOT
C76	Mylar capacitor, 0.082	CQMB823KEH
C82	Mylar capacitor, 3,300p	CQMB332KEH
C83, 84	Ceramic capacitor, 100p	CCGB101KOT
C87, 88	Electrolytic capacitor, 2.2	CEEGR22ZMN
C89, 90	Ceramic capacitor, 10p	CCGB100DOT
C91, 92	Electrolytic capacitor, 33/10	CEEC330ZMN
C93, 94	" 22/10	CEEC220ZMN
C95, 96	Mylar capacitor, 0.012	CQMB123GEH
C97, 98	" 0.039	CQMB393CEH
C101, 102	Electrolytic capacitor, 10/35	CEVF100ALX
C105, 106	" 4.7/25 (non-pol.)	CEAE4R7NLX
C107-110	" 100	CEAG101ALX
C114, 115	Ceramic capacitor, 180p	CCDB181KOM
C116	" 47p	CCGB470KOT
C121	Electrolytic capacitor, 220/16	CEED221ALX
C124	" 220/25	CEEE221ALX
C127, 128	Mylar capacitor, 0.01	CQMB103KEH

PSLD026COX [Program LED] : 390R

Symbol No.	Description	Part Code
Q1	Transistor, 2SA1015	QTA1015XAT
D1	Silicon diode, 1N4448	QDSN4448XZ
LD1-5	LED, Aux/Phono-1, 2, etc.	QLALP137BC
R1	M-oxide film resistor, 820, 1/2W	RGHANJ821N
C1	Electrolytic capacitor, 4.7/25	CEVE4R7ALX

PSSW076COX [Turn-Over] : 390R

Symbol No.	Description	Part Code
	Pushing switch	SP02YAX10A
C1, 2	Mylar capacitor, 0.0039	CQMB392KEH
C3, 4	Mylar capacitor, 0.0012	CQMB122KEH
C5, 6	" 0.012	CQMB124KEH

PSSW077COX [Mute] : 390R

Symbol No.	Description	Part Code
S1	Lever switch, 2-p/2-t	SL020215ZB

PSTC031COX [Tuner] : 390R

Symbol No.	Description	Part Code
VR1, 2	VR, 100k x 4, Volume/Balance	RVZA104X01
VR3-5	" 50k (B), Tone	RVQA503B05
S1-3	Slide switch, 4p-3t, Tape Mon, etc.	SL040304ZB
S4-6	" 2p-3t, Loudness, etc.	SL020215ZB
S7, 8	" 2p-3t, Sub-Sonic, etc.	SL020306ZB
Q1, 2, 7, 8	Transistor, 2SC2240	QTC2240XAT
Q3, 4	" 2SA970	QTA0970XAT
Q5, 6	" 2SA798	QTA0798XEE
R51, 52	M-oxide film resistor, 5.6k, 1/2W	RGHANJ562N
R55, 56	" 10, 1/2W	RXHANJ100N
C1, 2	Ceramic capacitor, 220p	CCFB221KOT
C3, 4	Mylar capacitor, 0.12	CQMB124KEH
C5, 6	Ceramic capacitor, 100p	CCGB101KOT
C7, 8	Electrolytic capacitor, 1	CEEG010ZMN
C9, 10	Ceramic capacitor, 10p	CCGB100DOT
C11, 12, 41, 45	" 47p	CCGB470KOT
C13, 14	" 560p	CCFB561KOT
C15, 16	Electrolytic capacitor, 100/10	CEVC101ALX
C17, 18	" 10/25	CEVE100ALX
C19, 20, 81	" 100	CEEG101ALX
C29, 30, 63, 64	Mylar capacitor, 0.0082	CQMB822KEH
C33, 36	" 0.039	CQMB393KEH
C37, 38	" 0.01	CQMB103KEH
C39, 40	Electrolytic capacitor, 4.7/25	CEEE4R7ZMN
C43, 44	Ceramic capacitor, 27p	CCGB270KOT
C47, 48	Electrolytic capacitor, 4.7/25 (non-pol.)	CEAE4R7NLX
C51-54	" 0.33	CEEGR33ZMN
C55, 56	Mylar capacitor, 0.0056	CQMB562KEH
C57, 58	" 0.0022	CQMB222KEH

Symbol No.	Description	Part Code
C59-62	Electrolytic capacitor, 0.15	CEEGR15ZMN
C65, 66	Mylar capacitor, 0.0033	CQMB332KEH

PSLD025COX [Power Level LED] : 390R

Symbol No.	Description	Part Code
IC1	IC, TA7318P-2	QQM07318AT
IC2, 3	" TA7612P	QQM07612AT
RV1, 2	Trimming resistor, 100	RPGNB10402
LD1-18	LED, SLP137B	QLALP137BC
Q1, 2	Transistor, 2SC1685	QTC1685XAN
RV3, 4	Trimming resistor, 50k	RPGNB50302
C1, 2	Electrolytic capacitor, 1	CEEC010ALX
C3	Mylar capacitor, 0.1	CQMB104KEH
C4, 5	" 0.01	CQMB103KEH
C6	Electrolytic capacitor, 1	CEEG010ALX

PSPW036COX [Power Supply] : 390R

Symbol No.	Description	Part Code
Q1	Transistor, 2SA1015	QTA1015XAT
Q2	" 2SC1815	QTC1815XAT
D1	Silicon diode, SS-7	QDSSS7XXXD
D2	" SS-7R	QDSSS7RXXD
D3	" RA-1Z	QDSRA1ZXXD
D4	" 1N4448	QDSN4448XZ
R1, 2	M-oxide film resistor, 3.3k, 3W	RG3ANJ332N
R5	" 470, 1/2W	RGHANJ471N
R8	" 15, 3W	RX3ANJ150N
R9	" 180, 1/2W	RGHANJ181N
C1, 2	Ceramic capacitor, 0.01, 500V	CKDE103PEM
C3	Electrolytic capacitor, 4.7/25	CEEE4R7ALX
C4	" 1,000/25	CEAE102ALX
C5	Fuse housing	YHF0P0003Z

PSLD016COX [FM Stereo LED] : 390R

Symbol No.	Description	Part Code
LD1	LED, SLP137B	QLALP137BC

PSZQ008COX [Final Power TR] : 390R

Symbol No.	Description	Part Code
R1, 2	M-oxide film resistor, 5.6, 1/2W	RXHANJ5R6N
R3, 4	Cement resistor, 0.47, 3W	RF03SKR478
C1, 2	Electrolytic capacitor, 1/100	CEAK010ALX
D1	Quadruple diode array, STV-4H	QVFSTV4HXD