

TANDY

ELECTRONICS CATALOGUE 1974/75

QUICK INDEX

First page only is given —
complete index Page 49.

Aerials	50	Radio	88
Auto Stereo	31	Stereo/HiFi	4
Batteries	78	Tapes	43
Electronic parts	55	Tape Recorders	93
Intercoms	41	Test Equipment	76
Kits	81	Tools	36
Microphones	24	Valves	80



MC 500

LAB-12B

Realistic Super Hi-Fi System

A great stereo system offered at this Realistic price by REALISTIC! Fantastic STA-18B AM/FM Stereo Receiver which gives great reproduction from radio, tapes or records. Two MC-500 speakers, in oiled walnut cabinets, with bass response down to 40 Hz and treble up to 20,000 Hz. And to complement them, our LAB-12B automatic/manual changer with magnetic cartridge and dust cover. Top quality — at a price you can afford!

Sold separately
costs: £154.90

As a complete
system:

£139



STA-18B

TUNE IN THE WORLD!

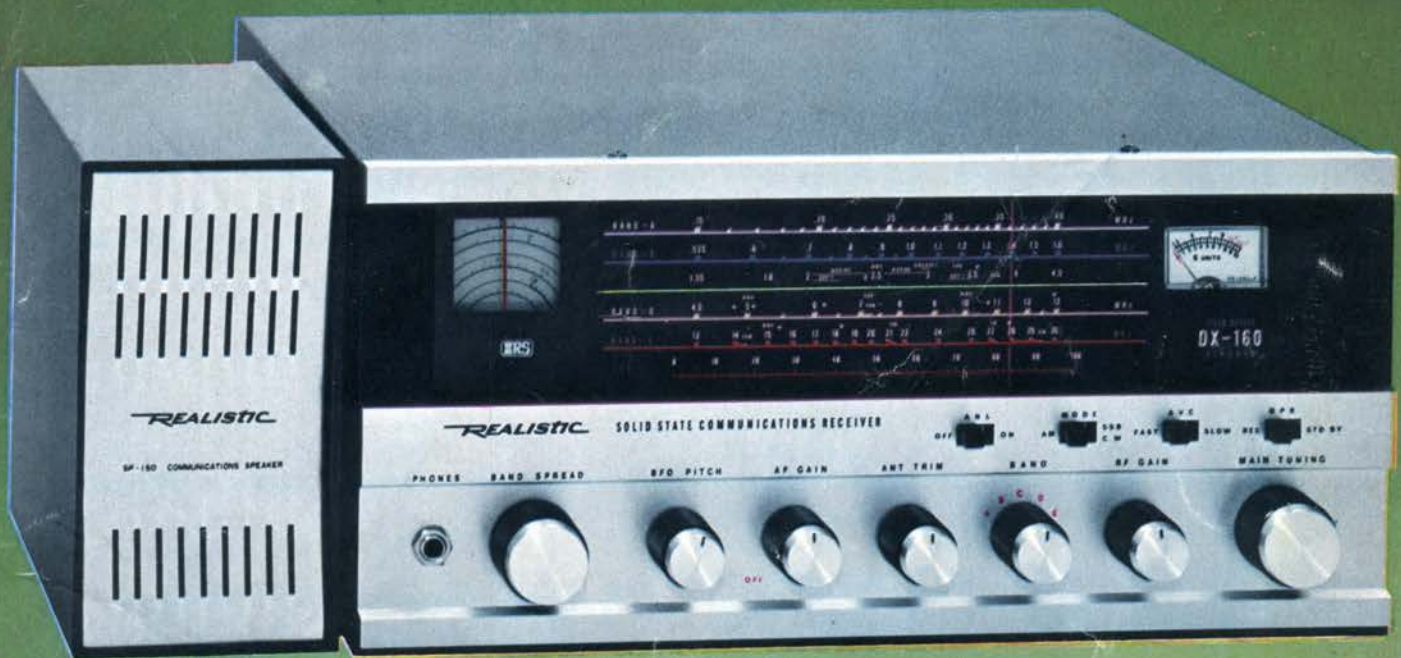

£ 89.95

All Solid State 5-band Communications Receiver. Acclaimed in America by radio and electronics magazines as a „top receiver buy“. Perfect for Hams and Short-wave listeners.

- 5 FET's for outstanding performance!
- Mechanical filter for high selectivity!
- Product detector and variable BFO for great SSB and CW reception!

- 11 front controls; battery/AC power!
- Voice-selective outboard speaker!
- Lighted dial, S-meter & bandsread!

Realistic DX-160 Receiver for HAM/SWL/SSB/CW

Big - exciting - professional... a really fantastic receiver with top-quality, no-nonsense circuitry. Features electrical bandsread for 160-10 meters (Ham and CB) and controls for ANL, fast/slow AVC, receive/standby, AF & RF gain, antenna

trim, main and bandsread tuning. The DX-160 has 5 Bands: 150-400 kHz longwave; 535-1605 kHz standard AM; 1.5-4.5 MHz, 4.5-13 MHz and 13-30 MHz shortwave. It also has OTL audio, cascade RF stage, zener stabilization to cut drift, headphone jack, logging scale, noise limiting in IF and audio stages. It operates on 8 „D“ batteries, 12V DC negative ground or 220/240V AC. The receiver measures 165x362x235 mm and the outboard speaker 178x83x130 mm.

20-152 £ 89.95

Useful accessories for beginners or experienced operators



- A. Code Oscillator Module. Fully wired. Connect to key, PM speaker. 1.5 V battery. With instructions.
20-1155 99 P
- B. High Frequency Code Practice Buzzer. Clear, steady signal. Use with beginner's key. Adjustable frequency.
20-1086 79 P
- C. Beginner's Hand Key. With adjustable contacts.
20-1085 99 P
- D. High Speed Hand Key. Adjustable spring tension, contacts, ball bearing pivots, circuit-closing switch.
20-1084 £ 2.49
- E. Code Practice Set. Perfect for Morse code. Buzzer, adjustable spring and contacts, jack for headphones.
20-1087 £ 2.49
23-466 1.5 V „D“ battery 9 P
- F. Code Practice Oscillator. Variable tone plus light signals and internal speaker. Complete with 2 batteries, earphone and manual.
20-007 £ 5.95
- G. Morse Code Record. Learn the Morse code to 15 words per minute. 10 easy lessons. 33 1/3 rpm 12" record. Includes manual.
20-025 £ 3.95
- H. Morse Code Cassette. Fits any cassette player. 12 lessons with manual. Up to 15 words per minute.
20-026 £ 4.95

SW Antenna Kits for long-distance listening

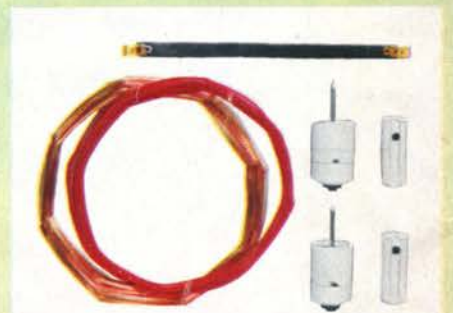

- Economy Model. 15 meters copper wire, 7.5 meters lead-in wire plus insulators and full instructions.
278-1373 £ 2.59
- Deluxe Model. 22.5 meters copper wire, 15 meters lead-in wire, insulators, instructions.
278-758 £ 4.19.



a completely new concept in electronics retailing

The appearance of the Tandy name in your local High Street heralds much more than the arrival of another radio store. It marks a completely new departure in the marketing of „consumer electronics“ and for a number of important reasons.

Tandy concentrates on electronics equipment, and all but a fraction of the products sold are exclusive Tandy brands.

They also come direct to you

without middlemen's profits, which means that you pay much less for them than you would for equipment of comparable quality and performance elsewhere.

Tandy is also international, with manufacturing plants across the world and retail outlets throughout America, Canada, Australia and the European Common Market. Indeed, in America, where the Tandy Corporation was founded some 50 years ago, their

Radio Shack store chain now totals over 2000 outlets, with a retail turnover in excess of £200 million and a regular clientele of over 9 million.

But the really unique feature of the Tandy marketing concept is that all the stores are available for franchise. This means any enterprising store manager, or anyone with a flair for store management, can have one or more Tandy stores.

Run a Tandy store of your own

If you've ever contemplated going into business on your own account, you'd do well to make a careful study of a Tandy franchise. Because it really does offer you the opportunity of a lifetime. The opportunity to secure a high and progressive income – with security.

For a start, you get the benefit of Tandy's 50 years' experience and full specialist support. Then you'll be selling Tandy's own exclusive brands. Brands that are not available across the street. Brands that compare more

than favourably with the competition. Brands that receive regular large-scale advertising support. Brands you'll be proud to recommend to your customers.

Previous radio trade experience is not essential. Everything, from the selection of a suitable store location through your grand opening, daily routines and procedures, is taken care of by our experts. It's a continuing service too – never any further away than your telephone. We call it total marketing.

Now, how much does all this cost?

The minimum initial investment is £14,500. This covers items such as stock, fixtures, fittings, rent, fees and so on.

Like to know more?

Simply write for our fully informative portfolio to:

Mr. R. J. O'Brien,
Tandy Corporation (Branch UK),
Bilston Road,
Wednesbury,
Staffordshire, WS10 7JN.

TRADE DESCRIPTION ACT 1968 Whereas every effort has been made to ensure accuracy in the preparation of this catalogue, the Company excludes liability for all errors insofar committed therein. We should appreciate our customers informing us directly of any inaccuracies they may find. Thank you. All prices in this catalogue are subject to change without notice.

Realistic AM/FM Stereo Receiver - Unbeatable value!



£ 89.95

Includes Walnut case worth £ 10

Realistic STA-18B. Equipped to be the „heart“ of any stereo system for years to come! All silicon transistors insure excellent performance. Sensitive FET-FM front end pulls in more stations more clearly – even in fringe areas! And the wideband AM circuit gets reception that can rival FM. Features include an illuminated centre-channel/signal-strength tuning meter; tape inputs/outputs with monitor; mag. phone input; A & B speaker switches that turn on main or remote speakers together or independently! Also included

are Flip-Lever stereo-mono & loudness switches, and built-in antennas. The 18B really excels in style too, with its elegant brushed aluminium panel and walnut wood case. 127×406×276 mm. **31-2049 £ 89.95**

Specifications: Power at 8 ohms: 20 watts IHF, 14 watts RMS. Response: 20-30,000 Hz ± 2 dB. Power Bandwidth: 30-20,000 Hz. Harmonic Distortion: Under 1%. Hum and Noise: -60 dB. Input Sensitivity: Phono, 2.5 mV. Output: 4-16 ohms. FM Sensitivity: 2.0 µV. Separation: 40 dB. Signal-to-Noise: 67 dB.



Full-Range Tone Controls!



Colour-Changing Dial Pointer!



Tape Monitor Switch!



Centre-Channel/Signal-Strength Tuning Meter!



Stereo Headphone Jack!



A & B Speaker Selector Switches!



Good

31-2049. STA-18B AM/FM Stereo Receiver
40-103. Two Solo-103 Acoustic Suspension Speaker Systems
42-2935. LAB-12B Automatic Turntable with Base and Stereo Magnetic Cartridge

Worth £ 138.80 Complete System **£ 124.95**

Save £ 13.85



Better

31-2049. STA-18B AM/FM Stereo Receiver
40-1980. Two MC-1000 Bookshelf Speaker Systems
42-2935. LAB-12B Automatic Turntable with Base and Stereo Magnetic Cartridge

Worth £ 182.90 Complete System **£ 163.95**

Save £ 18.95



Best

31-2049. STA-18B AM/FM Stereo Receiver
40-1969. Two Optimus-1 Speakers
42-2935. LAB-12B Automatic Turntable with Base and Stereo Magnetic Cartridge

Worth £ 234.80 Complete System **£ 209.95**

Save £ 24.85

Realistic AM/FM Stereo Receiver - For real value!



£ 109.95

Includes walnut case worth £10

Realistic STA-46. Designed with just about every possible feature, yet priced below what it should cost! There's OTL audio, all-silicon FET-FM front end for truly fine reception, and wide-band AM. The STA-46 also has tape outputs and inputs for recording off-the-air or adding a recorder or deck. The tape monitor switch lets you listen as you record! Plus: magnetic pickup input, illuminated signal-strength and centre-channel meters, main & remote speaker switches, stereo/mono switch and loudness switch for deep bass even at low volume! Separate volume, balance,

full-range bass & treble controls. Complete with line cord FM, built-in AM antennas, FM stereo light, headphone jack. Attractive brushed aluminium front panel. 432x305x127 mm.

31-2026 STA-46 £109.95

Specifications: Output at 8 ohms: 36 watts IHF, 25 watts RMS. Response: 20-25,000 Hz \pm 1 dB. Power Bandwidth: 25-25,000 Hz. Harmonic Distortion: under .8%. IM Distortion: Less than 1%. Hum & Noise: -65 dB. Input Sensitivity: Phone 2.5 mV. FM Sensitivity: 3.0 μ V. Separation: 34 dB. Signal-to-Noise: 55 dB. Output: 4-16 ohms.



Dual Tuning Meters



4-position Mode Selector



Ganged Tone Controls



Tape Monitor Switch



Main & Remote Speaker Switches



"Black-Out" Tuning Dial



31-2026. STA-46 AM/FM Stereo Receiver
40-1980. Two MC-1000 Two-way Air-loaded Speaker Systems
42-2935. LAB-12B Automatic Turntable with Base and Magnetic Stereo Cartridge

Worth Complete System
£202.90

Save £19.95 **£ 182.95**



31-2026. STA-46 AM/FM Stereo Receiver
40-451. Two Solo-3B Wide-range Speaker Systems
42-2935. LAB-12B Automatic Turntable with Base and Magnetic Stereo Cartridge

Worth Complete System
£212.80

Save £20.85 **£ 191.95**



31-2026. STA-46 AM/FM Stereo Receiver
40-2002. Two Optimus-5 Four-Element Speakers
42-2937. LAB-36A Precision Tracking Automatic Turntable with Elliptical Stereo Cartridge

Worth Complete System
£281.90

Save £28.95 **£ 252.95**

Realistic AM/FM Stereo Receiver with Quatravox Four-Channel Synthesizer

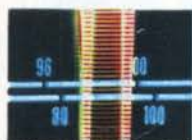

Colour-changing Dial Pointer!



Quatravox Control for Synthesized 4-Channel Sound!



FM Muting Eliminates Tuning „Hiss“!

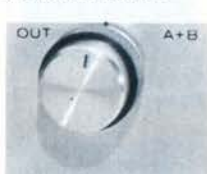

A & B Speaker Selector lets you Select Main, Remote or Both Pairs of Speakers!



Overload Indicator Warns of Harmful Load, Shorts!

£ 139.95

Includes walnut case worth £ 10

Realistic STA-75. The „value sensation“ for 1974 has our exclusive Quatravox built in for derived 4-channel sound from any 2-channel stereo source! Just add four speakers and you'll get a quadraphonic effect – like in theatres or nightclubs! Or, use it as a stereo receiver and add two extra speakers later on. Special features of the STA-75 include: Sensitive IC/FET-FM and wideband AM tuner circuitry; main-remote speaker control; automatic FM mono-stereo switching; dual-purpose illuminated tuning meter; push-buttons for power on/off, loudness, tape monitor

and FM muting; AC convenience outlet. The STA-75 has all the inputs and outputs to make it very versatile – and it's fuse protected. 133×476×343 mm.

31-2045 **£ 139.95**

Specifications: Output at 4 ohms: 50 watts RMS. Output at 8 ohms: 40 watts RMS. Response: 15-50,000 Hz. Power Bandwidth: 15-50,000 Hz. Harmonic Distortion: Under 0.7%. IM Distortion: 0.8%. Input Sensitivity: Phono, 3 mV. FM Sensitivity: 3.5 µV. Separation: 33 dB. Signal-to-Noise: -60 dB. Output: 4-16 ohms.



31-2045. STA-75 AM/FM Stereo Receiver
40-451. Two Solo-3 Compact Speaker Systems
42-2935. LAB-12B Changer with Base and Magnetic Stereo Cartridge.

Worth ~~£ 242.80~~ Complete System
£ 218.95

Save
£ 23.85



31-2045. STA-75 AM/FM Stereo Receiver
40-1969. Two Optimus-1 20-20,000 Hz Speakers
42-2935. LAB-12B Changer with Base and Magnetic Stereo Cartridge.

Worth ~~£ 284.80~~ Complete System
£ 256.95

Save
£ 27.85



31-2045. STA-75 AM/FM Stereo Receiver
40-4020. Two Nova-8 Bookshelf Speaker Systems
42-9010. LAB-30 Manual Turntable with Elliptical Diamond Cartridge

Worth ~~£ 327.80~~ Complete System
£ 294.95

Save
£ 32.85

Realistic STA-80 AM/FM Stereo Receiver

£ 149.95



Includes Walnut wood case worth £ 12

Loaded with a Combination of Features seldom found at ANY PRICE!

At last – a receiver that combines the most useful features with outstanding beauty and style! For example, the STA-80's silver-grey extruded aluminium panel has black trim and an electric-blue-green dial with an illuminated yellow pointer/FM stereo beacon that changes to red on stereocasts. The FET/IC FM front end pulls in weak stations yet does not overload on strong, local stations. And there's wideband AM, of course! The silicon-transistor OTL amplifier offers stable performance under virtually all operation conditions. A tape monitor switch and taping outputs allow professional recording with 3-head equipment. Then there's FM muting to stop hiss between stations while dialing, there are pushbuttons for stereo-mono, high filter and loudness, and a selector for main, remote or main plus remote speakers. Other features include a separate pushbutton

for power on/off, Glide-Path volume and balance controls, headphone jack, RCA-type and screw terminal speaker connections, 75-ohm and 300-ohm FM antenna terminals. And on top of that, two tuning meters: centre-of-channel for FM, signal-strength for AM – the best for each!

31-2046 £ 149.95

Specifications:

Amplifier. Power Output at 8 ohms: 56 watts IHF, 44 watts RMS. Frequency Response: 20-20,000 Hz ± 1 dB. Harmonic Distortion: less than 1%. Power Bandwidth (IHF): 20-50,000 Hz. Hum & Noise: Less than 60 dB phono, less than 80 dB aux. Sensitivity: Phono – 2.8 mV, Tape/Aux. – 200 mV.

FM Tuner. Sensitivity: 2.5 µV (IHF). Separation: over 36 dB at 1000 Hz.

AM Tuner. Sensitivity: 20 µV for 20 dB S + N/N ratio.

Antennas. Build-in AM and FM plus external antenna terminals.

Power Requirements. 220/240V AC, 50/60 Hz.

Dimensions: 127×459×317 mm



**Lighted Dial/
Stereo Beacon**



**Front Panel
Headphone Jack**



**Glide-Path
Volume Controls**



**Main & Remote
Speaker Selector**



**Pushbutton
Function Switches**



**Dual Tuning
Meters**



Good

31-2046. STA-80 AM/FM Stereo Receiver
40-2022. Two Optimus-2 Bookshelf-size
Speaker Systems
42-2935. LAB-12B Changer with Base and
Magnetic Stereo Cartridge

Worth £ 254.80
Complete System
£ 229.95

Save
£ 24.85



Better

31-2046. STA-80 AM/FM Stereo Receiver
40-4021. Two Nova-7 3-way Speaker
Systems
42-2937. LAB-36A Precision Tracking
Automatic Turntable with Elliptical
Stereo Cartridge

Worth £ 312.80
Complete System
£ 279.95

Save
£ 32.85



Best

31-2046. STA-80 AM/FM Stereo Receiver
40-4023. Two Optimus-9 5-speaker
Systems
42-9010. LAB-30 Manual Turntable with
Elliptical Diamond Cartridge

Worth £ 361.80
Complete System
£ 324.95

Save
£ 36.85

Realistic STA-150 AM/FM Stereo Receiver

The World's first Receiver with Auto-Magic FM Tuning

£ 199.95



FET-FM! Wideband AM! 7 Integrated Circuits! Transformerless Audio!

When you turn the tuning knob, AFC is deactivated for easy station selection. Release the knob, and Auto-Magic fine-tunes and locks in the station! There are seven IC's to make this one of the finest receivers ever - four in the FM-IF stages, one in the wideband AM circuit and two in the multiplex and muting circuits. Three dual-gate FETs in the RF/mixer stages for high sensitivity without overloading. The OTL amplifier has the power needed for deep bass even with two pairs of speakers. A midrange control allows you to adjust the music to „bring out“ (or back off) soloists, as you prefer. The Glide-Path volume controls incorpo-

rate Tandy's exclusive „Perfect Loudness“ system which adds just the right amount of bass and treble for any listening level. High and Low filters and FM muting remove hiss, rumble and tuning „thumps“. There's a tape monitor switch, tape copying provisions, and high-low phono switch. FM/AM tuning meter. A lighted yellow dial pointer turns red to indicate stereo-casts. There are 15 front and rear panel controls in all, plus a headphone jack.

31-2047..... £ 199.95

Specifications.

Amplifier. Power Output at 8 ohms: 100 watts IHF, 65 watts RMS. Frequency Response: 20-20,000 Hz. Power Bandwidth: 15-70,000 Hz. Harmonic Distortion: Less than 1%. Hum & Noise: Phono -70 dB; Tape & Aux. -80 dB. Sensitivity: Phono 5.0 mV; Tape/Aux. 200 mV.
FM Tuner. Sensitivity: 1.6 µV (IHF). Stereo Separation: 45 dB at 1 kHz. Signal-to-Noise Ratio: 70 dB.
AM Tuner. Sensitivity: 20 µV. Selectivity: 30 dB.
Power Requirements: 220/240V AC, 50/60 Hz.
Dimensions: 140x489x365 mm.



Auto-Magic for Perfect FM Tuning



5-Position Input Selector



High and Low Filters



Midrange, Bass, Treble Controls



Glide-Path Volume/Balance



Easy-to-use Pushbuttons



31-2047. STA-150 AM/FM Stereo Receiver
40-1969. Two Optimus-1 Bookshelf Speaker Systems
42-2937. LAB-36A Precision Tracking Automatic Turntable

Worth ~~£ 356.80~~
Complete System
£ 319.95
Save
£ 36.85



31-2047. STA-150 AM/FM Stereo Receiver
40-2002. Two Optimus-5 Speaker Systems
42-9010. LAB-30 Manual Turntable with Elliptical Diamond Cartridge

Worth ~~£ 366.90~~
Complete System
£ 329.95
Save
£ 36.95



31-2047. STA-150 AM/FM Stereo Receiver
40-4023. Two Optimus-9 5-Speaker Systems
42-9010. LAB-30 Manual Turntable with Elliptical Diamond Cartridge

Worth ~~£ 411.80~~
Complete System
£ 369.95
Save
£ 41.85

Now! The first moderate cost Realistic AM/FM Receiver built for ANY kind of Stereo or 4-Channel sound



£ 169.95

Included: Walnut cabinet worth £15

Realistic QTA-751. This is the receiver built for today with tomorrow in mind! The SQ decoder gives true 4-channel sound from quadrasonic records, tapes and FM. The Aux-4 inputs accept discrete 4-channel from open-reel tapes and Q-8 cartridges. Our exclusive Quatravox gives synthesized 4-channel from all 2-channel stereo sources! Includes inputs & outputs plus monitor for professional recordings with 3-head tape equipment. Glide-Path front and rear volume controls, rotary left and right balance controls, 4-channel loudness switch, dual concentric bass and treble controls for independent adjustment of front and rear channels,

stereo/4-channel headphone jacks and stereo FM light!

31-4009 **£ 169.95**

Specifications:

Amplifier. Audio output at 8 ohms: 80 watts IHF, 60 watts RMS. Harmonic Distortion: Under 0.8%. Frequency Response: ± 1 dB, 20-20,000 Hz. Power Bandwidth: 20-25,000 Hz. Hum: -65 dB.

Radio/Tuner Circuit. FM Sensitivity: 3.3 μ V IHF. FM Stereo Channel Separation: 30 dB at 1000 Hz. Signal-to-Noise Ratio: 65 dB. AM Sensitivity: 6 μ V for 30 dB S/N. AM Signal-to-Noise Ratio: 40 dB.

Antennas. Built-in AM and FM

Power Requirements. 220/240V AC, 50/60 Hz.

Dimensions. 330x402x145 mm.



4-Channel Headphone Output



TWO Tuning Meters



Front & Rear Volume Controls



4-Channel Loudness Control



Front & Rear Speaker Switches



Tape Monitor



31-4009. QTA-751 AM/FM Stereo Receiver with Quatravox
40-1981. Four MC-500 Bookshelf Speakers
42-2935. LAB-12B Changer with Base and Magnetic Stereo Cartridge

Worth £274.90 **Complete System**
£ 246.95

Save
£ 27.95



31-4009. QTA-751 AM/FM Stereo Receiver with Quatravox
40-1980. Four MC-1000 Acoustic Suspension Speakers
42-2935. LAB-12B Changer with Base and Magnetic Stereo Cartridge

Worth £330.90 **Complete System**
£ 294.95

Save
£ 35.95



31-4009. QTA-751 AM/FM Stereo Receiver with Quatravox
40-2022. Four Optimus-2 Speaker Systems
42-9010. LAB-30 Manual Turntable with Elliptical Diamond Cartridge

Worth £361.70 **Complete System**
£ 324.95

Save
£ 36.75

Realistic Low-cost Stereo Components



10-watt Stereo Amplifier

Realistic SA-100C. Enjoy economy stereo without compromising quality, features or looks! The SA-100C has a full array of controls you'd expect to find only in more costly amplifiers: FET for lowest noise and high gain; ceramic phono & tuner inputs; full-range tone plus separate volume & balance controls; power, Mono/Stereo and selector switches. There's even a stereo headphone jack and speaker „On-Off“ switch for private listening! Stylish extruded aluminium panel with walnut-grain wood case. 228×76×165 mm.

31-1970 £24.95



Matching AM/FM Tuner

Realistic TM-100. The perfect match for the SA-100C – together they make a stereo pair at a price you can't beat! Superb FET/IC chassis assures fine stereo FM reception and over 25 dB separation. AM section pulls in stations across the dial. The TM-100 has lighted slide-rule dial, stereo indicator light, line cord FM antenna plus external antenna terminals, positive-action power On-Off and AM/FM switches. FM Sensitivity: 5.0 μ V for 20 dB S/N ratio. Brushed aluminium panel and walnut-grain wood case. 228×76×165 mm.

31-2043 £29.95

Unique Stereo Modules – real value from Tandy



Compact 24-watt Solid State Amplifier

20-20,000 Hz Reponse!

Realistic SA-175C. Mini-sized, mini-priced . . . a lot of stereo in a small space! Switch selects magnetic or ceramic phono input, tape inputs and outputs too. ITL/OTL direct-coupled circuit delivers full power over entire frequency range. Other deluxe features included ganged volume control, stereo/mono switch, headphone jack. Power Output: 24 watts \pm 1 dB, 14 watts IHF. Harmonic Distortion: under 1.5%. 178×254×101 mm

31-1973 £39.95

and a matching AM/FM Stereo Tuner

FET FM Front End!

Realistic TM-175B. Gives stereo fans the wanted features usually found only in larger and more expensive models! Sensitive 5 μ V circuit pulls in more stations more clearly. Tuning meter shows both centre-channel FM and AM signal strength. Smooth vernier circular tuning dial, rear panel volume controls, front panel stereo-mono switch, pilot & stereo indicator lights. 25 dB stereo separation. 178×254×101 mm

31-2003 £44.95

Realistic Amplifiers and Tuners



Realistic 80 Watt Deluxe Stereo Amplifier

- **Walnut case included!**
- **3 Tone controls!**
- **Built-in synthesized 4-channel sound!**

£ 89.95

Available 30 May, 1974.

Realistic SA-1000. Our finest stereo amplifier with features you'd never expect at the price! Bass, treble and midrange controls, low and high filter pushbuttons and a tone control defeat pushbutton for flat response. Pushbuttons for selecting main/remote speakers and „Quatravox“ 4-channel sound. Pushbuttons also for loudness, mono/stereo, tape monitor and power. Inputs for magnetic record player, tuner, aux. 1 and aux. 2. Deluxe spring terminals and phono jacks for speaker connections. 386×111×256 mm.

31-1980 £ 89.95

Specifications: RMS Power at 8 ohms: 20 watts per channel at 1% THD over full 20 to 20,000 Hz, both channels driven. IHF Power: 40 watts per channel at 8 ohms; 55 watts at 4 ohms. Frequency Response: 20-20,000 Hz (+1.5 dB -4dB). IM Distortion: 0.2%. Hum & Noise: -75 dB aux.; -60 dB phono. Output Impedance: 4-16 ohms. Input Sensitivity: Phono high, 1.7 mV; Phono low, 3.4 mV; Aux, Tuner, 185 mV. Power Requirements: 220/240V, 50/60 Hz.



Deluxe AM/FM Stereo Tuner

- **Auto-Magic tuning!**
- **FM inter-station muting!**
- **MOS-FET FM tuner!**
- **Walnut case included!**

£ 89.95

Available 30 July, 1974.

Realistic TM-1000. A perfect match for the SA-1000. Features MOS-FET transistor for extra-high FM sensitivity, exceptional low noise and immunity to electrical interference. AM circuitry gives wide-bandwidth response. Our exclusive Auto-Magic tuner automatically engages a circuit when you touch the tuning control and allows precise tuning with the meter. When the control is released, Auto-Magic takes over and locks in the station. Pushbuttons for muting, power, AM, FM-Mono and FM-Auto; a rear-panel output level control; an illuminated dial pointer that turns to red on stereo stations. FM line cord antenna, AM loopstick, and connections for 75 & 300 ohms FM antennas. 386×111×256 mm.

31-1981 £ 89.95

Specifications: FM: Sensitivity: 2 μ V or better. Image Rejection: 50 dB. IF Rejection: 90 dB. Selectivity: 65 dB Signal-to-Noise: 65 dB Capture Ratio: 2 dB. Stereo Separation: 35 dB. AM: Sensitivity: 250 μ V/m. Image Rejection: 35 dB. Selectivity: 32 dB. Signal-to-Noise: 45 dB. Power Requirements: 220/240V, 50/60 Hz.



Realistic Stereo Amplifier designed for the Future!

Realistic SA-500. A great stereo amplifier featuring Glide-Path bass & treble controls. Pushbutton selectors for loudness, tape monitor, magnetic/ceramic phono, tuner, aux. Outputs for headphones, main/remote speakers, tape recorder. Switched and unswitched AC convenience outlets. Walnut wood case. 92×365×279 mm.

31-1975 £ 69.95

Specifications: Power output at 8 ohms: 45 watts IHF, 30 watts RMS. Frequency Response: \pm 1 dB, 20-20,000 Hz. Power Bandwidth: 30-20,000 Hz. Harmonic Distortion: less than 1% at full power. Hum/Noise: Phono, -50 dB; Tuner/Aux, -65 dB. Output Impedance: 4-16 ohms.

Realistic Optimus Speaker Systems

The Look and Sound of Luxury!



Optimus Bookshelf Speakers

Optimus-1. The 254 mm acoustic-suspension woofer has a special brass voice coil for solid response all the way down to 20 Hz without booming! Two extended-range, high-frequency tweeters handle midrange and highs with a clarity that's very impressive. Three-way high-frequency switch. 20-20,000 Hz full audio frequency response. 8 ohms impedance. Beautiful oiled walnut or teak speaker enclosure. The Optimus-1 proves you can still afford fine audio quality! 584×305×292 mm.

40-1969 Walnut £59.95
40-9969 Teak £59.95

Optimus-2. Perfect bookshelf-size for apartments or houses where space is limited. Designed for maximum performance with acoustic suspension high-compliance woofer and tweeter plus a three-way treble switch for tuning to „hard“ or „soft“ rooms. Phono jack and screw terminals for easy connection with any receiver or amplifier. Full 20-20,000 Hz response. 8 ohms impedance. Oiled walnut or teak enclosure. 254×280×508 mm.

40-2022 Walnut £39.95
40-9022 Teak £39.95



Optimus-5. Combines a massive 306 mm acoustic-suspension woofer with brass voice coil and three high-compliance tweeters in an ideally-sized floor/bookshelf enclosure. A unique crossover network allows all three tweeters to reproduce midrange – one reproduces the high frequencies for maximum dispersion. Includes variable controls for middle and high frequency compensation. Full 20-20,000 Hz response at 8 ohms. Enclosure in walnut or teak. 635×355×292 mm.

40-2002 Walnut ... £67.50
40-9002 Teak £67.50



Optimus-9. This 5-Speaker system achieves a unique dispersion of sound that gives the most life-like reproduction of music. The 306 mm acoustic-suspension woofer faithfully reproduces bass from 20-1000 Hz. Three matched midrange speakers have a flat response from 1000-7000 Hz. High compliance dome tweeter adds high-frequency reproductions from 7000 Hz to beyond the range of the human ear. Complete with a deluxe crossover network, midrange & tweeter controls for „personalized“ tone characteristics, decorator-designed moulded grille, phono jack/screw terminal connections. 20-20,000 Hz response at 8 ohms impedance. 711×482×228 mm.

40-4023 £89.95

Lifetime Guarantee

TANDY guarantees without time limitation the proper electro-mechanical function of all REALISTIC OPTIMUS and NOVA speaker systems in original unopened enclosures, providing that the system has not been physically abused (our determination is final) and that the owner provides transportation to and from the repair site. Your system must function properly or Tandy will repair it FREE – both parts and labour costs. This guarantee is honoured at all Tandy stores. Your receipt is all you need to obtain LIFETIME FREE SERVICE.

Realistic Acoustic-Suspension Bookshelf Speaker Systems

Fine-furniture Cabinets add Style to any Decor!



MC-1000

MC-500



5-YEAR GUARANTEE

See page 14

Realistic MC-500 Full-fidelity bookshelf system that is designed for great sound even in the tightest spaces. Air-loaded acoustic-suspension 127 mm woofer for full-sounding bass response down to 40 Hz; 50 mm high-frequency tweeter for highs with a bell-like clarity to 20,000 Hz. Compact enclosure is finished with oiled walnut or teak with matching grille cloth. 8 ohms impedance. Features RCA plug-in jack for easy connection to any amplifier or receiver; also screw terminals. 300 × 230 × 140 mm.

40-1981 Walnut £20
40-9981 Teak £20

Realistic MC-1000 Great for small apartments and limited space stereo systems! Rich, crisp sound compares with speakers costing twice as much. Acoustic-suspension 203 mm woofer, 76 mm wide-dispersion tweeter. Has the capacity for high-volume listening, but sensitive enough for the softest „lows“. 30-20,000 Hz, RCA jack and screw terminals, walnut or teak enclosure with matching grille cloth. 8 ohms impedance. 438 × 213 × 286 mm.

40-1980 Walnut £34
40-9980 Teak £34

The Richness of Fine Furniture combined with the Excellence of Realistic Hi-Fi



Nova-8

Nova-7



LIFETIME GUARANTEE

See page 12

Realistic Nova-7 Our 254 mm 3-way speaker system will enhance any hi-fidelity stereo system. The 254 mm woofer presents bass to 20 Hz and two 89 mm tweeters offer middle range and highs to 20,000 Hz. Tweeter and midrange controls compensate for room acoustics. LC crossover network divides frequency spectrum for best response. Rich oiled walnut cabinet and lattice work with matching grille cloth. 8 ohms impedance. 562 × 316 × 282 mm.

40-4021 £62.95

Realistic Nova-8 From the lowest bass to the most acute treble, our best Nova speaker will compare with any and all of the finest! 305 mm acoustic-suspension woofer and three high-compliance tweeters. Deluxe capacitive-inductive crossover – the woofer cuts out at 800 Hz, two mid-size units cover 800-5000 Hz, the tweeter covers 5000-20,000 Hz – four speaker elements in all. Tweeter and midrange control. 8 ohms. 635 × 356 × 292 mm.

40-4020 £77.95

Solo-3B

Realistic Solo Speakers for Sound Value



Five low-cost, high performance bookshelf speaker systems

Wide-range Solo-3B. An acoustic-suspension woofer of 203 mm puts forth full bass response. A 76 mm Optimus-series tweeter delivers excellent high-frequency clarity. 40-17,000 Hz response. 8 ohms. 571×324×235 mm.
40-451 £38.95

Acoustic-suspension Solo-103. Amazing fidelity for the price and size! Features unrestricted „acoustic cone excursion“ – first time ever in a 101 mm speaker! The magnet develops over 10,000 Gauss. 30-17,000 Hz, 8 ohms. Only 248×152×178 mm.
40-103 £11.95

Bookshelf size Solo-4. The space-saving Solo-4 is the perfect „add-on“ for your music system – or take 2 for stereo! Rear-loaded reflex-type enclosure. 100-12,500 Hz, 8 ohms. 165×400×190 mm.
40-2000 £9.95

Solo-1. A big sound at a low cost! Only 279×356×203 mm yet it rivals many bigger, more expensive speakers. Ultra-high compliance speaker. Wide 50-14,000 Hz frequency response. 8 ohms.
40-253 £15.95

Solo-5. A low-cost replacement speaker system which will fit your bookshelf. Ideal for replacements, extensions or „mini“ set-ups. Has a compact 127 mm full-range speaker component. Plug-in and screw terminals. 8 ohms. 254×216×140 mm.
40-913 Walnut £6.49
40-9913 Teak £6.49

5-Year Guarantee

TANDY guarantees the proper electro-mechanical function of all REALISTIC MC and SOLO speaker systems in original unopened cabinets, provided that the system has not been physically or electrically abused (our determination is final) and that the owner provides transportation to and from the repair site. Your Realistic speaker must function properly or Tandy will repair it FREE – both parts and labour costs. This guarantee is honoured at all Tandy stores. All you need to do is present proof of purchase.

203 mm Hi-Fi Patio Speaker

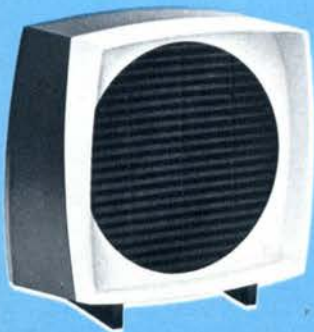

Great for outdoor music!

Full-range speaker which is perfect for the patio, terrace or poolside. Can be used indoors or out, free-standing or mounted on a wall. Easy carrying handle. Plug-in connections for radio, TV, record player. Screw terminals. 8 ohms. 254×216×140 mm.

40-1299 £11.95

Quartette 4-Channel Synthesizer



For 4-Channel sound effect!

Get a quadrasonic effect from ordinary stereo! For 8 ohm speakers. Blend and phase switches, amplifier cable. Can be set up in minutes.

40-981 £2.99

Add-on system!

– 1 Quartette Synthesizer
– 2 Solo-5 Bookshelf Speakers
For the special price of £14.95



Little speakers which give big sound

Realistic Minimus-2. A compact 178×203×356 mm, yet it gives w-i-d-e-r audio range and better sound than other speakers of its size and price! Oiled walnut cabinet holds a 152 mm acoustic-suspension woofer matched with a high-compliance tweeter. Adjustable tweeter level for „soft“ or „hard“ rooms. 20-20,000 Hz response. RCA-type jack or screw terminal connections. Lifetime Guarantee (see page 12).
40-1968 £27.95

Realistic Deluxe Wall Baffle. An acoustic-suspension 254 mm full-range speaker that looks as good as it sounds! Designed to be wall-mounted, it can be used indoors or out and has a handy volume control on the front. Complete with both RCA-type jack and screw terminals for easy hook-up. 40-15,000 Hz response at 8 ohms. Use 2 for stereo – or 4 for quadraphonic. 343×267×95 mm.
40-220 £15.95

Realistic Minimus 0.5. Ideal for extension use – it improves the sound quality of any portable radio, tape or cassette recorder. Compact – yet so efficient. Handles 10 watts music power at 8 ohms. Has RCA-type plug-in jack for easy connections. Handsome oiled walnut case with matching grille cloth. Includes Lifetime Guarantee (see Page 12). Only 120×168×114 mm. A sensational buy!
40-1995 £7.95
42-2444 18 cm patchcord for connection to recorder .. 99 P



Connects to ear-phone jack or recorder output. A cassette recorder can power it!

Realistic Quatravox - 4-channel excitement from any stereo source!

Add Quatravox and 2 speakers to your stereo for synthesized 4-Channel!



Enjoy derived quadrasonic sound from 2-channel records, tapes or broadcasts. Add Quatravox and an additional pair of 8-ohm speakers – they don't even have to be the same quality as your present speakers! Quatravox reveals reflected (ambient) sound hidden in ordinary stereo and lets you hear it like it's reflected at a live performance! Full complement of controls for complete versatility. Walnut enclosure. 70×184×136 mm.
40-2011 £9.95

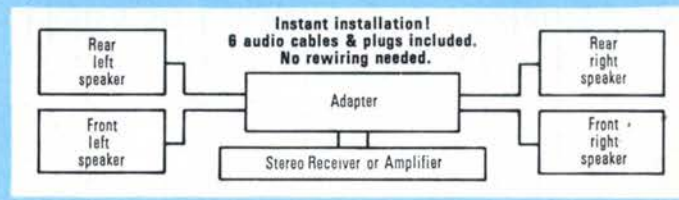

— Realistic Quatravox Synthesizer
 — 2 Realistic Solo-103 Acoustic-suspension speakers
Worth £33.85 Add-on System £ 29.85
Save £4



— Realistic Quatravox Synthesizer
 — 2 Realistic MC-500 2-Way Speakers
Worth £49.95 Add-on System £ 44.95
Save £5

Fully Assembled Realistic Stereo Turntables and Changers

- All include pre-installed Realistic/Shure magnetic cartridges
- All include a plastic dust cover
- All are pre-mounted on an attractive base



LAB-30 Four-Speed Single-Play Turntable

The LAB-30 is ideal for the select circle of enthusiasts who insist on manual operation. The low-mass, high-precision tone arm is made of square section aluminium and is supported on ball race bearings for greater stability and freedom of movement. It is fully counterbalanced. The Realistic/Shure magnetic cartridge with elliptical diamond stylus tracks as low as 1.5 g. The large diecast turntable is driven by a dynamically balanced 4-pole motor. Other features include dual-range anti-skate, muting switch, pop filter and slide-in cartridge carrier. Plays 78, 45, 33 and 16 rpm records.

42-9010 **£31.95**

LAB-12B Automatic and Manual Stereo Changer

Loaded with features that count! Adjustable tracking force, viscous-damped downward cueing, AC 'pop-filter', plus automatic, semi-automatic, manual and repeat play operation – automatic and manual play spindles included! Together with a dynamically balanced 4-pole motor and a low-mass, counter-balanced arm for precise tracking, the LAB-12B is factory mounted on an attractive base with walnut trim. Plays 33, 45 and 78 rpm records. Complete and ready to plug in, the LAB-12B is custom manufactured for Tandy in England. 168×387×335 mm

42-2935 **£24.95**



Anti-Skate control



Cueing & Pause Control



Magnetic Cartridge worth £ 7.95

LAB-36A Three-Speed Changer

Our best changer with every extra you can think of! There's a high-track-ability magnetic cartridge with a 2 × 7 mil elliptical diamond stylus, vertical and horizontal ball-bearing pivots for tracking capability under two grams, stereo muting during change cycle, heavy-duty turntable platter and separate anti-skate control for conical and elliptical styli. A synchronous motor controls speeds precisely at 33, 45 and 78 rpm. If you really treasure your records, this is the one for you! 165×387×336 mm.

42-2937 **£36.95**



Elliptical Cartridge worth £ 13.95



Synchronous Motor



Massive Die-cast platter



Dual-range calibrated anti-skate

Start your Stereo System with Realistic Low-cost Changers



Realistic 48 Stereo Changer

A great way to get the system going – in style! It comes ready to play with any system – or can also be used as a replacement in a console. Features a lightweight tubular pickup arm, a cueing lever and anti-skate adjustment. Then there's a large 260 mm turntable platter, slide-switch function controls, and an attractive base with a walnut finish! The Realistic 48 plays all sized records automatically and has three speeds. A plastic dust cover is included in the price.

374×336×82 mm.
42-2934 £15.95



The Realistic Modulaire – No extras to buy!

Low-cost, feature-packed changer which is ready to plug in and play! Lightweight tubular pickup arm has a factory-installed diamond needle cartridge which lasts four times longer than conventional needles. The Modulaire plays any sized records at 3 speeds, and you can even intermix 10" and 12" LPs of the same speed. And included in the price are a smoke-tint dust cover and a custom-made base! Great where space is limited – it measures only 333×244×178 mm.

42-2933 £11.75



Diamond needle cartridge

45 rpm adapter

Factory-mounted custom base

Smoke-tint dust cover

Realistic „Audiophile Series” Stereo Sound Effects & Test Records



28 Timed Sound Effects. Add an exciting dimension to home movies, parties, amateur plays, etc. Includes laughter, boat whistles, police car, rain & thunder, car skid and crash and many more.

50-1970 £1.59

Stereo Spectacular. Show-off your system's power and range with this LP! Excerpts from stereo recordings; sound effects; channel balance and direction demonstrations which span the entire audio range.

50-7777 £1.59

Stereo Test Record. Tops for testing frequency response, phasing & balance of stereo systems. Many popular marches for stereo demonstrations!

50-1971 £1.39

Live Mechanical Sound Effects. 38 everyday & unusual sounds in stereo. For home movies, slides, etc.

50-2016 £1.49

Sound Effects in Stereo. 50 sounds. Ocean liner, jets, crowds, radio code, typewriters, etc.

50-2017 £1.59

Sound Effects in Stereo. 48 sounds. Chinese New Year, car crash, animals, slot machine, others.

50-2018 £1.59

Realistic Stereo Headphones



Nova-Pro

£ 18.95

for luxury listening

Really professional headphones with vinyl cone speakers that improve stereo sound. Each earcup has an independent volume control. Wide 20-20,000 Hz response and 8 ohms impedance. Adjustable headband and 3 meters of coiled cord.

33-1014

£18.95



£ 49.95

Realistic HP-100 Electrostat Headphones

An entirely new experience in stereo!

Electrostatic design eliminates diaphragm breakup and distortion. Energizer plugs into a standard AC outlet and features a speaker/phones switch which can cut out either speakers or headphones. Includes 3 m coiled headset cord, energizer with AC cord, leads for amplifier hookup and terminals for speaker hookup. 20-20,000 Hz response! A fantastic buy for the serious audiophile!

33-1017

£49.95



Nova-15

Stereophones for expanded sound!

Fine audio quality combined with superior comfort! Each earcup has a „ported“ back to increase bass response and comfortable cushions to reduce fatigue. Lightweight, adjustable headband. 20-20,000 Hz response. Complete with 3 m cord and 6.35 mm plug.

33-1015 £11.95



Air-cushioned Headphones

Lightweight and comfortable!

Earphone housings in light aluminium and aircushioned cups give added comfort and reduced weight. The spring headband is covered in wear-resistant fabric. 40-15,000 Hz, 4-16 ohms. 3 m coiled cord.

33-195 £9.49



Nova-20

For the demanding audiophile!

Great value for money. These top-quality headphones have 10 cm speakers which give 30-18,000 Hz response, cushioned earcups and a padded, adjustable headband. 4-16 ohms impedance. Complete with 3 m coiled cord.

33-1038 £12.50



Nova-10

Headset on a budget!

Fantastic value for money! Full-range stereo of a quality you just wouldn't expect at this price! 5 cm transducers give 50-15,000 Hz response; impedance is 4-16 ohms. Vinyl headband and 3 m coiled cord.

33-1012 £5.99

Nova-44 Stereo/Quadraphones

**Listen to Full Stereo
PLUS Exciting 4-Channel Sound!**

- Each earcup has separate speakers for front & rear channels!
- Dual plugs for regular stereo (use one) or 4-channel (use both)!

If you want smooth, virtually distortion-free stereo plus the added realism of 4-channel „surround-sound“, then our NOVA-44s are just the „ticket“ to your own personal concert hall! Ported earcups eliminate closed-in feeling, let you hear spacious „full“ sound! Special design extends bass, expands highs for full 20-20,000 Hz response. Comfortable, adjustable headband, 5 m coiled cord, dual 6.3 mm plugs, 4-16 ohms.

33-1016 £24.95



Special Headsets and Useful Accessories from Tandy



**Low-cost mono
8-ohm
headphones**

Great value for HAM operators and SW listeners. Adjustable metal headband. 8 ohms. 6.3 mm phone plug.

279-198 £2.39



Deluxe 8-ohm type with large, soft ear-cushions and vinyl-covered double headband. Cord has 6.3 mm phone plug.

279-200 £4.39



Headphone Extension Volume Control

Adjust your stereo headset from your chair! Coiled 50 cm cable extends to 2.4 m.

33-1011 £2.79



2000 Ohm Headphones

Comfortable and adjustable. Features vinyl headband and tip plugs for portables, etc.

33-180 £2.19



Transistor Earphone

For portable recorders

33-175 With 3.17 mm. plug ... 65 P
33-174 With 2.4 mm. plug ... 65 P



Pillow Speaker

Precision speaker with miniature phone plug.

33-206 £1.29



Headphone „Y-“ Adapter

Connects 2 sets of headphones to one stereo headphone jack. 3-conductor phone plug connected to two 3-conductor jacks.

42-2448 £3.19

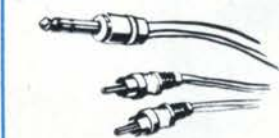

Stereo „Y-“ Adapter

Record directly from headphone output on receiver. 2 m cord, phone plug, 2 phono plugs.

42-2474 £2.29



Stereo/Mono DUoFONE

8-ohm set for use with any solid-state stereo or mono equipment. Plugmounted selector switch, wide-range dynamic elements.

33-196 £3.95



Nova-Fone Earphone Speaker

Completely covers the ear! Dynamic 8-ohm speaker, 30-14,000 Hz. 3.17 mm mini phone plug.

33-1036 £1.99



Amplifier-Headphone Coupler

Attach stereo headphones to any amplifier that doesn't have a jack.

33-1009 £1.29



Deluxe Headphone Junction Box

Connects 1 or 2 pairs of headphones to any amplifier or receiver. Switch controls headphones and speakers. 4-16 ohms, 120x40x44 mm.

33-1010 £2.95



6 Meter Earphone Extension

3.17 mm miniature jack and plug for transistor radios, etc.

33-176 69 P



4m Stereo Headset Replacement Cable

Coiled-cord replacement extends. 3-conductor.

42-2476 £2.99



7m Stereo Headphone Extension Coiled Cord

Easy to connect & extend your headphones! Shielded cable has stereo plug and jack.

42-2443 £3.99



6 m Stereo Headphone Extension

Shielded cable with stereo plug and jack. Use your headphones anywhere in the room.

42-2442 £2.99

Tandy - Your Headquarters for Realistic Gramophone Accessories

Stereo Preamplifier - Use a Magnetic Cartridge!

- **Solid-State Circuitry**
- **Instant Installation**

Use a changer with a magnetic cartridge - even with equipment that has a ceramic phono input. You'll get the increased bass & treble that only a magnetic cartridge can provide. Easy to connect. 63x101x38 mm.

42-2930 **£6.45**



Record cleaning kit keeps records

„young“

Includes fluid, applicator, stylus brush. Easy to use.

42-1085 **£ 1.29**



Easy-to-use record cleaner spray

- With spray and cloth

Fine spray penetrates deep into record grooves to remove harmful dust and dirt. Reduces record and needle wear.

42-2500 **89 P**



Stylus pressure gauge

Correctly adjusts tracking down to 0.25 g. Easy to use - no special calculating needed.

42-2350 **79 P**



Economy plastic changer cover

Protects your turntable from harmful dust and dirt. 432x381x222 mm.

42-1069 **£ 1.49**

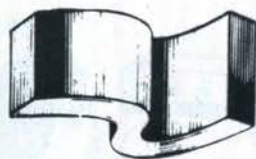

Acoustic insulation

Fibreglass insulation for lining speaker enclosures. Prevents resonances and gives better bass response. Line changer to reduce feedback. 90 cm².

42-1082 **£ 2.49**



Enduro-Clean pad

Discharges static electricity to keep your records clean. Just wet the pad and wipe the grooves whilst record turns.

42-121 **69 P**



50-power stylus microscope

Inspect needles for signs of wear, chipping or breaking. You'll know when it's time to change your stylus!

42-747 **£ 1.69**



Deluxe record sleeves

Vinyl-lined paper sleeves protect your records from dust, dirt and fingerprints. Fits standard 12" LP. Pack of 12.

42-132 **£ 1.19**



45 RPM record inserts

Twelve snap-in inserts let you play your favourite 45s without a special spindle. Pop out for re-use.

42-125 **19 P**



10" & 12" Turntable cushions

Foam cushion grips record to prevent slipping. Reduces rumble.

42-360 10" **59 P**

42-361 12" **69 P**



Low-cost record sponge cleaner

Cleans record grooves whilst record turns.

42-131 **39 P**

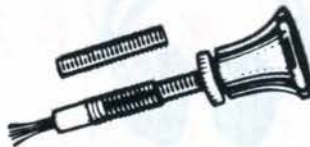

Changer mount stylus brush

Keep harmful particles from adhering to your needle and eventually causing the needle to chip. Mounts on changer.

42-746 **79 P**



Vinyl record sleeves

Twelve 13" vinyl dust jackets with rounded bottoms for perfect fit. Excellent protection for your valued LPs.

42-1070 **79 P**



45 rpm spindle adapter

For playing 45 rpm discs on standard gramophone spindles. Moulded plastic adapter slips over regular spindle.

42-120 **20 P**



Clip-on record brush

Snaps on tonearm and cleans records as they play. Soft brush reaches deep into record grooves.

42-1073 **30 P**



Our finest record cleaner

Velvet-covered ionizer/cleaner. Polyurethane foam record cleaner removes particles and static electricity. Will wet or dry clean. Plastic cover and holder.

42-130 **£ 1.49**

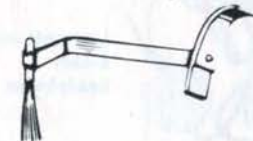

Record brush & tone arm lift

Clips on any tone arm to keep records dust-free. Eliminates static and grit. Automatic pressure control.

42-1072 **69 P**



Platter speed strobe disc

Checks the speed of any turntable. Helpful in making precise speed adjustments. Use with fluorescent light.

42-268 **29 P**



20 cm pickup arm with cartridge

- Dual Sapphire Stylus!
Perfect replacement arm for portable gramophones. Separate needle for 78s and LPs. With fingertip lift and arm rest.

42-004 Mono **£ 1.99**

42-128 Stereo **£ 2.99**



Record rack

Holds records of any size for easy selection. Brass-plated metal with walnut handles.

42-133 Holds 39 records. **£ 1.29**

42-134 Holds 60 records. **£ 2.49**

Low-Cost, Top-Quality Realistic/Shure Magnetic Stereo Cartridges



The Finest We've Ever Offered.
Tracks down to 0.75 g!

- Extra long-life stylus!
- 10-25,000 Hz response!

Realistic/Shure R700E „SuperTrack“. For the finest automatic & manual turntables. The 0.05×0.018 mm elliptical diamond stylus tracks records closest to the way they're made – light tracking force assures long record life. Channel Separation: 25 dB at 1 kHz. Tracks 0.75 to 1.5 g.
42-2765 £18.95



High-Performance Elliptical Tracks as low as 1-1.5 g.

- 20-20,000 Hz response!
- Bargain-priced!

Realistic/Shure R27E. Light-tracking hi-fi cartridge which gives crisp, clear response. Use with high-quality automatic and manual turntables without sacrificing audio quality. Channel Separation: over 25 dB at 1000 Hz. Diamond stylus, 0.05×0.018 mm.
42-2763 £13.95



Low-Cost Elliptical-Stylus Cartridge Tracks 1.5-3 g.

- Up-date your conical-cartridge system!

Realistic/Shure R47EB. Perfect for up-dating conical-cartridge systems for better sound! All the features of expensive models at a moderate price! For use with good quality changers and turntables. 0.010×0.018 mm diamond stylus. Channel Separation: 20 dB at 1 kHz. 20-20,000 Hz response.
42-2761 £10.95



Quality-Made Conical With 20-20,000 Hz Response.

- Our lowest priced magnetic cartridge!

Realistic/Shure R7C. Economy priced but gives high performance. Has 0.015 mm „floating“ conical diamond stylus that accurately tracks at forces of 3-5 g. Ideal for low-priced stereo changers. Channel separation: 25 dB at 1 kHz. A great buy!
42-2760 £7.95

Replacement Needles for Above (All are Interchangeable)

Each Realistic replacement needle fits any Realistic cartridge. Up-grade your conical cartridge to elliptical with a lower tracking needle!

Cat. N°	Model	Description	Price £
42-2776	RS7C	For R7C, Shure M71, M75, M90 series	6.95
42-2762	RS47EB	For R47EB, Shure M71, M75, M90 series	8.99
42-2764	RS27E	For R27E, Shure M71, M75, M90 series	12
42-2766	RS700E	For R700E, Shure M71, M75, M91, M92, M93, series	12.95

Magnetic Cartridge Replacement Diamond Needles

Goldring			Shure			
Cat N°	Fits	Price £	Cat N°	Model	Fits	Price £
42-9119	Goldring 800	2.95	42-238	N3D	Shure M3D, M7D	4.99
42-9118	Goldring 850	2.95	42-219	N21D	Shure M3D, M7D, M7N21D, 1.5-2.5 g only.	6.99

Realistic Diamond Replacement Styli

ALL ONE LOW PRICE: £1.19

Individually tested for uniform quality and response. Whole stone diamonds, finely graded. Only at TANDY can you purchase first grade British-made diamond styli at this bargain price. Every stylus is fully tested to eliminate any chance of ruining your valuable records. All styli are diamond-tipped on one side, and if double sided, have sapphires on the other. The code in the chart for Tip 1 and Tip 2 is: ST=Stereo, LP=Long Playing, 78=78 records only.

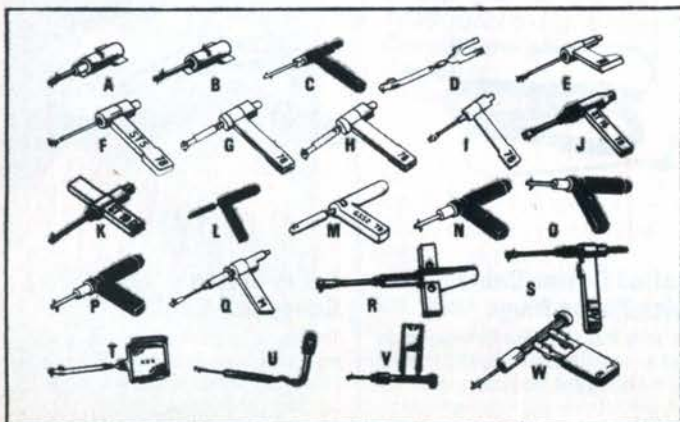

Cat. N°	Figure	Tip 1 Dia.	Tip 2 Supph.	Needle/Cartridge N°
ACOS				
42-9100	A	ST	ST	GP91-1SC
42-9101	B	ST	ST	GP98, GP91, GP95
42-9103	C	ST	ST	GP104
BSR				
42-9104	D	ST	—	TC8R, TC8RS, TC-8M, TC-8M, GP83-2
42-9105	E	ST	ST	ST4, ST3, X1M, X1H, X2HE, SX1M, SX1H, SX2H, C1
42-9110	F	LP	LP	ST6, ST5
42-9108	G	ST	78	ST9, ST8, X2M, X3H, 211
42-9109	H	ST	ST	ST10
42-9106	I	ST	78	ST14, ST12
42-9107	J	ST	ST	ST15
42-9111	J	ST	ST	ST17, ST16
42-9112	K	ST	—	ST19
GARRARD				
42-9113	L	ST	ST	GDS1, GCM31, GCS35, GCS36, Sonotone 2109, 2509, 2539
42-9114	M	ST	ST	GDS2, GCS38, Sonotone 2529
42-9115	N	ST	ST	K340A, ASS, ADS, Sonotone 3509
42-9110	O	ST	ST	K341B, BDS, BSS, Sonotone 3549
42-9117	P	ST	ST	K3H1C, CDS, CSS, Sonotone 3559
A.G. (PHILIPS)				
42-9102	Q	ST	ST	AG3306, AG3310, AG3324, AG3228
42-9123	R	ST	—	GP306, GP310, GP230, GP228, 946/SS-50
42-9124	S	ST	ST	GP205, GP204, GP213, GP212
SONOTONE				
42-9120	T	ST	—	BF-40, Binofluid, DC284, P, T, DC2840V, 400, Stereo 105, 106, 208, PE20, 30, 45, 90 Istra
SONOTONE				
42-9125	U	ST	ST	BT4A
42-9122	V	ST	ST	9TAF, 9TANC, Sonoflex
42-9121	W	ST	ST	9TA

Indestructible Realistic Audio Cables for Every Kind of Hookup

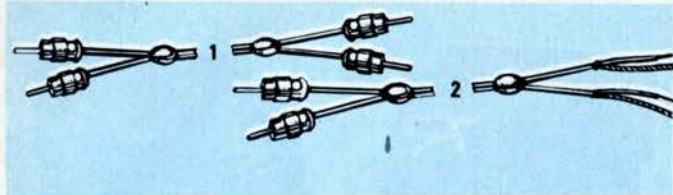

Injection Moulded Stereo Cable Assemblies

Shielded stereo cables for quick, easy connections. Plugs are colour-coded for correct hookup. Single grey cable splits 127 mm from each end for separate plugs.

Cat. N°	Fig.	Description	cm	Price £
42-2351	1	2 straight phono plugs at each end	91	1.25
42-2352	1	2 straight phono plugs at each end	182	1.49
42-2355	2	2 straight phono plugs at one end; 2 stripped and tinned ends	182	1.76

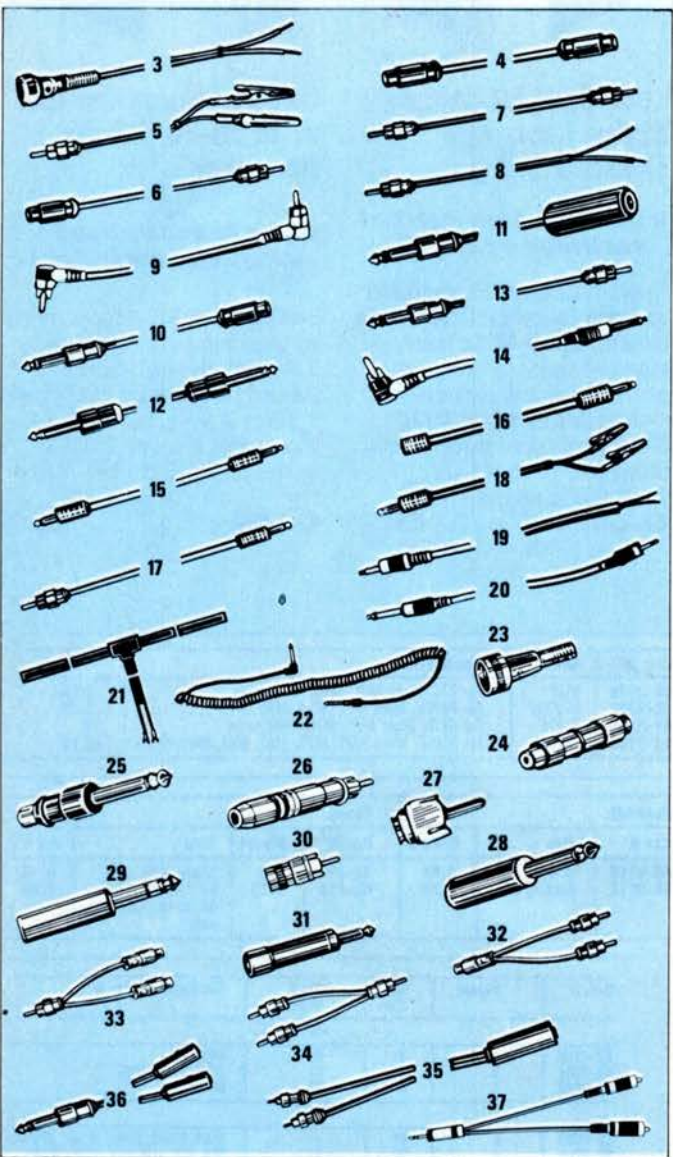

Moulded Cable Assemblies & FM Antenna

Multipurpose flexible cable for every application. All cables are grey, shielded except Fig. 5 (parallel wires for speaker connections), Fig. 21 (FM antenna), Fig. 22 (black coil cord, shielded).

Cat. N°	Fig.	Description	cm	Price £
42-2357	3	Mike connector to stripped, tinned ends	182	1.19
42-2358	4	Phono jack to phono jack	182	1.19
42-2359	5	Phono plug to alligator clips	365	1.29
42-2361	6	Phono plug to phono jack	91	89 P
42-2362	6	Phono plug to phono jack	182	99 P
42-2363	6	Phono plug to phono jack	365	1.39
42-2365	7	Phono plug to phono plug	45	69 P
42-2366	7	Phono plug to phono plug	91	79 P
42-2367	7	Phono plug to phono plug	182	99 P
42-2368	7	Phono plug to phono plug	365	1.49
42-2370	8	Phono plug to stripped, tinned ends	91	85 P
42-2371	8	Phono plug to stripped, tinned ends	182	99 P
42-2372	8	Phono plug to stripped, tinned ends	365	1.19
42-2441	9	90° phono plug to 90° phono plug	182	1.19
42-2377	10	Phono plug to phono jack	182	1.19
42-2378	11	Phono plug to phone jack	365	1.19
42-2381	12	Phone plug to phone plug	182	1.19
42-2373	13	Phone plug to phone plug	182	1.19
42-2440	14	90° phono plug to phone plug	182	1.49
42-2420	15	Miniature phone plug to miniature phone plug	182	89 P
42-2472	16	Miniature phone plug to miniature phone jack	182	1.49
42-2444	17	Miniature phone plug to phono plug	182	99 P
42-2421	18	Miniature phone plug to alligator clips	182	1.19
42-2434	19	Mini phone plug to stripped leads	182	1.19
42-2433	20	Mini phone plug to phone plug	182	1.19
42-2385	21	FM Dipole antenna		1.49
42-2473	22	Coiled Guitar cord, 91 cm, extends to 4.5 m. Phone plugs 457		2.69

Adapters and Connectors

All adapters are made of high-strength, lightweight plastic... moulded for long life and noise-free operation.

Cat. N°	Fig.	Description	Price £
42-2388	23	Microphone connector, female/male	69 P
42-2404	24	Phone jack to phono jack	69 P
42-2405	25	Phone plug output, phone jack input	69 P
42-2414	26	Phone jack input to phono plug output	79 P
42-2417	27	Phono plug, pack of 5	49 P
42-2425	28	Phone plug, screw terminals	49 P
42-2391	29	Stereo phone plug, screw terminals	69 P
42-2390	30	Shielded phono plug, pack of 2	69 P
42-2429	31	Adapter: phono plug to „Tiny Plug“	79 P
42-2435	32	Y-Adapter: 2 phono plugs connected to one phono jack. 101 mm shielded cable	99 P
42-2436	33	Y-Adapter: Phono plug connected to 2 phono jacks. 76 mm shielded cable	1.19
42-2438	34	Y-Adapter: 3 phono plugs connected to 101 mm shielded cable.	99 P
42-2471	35	Y-Adapter: 3-conductor (stereo) phone jack to two phono plugs	1.79
42-2448	36	Y-Adapter: 3-conductor (stereo) phone plug to 2 3-conductor phono jacks	3.19
42-2477	37	Y-Adapter: 3-conductor (stereo) phone plug to 2 phono jacks	1.19



Colour-Coded 90 cm Audio Cables

Top-quality cables are shielded for good protection and low signal loss. Perfect for easy connections, testing equipment, or for making checks and repairs.

42-2309 £ 1.49



Phono Plug Coiled Audio Cables

Extend to 168 cm, retract to only 20 cm. For neat connections in any use.

42-2396 Phono plugs on each end 99 P

42-2397 Phono plug one end, stripped and tinned leads on the other 99 P

42-2398 Phono plug to colour-coded alligator clips £ 1.19

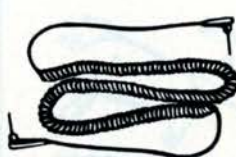

Coiled Guitar Cable with Phone Plugs

Let's you keep your guitar far enough away from its amplifier to virtually stop feedback. 3.6 m coiled cable has phone plugs at each end. Connects your guitar and amplifier.

42-978 £ 2.49



1,8 m Stereo Connector Cable

The easy and positive way to hook up all your components. Quality shielded cable has phono plugs at each end for most amplifiers, receivers and recorders.

42-977 99 P

Audio Cables and Adapters

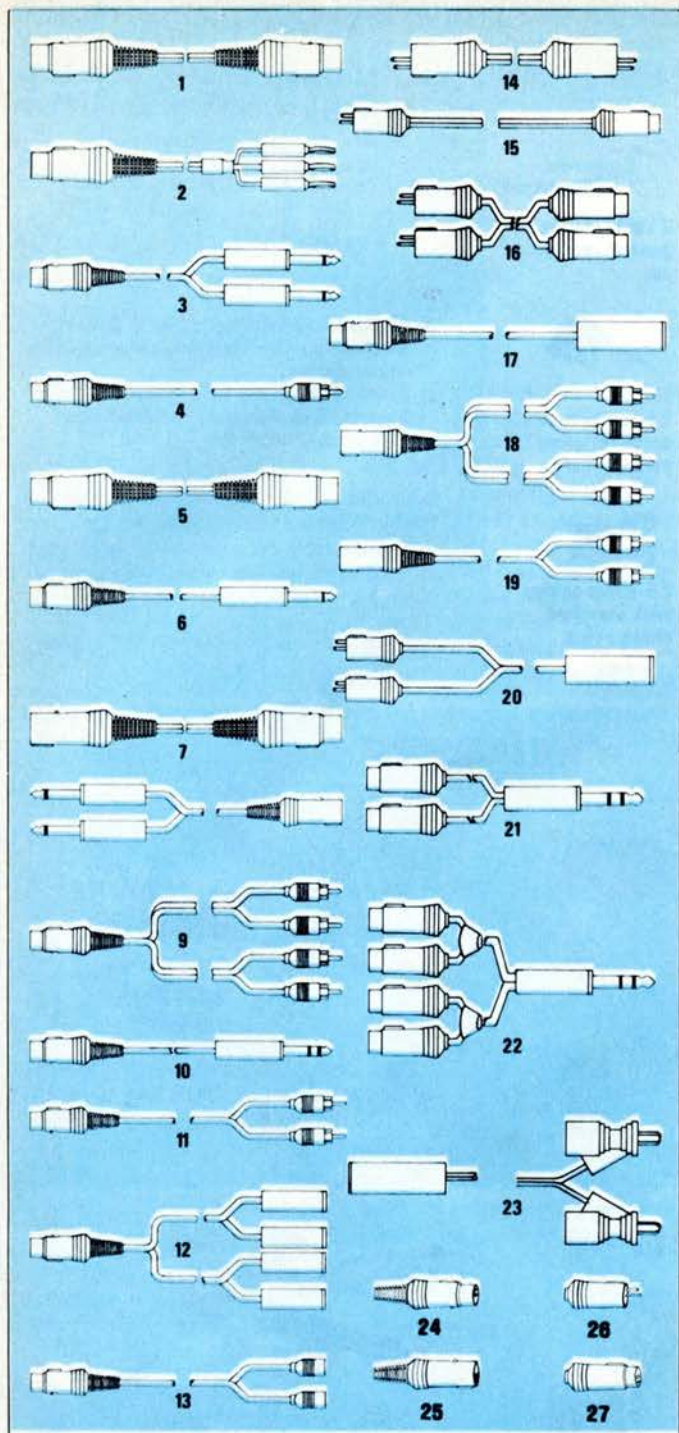

Cable Assemblies

Multi-purpose flexible cables. All are grey in colour.

Cat. N°	Figure	Description	Length (m)	Price £
42-9020	1	3-pin DIN plug to 3-pin DIN plug	1.5	89 P
42-9021	1	3-pin DIN plug to 3-pin DIN plug	2.5	1.29
42-9022	2	3-pin DIN plug to 3 banana plugs	1.5	1.49
42-9023	3	3-pin DIN plug to 2 miniature phone plugs	1.5	1.29
42-9024	4	3-pin DIN plug to phono plug	1.5	99 P
42-9025	5	5-pin DIN plug to 3-pin DIN plug	2.5	1.29
42-9026	6	3-pin DIN plug to 1 miniature phone plug	1.5	1.09
42-9027	7	3-pin DIN plug to 3-pin DIN jack	1.5	1.09
42-9029	8	3-pin DIN jack to 2 miniature phone plugs	1.5	1.29
42-9030	1	5-pin DIN plug to 5-pin DIN plug	1.5	1.49
42-9031	1	5-pin DIN plug to 5-pin DIN plug	2.5	1.79
42-9032	9	5-pin DIN plug to 4 phono plugs	1.5	2.39
42-9033	10	5-pin DIN plug to stereo phone plug	1.5	1.69
42-9034	3	5-pin DIN plug to 2 miniature phone plugs	1.5	1.49
42-9035	11	5-pin DIN plug to 2 phono plugs	1.5	1.39
42-9036	7	5-pin DIN plug to 5-pin DIN jack	1.5	1.49
42-9037	7	5-pin DIN plug to 5-pin DIN jack	2.5	1.79
42-9040	12	5-pin DIN plug to 4 miniature phone jacks	1.5	2.69
42-9044	13	5-pin DIN plug to 2 phono jacks	1.5	1.79
42-9047	14	DIN Loudspeaker plug to DIN loudspeaker plug	1.5	79 P
42-9048	14	DIN Loudspeaker plug to DIN loudspeaker plug	2.5	89 P
42-9049	14	DIN Loudspeaker plug to DIN loudspeaker plug	5.0	1.29
42-9050	14	DIN Loudspeaker plug to DIN loudspeaker plug	7.0	1.79
42-9051	14	DIN Loudspeaker plug to DIN loudspeaker plug	15.0	99 P
42-9052	15	DIN Loudspeaker plug to DIN loudspeaker jack	1.5	79 P
42-9053	15	DIN Loudspeaker plug to DIN loudspeaker jack	2.5	99 P
42-9054	15	DIN Loudspeaker plug to DIN loudspeaker jack	5.0	1.29
42-9055	15	DIN Loudspeaker plug to DIN loudspeaker jack	7.0	1.79
42-9057	16	2 DIN Loudspeaker plugs to 2 DIN loudspeaker jacks	1.5	1.19
42-9090	9	DIN plug to 4 phono plugs with 2 resistors. For connecting tape recorder to amplifier without DIN jack		1.99

Adapters and Connectors

All adapters have 20 cm grey connecting cable. Connectors are also grey, flexible and rubber covered.

Cat. N°	Figure	Description	Price
42-9028	7	5-pin DIN jack to 3-pin DIN plug	79 P
42-9038	17	5-pin DIN plug to stereo phone jack	1.39
42-9039	17	5-pin switched plug to 3-pin stereo phone jack	1.29
42-9041	18	5-pin DIN jack to 4 phono plugs	2.19
42-9042	8	5-pin DIN jack to 2 miniature phone plugs	1.09
42-9043	13	5-pin DIN plug to 2 phono jacks	1.49
42-9045	11	5-pin DIN plug to 2 phono plugs	1.19
42-9046	19	5-pin DIN jack to 2 phono plugs	1.19
42-9056	20	2 loudspeaker DIN plugs to stereo phone jack	1.29
42-9058	21	Stereo phone plug to 2 loudspeaker DIN jacks	1.29
42-9059	22	Stereo phone plug to 4 loudspeaker DIN jacks	1.79
42-9060	23	Stereo phone jack to 2 loudspeaker combination jack/plugs	1.99
42-9061	24	3-pin DIN plug	Packet of 2 39 P
42-9062	24	5-pin DIN plug	Packet of 2 55 P
42-9063	25	3-pin DIN jack	Packet of 2 55 P
42-9064	25	5-pin DIN jack	Packet of 2 59 P
42-9065	26	Loudspeaker plug, screw terminals	Packet of 2 59 P
42-9066	26	Loudspeaker plug, solder terminals	Packet of 2 49 P
42-9067	27	Loudspeaker jack, screw terminals	Packet of 2 79 P
42-9068	27	Loudspeaker jack, solder terminals	Packet of 2 39 P



Speaker Extension Cables with Phono Plugs

Convenient, easy hook-up. Terminates in phono plug at each end. Use for extensions or to move present speakers.

42-2392	7.3 m	(grey)	£1.49
42-2430	7.3 m	(white)	£1.39
42-2445	3.6 m	(grey)	£1.19
42-2431	3.6 m	(white)	£1.19



Speaker Extension Cables with Lug Connectors

Use to hook-up extensions or move your present system speakers. Easy to connect - no soldering required. Colour coded.

42-2446	7.3 m	99 P
42-2447	3.6 m	89 P



12 meter Stereo Speaker Cable

High-quality cable with phono plugs at each end for easy connections. Use to place speakers up to 12 m from the amplifier, or with remote speakers anywhere in the home. For use with all Realistic Receivers and Speakers.

42-2432 £ 3.19

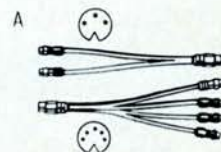

3- and 5-pin DIN Norm Y-Adapters

15 cm cables. Use to adapt DIN plugs to standard phono plugs and cables.

A. 42-2393 3-Pin Socket to 2 phono jacks £ 1.49

B 42-2394 5-Pin Socket to 4 phono jacks £ 1.79

Realistic Pro-100 13-Piece Microphone System for Studio-Quality Stereo Recordings.



2 Slide-on wind screens stop pops and noise



2 Table stands for general recording use



2 2-meter cables with moulded phone plug.



2 Lavalier neck cords for „live“ performances



2 Floor-stand adapters for Personal Address and Stage uses



2 6-meter cables with standard phone plugs.

● **Natural-sounding 100-10,000 Hz Response** for fine voice or music recordings!

● **Switchable 250 and 10,000 Ohms impedance** for use with virtually any equipment!

Everything you need for great recordings with all Realistic and most other reel-to-reel, cassette or 8-track recorders. Each mike has 6 accessories for total versatility. The carrying case has fitted compartments for accessories and is only 247x279x95 mm.

33-1024 **£19.95**

Low-Cost, High-Impedance Replacement Mikes for Every Use



Harmonica Mike. Crystal-contact enhances sound just as more costlier mikes do! Easily connectable to PA, radio or turntable.

33-115 **£1.19**



Lapel-Type Crystal Mike. Sensitive, easily concealable. 200-3000 Hz. 3 meters of cord with moulded mini plug.

33-100 **£1.79**



Lavalier Dynamic Mike. Pencil-slim with 1.40 meters of cable, neck cord and stand. On/Off switch incorporated.

33-928 **£4.39**

Low-Impedance Microphones for Cassette or Tape Recorders



Dynamic Cassette Mike. 150-10,000 Hz. Mini-plug for mike, sub-mini on/off.

33-1034 **£2.39**



Reel-to-Reel Recorder Mike. Mini-plug and coax. power plug with on/off switch. 200 ohms.

33-1030 **£2.95**



A. Cassette Mike with Stand. Mini-plug for mike, sub-mini on/off. 200 ohms.

33-1033 **£2.19**

B. Omnidirectional Conference Mike. Record meetings, lectures, parties! 400 ohms. 1.50 meters cord with mini-plug. Desk stand included.

33-1047 **£4.95**

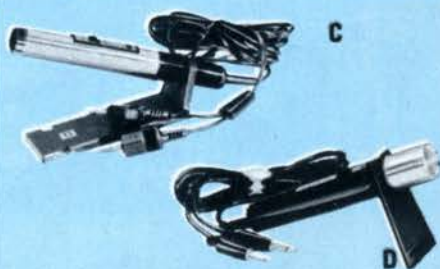

C. Dynamic Omni-Directional. 100-11,000 Hz. Desk stand, dual plugs, 1000 ohms.

33-1039 **£4.95**

D. For Portable Cassette Players. Mini-plug for audio, sub-mini for on/off.

33-1031 **£2.95**



Dynamic Cardioid. 100-11,000 Hz. 1000 ohms. With desk stand and dual plugs.

33-1040 **£6.49**

Realistic Electret Condenser Mikes and Mixers

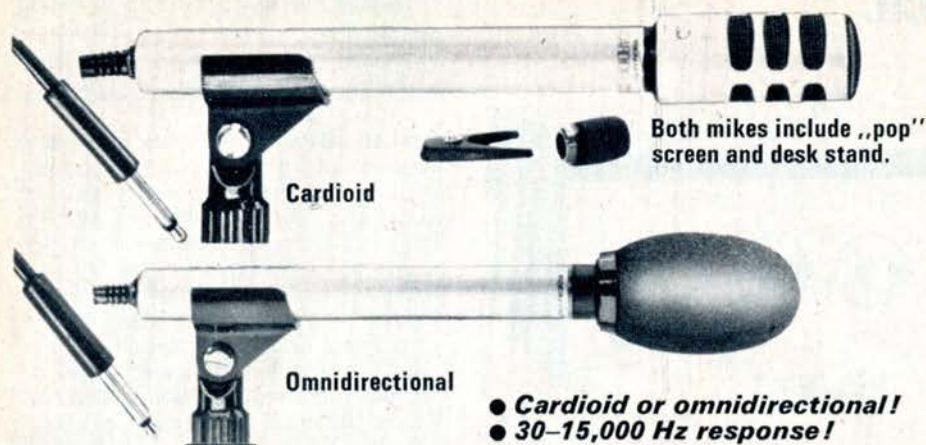

Both mikes include „pop“ screen and desk stand.

Cardioid

Omnidirectional

- **Cardioid or omnidirectional!**
- **30-15,000 Hz response!**

Two microphones designed to meet almost any microphone need! They are so good, they can be used with the highest quality sound systems or recorders. Special „foil diaphragm“ insures superb music or voice reproduction – perfect for live stage work. Wide frequency response equals that of professional broadcast mikes. Can be used with low (600 ohms) or high (20,000 ohms) impedance mike inputs. Windscreen blocks out unwanted noise and controls the echo in partially filled halls. Powered by „AA“ penlight battery for up to 10,000 hours or continuous operation. Battery included.

- 33-1045 Cardioid £18.95
- 33-1044 Omnidirectional £15.95

„Highball“ Dynamic Cardioid Dual-Impedance Mike



- **50-15,000 Hz Reproduction of Music and Voice!**
- **Special filter – no squeals, pops or booms!**

Very professional! On-off switch with a lock for the „on“ position. Internal impedance change: 50-250 or 50,000 ohms. Cannon connector, stand adapter.

Mike is complete with 4 meters cable, universal plugs, 6.3 mm phone plug adapter, MCIF Amphenol plug.

33-983 £26.95

„Highball-2“ All-Purpose Dynamic Microphone

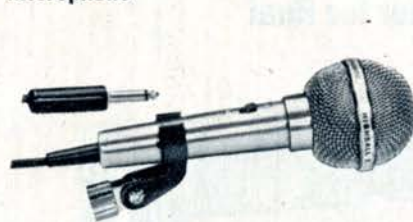

- **Feedback filter!**
- **Pop & Boom screen!**

Outstanding value! 250 & 50,000 ohms impedance, on-off switch, ball screen. 6.3 mm phone plug, 2 meters cable, stand adapter.

33-985 £8.95

Pencil-thin Dynamic Cassette Recorder Mike



- **100-10,000 Hz Audio Range!**
- **For hand, stand or lavalier use!**

MC-1000 – our lowest-priced dynamic model! Excellent for voice or music recordings. 10,000 ohms impedance. Complete with stand, 2 meters cable, 6.3 mm phone plug.

33-990 £5.95

„Highball 5“ Dynamic Cardioid Mike



- **70-13,000 Hz Audio Response!**
- **Quick change impedance plug!**

For general purpose use and for recording. 600 or 20,000 ohms impedance. „Pop“ filter stops squeals & booms. 6.3 mm phone plug, 4 meters cable, stand adapter.

33-1042 £18.95

Rubber Isolated Microphone with Unidirectional Pickup



- **Dual impedance!**
- **85-11,500 Hz frequency response!**

„Quick change“ feature selects 600 or 20,000 ohms impedance. Ideal for voice or „live“ performances. With 6.3 mm phone plug and stand adapter.

33-1041 £11.95

Dual-Impedance Super Cardioid Microphone



Designed for good audio at a budget price. 600 or 50,000 ohms impedance, 80-12,000 Hz response. Mesh screen stops feedback. Stand adapter, 6.3 mm phone plug.

33-992 £11.95

Pro-Quality Stereo Mike Mixer with Phono Input



Mixes & blends up to 4 mike inputs! Each mike has its own level control and a master control adjusts the overall volume. Stereo phono input lets you add background music. Stereo-mono switch allows 2 mike inputs per channel or 4

mike inputs for mixing/blending mono output at either channel. High/low impedance. 20-20,000 Hz, ± 3 dB, S/N, 50 dB. Uses 4 „AA“ batteries. 60x279x152 mm.

33-1043 £18.95

Mono-Stereo Mike Mixer



Mixes 4 mono mikes or a pair of mikes to each stereo channel. Stereo-mono and on-off switches. High impedance. Measures 57x152x89 mm. Uses one 9V battery.

33-920 £6.59

Realistic PA Amplifier with Instant „Priority” Paging Switch.

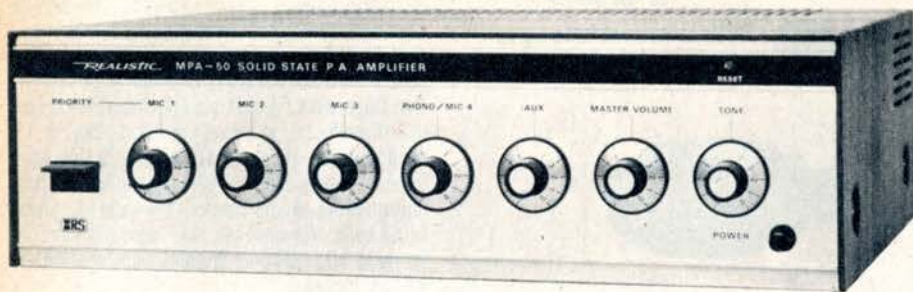

- **50-Watt Power!**
- **„Push-down” switch for Mike-1 lets you override all other channels for paging.**



Realistic MPA-50. A complete, solid-state PA control amplifier with four mike inputs plus an aux. input, for a total of FIVE mixable inputs! Master volume and tone controls, plus push-button for power on/off, allow all gain controls to „stay put” without constant readjustment. Rear-panel switch permits Mike-4 input to take a turntable in place of a mike. Outputs: 4, 8, 16 ohms, 25 and 70 Volt line. Protective circuit cuts-off output stages if overload occurs and an overload light flashes on. 50 watts RMS at 8 ohms. 100-10,000 Hz response at full power. 108×350×279 mm.

33-2021 £74.95

Realistic Dual Purpose PA Amplifier for Real Versatility



20-Watt Power!
220/240V AC/12V DC!
Use it anywhere!

- **Two mike inputs with mixing!**
- **Aux. and Phono inputs!**
- **Master volume & tone controls!**

Realistic MPA-20. For indoor or outdoor music and PA systems, PA cars, etc. Outputs for 4, 8 and 16 ohm speakers, plus 25 & 70 Volt line. Front-panel jacks for mikes 1 & 2, power on/off switch and power-on indicator light. 200-10,000 Hz response at full power. 20 watts RMS. 76×267×190 mm.

32-2020 £49.95

Low-Priced Sound Level Meter

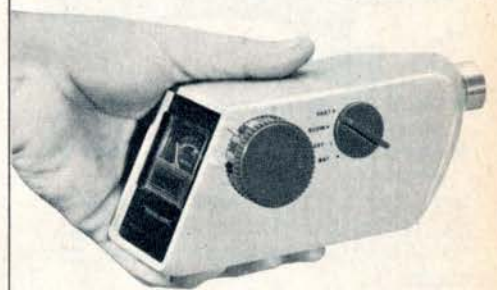

- **Fast or slow readings!**
- **Compares with units costing much more!**

A „must” for audio fans! Test sound levels in clubs, factories, sound-proof rooms, stereo and PA systems. Reads 60-116 dB in five 16 dB ranges. Accuracy, ± 2 dB at 74 dB pressure (standard 0 dB = .0002 dyn/cm²). Built-in battery tester. 184×70×70 mm.

33-1028 £26.50

Microphone Stands and Accessories

Mike Stand Adapter.



Converts mike quickly from hand to stand. High-impact styrene. For use with any assembly. 33-371 99 P

Full 33 cm Flexible Gooseneck.



Provides 33 cm of flexibility. Moves in any direction, to any angle. 33-330 £1.49

Padded Desk Stand.



Heavily padded with gunmetal finish. 10 cm chrome tube attaches easily. 33-370 £2.95

„Baby Boom” Floor Stand Attachment.



Universally attachable – gives „studio” results. 79 cm long, chrome plated. 33-343 £4.75

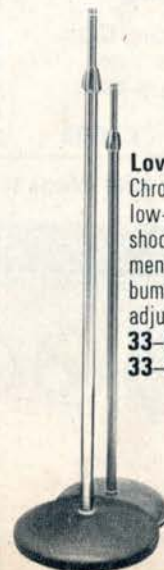

Low-Profile Microphone Stands.

Chromed tubes are sleekly designed with low-profile bases that feature levelling shock absorber pads for quick placement and use anywhere. Anti tip-over bumpers, and quick, sure locking and adjustment system. 86×160 cm.

33-320 Cast base £7.95
33-321 Chrome base £8.95

Realistic Acoustic Suspension Speakers

Install them yourself – and save money!

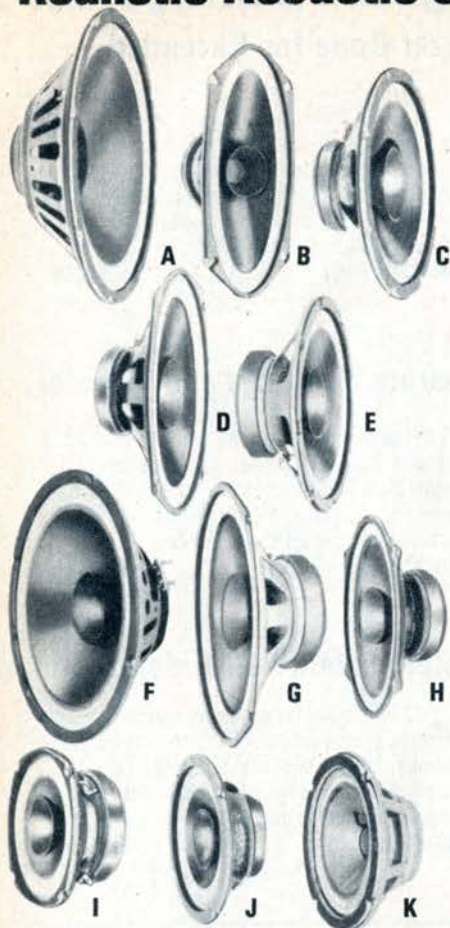

A. 30.5 cm – 32 Watts – 28-18,500 Hz. Builds easily into any stereo system. 283 g ceramic magnet, 30 cm woofer, whizzer cone. 8 ohms impedance.
40-1287 £11.95

B. 4×25.4 cm – 30 Watts – 50-18,000 Hz. Dual-cone cloth roll speaker for replacement use in home or car. 283 g ceramic magnet, whizzer cone, 8 ohms.
40-1297 £8.49

C. 20.3 cm – 30 Watts – 30-20,000 Hz. Excellent speaker for bookshelf enclosures. 283 g magnet, whizzer cone, 8 ohms.
40-1286 £7.95

D. 6×22.8 cm – 15 Watts – 30-20,000 Hz. Perfect for mounting in the rear of your car. Whizzer cone, ceramic magnet. Rugged design. 8 ohms.
40-1260 £8.39

E. 20.3 cm – 33 Watts – 28-20,000 Hz. Heavy 453 g ceramic magnet! Built for strength and durability. Separate high frequency cone. Great response! 8 ohms.
40-1341 £8.95

F. 25.4 cm – 30 Watts – 30-20,000 Hz. Dual cone design. 283 g ceramic magnet, free-air resonant frequency, 45 Hz. For replacement and extension use. 8 ohms.
40-1296 £10.95

G. 6×22.8 cm – 16.5 Watts – 20-20,000 Hz. High-fidelity type cloth roll construction. Separate high-frequency whizzer cone. Heavy 453 g ceramic magnet. Rugged. 8 ohms.
40-1340 £8.95

H. 5×17.8 cm – 32 Watts – 50-17,000 Hz. Oval speaker offering fine sound. 283 g ceramic magnet, whizzer cone – perfect for replacement use. 8 ohms.
40-1288 £6.59

I. 12.7 cm – 18 Watts – 65-17,000 Hz. Ideal for car systems, „second” stereo systems and „mini” installations! 283 g magnet, 8 ohms impedance.
40-1284 £6.49

J. 15.2 cm – 25 Watts – 50-17,000 Hz. Low-cost speaker for extension, replacement or small hi-fi system use. 283 g magnet, whizzer cone, 8 ohms.
40-1285 £7.49

K. 15.2 cm – 50 Watts – 45-15,000 Hz. Maximum efficiency – 11,500 gauss! 25.4 mm voice coil, 40 Hz free air resonance. Huge 900 g magnet. 8 ohms.
40-1342 £10.95

Acoustic Suspension 12.7 cm Speaker

- Perfect for extension speaker use.



Build this fine speaker into your own enclosure for a sound that will amaze your friends! Full 30-15,000 Hz. 8 ohms.
40-1909 £2.95

FE-103 10 cm Speaker

- Large ceramic magnet
- Acoustic suspension



Ceramic magnet develops over 10,000 Gauss. 30-17,000 Hz. 15 Watts, 8 ohms. For 4589 cm³ enclosure.
40-1197 £4.95
40-808 Equalizer Kit £2.25

12.7 cm Acoustic Suspension Die-Cast Speaker

- For TRUE Hi-Fi sound in your car!



30-20,000 Hz – peak performance. 900 g magnet, 25.4 mm voice coil. 8 ohms. Installs easily.
40-1292 £9.49

Realistic Indoor / Outdoor PA and Extension Speakers

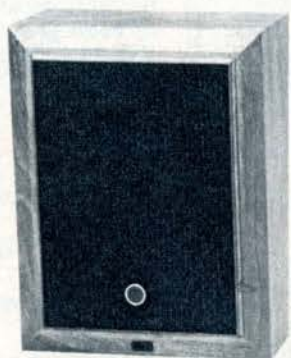

Deluxe Wall Baffle Speaker

- Acoustic suspension design!
- 40-15,000 Hz response!
- Walnut finish enclosure!

Wide range 12.7 cm speaker that looks good anywhere in the home! Frontal volume control, RCA-type and screw terminal inputs. 8 ohms. 343×267×93 mm.
40-220 £15.95



Low-Cost 20.3 cm Speaker & Baffle

Full-range speaker in an attractive walnut baffle. 8 ohms.
40-219 £5.95



70 V Line Transformer

10 Watt primary. Taps at 10, 5, 2.5, 1.25, 0.62 watts. Secondary impedance 4-8 ohms.
32-1031 £2.95

Indoor/Outdoor Speaker

Portable 10 cm speaker with Alnico V magnet. Screw terminals. 8 ohms.
40-1229 £4.95



10 cm Power Horn

- Wide range
- Waterproof

It has a cone in a horn-type enclosure. 5 Watts. 8 ohms.
40-1239 £5.95



Realistic Speakers - Great Value When Building Your Own System!

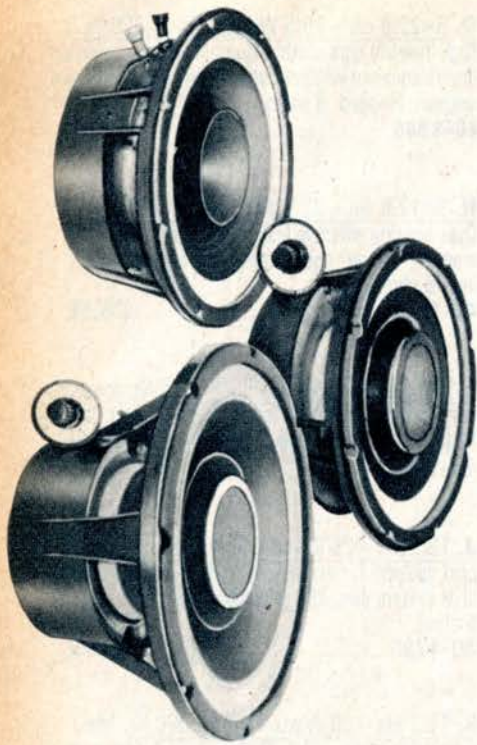

20.32 cm 2-way Speaker has Whizzer Cone for Extended High Frequencies

- 45-18,000 Hz response!
- Ultra-high-compliance cone!
- Easy screw-type binding posts!
- Pressure-cast speaker frame!
- 24 watts power handling!

Speaker frame is cast under high pressure for perfect alignment of moving parts. Whizzer cone offers brilliant high-frequency response. 20.32 cm woofer, 2.54 cm voice coil, cloth-roll suspension. 24 watts, 8 ohms.

40-1301 £10.49

20.32 cm 3-way Speaker with Separate Midrange and Tweeter

- 35-19,000 Hz response!
- High-frequency level control!
- 283 g ceramic magnet!
- Epoxy-bonded for long life!
- 30 watts power handling!

Cloth roll suspension woofer with 2.54 cm voice coil and 7.62 cm high-frequency tweeter. Midrange. Heavy cast frame, easy-to-connect screw terminals. 30 watts, 8 ohms. Buy a pair for a sensational compact stereo system.

40-1302 £14.95

30.48 cm 3-way Hi-Fi Speaker System offers Full-Fidelity Sound

- 25-20,000 Hz response!
- Cone tweeter level control!
- 566 g ceramic magnet!
- Stove enamel finish!
- 45 watts power handling!

Big 30.48 cm woofer and heavy magnet structure for really powerful bass. Axially-mounted midrange radiator. Internal dust seal for extra long life, cloth-rolled cone edges. Cross-over network, screw-type binding posts.

40-1304 £23.95



Deluxe 3-way Crossover Network

- Ideal for use with separate speaker components!

Design your own speaker systems! Can be used with either matching or non-matching efficiency 2-way or 3-way speakers. Crossovers, 500-3300 Hz. Midrange and tweeter level controls. 152x76x63 mm. Instructions included.

40-1339 £6.99



Ultra High-Frequency Tweeter with Crossover

Cyclac moulded horn, cross-over. 30 watts; 2000-25,000 Hz; 8 ohms. For 2 or 3-way systems.

40-1274 £7.95



High-Efficiency Horn Tweeter with Crossover

Improved high-frequency response - 2000-20,000 Hz. Has electronic crossover. 30 watts, 8 ohms. Aluminium. 184x76x160 mm.

40-1228 £5.49



15.24 cm Midrange with Crossover

Use with 25.4 cm woofer on the left to build your own speaker system. Cone type. 700-6000 Hz.

40-1332 £4.75



24.4 cm Woofer

Build or replace your own speaker system with our 25.4 cm woofer (with treated cone edges) and other components. 30-4000 Hz.

40-1331 £10.95



20.32 cm 2-way Special

- Air suspension!
- 45-17,000 Hz!
- 283 g magnet!
- Crossover!

Compact, low-distortion speaker for wide-range sound at a great price! Cloth roll, 2.54 cm voice coil, handles 17 watts. 8 ohms impedance. 8.6 cm deep. Great buy!

40-1330 £7.95



20 cm Woofer and 9 cm Tweeter

- Illustrated instructions for your own Hi-Fi systems!

Compares with units 2 or 3 times dearer when built according to instructions! 20.32 cm woofer has treated cone edges. 9 cm tweeter with closed back. 24 watts, 8 ohms.

40-1306 £7.95



30.48 cm 3-way Special

- 24-18,500 Hz!
- 283 g magnet!
- Handles 28 watts!

Air-suspension woofer has cloth roll and midrange cone, plus coaxially-mounted tweeter with crossover. 2.54 cm voice coil.

40-1320 £15.95

Musical Instrument Speakers and Accessories - Professional Quality

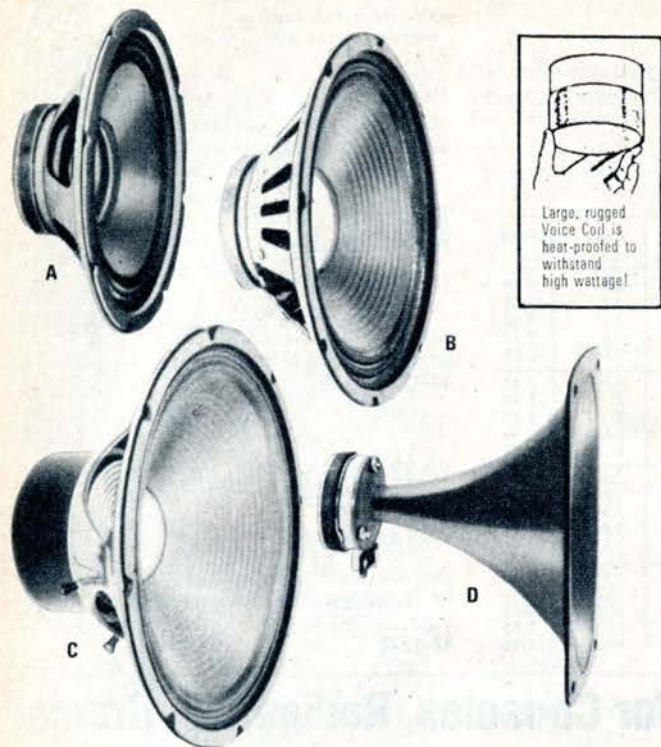

Large, rugged Voice Coil is heat-proofed to withstand high wattage!

Realistic Super-Power Speakers Take The „Heavy“ Music Of Guitar, Organ Or Bass Amp - Without Strain!

- A. 20.3 cm 30-Watt Guitar Amplifier Speaker.** Up-date your guitar amplifier! Potent 283 g magnet with 2.54 cm voice coil – handles up to 30 watts of music power. Heat-proofed. Free air resonance. 72 Hz impedance, 8 ohms.
40-1316 £7.49
- B. 30.5 cm 50-Watt Guitar Amplifier Speaker.** Great performance at a low price! Rugged construction – won't burn out! Reinforced cone edges resist shatter, extend life. Big 567 g magnet with 3.8 cm voice coil for 50-watt capacity. Free air resonance. 50 Hz, 8 Ohms.
40-1275 £13.95
- C. 30.5 cm 85-Watt Guitar Amplifier Speaker.** For the full sound of today's music! Rugged 5 cm voice coil and massive 3 kg magnet structure for great volume level per watt of input. Free air resonance. 55 Hz, 8 ohms. 16.5 cm deep.
40-1314 £20.95
- C. 38 cm 100-Watt Guitar Amplifier Speaker.** Huge speaker gives tremendous reproduction! Massive 1135 g ceramic magnet and 5 cm voice coil with multi-strand flexible leads. Resists fracture and burn-out. Free air resonance. 45 Hz, 8 ohms. 20.3 cm deep.
40-1315 £24.95
- D. 50-Watt Instrument Amplifier Music Horn.** Add exciting overtones to amplified instrument music that can't be reproduced by high power bass speakers. 2000-20,000 Hz. 80 g ceramic magnet, 2.54 cm voice coil. 8 ohms. For use with 8 or 16 ohm speaker. 89×203×216 mm.
40-1317 £6.95

„Baffle-Pak“ Speakers in Three Different Sizes

Use in or out of the Box
Our exclusive heavy-duty ceramic magnet speakers in sturdy wood-grain baffle boxes that double as speaker enclosures. All have 15 cm cables attached. Use 12.7 cm or 15.2 x 22.8 cm for car stereo; 20.3 cm for PA system or extension speaker for TV, radio, etc.



- A. 20.3 cm Speaker.** 18 watts power handling, 85 g magnet.
40-1280 £5.49
- B. 15.2×22.8 cm Speaker.** Handles 18 watts-power, 85 g magnet. Ideal for car stereo use.
40-1282 £5.49
- C. 12.7 cm Speaker.** Far better than ordinary car speakers! Handles 15 watts, 85 g magnet.
40-1281 £4.49

Realistic Ultra Slim Speakers

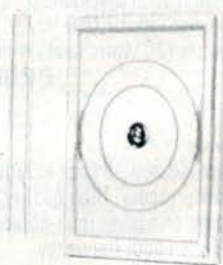

Side View
3.8 cm thin!

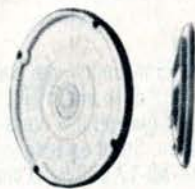

- A. 35.6 cm Ultra-Slim Speaker.** Installs where no others can! Table tops, doors, etc. 40 watts. 30-20,000 Hz. 8 ohms. 36×298×373 mm.
40-1344 £9.95

- B. 20.3 cm Ultra-Slim Speaker.** Disc-shaped, lightweight, bi-directional. 20 watts. 40-20,000 Hz, 8 ohms. 25.4 mm deep – fits any 20 cm grille.
40-1343 £5.95

Decorative Speaker Grille Cloth

- Attractive colour-fast patterns
- Keeps dust and dirt out of speakers
- 10 different designs and tones, 2 sizes.

Beautifully woven grille cloth for use in making your own speakers, repair or replacement. Special „acoustically transparent“ weave allows unrestricted passage of sound waves.

Size 91×91 cm

Cat. N°	Price £	Description
40-1926	£3.95	A. Rustic Brown
40-1927	£3.95	B. Forestry Brown
40-1928	£3.95	C. Coarse Charcoal
40-1929	£3.95	D. Golden Maple
40-1930	£2.89	E. Waffle
40-1931	£2.89	F. Off-white
40-1932	£2.89	G. Walnut
40-1933	£2.89	H. Black
40-1934	£2.89	I. Woven Wood
40-1935	£2.89	J. Cane

Size 46×61 cm

Cat. N°	Price £
40-1942	£1.89
40-1943	£1.89
40-1944	£1.89
40-1945	£1.89
40-1936	£1.39
40-1937	£1.39
40-1938	£1.39
40-1939	£1.39
40-1940	£1.39
40-1941	£1.39

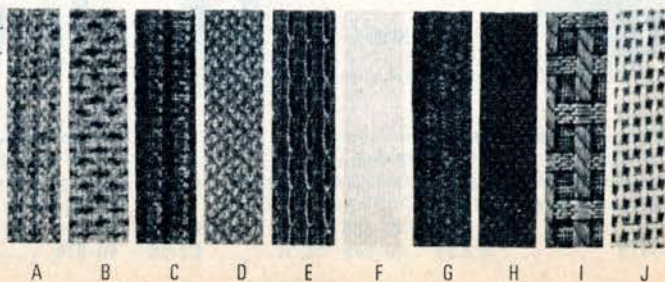

Realistic Speakers for „Better-than-Original” Replacement!

- Ideal for car, home-replacement and extension speaker uses!
- Quality-made in the USA
- Efficient Alnico-V magnet!

All feature rigid-frame construction for proper voice coil and magnet alignment, Alnico-V magnets for wide response sound. The ideal, low-cost way to revamp your system; for extension speakers too! The best selection on the market!

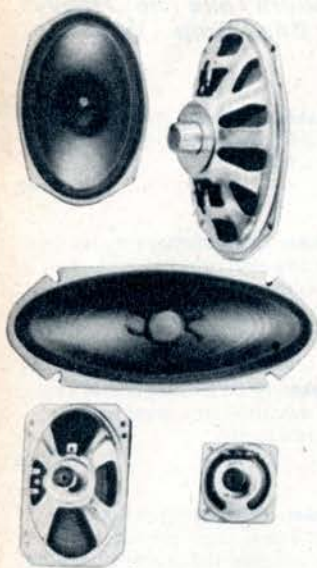

Cat N°	Size cm	Magnet g	Watts	Ohms	Price £
40-1201	7.62	19	3	3.4	2.09
40-1202	8.89	19	3	3.4	2.09
40-1203	10.16	16	3	3.4	2.09
40-1204	10.16	28	4.5	3.4	2.19
40-1205	12.70	16	4	3.4	2.19
40-1206	12.70	28	5	3.4	2.49
40-1240	12.70	67	5	8	2.99
40-1241	13.33	67	8	8	3.69
40-1207	15.24	19	5	3.4	2.99
40-1242	15.24	67	6.5	8	3.69
40-1209	12.70×7.62	16	4	3.4	2.19
40-1210	10.16×15.24	19	4	3.4	2.49
40-1211	12.70×17.78	19	4	3.4	3.29
40-1212	15.24×22.86	19	4	3.4	3.49
40-1213	20.32	42	8	3.4	3.69
40-1905	15.24	42	6	10/20/40	3.39
40-1214	10.16×25.40	61	8	10/20/40	4.49
40-1243	10.16×25.40	156	9	10/20/40	5.59
40-1215	12.70×17.78	42	7	10/20/40	3.99
40-1216	15.24×22.86	42	8	10/20/40	4.19

8-ohm Direct Replacements 75P

- For transistor radios, walkie-talkies, etc.

Alnico PM „thin” speakers.
 40-262 6.98 cm 40-246 5.70 cm
 40-247 6.35 cm 40-245 5.08 cm

20.32 cm Round Speaker

- With whizzer cone!

Ideal for replacing old or adding new speakers anywhere! 42 g magnet.

40-1271 £2.49

20.32 cm Speaker Special

- 170 g magnet!

Good bass response, excellent highs. For TV, radiogram, replacement uses. 8 ohms.

40-1272 £4.49

Quality Hi-Fi Speaker Replacements for Consoles, Radios, TV, Grams!



30.48 cm 3-Way Coaxial

Features horn-shaped tweeter coaxially mounted with pre-wired capacitive crossover for outstanding voice and music reproduction. Midrange is coaxially mounted to woofer with mechanical crossover. Big 283 g magnet. 35-17,000 Hz response. 8 ohms. 16 watts (30 watts peak).

40-1230 £9.95



30.48 cm Full-Range Design

Highly efficient! Handles 30 watts power, has ceramic magnet structure. Exclusive internal dust seal protects precision voice-coil from „stray whiskers” that may work loose from the magnet. Smooth 50-11,000 Hz response. 8 ohms.

40-1200 £6.39



8.9 cm Square Tweeter

Specially designed basket has sealed back to protect cone against woofer back pressure. High quality features include electronic crossover (non-polarized capacitor at 4,500 Hz) for smooth frequency distribution. 2000-16,000 Hz. 10 watts power, 8 ohms impedance. Rugged construction.

40-1224 £2.75



20.32 cm Dual-Cone Design

Full-range speaker with lustrous stove enamel finish, 8 watts capacity and smooth 40-12,500 Hz response. Whizzer cone tweeter gives crisp highs, 20.32 cm round woofer for deep bass. Has 283 g ceramic magnet. 8 ohms. Great bargain price!

40-1232 £5.49



20.32 cm Round Coaxial

Only 70 mm deep – perfect for mounting into wall or ceiling. 7.62 cm tweeter for crisp music and voice reproduction. Pre-wired tweeter and crossover for simplified installation. Stove enamel finish. 85 g ceramic magnet. 50-17,000 Hz. 8 ohms. Get one today!

40-1226 £6.99



15.24×22.86 cm Coaxial

Perfect choice for BIG speaker sound! Has separate coaxially-mounted 7.62 cm tweeter for excellent high frequency dispersion. Ceramic magnet structure gives sharp, clear overall reproduction. Rugged construction. Smooth 50-15,000 Hz response. 8 ohms. 8 watts (18 watts peak).

40-1231 £7.49



20.32 cm Speaker Baffle

– Aluminium
 For mounting speaker in wall, ceiling. Easy to install. Less speaker.

40-1223 £2.29



Mono



Stereo

8-ohm L-Pads

Controls speaker volume. 3 watts. 19.05 mm shaft.

40-980 Mono £1.59

40-979 Stereo £2.59



Stereo Wall-Jack

– Wire your house for sound!
 Hook up stereo speakers anywhere! Ivory plastic. With 2 plugs and hardware.

40-976 £1.25

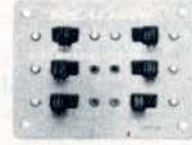

6-way Speaker Selector

Installs easily!
 Allows selection of up to 6 pairs of remote speakers. 8.7×20.3×6.3 cm.

40-124 £1.99



Wall Mounted

Speaker Selectors

8-16 ohms
 Non-shorting. For 1 or 2 pairs of speakers.

40-130 Enclosed £2.39

40-131 Wall mount £1.95



Enclosed

Realistic Car Speakers and Accessories for Quality plus Value!

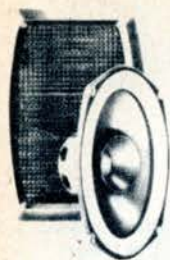

15.2x22.8 cm Rear Deck Kit with Grille

A concert hall in your car! 30-20,000 Hz response. Big 283 g ceramic magnet. 15 watts, 8 ohms.
40-1335 £ 9.95

Deluxe 15.2x22.8 cm Wide-Range Universal Speaker

● 156 g ceramic magnet!

Delivers great frequency response! Wide range for car reverb or rear deck set-up. Powerful 12-watt capacity. Screw terminals. 8, 10, 20 or 40 ohms.
40-1268 £ 6.99

8.9 cm Speaker With Pre-Mounted Dust Cover

● Ideal for in-dash installations!

Small enough to fit in tight places. Can be installed in most car dashboards. 4 watts, 8 ohms. Two mounting ears.
40-1333 £ 3.79

10.1x15.2 cm Replacement Speaker

● Great for TV, Console, Car!

Heavy-duty - offers excellent bass response. 156 g ceramic magnet. 8 ohms. Up-grade your car radio or tape-player with this low-cost speaker!
40-1298 £ 3.99

Speaker Controls

A. Speaker Control. Selects sound from front, rear, both. 60x48 mm.
40-540 75P

B. Fader Control. Controls front, rear, both speakers.
40-550 69P

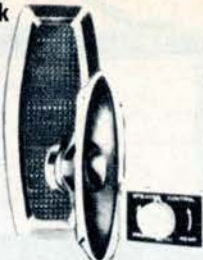

10.2x25.4 cm Rear Deck Kit with Die-Cast Aluminium Grille

● Treble control!

Matches all car radio outputs. Treble cone boosts high frequencies! 156 g ceramic magnet. 10 watts, 10, 20 or 40 ohms.
40-1336 £ 7.49

Universal 12.7x17.8 cm Speaker

● Whizzer cone for high frequencies!

Great for use with compact cars! 85 g ceramic magnet, 10 watts power capacity, whizzer tweeter cone. Multi-impedance (9, 10, 20, 40 ohms).
40-1261 £ 4.99

15.2x22.8 cm Oval Speaker for Auto or Home

● Offers fine sound in any set-up!

Great low-cost speaker for replacement use in auto sound systems or as home extension speaker. 28.3 g magnet, 3.4 ohms.
40-1269 £ 2.19

15.2x22.8 cm Rear Deck Grille

● Non-glare charcoal finish!

Adds a neat look to any rear-deck speaker installation! Heavy aluminium, no exposed screws. Complete, ready to mount. 16.8x24.1x0.9 cm.
40-1337 £ 2.19

12.7 cm Moulded Grille

● Mount your own car speakers!

Easy to install on door panels or rear deck. Complete with all mounting hardware, templates and instructions.
40-1290 79P

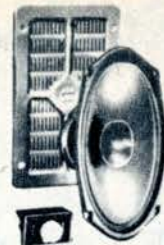

Universal 15.2x22.8 cm Rear Deck Speaker Kit

● For all car radios & players!

Great sounding speaker! Handles full 10 watts. 156 g magnet. Chrome-plated grille, wiring harness & hardware included. 8-10, 20 or 40 ohms.
40-1222 £ 7.39

Low-Priced Auto Speaker Kits

● Ideal for replacement or new speaker add-on!

Easy to install. Each 3.4 ohm speaker comes complete with fader control and good-looking metal grille.
40-299 15.2x22.8 cm £ 4.59
40-300 12.7x22.8 cm £ 3.99

15.2x22.8 cm Auto Replacement or Home Extension Speaker

● Good bass response!

Powerful, high-efficiency 170 g ceramic magnet. 8 ohms. Sure to sound great in any mono or stereo system.
40-1273 £ 3.99

10.1x25.4 cm Die-Cast Aluminium Rear Deck Grille

Good-looking, easy to install. No exposed screws so it looks factory-installed! Attractive charcoal finish. 13x28x0.9 cm
40-1338 £ 1.99

Low-Cost Chrome Grille

● With all mounting hardware!

Heavy-duty satin-chromed steel grille 15.2x22.8 cm. Complete with hardware, templates and instructions for fast installation.
40-1174 £ 1.09

Stolle Antennas for any Car or Lorry

NEW



Electronic-1: A new electronic all-band antenna which gives a huge improvement in performance, especially on SW and FM stations. Two sections, telescoping to 40 cm, give a neat appearance on any car. Easily mounted. 12V negative ground.
12-9050 £ 15.95

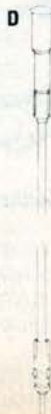

A AS-1001: A one-section antenna with spring. Suitable for all cars - interior depth is only 5 cm. With 1.25 m cable.
12-9051 £ 3.29

B AWW-1002: Special for Volkswagens. 5-section, 1 m telescopic and fully-disappearing antenna with interior depth of 30 cm. With 1.25 m cable.
12-9052 £ 3.19

C AU-1003: A 5-section universal antenna which telescopes to 1 m and disappears completely when closed. Interior depth: 28 cm. With 1.25 m cable.
12-9053 £ 2.99

D Extension Cable: 1.5 m extension cable for all car antennas.
12-9054 59P

Auto-Testers and Electrical Accessories



Automatic Dwell Tachometer
Instant, direct readings of RPM and Dwell angle from two 114 mm meters; ignition automatic starter switch lets you start engine from outside vehicle. Reads 0-3000 rpm,

0-45° (8-cyl); 0-4000 rpm, 0-60° (6-cyl); 0-6000 rpm, 0-90° (4-cyl). For 6, 12, 24V systems. Colour-coded & insulated heavy duty clips. Metal case and carry handle.
22-014 £23.95



● 152 mm meter!
● For 6 & 12 V systems!

Auto Tune-Up Analyzer
Does every electrically based tune-up and testing function for 4-6-8 cylinder engines. Reads high rpm (0-6000), low rpm (0-1200); 0-16V

DC, 0-80 amps, and cam dwell (0-45° & 0-60°). Rotary function selector, colour-coded test leads. Strong metal case and carrying handle.
22-013 £27.95

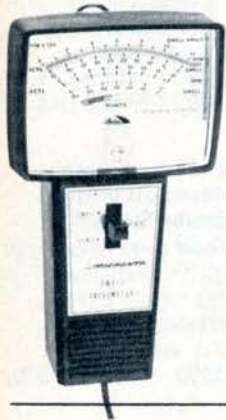

Dwell-Tach-Points Tester

For all 4-6-8 cylinder cars, 6 & 12V systems. 5 scales: 8-cylinder for 0-1200 rpm & 0-45° dwell; 6-cylinder for 0-1600 rpm & 0-60° dwell; and points scale. No internal batteries or calibration needed. High impact case fits hand. Long coded leads with insulated alligator clips.
22-1631 £9.95



DC Power Timing Light

● 6 & 12V DC operation!
● Pistol-grip trigger action!

Professional-quality timing light for auto tune-ups. Xenon flashtube gives blue-white light visible day or night. Checks ignition timing, spark advance, distributor cam wear. Leads have colour-coded insulated clips and string spark adapter.
22-015 £12.95

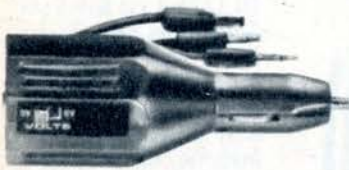

DC Auto Adapter

● Reduces 12 V to 9 or 6V!
● Plugs into any car lighter socket!

Power transistor radios, tape recorders, from your vehicle. 3 output plugs (mini, sub-mini and power jack) fit most units. Switch for 6 or 9V output; polarity reversing switch. 300 mA. 150 cm cord.
270-1532 £3.95



Car Stereo Noise Eliminator Kit

Designed to eliminate noises or interference from ignition or alternator. Kit includes choke and capacitor, with instructions.
270-020 £1.59

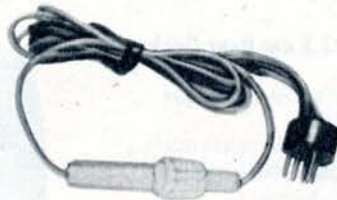

Universal Car Stereo Power Connector

Designed to fit most car stereo tape players. Colour-coded speaker and power leads, in-line fuse holder. 4 and 5 pin connections.
270-017 £1.29

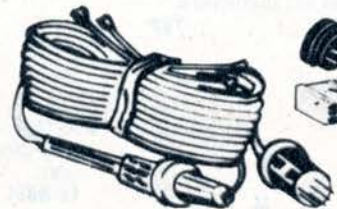

Car Stereo Connector Cords

Wiring harness designed to fit most car stereo tape players or use for connecting unit at home. Colour-coded speaker leads, in-line fuse holder with fuse. 5 m cord.
270-014 5-pin plug £2.69
270-015 6-pin plug £2.29



Auto-Tape Player Mounts

● For 2 or 4-channel players!

Heavy gauge metal with nylon runners. Slide player out and take it with you when you leave; mount and wiring stay attached. Colour-coded leads for 2 or 4 channel systems. Includes contacts and all hardware.
270-016 Under-dash mount £4.49
Male bracket for 270-016 :
270-019 £2.49
270-018 Floor mount £4.69



Auto Lighter Plug

Lets you power DC accessories directly from the car lighter socket.
274-331 65P



Auto-Radio Suppressors

Stops electrical interference in car radios.
A. 270-012 Straight-type ... 49P
B. 90° type for close mounts
270-013 69P



6 to 12V DC Voltage Interter

● Converts 6V DC input to 12V DC output!

Use 12V equipment in your 6V vehicle! Features dual inputs - 6V neg. ground & 12V pos. ground. Output rating: 12V neg. ground at 3 amps. Fuse protected. With instructions.
22-129 £12.95

Realistic Car Radios at Exceptional Prices!

Realistic Car Radios include everything for proper installation - mounting brackets, hardware, power & speaker cables, instructions!



Under-Dash FM Stereo Radio

- 3-ganged tuner RF and 4 ICs for better sound, smaller size!
- Ceramic filter!
- Built-in AFC!

Full-size stereo from a compact radio! (Only 133x50x175 mm). Thumbwheel volume/on-off, balance, tone and tuning controls; stereo-mono pushbutton, stereo beacon. For use with 4 or 8 ohm speakers. 12V. negative ground.

12-1370 £46.95

See page 34 for a full selection of auto stereo speakers.

Compact AM Radio for In or Under the Dashboard



- High gain — 7 tuned circuits & 3-gang tuner!

Features an IC and transformerless audio output for top performance! Built-in 101 mm speaker, high/low tone switch, power „on“ beacon, volume-On/Off and tuning controls. 159x50x127 mm. 12 V positive or negative ground.

12-1343 £15.95

Low-Priced Universal FM/AM Radio



Fits in or under the dash — With built-in speaker!

- Compact — even fits VW dashboards!
- Easy-grip rubber covered knobs!
- Dial light!
- Pilot light!

Enjoy FM and AM for what you'd expect to pay for AM alone! Push-buttons for FM, AM and High or Low Tone. Illuminated slide-rule dial has „power-on“ pilot light. Full-sounding built-in speaker. For 12V positive or negative ground. 162x184x48 mm.

12-1369 £27.95

Under-Dash FM Auto Radio Converter



- Add FM to your AM car radio!

Two ICs, two ceramic filters, 3-gang tuner — 12 tuned circuits in all! Built-in AFC, AGC, AM/FM selector/Power-On switch, rotary tuning control, solid-state. 178x89x45 mm. 12 V positive or negative ground.

12-1332 £19.95

FM/AM Auto Portable - Plays in or out of your car!



- For 6 or 12 V systems!
- For positive or negative ground!
- Handy carrying handle doubles as stand!

Enjoy great-sounding AM and FM inside or outside your car! Has push-buttons for FM, FM with AFC, AM and Tone. 89 mm speaker, external speaker jack. Dial lights when used in car. Includes special under-dash mounting case/bracket with lock and key, 4 „C“ batteries for portable use. Has AM and telescoping FM antennas. 229x156x70 mm.

12-677 £36.95

High-Performance Car Speaker Systems

Surface-Mount Speaker Systems

Hang on doors, dashboard or deck without cutting!

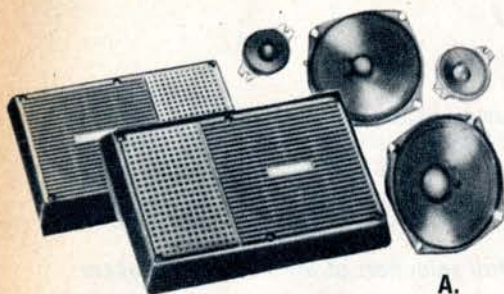

A.

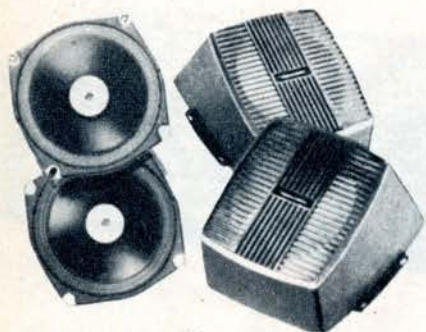

B.



C.

A. Deluxe 2-way speaker systems give deep, powerful stereo that sounds like your home hifi! Separate 127 mm woofer and 50 mm sealed-back, high-compliance tweeter give maximum power handling capability. Massive 227 g magnet, cloth-roll construction. Measures only 24x16,5x10 cm.

12-1847 Pair: £20.95

B. Deluxe 133 mm Surface-Mounts with dual cones. Wide response for impressive car stereo! Big 120 g magnets, whizzer cones, cloth roll construction. Moulded housings mount anywhere - effortlessly! All hardware included.

12-1844 Pair: £7.95

C. Low-cost Surface-Mount speakers. Heavy-duty 127 mm speakers in attractive moulded enclosures. Mount without cutting or fitting - under the dash, on doors, etc. Transfer easily to your next car.

12-1842 Pair: £4.95

D. Our finest Flush-Mount Speaker System Kit. Deluxe 127 mm speakers each have massive 900 g magnet structure, 25,4 mm voice coil, acoustic-suspension construction for deep bass response, snap-mount padded rubber grilles, durable die-cast frames. Flush mount easily with no screws visible!

12-1846 Pair: £19.95

E. 133 mm Flush-Mounts with 227 g Magnets. High performance for car stereo! Powerful magnets, whizzer cones, cloth-roll construction & padded vinyl grilles. Easy to install, with mounting rings, all hardware.

12-1845 Pair: £11.95

F. 133 mm Flush-Mounts with dual cones. High-compliance speakers have 120 g magnet, cloth-roll construction and whizzer cones. Deluxe chromed grilles add a neat appearance to any car. Install easily.

12-1843 Pair: £7.95

G. Low-cost Flush-Mounts which install easily. Give your car that „custom“ look - and great stereo sound! Includes 127 mm heavy-duty speakers, chromed grilles and instant-mount retainer rings so that you can mount the speakers without removing the panels.

12-1841 Pair: £4.95

Flush-Mount Speaker Systems

Flush mount in doors, panels and rear decks!

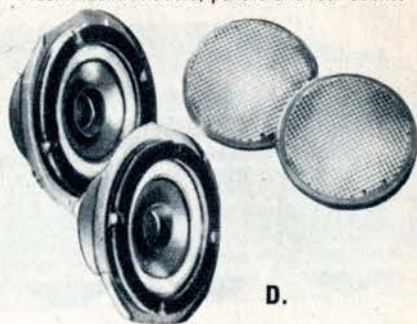

D.

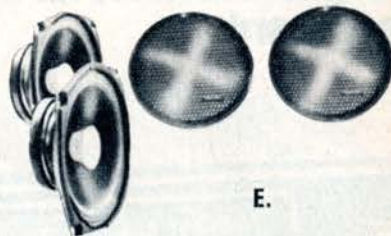

E.

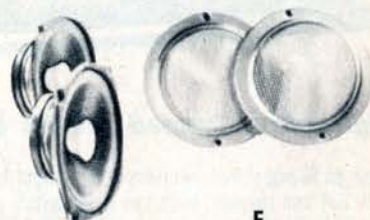

F.

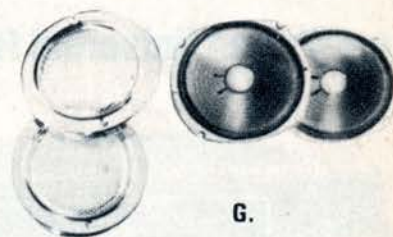

G.

Realistic Quatravox 4-Channel Auto Adapter



- **Get Quadraphonic effect from any stereo!**
- **Only 136x64x44 mm. With 5,5 m speaker cables!**

Double your driving fun! Add the Quatravox and 2 more speakers to your present stereo system for 4-channel enhancement of all stereo sources. Offers total listening flexibility - independent volume control of front and rear speakers for both stereo and 4-channel! Listen to the front only, rear only, or balance all 4 speakers to your own preference. Simple installation instructions included.

12-1874 £4.85

NOTE: All Realistic car speaker systems and tape players include all mounting hardware and cable!

Make Driving Fun! Buy a Realistic Stereo 8-Track Tape Player!



All Realistic players come complete with mounting hardware plus power and speaker cables for 12V DC negative ground. Speakers not included.

„Mini“ Player fits where others won't!

- 8-Watt audio output power!
- Slide-type balance control, rotary tone controls!

Integrated circuitry lets us build in the power and audio quality of larger models. Full 8-watt stereo amplifier, lighted programme indicators, manual pushbutton or automatic programme selection. All at the right price!

12-1821 £ 32.95



Deluxe Player with Lock & Key

- Bracket lock & key discourages theft!
- Speedy pushbutton fast-forward and play!
- Pushbutton eject!
- Headphone jack!

Powerful 12-watt amplifier, top-mounted slide volume, balance and tone controls, illuminated programme indicators; fast-forward button advances tape to next programme automatically; eject button stops player and ejects cartridge. Headphone jack lets passenger listen „privately“. 170×190×60 mm.

12-1831 £ 49.95



8-Track Player with Quatravox 4-Channel Synthesizer

- Enhances ordinary stereo tapes with 4-channel effect!
- Plays regular stereo, too!
- 12 Watts power!
- Headphone jack!

A new dimension in auto entertainment. Quatravox is built right in – there's nothing else to buy. Thumbwheel volume, balance and tone controls, programme selector, indicators, speaker switch. Switch for regular 2-channel operation. 159×152×67 mm.

12-2024 £ 36.95



Stereo 8-Track Player/Stereo FM Radio

This 2-in-1 stereo entertainer is our smallest 8-track player/stereo radio yet! Fits where others won't, and with a full complement of conveniently-arranged controls. Sliding controls for volume, balance and tone; push-buttons for radio-on, stereo-mono, tape programme select and tape programme repeat. Radio has lighted slide-rule dial and FM-Stereo beacon. Only 180×136×75 mm. A real bargain!

12-1820 £ 54.95



Low-Priced Compact Player

Performs with many of the big ones! 8-watt amplifier, thumbwheel volume, balance and tone controls, lighted channel indicators, manual track change button. 133×175×57 mm.

12-1819 £ 26.95

Fantastic Electronic Calculator for Home or Business

£ 39.95

- **Performs the 4 basic mathematical functions PLUS mixed & chain calculations!**
- **Multiplies or divides long series of numbers without re-entering the constant!**
- **Does square root and exponential calculations!**
- **Hooded display for crisp readouts!**

Features 8-digit entry and display with floating or fixed decimal; Clear Entry Key erases incorrect figures without clearing previous entries; Automatic Cutoff dissolves display after 30 seconds to extend battery life – simply touch the „D” button and the display instantly reappears! Use the EC-200 anywhere – at home, office, in planes, on trains... it works with either batteries, rechargeable batteries, or on AC current. What's more, the AC charger/adaptor is included in the price – as is the handy carry-case. One year's guarantee. Weighs only 225 g and measures 145×83×32 mm.



EC-200. Your personal „pocket professor” gives instant answers to most of your mathematical problems! Adds, subtracts, divides, multiplies – even performs difficult chain and mixed calculations, quickly and efficiently!

63-602 £ 39.95
 23-9155 „AA” battery (4 required)
 4 for 40 P
 23-125 „AA” rechargeable battery
 (4 required) 2 for £ 1.99

4-Digit Reset Counter



Handy little gadget with hundreds of uses! Great for keeping a tally on your spending in the supermarket! Counts 0 to 9999.
 63-835 £ 1.95

Micronta 2.5-Power Flip-up Magnifier



Resistant, adjustable and lightweight! For delicate PC or jewellery work. Flip up or down – they stay put and leave your hands free. With glare guard. 130×41 mm.
 63-845 £ 2.89

Pushbutton Calculator



Adds up pounds and pence to £ 20
 61-433 49 P

Add/Subtract Calculator

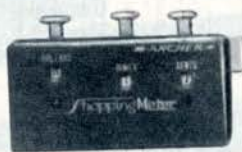

Adds, subtracts. Easy pushbuttons, plastic case.
 61-432 75 P

Security Door Scope

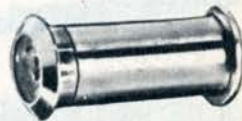

Quickly installs in 12.7 mm hole. Personal protection at low cost! You can look through the door, but no one can look in. Wide-angle view. For doors 25 to 45 mm thick.
 270-139 £ 1.29

Travel Adapters

Convert 220/240 V to 120 V AC, 50/60 Hz

Converter Adapter



- **Fits most European power points!**
- **Ideal for electric heating and steam appliances!**

Just visiting? Perfect for visitors from America, South America, Canada, Spain or any country with 120 V current who want to use their appliances whilst here. Perfect for irons, toasters, percolators, frying pans, electric blankets, hair dryers and tongues. Converts 120 V to 220/240 V. Rated 1000 watts. Compact, weighs only 85 g. Built-in thermostat automatically prevents overheating and overloading. Size 89×38×38 mm.
 273-1402 ... £ 6.95

Step-down Transformer



- **Great for using 120V AC electric appliances in Europe**
- **Weighs only 270 g**

For completely safe operation of 120 V AC electric razors, radios, tape players, calculators, flashguns etc., from 220/240 V AC. Also great for cadmium and dry-cell rechargers and recharging battery packs. Rated at 40 watts. Rugged construction, lightweight. Thermally protected. 41×67×32 mm.
 273-1401 ... £ 6.95



British adapter included

Combination Telescope/Microscope



- **8 x Telescope!**
- **30 x Microscope!**

2-in-1 optical instrument. It's a telescope with adjustable focus barrel, or you can use it as a microscope. Handy pocket clip.
 63-844 £ 1.49

„Electronic Insurance“ Security Devices

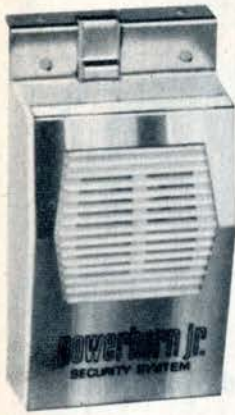

Battery Operated Alarm

Attaches to doors or windows and goes off if someone opens them. Installs permanently or temporarily with screws or adhesive backing. Requires 2 „AA“ batteries.

275-494 £1.09
23-468 „AA“ batteries
Each..... 6P



Door Chain Burglar Alarm

Alarm mounts on door and chain bracket on door post. Makes a loud blast if someone tries to break in! Installs in minutes with a screwdriver. Uses 2 „AA“ batteries.

275-499 £1.99
23-468 „AA“ battery
Each..... 6P



Electronic Whooper

- Produces „whooping“ sound that can be heard streets away!
- Ideal for home, boat or car!

A solid-state system that makes a repetitive „whoop-whoop“ sound similar to that used by many police cars. Waterproof/Weatherproof for indoor or outdoor use. Attaches to a swivel steel mounting base for quick installation. Uses less than 750 mA, 6 or 12V DC power. Spun-aluminium construction, complete with mounting hardware and screws. 152×133×133 mm.

275-488 £15.95

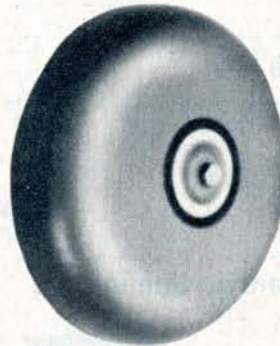

20 cm Alarm Bell

- Operates on 6/12 V DC.

Great as a burglar or fire alarm in houses, schools, boats or cars. Produces a loud, shrill noise that can be heard for blocks! Weatherproof, with mounting bracket for wall or bell-box.

275-498 £7.95

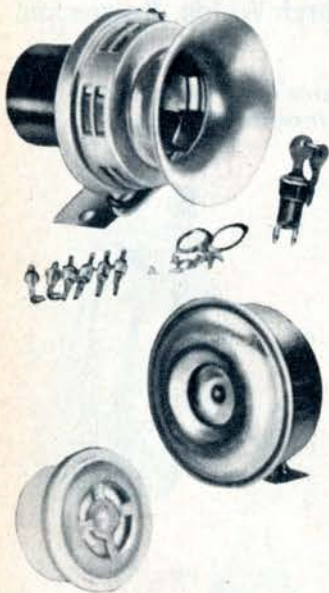

Auto Siren Alarm Kit

- 24-hour protection for any vehicle!

Protect your vehicle from thieves! Loud siren sounds if boot, bonnet or doors are tampered with. Six switches, two keys, lock, wire and all hardware included. Easy to install. For 12V DC negative ground only.

275-492 £14.95

Compact DC Buzzers

Connect to almost any alarm system. Gives off loud warning. Battery operated.

273-004 1.5-3 V Model 74P
273-049 6 V Model 99P
273-051 12 V Model ... £1.39



Window Foil

Ideal for most alarm systems: shop, home or business. Silver adhesive strip 45 m × 9.5 mm. Easy to apply!

275-502 £2.09

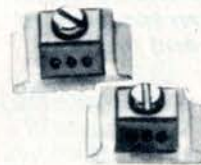

Foil Block Connectors

Set of 6 self-sticking foil blocks allows foil to be connected to wire circuit. Single screw connection – no soldering.

275-504 £1.89

TANDY Flashlights – Don't be without one!



A. 5-Battery Flashlight. Highly dependable! Strong 450 m light beam. Uses 5 „D“ batteries.
68-1001 70P



B. Heavy-Duty Light. Durable construction, non-breakable plastic. Uses 2 „D“ batteries.
61-2637 65P



C. Lantern. Powerful, heavy-duty, high-impact plastic. Uses 4 „D“ batteries. A „must“ in the car!
61-2634 £1.19



D. Disposable Light. Built-in battery. Use if for months, then throw it away. Quick, convenient.
61-2638 89P

Weller Instant Heat Gun 8200D



A built-in spotlight illuminates work. Easy-to-hold pistol-grip handle with fingertip trigger action. High efficiency copper soldering tip. Tip wrench included. 100/140 W, 240V AC, 50 Hz. Dual Heat.

64-9010 £5.95
64-9011 Packet of 2 7135-tips for above 24P

Archer Pencil Type Soldering Iron



Lightweight, easy to handle. Heats instantly. 220V AC.

64-9021 £2.29
64-9022 Extra tip for above 56P

4-Piece Archer Solder Kit



• **Makes jobs fast & easy!**

Heat sink, pointed probe, brush/scrapper and slotted probe.

64-2227 £1.35

Clean Tip Sponge Kit



• **Doubles tip life!**

Cleans tips the easy way!

64-2087 99P

Tape Solder



Pre-cut solder melts under heat of a match!

• **Solder with a match!**
• **Tape wraps around leads and melts!**

Wrap solder tape around twisted wires. Heat with a match or candle for a perfect connection. Plastic pouch.

64-0010 Packet of 100... 55P

Rosin Core Electronic Solder



• **Radio engineer recommended!**
• **60% tin, 40% lead!**

Low viscosity for easy handling and quick melting. Choose the size and gauge to fit your needs.

Cat. N°	Quantity	Gauge	Use	Price
64-0001	2.10 m Handy Pack	16	Standard	37P
64-0002	5.50 m Bench Spool	16	Standard	55P
64-0003	450 g Spool	16	Standard	£2.59
64-0004	15.20 m Spool	16	Standard	£1.09
64-0005	15.20 m Spool	18	Light Duty	£1.09
64-0006	15.20 m Spool	20	PC Work	£1.09

Weller „Marksman“ Soldering Irons

With unbreakable heat-resistant handles, steel barrels and special steel heating elements with Mica insulation bedded in ceramic.

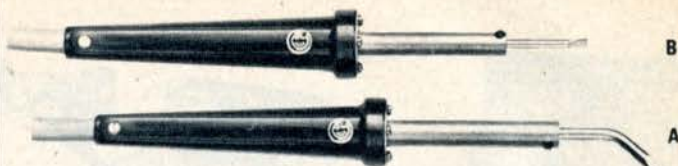

A.

Model SP40D. 40 Watts, 220 Volts.
64-9014 £2.49
64-9015 Tip for above 33P

B.

Model SP25D - 25 Watts, 220 Volts.
64-9012 £2.19
64-9013 Tip for above 26P

Pocket-Size Mini-Torch and Soldering Kit

• **2 Butane charges!**
• **Develops 2000 °C flame!**

Ideal for delicate, intricate work. Each butane charge holds half an hour's fuel. Cartridge screws into torch handle, turns on & off instantly. Braze small parts, repair toys, etc.

64-2155 £3.29
64-2156 Set of 4 extra charges 99P

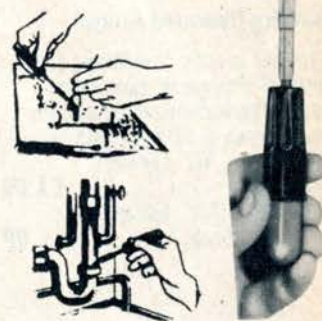

Hand-Held Microflame Torch Welds, Brazes and Cuts most Metals

• **Up to 30 minutes use from each cylinder!**
• **Develops over 2750 °C pinpoint flame!**

Hand-held „welding shop“ which comes with 2 extra-safe „Micronox“ cylinders and 1 butane cylinder. Easy and quick installation with thumb-screws to hold them securely in place. Gaskets prevent leakage. Includes 3 tips, torch tube, gaskets, 2 oxygen & 1 butane cylinder. 133x50x32 mm.

64-2165 £12.95
64-2166 Extra butane cylinders, 2-pack 59P

64-2167 Extra Micronox cylinders, 2-pack 99P



Desoldering Vacu-Bulb

• **Teflon tips!**
• **Safe & fast!**

Quickly and easily takes up solder.
64-2086 99P



Vinyl Electrical Tape

Strong 10,000V dielectric tape. 0.18 mm thickness good for temperatures up to 80°C. Made in USA.

Cat. N°	Size	Price
64-2348	12.7 mm x 3.8 m	19P
64-2349	19 mm x 6 m	39P
64-2350	19 mm x 20 m	69P



Budget-priced Archer Tools



Colour TV Alignment Tool Kit
 • *Non-metallic, safe to use!*
 • *5 most-needed tools!*
 8 hex ends fit most iron core transformers. 2 screwdrivers tips, extender. In pocket pouch.
64-2220 £1.69



Television Alignment Tool Kit
 • *Adjust your own set!*

Why pay bills for repairs when you can do it yourself? Fits 90% of all RF & IF transformers. Each tool has 2 working ends: The 13 cm long K-Tran has 1 hex-end and 1 undercut end to reach bottom-mounted cores. The other tool, 15 cm long, has 3.9 mm Delrin tip and 3.2 mm metal tip.
64-2223 79 P

„Sure Grip“ Masking Tape



Jumbo-Size: non-slip, non-marking. 50 mm wide, 55 m long.
64-190 £1.49
 Standard Size: Non-marking, non-slip, 19 mm wide, 55 m long.
64-188 59 P

Ceramic Magnets



28.6 mm Round
64-1885
 25.4 mm Rectangular
64-1875



Nutdriver Set

• *7 pieces!*
 Six hex sockets in 5/6/7.5/9/10/11 mm. Plastic handle.
64-1977 79 P

3-Piece Alignment Stick Kit

• *Fits most popular sizes!*
 Non-metallic to eliminate shorts. Reaches hard-to-get-at places. Fits standard coils in amp, tuner, recorder, TV. 2 sticks in fibre-glass respectively 30 cm long x 3.2 mm dia. and 30 cm x 4 mm dia., plus 18 cm Delrin stick with 3.8 mm dia. All with screwdriver tips. Tips can be reground for other uses.
64-2222 99 P



Science Fair Electronic Tool Kit

• *9-piece set!*
 • *Popular tools!*
 30-watt pencil-iron, solder, solder aid, 2 pliers, 3 screwdrivers (1 cross-point, 1 with built-in wire stripper) and heat sink.
64-9801 £4.95

Etching Pen

• *For glass, metal, tiles, plastic!*
 Pencil-shaped etching tool tipped with tungsten carbide. Pocket clip.
64-1980 69 P



File Set for Fine Work

Most popular file sizes. Rapid cutting. Pouch.
64-1838 75 P



Hex Key Tool

Handy folding hex key for 1.5/2/2.5/3/4/5 mm. Pocket size.
64-1839 59 P



Super Epoxy Glue

• *Quick drying!*
 Bond strength over 3000 psi. Easy to mix and apply.
64-2426 79 P

Burnishing Tool

• *With case!*
 Excellent for cleaning metal contacts in relays, switches, tuners.
64-2425 25 P



Wire Bending Jig

Dozens of practical uses. Bends eyes, spirals, curves, etc.
64-1960 69 P



7-in-1 Hole Saw

7 circular blades of 25, 30, 36, 42, 49, 55, 61 mm. 6.3 mm shank, slug ejector.
64-1974 85 P



100 Solderless Lugs

• *5 assorted types!*
 20 each of ring, fork and hook-tongue. Assorted sizes.
64-406 69 P

Your Choice!	10 for	25 for	100 for	Each
	75p	£ 1.75	£ 6.50	8p



Handy All-Purpose Lube Oil

• *Silicone formula!*
 • *Resists heat, moisture!*
 Stops rust, loosens frozen parts, protects.
64-2318 65 P



TV/Radio Service Cement

• *Fast setting!*
 Cement parts to chassis, repair plastic cabinets. Fast and clear drying, makes firm bond.
64-2309 49 P



All-Purpose Glue

• *Fast drying!*
 • *Strong!*
 Use for joining plastic, wood, rubber, glass. 56 g. Instructions for making invisible bonds.
64-2311 45 P



Colour TV Tuner Cleaner

• *Improves colour, cuts resistance!*
 Safe for any colour set. Just remove tuner knob and spray in!
64-2320 99 P



TV Cleaner and Lubricant

• *Keep your TV in good shape!*
 For all types of tuners, controls. Leaves no damaging deposits.
64-2315 79 P



Silicone Spray

• *100s of uses!*
 • *Spray-on protection!*
 Spray away squeaks, rust. Lubricates and protects many surfaces.
64-2310 69 P



All-Purpose Acrylic Protective Spray

• *Prevents arcing, corona shorts!*
 Over 20,000 V dielectric strength. Prevents rust, corrosion!
64-2317 99 P

Get the Job Done Right with Top-Quality Tools by Archer

● Precision Sets

● For Hobby, Jewellery, Electronics.

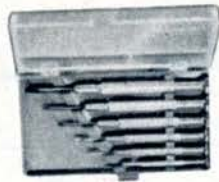

Screwdriver Set

● Handy carrying case!

Six precision screwdrivers in widths from 0.8 to 3.8 mm in a fitted plastic case. Hardened and tempered rustproof blades, chrome-plated brass handles, swivel tops for one-hand operation.

64-1948 £1.39

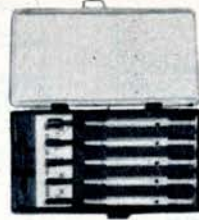

Nut-Driver Set

● Tempered and hardened!

Five precision nut-drivers with swivel tops and chrome-plated brass handles. Hardened and tempered for long life. One-hand operation for delicate jobs. Fitted plastic case.

Sizes: 3, 3.5, 4, 4.5 & 5 mm.
64-1957 £1.39

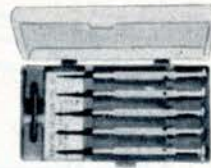

Crosspoint & Hex Key Set

● Rugged construction!

Set of 5 tools: 2 crosspoint screwdrivers (2.4 & 2.9 mm) and 3 hex-key wrenches (1.5, 2 & 2.5 mm). Chrome-plated brass handles and swivel tops for easy use. Hardened & tempered. In a fitted plastic case.

64-1958 £1.39

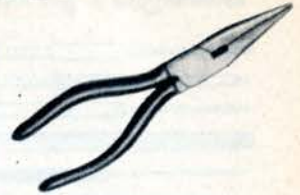

16.5 cm Needle Nose Pliers

Useful for wiring operations. Sheffield steel. Insulated grips.
64-1844 £1.49

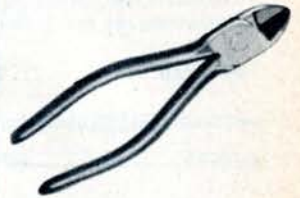

15.2 cm Diagonal Wire Cutters

Useful for wiring. Long-life Sheffield steel. Insulated grips.
64-1845 £1.49

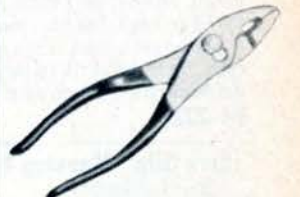

15.2 cm Slip-Joint Pliers

Adjust claw grip size. Handy for any electrical, mechanical job.
64-1846 99 P



● Colour coded handles!
● Handy carrying case!

8-Piece Interchangeable Screwdriver & Nut-Driver Tool Sets.

8-Piece Screwdriver Set. Specially hardened 48 mm blades in 8 different sizes. Each handle fits into master handle to give extra turning power.
64-1835 £1.35

8-Piece Nut-Driver Set. Insulated, colour-coded drivers fit into master „power handle“ for real torque. Tempered steel, rustproof sockets. Sizes: 4.5, 5, 5.5, 6, 7, 8, 9 & 10 mm.

64-1800 £1.85



Insert wire



Squeeze handles



Strips perfectly

Automatic Wire Stripper/Cutter

● No nicks, no breaks!

Professionally strips wire from N° 12 to N° 24 awg in seconds. Insert wire, squeeze handles and release - removes insulation cleanly, without nicking or breaking wire. Lightweight, durable. Put one on your work bench!

64-1955 £4.75



Miniature Pliers for Close Work

● Insulated grip!
● Drop forged!
● Fully polished!

A. 10.16 cm Nippers. Rugged quality made for hard, close work.
64-1840 £1.49

B. 11.3 cm Diagonal. Ideal for wire work in hi-fi and hobby use.
64-1841 £1.49

C. 11.3 cm Long Nose. Great for delicate electronics jobs.
64-1843 £1.49

D. 11.3 cm Flat Nose. Precision - manufactured general purpose tool.
64-1842 £1.49

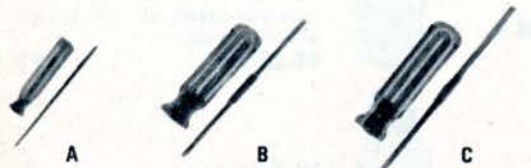

Two-In-One Reversible Screwdrivers

A. Reverses miniature Philips to miniature straight blade instantly.
64-1949 89 P

B. Reverses Philips N° 1 to standard 4.7 mm
64-1950 £1.19

C. Reverses Philips N° 2 to standard 6.3 mm
64-1951 £1.49



Miniature Precision Tool Kit

● 6-piece set!
● Plastic storage stand!

Contains 3 different standard screwdrivers (1.5, 2.5, 3.5 mm), 1 cross-point (3.5 mm), 1 scribe and a handle. Made from hardened and tempered steel. Handy plastic stand keeps tools together.

64-1981 £1.19

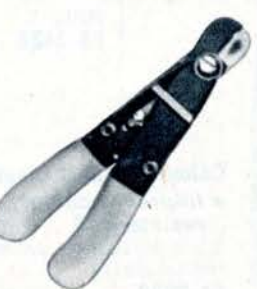

Stripper/Cutter

● Spring loaded!
● 12 to 24 gauge wires!

Handy tool for any wiring job. Long 12.7 cm blades for smooth cutting action. Easy-grip insulated handle.

64-2129 99 P



Crimps all terminals

All-Purpose Crimping Tool

● Slices bolts!
● Strips wire!
● Cuts wire!
● Crimps!

Do-it-all tool. Crimps insulated solderless terminals; slices machine screws, measures stud sizes. Hundreds of uses. A „must“ for hobbyists and do-it-yourselfers.

64-2268 £3.19

64-2269 22 assorted terminals 99 P



Dial-Type Stripper/Cutter

● Dial the gauge you want to strip!

Spring-loaded stripper and cutter has plastic cushioned grips, flush cutting action. Strips N° 12 to N° 24 awg wire.
64-1952 £1.39



3-Way Crimping Tool

● Crimps solderless terminals!
● Cuts, strips wire!

Hundreds of uses. „Sure grip“ insulated handle. With assorted crimp-type terminals.
64-405 £1.09

Accessories for your Workshop.



24-Drawer Cabinet

- "See-through" storage!
- For home, office or shop!

Sits on a desk or table. Portable storage organizer has unitized steel frame with stove enamel finish and handle. Clear plastic drawers 146×70×32 mm. With dividers and labels. **64-2027** £5.69



One-Ton Block & Tackle Hoist

- Handles tough lifting jobs!
- Lifting ratio of 7 to 11!
- Non-corroding aluminium/steel!

Weighs less than a pound yet has the muscle to lift a ton! Fully assembled - ready to use. Strong 1.65 m nylon ropes included. A practical tool for home, shop, garage or car. **64-164** £3.49

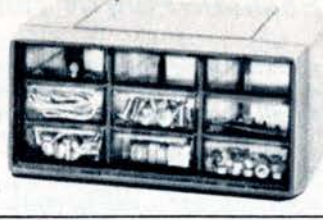

9-Drawer Cabinet

High-impact plastic. Great for jewellery, hardware, office items. Size 248×191×162 mm. Drawer size 222×146×64 mm. Dividers and labels included. **64-2039** £2.29



Precision Knife Set

Includes 10 interchangeable blades for delicate and exact cutting operations: PC boards, engraving, etc. With fitted plastic case. Great for the hobbyist! **64-1801** £1.49



Plastic Boxes

- Transparent!
- High impact!

Ideal for sorting out nuts, bolts, screws, washers, tacks, pins, other small items.

Cat N°	Size (mm)	Sections	Price
64-552	205 x 105 x 38	12	65 P
64-553	111 x 67 x 25	6	25 P
64-554	265 x 135 x 51	5	£1.19

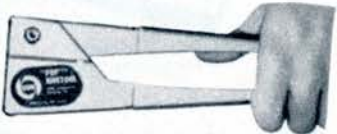

Pop Rivet Gun

- Easy to use!
- Quick fastening!

For permanent fastening jobs around the home or shop. Rivets won't strip, loosen or fall out.



64-2852	25 short rivets to 6,3 mm	£2.19
64-2853	20 medium rivets to 6,3 mm	35 P
64-2854	15 long rivets to 12,7 mm	35 P
64-2855	40 backup plates	35 P



15-Drawer Cabinet

- Ideal way to store and carry small items!

Unitized 254×203×152 mm steel frame storage organizer with 15 compact, transparent plastic drawers (146×70×38 mm). Convenient handle, drawer dividers and labels included. Stove enamel finish. **64-2026** £3.89



Nibbling Tool

- Cuts up to 18 gauge steel!
- Up to 16 gauge aluminium!

Great for just about any metal-working chore. Cuts straight, circular. Easy to use - no dials or controls to set. Comfortable trigger-type grip. Cuts smoothly - no jagged edges. **64-822** £3.49

Popular Electronics Hardware in Reusable Transparent Packs

- Hot tin-dipped solder-type lugs!
- Nickel-plated steel hardware!
- Solderless terminals, connectors and quick disconnects are properly assembled for easy crimping and electro-tin plated!



- Assorted vinyl-insulated washers. 7 each of 6.3, 7.9, 9.5 mm, 5 each of 11.1, 12.7 mm. **64-3025** 39 P
- Assorted wire nuts. 24 pieces, 5 different types in wire sizes 10 to 24. **64-3026** 39 P
- Assorted Butyrate cable clamps. 6 each of 3.18, 4.8, 6.35 mm cable diameter. **64-3028** 39 P
- 8. Assorted solder terminals. 48 pieces. Mounting holes of 3.7, 4.3 and 5.3 mm. **64-3029** 39 P

Figures 9-12. Crimp-type Terminals

- Non-insulated ring tongue. 6 each 3.7 & 4.3 mm (22-18 awg); 3.7 & 4.3 mm (wire size 16-14). **64-3030** 39 P
- Non-insulated fork tongue. 6 each 3.7 & 4.3 mm (wire 22-18); 3.7 & 4.3 mm (wire 16-14). **64-3031** 39 P
- 6 non-insulated fork tongue (wire sizes 26-24) and 4 insulated fork tongue (wire sizes 26-24). **64-3042** 39 P
- Insulated ring tongue. 4 each 3.7 mm (22-18), 2 each 4.3 mm (22-18), 2 each 3.7 mm (16-14), 2 each 4.3 mm (16-14). **64-3032** 39 P
- Insulated fork tongue. Assorted as above. **64-3033** 39 P
- Non-insulated fork tongue. 5.3 mm dia. 12 each of wire sizes 22-18 and 16-14. **64-3034** 39 P
- Insulated fork tongue. 5.3 mm dia. 5 each of wire sizes 22-18 & 16-14. **64-3035** 39 P

- Non-insulated splices. 10 each of wire sizes 22-18 and 16-14. **64-3036** 39 P
- Insulated splices. 5 each of wire sizes 22-18 and 16-14. **64-3037** 39 P
- 16. Male quick-disconnects. 2 non-insulated 4.76 mm, 4 non-insulated 6.3 mm, 2 each of insulated 4.76 and 6.3 mm. **64-3038** 39 P
- 18. Female quick-disconnects. Assorted as above. **64-3039** 39 P
- Nylon-insulated closed-end connectors. 5 each of wire sizes 22-14 and 16-10. **64-3041** 39 P

Figures 20-23 Crimp-type Terminals

- Non-insulated flanged fork. 6 each of 3.7 and 4.3 mm (22-18) and 6 each 3.7 & 4.3 mm (16-14). **64-3043** 39 P
- Insulated flanged fork. 4 each 3.7 mm (22-18); 2 each 4.3 mm (22-18), 3.7 & 4.3 mm (16-14). **64-3044** 39 P
- Non-insulated hook tongue terminals. 6 each 3.7 & 4.3 mm (22-18) and 6 each 3.7 & 4.3 mm (16-14). **64-3045** 39 P
- Female flag-type quick disconnects. Non-insulated. 5 each of 4.7 and 6.3 mm. **64-3046** 39 P



Wireless 2-Station System

Realistic Plug 'N Talk

- **Illuminated combination talk-bar/night light!**
- **Lock button for monitoring**
- **Call button alerts other station with a „beep“!**

So convenient – no wires to install, just plug it into the AC outlet! Use them in any room, they're ideal for monitoring or babysitting! Fingertip controls – press to talk, release to listen. Thumbwheel off/volume control. Lock for continuous transmission. Adjustable squelch minimizes line noise. Solid-state circuitry for low current drain. 127×140×41 mm. 220/240V AC.

43-210 £22.95



4-Station Intercom with Master & 3 Remotes

All remotes can call the master, even when off!

- **Place on a desk or wall-mount! All hardware included!**
- **Private conversations between master and remotes!**
- **Complete with three 20 m cables and 9V battery!**

Save time with a „whole house“ intercom. Master switch chooses one of 3 remotes or standby. Pressing talk bar on remote contacts master – even with the system turned off! AC adapter jack. Master: 124×105×44 mm. Remotes: 29×78×44 mm.

43-216 £14.95
270-9531 Universal AC adapter..... £4.49



2-Station Telephone Intercom

- **2-way continuous talk – no buttons to push!**
- **Buzzer alerts other people!**
- **Place on a desk, mount on a wall!**

Private, two-way conversations come through clear and crisp. Stylish handsets come with coiled cord. A battery saver turns the unit off when not in use. Includes batteries, 20 m cable, instructions. 98×235×82 mm (with base).

43-242 £13.50

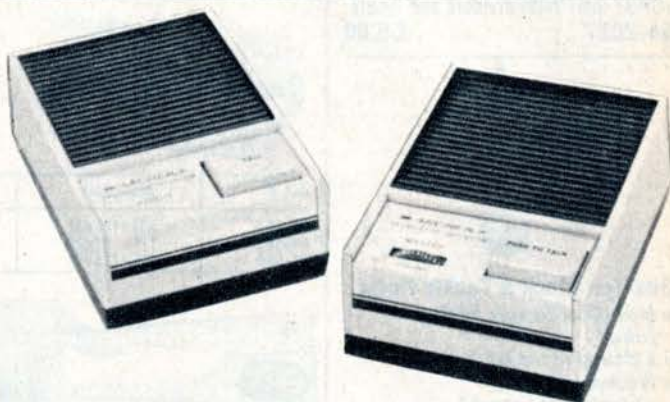

2-Station Indoor/Outdoor Intercom

Ideal for caravans!

- **Remote signals master – even with system off!**
- **Battery operated for portability & versatility!**
- **Our lowest priced Intercom system!**

Use it anywhere. Perfect for connecting the car to the caravan! Great at home too – use it outside to check callers at the front door, or inside to connect rooms! For desk top or wall-mounting. Easy to install and use. Includes batteries and 20 m connecting wire. 105×78×44 mm each.

43-221 £7.95

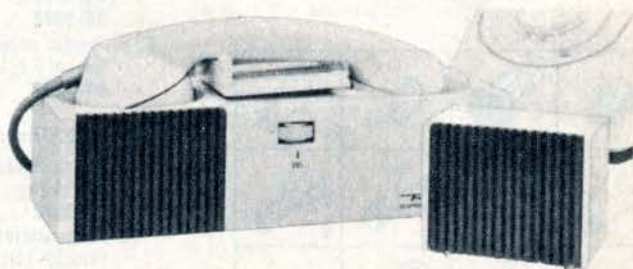

Telephone Amp with Separate Speaker

- **The whole family can listen & talk!**
- **Hands-off phone conversations!**
- **No installation!**

Get everybody in on the action – ideal for family calls, business conference calls. Separate speaker and mike. Place phone on the cradle to turn the unit on. Volume control. With batteries, earphone jack for hard-of-hearing people. Main: 260×114×82 mm. Speaker: 89×57×70 mm.

43-230 £10.95

Make Better Recordings With Realistic Tape Accessories



8-Track Demagnetizer Headcleaner

- Requires no power!
- Demagnetizes as it cleans!

It's patented! Requires no power yet cleans and demagnetizes 8-track players and recorders. Full maintenance takes only 40 seconds, but improves performance. Reduces hiss, increases response. A clean recorder helps eliminate mangled tapes. Non-abrasive.

44-630 £3.49



Cassette Head Cleaner

For stereo or mono players. Insert cassette and switch unit to „play“ for about 20 seconds after each 10 hours of use. Non-abrasive; removes deposits.

44-1160 89P



Cassette Index Labels

Packet of 24, colour-coded.

44-621 49P

8-Track Index Labels

Packet of 20, colour-coded.

44-622 65P



Deluxe Cassette Splicer

Precision splicer made specifically for cassettes. Cuts and trims.

44-771 £1.89



8-Track Clip-on Covers

Set of 10

Protects tape cartridges from dust and dirt. Snaps on easily.

44-206 55P



Tape Head Demagnetizer

Keep recorders & tape decks in peak condition! A must for anyone with a recorder or playback deck. Works with any machine cassette, 8-track, reel-to-reel. Reduces hiss, distortion; maintains high-frequency response. Simple to operate, takes just seconds to completely demagnetize your unit. Easy-grip handle with AC cord.

220/240V.
44-772 £2.95



8-Track Head Cleaner

For all 8-track car or home units. Insert into player as a cartridge, allow machine to operate for 10 seconds. Non-abrasive, removes all oxide deposits.

44-1161 99P



8-Track Head and Capstan Cleaner

One end cleans tape heads, the other cleans the capstan rollers! For 8-track car or home units. Insert and allow to run for 10 seconds. Non-abrasive - removes all deposits.

44-208 £1.29



Cleaning Cloths

Pack of 4. Chemically treated - removes distortion and squeal.

44-1088 59P



Cassette Tape Splicer

Splicing block especially designed for cassettes. Edit or repair in seconds.

44-1021 £1.49



Cassette Demagnetizer/Cleaner

Needs no power! Unique, patented device demagnetizes cassette machines as non-abrasive cloth cleans heads, tape guides. Complete maintenance in about 60 seconds.

44-631 £2.89



Cassette Repair Kit

Transfer tape from damaged or defective cassette to new housing. 60 cm leader. Complete instructions.

44-626 59P



100 Cleaning Sticks

Get at hard-to-reach spots in recorders. 15 cm long. Cotton tips.

44-1093 39P



Heavy Duty Cassette Storage Boxes

Keeps tapes clean. Hinged cover.

44-611 45P



Remote Foot Switch

Use with any recorder with remote control mike jack.

44-610 £1.95



Recorder Cleaner

Cleans heads and all metal parts. Applicator.

44-1010 55P

Special Formula



Cassette Mailers

Packets of 3. Use as storage boxes also. With mailing labels.

44-608 25P



Cloth Tape Head Cleaner

7.6 cm reel of cleaner-impregnated cloth tape and extra fluid.

44-1151 ... £1.19



Tape Mailers

Packet of 12. For reels up to 83 mm.

44-1057 49P



Self-stick Pressure Pads

Replace worn pressure pads! 2 pads, 3.2 and 4.7 mm thick.

44-1027 35P



Aerosol Head Cleaner

Convenient spray cleaner has extension nozzle.

44-1011 ... £1.19



Tape Head Lubricant

Excellent for chromium dioxide and other tapes.

44-1009 39P



Non-Slip

Ensures uniform speed. For idler wheels, etc. Applicator. Won't harm rubber.

44-1013 49P



Lubricating Oil

For recorders and changers. Prevents rust and corrosion on moving parts.

44-1012 35P

Realistic Top-Quality Mylar and Tensilized-Mylar Recording Tape



Professional quality, extra-durable all-Mylar base – so your recordings will last for years. Made to Realistic's specifications by one of America's top manufacturers!

- Uniform output!
- Long lasting!
- Superior fidelity
- Splice-Free!
- No „dropouts“!

High quality Realistic tape records music or voice with „original performance“ fidelity. Rugged, flexible Mylar base lasts through years of wear and will not grow brittle with age. Tensilized Mylar resists stretching – even under tension. Storage box keeps tape dust and dirt-free.

Cat. N°	Reel size cm	Length m	Base	Price each		
				1-5	6-9	10 & Up
44-733	6	90	Mylar	59 P	56 P	53 P
44-734	7.5	89	Mylar	49 P	47 P	44 P
44-760	8.2	180	Tensil. Mylar	79 P	75 P	71 P
44-735	13	180	Mylar	85 P	81 P	77 P
44-753	13	270	Mylar	£1.25	£1.19	£1.13
44-736	18	360	Mylar	£1.29	£1.23	£1.16
44-754	18	540	Mylar	£1.79	£1.70	£1.61
44-758	18	730	Tensil. Mylar	£2.59	£2.46	£2.33
44-766	18	1080	Tensil. Mylar	£4.49	£4.27	£4.04

Tandy's Practical Accessories for Real-to-Reel Tape



Colour-coded Leader Tape

Two 7.6 cm reels of 45.7 m tape – one red, one white. Ideal for indexing and cueing. Splice on to tape ends to protect or extend tape.

44-1053 69 P



Telephone Pick-up Coil

Lets you record any vital calls. Suction cup installs on handset. Gives clear recordings. Low-cost solution to an important job. With cord and plug.

44-533 75 P



3-Pack Tape Cases with Rack

Keeps tapes clean and dustfree. Stack side by side for easy access. Buy enough for your entire tape library.

44-1153 13 cm £1.19
44-1152 18 cm £1.49



Empty Tape Reels with Boxes

Cat N°	Reel cm	Price each		
		1-5	6-9	10-Up
44-272	6	13 P	12 P	11 P
44-273	7.5	15 P	14 P	13 P
44-1000	8.2	17 P	16 P	15 P
44-278	13	35 P	33 P	31 P
44-279	18	45 P	43 P	41 P

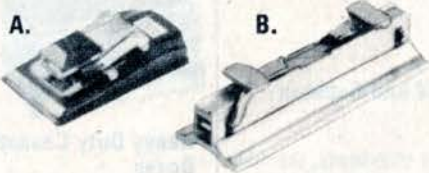

Reel-to-Reel Tape Splicers

- A. Precision cuts and trims diagonally. Dispenser, roll of 9.5 mm wide splicing tape.
44-770 £2.45
- B. Makes well-bonded splices. All aluminium.
44-1020 £1.29



6.3 mm 9.5 mm 12.7 mm

Mylar Base Splicing Tape

Assures secure, high-quality splices every time. Base does not grow brittle with age!

Cat N°	Width mm	Length m	Price
44-1125	6.3	30.48	20 P
44-1126	9.5	30.48	25 P
44-1127	12.7	30.48	29 P



Metallic Sensing Tape

Automatically stops or reverses any recorder having electronic switching controls – you never touch the tape or recorder! Just apply to tape! 30.5 m.

44-1155 99 P



Packet
of 36
25 P

Tape Labels

Self-stick, 12.7 × 50 mm labels let you identify tapes at a glance. Fit securely on reels.

44-1029 25 P

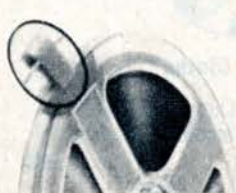

Tape End Clips

Sturdy plastic clips secure loose ends to guard against tearing & cracking. Fit any size reel. Keep tapes neat.

44-1028 29 P

Packet
of 18
29 P

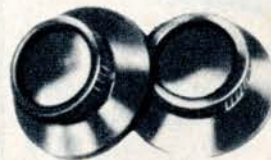

45 P
Pair

Tape Reel Holders

Press over spindles to keep reels seated and wobble free. A must for vertical players. Made of durable rubber.

44-1068 45 P

Supertape: New Oxide Coating for Super-Linear Response.



Laboratory Standard Series.

Super-durable Mylar base tape

Plays up to twice as long as other reel-to-reel tapes. For all general recording purposes. Full-range response.

Cat. N°	Size cm	Length m	Thickness μ	Base	Price		
					1-5	6-9	10-Up
44-1872	13	270	25	Mylar	£1.59	£1.51	£1.43
44-1873	18	540	25	Mylar	£2.79	£2.65	£2.51
44-1875	18	730	12.5	Tens. Mylar	£3.99	£3.79	£3.59

Low Noise, Wide Dynamic Range Tape for Professionals

• *Extended response of 30 Hz to beyond 20,000 Hz, within 3 dB!*

Superior signal-to-noise ratio and ultra-wide dynamic range for professional quality recordings. Amongst the finest available anywhere!

Cat. N°	Size cm	Length m	Thickness μ	Base	Price		
					1-5	6-9	10-Up
44-1878	18	360	37.5	Mylar	£2.59	£2.46	£2.33
44-1877	18	540	25	Mylar	£3.29	£3.13	£2.96
44-1879	18	730	12.5	Tens. Mylar	£4.49	£4.27	£4.04

Reduces hiss & headwear!



CONCERTape - Best Value 540 m Tape. High Quality - Low Cost!

- **Long Lasting!**
- **Polyester Base!**
- **Pre-tested!**

Free of defects to provide excellent recordings. Manufactured and quality-controlled by a leading producer of professional tapes. Extra-length 25 μ thickness gives up to 50% more recording time than conventional tapes - ideal for taping concert-length LPs or FM stereo broadcasts! Designed

to eliminate excessive hiss, dropouts. High tensile strength polyester base will not be affected by humidity during long-term storage or use. 540 m on 18 cm plastic reel. Buy in quantity and SAVE!

Cat. N°	Price Each			
	1-5	6-9	10-49	50-Up
44-1018	£1.39	£1.32	£1.25	£1.18



Heavy Duty, 37.5 μ Mylar Base CONCERTape

- **NO Flaking**
- **NO Dropout!**
- **High S/N Ratio!**

Delivers a high-integrity signal - makes quiet, great sounding recordings! Special oxide coating is highly impressionable to magnetic signal from head - tape is free from flaking, edge burrs, shredding or uneven distribution of oxide for uni-

form sound quality. Mylar base offers double the strength of acetate - plus 5% elongation resiliency & high resistance to humidity. Each 13 or 18 cm reel can be stored dust and dirt free in its own protective box.

Cat. N°	Length m	Size cm	Price Each		
			1-5	6-9	10-Up
44-755	360	18	99P	94P	89P
44-1085	180	13	69P	66P	62P



Triple-play Tensitized 12.5 μ Polyester Tape

- **Pre-stretched, lubricated!**
- **Long-wear capability!**
- **Extra-long storage life!**

Cat. N°	Length m	Size cm	Price Each		
			1-5	6-9	10-Up
44-1059	360	13	£1.35	£1.28	£1.22
44-1060	730	18	£1.89	£1.80	£1.70
44-1061	1080	18	£2.79	£2.65	£2.51

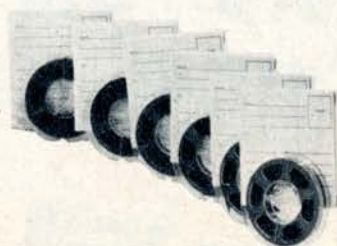

6-Pack Tape Special!

- **75 m reels - perfect for students or tape correspondence!**

Six 7.6 cm reels of quality magnetic tape - ideal for any voice recording! Up to 30 minutes recording per reel. Cases have labels for mailing or indexing. Stock up today!

Cat N°	Price per pack of 6		
	1-5	6-9	10-Up
44-1056	£1.29	£1.23	£1.16

Realistic Supertape Cassettes



New Formula Oxide Coating for Super Linear Response!



Deluxe hinged plastic storage case

- **Wide dynamic range – resists overload distortion!**
- **Improved sensitivity for full-range response!**

Nobody thought iron oxide tape could be this good, but here it is – new Supertape with super linear response! No special bias required – get the best possible performance from any recorder including portables. Smaller oxide particles mean fewer drop-outs, increased sensitivity and reduced headwear. High output dramatically reduces annoying hiss and distortion. Tough polyester base is unaffected by age.

Record Sensitivity (1% THD) +2 dB
 Output Variation 1 dB
 Signal-to-Noise Ratio 56 dB
 Colour Dark Brown
 Base Tensitized Mylar
 Frequency Response
 333 Hz +1.5 dB
 1000 Hz +0.8 dB
 Overall response flat within 3 dB from 40-14,000 Hz

Cat No	Type	Playing time per side	Price each		
			1-11	12-23	24-Up
44-617	C-45	22½ minutes	1.09	1.04	98P
44-615	C-60	30 minutes	1.29	1.23	1.16
44-616	C-90	45 minutes	1.79	1.70	£1.61

Realistic High-Output Cassettes



- **3 dB increased sensitivity!**
- **Low noise, wide dynamic range – your best buy!**
- **A length for every taping need!**



Deluxe hinged plastic storage case

You can pay a lot more for these general purpose recording tapes, but not when you buy them at TANDY! Everything about them is high quality – high output, low-noise, extended frequency response tape housed in a cassette that's the envy of the industry. The housing features double-flanged

idler rollers and stainless steel pins to reduce wow & flutter, nickel alloy hum shield, and graphite coated slip sheets for even winding without static build-up.

Cat. No	Type	Playing time per side	Price each		
			1-11	12-23	24-Up
44-601	C-30	15 minutes	59P	56P	53P
44-602	C-60	30 minutes	69P	66P	62P
44-603	C-90	45 minutes	89P	85P	80P
44-604	C-120	60 minutes	£1.29	£1.23	£1.16



Three-Pack Concertape Cassettes - A Value Leader

- **Buy at quantity prices for even greater savings!**

Great for voice and general purpose recording. Use shorter tapes for „voice letters“, longer tapes for concert-length recordings. All are made of heavy-duty polyester to resist breakage and stretching while giving extra-wide response! At these low „quantity“ prices you can afford to really stock up!

Cat. No	Type	Playing time per side	Price per pack of 3	
			1-11	12-Up
44-606	C-30	15 minutes	£1.29	£1.20
44-607	C-60	30 minutes	£1.39	£1.30
44-613	C-90	45 minutes	£1.79	£1.68
44-614	C-120	60 minutes	£2.49	£2.35

Realistic Supertape - Now Available in 8-Track Cartridges!



New Formula Oxide Coating for Super Linear Response!

- *Finest 8-track cartridge ever made!*
- *Extended dynamic range – less noise and improved high frequency response!*
- *Tough polyester base – unaffected by age!*
- *Convenient new 45 & 90 minute lengths!*

Now you can get the best high-fidelity performance from any 8-track recorder with **no special bias setting!** You'll get full-range response, wide dynamic range and incredibly reduced hiss for „pro“ recordings. Super fine-grain coating reduces head wear and a special lubricant means fewer mangled tapes. New lengths give you plenty of tape for copying even long records. You can't buy a better cartridge!

Cat. N°	Total Playing Time	Price each		
		1-11	12-24	25 - up
44-842	45 minutes	£1.69	£1.61	£1.52
44-843	90 minutes	£2.19	£2.08	£1.97

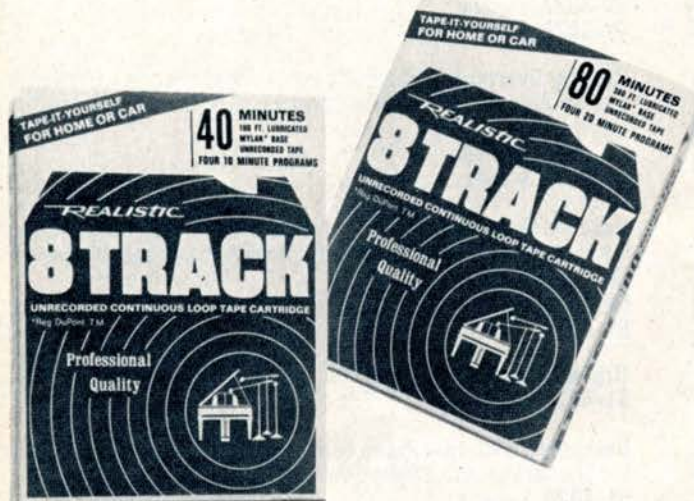

Realistic Blank 8-Track Cartridges For Home or Car Tape Systems

- *Lubricated Mylar Base!*
- *Continuous Loop!*

automatic operation – no rewinding or rethreading. Friction reducing lubricant moves tape freely through recording mechanism without sticking. Uniform oxide coating insures high signal-to-noise with no flaking! Buy in larger quantities and save even more – stock up!

Record your own 8-track cartridges and SAVE – play them back on ANY home or car player! Self-contained

Cat. N°	Total Playing Time	Price each		
		1-11	12-24	25 - up
44-840	40 minutes	£1.39	£1.32	£1.25
44-841	80 minutes	£1.69	£1.61	£1.52



Realistic Chromium Dioxide High-Fidelity Cassettes

Greatest Advance in Tape since the Cassette!

- *Chromium Dioxide is your BEST cassette tape!*

Here's Why!

Record Sensitivity at 333 Hz	-1 dB
Harmonic Distortion at 333 Hz	0.7%
Frequency Response	
at 8,000 Hz	+ 7 dB
at 12,000 Hz	+ 9 dB
Output Variation at 333 Hz	1 dB
Signal-to-Noise Ratio	54 dB
Colour	Black
Base	Mylar

Made especially for cassette recorders with special CrO₂ bias switches. Chromium dioxide tape provides the widest available frequency response and lowest hiss for recordings that rival reel-to-reel tapes. High-quality housing assures smooth handling. **Not for recorders without CrO₂ bias.**

Includes plastic storage case

Cat. N°	Type	Playing time per side	Price each		
			1-11	12-23	24 - up
44-618	C-60	30 minutes	£1.59	£1.51	£1.43
44-619	C-90	45 minutes	£1.99	£1.89	£1.79

Demonstration and Sound Effect Stereo Tapes

Realistic „Audiophile Series“ 8-Track Cartridges and Cassettes



Stereo Spectacular. Spans the entire frequency range with stunning sound effects. Orchestral, individual instruments, „live“ effects, others.
 51-2777 Cassette £2.79
 51-3777 8-Track £2.89

Live Mechanical Sound Effects. Unusual sounds for unusual listening: lawnmower, turnstiles, car body crusher, stock cars, fire engine... 38 in all.
 51-2778 Cassette £2.79
 51-3778 8-Track £2.89

50 Sound Effects in Stereo. Ocean liner, airplanes, crowds, pistol shots and ricochets, thunder, water dripping and pouring, animals.
 51-2779 Cassette £2.79
 51-3779 8-Track £2.89

Sound Effects in Stereo. Chinese New Year, helicopter, slot machine, walking in snow, children in a playground, throwing dice, animals, more.
 51-2780 Cassette £2.79
 51-3780 8-Track £2.89

18 cm Reel-to-Reel Demonstration Tape

4-track stereo tape has actual sounds of trains, airplanes, parades, birds, etc., to demonstrate the capabilities of your Hi-Fi system!

51-1777 £2.79



„Audiophile Series“ Classical Corner

Cassettes and 8-Track !

One-hour pre-recorded stereo tapes offer twice the music at half the usual cost! Each feature world-famous performers, too:



Tchaikovsky – The Pathétique Symphony. Complete recording of the famed Symphony N° 6 plus Tchaikovsky's 1812 Overture.
 51-4070 Cassette £2.79
 51-5070 8-Track £2.89

Strauss Waltzes & von Suppé Overtures. – Emperor and Blue Danube Waltzes. Tales from the Vienna Woods, Light Cavalry and Poet & Peasant Overtures.
 51-4071 Cassette £2.79
 51-5071 8-Track £2.89

Tchaikovsky Ballets – Complete Swan Lake, selections from Romeo and Juliet and the Nutcracker Suite.
 51-4072 Cassette £2.79
 51-5072 8-Track £2.89

Popular Overtures – Reznicek's Donna Diana. Smetana's Bartered Bride, Brahms' Academic Festival, Beethoven's Egmont and others by Thomas, Verdi and Wagner.
 51-4073 Cassette £2.79
 51-5073 8-Track £2.89

Russian Masterpieces – Tchaikovsky's March Slav, Rimsky-Korsakov's Russian Easter Overture, Borodin's Polovetian Dances and others by Moussorgsky and Glinka.
 51-4074 Cassette £2.79
 51-5074 8-Track £2.89

Organ Music – Vivaldi's The Four Seasons and Bach's Toccatas and Fugues.
 51-4075 Cassette £2.79

Beethoven & Chopin Piano Selections – Beethoven's Moonlight Sonata and Emperor Concerto. Chopin's Polonaise.
 51-4076 Cassette £2.79

8-Track and Cassette Holders



Cassette



8-Track

Lazy Susan

Metal case with cushioned ball-bearing swivel base that keeps your tapes fingertip ready. Attractive walnut-grain trim and chrome handle.
 44-651 Holds 24 cassettes £5.89
 44-652 Holds 24 cartridges £8.49

Tape Storage Racks

In gold-plated metal. Allows easy indexing.
 44-623 Holds up to 36 cassettes £2.69
 44-624 Holds up to 32 cartridges £2.69

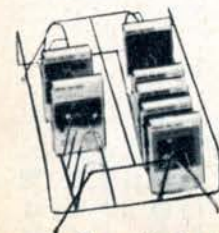

Cassette Rack



8-Track Rack

Home or Auto Tape Carry Case



The case divides in the middle to sit comfortably on the „hump“ between the front seats of the car. Black moulded case with walnut trim and carrying handle.
 44-650 £3.79

Holds 12 cartridges!
 Holds 36 cassettes!

Product Index

A					O		Controls	30
Acoustic Insulation	20	Kit	82	Organ Kit	85	Grille Cloth	29	
Adapters	32, 69	CONNECTORS	22, 23, 52, 66-68, 71	Oscillator, Code Practise	2, 82	Grilles	30, 31	
Adapter, Universal AC	69	Controls, Volume	63	„OTL“ Amplifier Kit	82	Hi-Fi	12-15	
Adapter, DC Auto	32	CONVERTERS				L-Pad	30	
Adhesives	39	FM Car	33			Musical Instruments	29	
AERIALS		Power	32			Outdoor	14, 27	
Amateur/SWL	2	Crimping Tools	40	P		Pillow	19	
Car	31	Cutters, Wire	40	Panel Meters	77	PA	26	
FM	51			Perf boards	55	Radio Extension	92	
Indoor	54			PHONOS, Mono	91	Replacement	27-31	
TV	50-52			Phono Accessories	20, 21	Switches	30	
AERIAL ACCESSORIES				Pilot Lights	65	Splicer, Tape	43, 44	
Cables	52, 53	D		Pliers	40	Substitution Box	77	
Connectors	52, 71	Demagnetizers, Tape Head	43	PLUGS	66-68	SWITCHES	30, 64	
Couplers	52, 53	Dials & Accessories	69	Potentiometers	63	Illuminated	64	
Coax Cable	52, 53, 71	Digital Readouts	61	PRINTED CIRCUIT EQUIPMENT		Magnetic	64	
Hardware	54	DIODES	56, 57, 60, 61	Boxes	72	Toggle	64	
Masts	53	Dwell/Tach	32	Brackets	55			
Mounts (Roof)	53			Components	55			
Mounts (Wall)	53, 54			Kits	55	T		
Rotators	52	E		PUBLIC ADDRESS EQUIPMENT	26	Tachometer	32	
Splitter	53	Earphones	19	Publications	81	TAPE		
Wire	52, 53, 70, 71	EDUCATIONAL LAB KITS	85-87	QUADRAPHONICS (4-Channel)		Accessories	43, 44, 48	
Aircraft Receiver	91			Receiver	9	Blank Tape	44-47	
Alarms	72	F		Synthesizers	14, 15, 34	Electrical Tape	38	
Alarm Kit	82	FIBRE OPTICS	73-75	Systems	9	Prerecorded	48	
Alignment Tools	39	Flasher Kit	82			TAPE EQUIPMENT		
Alligator Clips	68	Flashlights	37			(8-Track)		
Amateur Receiver	2	Fuses	65			Car Players	35	
AMPLIFIERS	10, 11, 26, 42, 72, 82, 84					Stereo Record/Play Decks	95, 96	
Amplifier/Speaker Combo	72	G		R		Players	88, 95, 96	
ARCHER KITS	83, 84	Grille Cloth	29	Aircraft	91	(Cassette)		
Audio Cables	19, 21-23			Car	33	Stereo Record/Play Decks	94	
		H		Clock	89	Players (Stereo)	94	
		Ham, SW Accessories	2	Multiband	91	Mono Portables	93	
		HARDWARE	41	Novelty	91, 22	Telephone Amplifier	42	
		HEADPHONES	18, 19, 83	AM, AM/FM Portables	90, 91, 92	Tele/Microscope	36	
		Heat Sinks	60	Table	88, 89, 91	Terminal Strips	68	
		HI-FI EQUIPMENT		Kits, AM	86	Test Leads	68, 71	
				Kits, Multiband	85	Test Probes	68	
				RECEIVERS		Timing Lights Kit	83	
		Hobby Tools	38-41	Amateur	2	Wired	32	
		Hoist	41	Communications	2	TOOLS	38-40	
				Four-Channel	9	Torch	38	
		I		Ham	2	Transformers	69	
		IC's	56, 59	Shortwave	2	Transistor Tester	77	
		Insulators	70	Stereo	4-8, 88, 96	TRANSISTORS	56-58, 61	
		INTERCOMS, Wired	42	Systems	Front Cover, 4-9, 88, 96	TREASURE FINDERS	84	
		Kit	42			TUBING, Plastic	71	
		Wireless	84	Record Accessories	20	Heat Shrinkable	57, 71	
		Inverter, Voltage	60	RECORDS, DEMO & TEST	17	TUNERS	10, 11	
				Rectifiers	60	TURNTABLES, Ceramic	17	
				REEL-TO-REEL TAPE		Magnetic	16	
		J		Blank	44, 45			
		Jacks	66-68	Relays	63	V		
				RESISTORS	57, 63	VALVES	80	
		K		Riveter	41	Sockets	61	
		Keys, Code	2	ROTATORS, AERIAL	52	Vernier Dials	69	
		Knobs	57, 69			VHF Radios	91	
						Voltage Regulators	59	
		L				VOM's	76	
		L-Pads	30	Saw, Hole	39	Voltmeter Kits	81	
		Labels, Index	43, 44	SCIENCE FAIR KITS	82-87	Volume Controls	63	
		Lamp Bulbs	65	Screwdrivers	40			
		Lie Detector Kit	84	SECURITY EQUIPMENT				
		Light Emitting Diodes	61	Alarms	37	W		
		Lubricants	39, 43	Doorscope	36	Wiper Delay Kit	83	
		Lugs	41, 68	Window foil	37	WIRE & CABLE		
				SEMICONDUCTORS	56-61	Aerial	52, 53, 71	
		M		SW Receiver Kits	85	Audio	22, 23, 70	
		Magnets	39	Signal Tracer	77	Coaxial	52, 53, 71	
		Magnifier	36	Siren Kits	37, 82	Hookup	71	
		METAL LOCATOR KITS	84	SOCKETS	57, 65-67	Intercom	70	
		Meters, Panel	77	IC	59	Lamp	70	
		Metronome (Electronic)	83	Transistor	60	Magnet	71	
		MICROPHONES	24, 25	Valve	61	Microphone	70	
		MULTITESTERS	76	SOLDER EQUIPMENT	38	Shielded	70	
				Sound-Level Meter	26	Speaker	22, 23, 70	
		N		Spacers	55			
		Needles, Phono	21	SPEAKERS		WIRE-WORKING TOOLS		
		Nibbling Tool	41	Accessories	20-23, 29, 30	Cutters	40	
		Noise Suppressors	32	Amplifier/Speaker	72	Strippers	40	
		Nutdrivers	40	Baffles	27			
				Car	31, 34	Z		
						Zener Diodes	56, 60	

Antiference Trucolour MK 2 UHF Aerials

A Must for Colour Reception!

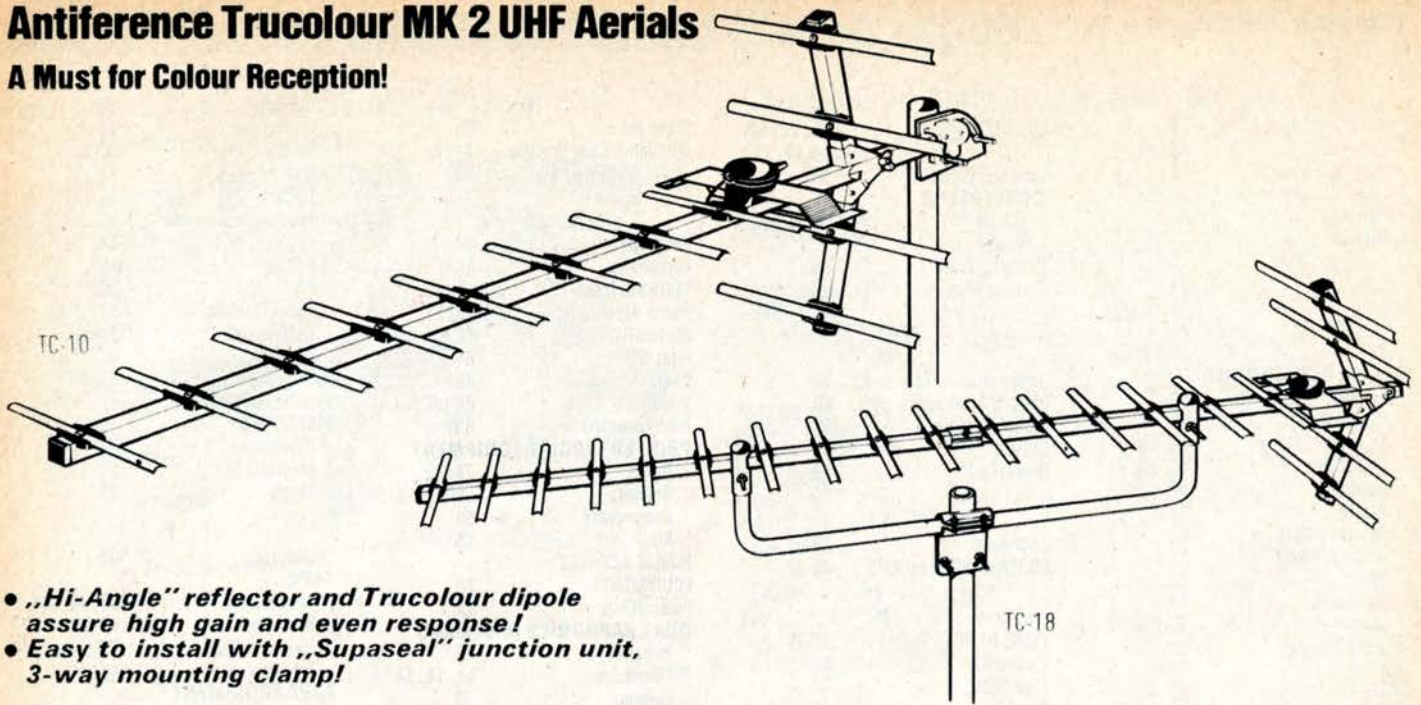

- **„Hi-Angle“ reflector and Trucolour dipole assure high gain and even response!**
- **Easy to install with „Supaseal“ junction unit, 3-way mounting clamp!**

Save on costly installation bills and install your own aerial. Perfect colour and black & white reception can be yours for far less than you'd usually pay with this quality aerial. Special features for easy installation include a „man-size“ weatherproof junction unit with simple screw-terminal connections, „Supaseal“ entry which automatically adjusts to any size of cable and captive unit cap which can't be lost during installation. The Hi-Angle reflector snaps into place and the 3-way mounting clamp allows easy turning or tilting of the aerial. The TC-10 is recommended for primary service areas and the TC-18 for medium/long-range reception. Both have a strong welded boom for years of service.

Cat. N ^o	Type	Channel Group	Channels	Colour Code	Elements	Price £
15-9202	TC-10	A	21-43	Red	10	3.25
15-9203	TC-10	B	39-51	Yellow	10	3.25
15-9204	TC-10	CD	49-68	Blue/Green	10	3.25
15-9205	TC-18	A	21-34	Red	18	4.60
15-9206	TC-18	B	39-51	Yellow	18	4.60
15-9207	TC-18	CD	49-68	Blue/Green	18	4.60

Antiference „Extra Gain“ UHF Aerial for Fringe Areas

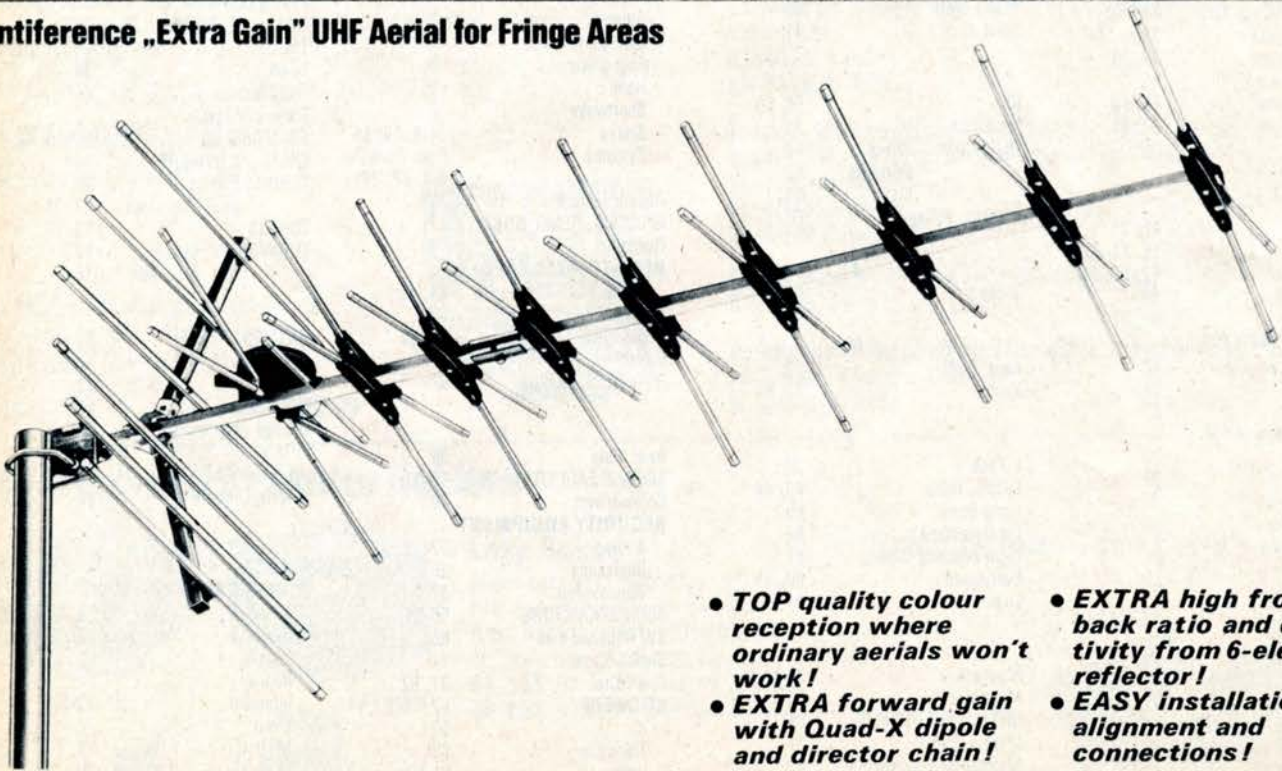

- **TOP quality colour reception where ordinary aerials won't work!**
- **EXTRA forward gain with Quad-X dipole and director chain!**
- **EXTRA high front/back ratio and directivity from 6-element reflector!**
- **EASY installation, alignment and connections!**

The perfect aerial for the „problem“ location. The XG-8 with its 8 Quad-X director bays gives the same gain as a 2 x 18 element aerial, but is much lighter and easier to install. Highly directive to prevent ghosting and maximize performance. 3-way clamp for easy mounting, may be rolled for vertical alignment. Resilient director mounting mouldings and sealed element ends keep water out and ensure long continued top performance. Channel A is 1.35 m boom length, B and CD are 1.17 m. Average forward gain is 17 dB;

Cat. N ^o	Channel Group	Channels	Colour Code	Price
15-9208	A	21-34	Red	£ 7.00
15-9209	B	39-51	Yellow	£ 7.00
15-9210	CD	49-68	Blue/Green	£ 7.00

Put Up Your TV Aerial Yourself and Save!

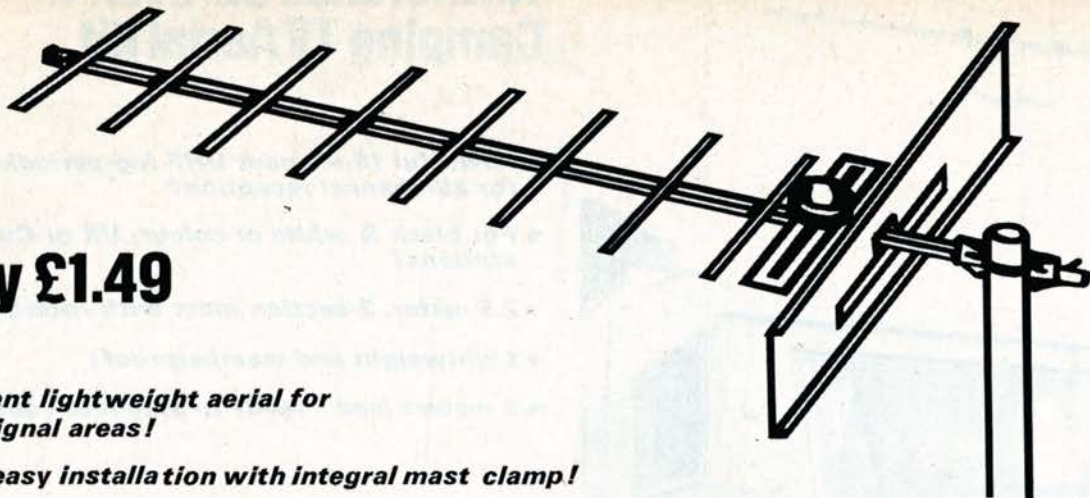

only £1.49

- **10-element lightweight aerial for strong signal areas!**
- **Simple, easy installation with integral mast clamp!**

Installed either in the loft or on your roof, this is the perfect aerial for strong signal locations. Can be put up with just a wrench and a screwdriver by anyone! Weatherproof junction box with screw terminals. Even at our low price it will provide far superior reception to a set-top aerial.

Cat. N ^o	Channel Group	Channels	Colour Code	Price
15-9242	A	21-34	Red	£ 1.49
15-9243	B	39-51	Yellow	£ 1.49
15-9244	CD	50-68	Blue/Green	£ 1.49

Fine FM/Stereo Reception Requires an Aerial!

3-Element £2.69

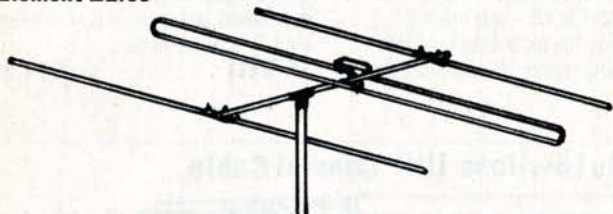

- **High quality extruded aluminium alloy construction!**

These aerials are a must for good stereo even in strong signal locations. Just like colour TV, stereo requires a much stronger signal for low distortion and low noise. Both aerials can be mounted either on the roof or in the loft. They have a strong double J-bolt mast attachment for any size mast, and

4-Element £3.29

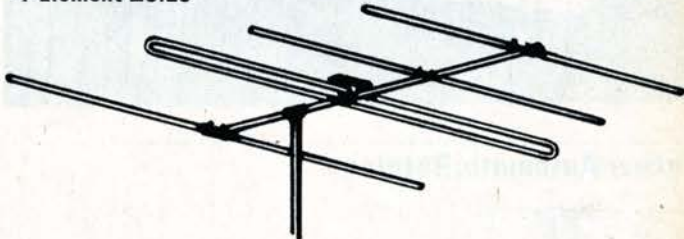

- **Simple installation but BIG performance!**

assemble and install quickly.

15-9240	3-Element	5 dB Gain	£ 2.69
15-9241	4-Element	6.5 dB Gain	£ 3.29

Antiference „Mush” Killers. For the Best FM Stereo Reception.

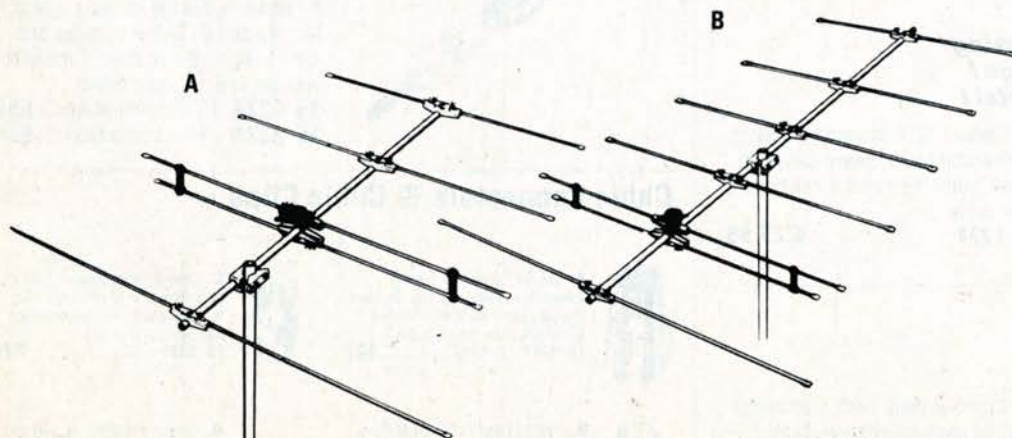

- **TRU-MATCH dipole ensures accurate match to cable for interference-free reception!**
- **Fast assembly, elements snap into position; universal clamp adjusts to any mast!**
- **Highly directive to ensure no multipath distortion!**
- **Your fine stereo system deserves a fine aerial!**

Specially designed elements and dipole give high gain over the entire FM band. Very high directivity cuts out unwanted signals and reflections which cause multipath distortion – the equivalent of TV ghosting! Perfect for use with a rotator in areas with stations at different locations – or simply add it on to your TV mast.

A. FM 244T. 4 elements with 7 dB gain, ± 28 dB acceptance angle.	
15-9200	£ 5.25
B. FM264T. The ultimate for medium/long-range reception. 6 elements, 9.5 dB gain only, ± 26 dB acceptance angle.	
15-9201	£ 7.95

Antiference Caravan & Camping TV Aerial Kit



- **Powerful 15-element UHF log-periodic array for all-channel reception!**
- **For black & white or colour, UK or Continental stations!**
- **2.5 meter, 3-section mast with rotating handle!**
- **Lightweight and weatherproof!**
- **9 meters lead – ready to plug into your TV!**

only £11.50

It's a complete, lightweight, pack-away TV aerial and mast that clamps to your caravan towbar, stands by your camping site, or goes up wherever you moor your motor cruiser! Needs no extras at all – just erect it and plug the extra-long lead into the aerial socket of your portable TV.

You'll get the finest possible reception from UHF transmitters anywhere – in the UK or in Europe! And when you move on, the aerial, mast, lead, everything, packs and stows away in a carton just 5 cm high! Complete with TV station guide.

15-9211 £11.50

Archer Automatic Rotator

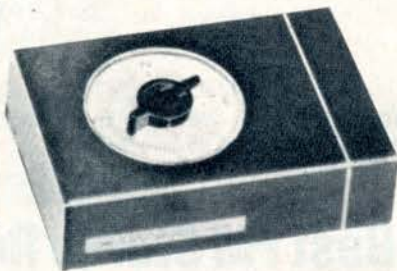

- **Weatherproof die-cast housing!**
- **Lifetime lubricating bearings!**
- **Mechanical brake locks aerial!**

Zeros-in on each station for maximum signal strength, clearest pictures and sound! Simply turn the knob on the control unit to direction desired; the rotator turns the aerial accurately. Gold finished die-cast housing takes

22.2 mm to 52.4 mm outdoor masts. Mechanical brake, heavy-duty/high torque motor. Requires 4-conductor rotor cable.

15-1221 £25.95

4-Conductor Rotor Cable

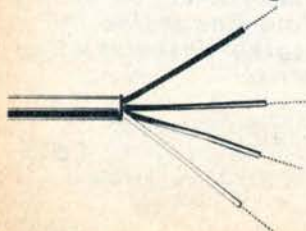

4-core control lead. Each core colour coded for easy installation. Each conductor 0.5 mm², insulated in 6 mm Ø PVC.

15-9261 14P/meter.

Stolle Low-loss UHF Coaxial Cable



Highest quality, colour guaranteed, low-loss cable for UHF and FM installations. Don't ruin your signal with a cheap cable. This cable features 1 mm solid copper conductor, PET foam dielectric, copper screen covered with foil wrap for 100%

shielding and brown PVC outer covering. 7 mm diameter, 75 ohms. Attenuation per 100 meters: 7 dB at 100 MHz, 22 dB at 600 MHz. Made in Western Germany.

15-9260 14P/meter

Attenuators

Used to reduce signal to TV set. FM, VHF or UHF. Necessary when a new station, nearer your home, goes on the air and provides too strong a signal for your aerial. Rather than replace the aerial, fit the attenuator between your set and the input cable.

15-9223 18 dB attenuation ... 55P

15-9224 6 dB attenuation ... 55P

Cable Connectors & Cable Clips



A. Coaxial Cable Plug. Easy to assemble, no solder required. Standard coaxial plug to BS 3041. Polished aluminium alloy, for any cable.

15-9222 TVP2/SP 18P



C. Coaxial Cable Adapter. Back-to-back sockets to join to cable plugs. Nickel plated brass, polypropylene insulation for low loss.

15-9221 TVS5 27P



B. Coaxial Cable Socket. Easy to fit, incorporates a bright zinc plated C-spring for strength. Fits any cable.

15-9226 TVS4 33P



D. Coaxial cable nail-in clips. Plastic body fits 7 mm cable. For indoor or outdoor use.

15-9252 Each: 1P 10 for 7P
Box of 100: **55P**

Masts, Mounts, Lashings and Accessories

Chimney Lashings

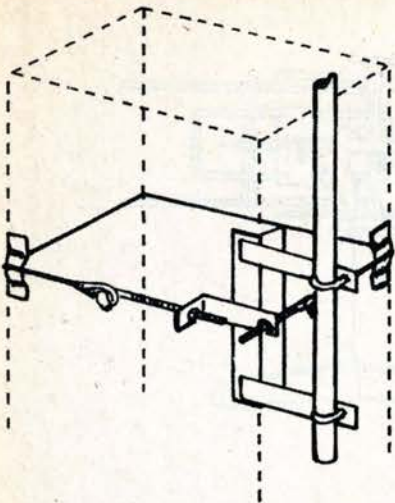

Single chimney lashing kit. For masts up to 32 mm \varnothing . Complete kit with cable, galvanized mount, corner plates, V-bolts. For lightweight aerials.
15-9250 **£1.55**

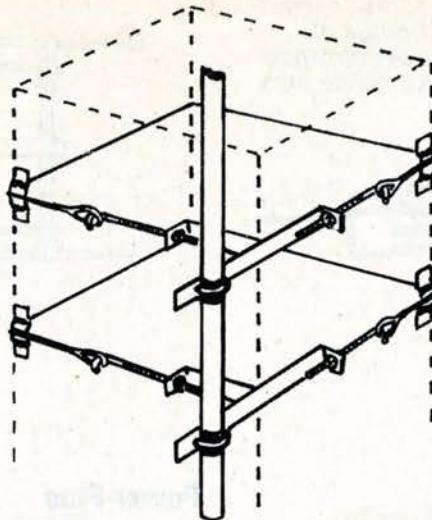

Double chimney lashing kit. For masts up to 50 mm \varnothing . Heavy-duty kit with 2 mounts. Cable, corner plates, V-bolts, all included.
15-9251 **£2.95**

Masts and Base Mounts

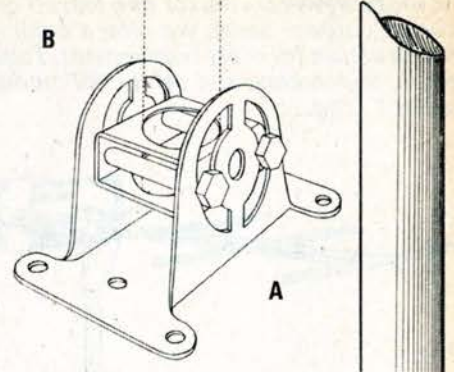

A. Straight, 1.8 m (6') mast, 25.4 mm (1") outside \varnothing , aluminium.
15-9247 **95 P**

A. Straight, 3.65 m (12') mast, 50 mm (2") outside \varnothing , heavy gauge aluminium.
15-9248 **£4.50**

B. Universal base mount. Swivel bracket for wall or joist mounting. Takes mast up to 25.4 mm \varnothing . Excellent for loft use.
15-9249 **49 P**

Antiference „Easimounts“ for Loft and Surface Mounting

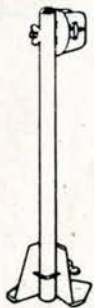

Loft Mount. For mounting outdoor UHF aerials in the loft: Permits aerial to be turned, tilted and rolled. Only 2 wing-nuts to tighten after final adjustment. Aerial clamp fits any boom, base screws into wooden beam.
15-9217 EM-1 **69 P**

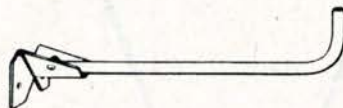

Easimount EM-3. Arm and bracket for surface mounting of small UHF aerials. Provides 37 or 13 cm stand off. 19 mm \varnothing aluminium arm, plated steel bracket. Perfect for window ledge mounting.
15-9218 EM 3 **58 P**

Wall Mounts

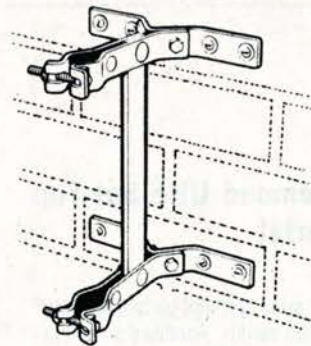

Light duty wall mount assembly. For masts up to 32 mm \varnothing . Holds mast 10 cm from wall. Centre brace for rigidity.
15-9215 **£1.18**

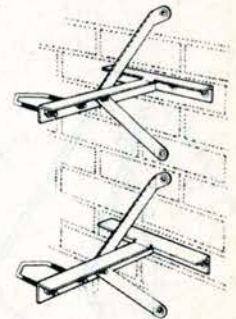

Heavy duty wall mount. For masts up to 50 mm \varnothing . Holds masts 20 cm from wall. Upper and lower struts for maximum strength. V-bolt mast mounting.
15-9216 **£2.77**

Diplexer, Splitter, Aerial Switch, FM Transformer

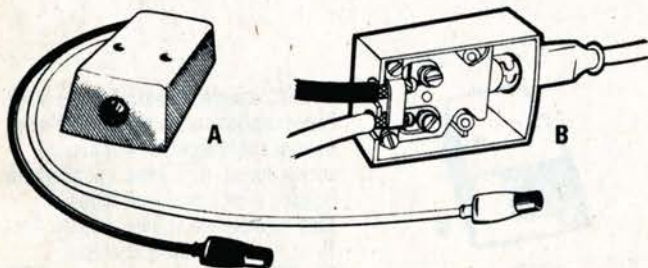

A. VHF/UHF Diplexer. Separate VHF and UHF signals from single down lead. Can be used to separate FM from UHF also. Good for use in buildings with community TV systems. Standard coaxial plug input, 2 colour-coded output cables with coaxial plugs. Mounts to wall or back of set.
15-9225 UF 11 **£1.03**

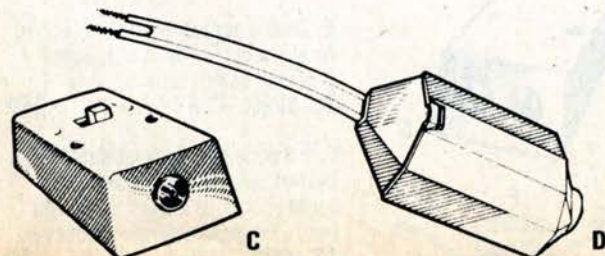

B. Splitter Unit. Divides signal from single aerial to drive 2 TV sets or one TV set and one FM set. Standard coaxial plug input, screw terminals and braid clamp outlets. Place in loft to feed sets in separate rooms. High impact polystyrene case (shown without cover).
15-9220 SB 11 **82 P**

C. Aerial Switch. For switching TV or FM tuner from one aerial to another or to switch one aerial downlead from one receiver to another. Single input/output for standard coaxial plug, double cable connections with screw terminals for switched input/output. High impact polystyrene case with screw mounting holes.
15-9219 AS 11 **£1.26**

D. 75/300 ohms Transformer. Simple, high-quality transformer to match 240/300 ohms input FM receivers to standard 75 ohms coaxial cable, output 300 ohms flat lead.
15-9233 TRR/V **£1.29**

Antiference UHF & VHF Indoor Aerials

For those viewers who, for one reason or another, cannot have an outdoor aerial, we offer a complete range of set-top aerials for every requirement. Tops in performance, design, appearance and safety. All models complete with lead and plug.

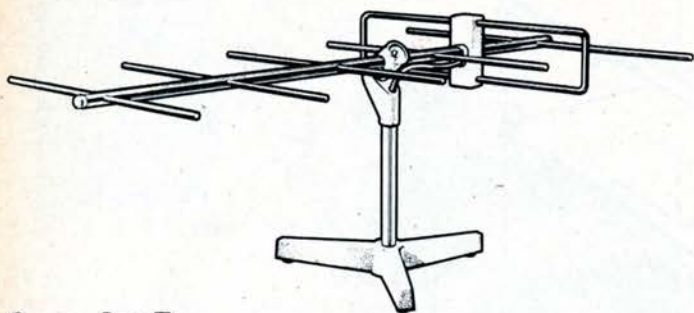

Super Set-Top

For all-programme UHF reception. Britain's most popular set-top aerial. Compact, beautifully styled in cream, white and gold. Easy adjustment (turn, tilt or roll) for horizontal or vertical polarisation.

15.9234	Band A	£2.75
15.9235	Band B	£2.75
15.9236	Band C/D.....	£2.75

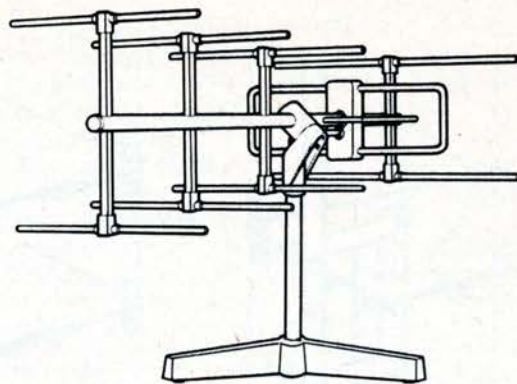

Power-Plus

The latest and most powerful UHF set-top aerial by Antiference: Comprises a powerful multi-element array with double director chain which takes its performance into a new class for set-top aerials. A unique design, superbly styled in cream and gold. Adjustable for horizontal or vertical polarisation.

15.9237	Band A	£4.25
15.9238	Band B	£4.25
15.9239	Band C/D	£4.25

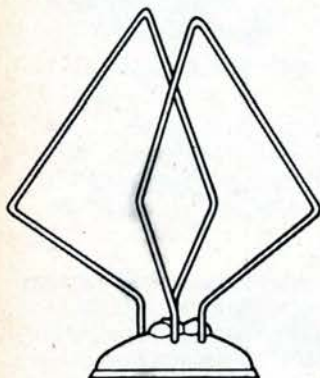

Diamond UHF Set-Top Aerial

Low price but high performance UHF set-top aerials. Anodised silver elements, black base.

15-9245	Bands A/B, Channels 21-51	£1.19
15-9246	Bands C/D, Channels 49-68	£1.19

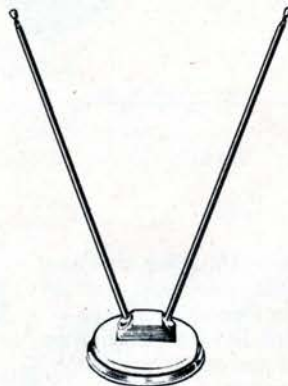

Vantenna FM

Specially designed for FM radio (Band 2). Two-arm aerial in black and silver finish.

15-9214	£2.45
----------------	-------	--------------

Wall Surface and Flush Mount Outlets, Flylead

• For a professional installation!

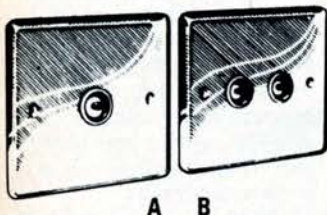

A. Flush mounting single coaxial outlet box. Brilliant white thermoset plastic. Easy cable connections with screw terminals. VHF/FM/UHF all suitable. Requires use of patre box, 15-9232, below.

15-9230	800	59P
----------------	-----------	------------

B. As above, but 2 cable inputs, 2 coaxial socket outputs. Perfect for TV and FM use.

15-9227	805	76P
----------------	-----------	------------

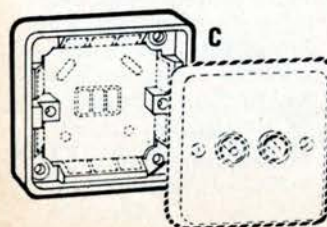

C. Patre Box. Shallow 20 mm deep box in durable white thermoset plastic. For surface or in-wall mounting of flush outlet boxes above.

15-9232	604	14P
----------------	-----------	------------



D. Single surface coaxial outlet box. Easy installation. Screw terminals for coaxial cable input, single coaxial socket output. High impact polystyrene housing with 2 mounting holes. May be attached at base of wall. For TV or FM. Completely enclosed.

15-9231	COB 11	37P
----------------	--------------	------------

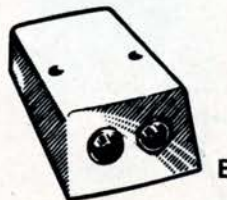

E. Double surface coaxial outlet box. As above but for two cable input, 2 coaxial socket output.

15-9228	COB 12	69P
----------------	--------------	------------

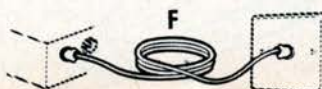

F. 1.8 m Flylead. Fully insulated 1.8 m coaxial cable flylead to connect aerial socket (as above) to receiver input. White. Coaxial plugs both ends.

15-9229	FL600	38P
----------------	-------------	------------

Low-Cost Printed Circuit Accessories and Builder's Components.

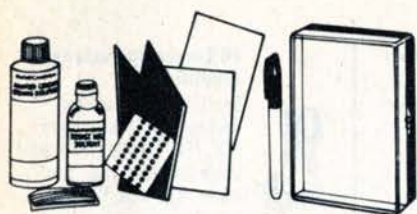

Printed Circuit Kit - Everything you need to build your own PC boards.

- **Design your own circuits!**
- **Great for hobby and experimenter projects!**

Create your own PC boards with this easy-to-use kit. Includes two 11.4x7.6 cm copperclad boards, 56 g glass bottle of resist-ink solvent, 170 g plastic squeeze bottle of etchant, resist-ink pen, one package layout strips and circles, one 38x63 mm scouring pad, 1.58 mm drill bit, one 10.8x15.9x5.7 cm deep plastic box for use as etching tank, instruction sheet. Simply draw schematic on board, immerse in etching solution: the copper not covered by the resist-ink dissolves, leaving circuit design intact. Safe and harmless to use.

276-1576 £ 4.95

Experimenter Perfboards for Easy Component Mounting

- **Tops for modular construction!**
- **Accepts miniature components!**
- **Phenolic & copperclad!**
- **1.6 mm thick - easy mounting!**
- **Breadboard or permanent!**

Patterns for Perfboards

Pattern	Grid Hole Centres	Hole Size
A	6.73x6.73 mm	2.38 mm
B	4.75x4.75 mm	1.58 mm
C	2.54x5.08 mm	1.58 mm
D	2.54x2.54 mm	1.19 mm

Pre-Punched Perfboards

Cat. N°	Pattern	Size	Price each
276-1582	A	92x175 mm	59P
276-1583	A	175x248 mm	£1.09
276-1390	B	114x143 mm	59P
276-1391	B	143x228 mm	£1.09
276-1392 *	C	114x143 mm	79P
276-1393 *	C	143x228 mm	£1.09
276-1394 §	D	114x152 mm	99P

* Alternate Grid § Fits TTL Integrated Circuits

Solid Copper-Clad Boards

Cat. N°	Pattern	Size	Price each
276-1586	E	92x175 mm	89P
276-1587	E	175x248 mm	£1.49
276-1589	E	127x299 mm	£1.59

Pre-Punched Perfboards



Set of 10

Do your circuits quickly and accurately. 1.58 and 2.38 mm hole sizes, straight & alternate grids. Mixed sizes.

276-1575 99 P

Copper-Clad Perfboards

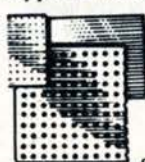

Set of 10

Punched and solid. Just etch out the circuit - install the components. Assorted sizes. Board itself is phenolic. Handy for the experimenter.

276-1580 £1.19



470 cc

Printed Circuit Etchant Solution

- **Takes copper off perfboard completely!**
- **Safe, easy & fast to use!**

A PC „must“ for hobbyists and builders! Special ferric chloride solution removes the copper without damage to board material.

276-1535 £1.69



30 cc

Etch Resist Lacquer

- **With etching brush for drawing circuits!**

Make your own printed circuits on copperclad board! Complete with etching brush.

276-1531 79 P



60 cc

Resist Ink Solvent

- **For use on printed circuit boards after etching process!**

Removes ink, markings, surplus flux, and etching on printed circuit boards.

276-1532 79 P



Resist Marking Pen

- **Black ink!**
- **Dries fast!**
- **Fine point!**

Draw and design your own patterns directly on copper-clad boards. With pocket clip.

276-1530 99 P



Set of 10

Alligator Clips

Strong, positive terminal connections. Teeth pierce connector insulation completely. 35 mm long, phenolic insulation, brass-plated steel, will take high current.

270-1540 99 P

Handy „Push-In“ Terminals

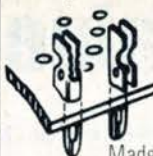

Set of 100

Made for use with pre-punched perfboards. Assure secure terminal connections 1.58 mm

270-1394 £1.39



Set of 20

Solderless Spring Terminals

Gives a strong, positive connection without soldering. Leads slip between the spring coil for a binding contact.

270-1547 £1.19



Pair

Circuit Board Support Brackets

Raise perfboards for component and terminal clearance. All aluminium. 25.4x203 mm.

270-1549 59 P

10-Piece Angle Brackets



- **„Z“ to „L“ shapes!**
- **Positive mounting!**

Five „Z“ and 5 „L“ shapes for easy tube or transistor socket mounting to PC-boards. Metal, with end holes.

270-1548 49 P



Set of 10

Spade Lugs with Jacks

Sturdy and open-ended. Insulated. Handy to have around the workbench. 22.2 mm long. 5 red & 5 black.

270-1541 99 P



Set of 48

Aluminium Spacers

- **Allows easy access to base-mounted components!**

Mixed sizes of 6.3, 12.7, 19 and 25.4 mm spacers. Fits No 2, 4 or 8 screws. Many uses for building!

270-1393 99 P

Fahnestock Spring Clips



Set of 10

- **High-conductive brass!**
- **Ideal for bread-boards!**

Positive, solderless connections. 8 single 19 mm clips, 2 double 38 mm clips. Nickel-plated brass.

270-393 69 P

ARCHER PACKS - Top Value in Parts ... Semi-Conductors!

35 Micro Epoxy Rectifiers



Each rated 1A up to 1 kV. Measures only 6.3x1.9 mm. Silicon type for hobbyist's building projects where limited space is a factor. Assorted voltages. Untested. **276-591**

30 Silicon & Germanium Diodes



Excellent for switching, ultra-high frequency and binary digital in computer and logic designs. Includes 1N5156, 1N914, 1N3712, 1N34, 1N60, 1N447, more. Untested. **276-604**

10 1A Thyristors



Save on a big packet of silicon controlled rectifiers. Includes assortment of voltage ratings up to 100 PIV. TO-18, TO-5 cases, fully insulated against heat damage. Untested. **276-579**

25-piece Transistor Surprise Pack



Includes PNP and NPN silicon and germanium type transistors. Assorted cases: TO-5, TO-18 & TO-46. Perfect for experimenters. Untested. **276-524**

4 Planar Unijunction NPN Transistors



For silicon controlled rectifier drivers, motor-speed control timers. Similar to 2N2646, 2N2840, 2N4852/3. Low leakage. 300 mA peak emitter current. TO-92 case. **276-111**

15 PNP, NPN Transistors



Outstanding assortment of popular transistors: CK722, 2N35, 2N107, 2N440, 2N335 even plastic types! Invaluable to experimenters and hobbyists. Untested. **276-510**

20-piece Zener Pack



Includes uprights, axial lead and reference types in 0.5, 1, 3 watts and higher. Also includes some submini types. Popular voltages. Untested. **276-610**

„P” & „N” Channel FETs



Values in field effect transistor package. High Z input. 250 MHz. „P” similar to 2N4360, 2N5033. „N” similar to 2N3819, 2N3865. Acts like a tube in audio circuits. TO-92 case. **276-112**

4 Type 2N107 PNP Transistors



One of the most widely used transistors for all general audio applications. Complete with base wiring diagram for easy installation. **276-501**

20 Epoxy Silicon Rectifiers



Most widely used rectifiers at a fantastic low cost! Up to 2.5 amps, assorted voltages. Supplied with long leads. Perfect for hobbyists and experimenters. Untested. **276-582**

4 Power Rectifiers



Handy assortment. Ideal for applications with low voltage transistor or battery power supplies. Two 12A, two 50A. Up to 50 PIV. Tested. **276-594**

4 NPN Type 2N3641 Epoxy Transistors



Specially designed for radio frequency amplifiers and high current switching. Replaces HEP50, HEP55, MPS6514, etc 1 watt max. **276-608**

12 Epoxy Rectifiers 3A



Heavy duty leads. Replaces „stud” types. Assorted voltages. Untested. **276-599**

5 Type 2N170 Transistors



General Electric's popular NPN transistors for hundreds of radio frequency applications. Specifications: 25 mW, 6 BVco, 20 hfe. Great for experiments! **276-574**

12 Silicon Power Rectifiers



For low-cost general applications in workshop, industry, etc. 2-12 amps. Up to 600 PIV. Untested. **276-508**

4 NPN Transistors, 40W



Silicon transistor type 2N3055 hobby grade. Maximum specs: 40 watts, 3A. Up to 60 Vceo. Gain up to 20. TO-3 case. Tested. **276-592**

4 PNP 2N3638 Epoxy Transistors



For line-driving, memory circuits, computers, audio amplifiers. Replaces types HEP716, MPS2638, more. 300 mW, 25 BVco, 25 hfe, 100 MHz. **276-606**

30 Silicon Zener Diodes, 1W



Today's best value! Mini and micro glass diodes include 4, 6, 9, 12, 15 & 24V units. Axial leads. Excellent where transistor power supply regulation is required. Untested. **276-521**

8-piece Dual Inline „IC” Kit



Seven ICs plus adapter. Gates, buffers, adders, registers, flip flops, etc. 14 and 16 pin DTLs and TTLs. For computer digital uses, experiments, etc. Untested. **276-531**

25 Germanium Diode Surprise Pack



Used in computer switching, general applications. Similar to 1N34, 1N60. Excellent for builders, hobbyists and experimenters. Untested. **276-519**

5 PNP Power Transistors, 10W.



Can be used where higher wattage rating transistors are necessary. Similar to type 2N155. TO-3 case. Tested. **276-527**

30-piece Semiconductor Surprise Pack



Assortment of silicon and germanium rectifiers, NPN & PNP transistors, powers, zeners, top-hats, diodes, more. Untested. **276-545**

15 Plastic NPN Transistors



Top value experimenter's package. Includes many types similar to 2N2711, 2N2712, 2N2923. For radio frequencies, oscillators, intermediate frequencies. TO-98 cases. Untested. **276-590**

3 Programmable Unijunction Transistors



Silicon types rated 40V, 375 mW. For SCR triggering, oscillators, pulse and timing circuits. Typical rise time: 40 nanoseconds. TO-92 case. **276-119**

10 Linear Operational Amplifiers



Special factory purchase. Package may include types 709, 710, 711, 301, 555, even phase lock loops, etc. Dual inline, mini-dips, flat packs and TO-5 case styles. Untested. **276-611**

5 CK722 Transistors



One of the most popular PNP transistors. Great for any general-purpose hobby or experimenter application. TO-5 case. Made by General Electric. **276-572**

5 Silicon Control Switches



A „must” for any hobbyist! Rated 1A. Colour-coded voltages: 15, 30, 60, 100, 150V. For any SCR application. TO-18 cases. **276-571**

4 Power Tab Transistors, 35 W



Two PNP and two NPN types with built-in heatsinks. 3 isolated leads. Maximum specs: 20 Vceo, 50 hfe, 2A. Similar to 2N6124-26 and 2N2621-3. Tested. **276-626**

4 Readout & Display Driver Transistors



Popular silicon NPN devices used in many counting systems like nixie-type digital readouts, LED readouts (MAN-4) and others. 300 mW power dissipation. 140V BVcbo. 200 hfe. TO-18 case. **276-613**

4 Pancake Photo Cells



Only 7.94 mm square. Ideal in microcircuits for the detection of light. Dark to light resistance range: 30 k to 200 ohms. Cadmium sulphide. **276-677**

10 1N914 Switching Diodes



One of the fastest switching diodes: 4 nanoseconds. Axial leads. PIV: 90V. IF: 10. VF: 1. Untested. **276-612**

Fantastic Choice for Clubs, Hobbyists, Schools, Laboratories

99 P/packet
5 for £4.45



60 Precision Resistors
Great assortment of 1% tolerance resistors for use in critical electronic equipment. Values up to 1 megohm and wattages of 0.125, 0.5, 1 and 2. Includes magnetic-film types.
271-819



3 „MOSFET“ Transistors
Popular single and dual gate types. One each of 3N128, 3N140 & 3N187. High gain, low noise, used in VHF/UHF circuitry. μ ohms, 10k average. With specifications. TO-72 case, 4 leads. Tested.
276-628



6 Micro-Miniature Pots
Potentiometers designed to snap directly into printed-circuit mounting. Values: 100, 250 ohms, 5k, 25k, 50 kOhms, 1 Meg. Includes knob types too. Rated 0.125 watts.
271-201



20 Power Resistors
Contains vitreous, canohm and wire-wound types. Power ratings range from 2 to 20 watts. Ideal for servicemen, hobbyists, builders.
271-1202



4 Magnetic Reed Switches
Ideal for counting instruments, scanners, limiting switches, alarm systems, etc. Rapid cycling. Contacts rated 1A at 250V AC/DC. Size: 82.5x4.7 mm.
275-026



8 Volume Controls
Assortment of most popular values - ranging up to 1 Megohm. Includes dual types, long and short shaft sizes. Some have switch.
271-127



38 m of Hookup Wire
Assortment consists of five 7.6 m rolls of wire. Some stranded, some solid coils. For repairmen, hobbyists, kit builders.
278-025



30 Square Disc-Type Capacitors
„Thin plate“ design. Ideal for printed circuits. Assorted values from 0.0001 mF to 0.01 mF. Some as small as 6.3 mm square.
272-1574



60 Preformed Disc Capacitors
Precut at the factory! Hundreds of printed circuit applications. Snap in and solder. Variety of values from 0.0005 to 0.01 mf. Voltages to 5kV. Great for the experimenter.
272-624



35 Radio & TV Knobs
Indispensable to repairmen and hobbyists! Selection of sizes, most popular types, with and without shafts. Great bargain!
274-1564



35 Resistors, 1W
Hundreds of uses. Contains Allen Bradley and IRC carbons, with 5% values included. Colour coded. Long axial leads.
271-1576



40 Miniature Resistors
World's smallest 0.25 watt carbon resistors. All with axial leads. Made for transistor and subminiature circuits. Assorted values. With resistor colour-code chart.
271-1574



8 Electrolytic Capacitors
Assortment of vertical and axial types. Capacitances range from 5 to 100 μ F. Assorted working voltages. Ideal replacement for service stock or for hobbyists.
272-1571



55 Resistors, 0.5 Watt
Made by Allen Bradley and IRC. Many are 5% & 10% tolerance. Colour chart included. Most popular resistance values. Indispensable to hobbyists and kit builders.
271-1612



45 Plugs and Sockets
Ideal bench assortment for repairmen, Hams, hobbyists. Sub-miniature and printed circuit types included.
274-1562



7 Slide Switches
Excellent assortment for hobbyist and builder. Contacts rated 3A at 220V AC or better. PC and lug terminal connections. Made in the USA.
275-404



5 Transistor Pots
Printed circuit mounting type. Linear taper. Immersion-proof. Screwdriver adjust from top. Ideal for transistor work. 0.5 watt rating. Assorted values. 12.7x12.7 mm. With 3 leads.
271-1621



25 Polystyrene Tubular Capacitors
Hermetically sealed, stable, lightweight. Direct replacement for Mylars and micas used in TV, radio circuits. Assorted values & voltages. Axial leads.
272-618



4-piece Magnetic Reed Kit
Designed for use in alarm systems, position indicators and other equipment. Includes 19, 31.7 and 50.8 mm reed switches, horseshoe magnet and flux keeper.
275-202



30 Moulded Capacitors
Variety of capacitance values and working voltages. Includes Mylars, dipped types, porcelain, oil filled, polystyrene. Upright and axial lead types.
272-622



40 Coils and Chokes
Great assortment of RF, Oscillator, IF, parasitic, peaking and many more highly useful types. Ideal for servicemen, hobbyists, kit builders.
273-1569



40 Terminal Strips
Wide variety of screw and solder-lug type terminal strips with one to six lugs. 101 uses for the builder and experimenter. Ideal for repair stock.
274-1555



5 Micro Pots
Made by Allen Bradley. Type „G“. Includes shaft, screw driver, lock nut types. Values up to 1 Megohm. Linear taper, panel mounting. Threaded bushing (less mounting hardware). Solder-lug terminals.
271-203



10 „Mini“ Reed Switches
SPST type. Ideal for burglar alarm systems & micro circuitry involving mechanical relay functions. Glass length: 28.5 mm. Overall length: 38 mm.
275-1550



20 Mylar Capacitors
Sprague tubulars in assorted sizes, voltages and capacitances up to 1 μ F. Long axial leads. For kit builders and experimenters.
272-1565



75 Preformed Resistors, 0.5W
A fine assortment of carbon resistors in most popular values; tolerances of 5 and 10%. Colour coded. Ideal for printed and subminiature circuits.
271-820



45 Tubular Capacitors
Quality tubular capacitors in capacitances from 100 pF to 0.1 μ F. Working voltages up to 600V. Includes moulded paper, porcelain and Mylar types.
272-1568



60-piece Resistor Special!
Wide assortment of most popular values. Contains 20 0.25W, 30 0.5W, and 10 1W types. With both axial and preformed leads for easy printed circuit mounting.
271-821



8 Assorted Electrolytics
Excellent for radio and TV repairs. Includes FPs, plug-ins, tubulars, as well as double and triple units. Offers an assortment of working voltages and mountings.
272-1570



40 Disc-type Capacitors
A varied assortment of types. Includes NPOs, Hi-Q, N750s and ceramic. You get capacitance values from 10 pF to 0.01 μ F in working voltages up to 6 kV. Long and short leads.
272-1567



Heat Shrinkable Tubing
Contains 20 pieces. Just slip tubing over wire splice and heat with a match or soldering iron. Tubing shrinks 50% at 135°C.
270-1166



Variable Capacitance Tuning Diodes
100 kHz to 100 MHz. For FM oscillators, etc. „Varactors“ replace mechanical variable capacitors. Variable from 15 to 60 pF. Bias voltage: 0 (15 pF) to 20V (60 pF).
272-1345

NOW You Can Replace OVER 15,000 TRANSISTORS at TANDY - Your Solid-State Headquarters

WE'RE THE ONE-STOP SHOP FOR ALL YOUR ELECTRONICS NEEDS
REPAIR, REPLACEMENT, HOBBY, PROJECTS, EXPERIMENTS!

Outstanding assortment of 29 low-cost ARCHER Transistors REPLACE ABOUT 15,000 DIFFERENT TYPES! All are brand-new, first-quality - NOT "fall-outs" - NOT "rejects": Each is individually packaged with

data and pin connections included. It's the biggest selection of transistor replacements for radios, TV, amplifiers and other uses by servicemen, builders, schools and hobbyists!

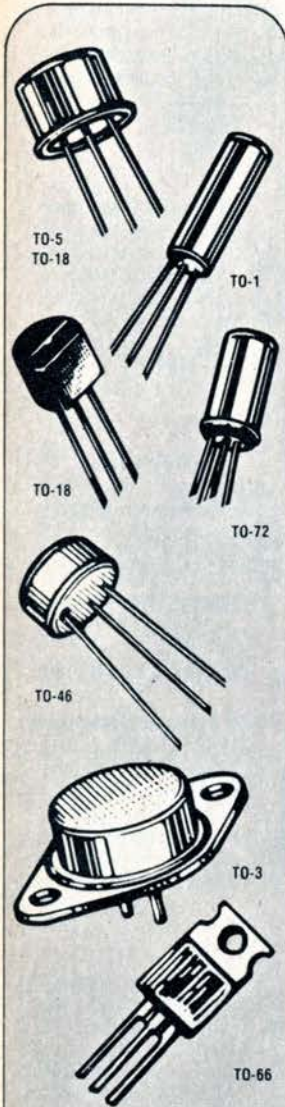

TYPE	APPLICATION	CASE	REPLACES	CAT. N	PRICE £
GERMANIUM					
NPN	2N1304. Gen. purpose amplifier & high switching application	TO-5	2N440, 2N635, 2SC75, 2SC90, ECG101, HEP641	276-2001	65P
NPN	Gen. purpose audio amplifiers, auto radios, preamps and low-level outputs	TO-1	2N97, 2N145, 2N183, HEP641, 2N164	276-2002	80P
PNP	Small signal audio, mixer, oscillator, converter, RF & IF amplifier (AM radio)	TO-1	2N414, 2N534, 2N624, HEP1, HEP3, HEP34	276-2003	80P
PNP	Gen. purpose audio amplifier for radios, preamps & low-level audio amp outputs	TO-1	2N186, 2N262, HEP250, HEP253, 2SB100, SK3003	276-2004	70P
PNP	Gen. purpose audio amplifier for radios, preamps & low-level audio amp outputs	TO-1	2N39, 2N191, HEP251, HEP254, 2SB496, SK3004	276-2005	70P
PNP	Power audio amplifier, audio output in most car radios	TO-3	2N155, 2N350, 2N401, HEP230, SK3014, 2SB138	276-2006	£ 1.29
PNP	2N1305. Gen. purpose amplifier, high freq. for computer and switching applications	TO-5	2N1284, 2SB39, ECG158, HEP629, SK3005	276-2007	65P
SILICON					
NPN	2N5058. Gen. purpose amplifier, audio output, rated 1 W but can be heat sunk to 5 W	TO-5	2N3439, 2N3499, 2SC66, ECG154, SK3045	276-2008	99P
NPN	2N2222. Gen. purpose amplifier, high speed, medium switching	TO-18	2N718, 2SC55, 2SC68, ECG123A, SK3018, HEP55	276-2009	59P
NPN	2N2484. Low level, low noise, high gain	TO-18	2N957, 2SC17, 2SC68, ECG123A, HEP50, SK3020	276-2010	65P
NPN	2N918. VHF and UHF amplifier, freq. up to 500 MHz	TO-72	2N917, 2N3291, 2SC54, ECG108, HEP709, SK3018	276-2011	£ 1.19
NPN	A5T5058. High-voltage inverters, voltage regulators (Epoxy)	TO-18	2SC42M, 2SC481, 2SD121, ECG128, SK3024	276-2012	89P
NPN	T1S97. General purpose low frequency audio amplifier - 360 mW	TO-18	2N5088, 2N4410, 2SC67, ECG107, SK3020, HEP726	276-2013	60P
NPN	2N5449. Med. power amplifier for Class B audio outputs, hi-fi drivers	TO-18	2N3402, 2N6343, A5T3904, ECG123A, HEP57, SK3018	276-2014	60P
NPN	2N4996. High frequency for tuner & IF stages in FM & AM/FM stereo multiplex receivers (Epoxy)	TO-18	2SC17, 2SC79, 2SC127, ECG108, HEP56, SK3018	276-2015	60P
NPN	A5T3904. General purpose, switching & amplifier applications	TO-18	2S005, 2S101, 2SC55, 2SC134, ECG123A	276-2016	59P
NPN	SP8918. Audio power output 15 watts, freq. 20-20,000 Hz	TO-66	2N5190, 2N5296, 2SC496, ECG153, HEP703, SK3054	276-2017	89P
NPN	TIP29. Power amplifier, high-speed switching, rated at 2 W but can be heat sunk to 30 W	TO-66	2N4921, 2SC496, 2SC509, 2SC789, ECG152, HEP246	276-2018	£ 1.09
NPN	TIP33. Power amplifier, high speed switching, rated at 3.5 W but can be heat sunk to 80 W	TO-3	2N5034, 2N5035, 2SC496, 2SC768, 2SD81	276-2019	£ 1.79
NPN	TIP3055. Power amplifier, high-speed switching, rated at 3.5 W but can be heat sunk to 90 W	TO-3	2S033, 2SC708, 2N3055, GE19, HEP56, SK3036	276-2020	£ 1.79
PNP	2N2907. Gen. purpose amplifier, high-speed med. power switching	TO-18	2N722, 2SB24, HEP52, SK3004, ECG159	276-2021	59P
PNP	2N2605. Small signal amplifier, low level, low noise, high gain	TO-46	2N1256, 2SB24, 2SB56, HEP52, SK3004, ECG159	276-2022	75P
PNP	A5T2907. Gen. purpose amplifier, high speed, med. power switching	TO-18	2N1257, 2SB79, 2SB56, ECG159, HEP52, SK3004	276-2023	49P
PNP	2N5447. Med. power amplifier, Class B audio output & hi-fi driver	TO-18	2N3702, 2N3638, ECG159, HEP57, SK3025	276-2024	60P
PNP	SP8919. Audio output 15 W, freq. 20-20,000 Hz	TO-66	2N5193, 2SA473, 2SB435, ECG153, HEP702, SK3021	276-2025	89P
PNP	TIP30. Power amplifier & high-speed switching, free air 2 W, heat sunk to 30 W	TO-66	2N4918, 2SA489, 2SB435, ECG153, HEP246	276-2026	£ 1.39
NPN	TIP34. Power amplifier & high-speed switching, free air 3.5 W, heat sunk to 80 W	TO-3	2SA489, 2SA496, ECG183, MJE2901, 2SA509	276-2027	£ 1.99
NPN	A5T3821. "N" channel FET, small signal, VHF amplifier & mixer, high-speed commutator & chopper applications	TO-18	2N5949, 2SK24, 3SK23, ECG133, HEP801, HEP5007	276-2028	79P
NPN	2N4891. P-N unijunction transistor, industrial timing & triggering circuits	TO-18	2N2160, 2N2646, HEP310, 2N4841, 2N4871	276-2029	89P
NPN	2N3050. Medium power high current switching	TO-39	2N656, 2N1218, 2N1479, SK3024, HEP243, 2N4917	276-2030	59P
NPN	2N3565. General purpose amp., small signal, low noise, high gain	TO-106	2N4286, 2N4287, 2N4967, HEP55, ECG123	276-2031	39P
PNP	2N3638. General purpose medium power amp., high current	TO-105	2N2695, 2N2696, 2N3829, 2N4402, 2N5041, HEP716, ECG129	276-2032	49P
NPN	2N3643. Medium power amp., high current switching	TO-105	2N2960, 2N2961, HEP3736, ECG108	276-2033	49P
PNP	2N3906. General purpose, small signal, medium power switch	TP-92	2N3251, 2N3251a, 2N5447, ECG106, HEP715	276-2034	59P

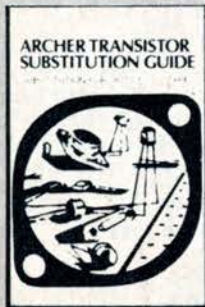

Transistor Substitution Guide
Lists up to 15,000 types, foreign and domestic.
276-2000, 96 Pages, 99 p.

Integrated Circuits for Hobbyists and Experimenters

Popular Dual In-line Integrated Circuits



Quadruple 2-Input Positive NAND Gate. No 7400. For high-speed digital applications. Diode-clamped inputs minimize transmission line effects and low output impedance.

276-1801 **49P**

Hex Inverter. No 7404. For high-speed general purpose applications where noise margin and relatively low power dissipation are important system considerations.

276-1802 **59P**

Dual J-K Flip-Flop. No 7473. High speed-power efficiency and high output drive. For general purpose digital applications.

276-1803 **89P**

Nixie Driver. No 7441. Incorporates high-performance output transistors designed for driving gas-filled cold cathode indicator tubes for readouts, counters, etc.

276-1804 **£ 1.79**

BCD-to-7 Segment Decoder/Driver. No 7447. For frequency counter readouts, digital voltmeter readouts, etc. Also monitors analog voltage with appropriate A/D converters. Has lamp intensity modulation capability.

276-1805 **£ 2.09**

Quadruple Latch. No 7475. Designed for use as temporary storage for binary information between processing units and input/output or indicator units.

276-1806 **£ 1.29**

Triple 3-Input Positive NAND Gate. No 7410. Designed for high-speed general purpose digital applications. Diode-clamped inputs and low output impedance.

276-1807 **49P**

Wide assortment of the most popular types made by top US manufacturers. Ideal for hundreds of projects and experiments. All are guaranteed 100% electrically and mechanically and come complete with diagrams and specs.

Decade Counter. No 7490. May be used in three different modes: 1, binary decimal counter; 2, symmetrical divide by 10 counter; 3, divide by two or divide by 5 counter.

276-1808 **£ 1.09**

Dual 4-Input Positive NAND Gate. No 7420. For high-speed general purpose digital applications. Has diode-clamped input, low output impedance and short propagation delay time.

276-1809 **49P**

Quadruple 2-Input Positive NOR Gate. No 7402. For high-speed general purpose digital applications where noise immunity and low power dissipation are desired. Diode-clamped inputs. Average propagation delay: 12 nanoseconds.

276-1811 **49P**

Dual 4-Input Positive NAND Buffer. No 7440. Use to drive lines between equipment, operate small relay or lamps, or as clock driver. Features input clamping diodes.

276-1812 **49P**

Dual J-K Flip-Flop. No 7476. Incorporates separate pre-sets, clears and clocks. Clock pulse controls inputs to master section, and also regulates coupling between master and slave sections.

276-1813 **89P**

Monostable Multivibrator. No 74121. Designed for DC triggering from both positive and gated negative going pulses. Pulse length can be varied from 40 ns to 40 sec. with external timing circuits.

276-1814 **89P**

IC Socket Adapters

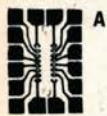

Set of 2



Dual In-Line IC Sockets

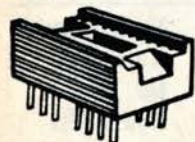

Set of 2

Jumbo Integrated Circuit Assortments



24 pieces per pack.

A. Dual In-line. For 14 and 16 pin ICs. Two mounting holes 31.7 mm apart. Copper clad. 53.9x38.1x1.5 mm. Mounts easily.

276-024 **69P**

B. TO-5. For 8 and 10 pin ICs. Copper clad. Two mounting holes 28.5 mm apart. Overall size: 55.6x38.1x1.5 mm.

276-028 **69P**

Choice of 14 or 16 pin styles. Designed for easy mounting of ICs on any chassis.

Size: 20.6x12.7x14.3 mm. Phenolic body.

276-027 14-pin **89P**

276-030 16-pin **79P**

Wide selection of RTLs, DTLs, etc. Dual in-lines, flat packs and TO-5 packs. Many uses in laboratory or repair shop. (Untested).

276-602 **£ 2.29**

Consists of TTL linear amplifiers, BCD drivers, flip-flops, quads, registers, etc. 14 and 16-pin dual in-line. (Untested).

276-625 **£ 2.35**

Linear Operational Amplifiers



TO-5



Dual In-Line

All popular types. Each has many uses for builders and hobbyists. All are guaranteed 100% electrically and mechanically.

703 RF-IF Amplifier. Ideal for amplifiers, harmonic mixtures or oscillators. Frequency to 150 MHz. High stability, limited gain. Single silicon chip in TO-5 case.

276-008 **79P**

709C. Popular amplifier used in linear circuits, analog computers, relay drivers, etc. Has 250 mW power dissipation, 9-15 volts input. Circuit combines functions of 15 resistors and 15 transistors. Choice of TO-5 case or dual in-line package.

276-017 TO-5 Case **59P**

276-1739 Dual in-line **59P**

723 Voltage Regulator. Has positive and negative regulation of 0-40 volts, 800 mW, 150 mA output. Adjustable current limiting, remote standby current drain. Low temperature, high ripple rejection. Choice of TO-5 case or dual in-line package.

276-009 TO-5 Case **£ 1.09**

276-1740 Dual in-line **£ 1.09**

741C. Frequency compensated version of 709C. High gain, wide bandwidth and low DC offset. Use in telemetry, instrumentation, data processing, etc. 500 mW power dissipation. 15 volt input. Choice of TO-5, dual in-line or mini-dip package.

276-010 TO-5 Case **89P**

276-1741 Dual in-line **89P**

276-007 Mini-dip package, 8 leads **89P**

Dual 741. Features two 741 operational amplifiers combined in a single "Mini-Flip" package. Frequency compensated. Offers high gain, wide bandwidth. Input offset voltage less than 1 mV.

276-038 **£ 1.09**

RTL Types



Fairchild 914 Dual 2-Input Gate. Widely used by experimenters. Used to build audio generator, DC meter amplifier, 2 and 4 channel mixers. Vcc: 4.5-5.5 volts, TO-5 case.

276-015 **59P**

Fairchild UL923 J-K Flip-Flop. Provides alternate conductance and non-conductance of two opposing stages. Use in digital control applications. TO-5 case with 8 leads.

276-023 **59P**

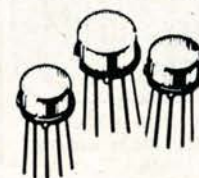

Popular "BIG-3" ICs 709C - 741C - 723

Big savings on a real experimenter special! Package consists of one each 709C, 741C and 723 operational amplifiers.

276-039 **£ 1.95**

Type 555 IC Timer

1001 uses! Times from 1 microsecond to 1 hour. Can be used as a time delay, oscillator, pulse detector, power modulator. Completely resettable. Operates from 5 to 15 V. Enclosed in an 8-pin "mini-dip" package. Similar to Signetics 555.

276-1722 **99P**

LM-309K Voltage Regulator

Popular type for use with ICs. Provides fixed 5V regulator, precision voltage and current regulator. Employs internal current limiting, thermal shut-down and safe area compensation - makes circuit blow-out-proof. Input: 35V max. Output: 5V at 1A. TO-3 case.

276-1830 **£ 1.79**

LM-565 Phase-Lock Loop

Ideal for filter and demodulation applications in 0.001 Hz to 500 kHz range. Contains voltage controlled oscillator, phase comparator, amplifier and low pass filter (similar to SE/NE 565). Power dissipation: 300 mW. Current drain: 812 mA. 5-12 volt supply. Input impedance: 10k ohms. 14 pin dual in-line package.

276-1720 **£ 2.59**

1 Watt IC Audio Amplifier

• Delivers 1W audio power into 8 ohm output!

• Operates from single 9V battery!

• 30-15,000 Hz!

Type TAA300. Circuit combines 11 transistors, 14 resistors and 5 diodes. Features high gain and low power consumption for highly efficient operation. Wide 30-15,000 Hz frequency response provides amplification for voice or music. Mounted in TO-5 package with 10 leads. Operates from a 9V battery (not included). Input impedance: 10,000 ohms.

276-016 **£ 2.99**

Diodes, SCRs, Heat Sinks, Rectifiers & Transistors

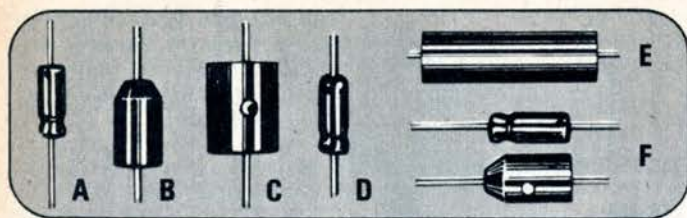

A. Micro-Miniature 1A Diodes

Epoxy diodes for power supply needs.

276-1101	50 PIV	3 for	34P
276-1102	200 PIV	3 for	55P
276-1103	400 PIV	3 for	79P
276-1104	600 PIV	3 for	£1.09

B. 1A Bullet Type Diodes

276-1135	50 PIV	2 for	25P
276-1136	100 PIV	2 for	39P
276-1137	200 PIV	2 for	49P
276-1138	400 PIV	2 for	79P
276-1139	600 PIV	2 for	99P

C. 3A Bullet Type Diodes

Great buys for the experimenter!

276-1141	50 PIV	2 for	39P
276-1142	100 PIV	2 for	53P
276-1143	200 PIV	2 for	79P
276-1144	400 PIV	2 for	99P

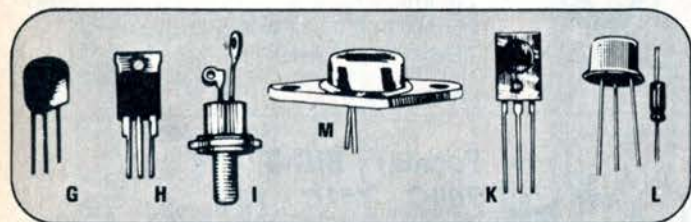

Silicon Controlled Rectifiers

1 Amp, 100 V. For low voltage relay switching, latching and counting circuits. Ideal for your introduction to these devices. 276-1059 Figure G. 89P

6 Amp, 200 V. Electrically isolated. High current, voltage control with high gate sensitivity. Ideal for temperature controls. Use as a light dimmer or speed control on series AC motors. 276-1067 Figure H. £1.95

High power for use in electroplating, 0.25 horsepower motor controls, etc. Three terminal, three junction thyristor can also be used for dimming lights and as a high speed unidirectional switch. 276-1086 6 Amp, 200V. Figure I. £2.09
276-1068 25 Amp, 200V. Figure I. £2.29

Quadrac. Electrically isolated. Use to replace relays, work as a light dimmer, high-

Transistor Sockets



Set of 6

Eliminate loss or damage of transistors. Printed circuit or chassis mounting. Takes transistors with contacts in-line or triangle. With mounting clips. 9.5x6.3 mm. 276-548 99P

D. 2500 mA 1000V Diode

Ideal for builders and experimenters. Only 6.3x4.7 mm, yet better than many bullet types much larger in size. Silicon rectifiers rated at 2.5A. Use in linear amplifier supplies or any circuits requiring high current and voltage. 276-1114. 3 for £1.25

E. 1500 mA 2000V Diode

Ideal for high voltage, high current rectifier circuits. Extra long axial leads for easy hookup. Great for use in linear amplifier power supplies. 276-1105 £1.49

F. Sixty 1A Epoxy Rectifiers

An experimenter's delight! Pack contains 30 micro-miniature and 30 bullet type. Use in transistor low voltage power supplies, micro circuitry. Buy now at this great price and start building that project! (Untested) 276-1164 £1.79

speed motor control or high-speed unidirectional switch. Can also be used in a variety of computer circuits. 276-1083 5 Amp, 200V. Figure H £2.19

Sensitive Gate - 4 Amp, 30V. Use in burglar alarm systems, temperature, light, motor speed control applications, warning systems and switching circuitry. Peak forward surge of 30A. Gate trigger voltage, 0.2V to 0.8V. Anode voltage, 7V. Case type TO-77. 276-1079 Figure K. £1.19

Triac. Basic component to make a light dimmer. Includes diagrams. Figure L includes trigger diode. 276-1080 6 Amp, 200V. Figure L £1.49
276-1084 8 Amp, 200V. Figure H £2.19
276-1085 25 Amp, 200V. Figure I £3.29

6 Amp, 200V. Most popular SCR type used today. Compact TO-66 case. Ideal for use as a light dimmer, speed control, other projects. 276-1087 Figure M. £1.59

Power Transistor Sockets



Set of 2

Designed to fit any TO-3 case. Spring contacts in brass-cadmium, moulded nylon top. Threads for mounting. 276-029 35P

6 Amp Full-Wave Bridge Rectifiers



- Heavy duty leads!
- Highest quality!
- 14.3 x 14.3 x 4.7 mm

Cat. No	PIV	Price
276-1146	50	99P
276-1148	100	£1.19
276-1147	200	£1.49
276-1149	400	£1.59

2 Amp Silicon Full-Wave Bridge Rectifiers



- TO-5 epoxy case!
- Only 4.7 x 6.3 mm!

Cat. No	PIV	Price
276-1151	50	59P
276-1152	100	89P
276-1153	200	99P
276-1154	400	£1.09

Light Activated Silicon Controlled Rectifiers



- Visible/invisible sensing!

Combines a light-sensitive silicon photo electric sensor and silicon controlled rectifier in a TO-18 case. 1 Amp. 276-1082 60 PIV 79P
276-1081 200 PIV £1.29



Set of 10

Pack of Glass Diodes

Excellent for those electronic projects! Similar to 1N34, 1N34A and 1N60 types. Excellent value. 276-821 89P



50 Silicon Diodes

Ideal for binary logic or use in RF switching circuits, low voltage regulators, RF and field test equipment. (Untested) 276-114 £1.69



Selenium Solar Cell

- Power small motors, radios, relays, using sunlight!

Produces 0.5V at 0.6 mA under strong light. With leads plus instructions for light-powered radio, relay, oscillator. Size 38x3.2 mm. 276-115 99P



Cadmium Sulphide Photo Cell

Sensitive in the yellow-green range of the light spectrum. 5 million ohms max. resistance, 100 ohms min. Maximum voltage 170V; maximum wattage 0.2 watts. Size 12.7x6.3 mm. 276-116 59P

Silicon Rectifiers



12 AMPS

Use in linear amplifier supplies, general purpose supplies, car ignitions.

Cat. No	PIV	Price
276-1060	50	45P
276-1061	100	59P
276-1062	200	89P

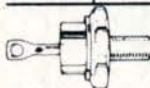

50 AMPS

Heavy-duty for high power applications. High current rating. For industrial use.

Cat. No	PIV	Price
276-1040	50	74P
276-1041	100	89P
276-1042	200	99P

0.5 W Zener Diodes



Set of 2

Ideal for most low voltage applications.

Cat. No	Normal Voltage	Price/Set
276-620	4	55P
276-621	6	55P
276-622	9	55P
276-623	12	55P

1 Watt Zener Diodes



Set of 2

For voltage references, transistor bias switches, etc. Axial leads.

Cat. No	Normal Voltage	Price/Set
276-560	4	69P
276-561	6	69P
276-562	9	69P
276-563	12	69P

Heat Sinks for Protection



Set of 5

Spring-loaded 63 mm heat sinks with magnetic bases. Also 35mm and 63 mm straight and bent jaw types. 276-001 £1.39

Single-Fin Sinks



Cat. No	Hole	Rad. Surface	Price
276-1356	6.7 mm	144 cm ²	79P
276-1358	55 mm	144 cm ²	79P
276-1360	Blank	216 cm ²	89P

Mounting Hardware for Heatsinks

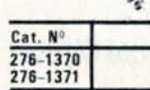

Cat. No	For Case	Price
276-1370	TO-3	25P
276-1371	TO-66	25P

Heat Sink Assortment



Set of 6

Popular assortment of 6 press-on-cooler heat sinks for TO-5 transistors, power and SCR types. 276-003 £1.09

Top Quality LEDs and Digital Displays at Real Bargain Prices

Miniature Light Emitting Diode

- High brightness-1500 fl at 20 mA!
- Solid-State lamp!
- Wide viewing angle!
- TO-106 case style!
- Unlimited life span!

Visible bright-red light source. Made of Gallium Arsenide Phosphide. Forward voltage: 1.6-2.3V at 50 mA; reverse voltage: 3V. Can be driven from the collector of a transistor or from integrated circuit outputs. Bonded in plastic encapsulant. Ideal for experimenters for use as panel lights, circuit indicators, alphanumeric displays, film annotations. Complete with data sheet.

276-026 £99P
276-040 As above, but with frosted lens. £99P

Subminiature Light Emitting Diode

- High brightness solid-state lamp!
- For panel light, circuit indicator, etc.!

Designed to emit visible bright-red light when forward biased. Forward voltage: 1.6 V at 20 mA. Radiant power output: 15 uW at 20 mA. Reverse voltage: 3V. Made of Gallium Arsenide Phosphide. Comes complete with data sheet.

276-042 £89P
276-044 As above, but bright green. £99P

Diffused Lens Light Emitting Diode

- Virtually unlimited life span!
- Ideal as on/off power indicator!

Visible red light source made of Gallium Arsenide Phosphide, encapsulated in a plastic package. Average brightness: 23 fl at 20 mA. Forward voltage: 1.75V at 20 mA. Reverse voltage: 3V. Circuitboard mountable. Complete with data sheet.

276-041 £99P
276-043 As above, but bright green. £99P

7-Segment Incandescent Digital Readout Displays

- Wide viewing angle!
- Easy to read displays!
- Low power consumption!

Plugs into standard dial in-line IC socket. Reads displays of 11.1 mm high by 6.3 mm wide. Temperature range: -55° to +70° C. Voltage per segment: 5V. Current per segment: 15 mA. 120° viewing angle. Ideal for hobby projects using digital displays. Directly compatible with TTL integrated circuits. Size: 22.1x12.7x5.08 mm.

276-051 £2.49

NEW 7-Segment LED Digital Readout Displays

- Easy to read 7.6 mm digits!
- Continuous uniform segments!
- Extra-wide viewing angle!

High reliable LED readout displays all digits plus a decimal point. Plugs into 14-pin dual in-line socket. Ideal for calculators, instruments, digital clocks - almost any purpose. Compatible with 7447 decoder driver. Voltage per segment: 1.6V at 20 mA.

276-053 £3.49

7-Segment LED Digital Readout Displays

- Equal to type MAN-3!
- Wide viewing angle!
- Up to 250,000 hours life!

Displays all digits and 9 letters 2.9 mm high. Known as the „claw“. Encapsulated in red epoxy. Shock resistant. Compatible with TTL IC 7448. Ideal for calculators, instruments, digital clocks and other devices requiring highly reliable displays.

276-054 £2.35

7-Segment LED Digital Readout Displays

- Equal to MAN-4 unit!
- Wide viewing angle
- Up to 250,000 hours life!

Displays all digits and 9 letters. Each segment is 4.8 mm high. Fits standard 14-pin IC socket. Encapsulated in red epoxy. Shock resistant. Compatible with TTL integrated circuits 7446, 7447, 7448. Ideal for calculators, instruments, digital clocks and other devices requiring high reliability displays.

276-052 £3.49

Transistor Pack Specials! For Hobbyists, Builders!

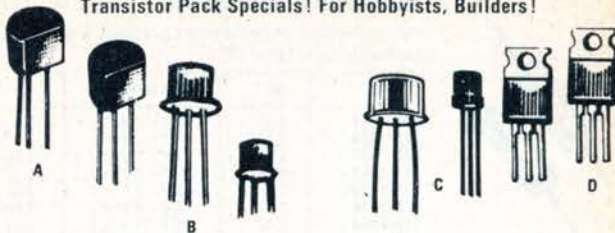

A. 24-piece Epoxy „Quad“

Includes 6 each NPN and PNP high frequency, low noise transistors and 6 each NPN and PNP medium power audio transistors. Tested.

276-530 £ 1.69

B. 16-piece Silicon "Quad"

Four each NPN, PNP high gain/low noise, and 4 each medium power PNPs and NPNs. From 360 mW to 800 mW power dissipation. Case styles TO-5, TO-18, TO-46. With data, plastic container. Tested.

276-532 £ 1.69

C. 40-piece "Twin-Pack"

Assortment of plastic-housed transistors may include FETs, TO-1, TO-9, TO-18 and other cases. Types: CK-722, 2N107, 2N170, etc. RF and audio uses. Untested.

276-1516 £ 1.59

D. 30-Watt Power Transistors

Ideally suited for audio output stages, bull horns, PA systems. Plastic tab case interchangers with TO-66 type. One is similar to D40D1/2/3, 2N4921. The other is similar to D41D1/2 and 2N4918. Data included.

276-117 £ 1.49

Miniature Tube Sockets

Set of 5

Especially useful when building receivers, transceivers, television sets and stereo FM-AM radios. Saddle mounting to chassis for dependable connection.

274-1511 7-pin 49P

274-1512 9-pin 49P

Space Saver Sockets



Set of 5

Great when using one chassis for the power source and the other for the circuit... such as pre-amp and amplifier. Taps off 220V AC from the source chassis to the circuit chassis.

270-642 74P

3.5 Watt IC Audio Amplifier



- 10 Watts peak power
- Frequency response, 30-100 kHz!
- Full power into 16 ohm load!

Made by General Electric. Delivers 3.5 watts continuous power into a 16 ohm load. Operates from 9 to 30V. Designed for PC use. Has 8 leads plus 2 heatsinks. Output is a quasi complementary push-push. Ideal for mono and stereo record and tape players, FM/AM/TV receivers. Complete with data.

276-629 £1.69

Jumbo Transistor Surprise Pack!

100 pieces

- Silicon • Audio • Germanium
- Plastic • RF • PNP and NPN
- High gain • All US-Made

One of the widest assortments available! Includes high frequency, high power types, FETs, duals, Darlingtons and different amplifiers. Case styles include TO-92, TO-98, TO-5 plastic, plus many metal cases. Use for handy replacement, or perform transistor projects. Made by Raytheon, G.E., etc. (Untested).

276-544 £2.59



TOP-VALUE SURPRISE PACK

Loaded with assorted parts... if purchased separately would cost many times more than our selling price. Includes: printed circuit boards, IF transformers, Mylar, dipped, mica, polystyrene/capacitors, resistors, coil forms, transistors, rectifiers - also includes some integrated circuits!

270-1251 £1.39

Tubular, Ceramic, Electrolytic & Tuning Capacitors

Tubular Capacitors

Built to endure high humidity and temperature. Leakproof, non-flammable case. 250 V DC.

Cat. No	μF	Size (mm)	Price
272-1051	0.01	14.2x7.9x4.7	2 for 45P
272-1056	0.022	14.2x7.9x4.7	2 for 45P
272-1057	0.033	14.2x7.9x4.7	2 for 45P
272-1052	0.047	14.2x7.9x4.7	2 for 49P
272-1053	0.1	15.8x7.9x4.7	2 for 49P
272-1058	0.22	15.8x9.5x6.3	2 for 55P
272-1054	0.47	14.2x11.1x4.7	each 55P
272-1055	1.0	30.1x12.7x9.5	each 59P

Printed Circuit Capacitors

Extremely small, high quality, non-inductively wound. High dielectric strength and rugged construction. Perfect for transistor circuits.

Cat. No	μF	Size (mm)	Price
272-1065	0.01	12x8x4	2 for 39P
272-1066	0.022	12x8x4	2 for 39P
272-1067	0.033	12x8x4	2 for 39P
272-1068	0.047	12x8x4	2 for 39P
272-1069	0.1	12x11x6	2 for 42P
272-1070	0.22	18x10x6	2 for 59P
272-1071	0.47	25x12x7	each 59P

Ceramic Disc Capacitors

High efficiency, ultra-compact ceramic disc capacitors with moisture-proof coating. **3 for 29P**

Cat. No	pF	Price	Cat. No	pF	Price
272-120	5	29P	272-125	470	29P
272-121	47	29P	272-126	1000	29P
272-123	100	29P	272-130	5000	29P
272-124	220	29P	272-131	10000	29P

Ferrite Loop Antenna Coil

A high-quality ferrite core unit suitable for transistor, tube or crystal radios. Sensitive high-Q antenna matches all tuning condensers in the broadcast band. Includes mounting bracket and hardware. 50x12.7 mm.

270-1430 76P

Variable Loopsticks

General replacement in small radios and experimentation and construction, or similar circuits. Smoothly-variable core tunes to be compatible with 365 pF tuning condenser. Centre-tapped for convenient application.

270-376 89P

2.5 Millihenry RF Choke

Axial leads for easy wiring. Rated at 125 mA. High reliability design for a variety of applications in receivers and transmitters. Quality made for long, dependable use.

270-1713 49P

A. Subminiature Wafer-Thin Capacitor

Dozens of uses. Integrates perfectly with most AM radio circuits - 365 pF. Gives smooth rotation, accurate mesh. Interleaved insulation prevents shorting between plates. 25.4 mm square, 15.9 mm deep. Shaft, 6.3 mm \varnothing , 25.4 mm long.

272-1341 79P

B. Miniature Tuning Capacitor with Calibrated Dial

For experimenter-built transistor TRF radios. Easy-to read plastic dial calibrated from 530 kHz to 1600 kHz. Smooth, solid „feel“. Minimum capacity at full clockwise position, maximum at full counterclockwise position. 25.4x25.4x12.7 mm.

272-1431 79P

C. General Purpose, Single-Gang Variable Capacitor

Solid aluminium stator and rotor blades reduce noise, resist corrosion. Bakelite insulation insures large capacitance with no shorting. Smooth ball-bearing operation. Counterclockwise rotation 9.6 to 365 pF. 38x33x48 mm. Shaft 38 mm long, 6.3 mm \varnothing .

272-1344 99P

4 kV Trigger Coil

• **Ideal for electronic Xenon flash tubes!**

Primary discharge voltage: 300 V; secondary voltage: 4000 V. Comes complete with specifications and diagram. Use with No 272-1145, below.

272-1146 79P

Electronic Xenon Flash Tube

• **Ideal for strobe light or photo flash!**

Most popular type used in electronic strobes. Ideal replacement - especially for low-cost psychodelic strobes. Max. anode voltage: 300 V. Min. anode voltage: 200 V. Min. trigger voltage: 4 kV. Approximate life: 8000 flashes. Use trigger coil No 272-1146.

272-1145 £ 1.69

Printed Circuit Electrolytic Capacitor Pack

• **Most popular values, types!**
• **Packed in handy plastic boxes!**
• **Rated at 35 V DC!**

Assortment of most popular types and sizes of printed circuit type electrolytic capacitors. These are all brand-new, first-quality capacitors packed in a plastic box for easy handling and storage. All are rated at 35 WV DC. The set of fourteen consists of three each 5 μF & 10 μF ; two each 25 μF , 50 μF , 100 μF ; one each 200 μF , 500 μF .

272-1035 £ 2.39

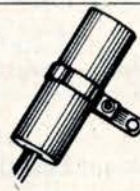
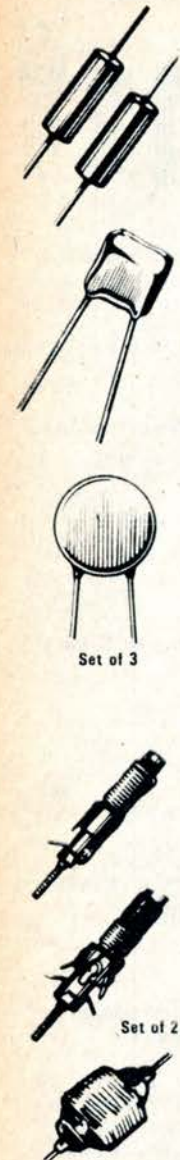

Tubular Electrolytic Capacitors

Tubular electrolytic capacitors designed for service replacement applications, experimenters, hobbyists. *Two sections in one capacitor, three leads.

Cat. No	μF	WV DC	Size (mm)	Price each
272-101	20	150	17.5x44.4	74P
272-103	20	450	23.8x44.4	89P
272-104	40	450	27x60.3	99P
272-106	50x30*	150	22.2x57.1	89P
272-107	50x50*	150	22.2x57.1	£ 1.19
272-108	80x50*	150	25.4x63.5	£ 1.19

Non-Polarized Electrolytics



Ideal for speaker crossover networks, by-pass applications or low frequency tuned circuits. Axial leads. All rated at 50V DC.

Cat. No	pF	Size (mm)	Price each
272-996	1.0	6.3x20	49P
272-997	2.2	6.3x20	55P
272-998	4.7	10x25	59P
272-999	10	10x25	69P
272-1000	47	16x36	79P

Miniature Electrolytic Capacitors

16 WV DC

Cat. No	μF	Size (mm)	Price
272-1001	5	5.5x15.1	2 for 49P
272-1002	10	6.3x15.1	2 for 59P
272-1003	22	7.9x15.1	2 for 59P
272-1004	50	7.9x15.1	2 for 59P
272-1005	100	10.3x25.4	2 for 65P
272-1006	220	10.3x27	2 for 65P
272-1007	500	15.1x23	each 59P
272-1008	1000	18.2x42	each 69P

16 WV DC (PC Type)

Cat. No	μF	Size (mm)	Price
272-951	5	5x12.7	2 for 49P
272-952	10	6x14.3	2 for 54P
272-953	22	8x19	2 for 54P
272-954	50	8x19	2 for 59P
272-955	100	10x20.6	2 for 69P
272-956	220	24x30.1	2 for 79P
272-957	500	13x31.7	each 69P
272-958	1000	18x41.3	each 79P

35 WV DC

Cat. No	μF	Size (mm)	Price
272-1012	5	6.3x15.1	2 for 49P
272-1013	10	7.9x15.1	2 for 55P
272-1014	22	7.9x20.6	2 for 59P
272-1015	50	10.3x25.4	2 for 59P
272-1016	100	18.2x25.4	2 for 65P
272-1017	220	18.2x31.7	2 for 65P
272-1018	550	18.2x42	each 59P
272-1019	1000	22.2x57.1	each 79P

35 WV DC (PC TYPE)

Cat. No	μF	Size (mm)	Price
272-1024	5	6.3x9.5	2 for 49P
272-1025	10	7.9x10.3	2 for 55P
272-1026	22	9.5x11.9	2 for 59P
272-1027	50	9.5x14.3	2 for 65P
272-1028	100	9.5x19	2 for 65P
272-1029	220	15.1x23.8	2 for 79P
272-1030	500	19x41.3	each 65P
272-1032	1000	22.2x57.1	each 79P
272-1020	2200	25.4x66.6	each 55P
272-1021	3300	25.4x96.8	each 59P

50 WV DC

Cat. No	μF	Size (mm)	Price
272-1040	2.2	26.6x15.1	2 for 69P
272-1041	5	27.4x15.1	2 for 76P
272-1042	10	7.9x15.5	2 for 65P
272-1043	50	12.7x27	2 for 79P
272-1044	100	12.7x31.7	each 89P
272-1045	220	15.1x41.3	each £ 2.39
272-1046	500	19.8x41.3	each £ 1.35
272-1047	1000	22.2x66.6	each £ 1.59

Low-Cost Components for Hobbyists and Builders

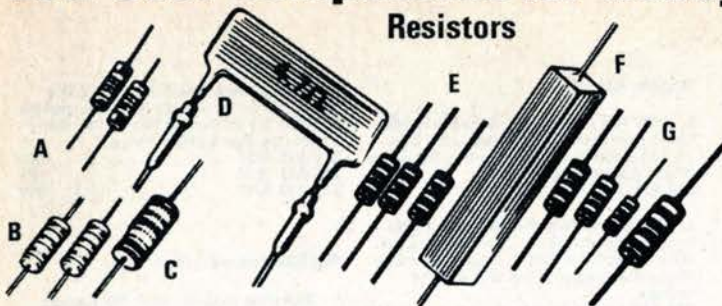

A. 1/4 Watt - Pack of 2 19 P

- Specify resistance value when ordering. (In Ohms)

271-1800 Series					19P
10	330	3900	39k	270k	
15	470	4700	47k	330k	
27	680	6800	56k	470k	
47	1000	10k	68k	680k	
100	1500	15k	82k	1 Meg.	
150	2200	22k	100k		
220	2700	27k	150k		
270	3300	33k	220k		

B. 1/2 Watt - Pack of 2 16 P

- Specify resistance value when ordering. (In Ohms).

271-000 Series						16 P
10	150	1.2k	12k	150k	1.2	
12	180	1.5k	15k	180k	1.5	
15	220	1.8k	22k	220k	1.8	
22	270	2.2k	27k	270k	2.2	
27	330	3.3k	33k	330k	3.3	
33	390	3.9k	39k	390k	3.9	
39	470	4.7k	47k	470k	4.7	
47	560	5.6k	56k	560k	5.6	
68	680	6.8k	68k	680k	6.8	
82	820	8.2k	82k	820k	8.2	
100	1k	10k	100k	1 Meg	10	

C. 1 Watt - Pack of 2 39 P

- Wirewound!
- For transistor circuits!

Cat. No	Resistance	Price
271-072	0.56 ohms	39P
271-073	1.0	39P
271-074	1.5	39P
271-075	3.3	39P

D. 10 Watt Fused - Pack of 2 59 P

- Packaged in sets of two

Cat. No	Resistance	Price
271-147	7.5 ohms	59P
271-148	5.6	59P
271-149	4.7	59P

Resistors

E. 1/2 Watt Pack of 100 £2.59

- Long axial leads!
- All colour-coded!
- Contains 21 values!

Money-saving kit for builders, hobbyists, laboratory or workshop. All top-quality US-made. With plastic storage box for easy handling. Contains 6 each: 4.7 kOhms, 10 kOhms, 100 kOhms; 5 each: 100 ohms, 330 ohms, 470 ohms, 680 ohms, 1 kOhm, 15 kOhms, 220 kOhms, 470 kOhms; 4 each: 15 ohms, 180 ohms, 390 ohms, 22kOhms, 56 kOhms, 120 kOhms, 330 kOhms, 1 Meg; 3 each: 22 ohms, 270 ohms.

271-306 £2.59

F. 10 Watt Power Resistors - Pack of 2 59 P

- Wire wound resistors, axial leads, rectangular ceramic body, 10% tolerance.

271-130	0.47 ohms	271-137	400 Ohms
271-131	1	271-138	500
271-132	10	271-139	750
271-133	50	271-140	1000
271-134	75	271-141	1500
271-135	100	271-142	2500
271-136	250	271-143	5000
		271-145	10000

G. 100 Composition Pack £2.29

- All have long axial leads!

Ideal for the electronic workbench! Colour coded and marked. Includes 1/10, 1/2, 1 and 2 watters. Many 1% and 5%. Carbons, carbofilms, tin oxide, metal film. Great value!

271-810 £2.29

Volume Controls

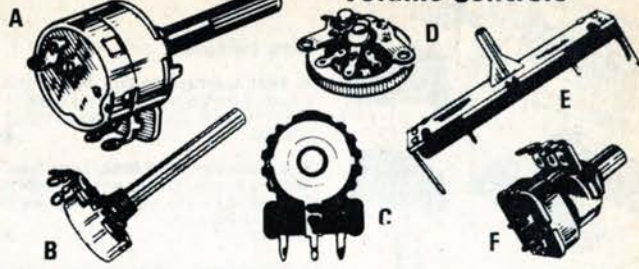

A. Linear Taper

- Shaft size, 50.8x6.3 mm. Mounting hardware included.

Cat. No	Ohms	Price
271-1714	5k	59P
271-1715	10k	59P
271-1716	50k	59P
271-092	100k	59P
271-210	500k	59P
271-211	1 Meg.	59P
271-093	2 Meg.	59P

Linear Taper with SPST Switch

- As above. Switch rated 3A at 220V.

Cat. No	Ohms	Price
271-066	500 ohms	74P
271-1620	5k	79P
271-1443	10k	79P
271-094	25k	74P
271-212	500k	74P
271-213	1 Meg.	74P

B. Audio Taper Types

- Shaft size, 50.8x6.3 mm.
- Mounting hardware included.

Cat. No	Ohms	Price
271-1720	5k	59P
271-1721	10k	59P
271-1722	100k	59P
271-1723	500k	59P

Audio Taper Types with SPST Switch

- As above. Switch rated 3A at 220V.

Cat. No	Ohms	Price
271-1725	5k	69P
271-1726	10k	69P
271-1727	100k	69P
271-1728	500k	69P

C. Printed Circuit Types

- 1/4 Watt
- 260° rotation
- Upright snap-in type

Cat. No	Ohms	Price
271-226	500	35P
271-227	1k	35P
271-228	2.5k	35P
271-217	5k	35P
271-218	10k	35P
271-219	50k	35P
271-220	100k	35P
271-221	500k	35P
271-229	1 Meg.	35P

D. Transistor Radio Volume Controls

- Replacement type

With SPST switch, 15.87 mm dia., 12.7 mm depth, 7.94 mm dia. knob.

271-390 5000 ohms 49P

271-391 10,000 ohms 49P

E. Glide-Path Controls

- Smooth, accurate linear taper.

For breadboard uses. Black bakelite lever. 73x14.29 mm. Solder lug terminals. Also mounts on PC boards.

271-222	5kOhms	99P
271-223	10kOhms	99P

F. Miniature Controls

- Audio taper!
- With DPST switch!

Audio taper, DPST switch. Fits 8 mm hole. Bushing 6.3x4.8 mm. Mounting hardware included. 6.3 mm shaft 9.5 mm long. Size: 15.87x19x25.4 mm.

Cat. No	Ohms	Price
271-214	5 kOhms	74P
271-215	10	69P
271-216	100	74P

Miniature DPDT Relays

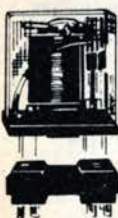

3 Amp contacts.

- Includes mounting socket!

Great for chassis and printed circuit mounting. Silver contacts. 220/240V AC: Resistance, 4400 ohms; current, 20 mA, 31.7x27x20.64 mm. 12V DC: Resistance, 250 ohms; current, 50 mA, 31.7x25.4x19 mm. Solder lug terminals, plastic housing, hold-down clips.

275-205	220/240V AC	£2.59
275-206	12V DC	£2.59

Heavy Duty DPDT Relays



10 Amp contacts.

- Choice of 220/240V AC or 12V DC models

Includes socket and mounting hardware. Plug-in type. Encased in transparent plastic cover. Silver contacts. 52.4x34.6x9.5 mm (less plug).

275-207	220/240V AC	£3.59
275-208	12V DC	£2.99

Pocket Resist-O-Guide



Rotary colour discs show ohms, tolerance of RETMA coded resistors.

271-1200		35 P
----------	--	------

Switch to Tandy for The Right Switch

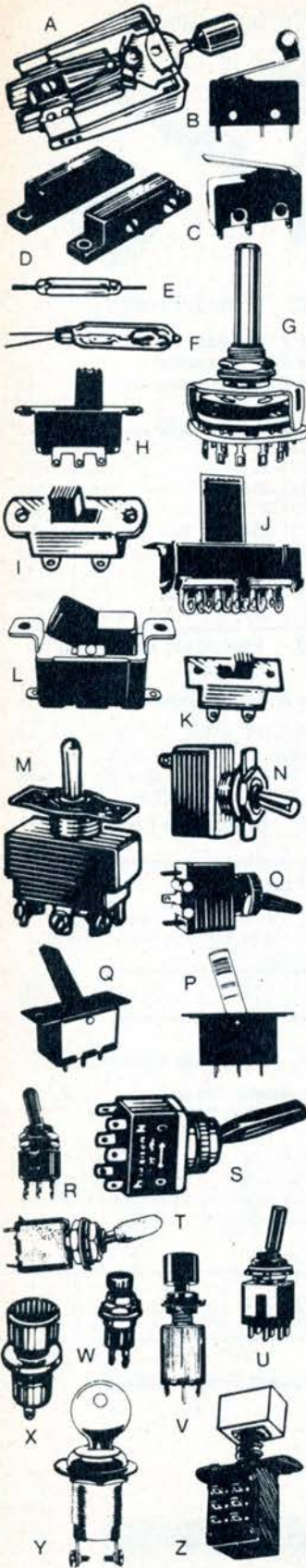

Lever switches

A. 4PDT Anti-Capacity Type. 4 sets of SPDT contacts. 3 locking positions. 25.4 mm handle. 54×7.9×15.9 mm. Contacts rated 5A at 250V AC. 275-600 89P

B. Subminiature SPDT Roller Lever Type. Solder lug terminals. Contacts rated 5A at 250V AC. Lever with 19 mm roller length. Operating force 50 g. Size: 19×8.3×9.5 mm 275-017 79P

C. Subminiature SPDT Lever Type. Solder lug terminals. Contacts rated 5A at 250V AC. Lever length 19 mm. Operating force 45g. 19×6.3×9.5 mm. 275-016 69P

Magnet contact switches

D. SPST Type. Contact is made when magnet is engaged. Normally open. Rated 0.5A at 250V AC. Screw terminals. 275-495 £1.49

E. Miniature Reed Switches. Contacts rated at 0.5A at 250V AC. Normally open. Ideal for alarms, limiting switches, scanners, counting. Size: 3.18×28.6 mm. 275-032 59P

Mercury switches

F. Glass Type. Long connecting wire leads. 1A contacts. Size: 41.3×7.94 mm. 275-027 SPST 69P
275-028 SPDT 79P

Rotary switches

G. 4-Pole, 2 Position. Contacts rated 0.3A at 250V AC. Requires 9.5 mm mounting hole. With washers and mounting nut. 1 gang. 275-1384 - 50.8 mm shaft, 6.3 mm Ø 59P
Single-Pole, 12 Position. Shorting. 275-1385 - 35 mm shaft, 6.3 mm Ø 59P
2-Pole, 6 Position. Single deck. Non-shorting. Shaft length 31.7×6.3 mm. 275-1386 69P

Slide switches

H. Set of 2 Switches. Solder lug terminals. Black button. 4A at 250V AC. Sizes: 25.4×35×15.9 mm. 275-401 SPST 33P
275-402 SPDT 35P
275-403 DPDT 35P

I. Switch Kit. Consists of 1 SPDT, 1 DPDT, 3 SPST, 1 DPST. Rated 0.5A at 250V AC. Size: 12.7×22.2×31.7 mm. 275-327 99P

J. 4PDT Miniature Panel Mount Type. Contacts. 0.3A at 250V AC. Black button. Size 31.7×9.5×14.3 mm. 275-405 49P

K. Subminiature Type. Contacts rated 0.3A at 250V AC. Black button. Mounting hole centres 19 mm. Size: 15.9×6.3×6.3 mm (less lugs). 275-406 SPST 35P
275-407 DPDT 35P

Illuminated Switches

SPST Pushbutton Type

Push on/off operation. Button lights in „on“ position. Lamp built into push handle. Contacts rated 10A at 250V AC. Solder lug terminals. With mounting hardware. 31.7×12.7×47.6 mm. Bushing 9.5×11.1 mm. 275-671 £1.99

Rocker switches

L. SPST Flip Action Type. Requires rectangular 19×15.9 mm mounting hole. Contacts rated 6A at 250V AC. Solder lug terminals. Mounting hole centres 30 mm. With mounting hardware. 275-611 Size: 22.2×12.7×12.7 mm. 59P

L. SPST Heavy-Duty Positive Action Type. Requires rectangular 33.3×12.7 mm mounting hole. Contacts rated 10A at 250V AC. Solder lug terminals. Mounting hole centres 35 mm. With mounting hardware. 275-610 Size: 28.6×15.9×15.9 mm. 79P

L. Kit of 1 SPDT and 1 DPDT. Contacts rated 3A at 250V AC. Solder lug terminals. 275-030 95P

Toggle switches

M. Centre-Off Heavy Duty DPDT. Set of 2. Long bat handles. Rated at 10A at 250V AC. On/off plate, screw terminals, mounting nut. Size: 19×35×35 mm. 275-1533 £1.49

N. Standard. Bakelite, 3A at 250V AC. On/off plates, lug terminals. 11.9 mm shank. Bat handles. Requires 11.1 mm mounting hole. 275-602 SPST 59P
275-666 DPDT 59P

N. Switch Kit. Set of 3 (1 DPDT, 2 SPST). With bat handles, on/off plates, solder lug terminals. 3A at 250V AC. Requires 11.1 mm mounting hole. 275-322 £1.29

O. Standard Type. Black insulated bat handles. Contacts rated 3A at 250V AC. With mounting hardware. Solder lug terminals. Size 20.64×14.29×15.87 mm; bushing 7.9×11.1 mm. 275-606 SPST 69P
275-604 SPDT 79P
275-605 DPDT 99P

P. DPDT Lever Type. Flush mounting. 19 mm baton handle in brushed aluminium. Contacts rated 3A at 250V AC. Mounting hole centres 30 mm. Solder lug terminals. 23.8×15.9×14.3 mm. 275-607 99P

Q. DPDT Lever Type. Tapered black handle. 22.2 mm long × 7.9 mm wide. Flush mounting. Solder lug terminals. Contacts rated 3A at 250V AC. Mounting hole centres 30 mm. With mounting hardware. Size: 23.8×15.9×12.7 mm. 275-608 79P

R. Miniature SPDT Type. Contacts rated 5A at 250V AC. 15.9 mm bat handle. 11.1×9.5 mm bushing. Lug terminals. Body 15.9×9.5 mm. Mounting hardware included. 275-603 79P

S. Lever Type. 25.4×9.5 mm black lever. Rated 6A at 250V AC. Bushing 12.7×9.5 mm; body 23.8×15.9×15.9 mm. 275-651 SPST 99P
275-654 SPDT £1.29
275-652 DPDT £1.09
275-653 DPDT Red lever, neutral centre...£1.49

T. Subminiature Type. Rated 10A at 250V AC. Solder lug terminals. 19 mm bat handle. 12.7×11.1×12.7 mm. All with 4 coloured insulators for handles. 275-324 SPST £1.09
275-326 SPDT £1.09
275-325 SPDT Neutral centre £1.09
275-1546 DPDT £1.19
275-1545 DPDT Neutral centre £1.49

U. Subminiature Type. Contacts rated 3A at 250V AC. Solder lug terminals. 4 coloured insulators for handle. 5.5 mm mounting hole required. Handle 9.5 mm long. Size: 9.5×6.3×9.5 mm. 275-612 SPST 89P
275-613 SPDT 89P
275-614 DPDT 99P

Pushbutton switches

V. Miniature Push-On/Push-Off. Contacts rated 6A at 250V AC. Solder lug terminals. Requires 5.5 mm mounting hole. Screw-on black knob. 275-1551 SPST 12.7×9.5×15.9 mm ... £1.49
275-1552 DPDT 12.7×12.7×15.9 mm ... £1.49

V. Subminiature Push-On/Push-Off. Contacts rated 3A at 250V AC. Solder lug terminals. 275-1553 SPST (Red Button) 11.1×6.3×17.5 mm £1.09
275-1554 DPDT (Red Button) 5.5×5.9×17.5 mm £1.19

W. SPST Miniature. Set of 5. Miniature momentary contact type - normally open. 6.3 mm mounting hole required. Solder lug terminals. Red button with black bakelite body - 9.5 mm Ø. Rated 0.5A at 250V AC. 275-1547 £1.09
275-1548 Normally closed. £1.15

X. SPST Push-On, Push-Off Type. Requires 12.7 mm mounting hole. Panel mount. Rated 3A at 250V AC. Length 28.6 mm. Solder lug terminals. 275-011 79P

X. SPST Momentary Action Type. Panel mounting. Requires 12.7 mm mounting hole. Contacts rated 3A at 250V AC. 35 mm long. With mounting hardware. 275-609 £1.09

Y. SPST Lock Switch. Ideal for burglar alarm systems. Screw terminals. Mounting hole required 20.6 mm. Contacts rated 2A at 250V AC. Complete with set of keys and mounting hardware. Size 50.8×9.5 mm. Key can be removed in both „off“ and „on“ positions. 275-503 £1.59

Z. Push-On/Push-Off Square Button Switches. Includes mounting template and screws. Rated 3A at 250V AC. Solder lug terminals. 275-1560 SPDT (Black button) 8.7×12.7×19 mm 89P
275-1561 DPDT (Red button) 11.9×13.5×19.8 mm 99P

Auto Panel Switches



AA. SPST. Flip type toggle switch used on many automobiles. Heavy duty. Contacts rated 5A at 12V DC. Screw terminals. Flexible 25.4 mm lever handle. 275-701 59P



BB. SPST Under Dash Types. Set of 2. Black finish. Flexible 25.4 mm lever handles. Screw terminals. 69.8 mm wide tapered to 54×15.9 mm depth. Contacts rated 5A at 12V DC. With all mounting hardware. On/off plates. 275-702 £1.19

Set of 6.



On/Off Switch Plates
For use with toggle switches having a bushing diameter of 11.9 mm. Keyway on bottom. 275-320 35 P

SPST Rocker Type



Flip action. Contacts rated 10A at 250V AC. Solder lug terminals. Completely enclosed. Mounts flush in panels. Mounting hole centres 36.5 mm. Requires a mounting hole of 28.6×14.3 mm. 275-672 £1.19

SPST Toggle Type



Snap action. Lamp built into handle. End of handle lights in „on“ position. Large 31.7 mm long bat handle. Bushing 12.7×11.1 mm. Solder lug terminals. Contacts rated 10A at 250V AC. 15.9×27×17 mm. 275-670 £1.89

PANEL LAMPS AND ASSEMBLIES, FUSES & FUSE HOLDERS

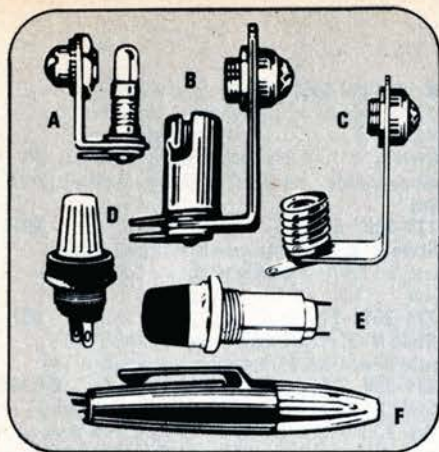

A. Miniature. Set of 3 includes 2 red, 1 green jewel with miniature 6V screw bulbs. Mounts in 7.9 mm hole. **272-344 99 P**

B. Bayonet. Set of 4 includes 2 red, 1 green, 1 amber jewel pilot light assemblies. Standard bayonet socket. Requires 11.1 mm mounting hole. Less bulbs. **272-318 99 P**

C. As above, but with miniature screw base. **272-319 89 P**

D. Miniature Panel Lamp Assemblies. Set includes 2 red, 1 blue jewel assemblies 35 mm long with soldering lugs. For 12.7 mm mounting hole. Complete with 6V screw-in bulbs, mounting hardware. **272-323 89 P**

E. Plastic Dome Assemblies. Set of 2. Removable red and yellow domes. Requires 14.3 mm mounting hole. Includes ring washer and plastic mounting nut. Solder lug terminals. Length: 44.4 mm. Takes mini screw lamp. **272-329 89 P**

F. AC/DC Circuit Tester. Glow indicates „live“ outlets, defective switches, blown fuses and can even locate dirty spark plugs. 90-500 V range. **272-201 59 P**

Neon & Incandescent Lamps.

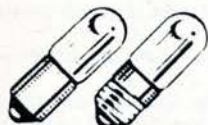

Wide variety of lamps to fill most electronic and general needs. For panels, appliances, cars, flashlights, toys, etc.

Neon Glow Panel Lamps

* High Brightness

Cat. N°	Type	Watts	Series Res.	Price
272-1101	NE-2	0.04	200 k Ohms	2 for 32 P
272-1102	NE-2H*	0.25	22 k	2 for 34 P
272-1103	NE-51	0.04	200 k	2 for 49 P
272-1104	NE-51H*	0.25	22 k	2 for 49 P

Miniature Bayonet Incandescent Panel Lamps, type BA 95

Cat. N°	Type	Volts	mA	Price
272-1108	44	6.3	150	2 for 29 P
272-1109	45	3.2	350	2 for 29 P
272-1110	47	6.3	150	2 for 29 P
272-1111	49	2	60	2 for 29 P
272-1112	1891	14	230	2 for 29 P
272-1113	51	7.5	220	2 for 29 P
272-1114	55	7	410	2 for 29 P
272-1115	1847	6.3	150	2 for 36 P
272-1116	93 §	12	15 CP	each 29 P
272-1117	53	14.4	120	2 for 29 P
272-1118	1815	14	200	2 for 36 P
272-1119	1819	28	40	2 for 43 P

§ „High Intensity“ - Single bayonet contact.

Flashlight Lamps

Cat. N°	Type	Volts	mA	Price
272-1120	PR-2	2.38	500	2 for 37 P
272-1121	PR-3	3.57	500	2 for 37 P
272-1122	PR-4	2.33	270	2 for 37 P
272-1123	PR-12	5.95	500	2 for 37 P
272-1124	222 *	2.25	250	2 for 37 P

* Pre-focus penlight type - screw base.

Miniature Screw Incandescent Panel Lamps - type E-10

Cat. N°	Type	Volts	mA	Price
272-1128	40	6.3	150	2 for 35 P
272-1129	41	2.5	500	2 for 43 P
272-1130	46	6.3	250	2 for 35 P
272-1131	48	2.0	60	2 for 37 P
272-1132	14	2.47	300	2 for 35 P
272-1133	50	7.5	220	2 for 35 P
272-1134	1487	14	200	2 for 37 P
272-1135	1821	28	170	2 for 37 P

Subminiature Pilot Lamps

A. Lamps with long connection leads

Cat. N°	Fig.	Volts	mA	Price
272-1139	A	1.5	25	Each 45 P
272-1140	A	6	25	Each 45 P
272-1141	A	12	25	Each 45 P

B. Screw lamps-Type T-1½ (E-5.5)

Cat. N°	Fig.	Volts	mA	Price
272-1142	B	6	100	2 for 45 P
272-1143	B	12	75	2 for 45 P

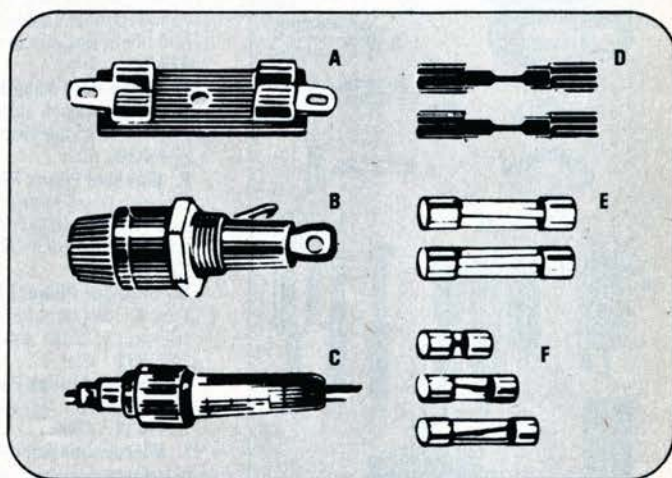

Fuse Holders and Fuses

All 30x6 mm ø.

A. Clip-in Fuse Holders. Set of 2, to hold 30x6 mm fuses. Lug terminal connections. Bakelite construction. **270-739 2 for 59 P**
270-740 2 for 64 P

B. Panel Mount Fuse Holder. For 30x6 mm fuses. Solder lug terminals. 41 mm long. Requires 12.7 mm mounting hole. **270-364 59 P**

C. In-Line Fuse Holder. Fits 30x6 mm fuses. Coil spring assures positive contact pressure. Tinned end leads. For projects, HAM radio, etc. **270-1281 59 P**

D. Slow Blow Fuses:

270-1288	0.25 A	2 for	69 P	270-1286	3 A	2 for	69 P
270-1282	0.5 A	2 for	69 P	270-1289	4 A	2 for	69 P
270-1283	1 A	2 for	69 P	270-1287	5 A	2 for	69 P
270-1284	1.5 A	2 for	69 P	270-1290	10 A	2 for	69 P
270-1285	2 A	2 for	69 P				

E. Fast-Acting Glass Fuses:

270-1270	0.25 A	3 for	49 P	270-1276	3 A	3 for	39 P
270-1271	0.5 A	3 for	49 P	270-1277	4 A	3 for	39 P
270-1272	0.75 A	3 for	49 P	270-1278	5 A	3 for	34 P
270-1273	1 A	3 for	39 P	270-1279	10 A	3 for	34 P
270-1274	1.5 A	3 for	39 P	270-1280	15 A	3 for	34 P
270-1275	2 A	3 for	39 P				

F. SFE Type Auto Fuses:

270-1266	9 Amp	3 for	34 P
270-1267	14 Amp	3 for	34 P
270-1268	20 Amp	3 for	34 P

Connectors and Adapters for Versatility

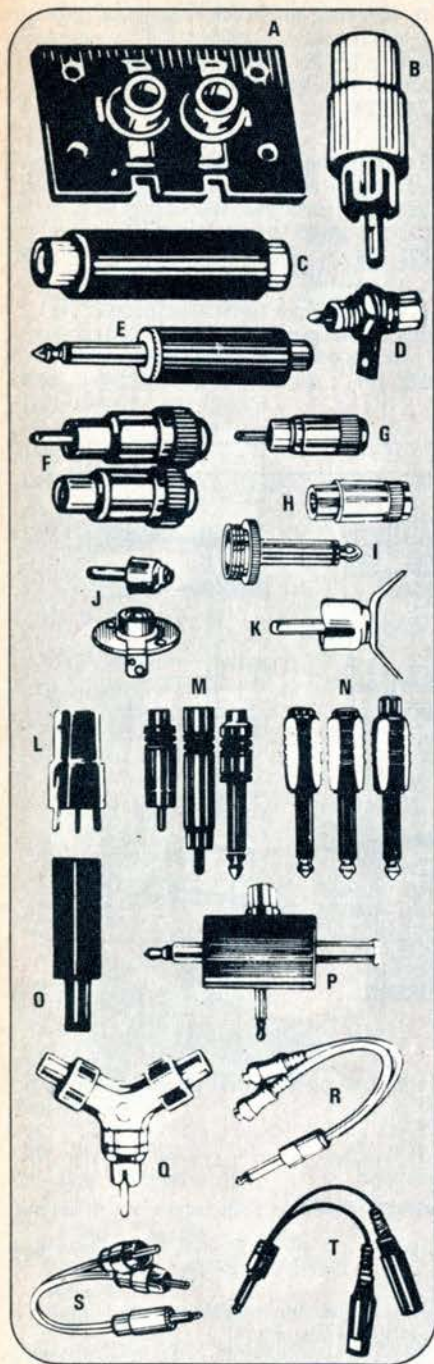

A. Dual Phono Jack. For stereo changers, amplifiers, etc. Accepts RCA-type phono plugs. Provides quick, sure interconnection of audio equipment whose existing connectors do not mate.

274-332 2 for 43P

Quad Phono Jack. Designed to mate with 4 phono plugs. Mounting hole centres: 52.3 mm. Length: 60.3 mm.

274-322 each 43P

B. 2-Conductor Phono Plugs. Plastic insulated handles to prevent any crossover and short circuits. Comes complete with cable clamp to provide strong, positive connections. Assorted colours.

274-321 8 for 99P

C. Dual Phono Jack Couplers. Allows 2 audio cables to be connected using phono plugs. Provides for a clean, strong, positive connection. Perfect for a variety of applications... military, hobby, repairs. 12.7x143 mm.

274-1553 2 for 69P

D. Shielded Phono Jacks. Accepts phono plug. Fits 6.3 mm mounting hole. Solder lug connections assure a durable, clean and positive mating. Shielding assures a reduction of annoying hum. 9.5x9.5 mm.

274-346 4 for 95P

E. Phono Plug Adapters. Inline adapters convert RCA-type phono plug to standard 6.3 mm plug. Provides a quick, positive interconnection. 12.7x73 mm.

274-320 3 for £1.29

F. Shielded Phono Plugs and Jacks. 3 sets of plugs and jacks for audio connections. Positive connections prevent resistive line losses. Shielded to assure reduction of hum. 9.5x23.8 mm.

274-334 3 for 94 P

G. Shielded Phono Plugs. Reduction of hum is assured in this connector that's designed for easier soldering... Mates with all phono jacks.

274-339 4 for 89P

H. Shielded Inline Phono Jacks. Set of 4. Solder lug terminals. Mates with all phono pin plugs.

274-338 4 for 89P

I. Microphone Adapter Plug. Converts single microphone screw-on connector to standard 6.3 mm plug.

274-1558 each 55P

J. Phono Plug and Jack Sets. For use in phonos, amplifiers, recorders, tuners, hifi equipment.

274-1575 8 for 99P

K. Finger-grip Phono Plugs. Wing-tip construction for easy use. For fast component hookup.

274-343 10 for 99P

L. Printed Circuit Phono Jacks. Ideal for mounting phono jacks directly to PC boards. No mounting nuts required! Great for experimenters, hobbyists.

274-347 5 for 55P

M. Plug Adapter Set. Now you can solve numerous connection problems with this handy kit for adapting miniature phone plugs to phono plugs, from phono plug to miniature phone plug, from miniature phone plug to standard 6.3 mm phone plug. Provides strong and positive electrical connection for plug and jacks that do not match.

274-046 3 for £1.49

N. Adapter Sets. Provides strong and positive connection for plugs that do not match your jacks. Each is moulded for long life and noise-free operation.

Style N° 1. For 6.3 mm phone plug to: phono jack, 2.3 mm subminiature phone jack and 3.1 mm miniature phone jack.

274-356 3 for 99P

Style N° 2. For 2.3 mm subminiature plug to: phono jack, 3.1 mm miniature phone jack and 6.3 mm phone jack.

274-357 3 for 99P

Style N° 3. For 3.1 mm miniature plug to: 2.3 mm subminiature jack, 6.3 mm phone jack and phono jack.

274-359 3 for £1.19

Style N° 4. For phono plug to: 2.3 mm subminiature jack, 3.1 mm miniature phone jack and 6.3 mm phone jack.

274-358 3 for 99P

O. Adapter Power Jacks. For use with battery chargers, tape recorders, radios, TV, etc. Each set contains one each of 2.16 and 2.4 mm internal diameter power jacks.

274-1551 25.4 mm long, 5.5 mm outside diameter 2 for 89P

274-1550 35 mm long, 4.9 mm outside diameter. 2 for 79P

P. Four-Way Adapter. Ideal for adapting or mating a miniature plug, subminiature plug, 2.46 mm diameter power jack and 2.15 mm diameter power plug. Parallel wiring.

274-351 each 89P

Q. Shielded „Y” Adapters. 2 phono jacks connected in parallel to a phono plug

274-303 each 69P

Q. Shielded „Y” Adapters. 2 phono jacks connected in parallel to a standard 6.3 mm phone plug.

274-304 each 69P

R. Flexible „Y” Adapters. 2 phono jacks connected in parallel to a standard 6.3 mm plug. Features highest quality wire, soldered connections. Plugs and jacks are moulded directly to various cable combinations.

274-306 each 79P

S. Two standard phono plugs connected in parallel to a miniature phone plug. 228 mm long. Moulded connections.

274-317 each 79P

S. Two standard phono plugs connected in parallel to a miniature phone plug. Moulded connectors. 228 mm long.

274-318 each 69P

T. Dual Stereo Headphone „Y” Adapter. Accepts two pairs of stereo headphones without loss of fidelity. One end has two 3-conductor 6.3 mm phone jacks connected in parallel to 3-conductor 6.3 mm phone plug.

274-319 each £1.89

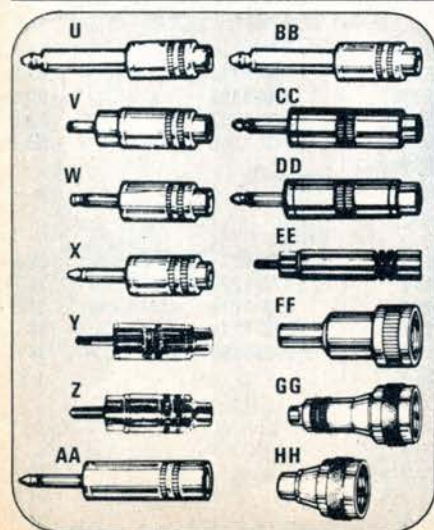

Shielded Plug Adapters

Provide quick, sure interconnection of audio equipment whose existing connectors do not mate. Positive mating contacts prevent resistive line losses. All are shielded to assure reduction of hum.

U. Adapts miniature phone jack to standard 6.3 mm phone plug.

274-325 2 for 69P

V. Adapts miniature phone jack to phono plug.

274-326 2 for 69P

W. Adapts miniature phone jack to subminiature phone plug.

274-327 2 for 79P

X. Adapts subminiature phone jack to miniature phone plug.

274-328 2 for 79P

Y. Adapts phono plug to a subminiature phone plug.

274-354 2 for 79P

Z. Adapts subminiature phone plug to a phono plug.

274-355 2 for 79P

AA. Adapts standard 6.3 mm phone jack to a miniature phone plug.

274-047 2 for 99P

BB. Adapts subminiature phone jack to standard 6.3 mm phone plug.

274-329 2 for 79P

CC. Adapts phono jack to miniature phone plug.

274-330 2 for 89P

DD. Adapts phono plug to miniature phone plug.

274-337 2 for 79P

EE. Phono Plug Adapters. Shielded phono jack at rear connects standard 6.3 mm phone plug to phono plug. Shielding assures a reduction of annoying hum so you can enjoy distortion-free sound. Gives strong, clean and positive connections. 53.9 mm long.

274-389 2 for 89P

FF. Microphone Adapter Plug. Accepts standard 6.3 mm phone plug and adapts it to a standard screw microphone connector.

274-048 each 72P

GG. Adapts miniature phone plug to standard mike connector.

274-049 each 72P

HH. Adapts phono plug to standard mike connector.

274-050 each 69P

Phone Plugs and Jacks for Every Requirement

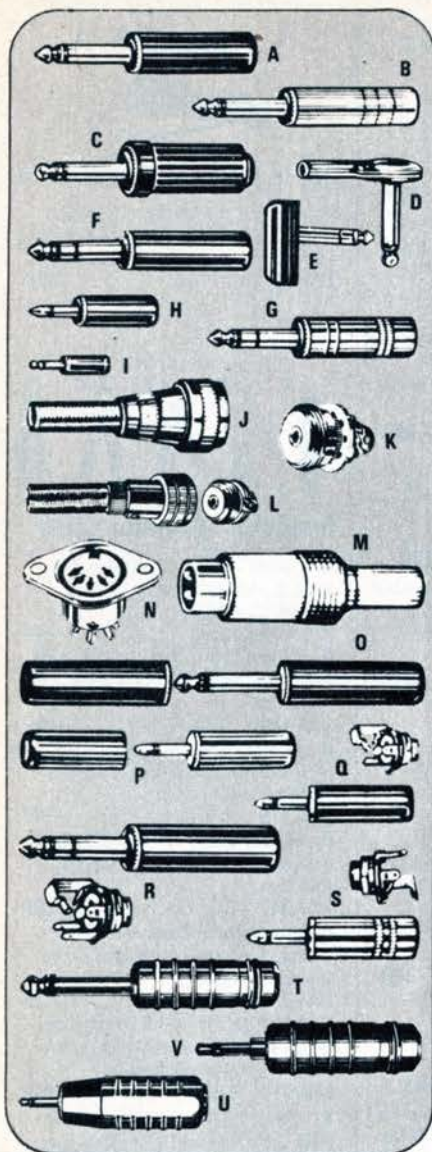

- A. 2-Conductor 6.3 mm Phone Plugs.** Set of 3. Long slim type with 12.7 mm diameter black bakelite barrel, 73 mm long. **274-1536** **89 P**
- B. 2-Conductor 6.3 mm Phone Plugs.** Set of 2. Long slim type with 12.7 mm diameter shielded barrel. 73 mm long. **274-1544** **89 P**
- C. 2-Conductor 6.3 mm Phone Plugs.** Set of 2. Double barrel. Ribbed plastic barrel handle takes cord phone tip or tips. 73 mm long. **274-1539** **89 P**
- D. 2-Conductor 6.3 mm Phone Plugs.** Set of 2. Shielded flat right-angle type. Ideal for space saving applications. 73 mm long. **274-254** **99 P**
- E. Right-Angle 6.3 mm Plugs.** Set of black and red shells. Screw-type terminals. **274-256** 2-Conductor **72 P**
274-257 3-Conductor **89 P**
- F. 3-Conductor 6.3 mm Phone Plugs.** Set of 3. Slim line. Black bakelite barrel. For push-to-talk mikes, stereo headphones. 73 mm long. **274-139** **£1.19**
- G. 3-Conductor Phone Plug.** Shielded type. Barrel 41 mm long. Nickel plated. Solder lug terminals. 73 mm long. **274-285** **95 P**
- H. 2-Conductor Miniature Phone Plugs.** Set of 2. Solder lug terminals. 41 mm long.
274-286 Black **65 P**
274-287 Red **69 P**
274-288 Shielded **85 P**
- I. 2-Conductor 2.4 mm Subminiature Phone Plugs.** Set of 2. Solder lug terminals. 23.8 mm long.
274-289 Black **59 P**
274-290 Red **59 P**
274-291 Tan **59 P**
- J. Microphone Connector.** Standard 15.9 mm inline mike connector. Removable locking nut. Strain relief spring. **274-1560** **59 P**
- K. Chassis Microphone Connector.** Designed to be mounted on a chassis. Mates with female microphone connector (274-1560). Requires 9.5 mm mounting hole. Includes washer, soldering lug and mounting nut. **274-1561** **43 P**
- L. Miniature Chassis and Microphone Connector Set.** Single contact connector. Chrome plated. Mike connector has removable coupling ring for use with either

- female or male mike connections. Chassis connector requires 6.3 mm mounting hole. Complete with washers, solder lug and mounting nut. **274-1557** **69 P**
- M. DIN Type Audio Plugs.** Shielded with snap-on plastic shells. For European tape recorders, mikes, external speakers.
274-004 3-Pin **39 P**
274-003 5-Pin **55 P**
- N. 5-Pin Chassis DIN-Type Connector.** Designed to mate with 3 or 5 pin male DIN type connectors. Solder lug terminals. Mounting hole centres 22.2 mm. **274-005** **39 P**

Phone Plug and Jack Sets

- O. Standard 6.3 mm.** 2 sets of slim phone plugs and inline jacks. One set red and one black for easy identification. **274-1241** **95 P**
- P. Miniature 3.2 mm.** 2 sets. One set black and one red for easy identification. Includes slim phone plug and inline jack. **274-283** **99 P**
- Q. Miniature.** 6 pairs of matching bakelite plugs and jacks. Jacks closed circuit. Ideal for transistor earphones and receivers. Assorted colours. **274-335** **99 P**
- R. Miniature.** 3 pairs of matching shielded phone plugs and shorting jacks. Remote speaker hookups, microphones and other uses. **274-336** **99 P**
- S. 3-Circuit Plug and Jack.** 6.3 mm open circuit jack and plug with black bakelite shell, solder lug terminals, mounting hardware. 2 pairs. **274-323** **£1.19**

Stereo-to Mono Headphone Adapters.

- Handy adapters let you listen to monophonic tape player, transistor radio, television, etc. through stereo headphones. Each has 3-conductor inline phone jack with 2-conductor plug of your choice.
- T. Stereo jack to standard 6.3 mm phone plug.** **274-360** **69 P**
- U. Stereo jack to 3.2 mm submini phone plug.** **274-361** **59 P**
- V. Stereo jack to 2.4 mm mini phone plug.** **274-362** **59 P**

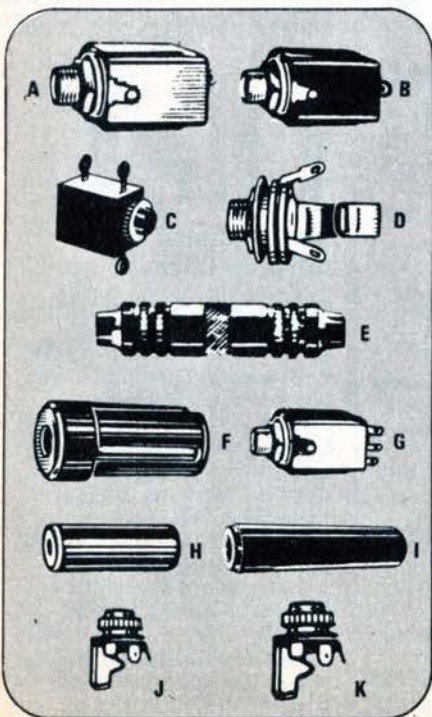

Phone Jacks.

- A. Enclosed 6.3 mm Phone Jacks.** Accepts standard 6.3 mm phone plugs. Versatile, panel or printed circuit mounting, for numerous applications. Solder lug terminals for positive connections. Complete with mounting hardware for quick, easy installation.
274-280 2-Conductor. Open Circuit **49 P**
274-281 2-Conductor. Closed Circuit **49 P**
274-282 3-Conductor. Open Circuit **49 P**
274-376 3-Conductor. Closed Circuit **59 P**
- B. Enclosed 3.2 mm Miniature Phone Jacks:**
274-296 Closed Circuit 2 for **59 P**
274-297 Open Circuit 2 for **59 P**
- C. Subminiature Phone Jack.** Closed circuit type. Mates with all standard 3.2 mm subminiature phone plugs. Lug solder connections. **274-275** **55 P**
- D. 6.3 mm Phone Jacks.** Accepts standard 6.3 mm phone plugs. With hardware for fast and easy installation in audio equipment.
274-324 2-Conductor. 2 Open Circuit, 3 Closed 5 for **99 P**
274-252 2-Conductor. Open Circuit 2 for **65 P**
274-255 2-Conductor. Closed Circuit 2 for **72 P**
274-312 3-Conductor. Open Circuit 2 for **95 P**
274-311 3-Conductor. Closed Circuit 2 for **99 P**
- E. Dual Jack Couplers.** Allows two cables terminating with miniature or subminiature phone plugs to be connected together. Shielded type.
274-298 Miniature Jack Coupler 2 for **99 P**
274-300 Subminiature Jack Coupler 2 for **89 P**

- F. Inline 6.3 mm Phone Plugs.** Durable black bakelite shell. Accepts standard 6.3 mm phone plugs. Dimensions 15.9x38 mm. **274-340** 3 for **89 P**
- G. Enclosed 6.3 mm Stereo Phone Jack.** 3-conductor. Double closed circuit. Strong, positive connection. Complete with schematic. **274-277** **79 P**
- H. 2-Conductor Inline Miniature Phone Jacks.** Accepts miniature phone plugs. Strong, positive connection. Quick and easy to install. **274-333** 2 for **59 P**
- I. Stereo Inline 6.3 mm Phone Jack.** Slim black plastic 3-conductor jack mates with any 3-conductor stereo phone plug. Lug terminal connections. Overall length 57 mm. **274-141** 2 for **89 P**
- J. 2-Conductor Subminiature Phone Jacks.** Accepts subminiature phone plugs. Closed circuit. Perfect for solid-state microcircuit component connections. **274-292** 3 for **69 P**
- K. 2-Conductor Miniature Phone Jacks.** One-third of the size of standard 6.3 mm phone jacks. Mounts in 6.3 mm hole. For panels up to 3.2 mm thick. Provides clean, positive, sturdy connections. Fast, easy to install.
274-251 Open Circuit 3 for **65 P**
274-253 Closed Circuit 3 for **69 P**

Terminal Strips, Test Leads, Connectors and Clips for Builders.



Set of 5

Tie-Down Terminal Strips

Bakelite strips for any circuit wiring. All are centre mounting type. Solder lugs spaced on 9.5 mm centres.

Cat. N°	Lugs	Ground Lugs	Price Set
274-682	1	None	35P
274-683	2	Yes	35P
274-685	2	None	35P
274-686	3	Yes	39P
274-687	4	Yes	39P
274-690	4	None	49P
274-688	5	Yes	47P
274-689	6	None	55P
274-692	8	None	49P



Set of 2

Screw Terminal Strips

1.6 mm thick bakelite strips 15.9 mm wide. Cadmium plated terminals.

274-663	35P
274-664	43P
274-665	49P



Set of 2

Barrier Terminal Strips

Ideal for permanent installation, breadboard or experimental work. Barriers between terminals prevent accidental shorts. Base 22.2 mm wide x 10.3 mm high.

274-656	2 Terminals	49P
274-657	3 Terminals	55P
275-658	4 Terminals	59P
274-659	6 Terminals	79P
274-670	8 Terminals	95P

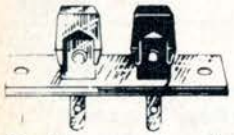

Pushbutton Terminals

Wire is held firmly by spring-tension terminal. To release, press button.

274-315	2 Terminals 54x19 mm	55P
274-316	4 Terminals 65x7.9 mm	69P

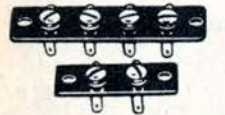

Set of 13

Screw Terminal Kit

Excellent for TV antenna, speaker terminal replacement. All 9.5 mm high. Each 38, 57 and 70 mm long.

274-345	£1.19
---------	-------



Set of 2

127 mm Solderless Test Prods

Moulded plastic handles. Plated tip plug fits standard phone tip jacks. One red and one black prod. 12.7 mm tip, 133 mm long.

274-720	69P
---------	-----



1.5 m „Flexi“ Test Leads

Feature „Flexi-Probes“ with moulded strain-relief – eliminates wire breakage. Tip plugs fit most multi-testers.

278-740	£1.09
---------	-------



1.30 m Test Leads with Banana Plugs

Moulded plastic handles. Solderless nickel-plated brass tips. Insulated, shockproof!

278-746	£1.89
---------	-------



Coiled Cord Test Leads

Colour-coded with solderless 12.7 cm test prods at one end, banana plugs at the other. 33 cm cord extends to 1.8 m. Includes adapter phone tips. Fits any multi-tester.

278-750	£1.89
---------	-------



11-Piece Test Lead Set

Two 114 mm prods, 1.8 m black and red test leads with banana plugs, 2 heavy-duty spade lugs, 2 phone tip plugs, 2 insulated clips, carrying case.

270-332	£2.69
---------	-------



Set of 10

Solder-Type Phone Tips

Provides positive electrical and strong mechanical connections. Nickel-plated brass. Fit standard phone tip jacks. 25.4 mm overall length.

274-719	49P
---------	-----



Solderless Phone Tips

One red, one black with insulated handles. Fit standard tip jacks. Wire fits through body and is held by knurled collar. Overall length 54 mm.

274-723	43P
---------	-----



Set of 6

2-Pin Plugs and Sockets

Assorted colours – red, black, ivory. Plug size: 19x12.7 mm; receptacle: 12.7x12.7 mm. Insure that your project's circuitry is correct!

274-342	99P
---------	-----



Set of 2

Phone Tip Jacks

One black, one red. Bakelite insulated heads. Accepts standard phone tip plugs. Requires 6.3 mm mounting hole. With fibre washers, mounting nut.

274-724	43P
---------	-----



Set of 2

Insulated Phone Tips

Flexible. Fit standard tip jack. Screw-on black & red insulators. Overall length 66.7 mm.

274-722	43P
---------	-----



Set of 2

Mini Test Clips

One black, one red. Each completely insulated to point of connection. Overall length, 54 mm. Makes connections on miniature components quicker, easier!

270-372	89P
---------	-----



Set of 2

Solderless Banana Plugs

One black and one red. Fit standard banana jacks. Insulated handles. Overall length 50 mm. Wire fits through body tip and is held by knurled collar.

274-721	49P
---------	-----



Set of 2

Banana Jacks

One black, one red. Heavy-duty insulated bakelite heads. Fits all standard banana plugs. Requires 6.3 mm mounting hole. With fibre washer, solder lug, mounting hardware.

274-725	35P
---------	-----



4 pairs

Banana Plugs and Jacks

Solder type gives positive connections. For radio, hi-fi and test equipment. 2 pairs red, 2 black.

274-341	89P
---------	-----



Set of 2

Phone Tip & Jack Sets

Black and red insulated tips, jacks. Solderless type. Ideal for replacement or projects requiring test points.

274-714	69P
---------	-----



Set of 8

5-Way Binding Post

4 red, 4 black for jobs requiring an external connection. Accepts banana plugs, phone tips, spade lugs. With solder, insulators, lug terminals.

274-661	8 for 89P
---------	-----------



Set of 2

Nylon Binding Posts

One black, one red. Insulated type. Accepts phone tip plug, banana plug, spade lug, alligator clip or wire strand. Requires 7.9 mm mounting hole. Wrap-around solder terminal

274-662	79P
---------	-----



2.4 m Auto DC Power Cord

Moulded plug fits car cigarette lighter. 2-conductor cable with stripped and tinned ends. Attaches any accessory in the car.

270-021	99P
---------	-----

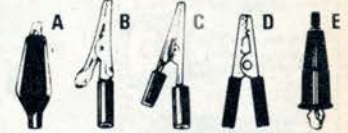

Insulated Alligator Clips

A. „Mini“ Clips. Kit contains 3 black, 3 red, 2 green and 2 yellow. Open to 4.8 mm. 32 mm long.

270-378	10 for 74P
---------	------------

A. 35 mm Mini Clips. 6 black, 6 red plastic insulators. Jaw opens to 6.3 mm. Solder type.

270-1545	12 for 99P
----------	------------

B. 57 mm Clips. Use around workshop of lab for solderless connections. Open to 7.9 mm. Various colours.

270-375	10 for 79P
---------	------------

C. 64 mm Clips. Consists of 5 red and 5 black clips. Solder connection type. All steel jaws.

270-347	10 for 89P
---------	------------

D. Heavy-Duty Clips. 67 mm long. 3 black, 3 red, rated at 10 amps. Screw terminal connections.

270-349	6 for £1.29
---------	-------------

D. 1A Clips. Set of 8. Vinyl insulated clips – 4 red, 4 black. Jaw opens to 9.5 mm. Size: 43 mm. Screw terminals.

270-371	8 for 99P
---------	-----------

E. „Mini“ Alligator Clips. Set has 5 black and 5 red clips. Sturdy steel jaws. Ideal for close work. Great for the workshop. 35 mm long.

270-374	10 for 79P
---------	------------

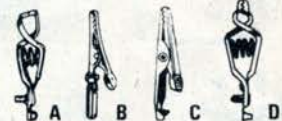

Non-Insulated Alligator Clips

A. Claw Clips. Heavy duty for low resistance connections. All steel.

270-377	10 for 84P
---------	------------

B. 50 mm Slim Clips. All steel with screw connections. Solderless type.

270-348	16 for 99P
---------	------------

C. „Mini“ Alligator Clips. Ideal for any test bench. Requires soldering of wire to solder lug. 32 mm long. Jaw opens to 4.8 mm. Rated 1 Amp.

270-380	12 for 74P
---------	------------

C. Copper Plated Micro Clips. Requires soldering of wire to solder lug. Jaw opens to 6.3 mm. 28.5 mm long.

270-373	10 for 59P
---------	------------

D. Battery Clips. Heavy-duty. Rated at 10 amps. Screw terminal connections. 48 mm long. Jaw opens to 12.7 mm.

270-379	8 for 85P
---------	-----------

Quality Knobs, Vernier Dials and Transformers

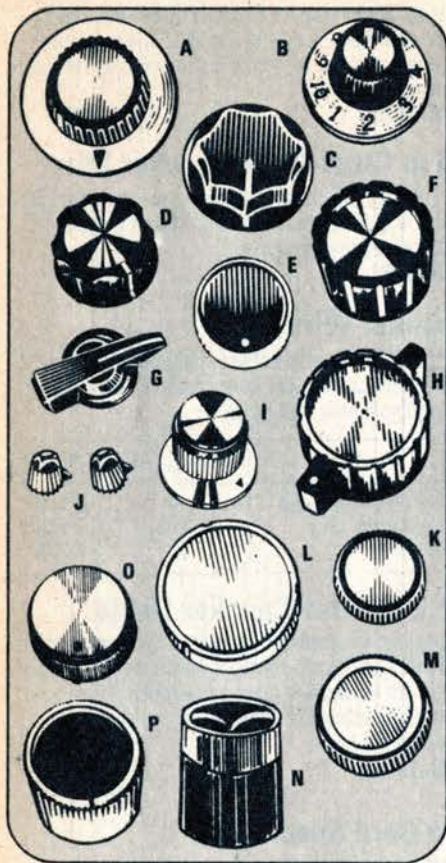

A. Communication Knobs. Set of 3. Knurled grip with numbers (0-10) etched on chrome plate. Silver inlay, set screws, 300° dial. 38 mm diameter × 22 mm deep. For 6.3 mm shafts.

274-392 £1.19
274-391 Single line index type £1.19

B. Communication Knobs. Same as above, but smaller in size. 28.5 mm diameter × 17.5 mm deep. Brass bushing for 6.3 mm shafts.

274-414 Single line index 2 for 69 P
274-413 0-10 calibrated 2 for 69 P

C. Hexagon Instrumentation Knobs. Handsome, rugged knobs for communications and test equipment. For 6.3 mm shaft.

274-407 Size 35 mm wide × 15.9 mm deep. 2 for 69 P
274-404 Size 25.4 mm wide × 15.9 mm deep. 4 for 79 P

D. Moulded Instrumentation Knobs. All fit 6.3 mm shafts. Brass insert and set screws included.

274-415 19 × 11 mm 4 for 99 P
274-416 25.4 × 14.3 mm 4 for 99 P
274-417 32 × 15.9 mm 4 for £1.19

E. 25.4 mm Matched Knobs. Four black knurled knobs with aluminium inlay, brass inserts, set screws. Fits standard 6.3 mm shaft. Use on all types of equipment. 25.4 mm wide × 19 mm deep.

274-1552 99 P

F. 25.4 mm Matched Moulded Knobs. Set of 4. Fits 6.3 mm shafts. Overall size 25.4 × 19 mm. With brass insert, set screws. Sure-grip type. Ideal for project purposes

274-419 £1.19

G. Pointer Knobs. Five black bakelite knobs with countless applications. 38 mm long × 14.3 mm deep. With brass inserts, set screws. For standard 6.3 mm shafts.

274-349 £1.19

H. Moulded Pointer Knobs. Brushed aluminium inlay, nibbed sides, brass bushing. Fits 6.3 mm shafts. With set screws. 22.2 × 15.9 mm.

274-411 2 for 79 P

I. Brushed Aluminium Knobs. Set of 2. Ideal for replacement in test and communication equipment. Pointed indicator on shirt. Fits 6.3 mm shafts. With set screw. Size: 17.5 × 19 mm.

274-418 £1.19

J. Clock Radio Knobs. 25, in assorted colours. Black, red, ivory, brown and clear plastic.

274-119 99 P

K. 15.9 mm Knobs. Four attractive knobs to add a neat appearance to any type of equipment. With brass insert, set screw. For standard 6.3 mm shaft. 9.5 mm deep.

274-401 79 P

L. Metal Knobs. Set of matched brushed aluminium knobs. Fit standard 6.3 mm shafts. Set screw.

274-350 19 × 12.7 mm 2 for £1.19
274-379 25.4 × 15.9 mm 2 for 89 P

M. 19 mm Knurled Knobs. Six black, silver-inlaid knobs. Brass insert, set screw. Fits 6.3 mm shaft. For radios, test equipment, experimental chassis of all kinds. 38 mm deep.

274-380 £1.19

N. Hi-Fi Type Knobs. Excellent for replacement or updating Hi-Fi equipment knobs. Fits 6.3 mm shaft. Black plastic with silver trim. Slotted set screw.

274-408 22.2 mm wide × 15.9 mm deep. 3 for 99 P
274-409 12.7 mm wide × 17.5 mm deep. 5 for £1.39

O. Hi-Fi Type Knobs. Nibbed sides with spun decorative insert. Brass bushing. Set screw. Fits 6.3 mm shafts. Size 19 × 19 mm.

274-410 3 for 99 P

P. Aluminium Knobs. Natural finish, black decorative inlay. With set screw. Straight knurling. Indicator marking on end. Size: 19 × 19 mm. Fits 6.3 mm shafts.

274-412 2 for 84 P

Universal AC Adapter

Fits most sets using 4.5 - 6 - 7.5 or 9 Volts.

- Save on battery costs!
- Polarity reversing cord!
- 300 mA rating!

Powers battery operated transistor radios, cassette players, etc., directly from any 220/240V AC source. Can be used with nearly any set having a jack for external voltage. 3 output plugs: Miniature, subminiature and power jack. 4-range voltage selector screw can be turned with coin or screwdriver. Output: 4.5, 6, 7.5 or 9 volts at 300 mA. 1.8 m cord. 70 × 50 × 38 mm.

270-9531 £5.49

Precision Vernier Dials

- Calibrated 0-100!
- Positive logging!
- 8:1 drive ratio!



Planetary drive for really precise settings. Easy-to-read black numerals on silver dial. For 6.3 mm shaft.

274-605 38 mm dial £1.19
274-615 50 mm dial £1.69

Low-Cost Filament Transformers

- Great for many electronic projects!
- Long, colour-coded leads for easy wiring!

A selection of popular transformers for the experimenter and builder. Great for transistor circuitry, pilot lights, miniature relays, power supplies, replacements, conversions, etc. Primaries designed to operate from 220/240V AC at 50/60 Hz.

Miniature 300 mA

273-9006 6.3V 52 × 25 × 30 mm £1.49
273-9007 12 V 52 × 25 × 30 mm £1.59
273-9008 24 V 60 × 28 × 35 mm £1.79



Standard 1.2 Amps

273-9003 6.3V 32 × 49 × 40 mm £1.69
273-9004 12.6V CT 50 × 60 × 38 mm £1.99
273-9005 24 V 50 × 49 × 81 mm £2.49

Subminiature 455 kHz Transformers

Set of 3 transformers and one oscillator coil. Use for PCs, AM radio replacements and experiments. Slug for tuning adjustments.

273-1383 £1.39

Audio Frequency Transformers

Cat. N°	Type	Impedance		Price
		Primary	Secondary	
273-1376	Input	200k	1k	99 P
273-1379	Output	500 CT	3.2	99 P
273-1380	Output	1k CT	8	99 P
273-1378	Driver	10k	2k	99 P
273-1381	Output	500 CT	3.2/8	99 P

Realistic Acoustic Suspension Speakers

Install them yourself – and save money!

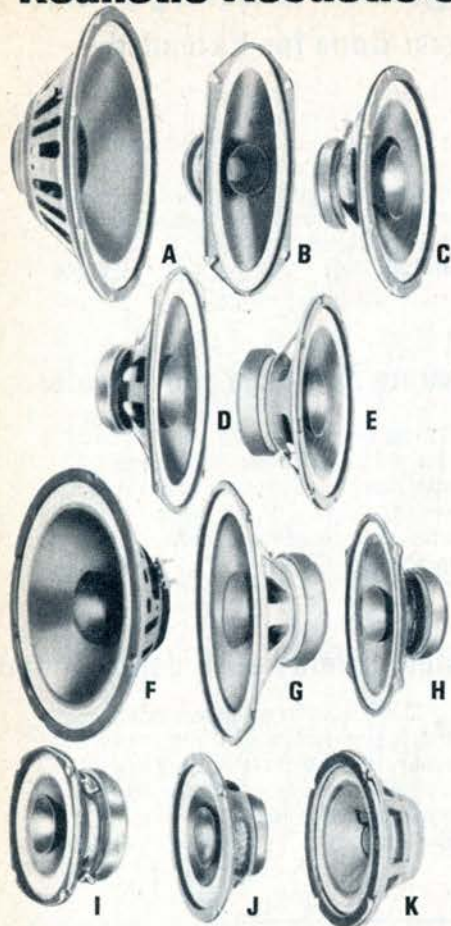

A. 30.5 cm – 32 Watts – 28-18,500 Hz. Builds easily into any stereo system. 283 g ceramic magnet, 30 cm woofer, whizzer cone. 8 ohms impedance.

40-1287 £11.95

B. 4×25.4 cm – 30 Watts – 50-18,000 Hz. Dual-cone cloth roll speaker for replacement use in home or car. 283 g ceramic magnet, whizzer cone, 8 ohms.

40-1297 £8.49

C. 20.3 cm – 30 Watts – 30-20,000 Hz. Excellent speaker for bookshelf enclosures. 283 g magnet, whizzer cone, 8 ohms.

40-1286 £7.95

D. 6×22.8 cm – 15 Watts – 30-20,000 Hz. Perfect for mounting in the rear of your car. Whizzer cone, ceramic magnet. Rugged design. 8 ohms.

40-1260 £8.39

E. 20.3 cm – 33 Watts – 28-20,000 Hz. Heavy 453 g ceramic magnet! Built for strength and durability. Separate high frequency cone. Great response! 8 ohms.

40-1341 £8.95

F. 25.4 cm – 30 Watts – 30-20,000 Hz. Dual cone design. 283 g ceramic magnet, free-air resonant frequency, 45 Hz. For replacement and extension use. 8 ohms.

40-1296 £10.95

G. 6×22.8 cm – 16.5 Watts – 20-20,000 Hz. High-fidelity type cloth roll construction. Separate high-frequency whizzer cone. Heavy 453 g ceramic magnet. Rugged. 8 ohms.

40-1340 £8.95

H. 5×17.8 cm – 32 Watts – 50-17,000 Hz. Oval speaker offering fine sound. 283 g ceramic magnet, whizzer cone – perfect for replacement use. 8 ohms.

40-1288 £6.59

I. 12.7 cm – 18 Watts – 65-17,000 Hz. Ideal for car systems, „second“ stereo systems and „mini“ installations! 283 g magnet, 8 ohms impedance.

40-1284 £6.49

J. 15.2 cm – 25 Watts – 50-17,000 Hz. Low-cost speaker for extension, replacement or small hi-fi system use. 283 g magnet, whizzer cone, 8 ohms.

40-1285 £7.49

K. 15.2 cm – 50 Watts – 45-15,000 Hz. Maximum efficiency – 11,500 gauss! 25.4 mm voice coil, 40 Hz free air resonance. Huge 900 g magnet. 8 ohms.

40-1342 £10.95

Acoustic Suspension 12.7 cm Speaker

- Perfect for extension speaker use.



Build this fine speaker into your own enclosure for a sound that will amaze your friends! Full 30-15,000 Hz. 8 ohms.

40-1909 £2.95

FE-103 10 cm Speaker

- Large ceramic magnet
- Acoustic suspension



Ceramic magnet develops over 10,000 Gauss. 30-17,000 Hz. 15 Watts, 8 ohms. For 4589 cm³ enclosure.

40-1197 £4.95

40-808 Equalizer Kit £2.25

12.7 cm Acoustic Suspension Die-Cast Speaker

- For TRUE Hi-Fi sound in your car!



30-20,000 Hz – peak performance. 900 g magnet, 25.4 mm voice coil. 8 ohms. Installs easily.

40-1292 £9.49

Realistic Indoor / Outdoor PA and Extension Speakers

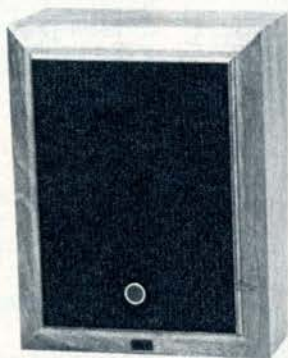

Deluxe Wall Baffle Speaker

- Acoustic suspension design!
- 40-15,000 Hz response!
- Walnut finish enclosure!

Wide range 12.7 cm speaker that looks good anywhere in the home! Frontal volume control, RCA-type and screw terminal inputs. 8 ohms. 343×267×93 mm.

40-220 £15.95



Low-Cost 20.3 cm Speaker & Baffle

Full-range speaker in an attractive walnut baffle. 8 ohms.

40-219 £5.95



70 V Line Transformer

10 Watt primary. Taps at 10, 5, 2.5, 1.25, 0.62 watts. Secondary impedance 4-8 ohms.

32-1031 £2.95

Indoor / Outdoor Speaker

Portable 10 cm speaker with Alnico V magnet. Screw terminals. 8 ohms.

40-1229 £4.95



10 cm Power Horn

- Wide range
- Waterproof

It has a cone in a horn-type enclosure. 5 Watts. 8 ohms.

40-1239 £5.95



Top Quality Wire and Cable for All Purposes

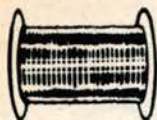

113 g Magnet Wire

Solvat-insulated, high-grade copper wire for dependable use as coil winding wire, wire for transformer windings, also radio frequency and choke use. Easily solderable!

Cat. N°	AWG	Length (m)	Price
278-003	22	28	£ 1.39
278-004	24	45	£ 1.39
278-005	26	73	£ 1.39
278-006	28	115	£ 1.39
278-007	30	182	£ 1.39
278-011	32	290	£ 1.39

Rainbow Wire Packs

Ideal for intercoms, model trains, toys. Flexible parallel cable, colour-coded for easy identification. Polyvinyl chloride (PVC) insulation resists temperature changes to provide low resistance. Very flexible. 3 or 4 conductor types in lengths to suit your every need.

- 278-755 2-Conductor, 11.5 m £ 1.39
 278-756 3-Conductor, 8.8 m £ 1.39
 278-757 4-Conductor, 7.6 m £ 1.39

Test Probe Wire

Plastic insulation, ideal for replacement or extension use. Comes in 7.6 m lengths.

- 278-553 Red £ 1.15
 278-554 Black £ 1.15

Hook-Up Wire Packs

Perfect for hobbyists and builders. Insulated electrolytic copper conductors. Various lengths, sizes and types to fit any requirement.

Single Colour					3 Assorted Colours				
Cat. N°	Type	AWG	m	Price	Cat. N°	Type	AWG	m	Price
278-1291	Solid	18	18	£ 1.19	278-1302	Solid	18	18	£ 1.19
278-1292	Stranded	18	16.5	£ 1.19	278-1303	Stranded	18	18	£ 1.19
278-1294	Solid	20	24	£ 1.19	278-1305	Solid	20	23	£ 1.19
278-1293	Stranded	20	20	£ 1.19	278-1304	Stranded	20	18	£ 1.19
278-1295	Solid	22	30	£ 1.19	278-1306	Solid	22	27	£ 1.19
278-1296	Stranded	22	27	£ 1.19	278-1307	Stranded	22	20	£ 1.19

Multi-Purpose Cable Kit

Handy addition to any workbench. Consists of three 1.8 m cables terminated with subminiature phone plug, miniature phone plug and adapter power jack. Other end of cable leads are stripped and tinned.

- 278-014 £ 1.39

150 m Hook-Up Wire Pack

Mammoth bargain! Five 30 m coils in popular colours. AWG sizes 18 to 22, suitable for most wiring jobs. You get both solid and stranded types. Great for the hobbyist and experimenter.

- 278-1484 £ 3.99

22.5 m Teflon Wire

Teflon-coated to protect your wire the same way Teflon protects your pots and pans. High temperature wire. Meets Military Specs. Stranded, assorted colours.

- 278-552 £ 1.79

Heat-Shrinkable Tubing

Set of 14 pieces in 10 cm lengths, sizes 3 mm and 12.7 mm. Fits over wire and shrinks to half its original diameter when heat is applied at 93°C. Forms smooth, tight-fitting cover for extra protection.

- 278-1627 £ 1.09

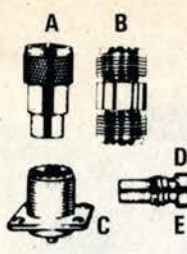

Coaxial Cable Connectors

Standard UHF type connections for HAM and CB use. Has push screw-on type lock.

- A. 278-205 PL-259 Plug 2 for £ 1.19
 B. 278-201 SO-239 Chassis Each 59P
 C. 278-1369 PL-258 Coupler Each 89P
 D. 278-206 UG-175/U Reducer for RG58/U 2 for 49P
 E. 278-204 UG-176/U Reducer for RG59/U 2 for 49P

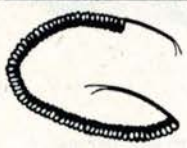

Telephone Coiled Cords

3 conductor stretches to 1.8 m. 4 conductor extends to 4.5 m.

- 278-361 1.8 m £ 1.29
 278-1389 4.5 m £ 5.59



Polyfoam Coaxial Cable

Extra low loss, compared to stranded dielectric. Ideal for amateur use. Gives greater signal strength. Order in quantities of 25ft.

- 278-1325 RG8/U, 52 Ohms 10P/ft
 278-1326 RG58/U, 52 Ohms 5P/ft
 278-1327 RG59/U, 75 Ohms 5P/ft

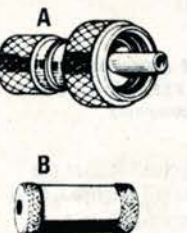

Solderless Coaxial Cable Connectors

A. Plug Type. Quick, easy hookup without soldering coaxial to connectors; eliminates shorts. Longlife construction.

- 278-209 For RG58/U Cable 2 for £ 1.19
 278-210 For RG59/U Cable 2 for £ 1.19

B. Inline Splicer. Join or extend coaxial cable - no special tools needed! Positive contact maintains wire impedance.

- 278-202 For RG58/U Cable £ 1.09
 278-203 For RG59/U Cable £ 1.09



Coaxial Connector Adapter

Specially designed to adapt the UHF type coaxial connector to the Motorola-type standard pin plug. Common in-series adapter that should be a must for the HAM or Amateur. Also use with police monitors as adapters.

- 278-208 £ 1.19



Motorola-Type Plugs and Jacks

Specially designed for use in auto radios. Great for adding a tape deck for recording off the radio; a reverberator kit for more true-to-life sound.

- 274-711. Plugs 49P
 274-712. Jack with flange 49P



Vinyl Sleeving

Twenty 60 cm flexible lengths. Fit wire sizes 12 to 20. Assorted colours - red, yellow, orange, green, blue-grey.

- 278-1625 99P



Test Lead Jumper Cables

A. Set of ten 35 cm colour-coded leads with miniature insulated alligator clips on each end. Ideal for testing or experimentation.

- 278-1156 £ 1.19

B. Set of four 75 cm test lead cables. Insulated clips at both ends. Red, green, black, yellow. Great for temporary hookups of any kind.

- 278-001 99P

C. Set of six 1m heavy-duty claw-type jumper leads. Insulated clips both ends. Colour-coded. Ideal for repairmen or experimenters.

- 278-002 £ 1.49

Better Buys in Printed Circuit Chassis for the Electronics Builder

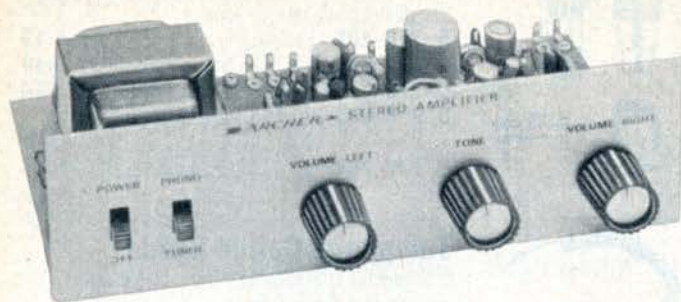

Stereo Amplifier Chassis

- **Rated at 3 Watts of music power!**
- **50-20,000 Hz response!**
- **Built-in AC power supply!**
- **Tuner and phono inputs!**

A complete stereo amplifier chassis that's perfect for building into a turntable base or tuner and/or phono systems. Has a power on-off and tuner/

phono slide switch plus left and right volume controls and tone control on aluminium front panel. Sensitivity: Tuner, 90 mV; Phono, 250 mV. Signal-to-Noise Ratio: 60 dB. Stereo Separation: 45 dB. Outputs: 8 ohms. With instructions. Size: 92x203x60 mm
277-040 £11.95

Compact 200 mW Speaker/Amplifier



- **Fits almost anywhere!**
- **Great for extension use!**
- **Battery powered!**

A pocket-full of power! It does the job of both speaker and amplifier! High-gain transistor amplifier output and driver transformers; speaker delivers clean 300-12,000 Hz response. On/Off volume control. With input jack, plug, cable. Requires 9V battery. 55x92x9 mm.

277-1008 £4.74
23-464 9V battery..... 19P



Use as a phono amp.



Use as a telephone amp.

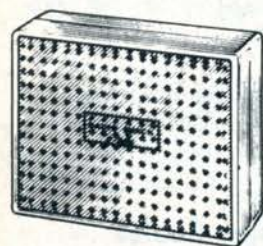

Rear view

Experimenter's „P-Box“ Perfbox

- **Parts mount without cutting tools!**
- **Transparent hinged lid!**

Makes circuits easier to build. Material withstands soldering heat. Removable lid. 2.38 mm \varnothing holes. 117x92x38 mm.

270-105 79P

- **Build professional projects with no cutting or drilling!**
- **Pre-drilled 89x152 mm board and speaker grille!**

Removable front, outlet for speaker wire or line cord. 1.57 mm hole \varnothing . Bakelite case. 95x155x51 mm.

270-097 £1.69

Miniature Audio Amplifier Chassis



- **Fully-wired ready-to-use mono amplifier!**
- **Convenient battery operation!**
- **100% safe!**
- **Sturdy, reliable PC construction!**

100 mW output, 4 transistors. Gain: 1 mV input for 100 mW output into any 8-12 ohm load. 2500 ohm output impedance at 1 kHz. Response up to 15,000 Hz. 76x14x17 mm. Uses 9V battery.

277-1240 £3.39

350 mW Output, 5 transistors. Dual inputs: 5000/10,000 ohms. For 8-12 ohm load. 101x51x19 mm. 15,000 Hz. Uses 9V battery.

277-1557 £4.75
23-464 9V battery 19P

1 Watt, 4 transistors. Input: 5000 ohms. Output: 8-12 ohms. 51x95x32 mm. Response to 15,000 Hz. Uses 8 „D“ batteries.

277-038 £5.59
23-466 „D“ battery each... 9P



- **„Snaps-on“ any standard phone for instant installation!**

Telephone Amplifier

Helps the hard-of-hearing!

Four-transistor amplifier boosts voice signal up to 5 times its normal sound, eliminates surrounding noises. Finger-tip volume control. Fixing band and battery. 67x25 mm.

277-007 £5.95

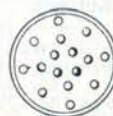

Crystal Mike Replacement Cartridge

General-purpose. 50-8000 Hz response. Sensitivity, -55 dB.

270-095 38x6 mm..... 89P

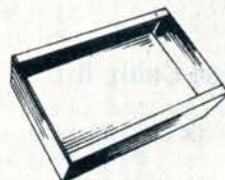

Aluminium Chassis Bases

Made of N° 18 gauge aluminium alloy.

270-243 57x114x25 mm ... 99P

270-244 89x140x25 mm ... 99P

270-245 102x152x51 mm. £1.29

270-246 127x178x51 mm. £1.59

Multi-Purpose Builders' Boxes



A. Bakelite „Mini“ Boxes. Heavy-duty. Aluminium cover removes for easy access to components.

270-230 82x 54x 28 mm 79P
270-231 102x 57x 57 mm 79P
270-233 128x 67x 41 mm 99P
270-232 157x111x 60 mm £1.69



B. Aluminium „Mini“ Boxes. Punched screw holes allow easy assembly. Lightweight, sturdy construction. Durable.

270-235 70x 54x 41 mm 99P
270-239 102x 54x 41 mm 99P
270-236 102x 57x 57 mm £1.29
270-237 127x 57x 57 mm £1.39
270-238 133x 76x 59 mm £1.49



C. Deluxe Metal Cabinets. Sturdy 2-piece construction. N° 18 gauge steel cover, aluminium front and rear panels. Cabinets are lowered for ventilation. Rubber mounting feet. A must for electronic builders and hobbyists. Many uses.

270-251 82x 55x102 mm £1.29
270-252 102x 60x152 mm £1.69
270-253 133x 76x149 mm £2.39

Super-Plastic „Thermal” Fibre Optic Kit

Create Dozens of Dazzling Light Displays with Heat-Shaped Plastic (Poly) Fibres.

- *Fibres can be formed and fused „thermally” (with heat)!*
- *Easy to use and re-use!*
- *107-piece accessory kit!*
- *9 booklets!*

Limitless variety of beautiful ornamental light displays! Plastic fibres transmit up to 175 times more light than glass fibres and can be formed and fused by heat from light bulbs, candles or soldering irons. Form 60 and 80 mm lensed fibres, transfer light from fibre to fibre (Link-O-Lites), pipe light up walls, around corners, and much more. Kit includes 25 m of 0.5 mm fibre, 60 cm of 1 mm fibre and 59 m of 0.25 mm Crofon (64x91 cm lengths fused in a vinyl jacket), 2.5 cm magic optical ribbon, 3.6 m x 0.5 mm colour coded fibres in 60 cm lengths. 107-piece accessory kit has 60 Fuse-N-Glo spheres with inner glow, 10 optical stems, 3-piece variable colour control, 1 optical adapter, Flex-O-Lite fitting, 10 end fittings, 60 cm vinyl jacket, magic floratape, vial of acrylic adhesive, 2 „O” rings, 3-piece sphere holder kit, 4-piece heat shrink tubing, 1 focus lens, self-powered light source, 9 fibre optic booklets.

272-306 £9.89

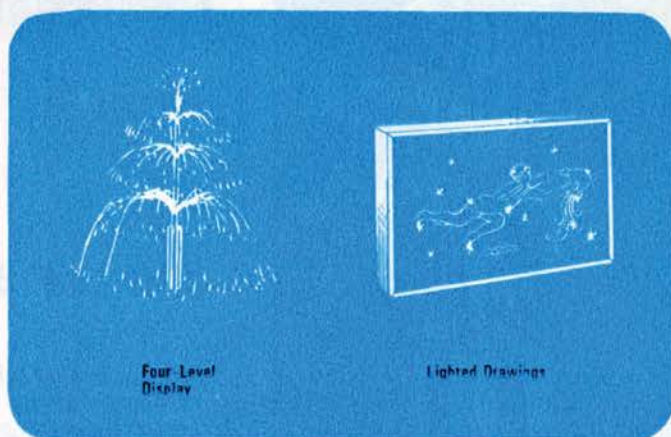

Four-Level Display

Lighted Drawings



Versatile Flex-O-Lite



TrOptical Displays



Aurora Display

Plastic and Glass Fibre Optic Kit Makes a Variety of Exciting Displays

- *Over 1600 light-transmitting fibres!*
- *Variable colour control for added versatility!*
- *79-piece accessory kit!*

Thousands of dazzling uses! Light travels through fibres by internal reflection. Each optically perfect fibre cuts and bends like wire, and guides light around corners, up walls, etc. Transmits enough light to trigger light sensitive devices. Includes 1400x30 cm glass fibres, 200x60 cm glass fibres in vinyl jacket, 64x0.25 mm dia. plastic fibres fused in a 60 cm black vinyl jacket. Accessory kit has 3.6 m of 0.5 mm solid plastic light wire, 5 cm image stick, assorted jackets, 2 optical adapters, 10-piece end-fitting kit, floratape, 6-piece heat shrink tubing, 30 hobby spheres, adhesive, 9 rigid vinyl stems, 4 „O” rings and 5 booklets!

272-302 £7.99

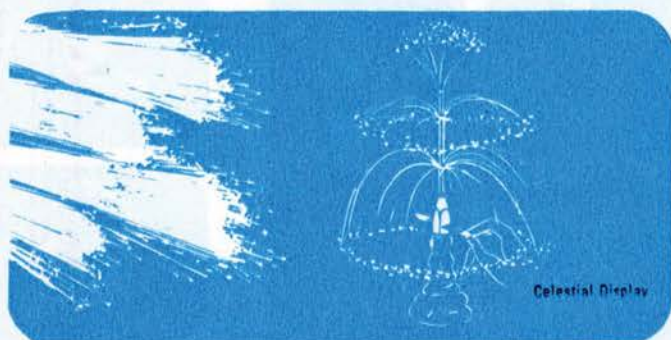

Celestial Display



Optical Plaque



Plastic/Glass Light Pipe



Magic Fibre Wand

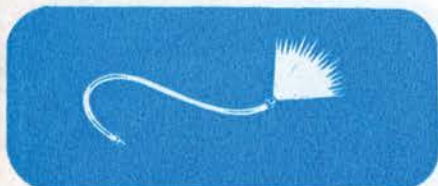

Fibre Optic Hobby Kit

- *Learn fibre optic basics!*

Excellent introduction to fibre optics. Includes 200 optically perfect 60 cm long glass fibres with vinyl jackets, 60 cm of 0.25 mm plastic fibre, optical adapter and a booklet with projects and theory.

272-303 £1.99



35 cm Magic Fibre Wand

- *With variable colour control!*

Multi-colour wand introduces you to hundreds of optical display projects. Variable colour control changes colour on up to 1000 micro-lighted tips. With light source and booklet. Batteries not included.

272-304 £3.49

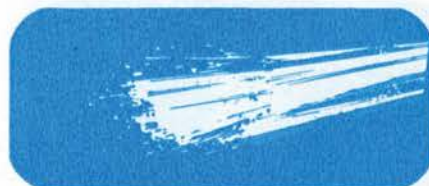

Glass Fibre Optic Kit

- *Perfect for the beginner!*

Illustrates the basic principles of fibre optics – transmits light by internal reflection even around corners. Has 90 cm glass light pipe with vinyl jacket, 300 glass fibres up to 30 cm long, optical adapter and booklet.

272-310 £1.99

Add Glitter and Sparkle to your Home with Fascinating Fibre Optics!



„Star-Lite” 3-level Optical Display Lamp Kit

- **Pre-shaped 0.5 mm plastic fibres – same type as used with more expensive displays!**
- **Unique design eliminates messy adhesives!**
- **Over 125 lighted tips!**
- **Plugs into AC power point!**

Enter the magical world of fibre optics with „Star-Lite”. First time in KIT FORM – and at a low price – this 30 cm optical display is sure to be a conversation piece in any home, office or shop! Includes 125 pre-shaped 0.5 mm plastic fibres that can be used over and over again, a multi-colour disc, acrylic base, 4-piece interlocking cylinder, 1.8 m line cord and 220/240 AC fibre optic lamp. „Light-up” your surroundings with this exciting kit which is fun and easy-to-build!

272-311 £9.95

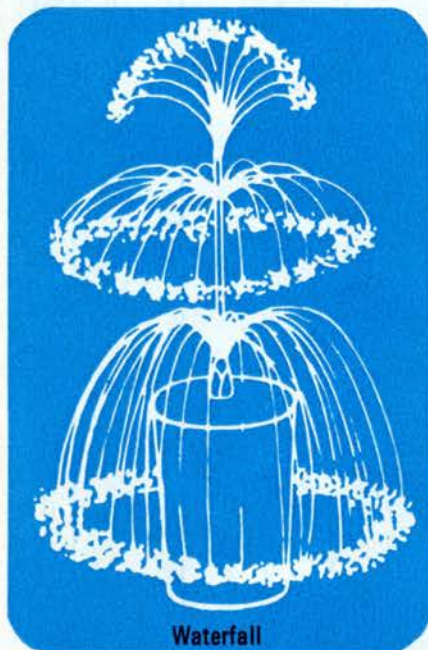

Glass Fibre Optic Light Sensor Kit

- **Makes unique displays and light pipes!**
- **Fibres cut and bend like wire!**
- **For hobbies, gifts, experiments!**

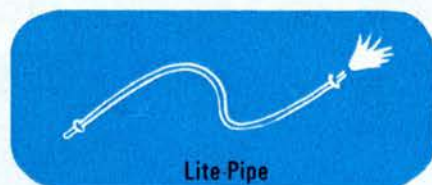

Lite Pipe



Magic Wand

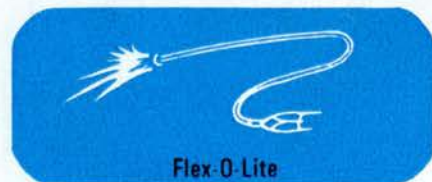

Flex-O-Lite

Discover the fascinating world of fibre optics! Light travels from one end of the fibre to the other by internal reflection –make optical displays, readouts, lines of light, etc. Special process allows you to use fibres over and over again. Kits includes 1400 optically perfect 30 cm long glass fibres (micro-lights), three 90 cm lengths of vinyl jacketing, 10-piece stem kit, 2 pieces of heat-shrink tubing, an optical adapter, floratape, 4 end fittings, 2 „0” rings, optical adhesive and 3 booklets.

272-301 £5.49

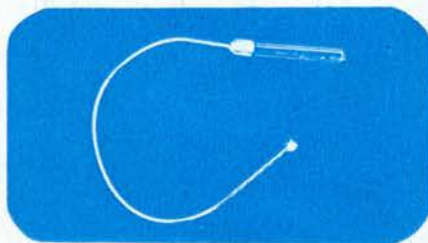

Magic Poly Flex-O-Lite

- **Hobbyist’s inspection aid!**

Directs light into hard-to-see areas, triggers light-sensitive devices. Includes 60 cm of 1 mm plastic light pipe with transparent vinyl jacket, adapter, light source, focus lens and booklet.

272-309 £2.95

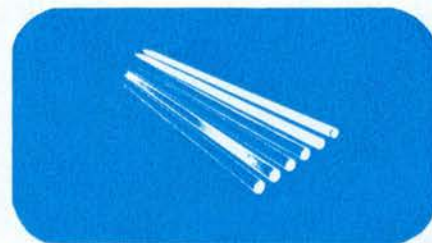

14 m „Colour-Coded” Fibre

- **Multi-coloured optics!**

Assorted 0.5 mm dia. fibres in yellow, green, orange, violet, red and blue. Kit includes 14 m of fibres, 30 „Fuse-’n-Glo’s”, 3-piece sphere holder kit, optical adapter, 3 end fittings, booklets.

272-314 £3.69

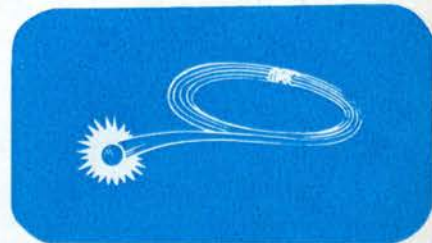

0.5 mm Plastic Light Wire

- **Continuous 24 m length!**

Perfect introduction to heat-shaped fibre optics! Kit includes 60 cm vinyl jacket for uni-fibre lensed light pipe, 4 end fittings, 3-piece sphere holder, 6 „Moonstone” polyspheres, booklet.

272-308 £4.99

Fascinating Fibre Optics - Elegantly DeLIGHTful Addition to any Room

The „Revolutionaire” Fibre Optic Lamp

- **Over 200 optical plastic tips of light!**
- **Fountain-like 3-tier cascade!**
- **Blends with any decor!**

What a price breakthrough! A complete lamp priced well below what you might expect to pay elsewhere! Over 200 plastic fibres for a truly impressive light array. Each optically perfect fibre transmits light by internal reflection, sparkling pinpoints of light emerge from each tip. Yellow, red and blue colour control disks let you add the colours of your choice. Fluted

octagonal base is accented with gold flecks and inlays, and glows amber when lit. Stylish gold metal top. Makes a great night-light or TV lamp. For psychedelic effect, use with „Psycholite” and have tips light to music for extra dimension in light display. 40 cm high. Plugs into any AC power point: 220/240 V.

272-300 £ 10.95

„Thermal” Plastic Fibre Optic Kit

Make 2 Sparklingly Different Displays

- **Low-cost way to add „sparkle” to your home!**
- **Same 0.5 mm poly fibres as in displays costing much more!**

Make TWO exciting light displays for less than the cost of one ready-made display! 0.5 mm plastic fibres transmit light by internal reflection, can be shaped and fused with heat. Meteor-Lite 4-level display has 3 levels of cascading lights topped with glowing moonstone sphericals. The Moonstone display is a spray of glowing polysphericals at the end of each fibre. Kit includes

40x60 cm lengths of plastic fibres, 30 „Moonstones”, 4-piece sphere holder kit, 5 optical stems. Two variable colour controls add a new dimension of light to each display. Self-powered cordless light source, 2 end fittings, „O” ring, magic floratape, vial of acrylic adhesive and booklets.

272-307 £ 6.69

Celestial Lights

- **45 cm 3-level display!**
- **1400 micro-light tips!**
- **Cordless light source!**
- **Variable colour control!**

A fountain-like shower of light! Glass fibres transmit light by internal reflection, even around curves! Variable colour control lets you change colours instantly. Kit includes 1400 optically perfect 30 cm fibres, cordless light source, floratape, optical adhesive, end fittings, 3 optical stems, booklets.

272-312 £ 4.95

Multi-Colour Cosmic Lights

- **Multi-colour plastic fibres!**
- **Fuse-’n-Glo spheres!**
- **Variable colour control!**
- **45 cm high!**

New dimension in optical displays. 0.5 mm plastic fibres transmit 22 times more light than glass fibres. Uses Poly Thermionic forming, shaping and fusing technique. Kit includes 18 m of 0.5 mm fibres, 30 Fuse-’n-Glo spheres, all in rainbow colours. Self-powered light source, floratape, large end-fitting, 4 stems, 3-piece sphere holder, booklets.

272-313 £ 4.95

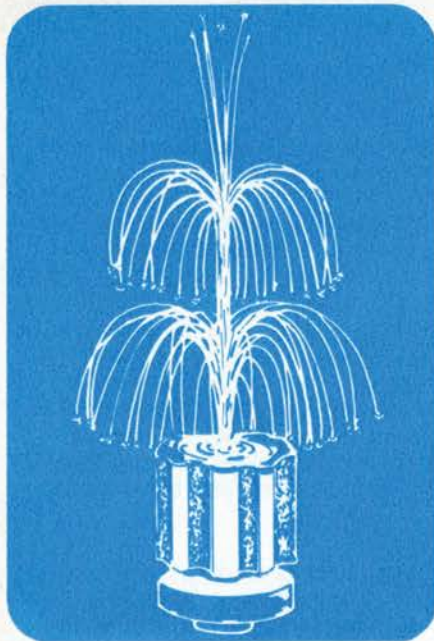

Micronta Multitesters – Versatility & Value



A



B

A. 1000 Ohms/Volt AC/DC Pocket Multitester – 8 ranges. Handy for home and workshop. Has easy-to-read two-colour 5 cm meter, pin jacks for all 8 ranges. Reads AC and DC volts: 0-15-150-1000. DC Current: 0-150 mA. Resistance: 0- 100,000 ohms. Accuracy: $\pm 3\%$ full scale on DC ranges, $\pm 4\%$ on AC ranges. Features convenient thumb-set zero adjustment, mirrored scale that eliminates parallax for accurate readings. Uses precision 1% tolerance resistors throughout. Enclosed in ultra-compact black bakelite case – only 89×59×32 mm. Complete with leads, battery, instructions.

22-027 £6.69

B. 20,000 Ohms/Volt – 18 ranges. Low-priced VOM with expensive model features! Single knob range selector with separate „off” position, 7.6 cm meter with easy-to-read colour-coded scales. Pin jack connections. Ranges: DC Volts, 0-5-25-125-500-1000 at 20k ohms/volt; AC Volts, 0-10-50-250-1000 at 10k ohms/volt; DC Current, 0-50 μ A, 0-250 mA; Resistance, 0-2k-20k-2 megs; Decibels, -20 to +62 in 4 ranges. Accuracy: 3% on DC ranges, 4% on AC. Size: 130×89×36 mm. With leads, battery, instructions.

22-201 £9.95

C. 20,000 Ohms/Volt – 25 ranges. Highly sensitive, full-range multitester styled with a design of the future. Single-knob range selector. Easy-to-read 10 cm meter with colour-coded, mirrored scales. Pin jack connections. Ranges: DC Volts, 0-0.6-3-15-60-300-600-1200 at 20k ohms/volt; AC Volts, 0-15-60-150-600-1200 at 10k ohms/volt; DC Current, 0-60 μ A, 3-30-300 mA; Resistance, 0-2k-20k-200k-2 megs; Decibels, -20 to +63 in 5 ranges. Accuracy: $\pm 3\%$ DC, $\pm 4\%$ AC. Complete with leads, battery, instructions.

22-202 £12.50

D. 30,000 Ohms/Volt – 27 ranges. Highly accurate precision tester does big jobs easily – a „must” for laboratories, servicemen, technicians! Colour-coded 10 cm meter reads with ease. Banana jack connections, polarity reverse switch. Ranges: DC Volts, 0-0.3-1-3-10-30-100-300-1000 at 30k ohms/volt; AC Volts, 0-10-30-100-300-1000 at 10k ohms/volt; DC Current, 0-100 μ A, 3-30-300 mA, 10 A; Resistance, 0-1k-10k-1 meg-10 megs; Decibels, -10 to +62 in 5 ranges. Accuracy: $\pm 3\%$ DC, $\pm 4\%$ AC. Compact and rugged with carry handle. Size: 160×116×46 mm. Test leads, battery, instructions included.

22-203 £14.95



C



D



50,000 Ohms/Volt - 43 Ranges

- „Range-Doubler” circuit!
- Overload protected meter!
- Single knob function switch with „Off” position!
- Carry handle doubles as tilt stand!

Range-Doubler provides more accurate readings on both current and voltage – great for low voltage transistor servicing! 11.4 cm meter has colour-coded, mirrored scale. Ranges: DC Volts, 0-250 mV, 2.5-10-50-250-1000 at 50k ohms/volt, 0-125 mV, 1.25-5-25-125-500 at 25k ohms/volt; AC Volts, 0-10-50-250-1000 at 10k ohms/volt; 0-5-25-125-500 at 5000 ohms/volt; DC Current, 0-50 μ A, 5-50-500 mA, 10A at 50k ohms/volt, 0-25 μ A, 2.5-25-250 mA, 5A at 25k ohms/volt; Resistance, 0-2-20-200k-2-20 megs; dB, -20 to +62 in 8 ranges. Accuracy: $\pm 3\%$ DC; $\pm 4\%$ AC. Size: 170×124×54 mm. With leads, batteries, instructions.

22-204 £18.95



100,000 Ohms/Volt - 27 Ranges

- Double jewelled D’Arsonval 10 cm meter!
- Meter protection circuit guards against burnout!
- Reverse polarity switch!

One of the finest portable/bench multitesters available today! Has every feature you need for faster, more accurate testing. Ranges: DC Volts: 0-0.5-2.5-10-250-1000 at 100k ohms/volt. AC Volts: 0-5-10-50-250-1000 at 10k ohms/volt. DC Current: 0-10 μ A, 500 μ A, 5-50-500 mA, 10A. Resistance: 0-1-10k, 1-10-100 megs. Decibels: -20 to +62 in 5 ranges. Accuracy: $\pm 3\%$ DC, $\pm 4\%$ AC. Mirrored scale eliminates parallax for more precise readings. Meter protection circuit prevents overload damage. Carrying handle doubles as tilt stand for the workbench. Size: 213×135×82 mm. With leads, batteries, instructions.

22-205 £24.95

Complete your Test Bench with Equipment from TANDY!

Easy-to-Use Battery Tester



- Tests most popular sized batteries!
- 2 jewelled meter movement!
- Colour-coded scales!

Accurately measures voltage under the load conditions of any flashlight or transistor radio battery. Five ranges: 1.5-6-9-15-22 volts. Two colour-coded scales - Regular: REPLACE-?-GOOD; Mercury: REPLACE-GOOD. Single-knob selector. Negative ground stud for quick checking. Size: 130x41x89 mm. With 45 cm test leads and instructions.

22-030 £6.45

Variable DC Power Supply



- Output voltages from 0-24 volts at 1 Amp!
- Dual function panel meter-volts & current!

Gives a continuously variable output from 0-24V DC. Dual voltage range selector for 0-12 and 12-24 volts. Input: 220V AC at 50 Hz. Output: 1.0 amp constant over entire voltage with 1.5 amps surge. Adjustable voltage control. Equipped with built-in circuit breaker. Metal case. Size: 136x184x76 mm.

22-126 £24.95

Solid-State Filtered DC Power Supply



- 4.5-6-9-12 Volt output-up to 140 mA!
- Bias for DC filament supply!

Use as battery eliminator for transistor radios or for constant low-voltage supply while servicing solid-state equipment. Highly filtered circuitry for 4 output voltages. Transformer powered. Binding posts, pilot light. 140x67x60 mm. For 220/240V AC.

22-008 £6.95

Signal Injector - Traces IF, RF and AF Circuits



Handy probe for quick tests of both tube and transistor audio circuits. Easy pushbutton operation, battery strength indicator lamp. Size: 127x41 mm (less probe). With batteries.

22-4032 £3.99

Resistance-Capacity Substitution Box



24 resistance values: low - 15-10,000 ohms; high - 15,000 ohms to 10 meg. (12 steps each). 9 capacitance values: 0.0001, 0.001, 0.0022, 0.0047, 0.01, 0.022, 0.047, 0.1, 0.22 μ F. Two sets of test leads. 130x70x44 mm.

22-001 £4.99

Precision Panel Meters



- D'Arsonval movement with jewelled bearings!
- Linear dial scales!

Most-wanted types by builders and experimenters. Rugged construction. Clear plastic wrap-around cover for wide-angle viewing. 70x57x32 mm. Requires 47.6 mm mounting hole.

22-051 0-50 μ A, DC £4.49

22-052 0-1 mA, DC £3.99

22-053 VU Meter -20 to +3, 20-20k, \pm 1 dB, „0“ VU = 0.8V rms. Internal rectifier. 4000 ohms £4.49

„In“ or „Out“ of Circuit Dynamic Transistor Checker



- Test low, medium, high power PNP and NPN types!

Shows electrode open and short circuits, current gain. Permits matching of similar transistors in operating circuits. GO/NO-GO test from 5-50 mA on power types. Front panel „quick check“ socket, clip leads for in-circuit testing. 159x76x57 mm.

22-024 £8.95

Transistorized Signal Tracer - Spots circuit troubles fast!



- Checks RF, IF and Audio signals from antenna to speaker!

A „must“ for any servicing work. Tests all types of audio equipment - record players, tuners, amps, receivers - stage-by-stage for accurate troubleshooting. Built-in 5 cm speaker, volume control. Portable. Size: 50x143x38 mm. With 9V battery, test leads, instructions.

22-010 £6.95

Miniature Panel Meters



- 30x28.5 x38 mm!
- Over 2% accuracy!
- Requires 39.7 mm mounting hole!

22-9016 0-300V AC £3.99

22-017 0-50 μ A £3.99

22-037 0-100 μ A £3.99

22-018 0-1 DC mA £3.49

22-038 0-15 DC Amps £3.99

22-036 0-15V DC £3.49

22-019 VU, -20 to +3 (0-100%), 4000 ohms £3.99

22-020 Signal Strength, 1 mA Full Scale £3.49

„New Formula” Batteries

Powerful „New Formula” Batteries

- All quality-controlled and factory inspected!
- Factory-fresh for extra long-life performance!

Every premium-quality „New Formula” power cell is first put in a steel jacket and then must surpass the most rigid quality controls before

ever leaving the factory. Why pay more for less when you can have the very best from Tandy?

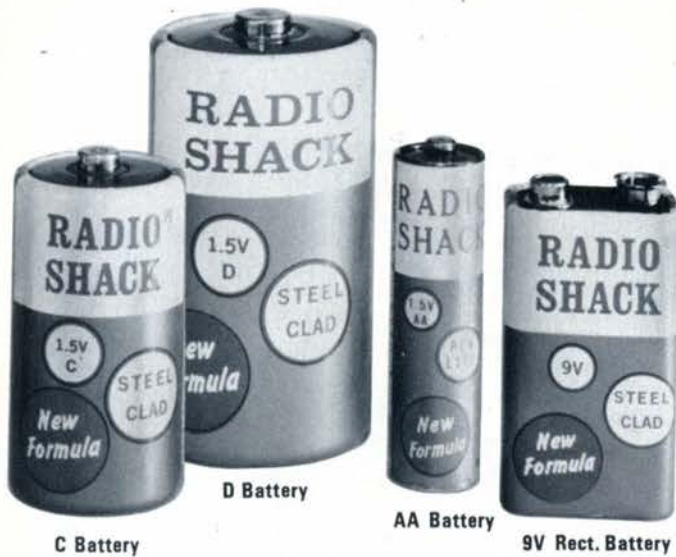

Cat N°	Type	Replaces Ever-Ready	Quantity prices	
			Each	Per box of
23-466	1.5V „D”	SP-2	9 P	24 / £1.85
23-467	1.5V „C”	SP-11	8 P	24 / £1.65
23-468	1.5V „AA”	U-12	6 P	72 / £3.85
23-464	9V Rect.	PP-3	19 P	24 / £3.85



Powerhouse Pack of 5 „D” Batteries

Buy 1.5V „D” batteries in our special 5-Pack and SAVE! 23-4665 43 P

Stock up and Save!
Buy a Box!



Tandy is your Headquarter for Hard-to-Find Batteries

Alkaline Batteries

Cat. N°	Volts	Equivalent Mallory	Price
23-223	1.5 „AAA”	MN 2400	13 P
23-013	1.5 „N”	MN 9100	13 P
23-225	1.5	PX 625	22 P

Mercury Batteries

23-9001	1.35	PX 625	33 P
23-660	1.4	RM 401H	29 P
23-1520	1.4	RM 675R	18 P
23-9002	1.4	MP 675H	20 P
23-1535	1.4	ZM9C	46 P

Miniature „B” Batteries

Cat. N°	Volts	Equivalent		Price
		Mallory	Ever-Ready	
23-509	15	M-154	B-154	22 P
23-097	22.5	M-122	B-122	27 P

Transistor Radio Batteries

23-9004	9	M-1603	PP-9	35 P
23-9005	9	M-1602	PP-7	29 P

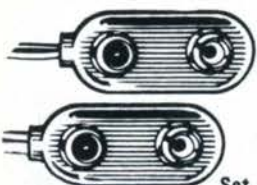

9-Volt Battery Clips

- Durable plastic!
- Low, low price!

12.7 mm spacing. Fits transistor radio and battery holder connectors. Designed to give long life and increased resistance to battery acid and other physical extremes.

270-325 79 P

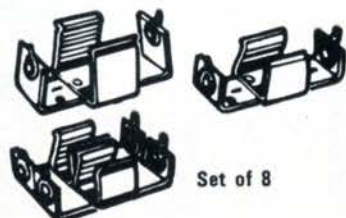

Battery Holder Kit

Great for hobbyists and experimenters. Kit consists of holders for 4 single „AA” batteries, 1 double „AA” battery, 1 „C” battery, and 2 „D” batteries. Solder lug terminal connections.

270-381 95 P

Join our „Tandy Free Battery Club” and save up to £ 2.28!



1 battery each month for one year

Join up now and receive your choice of one New Formula battery in 1.5V „D”, „C”, „AA” or 9V sizes each month. FREE! (That's worth up to £2.28). Pick up your Club Card at your nearest Tandy store!

No obligation, nothing to buy! It's just a way of saying „thanks” for shopping at Tandy.

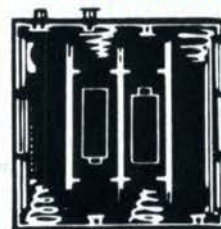

Plastic Battery Holders

Great for replacement use in walkie-talkies and radios. Durable plastic for easy insertion of batteries.

Cat N°	Holds	Price each	Cat. N°	Holds	Price each
270-382	2 „AA” batteries	49 P	270-385	2 „C” batteries	64 P
270-383	4 „AA” batteries	49 P	270-390	4 „C” batteries	64 P
270-388	4 „AA” batteries	54 P	270-386	2 „D” batteries	69 P
270-384	6 „AA” batteries	59 P	270-389	4 „D” batteries	69 P
270-387	8 „AA” batteries	74 P			

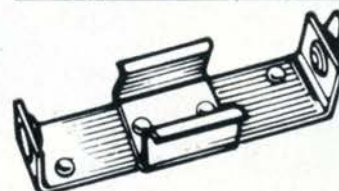

Aluminium Battery Holders

Very sturdy construction. Ideal for mounting batteries on breadboards. For use in a variety of experimental and hobby projects.

Cat. N°	Holds	Price each	Cat N°	Holds	Price each
270-1432	1 „AA” battery	27 P	270-1436	1 „C” battery	39 P
270-1433	2 „AA” batteries	29 P	270-1437	2 „C” batteries	39 P
270-1434	3 „AA” batteries	37 P	270-1438	1 „D” battery	39 P
270-1435	4 „AA” batteries	49 P	270-1439	2 „D” batteries	46 P

50% Extra-life Batteries - Exclusive at TANDY

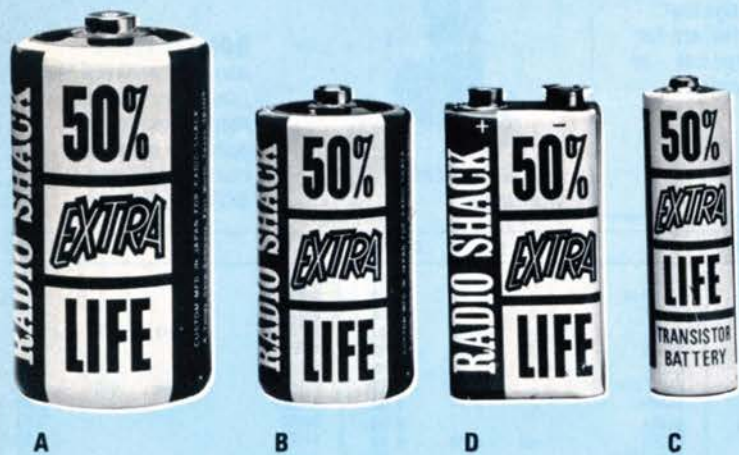

A special formulation gives 50% more life than „regular“ batteries. Longer shelf life insures full strength even after many months. Exceptionally good for high-drain applications such as in toys, flashlights, calculators and cassette recorders.

Figure	Cat. N°	Type	Replaces		Price	
			Ever-Ready	IEC		
A	23-9153	„D“	HP-2	R 20	2 for	44 P
B	23-9154	„C“	HP-11	R 14	2 for	34 P
C	23-9155	„AA“	HP-7	R 6	4 for	40 P
D	23-151	9V rect	PP-3	6F22	each	30 P

ENERCELL Alkalines last up to 10 times longer!*

Once you've divided the initial cost by hours upon hours of service, you'll immediately see why Tandy's Enercell alkaline batteries are your best buy! Steel-clad and insulated for top performance even at low temperatures, greater dependability in all kinds of weather! They offer top performance even at high-drain levels. Exclusive at Tandy! (Non-rechargeable).

*In the same service as regular zinc-carbon batteries.

- 7 times longer in flashlights
- 5 times longer in radios
- 10 times longer in toys
- 6 times longer in walkie-talkies

Figure	Cat. N°	Type	Replaces Ever-Ready/Mallory	Price
A	23-550	„D“	MN 1300	2 for 82 P
B	23-551	„C“	MN 1400	2 for 48 P
C	23-552	„AA“	MN 1500	4 for 68 P
D	23-553	9V rect.	-	each 67 P

B. 1.5V „C“ battery

A. 1.5V „D“ battery



D. 9V rectangular

C. 1.5V „AA“ battery

ENERCELL Nickel Cadmium Batteries

- Eliminate battery changing!
- Hermetically sealed!
- Recharge up to 500 times!
- Uniform power output!

Forget those unwanted trips to the store for replacement batteries! Enercell Nickel Cadmium power cells (made exclusively for Tandy) can be charged and discharged up to 500 times to save you time, trips and money! All are rated 1.25V and feature uniform output. Optional charger.

23-125 2 for £1.99

Nickel Cadmium „AA“ Battery Charger

Automatically charges 2 or 4 Enercell or other Nickel Cadmium „AA“ cell batteries at one time. Has a switch for 2 or 4 batteries. 14-16 hour charge cycle. Use any household AC power point.

270-1529 £5.95



Easy-to-Use Hand-Held Battery Checker



- Instantly shows the condition of „C“, „D“, „AA“ & 9V transistor radio batteries!

Handy at home or work - just plug battery into the checker and see the condition on easy-to-read colour-coded scales. If it shows red, replace; green means battery is good. For zinc-carbon, alkaline, mercury and Nickel Cadmium batteries. Size: 105x60x35 mm.

22-100 £3.99

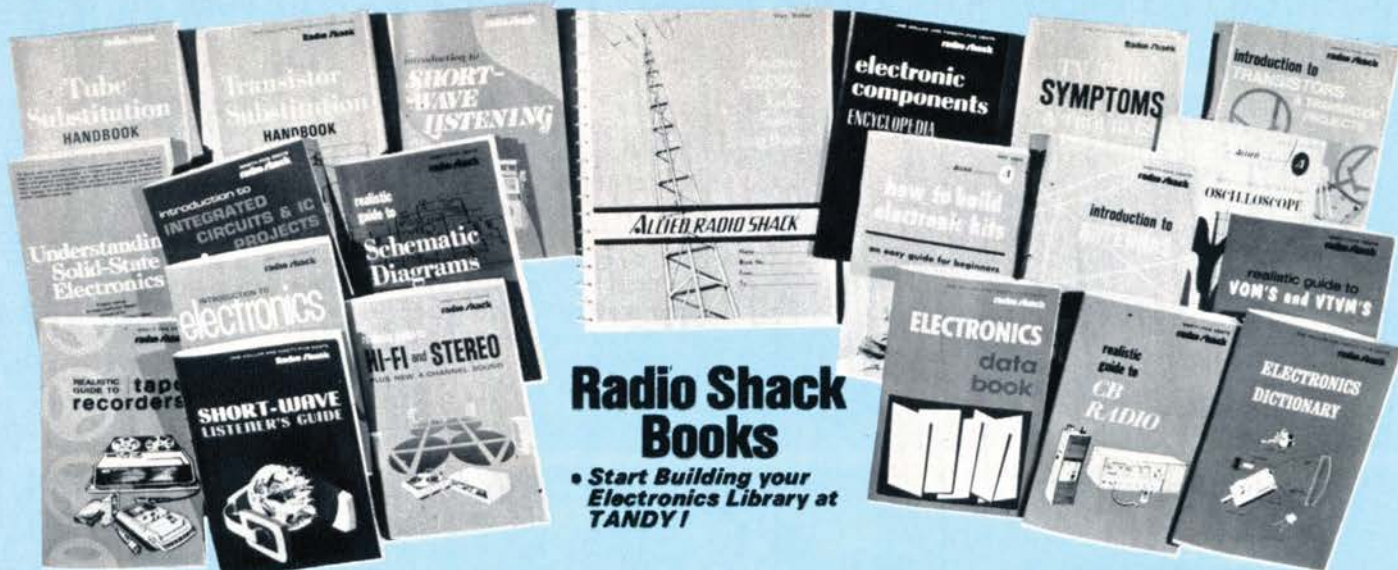

Radio Shack Books

• Start Building your Electronics Library at TANDY!

Reference

Tube Substitution Handbook. Over 12,000 direct substitutions for picture tubes, radio/TV, special-purpose, foreign and domestic tubes.
62-2030 96 pages 99 P

TV Tube Symptoms. Trouble-shooting guide shows hundreds of common problems caused by defective tubes. Tells how to isolate, test and replace suspected tubes. Fully illustrated.
62-2033 96 pages £1.19

Electronics Data Book. Complete source of electronics information - formulas, laws, maths, broadcast standards, codes, symbols, etc.
62-2040 112 pages 59 P

Electronic Dictionary. Readable definitions & clear illustrations explain over 4,800 electronics terms.
62-2047 112 pages 69 P

Electronics Components Encyclopedia. Explains most common electronic parts and how they work in circuits. Perfect way to learn what to look for in electronics. Each entry clearly and concisely written.
62-2048 112 pages 69 P

Projects

Introduction to Transistors & Transistor Projects. History and theory of transistors. Plans for AM radio, amplifier, tone generator, light meter, unijunction timer, dark and light activated relays, etc.
62-2041 112 pages 59 P

Introduction to Integrated Circuits & IC Projects. Explains how integrated circuits work and how they are manufactured. Projects include amplifier, AM tuner, code oscillator, high-frequency tuner, more.
62-2042 96 pages 59 P

How to Build Electronics Kits. Discusses many currently available kits, how to use instruction manuals, simple kit-building tools.
62-2038 96 pages 59 P

Transistor Projects, Volume 1. Twelve educational projects - CB crystal oscillator, power supplies, electronic thermometer, lie detector, siren, electronic metronome, slave flash unit, light meter, etc.
62-2080 96 pages 69 P

Integrated Circuits Projects, Volume 1. Metal detector, geiger counter, voice scrambler/unscrambler, light organ, digital counter, counter-feit coin detector, sound telescope, signal injector, more.
62-2090 96 pages 69 P

How to Build Speaker Enclosures. Get extra value by building your own speaker system - bass-reflex, infinite baffle, many more designs.
62-2055 144 pages 69 P

HAM-SWL-CB

Shortwave Listener's Guide. Lists stations by country, city, call letters, frequency, power, transmission times. With log. Get extra enjoyment from any radio equipped with shortwave bands.
62-2032 96 pages £1.19

Introduction to Shortwave Listening. Tells how to get the best reception with your radio, choosing the right antenna, more.
62-2052 96 pages 59 P

General Electronics

All About High-Fidelity and Stereo. Explains principles of mono, stereo, 4-channel. What to look for in a stereo. How to get more enjoyment from the system you choose.
62-2043 96 pages 59 P

Getting Started in Electronics. Easy to understand introduction to basic radio theory. Hundreds of examples from actual equipment.
62-2045 112 pages 59 P

Guide to Tape Recorders. How to get the best tape recorder for your money! Simple tips on how to use recorders. Maintenance hints to prolong recorder life.
62-2046 112 pages 59 P

Schematic Diagrams. Learn the "language" of electronics. Explains how each component works and what it does in actual circuits. Discusses both tube and transistor circuits, how to follow signal-flow.
62-2049 112 pages 59 P

Oscilloscopes. How to use oscilloscopes for wave-form analysis, frequency response curves, servicing, much more.
62-2050 96 pages 59 P

Understanding Solid-State Electronics. Basic course in semiconductor theory prepared by Texas Instruments Learning Centre. 12-lesson, self-teaching course with quizzes and glossaries.
62-2035 244 pages £1.19

Guide to VOM's and VTVM's. Use your meter to service radio, TV, hi-fi, amateur & CB radios. Step-by-step directions.
62-2039 112 pages 59 P

Check out these compact VOM kits that really measure up!



Archerkit Portable „Test Benches“

A. 50,000 Ohms/Volt Sensitivity. High stability precision circuit. VA/2 switch cuts voltage & current ratings in half, and DOUBLES sensitivity! Volts: DC, 0-0.3-0.6-1.5-3-6-12-30-60-150-300 600-1200. AC, 0-3-6-15-30-60-120-300-600-1200. DC Current: 0-30-60 μ A, 1.5-3-15-30-150-300 mA, 6-12 A. Resistance: 0-3k-300k, 3-30 meg (centre scale 15). dB: -10 to +17. Accuracy \pm 3% DC; \pm 4% AC. AC output jack. With leads and banana plugs. 146x101x63 mm.
28-3986 £12.95
23-468 „AA“ batteries, 3 required each 6 P

B. 20,000 Ohms/Volt Sensitivity. Trouble shoot all types of electronics. DC Volts, 0-5-25-100-500-1000; AC Volts, 0-10-50-250-1000; DC Current, 50 μ A-250 mA; dB, -5 to +62; Resistance, 0-20k-2 megs. Accuracy: \pm 3% DC, \pm 4% AC. Diode protected meter, 1% resistors, zero adjustment. With test leads: 89x132x43 mm.
28-3984 £8.95
23-468 1 „AA“ battery 6 P

C. 1000 Ohms/Volt Sensitivity. All purpose 9-range tester for AC & DC voltage, DC current & ohms. Pin jacks for all ranges, 2-colour meter scale, zero adjustment. With instructions, test leads, manual.
28-122 £5.95
23-468 1 „AA“ battery 6 P

Science Fair P-Box - America's Most Modern & Practical Hobby Kit!



Every P-BOX is designed and engineered by Tandy to let you build like a „professional“ by breadboarding – the same development technique used in the electronics industry! Teachers help us write the instructions and prepare easy-to-follow pictorial diagrams to let you learn electronics as you build. The result is a product with real use-value at amazingly low cost. The whole package serves a purpose – there's no waste: the transparent cover becomes the „bottom“ and the bottom becomes the Perfboard top. You can use the direct heat of a soldering iron to cut any size chassis opening. You can remount parts, change circuitry, and add to, or alter, your kit at will. Be your own engineer. Straight forward circuits and quality components assure proper performance and long-lasting operation. The whole concept is called the „P-BOX“, and it's so special we've applied for a patent!

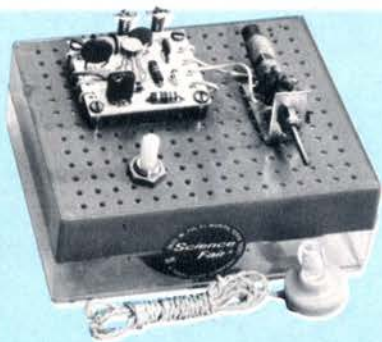

IC AM Radio Kit.

Delivers great AM sound from speaker or plug-in earphone. Simple, no-instruction alignment. Parts, earphone, instructions.

28-111 £ 4.49
23-464 9V battery 19 P



3-Transistor SW Radio Kit.

Tune in the world on 4.5-50 MHz. Regenerative high-gain detector, 2 audio amp stages. Earphone included.

28-110 £ 5.95
23-464 9V battery 19 P



„Goofy-Lite“ Lamp Flasher Kit. Safe and fun! 5 neon lights flash in sequence or at random.

28-130 £ 4.95
23-468 1.5V „AA“ battery, 4 required 6 P each

More exciting Science Fair P-Box Kits!

Voice-Controlled Relay Kit.

Starts a recorder, etc., when sound is present; automatically turns it off when sound stops. DPST relay.

28-131 £ 4.95
23-464 9V battery 19 P

One-Tube AM Radio Kit.

Tune 540-1600 kHz AM band. Safe low-voltage DC operation.

28-100 £ 3.95
23-468 „AA“ battery (1 required) 6 P
23-097 22.5V battery (1 required) 27 P

3-Way Code Oscillator Kit.

Learn Morse Code the easy way! Speaker, code guide, instructions. Connectable for 2-way transmission. Easy to build and use.

28-105 £ 3.29
23-468 1.5V „AA“ battery (4 required) 6 P each

„OTL“ Audio Amplifier Kit.

Gives clean mono sound with transformerless output. Safe low-voltage operation. Use it with AM radio kit (28-102). 3.2-8 ohms.

28-106 £ 3.49
23-468 1.5V „AA“ battery (4 required) each 6 P

Siren Kit.

Emits „rise-and-fall“ sound. Use it anywhere. On/off switch included.

28-107 £ 4.49
23-468 1.5V „AA“ battery (1 required) 6 P
270-383 Battery clip 49 P

Visible Light Transmitter/Receiver Kit.

Experiment with optoelectronics – the science of light energy! Includes Light Emitting Diode, phototransistor, mike.

28-108 £ 4.49
23-464 9V battery 19 P

2-Transistor FM Radio Kit.

Sensitive enough to receive most FM stations in your area. Battery operated – 100% safe. With instructions.

28-115 £ 4.95
23-464 9V battery 19 P

Telephone Amplifier Kit.

Hear both sides of phone conversations! With speaker, cord, suction cup and magnetic pickup – easy hookup. Aids the hard-of-hearing too!

28-116 £ 4.95
23-464 9V battery 19 P

Electronic Metronome Kit.

Makes a steady „clicking“ beat. Great for music lessons, practice sessions! Easy-to-set speed adjustment. Fun to build – and useful!

28-118 £ 3.95
23-464 9V battery 19 P

Extension Speaker Kit.

Great for use as a recorder or radio extension speaker. Gives clean, full sound. Works with any 8-ohm audio output. 1.8 m lead wire. P-BOX is the speaker case. Easy, quick assembly.

28-123 £ 1.49

Photo Night-Light Kit.

Adds home protection! Automatically turns light ON as room darkens. Built-in light, battery holder. Works anywhere.

28-126 £ 2.55
23-467 1.5V „C“ battery 8 P

Light-Operated Alarm Kit.

Makes a shrill alarm when light source is broken. Perfect burglar or door alarm. Mount or place anywhere. SCR operated.

28-128 £ 3.99
23-468 1.5V „AA“ battery 6 P

Electronic Organ Kit.

Imagine – YOU playing an organ YOU built! 7-note scale (A-G). Pushbutton switches, tuning control, speaker.

28-101 £ 4.95
23-464 9V battery 19 P

Heads & Tails Kit.

Ask it questions, sharpen your reflexes by trying to stop the light you want. Pressing the button stops one of two flashing lights at random – the „decision maker“!

28-124 £ 3.45
23-464 9V battery 19 P

Metal Locator Kit.

Locate lost jewellery, coins – any hidden metal object! Operates the same as larger units. Tone shift in earphone designates a „find“!

28-134 £ 3.95
23-464 9V battery 19 P

Transistor AM Radio Kit.

Also usable as a tuner. Solid-state. With all parts, earphone, instructions included. Easy to build and it gives low-cost portable AM listening.

28-102 £ 2.99
23-464 9V battery 19 P

Bell/Buzzer Code Key Kit.

Fun to build and use. Learn and send Morse Code; learn the basics of telecommunications electronic circuitry. Simple, informative.

28-112 £ 1.99
23-468 1.5V „AA“ battery 6 P

Wireless AM Mike Kit.

Have your own transmitting station! Broadcast through any AM radio up to 20 feet away. Mike, instructions included.

28-103 £ 2.99
23-464 9V battery 19 P

Automatic Windscreen Wiper Control Kit



Very compact — fits under dashboard!

- **Eliminates „dry wiper“ action in light rain or mist!**
- **Prolongs wiper blade life!**

Essential aid for driving safety! Thumb-wheel controls let you adjust for „wiper sweep“ as you need it — from once a second to once a minute. Just connect 2 wires to wiper control switch. Easy to assemble. For 12V negative ground. Only 101×50×50 mm.

28-4011 £9.95

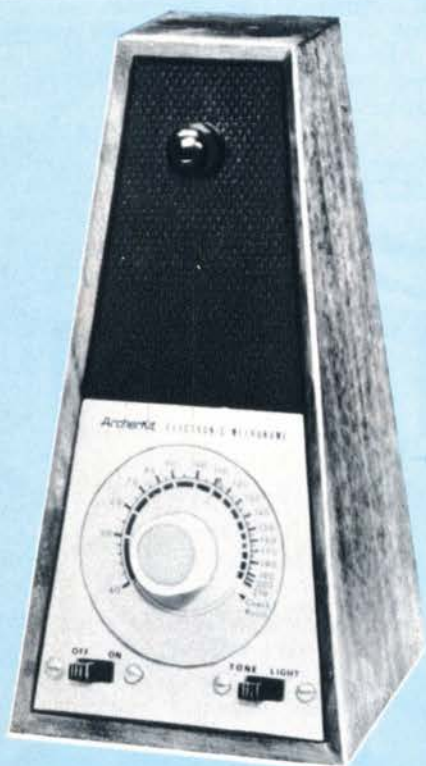

Archerkit Electronic Metronome

- **Sure, steady beats!**
- **Light or tone signal!**
- **Adjusts to any tempo!**
- **Select from 40 to 210 beats per minute!**

Gives a „feel“ for music and its proper tempo. Great for beginners, accurate enough for professionals! Flashing green light lets you play along without using an audible beat note. All electronic — no springs! Solid-state circuit, battery operated. Goodlooking wooden case. Easy to assemble. 228×101×89 mm.

28-3392 £7.49
23-464 9V battery 19 P

Archerkit Electronic Ignition



Deluxe Capacitive Discharge System Kit.

Finest ignition system we've ever offered! Get 50% more spark energy for complete combustion — spark magnitude is 3-5 times normal. Get quicker starts, faster acceleration, longer plug life and improved petrol consumption. In/out switch for instant performance comparisons with your regular ignition. Weather-sealed case. For 12V negative ground. Installs easily! 76×140×89 mm.

28-3203 £28.95



Hotter spark for more acceleration



Faster starts even in sub-zero weather



Cuts down on expensive repair bills



Stereo Headphone Kit

Very Hi-Fi! Very comfortable!

- **Listen at any volume — only YOU hear the music!**
- **Lightweight for long wear!**

A very low price for stereo that sounds like a million! Padded earcushions and headband! Adjustable volume controls on each earcup! Chromed metal parts! Specially shaped earcups seal out ambient room noise! 50-17,000 Hz response. 8-24 ohms. Easy assembly.

28-3389 £13.49

Archerkit High-Intensity Timing Light Kit.



High-impact case, comfortable trigger switch

- **Built-in DC power supply for very visible flashes even in daylight!**



Helps tune and adjust any engine for full power, high fuel economy. For checking ignition timing, synchronisation of double-breaker arms, automatic spark advance, distributor cam wear. 600V flashtube delivers up to 1250 flashes per minute. For 6/12V pos./neg. ground, 8-6-4 cylinders. With insulated clips, cables, sparkplug adapter. Assembles in one evening!

28-4016 £14.95

Build More Fun and Convenience Into Your Life!



£ 27.45

16.5 cm circular coil

Be a 20th Century prospector – unearth buried valuables!

Treasure Finder Kit

Find lost coins, jewellery and relics, pipes hidden in walls – anything metallic! Integrated circuit for high stability, Faraday shield for maximum sensitivity, sealed coil, 90 cm telescoping handle. Speaker gives audible indication when approaching metal object; meter gives visual indication. With all parts, instructions included. Good hunting!

28-4010 £27.45
23-464 9V battery (2 required) each 19 P



£ 6.95

Pair

Wire-Type 2-Station Intercom Kit

- Easy to build and operate!
- Battery powered!

Press the „call button“ to talk, release to listen. Great for monitoring nursery or sick room. Master unit has volume control. With 20 m wire, solder, instructions. Each measures 76×45×101 mm.

28-3334 Pair £6.95
23-464 9V battery 19 P



£ 14.95

Science Fair Metal Locator – the kit for fun and profit!

Sure to pay for itself in fun and excitement! Find coins, gold, silver, lost valuables, quickly and easily. Set volume and pitch slide-controls for constant tone in earphones (included!). Pitch increases when highly-sensitive PC board detector plate nears a metal object. Shaft expands from 40 cm to 90 cm. Battery operated. Illustrated manual included. Easy to assemble!

28-181 £14.95
23-464 9V battery 19 P

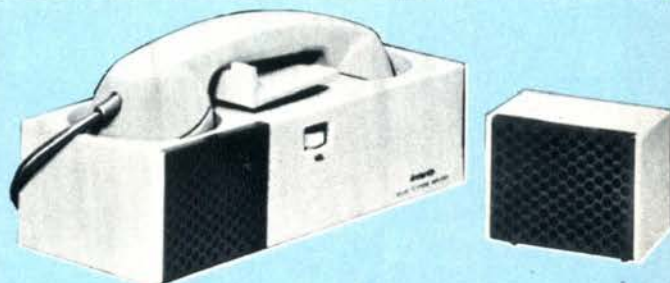

Handy Two-Way Telephone Amplifier Kit

For hands-free conversations!

- Ideal for family or business conference calls!
- Greatly helps the hard-of-hearing!

Easy-to-build amplifier, with separate speaker, allows you to continue writing or working without interrupting your phone conversation! Place the receiver on the cradle, then talk or listen – your hands are free! Others can participate in the conversation too. Instant on – requires no „warm-up“. With earphone, instructions. Master: 260×114×107 mm. Speaker: 89×50 mm.

28-3332 £8.95
23-464 9V battery 19 P

Lie Detector Kit

- Pocket size – take it anywhere!
- Play „truth“ games at parties!

Learn the truth, the whole truth and nothing but the truth! Sensitive psychogalvanometer gives audible indication of changes in body due to nervousness. Hooks-up with two fingertip controls. Quick, easy to assemble – just watch out for „loaded“ questions! Battery operated.

28-182 £7.95
23-464 9V battery 19 P

The Greatest SCIENCE FAIR Electronic Lab Kit Ever!

The exciting world of electronics right at your fingertips!

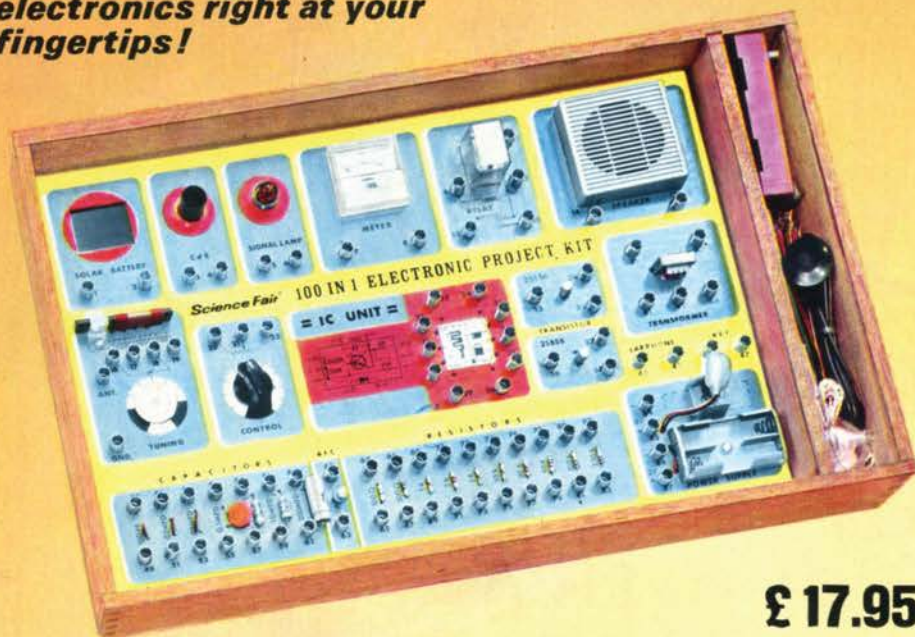

100-in-1 Electronic Project Kit

- 100% safe battery operation!
- Change circuits with NO soldering!
- Fitted case – sturdy and attractive!

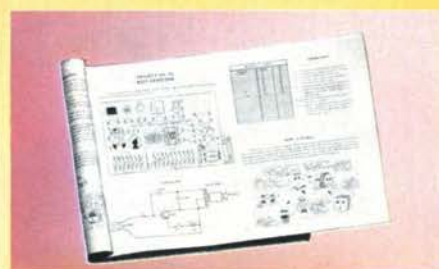

£ 17.95

Build projects, experiments – using the latest electronic principles.

A whole Pandora's box of projects that will get you started on one of the most rewarding of all hobbies! Build radios, amplifiers, code oscillators, computer circuits and many others. 100 projects

in all! You learn as you go along. Spring-type connectors – no soldering or tools required. 45×28×5 cm.

28-220 **£17.95**
23-464 9V Battery (1 required) Each .. **19 P**
23-468 AA Battery (2 required) Each ... **6 P**

Big Lab-type Manual

Educational Manual-full of projects and electronics information. Explains the „hows” and „whys” of each circuit!

Tune in the World



Science Fair „Globe Patrol”

Build a world of listening adventure and learn electronics at the same time! Tunes AM plus 3 SW wavebands from 1.5 to 30 Mz. Solid-state, printed circuit board construction – can be assembled with just 5 common tools! Bandspeed control, earphone jack, frontal speaker. Attractive moulded case with an aluminium panel. Includes a 32 page manual with a „where to listen” guide. Battery powered. 13×23×10 cm.

28-205 **£15.95**
23-467 „C” Battery (4 required) Each **8 P**

Solid State 15-note Electronic Organ Kit



It really plays!

- All spring-clip assembly – NO soldering!
- Plays any song over 2-octave range!

A really fun kit to build that is fun to use too! You'll be surprised at the great sound you get from an instrument you have built yourself! Fully tunable, PC board, pre-cut wires for easy assembly. With speaker, batteries, fitted hardwood case and songbook!

28-215 **£ 6.95**

"Build" Yourself a Real Electronics Education!



£ 14.95

Science Fair 65-in-1 Electronic Project Kit

- **Solderless spring clips!**
- **SCR, Zener diode, transistors, all included!**
- **Pre-cut wires!**
- **Perform up to 65 educational experiments!**

An exciting, easy-to-use kit which lets you learn and demonstrate the theory of „space

age" electronics. Build alarms, radios, intercoms, computer and test equipment circuits, AM transmitter and many more! You can perform solar-powered experiments, too! Point-to-point connections simplify wiring. 100% safe battery operation. Complete with all necessary parts including solar battery, transformer, code key, photo cell, meter, earphone, speaker. Attractive wooden case. 44×28×5 cm.

28-250 **£14.95**
 23-464 9V battery (1 required) **19 P**
 23-468 „AA" battery (2 required) **6 P** each

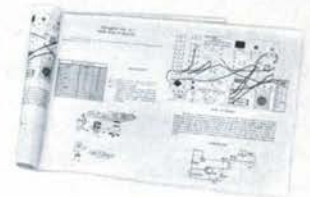

Educational manual

Gives easy-to-follow instructions and illustrations of each project. Explains each circuit, and how it works.

2-Transistor AM Radio Kit

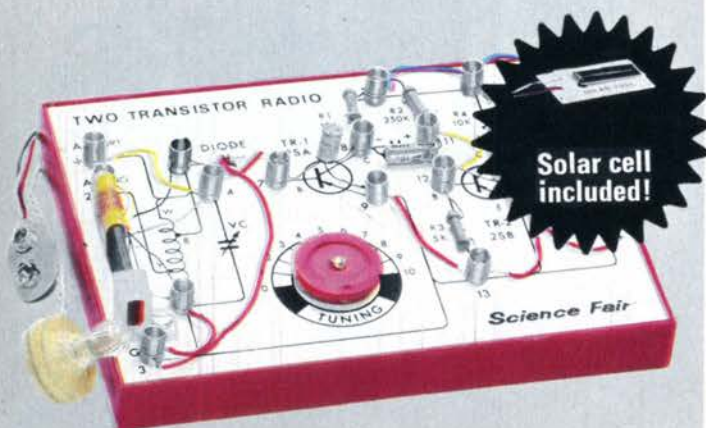

Ideal first kit for students or aspiring hobbyists. Offers hours of entertainment plus a priceless „basic training" in electronics. Works on battery or solar cell power! Easy, no-solder connections. Includes all necessary parts, solar cell, earphone and detailed operating and assembly manual.

28-214 **£3.99**
 23-464 9V battery (1 required) **19 P**

AM Crystal Radio Kit



Requires NO batteries or AC current, NO tubes or transistors – yet it really works! Tunes stations with the same type of circuitry used by Marconi for the first radio transmissions. Operates on a tunable crystal so that you can use it anywhere. Get years of listening without ever having to replace a battery or parts! With everything needed for easy assembly, plus earphone.

28-207 **£3.49**

The "New Generation" Lab Kit for Primary Scholars



Science Fair 40-in-1 Electro-Magnetic Experimenter Kit.

- **NOW - Students from 6 to 12 years can learn the magic of magnetism and the wonders of electricity!**
- **Each project is battery powered and 100% safe!**

Any youngster aged 6 to 12 (or older!) will get hours of educational fun from this exciting kit! Build fascinating projects that really work - 40 in all! Make a compass, motor spinning wheel, windmill, electric fan, underwater metal finder, light dimmer, flashers, buzzers, alarms and many more. Circuits are easily changeable using solderless spring clips. Complete with switches, lamps, code key, rheostat, meter, buzzer, electro-magnet, magnet switch. Detailed manual explains the „ins“ and „outs“ of functioning circuits.

44x28x5 cm.
 28-252 £12.95
 23-468 „AA“ battery (4 required) each 6 P



Pith balls

Round & Tubular magnets



Code key



Reed switch

Science Fair 20-in-1 Modular Experiment Kit



- **Build radios, alarms, testers . . . !**
- **100% safe battery powered circuits!**
- **Change circuits with no soldering!**

A ton of fun for all ages! Electrical-component modules let you change and interconnect circuits for different projects. Includes a tuning capacitor, test probes, Morse Code key, earphone, manual.

28-245 £8.99
 23-468 7 P

Science Fair 10-in-1 Junior Electronic Lab Kit

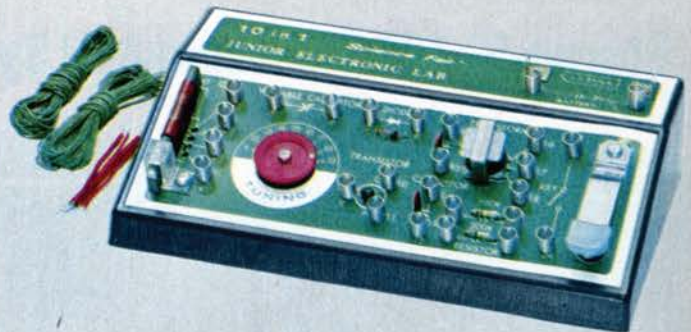

Build these 10 exciting projects!

- **Germanium diode/transistor radio**
- **Home broadcasting radio station**
- **Signal tracing amplifier**
- **Germanium diode radio**
- **Transistor amplifier**
- **Signal injector**
- **Transistor radio**
- **Morse Code oscillator**
- **Audio frequency oscillator**
- **Home burglar alarm.**

Spring terminals provide simple wire connections for up to 10 different circuits. 24 page manual has illustrations of each project and schematic diagrams. Tuning capacitor, code key, earphone, antenna/ground wires included. Safe battery operation!

28-225 £5.59
 23-468 7 P

Realistic CONCERTMATE-8- with Air Suspension Speakers



£ 79.95

AM/FM Stereo Radio with 8-Track Tape Player

Deluxe 3-piece compact unit which is a complete home music centre! Listen to AM, FM stereo or 8-track tapes. Inputs for record changer with ceramic cartridge; outputs for stereo headphones and tape recorder. Air-suspension speakers give full-range response with solid, deep bass. Radio features a dial which blacks-out completely when off - is electric-blue when on - plus stereo

light. Built-in AM and line cord FM antennas. The tape player has lighted programme indicators and automatic or manual programme change. Bass, treble, volume and balance controls. Control centre measures 451×260×105 mm. Speakers: 197×260×171 mm.

12-2088 **£ 79.95**

- Beautiful Walnut-finish wood cabinets!
- Attractive „black-out“ dial!
- Sounds as good as it looks!

„Stereo-3“ AM/FM Bookshelf System



- Beautiful Walnut-finish!
- Enhances any decor!
- Phono and tape inputs!

Three-piece stereo ensemble - ideal for the bedroom, study, dining room or even the kitchen! Luxurious walnut-finish enclosures are perfect bookshelf size. The two 10 cm speakers can be separated up to 3 m for great stereo separation - you can even wall-mount them! Lighted slide-rule dial, FM stereo light, AFC. Inputs for stereo tape player, ceramic record changer. Full-range tone, volume and balance controls. Stereo headphone jack for private listening. Built-in AM and line-cord FM antennas. Self-sticking felt anti-scratch pads included. Each unit measures 241×171×120 mm.

12-1451 **£ 46.95**

Tandy Leads the 4-Channel Field!



4-Channel Stereo Receiver with 4 Speaker Systems!

- 36 Watts (IHF) gives solid bass!
- SQ & Quatravox for TRUE Quadraphonie plus enhanced Stereo!
- 4 balanced speaker systems!

Realistic Modulaire-4: Quadraphonie is the „in“ sound – giving live-performance realism! And at last here is a Quadraphonic System that you can really afford! The SQ decoder lets you enjoy hundreds of records, tapes and broadcasts in thrilling 4-channel. And the Quatravox decoder gives new depth and realism to stereo recordings. Glide-Path volume controls, thumbknob balance controls. And there are inputs for playing

discrete 4-channel tapes, for ceramic phono, and inputs and outputs for stereo tapes. Pushbutton speaker on/off, power switches, FM stereo light, tuning meter bass & treble controls. 4-channel headphone jacks. Control centre: 127×419×279 mm. Speakers: 305×210×127 mm.

12-1444 £119.95

Realistic AM/FM Clock Radios - Convenience and Quality!

Realistic Digital Radios wake you to radio or buzzer alarm. They feature easy-to-see illuminated flip-type numerals and 24-hour alarm settings. On top of this, they have „snooze bars“ so that upon waking in the

morning – and falling asleep again – the alarm will ring again each 5 minutes until you get up! And a 60-minute sleep switch lets you go to sleep with the radio on – it switches itself off automatically after 60 minutes!



Chronomatic-108 It's different! The moulded, modular case has a pedestal base, elevated front with 30 cm curved and smoked dial cover. Top-mounted pushbuttons for on/off, auto/manual. Built-in AFC, top-mounted speaker, lighted slide-rule radio dial, ceramic filter for clear FM. Line cord FM antenna, ferrite-bar AM antenna. Complete with earphone jack. 292×171×111 mm.

12-1495 £36.95



Chronomatic-104 Classic styling with all the features! Full-size numerals, pushbuttons for on/off and auto/manual, AFC and ceramic filter for clearest FM sound. Base-mounted radio/buzzer switch, earphone jack. Side-mounted volume and tuning controls. Lighted slide-rule radio dial and clock face. With line-cord FM antenna and ferrite-bar AM antenna. Walnut wood grain case. 343×146×108 mm.

12-1494 £34.95

Realistic Radios at Realistic Prices



Realistic LW/AM/FM Portable

- **Battery/AC**
- **Slide-rule tuning**
- **Tone control**
- **Big speaker**

Our finest portable radio! You get great LW/AM/FM reception because of our built-in LW/AM ferrite bar antenna and disappearing FM whip antenna. A folding handle supports the radio at a perfect angle for desk use! 280×160×70 mm. Automatic switching to AC when the line cord is plugged in! Batteries included.

12-9101 £18.95

£ 18.95



At last - an AM/FM radio that fits your pocket - and purse!

- **OTL circuitry for better sound!**
- **Individual FM & AM tuning!**

Separate FM & AM tuning - unusual in a radio this small - for performance that rivals larger and costlier portables. 6.3 cm speaker, built-in AM and telescoping FM antennas. With 9V battery, earphone and carrying strap. 114×70×35 mm.

12-632 £8.95



AM/FM Portable which automatically switches from battery to AC!

Just the right size for indoor or outdoor fun! Advanced design includes slide-rule tuning, sliding volume control, switches for band selection, power and tone. Built-in AM antenna and 60 cm telescoping FM antenna. Then there's a full-sounding 7.6 cm speaker and a lift-up carrying handle. Attractive case in rugged plastic with metal trim. The AC cord stores inside the case. 4 „AA“ batteries and earphone included. 127×212×60 mm.

12-672 £19.95



High-performance, Low-cost Portable

The compact plastic case holds a 7.6 cm speaker which gives a really big sound! Oversized controls for off/on volume and tuning, plus easy-to-see slide-rule dial, make operating this radio a joy! Handy pull-out carrying handle. Other features include earphone and AC adapter jacks, built-in AM and 60 cm telescoping FM antennas. 4 „AA“ batteries included. Measures only 200×140×66 mm.

12-671 £12.95

Unique Realistic Radios



Astronaut-4

- 4-12 and 12-22 MHz SW
- FM/AM
- Battery/AC

The low-priced 4-band portable that tells you what in the world is going on! FET/IC circuitry gets global broadcasts plus all your FM/AM favourites. Fine-tuning on SW, tone control, 8.9 cm speaker, telescopic SW/FM antenna, built-in AM antenna, jack for external antenna. With earphone, 4 „C” batteries and AC cord. 165×228×89 mm.

12-774 £27.95

£ 27.95



Put a Pilot in your Pocket!

AM/VHF Aircraft Radio.

Tune in transmissions from approaching planes and nearby ground stations on the 108-135 MHz aviation band. Separate tuning dials for AM & VHF! Telescopic antenna. Complete with 9V battery, earphone and wrist strap. 114×70×35 mm.

12-630 £12.95



Very portable - only 2 kg!

Dual powered AM Radio/Record Player

REALISTIC PORTIPLAY. Plays 33 $\frac{1}{3}$, 45 & 78 rpm records. Radio plays even when the record player is covered. 45-rpm adapter, 4 „D” batteries, AC cord, earphone jack. 305×305×76 mm.

13-1169 £21.95
12-1398 Extension speaker, 30 cm cord & plug £1.50



FM DESKUBE

AM DESKUBE

A Realistic "DESKUBE" fits anywhere!

7.6 cm Rosewood-finished cubes.

„Instant” radios for music, news and sports

Unique cubes which are handsome and functional wherever you use them - the office, study, bedroom or living room. Volume and tuning controls are set underneath - you tune your favourite station just once. Then just press the play-bar anytime for instant entertainment! Completely portable - they operate on one 9V battery (which is included). Both feature high-sensitivity circuitry and clear, crisp sound from the top-mounted speakers. FM model has telescopic antenna to pull in nearby stations.

12-183 AM Deskube £6.49
12-174 FM Deskube £9.49

Tandy Portables: Travelling Fun in all Shapes and Sizes!

„Archer” Headset Radios

Headset radios for sound wherever you go!

● *Hands-free portables for active, on-the-go people!*

A. The music may be „heavy” – but these headphone radios are light and comfortable – you can wear them for hours! Foam-padded earpieces reduce outside noise and let you enjoy full-fidelity FM or AM from the dual 5.7 cm speakers. The antenna’s out of your way in the adjustable, padded headband. Perfect for listening to your favourite football commentator whilst watching the match – or on the beach – or in a noisy factory! 9V battery included.

12-192 £14.95

B. All the deluxe features of the model above, but AM only. With 9V battery.

12-191 £8.99



AM Pocket Radio

● *With zipped carrying case!*

The portable with the modern shape – fits in your hand or pocket. Push-pull audio output for clear sound. With wrist strap, carrying case, earphone and 2 „AA” batteries. Only 95×76 (at base)×32 mm.

12-646 £4.50



AM Bike Radio

Use it on your bike, at home, or as a portable.

● *Mounts on the handlebars of any bike!*
● *Built-in horn and safety reflector!*

Archer „ROAD PATROL”. Use it as a bike radio or just flip the lever and it’s a portable! Mounting bracket stays on the bike for instant remounting. Pushbutton horn, 7.6 cm safety reflector on the front. Weatherized case.

12-193 £8.50
23-467 „C” battery (3 required) 8 P each



Extension Speaker

7.6 cm diameter speaker in a tubular enclosure which improves the sound of most portables. With 3.6 m cord and 2 plugs.

12-1938 £1.50



Flavoradios

„Tasteful” AM Pocket Portables!

The perfect gift! Decorator designed to add a splash of colour wherever they go! Slim, modern, they fit both pocket and purse. Advanced solid-state circuitry, built-in speaker. With carry strap, earphone and 9V battery. 92×70×38 mm.

12-166 £3.99



Low-Cost AM Pocket Radio

● *With handy carrying strap!*

Fits a shirt pocket or handbag, yet has excellent sound due to push-pull output and transformerless input & output. Large dial for one-hand tuning. 9V battery and earphone included. 108×70×32 mm.

12-167 £3.19



Realistic Portable Cassette Players and Recorders



Available 30 July, 1974.

Realistic CTR-27 With „Auto-Level“ & Remote Control Mike.

- Record Interlock – No Accidental Erasures!
- Input for Direct „Off-the-Air“ Recording!
- Pushbuttons for all Tape Functions!
- Wide Response, Oversize Speaker!

The CTR-27 offers many „high-price“ features at really moderate cost! An all-purpose recorder with fine styling and sound equal to many costlier models. Auto-Level circuit automatically adjusts volume to smooth-out variations in voice during recording. Jacks for remote mike, aux input, earphone, external power sources. Batteries included. 63×130×240 mm.

14-833 £18.95
14-9854 AC Adapter £4.95

Our Super AC/Battery Tape Recorder! What value!



- Built-in Condenser Mike!
- „Auto-Level“ for Perfect Recordings!

Available 30 August, 1974.

Realistic CTR-28. Our low cost, high value, feature-packed cassette recorder. 5 pushbuttons plus eject button make operation really easy. Then there's a safety „interlock“ pushbutton for recording, inputs for

remote control mike, aux and earphone, and built-in AC operation. All this in an attractive, robust case with slide-out handle. 85×140×255 mm.

14-834 £25.95

All-Purpose Battery/AC Cassette Recorder with Built-in Mike



- High-Low Tone Switch!
- Digital Reset Counter!

Realistic CTR-16. The cassette recorder that's great for business and school notes, letter taping – or to take along for extra fun at parties! Oversize speaker for great sound, built-in AC adapter, „Safety Interlock“ record pushbutton, aux inputs, „Auto-Level“ for high quality recordings. External remote microphone, earphone and carrying strap all included. 235×120×63 mm.

14-878 £36.95
23-467 „C“ Batteries (4 required) 8 P each



Available 30 August, 1974.

Realistic „Triple-Play“

Cassette Player/Recorder with Built-in FM/AM Radio.

- Play pre-recorded cassettes or record your own!
- Pause control for easy editing and cueing!
- Built-in condenser mike!

Realistic CTR-18C. A portable music centre for get-away people! You can hear FM or AM and, at the same time, record the programme on a cassette. Or, if you prefer, make „live action“ tapes with the sensitive built-in mike. Automatic level control for perfect volume recordings, Auto-Stop to prevent damage to tapes and heads, AC/Battery operation. Pushbutton tape function controls, record level/battery meter, telescoping antenna, slide-rule FM-AM dial. Attractive case with swivel handle and storage compartment for the AC cord. 194×171×57 mm.

14-822 £54.95
23-467 „C“ Battery (4 required) 8 P each

Realistic Stereo Cassette Record/Play Deck



**With Built-in
Dolby* Noise
Reduction System**

* „Dolby“ is a trademark of
Dolby Laboratories, Ltd.

- **Less noise – with or without Dolbyized tapes!**
- **Bias switch for Chromium Dioxide cassettes!**
- **Memory rewind!**
- **Preamp output level control!**

£ 149.95

Realistic SCT-6C. One of the most advanced cassette decks you can buy! Combines performance that rivals reel-to-reel with cassette convenience. The Dolby Noise Reduction Circuit electronically reduces tape „hiss“ by increasing volume, where distracting hiss would be heard, during recording! For playback, Dolby reduces the increased volume to its original level so you hear the full dynamic range of the recorded music without hiss. Recordings you make at home will challenge professional ones in quality! Tape bias switch selects standard or low-noise CrO₂ cassettes. Memory rewind automatically returns tape to where recording was begun for easy playback. An „Edit Lever“ lets you eliminate unwanted material as you record! Other features include adjustable output and record level controls for individual or simultaneous setting of left & right channels; master record level control; mike jacks; aux

input jacks; dual illuminated record level meters; pushbutton pause for editing and automatic end-of-tape shutoff. Handsome oiled walnut cabinet with brushed aluminium trim.

14-898 £ 149.95

Specifications

Frequency Response (with CrO₂ cassette): 30-15,000 Hz ± 2 dB. Wow & Flutter: 0.14% RMS. Signal-to-Noise (With Dolby): Better than 56 dB. Input Impedance: MIC, 10k; AUX, 100k. Output Impedance: 1k. Output Level: .774 V max., adjustable. Recording Bias: 100 kHz. Erase System: 100 kHz. Dimensions: 420×260×114 mm. Power Requirement: 220/240V, 50/60 Hz AC, 30 watts.

Stereo Cassette Playback Deck



Cassette player on a budget!

- **Total end-of-tape shutoff – mechanical & electrical!**
- **Colour-coded piano key controls!**
- **Rear panel level control!**

Realistic SCP-1. The low-cost way to enjoy the many pre-recorded cassettes now available. The cassette cover has a „pocket“ for fast and easy loading. An output level control lets you match deck's output to any amplifier or receiver. Auto-Stop turns the unit off completely at the end of the tape and prevents damage to unit or tape. Keys control Rewind, Fast Forward, Play, plus two-step Stop/Eject key. Smart styling with walnut-finish cabinet and aluminium trim. Compact: 140×216×82 mm. 220/240V AC.

14-892 £ 28.95

£ 28.95

Realistic 8-Track Recorders and Players



8-Track Stereo Record / Playback Tape Cartridge Deck.

At a price you can afford!

- **Record tapes from any source – play them back through your home system or car stereo!**
- **Programme selector and indicator lights!**
- **Pause control, „Auto-Stop“, fast forward!**
- **Illuminated VU meters, separate level controls!**

£64.95

Realistic TR-881. The deck that's loaded – with value! It has push-buttons for „Auto-Stop“ (which stops the tape at the end of Programme-4 to prevent erasure of already taped material), programme selection (with indicator lights), fast-forward, and pause; dual recording level controls; out-

put level adjustment; mike & Aux inputs. Walnut enclosure. Response: 50–9,500 Hz. Flutter/Wow, 0.3%. 438×127×244 mm.

14-881 £64.95



3-Piece, 8-Track Stereo Player

Play your car tapes at home too!

- **Walnut finish wood cabinetry!**
- **Wide-range speaker systems!**
- **5-Watt power for BIG sound!**
- **Headphone jack and tone control!**

Enjoy prerecorded cartridge tapes at home like you do in the car... at a pleasantly affordable price. This ensemble looks attractive, and sounds great! The 5-watt solid-state amplifier and sealed, matched speaker systems deliver a curtain of room-filling stereo sound. The tape programmes play automatically and continuously, or you can change programmes instantly with the Programme pushbutton. Features include programme indicator lights, a power-ON indicator light, balance, tone and volume controls, stereo headphone jack, and an Aux input for adding a stereo record player. Rotary function selector. Player: 81×393×267 mm. Each speaker: 267×216×203 mm.

14-923 £64.95



8-Track Stereo Playback Deck

- **Auto/Manual programme change!**
- **4 programme indicator lights!**
- **Play your car tapes at home!**

Add it to ANY Stereo System!

Realistic TR-166. Just insert a cartridge to turn on the player, then enjoy up to 80 minutes of non-stop, non-repeat stereo. Remove the cartridge, and the player shuts off automatically. Rear panel output level control for adjusting to any stereo radio or record player. With audio cables and RCA-type plugs. Walnut grain enclosure. A real space-saver – only 178×254×101 mm. Add it to your stereo for great sound at a low cost!

14-1920 £34.95

We have the 8-Track Stereo Cartridge System that does it all!



£ 149.95

- **Records cartridges!**
- **Plays cartridges!**
- **Tunes AM/FM Stereo!**
- **Records as you listen!**



Power on/off pushbutton



Record-Mode Interlock

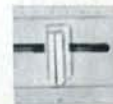

6 Glide-Path linear controls



Jacks for „live“ stereo recording



Slide-rule AM/FM tuning



Pushbutton tape function control



VU Meter for each channel



Six-position selector Switch

Realistic Modulaire-8

AM/FM 8-Track Stereo System

With matched acoustic suspension speakers!

Plug it in and play a tape. Or record a tape. Or tune in FM stereo or AM. It's got what it takes for great sound on them all. No-skimp solid-state circuitry; „Glide-Path“ controls for bass, treble, balance, volume

and left & right recording level; pushbuttons for „Auto-Stop“ (automatic shutoff at the end of Programme-4 to prevent erasure of already recorded material or repeat playback), fast forward, pause and programme selection. The radio has an FET-FM front end, wideband AM, stereo light and

built-in antennas. Headphone jack, aux and phono inputs. Lighted dial and VU meters. Walnut finish wood cabinetry, brushed aluminium panel.

Radio: 565×276×117 mm. Speakers: 270×230×140 mm.

14-924 £149.95