

JVC

SERVICE MANUAL

MODEL

MF-1845L

CASSETTE DECK PLAYER
FM/MW/LW STEREO RECEIVER



No. 2361
November 1975

Index

	Page		Page
Specifications	2	Tuner	21
Features	3	Tuner Parts List	22
The Name of External Parts	3	Control Amp.	24
Parts List of Record Player	4	Control Amp. Parts List	25
Location of Circuit Board	4	Auto Stop	27
Disassembly Instruction	5	Auto Stop Parts List	27
Main Parts Removing	6	Fuse	28
Removal of Mechanical Parts	7	Lever Switch	28
Tuner Alignment	8	Din Jack	28
Cassette Deck Alignment	10	Fuse Parts List	29
Replacement and Adjustment of the Head	10	Lever Switch Parts List	29
Replacing the Head	10	Din Jack Parts List	29
Azimuth Adjustment	10	Push Switch	30
Mechanism Adjustment	11	Ant. Parts List	30
Replacement and Adjustment of the Record Player ..	12	Cds Parts List	30
Troubleshooting	13	Mechanical Components	31
Cassette deck section	13	Mechanical Component List	33
Record player section	14	Record Player Components	34
To String Dial Cord	14	Record Player Component List	34
Block Diagram	15	Assembly Parts Except Enclosure Parts	35
Circuit Board Parts	16	Assembly Parts List	36
Power Amp.	16	Packing	36
Power Amp. Parts List	17	Wiring Diagram	37
Rec/PB Amp.	18	Standard Schematic Diagram	38
Rec/PB Amp. Parts List	19		

Specification

CASSETTE:

Type: Stereo Cassette Deck with ID Mechanism and Automatic Stop

Track system: 4-track, 2-channel stereo

Bias & erase: AC bias (57kHz), AC erase (57kHz)

Heads: Cronios head for Record/Play
Ferrite head with double gap for Erase

Frequency response: (Normal) 30 – 13,000Hz
(Chrome) 30 – 15,000Hz

S/N ratio: Better than 50dB (from peak level)

Wow and flutter: 0.11% WRMS

Crosstalk: 55dB (1kHz)

Channel separation: 30dB (1kHz)

Total harmonic distortion: 2% (1kHz, Normal tape)

Fast forward time: Within 125 sec. (C-60)

Rewind time: Within 125 sec. (C-60)

TUNER:

Type: FM/MW/LW Stereo Tuner (L model)

FM TUNER:

Antenna: 300 ohms balanced

Tuning range: 88 – 108MHz

Sensitivity: 2.7 μ V (S/N: 26dB)

Total harmonic distortion: 0.6% (98MHz)

S/N ratio: 55dB (MONO)

Capture ratio: 3.5dB (98MHz)

Stereo separation: 35dB (1kHz)

Frequency response: 30 – 11,500Hz

IF rejection: 70dB

Image rejection: 53dB (98MHz)

AM suppression: 48dB (98MHz)

MW TUNER:

Antenna: Ferrite bar

Tuning range: 540 – 1,600kHz

Sensitivity: 400 μ V/m (S/N: 20dB)

Total harmonic

distortion: 1.5% (5mV/m)

S/N ratio: 45dB (5mV/m)

IF rejection: 35dB (600kHz)

Image rejection: 42dB (1,400kHz)

LW TUNER (L model):

Antenna: Ferrite bar

Tuning range: 150 – 350kHz

Sensitivity: 1,000 μ V/m (S/N: 20dB)

Total harmonic

distortion: 2% (5mV/m)

S/N ratio: 40dB (1mV/m)

IF rejection: 30dB (340kHz)

Image rejection: 45dB (340kHz)

AMPLIFIER

Continuous power (both channels

driven at 1kHz): 15 watts RMS at 4 ohms (1% distortion) per channel

Music power

at 1kHz: 20 watts at 4 ohms (1% distortion) per channel

Power bandwidth: 30Hz – 20kHz (1% distortion, 4 ohms load)

Tone controls: Bass \pm 10dB at 100Hz

Treble \pm 10dB at 10kHz

Load impedance: 4 ohms

TURNTABLE:

Motor: 4-pole Synchronous Motor

Turntable speeds: 33-1/3, 45 rpm

Platter diameter: 11 inches (28cm)

Drive system: Belt-drive

Cartridge: Moving Magnet

Stylus: Diamond (DT-33H)

GENERAL:

Power source: 220V, 50Hz

Power

consumption: 130 watts

Dimensions: 500(W) x 193(H) x 438(D)mm

(19-3/2" x 7-8/5" x 17-16/3")

Weight: 16kg (35.2lbs.)

Features

High quality Cassette deck

1. Bias & Equalizer separate switches for chrome or new type of tapes.
2. Automatic stop mechanism.
3. Beat Cut SW Built in.

Powerful 3-Band Receiver

1. Solid-State Preamplifier with Tone Controls, Loudness and Noise-Cut Switches.

2. Power Per Channel 15 WATTS RMS (4 ohms) with 1% or less distortion.
3. Attractive Styling and Convertible Power Source Selection.

Record Player

1. Synchronous Belt-Drive Motor.
2. Turntable Cueing, Auto-Reject, Auto-Return, Auto Shut-off.

The Name of External Parts

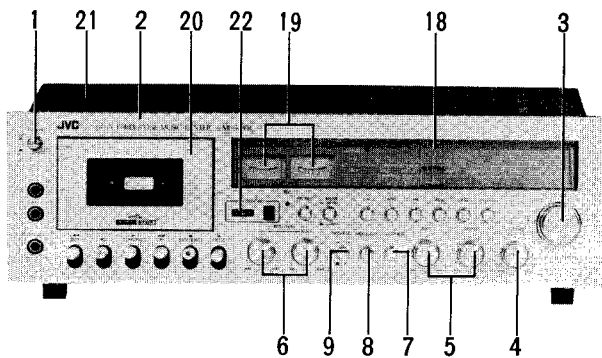

Fig. 1

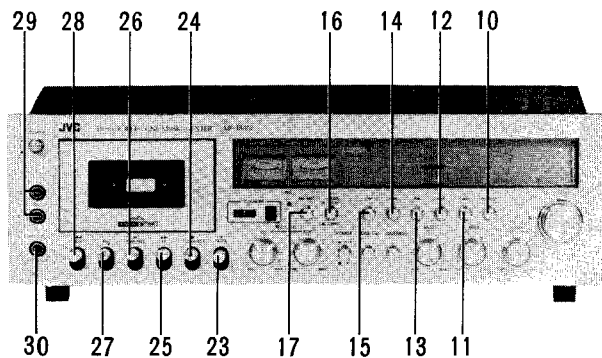

Fig. 2

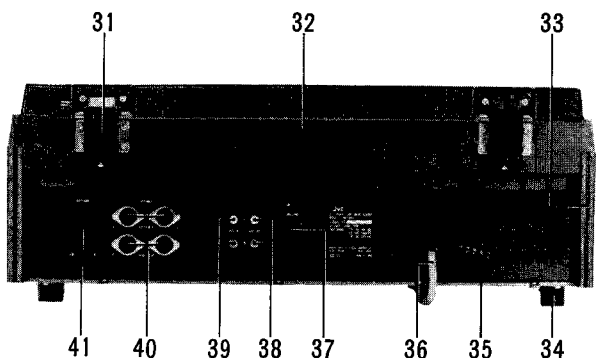

Fig. 3

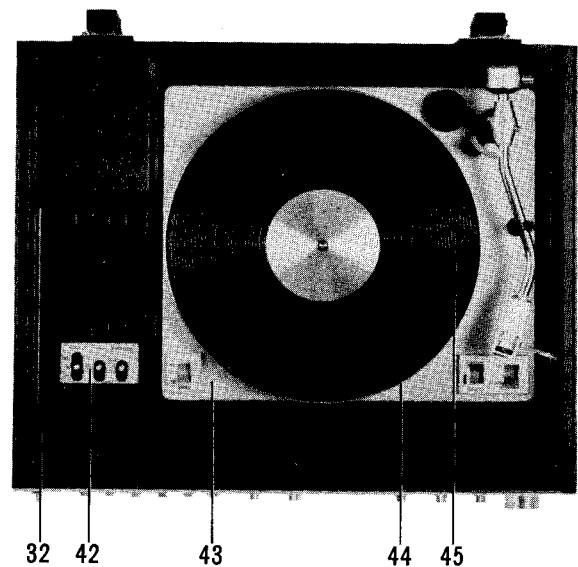

Fig. 4

- | | |
|----------------------|-----------------------------|
| 1. Power SW | 24. Stop/Eject Button |
| 2. Front Panel | 25. FF Button |
| 3. Tuning | 26. Play/Rec Button |
| 4. Volume Control | 27. Rec Button |
| 5. Tone Control | 28. REW Button |
| 6. REC Level Control | 29. Mic Jacks |
| 7. Loudness SW | 30. Phones Jack |
| 8. Noise Cut SW | 31. Hinge Ass'y |
| 9. Speaker SW | 32. Top Panel |
| 10. Phono SW | 33. Side Woods |
| 11. Cassette SW | 34. Feet |
| 12. AUX SW | 35. Bottom Cover |
| 13. FM SW | 36. Power Cord with Plug |
| 14. MW SW | 37. Tape DIN Jack |
| 15. LW SW | 38. Line Out Jacks |
| 16. Mode SW | 39. AUX In Jacks |
| 17. FM MUT SW | 40. Speaker Jacks |
| 18. Dial Needle | 41. AM/FM Antenna Terminals |
| 19. Level Meter | 42. Lever SW |
| 20. Cassette Door | 43. Record Player |
| 21. Top Cover | 44. Turn Table |
| 22. Tape Counter | 45. T.T. Covering |
| 23. Pause Button | |

Parts List of Record Player

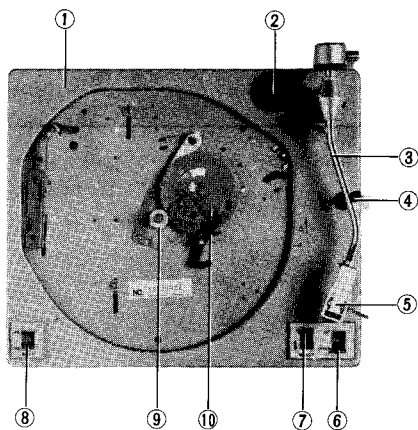

Fig. 5

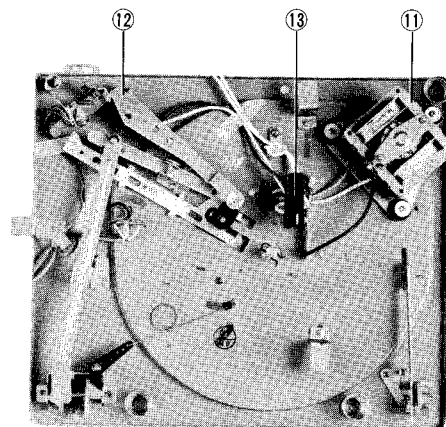

Fig. 6

Dwg. No.	Parts No.	Parts Name	Remarks	Dwg. No.	Parts No.	Parts Name	Remarks
1	YG-00005	Base Plate		8	YG-00010	Select Lever	
2	YG-00031	E.P. Adaptor		9	YG-00017	T.T. Shaft Ass'y	
3	YG-00030	P.U. Ass'y		10	EG-100628	R. Gear Ass'y	
4	EG-100651	Rest		11	YG-00012	MOTOR Ass'y	50/60Hz 100V
5	MD1016B	Cartridge		12	EG-100018	Micro SW	
6	YG-00010	Cue Lever		13	YG-00022	Capacitor	0.047 μ /600V
7	YG-00010	Reject Lever					

Location of Circuit Board

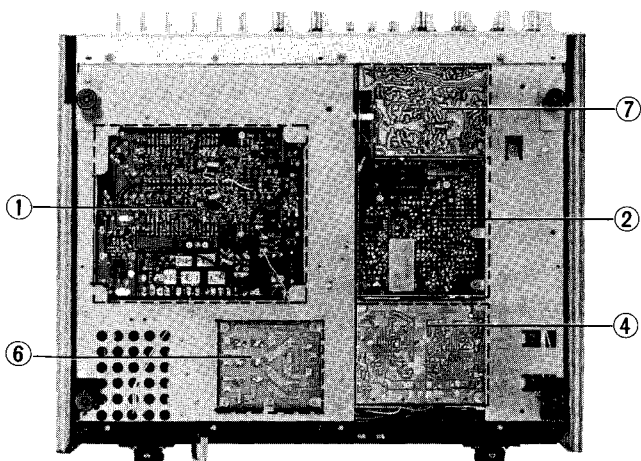

Fig. 7

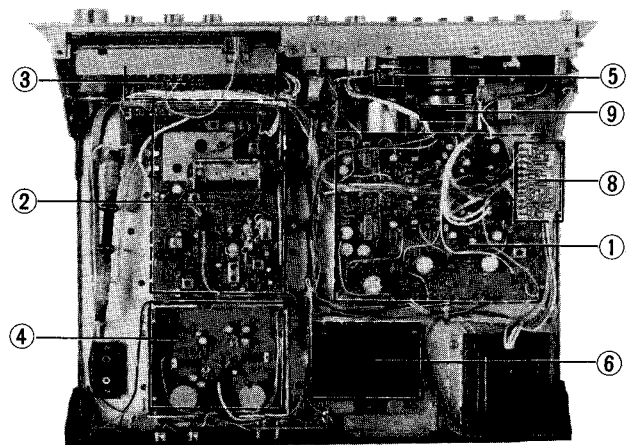

Fig. 8

REF. NO.	PARTS NAME	REF. NO.	PARTS NAME
1	Rec & PB Amp C.B.	6	Fuse C.B.
2	Tuner C.B.	7	Control Amp C.B.
3	Push Switch C.B.	8	Lever Switch C.B.
4	Power Amp C.B.	9	Auto Stop C.B.
5	Cds. C.B.		

Disassembly Instruction

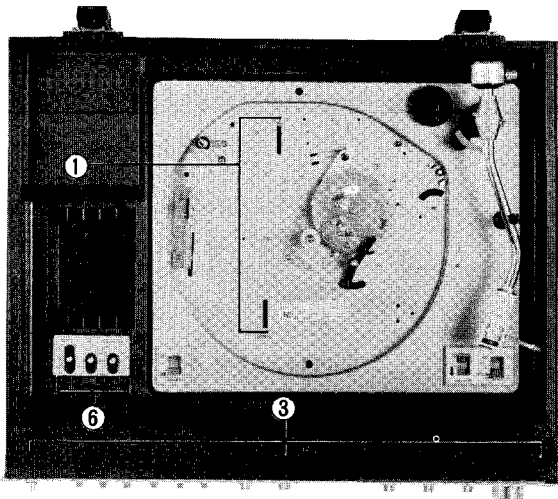

Fig. 9

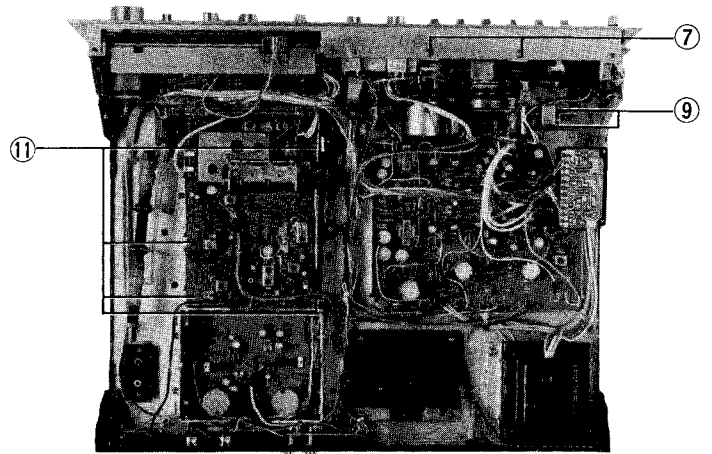

Fig. 13

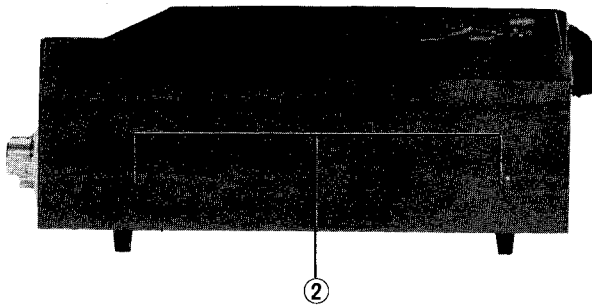

Fig. 10

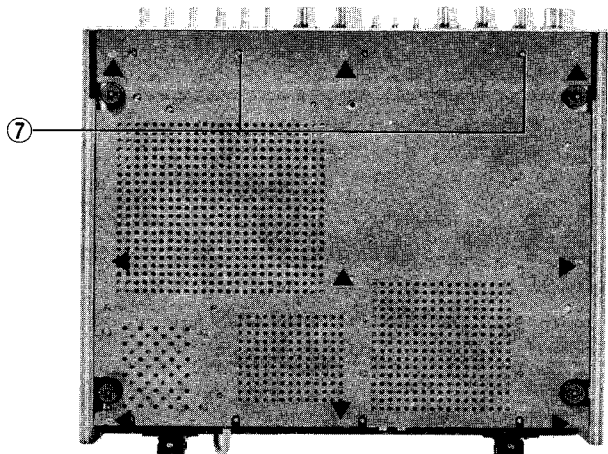

Fig. 14

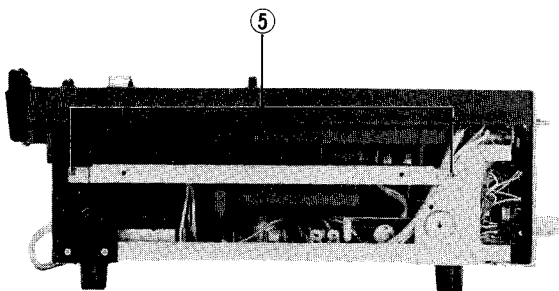

Fig. 11

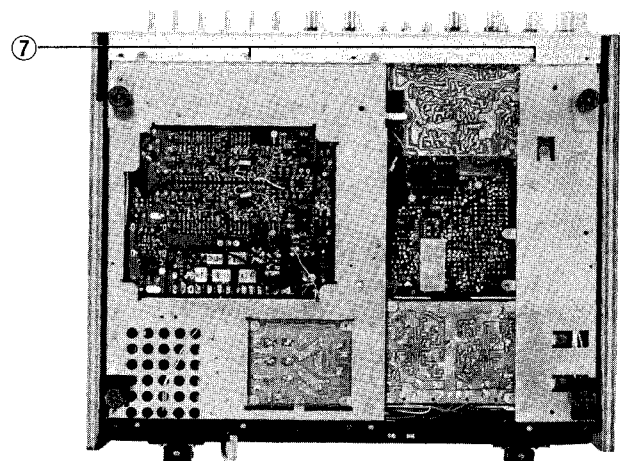

Fig. 15

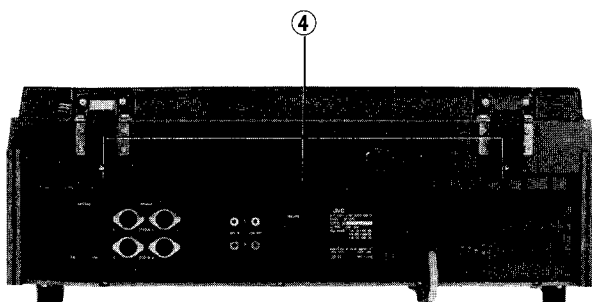

Fig. 12

Main Parts Removing

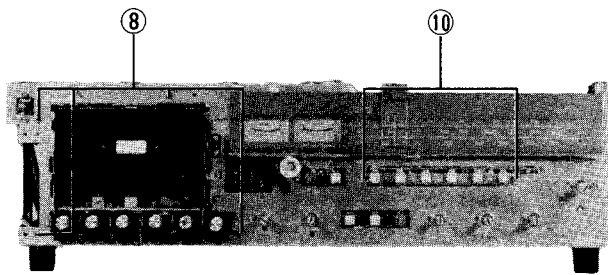

Fig. 16

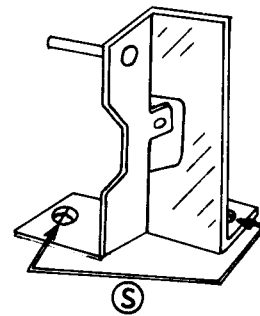

Fig. 17

Parts	Removing	Dwg. No.	Remarks
Player	Loosen 2 screws and slide them to arrow direction.	1	Fig. 9
Side Wood	Remove 4 screws.	2	Fig. 10 both Side-woods of left and right
Top Panel	1. Remove 3 screws on Top panel. 2. Remove 3 screws Back Top panel. 3. Remove 4 screws under Side woods. 4. Remove 2 screws (for Lever SW)	3 4 5 6	Fig. 9 Fig. 12 Fig. 11 Fig. 9
Bottom Board	Remove all screws.		arrows in Fig. 14
Front Panel Ass'y	1. Remove all control knobs. 2. Remove 2 screws. 3. Pull out the Front Panel.	7	Fig. 13,14,15
Cassette Mechanism	1. Remove 4 screws. 2. Remove 2 screws.	8 9 S	Fig. 16 Fig. 13 Fig. 17 TGB291440-0A Bracket Ass'y
Tuner C. Board	1. Remove 2 screws. 2. Remove 4 screws	10 11	Fig. 16 Fig. 13 Remove the Power C.B. in a forward direction.

Removal of Mechanical Parts

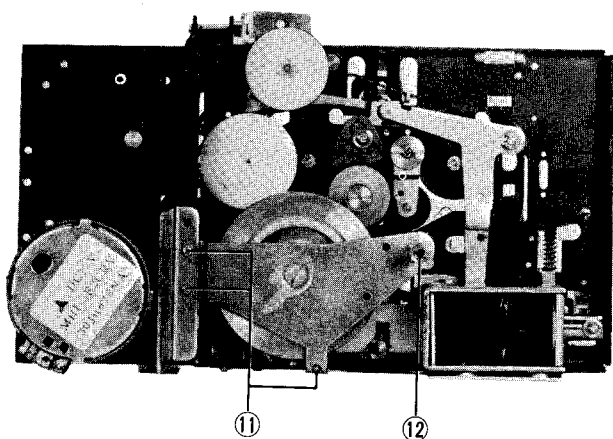

Fig. 18

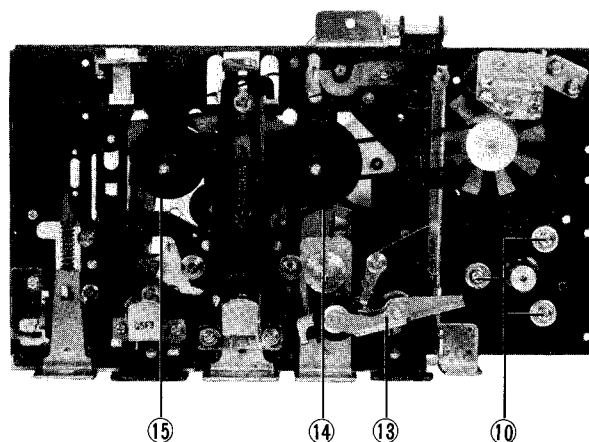

Fig. 19

Parts	Removing	Dwg. No.	Remarks
Motor	<ol style="list-style-type: none"> 1. Unsold wires from P.C. Board. 2. Remove a capstan Belt. 3. Remove the motor. (screw 3pcs) 	10	<p>Be careful not to soil in belt.</p> <p>Fig. 19</p>
Flywheel	<ol style="list-style-type: none"> 1. Remove a capstan belt. 2. Take out a flywheel holder. screw 3pcs 2. Pull out the flywheel. shaft 1 pcs 	11 12	Fig. 18
Pinch Roller Arm Ass'y	Remove an E ring fixing a pinch-roller arm ass'y. E ring 1 pc	13	Fig. 19
Take up Reel (Right) Supply Reel (Left)	<ol style="list-style-type: none"> 1. Take out an E ring fixing take-up and supply reel. E ring 1 pc 2. Take out a reel from the shaft. 	14 15	Fig. 19

- Note:**
1. Don't dirty with Oil or extend excessively the Belts to prevent the increase of wow and flutter.
 2. Adjust the height the Motor Pulley, when replacing the Flywheel-drivebelt, so that the belt will be parallel to the chassis surface.

Tuner Alignment

Power Source; AC 220V (or 240V)
Output measuring; Speaker terminal

AM IF & RF Alignment

Set the volume control to the maximum, the Balance control and the Tone controls to center position.
Input (S.S.G); Modulation 400Hz 30%
; Signal should be given to loop antenna.

Step	Band	Input Frequency	Place to be aligned	Set V. Capacitor to
1	MW (IF)	455kHz	T103,104	Minimum
2		Get seesaw-balled peak output with alternating adjustment of T103,104.		
3	LW	145kHz	L107	Maximum
4		360kHz	C170-a	Minimum
5		Repeat the steps 3 & 4.		
6		160kHz	Bar antenna (LW)	150kHz Signal
7		350kHz	C-169-a	350kHz Signal
8		Repeat the steps 6 & 7 and get seesaw-balled peak.		
9	MW	515kHz	L106	Maximum
10		1650kHz	C170-b	Minimum
11		Repeat the steps 9 & 10.		
12		600kHz	Bar antenna (MW)	Maximum
13		1400kHz	C169-b	Minimum
14		Repeat the steps 12 & 13 and get seesaw-balled peak.		

FM IF & Discriminator Alignments

- Set the Volume to minimize the sound from speakers and set the dial pointer to the high end.
- Connect IF/VF signal of TV sweep generator to the test point TP1. (Fig. 23)
- Connect Scope terminal of the generator with H.INPUT of oscilloscope.
- Connect V.INPUT of oscilloscope with TP2 and chassis. (Fig. 23)
- IF alignment
 - At the first tune off Discriminator with turning the secondary coil core of T102 to counter clockwise. Then the wave shape on scope becomes like as illustrated in Fig. 20.
 - Align the T101,102 (primary) to make the wave shape like as in Fig. 21. Be sure to bring the marker signal 10.7MHz to the center and the peak of the wave shape.
- Discriminator alignment
Align the T102 both primary and secondary coil so that the symmetrical "S" curve will be obtained. And carefully set the marker at the center across the horizontal flyback line. (Refer to Fig. 22)

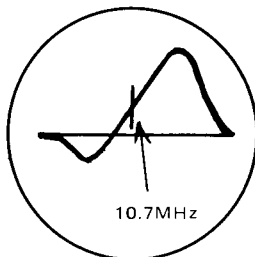

Fig. 20

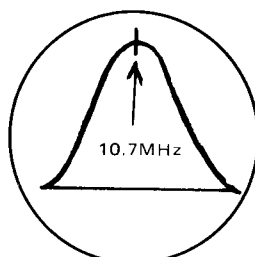

Fig. 21

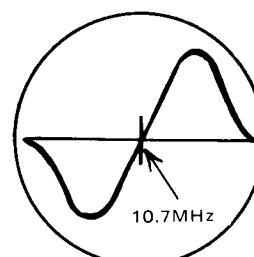

Fig. 22

FM RF Alignment

Input (S.S.G); Use 300Ω baloon modulation 400Hz deviation 22.5kHz (30%).

Step	Band	Input Signal		Place to be aligned	Set V. Capacitor to
		Frequency	Given to		
1	FM	87.5MHz	FM antenna terminal (Refer to Fig. 23)	L103	Maximum
2		109MHz		TC3	Minimum
3		Repeat the Steps 1 & 2.			
4		88MHz	FM antenna terminal (Refer to Fig. 23)	L101, 102	88MHz Signal
5		106MHz		CT1, 2	106MHz Signal
6		Repeat the Steps 4 & 5, and adjust for no further improvement.			

FM MPX Alignment (Refer to Fig. 23)

Input (S.S.G); 98MHz 100μV modulated by MPX signal.

1. 19kHz stage alignment
 - a. Connect the V.T.V.M to the test point "A".
 - b. Feed the signal modulated only by 19kHz to the FM antenna terminals.
 - c. Adjust T105, T106 for maximum output.
2. 38kHz stage alignment
 - a. Connect the V.T.V.M to "A".
 - b. Feed the FM stereo SUB signal.
 - c. Adjust T106 for maximum output.

3. Separation alignment

- a. Connect the V.T.V.M to "A" (Right channel output).
- b. Feed the LEFT channel signal.
- c. Adjust the R135 for minimum output.
- d. Connect the V.T.V.M to "A" (Left channel output).
- e. Feed the Right channel signal.
- f. Adjust the R135 for minimum output.

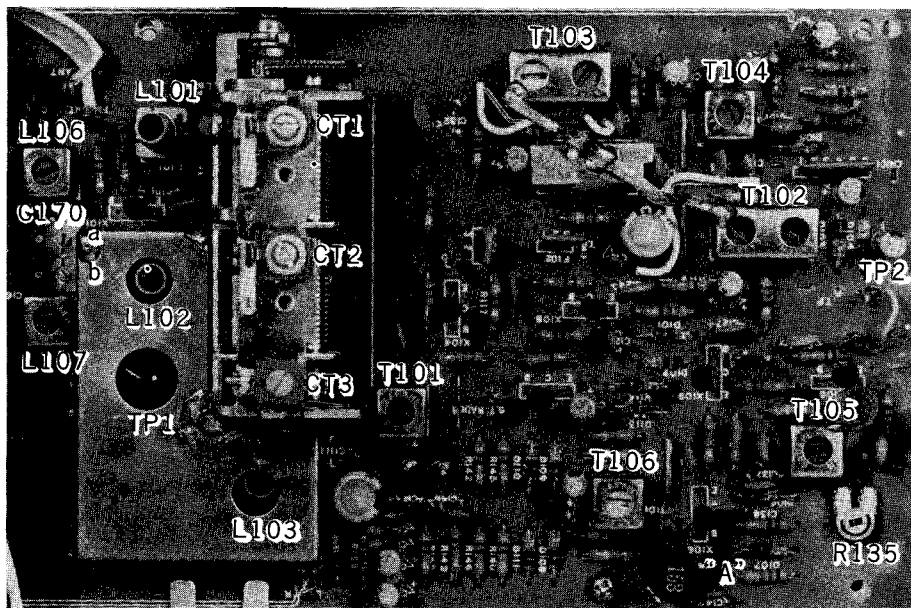

Fig. 23

For the German standard – FTZ – application area, correction of FM drift has to be done in following procedure.
To correct drift at the FM dial scale (87.5 or 108MHz) adjust coil L and trimmer C each other.

Cassette Deck Alignment

Equipment and measuring instruments used for adjustment.

1. V.T.V.M. (measuring AC in milivolts)
2. C.R. oscillator
3. Attenuator
4. Blank tapes
QP-12 C521V (normal) (JVC Test Tape TS-1)
TP-18 CrO₂ C401R (chrome) (JVC Test Tape TS-2)

This deck circuit has many check points so that checking and correct adjustment is easy.

Align the circuits according to the procedures.

Step 1 Bias currents

1. Set the machine in Recording mode.
2. Remove jump wires (R303 and R403).
3. Set BIAS SWITCH in NORMAL position.
4. Adjust R8 and R9 so that the voltage across R303,403, 100 Ω will become 37mV.
5. Set BIAS SWITCH in CHROME position.
6. Adjust R5 so that the R303,403 voltage will become 53mV.
7. Rest the jump wire.

Step 2 Deflection of level meters

1. Set the machine in playback mode.
2. Apply a 1kHz signal to PB (16mM/mm) JVC Test Tape VTT664.
3. Adjust R311 and R431 to indicate the meter pointer 0VU.

Replacement and Adjustment of the Head

If either of the Record/PB head and the Erase head shows low performance caused by wear, broken wire or excessive magnetization, it should be replaced. They can be removed by loosening screws with following procedure.

Replacing the Head

Step

1. Remove the Front Panel Ass'y
2. Remove the Cassette Door
(Remove shaft ⑤ in Fig. 24 with sliding it to the arrow direction)
3. Erasing Head
(Remove 2 screws ③ & ④) (Fig. 25)
4. Play/Rec Head
(Remove 2 screws ① & ②) (Fig. 25)
After replacement, adjust the azimuth of head.

Azimuth Adjustment

Step

1. Connect the INPUT jack of V.T.V.M. to the LINE OUT jack (or REC/PB socket)
2. Play back the standard tape (Full Track or JVC Test Tape VTT658 10kHz) for azimuth (angle adjustment).
3. Adjust screw ② so that indication of V.T.V.M. will become max.
When the azimuth adjustment standard tape is not available, play a music cassette.
Make the treble sound optimum with turning the screw ②.
4. After this adjustment, the screw ② should be locked with a bond.
If necessary, adjust playback level, recording bias current, bias and trap etc.

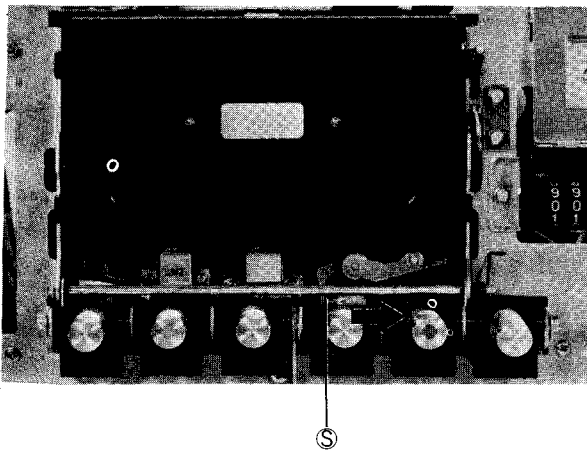

Fig. 24

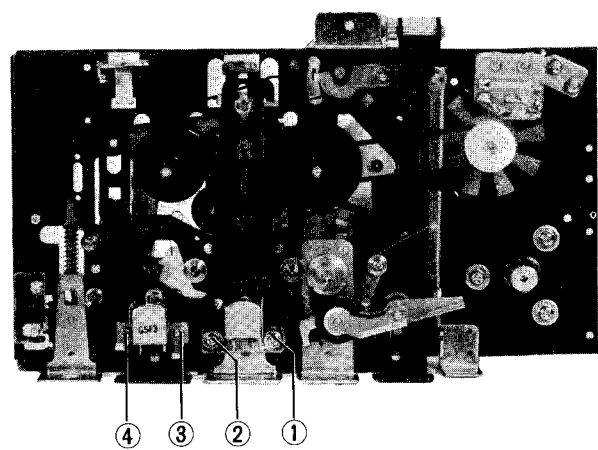

Fig. 25

Mechanism Adjustment

1. Pinch roller pressure

Standard pressure: 400~550g

If the pressure is not as specified, adjustment should be made by replacing the spring ① or by changing the spring position.

2. Take-up torque

Standard torque: 40~70gr·cm

If not as specified,

1. Replace the take-up idler arm ②.
2. Replace the take-up idler arm pressure spring.
3. Clean or replace the take-up belt ③.
4. Clean the right-side reel rubber outer surface, or replace the reel rubber.

4. Rewinding torque

Standard torque: 70gr·cm or more

If not as specified,

1. Clean the left-side reel rubber outer surface, or replace the reel disk ass'y ⑥.
2. Clean the rewind tire ⑦.
3. Clean the flywheel outer surface and belt.

5. Tape speed

Standard speed: 3000Hz \pm 2% (at playing a 3000Hz test tape)

If not as specified,

1. Insert your driver in hole with the motor up side and adjust a semi-VR for speed control in the motor case.
2. Replace the motor. *

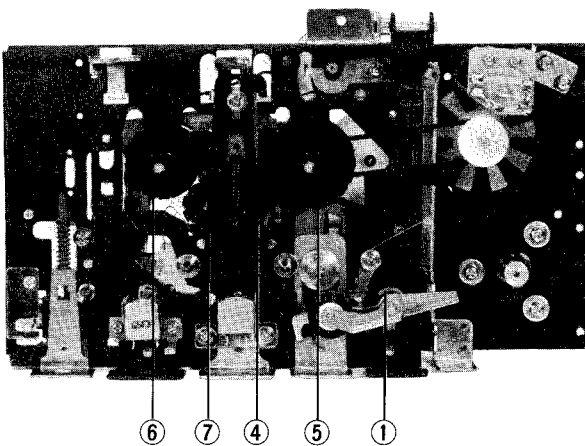

Fig. 26

3. Fast forward torque

Standard torque: 70gr·cm or more

If not as specified,

1. Clean the right-side reel rubber outer surface, or replace the reel disk ass'y ④.
2. Clean the fast forward tire and idler, or replace the fast forward idler ass'y ⑤.
3. Clean the flywheel outer surface and belt.

Auto-stop check-ups and adjustments

1. Mechanism section

When cassette mechanism wouldn't operate at operation mode except PAUSE, it is necessary to check the followings;

1. Check to see whether the belt is broken off.
2. Check to see whether the slotted disk or lamp.
3. Check to see whether the lamp is lit.

2. Check of automatic stop control circuit

When any defects has not found in above mentioned procedure, check the circuit operation on the circuit board YHY40002.

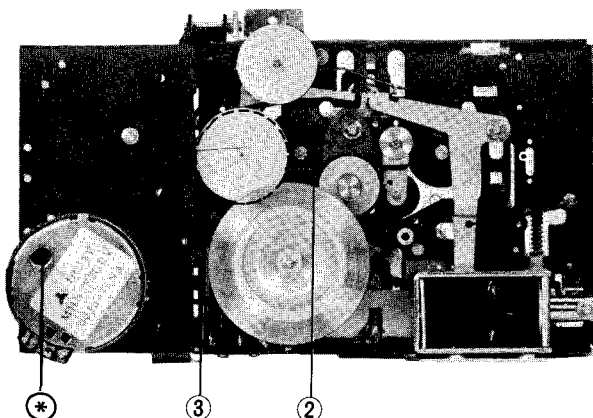

Fig. 27

Cleaning and Oiling

1. Cleaning

Clean the contact surfaces of the record/playback head, capstan and pinch roller with the tape.

If the head is dirty, tone quality will be greatly impaired, or erasure will be imperfect.

Clean them with a cloth moistened with alcohol, benzine, or trichloroethylene.

Keep the cabinet free from these chemicals, or the surface will be dissolved.

2. Oiling

Feed one or two drops of D.T.E. oil or machine oil to the rewind roller shaft and pinch roller shaft once or twice a year under normal conditions of use.

Avoid oiling them excessively, or rotation may become irregular because of oil splashes.

Replacement and Adjustment of the Record Player

Items of Motor and Pick-up Arm Replacement

1. Replacement of motor

- 1) Remove three wires ①, ② from motor terminals (Fig. 28).
- 2) Remove three screws 3 (Fig. 28).

Note: Be sure not to mix up the wires when soldering them again after replacement.

2. Replacement of Pick-up Arm (Fig. 28,29)

- 1) Unsolder six signal wires ④ soldered on Lug terminals.
- 2) Loosen two screws ⑤ fixing Arm Lever and take off the lever.
- 3) Take off Pick-up Arm Ass'y with removing the fixing Nut ⑥.
- 4) After replacement following adjustment is necessary.

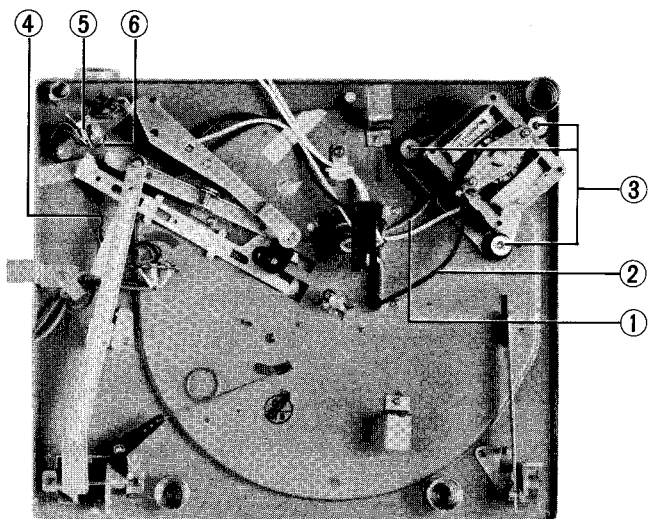

Fig. 28

Adjustment of Automatic Return Mechanism

1. Adjustment of the start point of returning

- a. In case of slightly fast or delayed;
To delay the start point turn the Adjustment screw to clockwise. (Fig. 29)
To fasten turn counter clockwise.

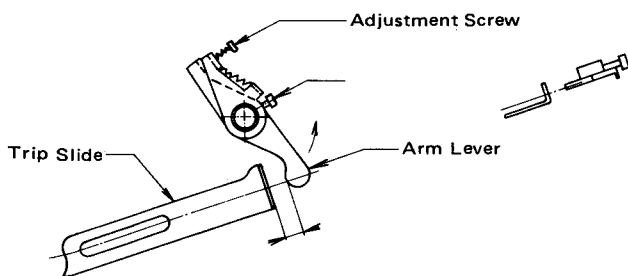

Fig. 29

- b. In case after replacement of Pick-up Arm;
Set Arm Lever with fixing screw to make space 4mm between trip slide and Arm Lever. (Fig. 29)
Adjust the start point with above mentioned procedure with Adjustment screw.

2. Adjustment of Return Position

When Pick-up Arm dose not return to Rest (goes down on the way to return) or excessively goes back to press Rest strongly, correct the operation with following adjustment.

- a. Remove platter with disengaging the driving belt.
- b. Put Pick-up Arm to the center shaft of the platter slowly to be stopped.
- c. Turn Main Gear counter clockwise slowly.
- d. Then Pick-up Arm will be lifted and stant to return with the rotation of Main Gear, and the return distance becomes maximum at about a half of rotation.

At this time turn Adjuster on Main Gear and correct the Return Position. (Fig. 30)

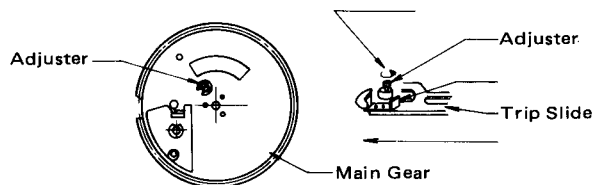

Fig. 30

3. Adjustment of up-down motion of Pick-up Arm

To prevent to scratch the disc or damage the stylus in Return Operation, or to play disc with optimum stylus pressure, the stylus height from Panel has to be adjusted. The distance between stylus tip and Panel at Down mode of Pick-up Arm has to be about 20mm.

Correction of this distance is made by bending the tip of Seesaw Arm. (Fig. 31)

Note: Be sure that the lever ratio between the bend distance and the height variation of stylus is 1 : 7.

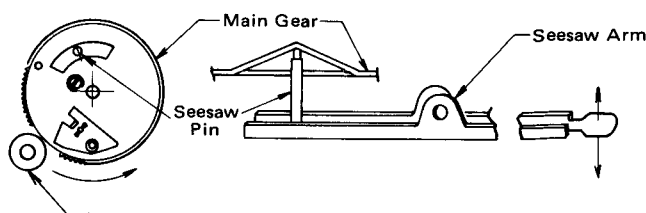

Fig. 31

Troubleshooting

Cassette deck section

1. Playback tone quality is poor.

- 1) Check the record/playback head whether dirty or worn excessively.

When wear is excessive, it results the loss of treble response.

- 2) Check the operations of circuits on the circuit board TAA270206 and tape select switches.

2. Recording tone quality is poor.

There are some defects in the recording circuits when playback quality of a music tape is agreeable. In this case, the unit should be checked in the following manner.

- 1) Check the signal to record by monitoring.

If found poor, check the circuits as like as above mentioned 1-2.

- 2) Also inspect the AC Bias Oscillator circuit and bias select switch.

3. Wow and flutter has increased.

Wow and flutter is caused by irregular rotation of revolving parts. It's Frequency increases in proportion to the rotation. Then play a 3000Hz test tape, and guess the parts rotating irregularly by the variation of frequency.

Check at first if anything seizing the rotation of following parts and then inspect if any defects are there.

Defective Part	Symptom	Remedy
Capstan	Capstan shaft turns like a top. Flywheel turns heavily caused by seized shaft.	Replace flywheel. Clean the bearing.
Pinch Roller	Rough rotation caused by scratches or dust on surface. Not parallel to capstan shaft. Pressure to capstan is not adequate.	Replace pinch roller. Adjust with bending the roller holder. Adjust spring.
Capstan Belt	Belt is run out. Belt is dirty or slippery.	Replace belt. Clean or replace it.
Back tension	Back tension is irregular, or back tension is too strong.	Replace supply disc. Replace back tension spring (under supply disc), or apply silicon grease.
Motor	Motor shaft has undue run-out. Motor pulley is oily and dusty.	Replace motor. Clean motor pulley.
Take-up lever arm	Pulley shaft is inclining. Pulley is stuck.	Replace take-up idler arm.

Record player section

No.	Item	Cause	Countermeasure or Repair
1	Platter would not turn.	Discontact of motor switch or broken wires.	Check switch and wires.
2	Pick-up Arm would not return with switching Reject Lever.	Operation lever is stuck or linkage spring is broken. Bad gearing.	Check the mechanism. Check the gear of platter and knob on the gear.
3	Pick-up arm would not return to the rest or start to return on the way playing.		Refer to the adjustment of Pick-up arm.
4	Pick-up arm would not come up though switching Cueing Lever.	Fault adjustment of cueing mechanism.	Adjust the screw on end of cue lever.

To String Dial Cord

1. Set the variable capacitor at maximum.
2. Cord length; $0.5\phi \times 1200\text{mm}$
3. Attach the spring to the dial drum.
String one side of the looped cord, then lead the cord to the outside of the chassis by fixing it not to lose.
4. String the cord in accordance with the numerical order (1~9) and finally string the cord to the roller (10).
Connect the final cord tip to the Dial Drum spring through the eyelet.
5. For adjusting the cord tension.
Swing the roller bracket by unscrewing the screw.
6. Attach the needle to the cord.

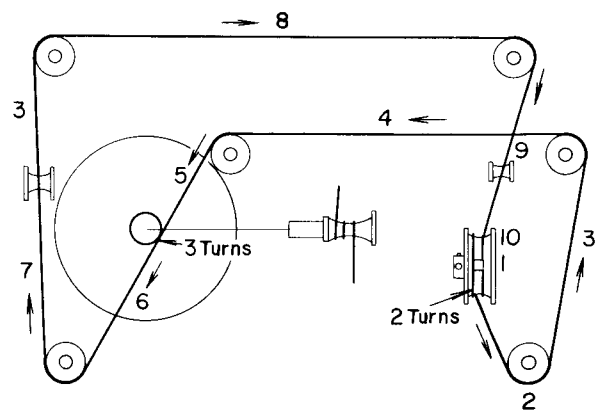

Fig. 32

Block Diagram

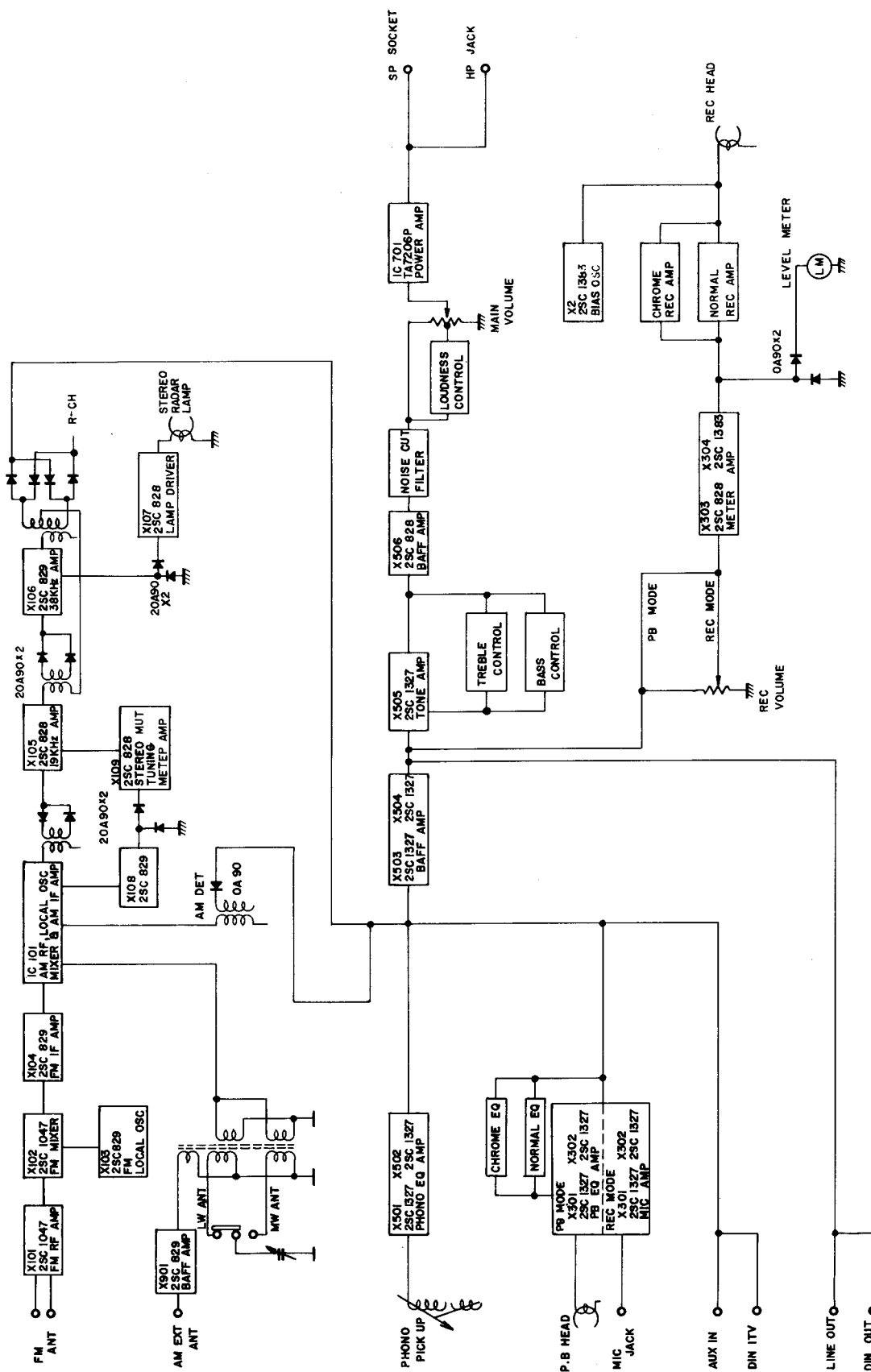
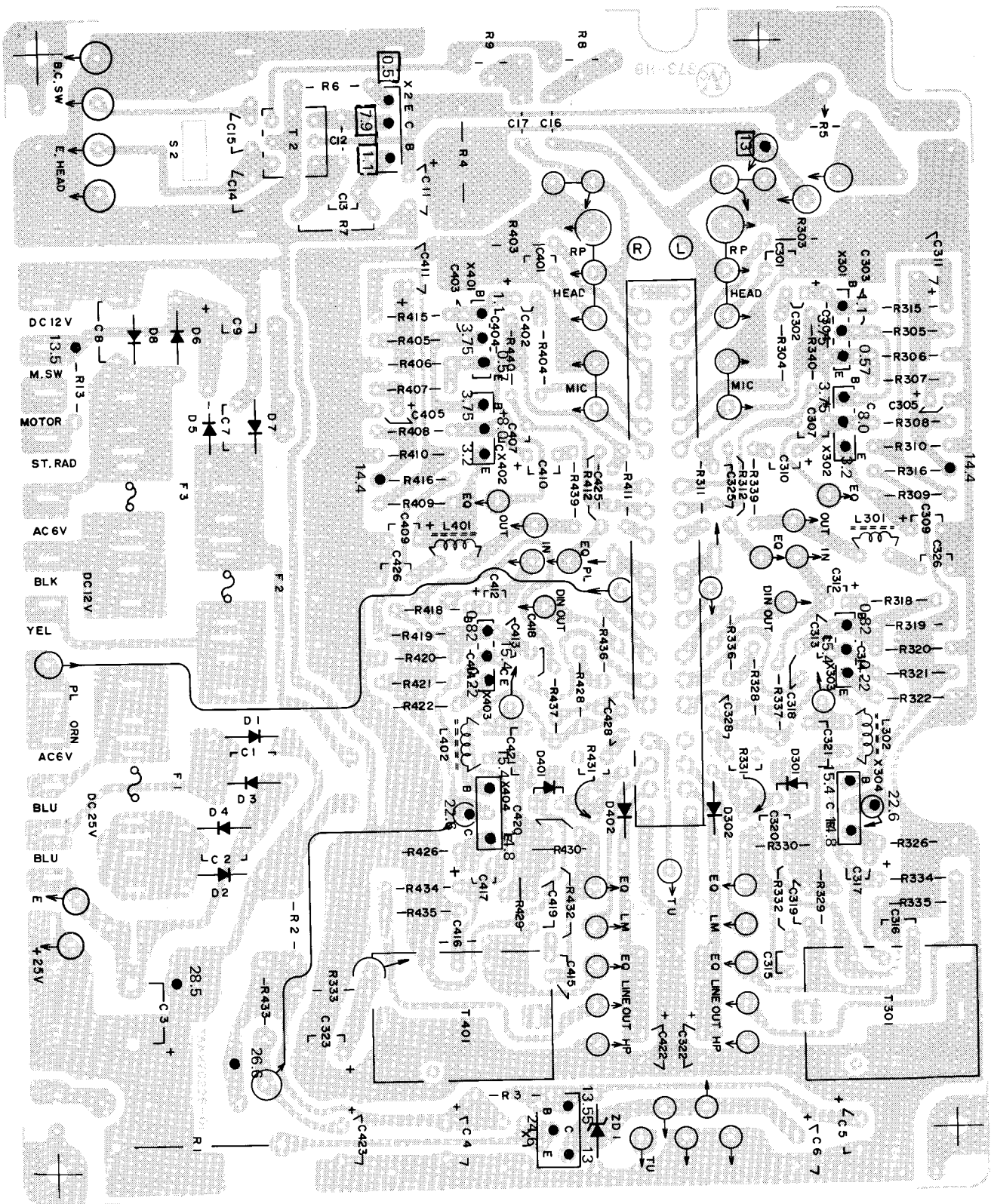

Fig. 33

Power Amp. Parts List

Ref. No.	Parts No.	Parts Name	Remarks	Q'ty
IC701,801	TAA291317-01	Power Amp C. Board		1
D701,801	TA7206P	I.C.		2
C709,809	1S2473	Si Diode		2
C702,705,708,802, 805,808	QEW71EH-478	E. Capacitor	4700 μ F 25V	2
C701,801	QEW41EA-336	"	33 μ F 16V	6
C708,808	QEB41EM-224	"	0.22 μ F 25V	2
C706,806	QFM41HK-104	M. Capacitor	33 μ F 25V	2
C707,807	" -332	"	0.0033 μ F 25V	2
C703,704,803,804	QCS11HK-151	Fixed C. Capacitor	150pF	2
C710,810	" -330	"	33pF	4
R705,805	" -331	"	330pF	2
R711,811	QVP8A0B-023	V. Resistor	2k Ω	2
R709,710,809,810	QRX016J-100	M.F. Resistor	10 Ω	2
R701,707,801,807	" -R47	"	0.47 Ω	4
R708,808	QRD142K-473	C. Resistor	47k Ω 1/4W	4
R712,812	" -333	"	33k Ω "	2
R706,806	" -103	"	10k Ω "	2
R702,802	" -472	"	4.7k Ω "	2
R704,804	" -102	"	1k Ω "	2
R703,803	" -471	"	470 Ω "	2
	" -5R6	"	5.6 Ω "	2
	E43727-003	Tab		3
	E40130-001	"		7
X701,702,801,802	2SD2340Y	Si Transistor		4

Rec/PB Amp. Circuit Board



+ REC MODE
 + NORMAL POSITION

Fig. 35

Rec/PB Amp. Parts List

Ref. No.	Parts No.	Parts Name	Remarks	Q'ty
	TAA270206-01	Rec & PB Amp C. Board		1
R303,403	QRD142K-101	C. Resistor	100Ω ¼W	2
R304,404,309,409	" -222	"	2.2kΩ "	4
R305,405,330,430	" -184	"	180kΩ "	4
R306,406	" -103	"	10kΩ "	2
R307,407	" -221	"	220Ω "	2
R308,408	" -682	"	6.8kΩ "	2
R310,410	" -122	"	1.2kΩ "	2
R311,411,337	" -223	"	22kΩ "	3
R312,412,437,321, 421	" -123	"	12kΩ "	5
R341,441	" -473	"	47kΩ "	2
R340,440	" -105	"	1MΩ "	2
R315,415,336,436	" -154	"	150kΩ "	4
R316,416	" -822	"	8.2kΩ "	2
R319,419	" -824	"	820kΩ "	2
R320,420	" -333	"	33kΩ "	2
R322,422	" -471	"	470Ω "	2
R328,428	" -155	"	1.5M "	2
R329,429	" -823	"	82kΩ "	2
R332,432	" -394	"	390kΩ "	2
R339,439	" -332	"	3.3kΩ "	2
R3	" -272	"	2.7kΩ "	1
R333,433	QRD146K-121	"	120Ω "	2
R326,426	QRG016J-471	M.F. Resistor	470Ω 1W	2
R2	" -330	"	33Ω "	1
R1	QRG026J-181	"	180Ω 2W	1
R10	" -821	"	820Ω "	1
R331,431	QVP8A0B-053	V. Resistor	5kΩ	2
R418	QVP6A0B-024	"	20kΩ	1
C1,25	QCF12HP-103	F.C. Capacitor	0.01μF	
C326,426,301,401, 304,404	QCY41HK-102	"	0.001μF	6
C330,430	" -103	"	0.01μF	2
C316,416	QCS11HK-681	"	680pF	2
C320,420	" -101	"	100pF	2
C303,403	" -330	"	33pF	2
C306,406,325 425	" -680	"	68pF	4
C313,413	" -100	"	10pF	2
C319,419	" -471	"	470pF	2
C315,415	" -391	"	390pF	2
C321,421	QCS12HJ-391	"	390pF	2
C302,402	QEE41EM-335	T. Capacitor	33μF 25V	2
C310,410,318,418, 328,428,322,422	QEW41EA-335M	E. Capacitor	3.3pF "	8
C317,417,307,407	" -336	"	33μF "	4
C311,411	" -107	"	100μF "	2
C9,28	" -108	"	1000μF "	2
C305,405	QEW41CA-336	"	33μF 16V	2
C5,6	" -107	"	100μF "	2
C309,409	QEW41AA-107	"	100μF 10V	2
C4	QEW41VA-477M	"	470μF 35V	1
C323,423	" -227	"	220μF "	2
C3	" -108	"	1000μF "	1
C26,27	QCF11HP-403	F.C. Capacitor	0.04μF	2
C2,24	QFM42DM-104	M. Capacitor	0.01μF	2
L302,402	TAC000324-01	Inductor	18mH	2
L301,401	" -02	"	6.8mH	2

Ref. No.	Parts No.	Parts Name	Remarks	Q'ty
L303	TAC000324-03	Inductor	1mH	1
T301,401	T45508-001	HP. Trans		2
S301	QSSC201-001	Slide Switch		1
R13	QRG016J-181	O.M.F Resistor	180 Ω	1
X1	2SD313E	Si Transistor		1
X2,304,404	2SC1383S	"	750. 200	3
X301,302,401,402	2SC1327U	"	150. 150	4
X303,403	2SC828ST	"	150. 150	2
D1,2,3,4	T30155-001	Si Diode	10kHz	4
ZD1	RD13E	Ze. Diode		1
D401,402,301,302	0A90	Ge. Diode	30MHz	4
F1,2,3	QMF51A2-1R0	Fuse	1A	3
	TAZ000331-02	Fuse Clamp		6
	E40130-001	Tub		15
	E43727-002	"		32
	(OSC Circuit)			
R6	QRD142K-390	C. Resistor	39 Ω 1/4W	1
R7	" -330	"	33 Ω "	1
R4	QRD016J-181	O.M. Resistor	180 Ω 1W	1
R8,9	QVP2A0B-025	V. Resistor	200k Ω	2
R5	QVZ3110-003	"	200 Ω 2W	1
C13	QCY41HK-102	F.C. Capacitor	0.001 μ F	1
C16,17	QCS12HK-101	"	100pF	2
C14	QFM42AK-223	M. Capacitor	0.022 μ F	1
C15	" -153	"	0.015 μ F	1
C12	QFZ0001-183	Polyetilen Capacitor	0.018 μ F	1
C11	QEW41CA-106	E. Cap	10 μ F 16V	1
T2	T48189-001	OSC Trans		1

Tuner Circuit Board

..... at FM STEREO
 at AM
 at signal on

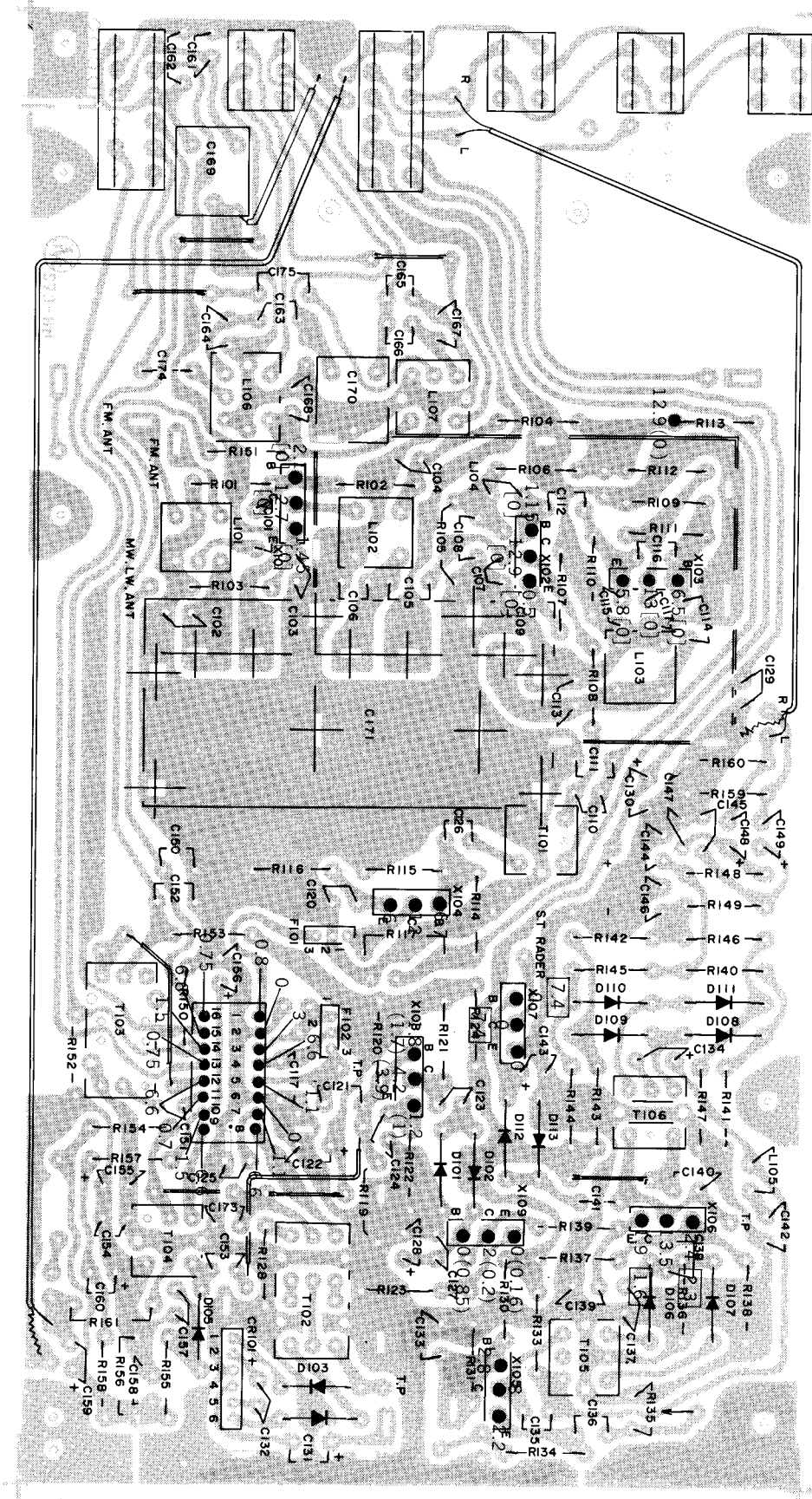

Fig. 36

Tuner Parts List

Ref. No.	Parts No.	Parts Name	Remarks	Q'ty
	TAA270209-01	Tuner C. Board		1
	E40130-001	Tab		6
	E43727-002	"		12
	TFB270447-01	Shield Cover		1
C171	QAA2233-001	V. Capacitor		1
R104,108,112	QRD142K-101	C. Capacitor	100Ω ¼W	3
R103,107	" -102	"	1kΩ "	2
R105,110	" -332	"	3.3kΩ "	2
R101	" -472	"	4.7kΩ "	1
R109,111	" -103	"	10kΩ "	2
R106	" -333	"	33kΩ "	1
R102	" -223	"	22kΩ "	1
C103,104,109,111, 117,172	QCF11HP-103	C. Capacitor	0.03μF	6
C105	QCS11HK-2R0	"	2pF	1
C112	" -3R0	"	3pF	1
C101	" -100	"	10pF	1
C102,107	" -120	"	12pF	2
C106	" -150	"	15pF	1
C108	" -331	"	330pF	1
C113	QCT05RF-220	"	22pF	1
C114	QCT05CH-220	"	22pF	1
C115	" -100	"	10pF	1
C116	" -330	"	33pF	1
	TFB270460-01	OSC Cover		1
	TFB270461-01	I.C Cover		1
	TFB270453-01	Shield Cover		1
R123,128	QRD142K-680	C. Resistor	68Ω ¼W	2
R113	" -101	"	100Ω "	1
R124	" -331	"	330Ω "	1
R117	" -471	"	470Ω "	2
R122	" -821	"	820Ω "	1
R116,121	" -182	"	1.8kΩ "	2
R119	" -472	"	4.7kΩ "	1
R114,115	" -822	"	8.2kΩ "	2
R120	" -123	"	12kΩ "	1
C119	QCF11EZ-393	C. Capacitor	0.039μF	1
C120,124,125,126, 127,129,173	" -203	"	0.02μF	8
C121	QCS11HK-180	"	18pF	1
C123	" -151	"	150pF	1
C131	QEW41HA-105	E. Capacitor	1μF DC50V	1
C128,132	QEW41CH-106	"	10μF DC16V	2
C122,130	QEW41CA-107	"	100μF DC16V	2
F101,102	SFE10.7MA	C. Filter		2
CR101	B6RD0104	CR Block		1
R135	QVP8A0B-013	V. Resistor		1
R151,153	QRD142K-101	C. Resistor	100Ω ¼W	2
R155	" -471	"	470Ω "	1
R150	" -152	"	1.5kΩ "	1
R152	" -332	"	3.3kΩ "	1
R156	" -103	"	10kΩ "	1
R157,158	" -223	"	22kΩ "	2
R154	" -224	"	220kΩ "	1
R161	" -104	"	100kΩ "	1
R162	" -820	"	82Ω "	1
C151	QCF11HP-103	C. Capacitor	0.01μF	1
C150,152,154,168	QCF11EZ-203	"	0.02μF	4
C161,164	QCS11HK-5R0	"	5pF	1
C153	" -150	"	15pF	1
C165	" -220	"	22pF	1
C167,176	" -560	"	56pF	2
C166	QCS11HJ-181	"	180pF	1
C162	QCS11HK-270	"	27pF	1

Ref. No.	Parts No.	Parts Name	Remarks	Q'ty
C163	QCS11HJ-331	C. Capacitor	330pF	1
C157,158	QFM41HK-103	M. Capacitor	0.01 μ F DC100V	2
C175	QFM41HK-393	"	0.039 μ F "	1
C156,159,160	QEW41HA-105	E. Capacitor	1 μ F DC50V	3
C155	QEW41CA-106	"	10 μ F DC16V	1
C169,170	QAT2002-001	Trimmer Capacitor		2
R139	QRD142K-681	C. Resistor	680 Ω $\frac{1}{4}$ W	1
R134	" -152	"	1.5k Ω "	1
R133	" -392	"	3.9k Ω "	1
R138	" -682	"	6.8k Ω "	1
R142,140,136,145, 146	" -103	"	10k Ω "	5
R131	" -183	"	18k Ω "	1
R159,160	" -104	"	100k Ω "	2
R137	" -333	"	33k Ω "	1
R130	" -683	"	68k Ω "	1
R141,143,144,147	" -334	"	330k Ω "	4
R148,149	" -393	"	39k Ω "	2
C133	QCS11HK-101	C. Resistor	100pF	1
C137,141	" -221	"	220pF	2
C145,147	QFM41HK-182	M. Capacitor	1800pF DC50V	2
C144,146	" -272	"	2700pF "	2
C138,142	" -472	"	4700pF "	2
C139	" -153	"	0.015pF "	1
C136	" -223	"	0.022pF "	1
C148,149,143	QEW41HA-105	E. Capacitor	1 μ F "	3
C134	QEW41EA-475	"	4.7 μ F DC25V	1
C135	QFS41HJ-472	P. Capacitor	4700pF DC50V	1
C140	" -821	"	820pF "	1
SW101	QSP0262-001	Switch		1
	TFB270482-01	Bar Ant. Holder		2
	LPSP3008Z	Screw		2
	(TK1049-001 Transistor Kit)			
X101,102	2SC1047C	Si Transistor		2
X106	2SC828R	"		1
	AN217	IC		1
X104,108	2SC829B	Si Transistor		2
X105,107,109	2SC828T	"		3
D105	0A90	Ge. Diode		1
D101,102,103,104, 106,107,108,109, 110,111,112,113	20A90	"		12
X103	2SC829C	Si Transistor		1
	(TK1050-005 Coil Kit)			
	TBR270434-01	RF Coil	FM Ant	1
	TBR270435-01	"	FM RF	1
	TBR270436-01	"	FM OSC	1
	TBR270437-01	"	Trap	1
	TBR270438-01	"	IF 1st.	1
	E03078-35S	FM Det.		1
	E03062-35S	AM IFT		1
	E03062-6S	"		1
	E03079-18S	LW OSC		1
	TB270452	MW OSC		1
	TBA270439-01	Bar Ant		1
	E0747-1S	Inductor		1
	E03117-003S	MPX Coil		1
	E03117-010S	"		1
	TER270483-01	Bushing		2

Control Amp. Circuit Board

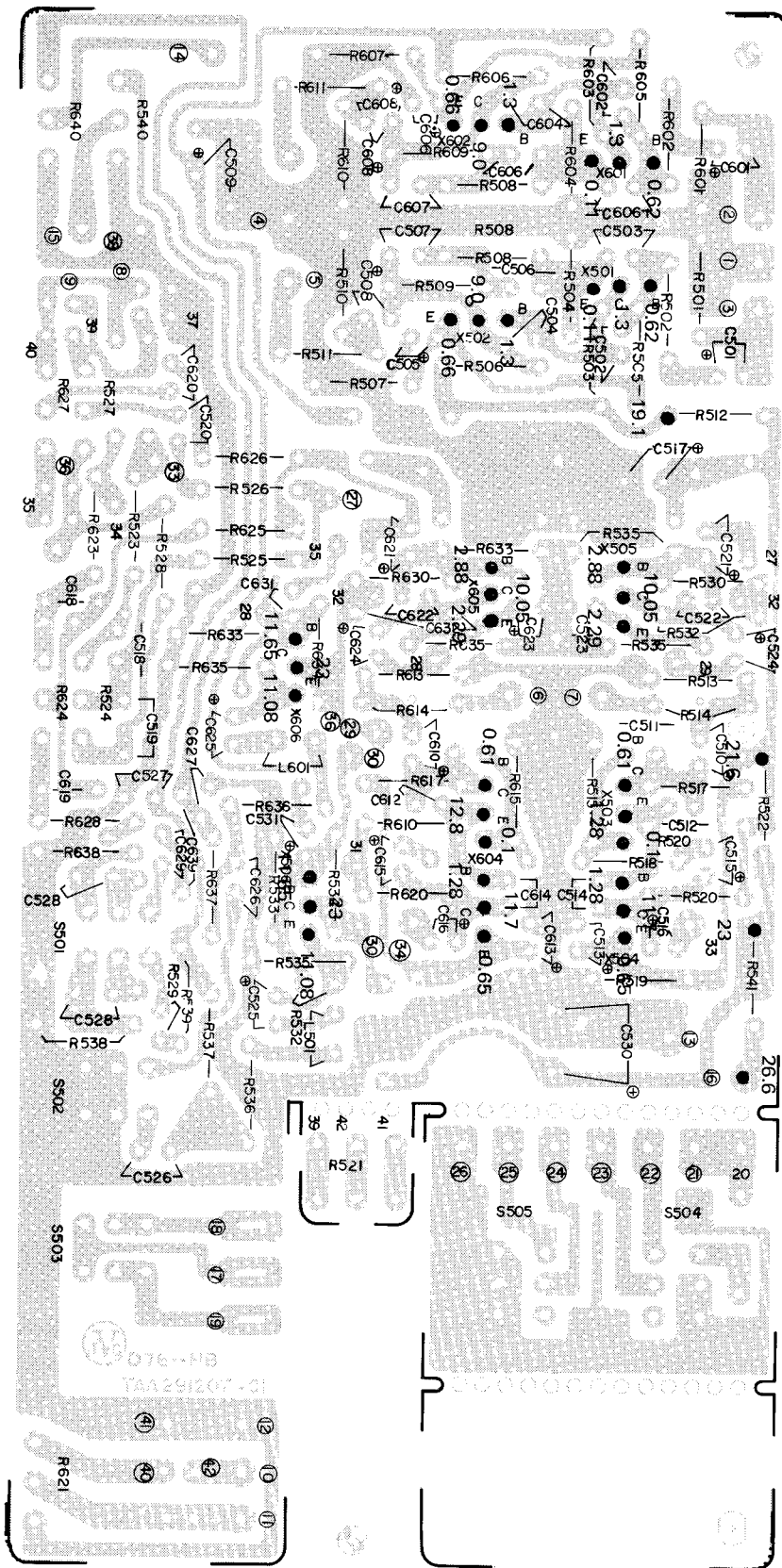

Fig. 37

Control Amp. Parts List

Ref. No.	Parts No.	Parts Name	Remarks	Q'ty
	TAA291207-01	Control Amp C. Board		1
	(Phono Circuit)			
X502,602,501,601	2SC1327U	Si Transistor	150. 150	4
C509	QEW41EA-227	E. Capacitor	220 μ F 25V	1
C505,605	QEW41AA-476	"	47 μ F 10V	2
C501,601,508,608	QEB41EM-105	"	1 μ F 25V	4
C507,607	QFM41HJ-123	M. Capacitor	0.012 μ F	2
C506,606	" -332	"	0.0033 μ F	2
C503,603	QFM41HK-102	"	0.001 μ F	2
C504,604	QCS11HK-470	F.C. Capacitor	47pF	2
C502,602	" -330	"	33pF	2
R503,603,505,605	QRD142K-394	C. Resistor	390k Ω 1/4W	4
R509,609	" -274	"	270k Ω "	2
R510,610	" -104	"	100k Ω "	2
R507,607	" -681	"	680 Ω "	2
R501,601	" -563	"	56k Ω "	2
R508,608	" -223	"	22k Ω "	2
R511,611	" -153	"	15k Ω "	2
R506,606	" -103	"	10k Ω "	2
R502,602	" -222	"	2.2k Ω "	2
R504,604	" -152	"	1.5k Ω "	2
R512	" -102	"	1k Ω "	1
	QRD141J-0R0	Jumping Resistor		1
	E43727-002	Tab		3
	(Tone Amp Circuit)			
X505,605	2SC1327U	Si Transistor	150. 150	2
C523,623	QEW41AA-476	E. Capacitor	47 μ F 10V	2
C531,631	" -475	"	4.7 μ F 25V	2
C517	" -227	"	220 μ F 25V	1
C522,622	QCS11HK-560	F.C. Capacitor	56pF	2
R530,630	QRD142K-224	C. Resistor	220k Ω 1/4W	2
R529,629	" -333	"	33k Ω "	2
R532,632	" -562	"	5.6k Ω "	2
R531,631	" -102	"	1k Ω "	2
R522	" -331	"	330 Ω "	1
	E43727-002	Tab		6
	(Flat Amp Circuit)			
X503,603	2SC1327U	Si Transistor	150. 150	2
X504,604	2SC828ST	"	150. 150	2
C530	QEW41VA-227	E. Capacitor	220 μ F 35V	1
C515,615,516,616	QEW41EA-475	"	4.7 μ F 25V	4
C513,613	QEW41AA-476	"	47 μ F 10V	2
C521,621	QEB41EM-105	"	1 μ F 25V	2
C510,610	" -224	"	0.22 μ F 25V	2
C512,612	QCS11HK-330	F.C. Capacitor	33pF	2
C514,614	" -470	"	47pF	2
C511,611	" -471	"	470pF	2
R516,616,517,617	QRD142K-394	C. Resistor	390k Ω 1/4W	4
R514,614	" -563	"	56k Ω "	2
R518,618	" -333	"	33k Ω "	2
R513,613	" -153	"	15k Ω "	2
R520,620	" -103	"	10k Ω "	2
R515,615	" -222	"	2.2k Ω "	2
R519,619	" -681	"	680 Ω "	2
R541	" -271	"	270 Ω "	1
	QRD141J-0R0	Jumping Resistor		1

Ref. No.	Parts No.	Parts Name	Remarks	Q'ty
	(Tone C. Circuit)			
R524,624,527,627	QVD8A3B-015A	V. Resistor	100k Ω	4
C518,618,519,619	QFM41HJ-153	M. Capacitor	0.015 μ F	4
C520,620	" -122	"	0.0012 μ F	2
R523,623,528,628	QRD142K-273	C. Resistor	27k Ω 1/4W	4
R525,625	" -103	"	10k Ω "	2
R526,626	" -123	"	12k Ω "	2
	(Filter Circuit)			
X506,606	2SC828ST	Si Transistor	150. 150	2
C524,624	QEB41EM-474	E. Capacitor	0.47 μ F 25V	2
C525,625	" -105	"	1 μ F 25V	2
C532,632	QFM41HK-102	M. Capacitor	0.001 μ F	2
C526,626	QFM41HJ-183	"	0.018 μ F	2
C527,627	" -121	"	0.0012 μ F	2
L501,601	TAC000324-05	Inductor	33mH	2
R533,633	QRD143K-334	C. Resistor	330k Ω 1/4W	2
R534,634	" -274	"	270k Ω "	2
R535,635	" -472	"	49k Ω "	2
R536,636	" -152	"	1.5k Ω "	2
R537,637	" -392	"	3.9k Ω "	2
	(Loudness Circuit)			
R540,640	QVL6A3B-515A	Variable Resistor	100k Ω	2
C529,629	QFM41HK-102	M. Capacitor	0.001 μ F	2
C528,628	" -333	"	0.033 μ F	2
R539,639	QRD142K-333	C. Resistor	33k Ω 1/4W	2
R538,638	" -153	"	15k Ω "	2
R521,621	QVG4A3A-054A	V. Resistor	50k Ω	2
	E43727-002	Tab		13
	E40130-001	"		3
	QSP0239-101	Push Switch		1
	QSP0229-002	"		1
R542	QRD142K-151	C. Resistor	150 Ω	1

Auto Stop Circuit Board

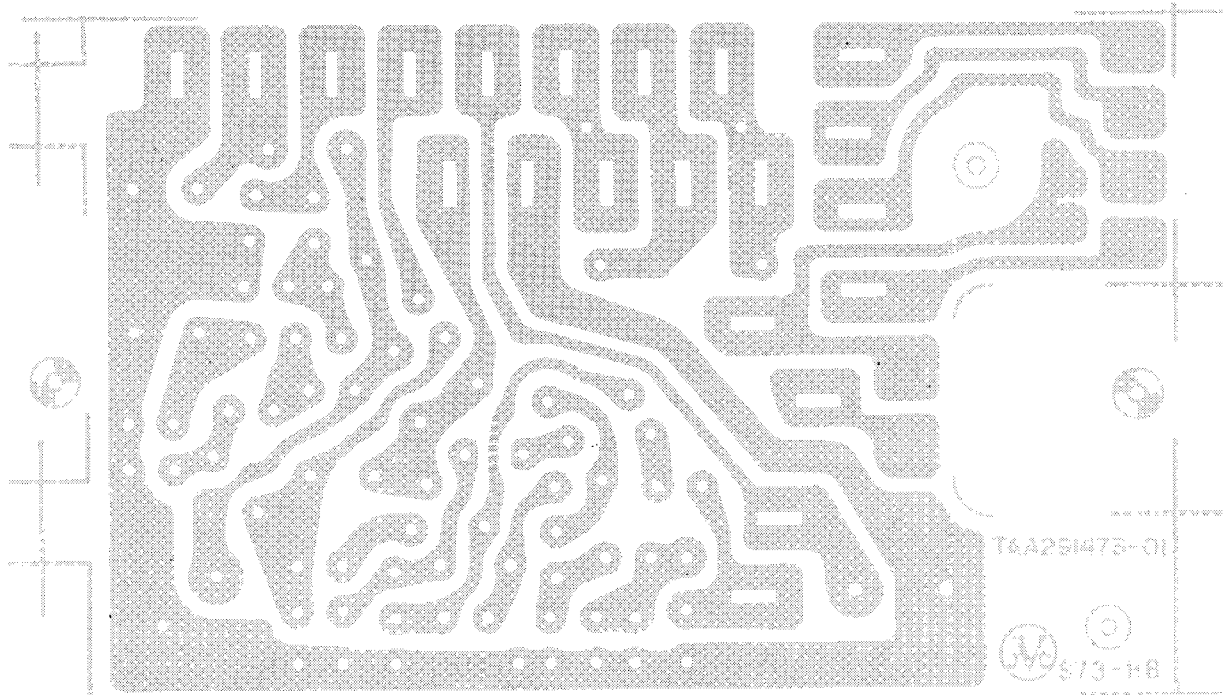

Fig. 38

Auto Stop Parts List

Ref. No.	Parts No.	Parts Name	Remarks	Q'ty
	YHY40002-001	Auto Stop C. Board	(TAA291473)	1
X201,202,203	2SC828ST	Si Transistor	150. 150	3
SCR201	2SF656	S. C. R		1
D201,202,203	1S188FM	Ge. Diode		3
C213	QEW41VA-477	E. Capacitor	470 μ F 35V	1
C203	QEW41CA-477	"	470 μ F 16V	1
C201	" -227	"	220 μ F 16V	1
C206	" -107	"	100 μ F 16V	1
C202,205,208	" -476	"	47 μ F 16V	3
C207	QEW41EA-335	"	3.3 μ F 25V	1
C209,211,212	QEB41EM-105	"	1 μ F 25V	3
C204	QEW40JA-477	"	470 μ F 6.3V	1
R201	QRG016J-121	O.M.F Resistor	120 Ω 1W	1
R217	" -330	"	33 Ω 1W	1
C210	QCF11HP-103	F.C. Capacitor	0.01 μ F	1
R212	QRD143K-823	C. Resistor	82k Ω 1/4W	1
R203	" -683	"	68k Ω "	1
R211	" -394	"	390k Ω "	1
R204	" -184	"	180k Ω "	1
R207	" -822	"	8.2k Ω "	1
	" -562	"	5.6k Ω "	1
R210,215	" -472	"	4.7k Ω "	2
R209	" -332	"	3.3k Ω "	1
R206,214,216	" -272	"	2.7k Ω "	3
R202	" -152	"	1.5k Ω "	1
R205	" -102	"	1k Ω "	1
R213	" -153	"	15k Ω "	1
R208	" -333	"	33k Ω "	1
R218,219	QRD142K-104	"	100k Ω "	1
	E40130-001	Tab		9

Fuse Circuit Board

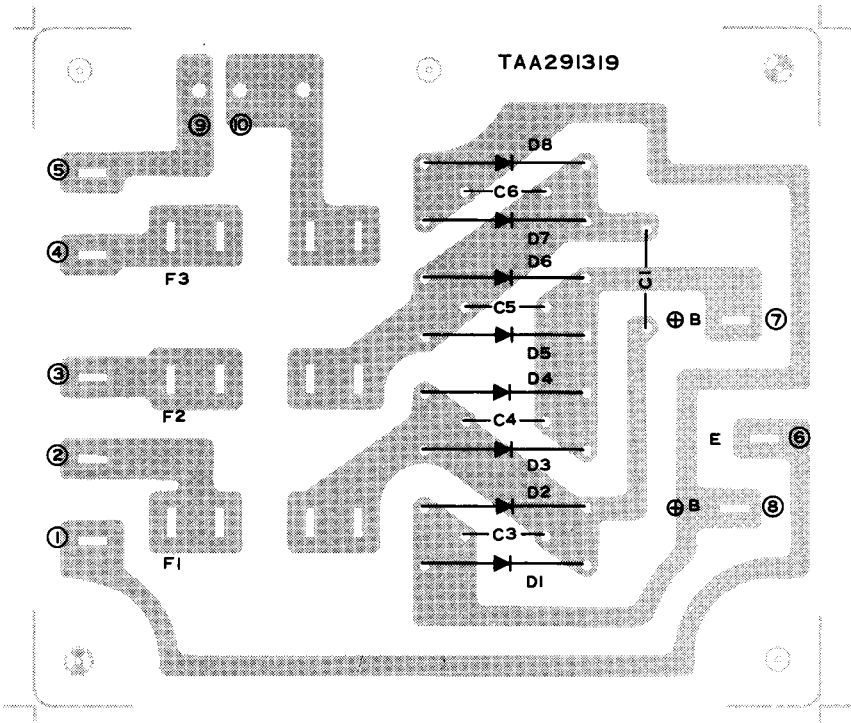

Fig. 39

Lever Switch Circuit Board

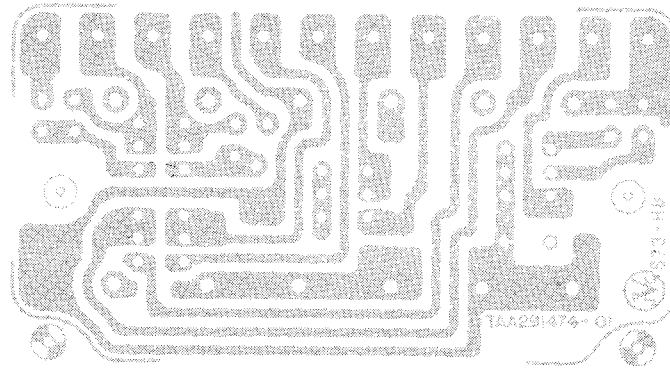

Fig. 40

Din Jack Circuit Board

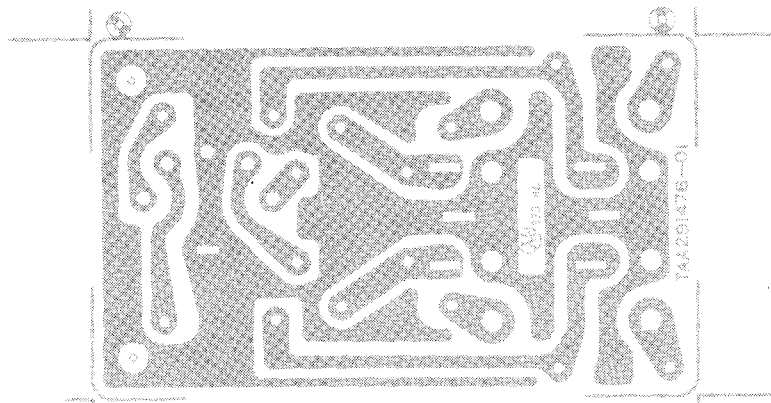

Fig. 41

Fuse Parts List

Ref. No.	Parts No.	Parts Name	Remarks	Q'ty
D1,2,3,4,5,6,7,8 C3,4,5,6 C1 F1,2 F3	TAA291319-01	Fuse C. Board		1
	T30155-003	Si Diode		8
	QCF12HP-103	Fixed C. Capacitor	0.01 μ F	4
	QFM41HK-274	M. Capacitor	0.1 μ F	1
	QFM51A2-4R0	Fuse	4A	2
	" -1R0	"	1A	1
	TAZ000331-02	Fuse Clamp		6
	TAZ291486-01	Connector		1
	51739-002	Lug		1
	E40130-001	Tab		8

Lever Switch Parts List

Ref. No.	Parts No.	Parts Name	Remarks	Q'ty
C352 R351,451 C351,451	TAA291474-01	Lever Switch C. Board		1
	QSL2218-111	Lever Switch	for Bias	1
	QSL4218-001	"	for EQ	1
	QSL2318-002	"	for Beat Cut	1
	QFZ0001-123	P.P. Capacitor	0.012 μ F	1
	QRD143K-103	C. Resistor	10k Ω $\frac{1}{4}$ W	2
	QFM41HJ-472	M. Capacitor	0.0047 μ F	2
	E43727-003	Tab		12

Din Jack Parts List

Ref. No.	Parts No.	Parts Name	Remarks	Q'ty
R380,480 R378,478 R376,476 R377,477 R381,481 R379,479	TAA291476-01	DIN Jack C. Board		1
	QRD142K-274	C. Resistor	270k Ω $\frac{1}{4}$ W	2
	" -472	"	4.7k Ω "	2
	" -393	"	39k Ω "	2
	" -563	"	59k Ω "	2
	" -123	"	12k Ω "	2
	" -124	"	120k Ω "	2
	E40516-001	Tab		6

Push Switch Circuit Board

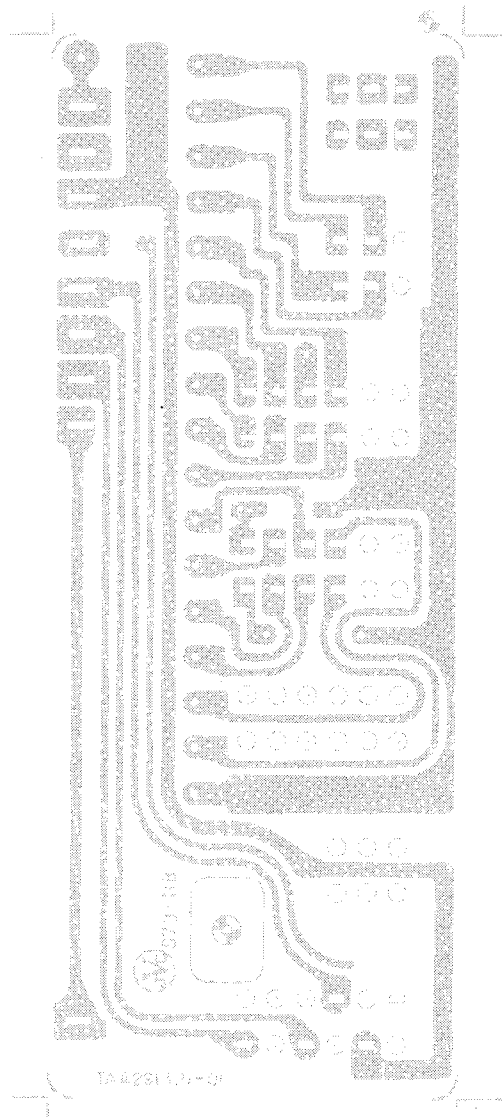

Fig. 42

Ant. Parts List

Ref. No.	Parts No.	Parts Name	Remarks	Q'ty
	TAA270480-001	Ant. C. Board		1
R902	QRD142K-564	C. Resistor	560k Ω 1/4W	1
R903	" -562	"	5.6k Ω "	1
R901	" -152	"	1.5k Ω "	1
R904	" -561	"	560 Ω "	1
C901,903,904	QCF11HP-393	C. Capacitor	0.039 μ F	3
X901	2SD829B	Si Transistor		1
L901	TBR270481-01	Inductor		1

Cds Parts List

Ref. No.	Parts No.	Parts Name	Remarks	Q'ty
	TAA265454-01	Cds C. Board		1
	T45516-001	Cds Photo Cell		1
	TCL000405-02	Pilot Lamp		1
	T45566-001	Lamp Holder		1
	TFB265443-01	Lamp Bracket		1
	TAS291482-01	Shield Board		1

Mechanical Components

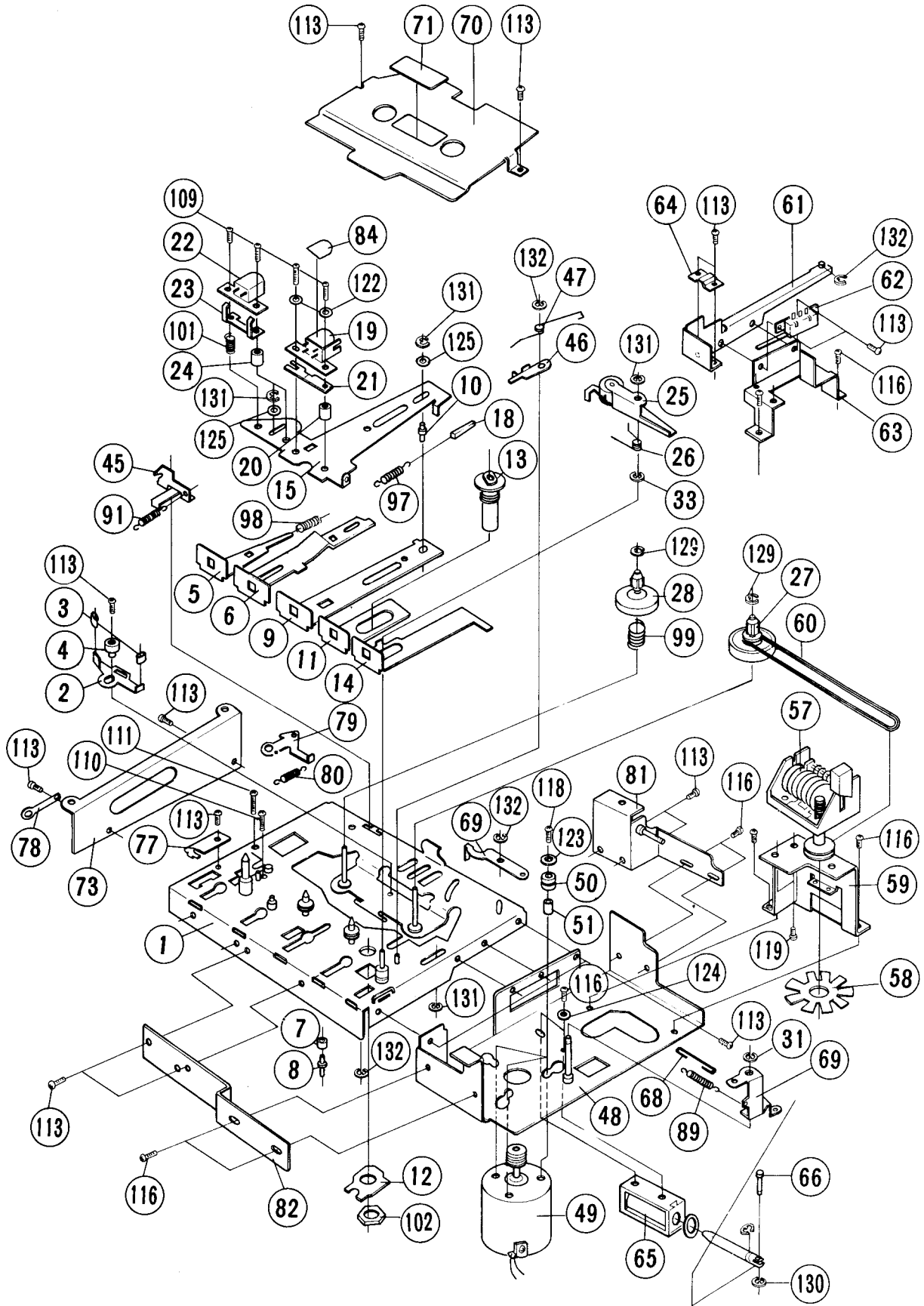

Fig. 43

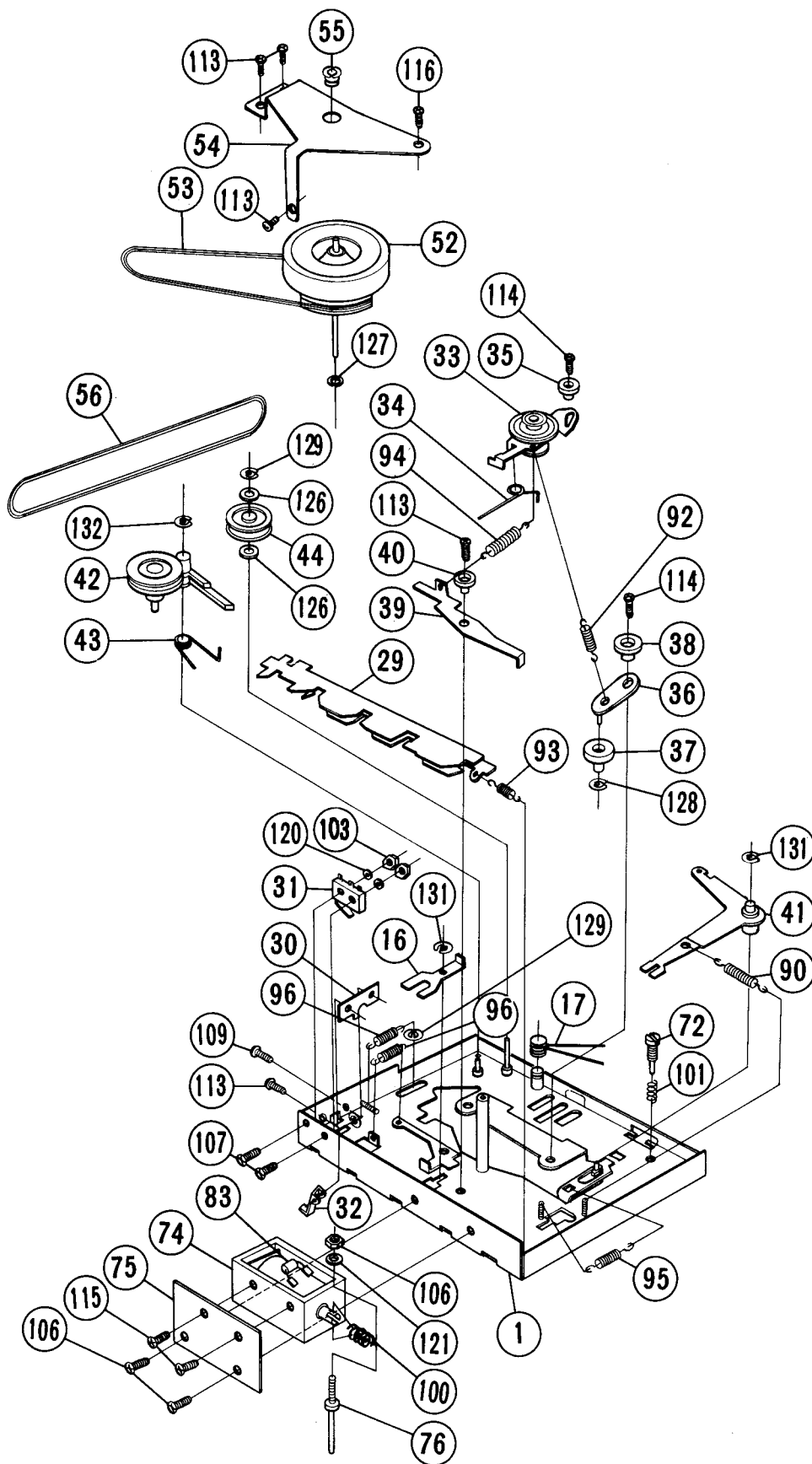

Fig. 44

Mechanical Component List

Ref. No.	Parts No.	Parts Name	Remarks	Q'ty
1	TGB305205-0A	Chassis Base Ass'y		1
2	TFB265488-01	Brake Arm		1
3	TER265487-01	Brake Rubber		2
4	TFH265486-01	Collar	for Brake Arm	1
5	T47449-00A	Rew Bar Ass'y		1
6	T47453-00C	Record Bar Ass'y		1
7	T30302-061	Collar	for Rec Bar	1
8	TFH265516-01	Stud	for Brake Lever	1
9	TGB265485-0A	Play Bar Ass'y		1
10	TFH265514-01	Play Bar	for Slide Base	1
11	T47459-00A	F.F Bar Ass'y		1
12	TFB305417-01	Spacer		1
13	TGH265546-0B	Capstan Metal Ass'y		1
14	TGB291420-0A	Stop Bar Ass'y		1
15	TGB265482-0A	Slide Base Ass'y		1
16	TFP014497-01	Spring Plate		1
17	TFW014498-01	Spring	for Play Bar	1
18	TJN265559-01	Silencer	for Spring	1
19	T31063-001	R.P Head Ass'y		1
20	T30302-066	R.P Head Coller		1
21	TFP294513-01	R.P Head Spring	for R.P Head	1
22	THS265480-0A	E. Head Ass'y		1
23	TFB265479-01	Wire Clamper		1
24	T30302-067	E. Head Coller		1
25	TGB291415-0A	P. Roller Arm Ass'y		1
26	TFW294483-01	P. Roller Spring		1
27	TGP294462-0B	T. Up Disk Ass'y		1
28	TGP294464-0C	Supply Disk Ass'y		1
29	TGB265475-0A	Push Button Cam Ass'y		1
30	TFB265509-02	Stopper	for P. Button Cam	1
31	QSM1S01-015	Micro Switch Ass'y		1
32	T47528-002	Switch Lever		1
33	TGB265474-0A	F.F Arm Ass'y		1
34	T47507-001	F.F Spring		1
35	TFH265557-01	Metal	for F.F Arm	1
36	T47508-00A	REW Arm Ass'y		1
37	T47500-001	Idler Ass'y		1
38	TFH265534-01	Metal	for REW Arm	1
39	T47511-001	Review Lever		1
40	T47529 001	Metal	for Review Lever	1
41	TGB265472-0A	Brake Lever Ass'y		1
42	TGP265471-0C	T. Up Lever Ass'y		1
43	T47520-001	Lever Spring		1
44	TGP265571-0A	Idler Pulley Ass'y		1
45	TFB291414-01	Record Safety Lever		1
46	TFB265535-01	Select Lever		1
47	TFW305443-01	Select Lever Spring		1
48	TGB305404-0A	Motor Bracket Ass'y		1
49	TDD265467-0B	Motor Ass'y		1
50	53492	Rubber Bushing	for Motor	3
51	T30302-058	Collar		3
52	TGD265561-0B	Flywheel Ass'y		1
53	TEB265499-01	Capstan Belt		1
54	TFB265492-01	Flywheel Holder		1
55	TEP265498-01	Thrust Washer		1
56	TEB265497-01	Take Up Belt		1
57	TGW305303-0A	Counter Ass'y		1
58	TFB265495-01	Plate		1
59	TFB305406-01	Counter Bracket		1
60	TEB305407-01	Counter Belt		1
61	TGB305409-0A	Pause Bar Ass'y		1
62	QSP1210-011	Push Switch Ass'y	for Pause	1
63	TFB305408-01	Pause Switch Bracket		1
64	TFB305411-01	Bracket	for Pause Bar	1

Ref. No.	Parts No.	Parts Name	Remarks	Q'ty
65	TDP281305-01	D.C Solenoid		1
66	TFH281422-01	Pin		1
67	TFB305412-01	Pause Arm		1
68	TFW305413-01	Wire		1
69	TFB265543-01	Pause Lever		1
70	TFB291411-01	Cassette Holder		1
71	T47610-001	Reflection Plate		1
72	TFH305442-01	Special Screw		1
73	TGB305432-0A	Holder Bracket Ass'y	Left	1
74	T44546-002	D.C Solenoid		1
75	TFB265458-02	Solenoid Bracket		1
76	TFH265457-01	Solenoid Pin		1
77	TFB265456-01	Guide Plate		1
78	A50221-001	Lug		1
79	TFB265550-01	Record Lock Lever		1
80	TFW265551-01	Lock Lever Spring		1
81	TGB305430-0A	Holder Bracket Ass'y		1
82	TFB305429-01	Bracket		1
83	T30155-001	Si Diode	for Solenoid	2
84	T46207-003	Head Plate		1
89	T30300-153	Spring		1
90	" -140	"	for Brake Lever	1
91	" -121	"	for Lock Lever	1
92	" -126	"	for Idler	1
93	" -132	"	for Button Cam	1
94	" -135	"	for Idler	1
95	" -136	"	for R. Lever	1
96	" -137	"	for FF Bar	2
97	" -139	"	for P. Bar, S. Lever	1
98	T30301-080	"	for REW Bar	1
99	" -103	"	for Back Tension	1
100	" -106	"		
101	" -115	"	for E. Head	2
102	T47828 001	Nut	M8 x 0.75	1
103	NNS2000N	"	for Micro Switch	2
105	NTB3000S	"	for Solenoid	1
106	SSSP2604Z	Screw	for Bracket	2
107	SSSP2012Z	"	for Micro Switch	2
109	SPSP2008Z	"	for R. P/E Head Stopper Bar	5
110	SPSP2010Z	"	for R. Spring	1
111	SPSP2012Z	"	for Spring	1
113	LPSP2005Z	"	for Brake Arm	19
114	LPSP2006Z	"	for FF Arm, Holder	4
115	LPSP2604Z	"	for Solenoid, G. Plate	3
116	LPSP2605Z	"		10
118	LPSP2608Z	"	for Motor	3
119	LPSP3005ZS	"	for Counter	2
120	WLS2000	Washer	for Micro Switch	2
121	WLS3000	"	for Solenoid	1
122	WNS2000N	"	for R.P Head	2
123	Q03091-154	"	for Motor	3
124	WNB2600N	"	for Solenoid	2
125	Q03093-430	"	for Slide Base	2
126	" -610	"	for Idler Pulley	2
127	" -611	"	for Flywheel	2
128	REE1000	E. Ring	for Idler	1
129	REE1200	"	for Disk, Switch Lever	4
130	REE1500	"	for Pin	1
131	REE2000	"		8
132	REE2500	"		6
133	REE4000	"		1

Record Player Components

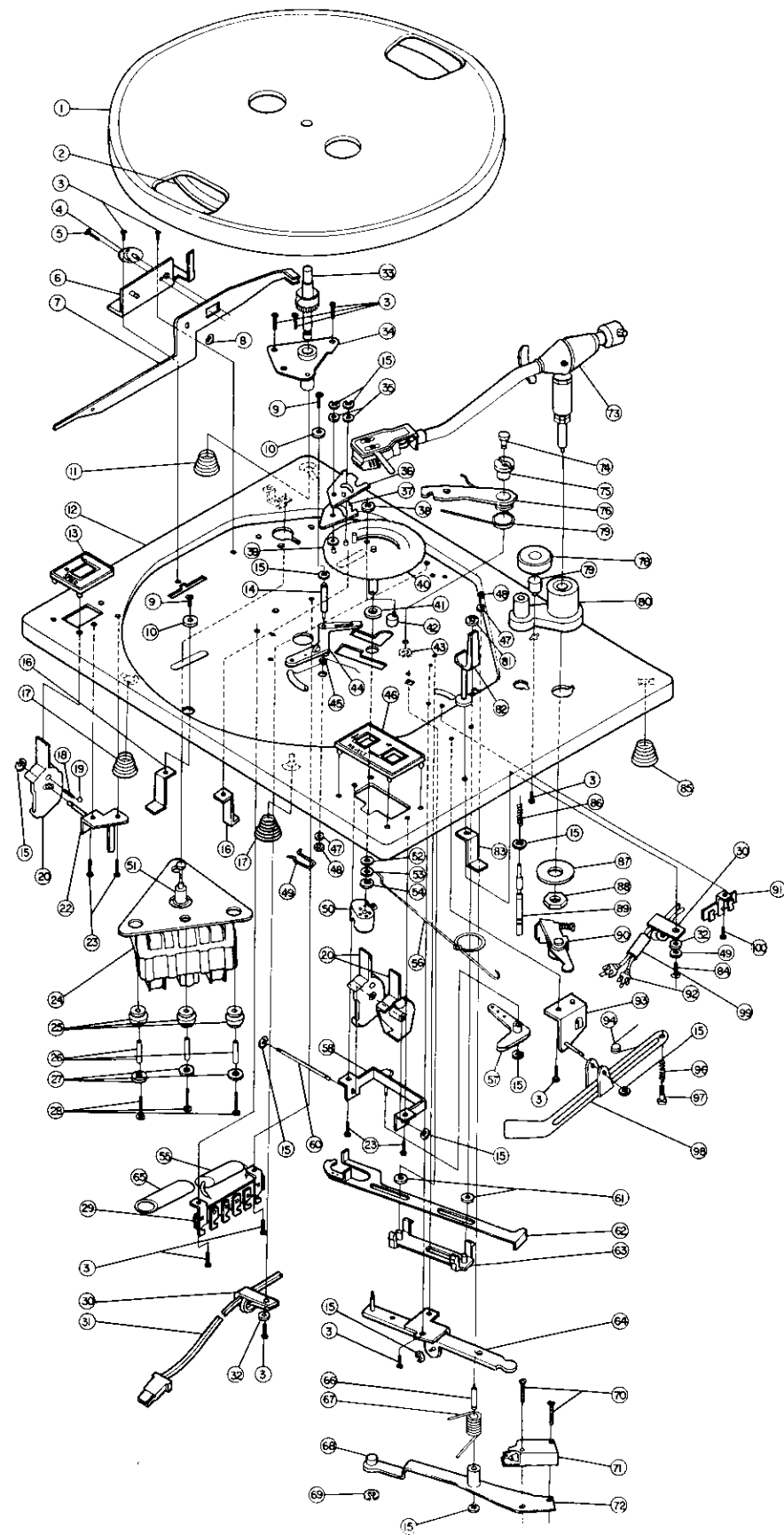

Fig. 45

Record Player Component List

Ref. No.	Parts No.	Parts Name	Remarks	Q'ty
1	YG-0001	Turn Table		1
2	EG-100058	Belt		1
4	YG-00002	Adjuster		1
5	ZBC3x6	Screw	for Adjuster	1
6	YG-00003	Shifter Base Unit		1
7	YG-00004	Rod Arm		1
11	EG-100504	Conical Spring		1
12	YG-00005	Base Plate		1
13	YG-00006	Change Cover Unit		1
14	YG-00007	REJ Lever Shaft		1
16	EG-100113	Stopper		2
17	EG-100502	Conical Spring		2
18	YG-00008	Cam Spring		1
19	YG-00009	Still Ball	φ4	1
20	YG-00010	Select Lever		3
22	YG-00011	Sp. Select Base Unit		1
24	YG-00012	Motor Ass'y		1
25	EG-100099	Cushion Rubber	for Motor Ass'y	3
26	YG-00013	Tube Spacer		3
29	YG-00014	Lug		1
30	YG-00015	Wire Clamp		2
31	YG-00016	Power Cord		1
33	YG-00017	Spindle Shaft Ass'y		1
34	EG-100057	Shaft Holder		1
35	YG-00018	Engagement Washer		2
36	EG-100006	Engagement		1
37	EG-100007	Lower Trip		1
39	YG-00019	Gaid Washer		1
40	EG-100628	Gear Ass'y		1
42	EG-100009	Adjuster		1
44	EG-100014	Kick Lever		1
45	EG-100015	Return Spring		1
46	YG-00020	REJ Cover Ass'y		1
49	EG-100071	Stopper		1
50	EG-100514	Switch Lever		1
51	YG-00021A(50Hz) YG-00021B(60Hz)	Pulley		1
55		Capacitor	0.047μ/600V	1
56	YG-00023	REJ Spring		1
57	EG-100664	REJ Ring		1
58	YG-00024	REJ Base		1
60	YG-00025	Cam Shaft		1
61	EG-100559	Washer	for Trip Slide	2
62	YG-00026	Trip Slide		1
63	YG-00027	Action Base		1
64	EG-100545	Seesaw Ass'y		1
66	EG-100557	REJ Lever Shaft		1
67	YG-00029	Arm Spring		1
68	EG-100591	Pin	for Switch Arm	1
71	EG-100018	Micro Switch		1
72	EG-100650	Switch Arm Ass'y		1
73	YG-00030	Pick Up Ass'y		1
74	EG-100509	Gear Stop Stud		1
75	EG-100508	G.S Shaft		1
76	EG-100510	G.S Arm		1
77	EG-100567	G.S Spring		1
78	YG-00031	E.P. Adaptor		1
79	EG-100505	Adaptor Shaft		1
80	YG-00032	P.U. Base		1
82	EG-100651	Rest		1
83	EG-100526	Stopper		1
85	YG-00033	Conical Spring		1
86	EG-100571	Elevation Spring		1
89	YG-00034	Elevation Shaft Ass'y		1
90	YG-00035	Arm Lever Ass'y		1
91	YG-00036	Lug		1
92	YG-00037	Signal Cord Ass'y		1
93	YG-00038	Seesaw Base		1
94	YG-00039	Seesaw Spring		1
98	YG-00040	Seesaw Arm		1

Assembly Parts Except Enclosure Parts

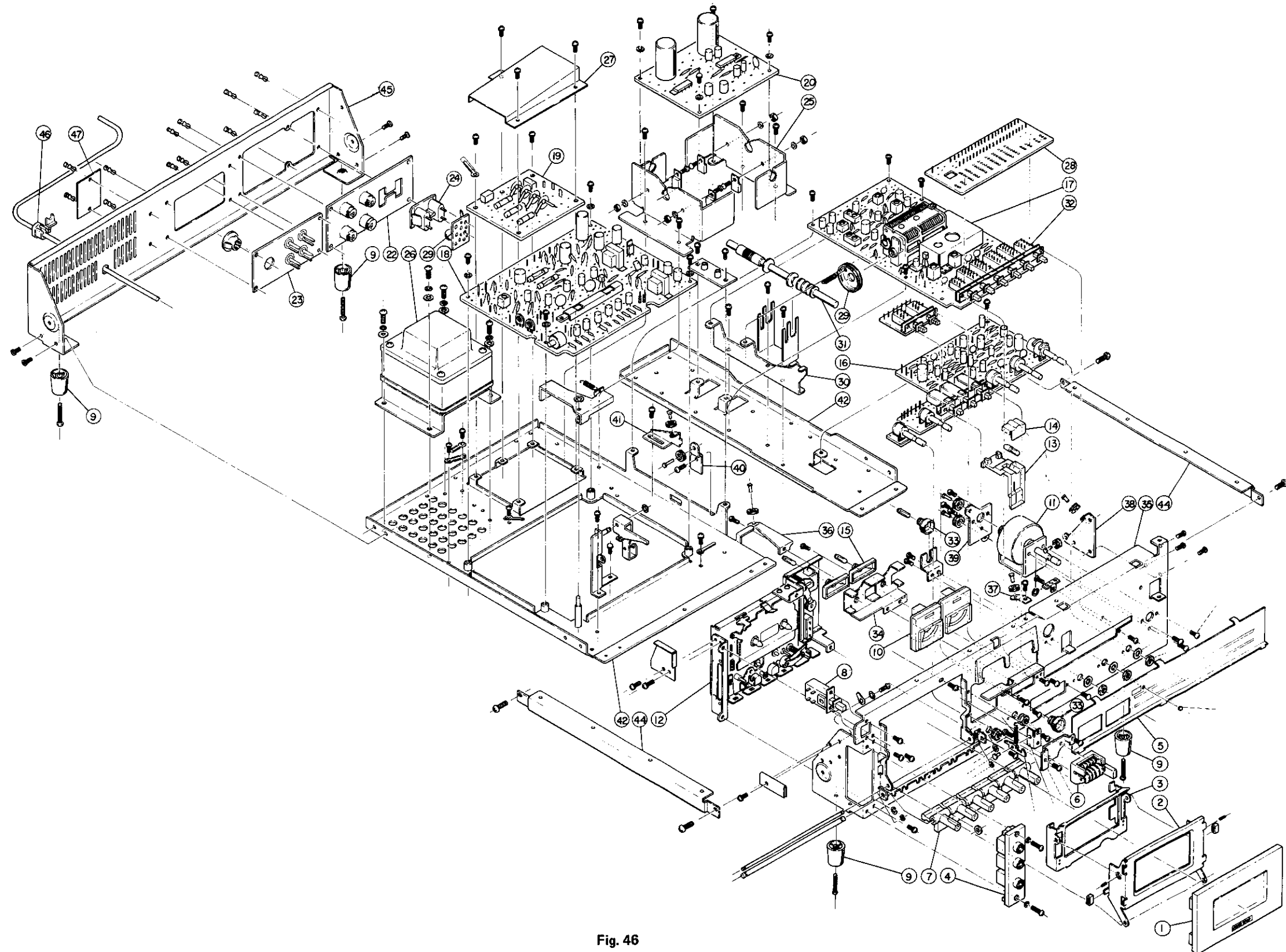

Fig. 46

Assembly Parts List

Ref. No.	Parts No.	Parts Name	Remarks	Q'ty
1	TJP291327-0A	Cassette Door Ass'y		1
2	TGB291322-0A	C. Door Holder Ass'y		1
3	TGB291423-0A	C. Holder Ass'y		1
4	TAJ031304-03	Mic & HP Jack Ass'y		1
5	TJD291313-01	Dial Scale		1
6	TGW291324-0A	Counter Ass'y		1
7	TJB291305-0D	Push Button Ass'y		4
	" -0E	"	for Rec	1
	" -0F	"	for Stop Eject	1
	"	"	for Power	1
8	QSP2111-001	Push Switch		1
9	TJF291463-01	Foot		4
10	TDM291328-01	Level Meter		2
11	YKA40003-001	Tuning Shaft Ass'y		1
12	YMC-001	C. Mechanism Ass'y		1
13	TJD291308-01	Needle		1
14	TFB291453-01	Needle Cover		1
15	TER267472-01	Tape Run Bush	for Level Meter Lamp	2
16	TAA291207-0A	Control Amp. C.B. Ass'y		1
17	TAA270209-0A	Tuner C. Board Ass'y		1
18	TAA270206-0A	Rec & PB Amp. C.B. Ass'y		1
19	TAA291319-0A	Fuse C. Board Ass'y		1
20	TAA291317-0A	Power Amp. C.B. Ass'y		1
21	TAA270480	Antenna C.B. Ass'y		1
22	TAJ291315-0A	SP. Jack Ass'y		1
23	TAJ291318-0A	Din Jack Ass'y		1
24	TLZ270306-01	FM Antenna		1
25	TAR291316-01	Heat Sink		1
26	TAP291301-01	Power Transformer		1
27	YXQ30003-001	Shield Cover		1
28	TAA291321-01	Circuit Board	for Push SW	1
29	QZD1205-003	Dial Drum		1
30	TFB291320-01	Ant. Holder		1
31	TBA291-01	Bar Antenna Ass'y		1
32	QSP0262-001	Push Switch		1
33	TER272407-01	Lamp Bush		2
34	TFB291451-01	Lamp Bracket		1
35	TFB291104-01	Front Bracket		1
36	TGB291469-0A	Roller Bracket		1
37	TGB291472-0A	"		1
38	TGB291471-0A	"		1
39	TGB291470-0A	"		1
40	TGB291468-0A	"		1
41	TGB291467-0A	"		1
42	TGC291205-0A	Chassis L Ass'y		1
43	TFC291204-0A	Chassis R Ass'y		1
44	TFB291307-01	Side Bracket		2
45	TFB291105-01	Rear Bracket		1
46	QHS6374-162	Bushing		1
47	TJL000329-05	Name Plate		1

Packing

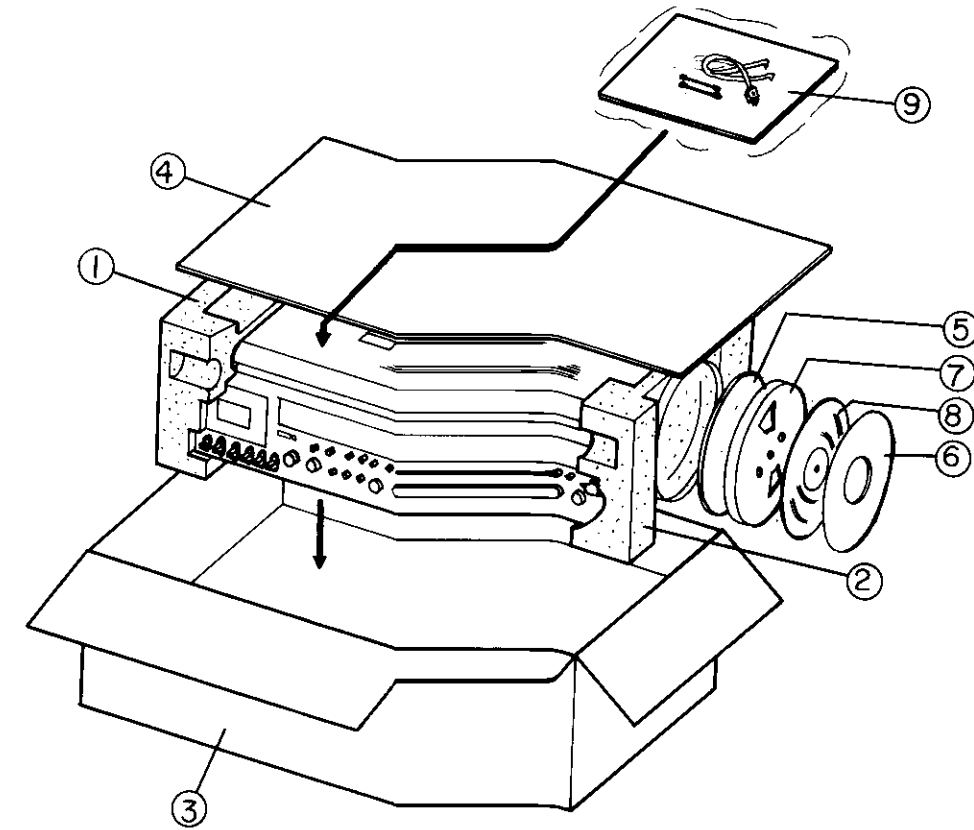

Fig. 47

Packing List

REF NO.	PARTS NO.	PARTS NAME	REMARKS	QTY
1~6	TKB291330-0A	Packing Case Ass'y		1set
1	TKC291108-01	Cushion(L)	Left	1
2	TKC291109-01	" (R)	Right	1
3	TKB2913301-01	Case		1
4	" -02	Cushion		1
5	" -03	"	for a Turn Table	1
6	" -04	"	"	1
7	YG-00001	Turn Table	with Belt (EG100058)	1
8	TLE000333-02	Turn Table Covering		1
	TLE000474-01	Envelope	for a Unit	1
	T6800-00K	"	for a Top Cover	1
	AP4056A-035	"	for a Turn Table	1
	AP4056A-077	"	for a Power Cord	1
	AP4056A-024	"	for an Instruction Book & FM Antenna	1
			for a Head Stick	1

Accessories

REF NO.	PARTS NO.	PARTS NAME	REMARKS	QTY
9	T7195EGF	Instruction Book		1
		FM Antenna Ass'y		1
		Head Stick		2

Wiring Diagram of Model MF-1845L

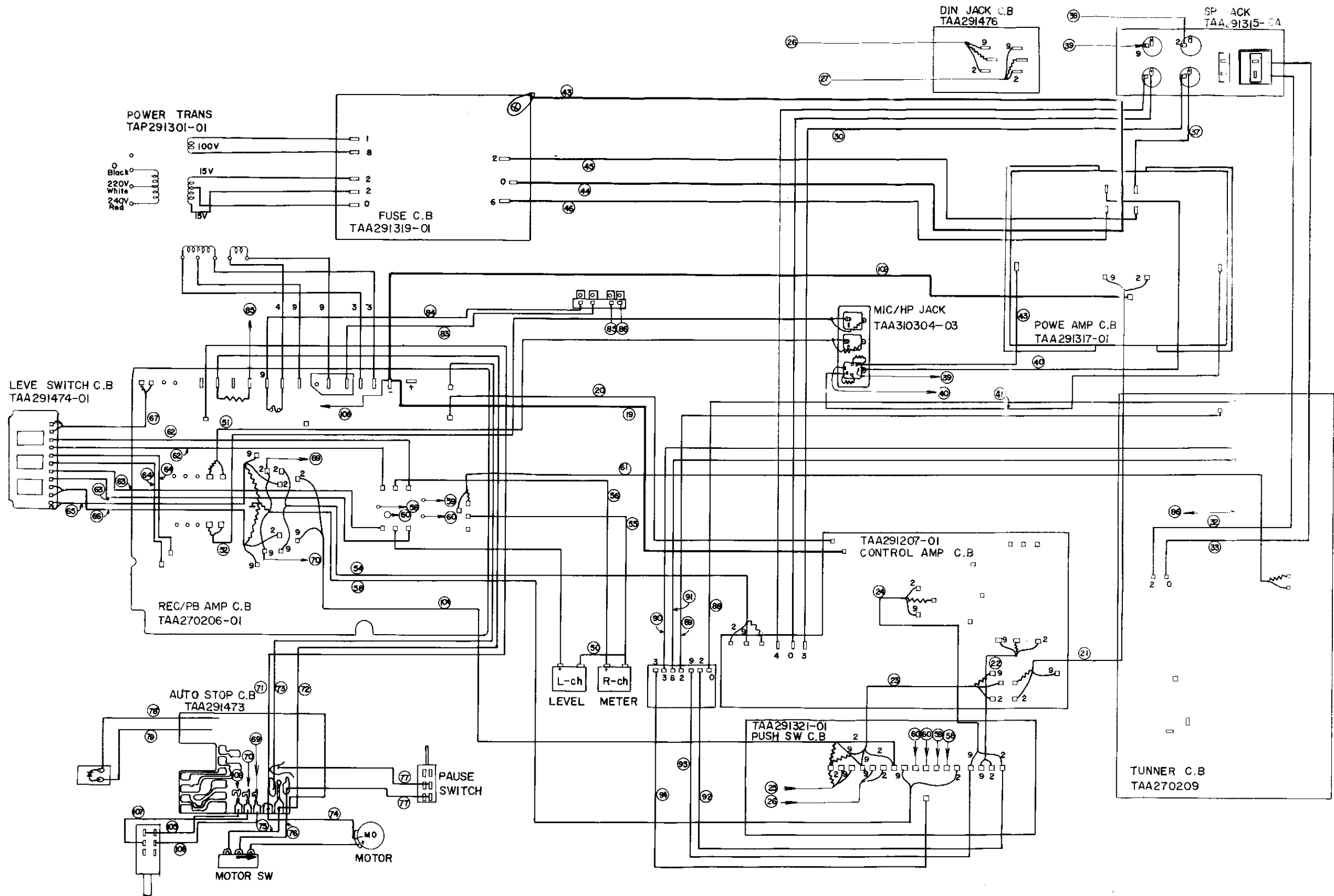

Fig. 48

Standard Schematic Diagram of Model MF-1845L

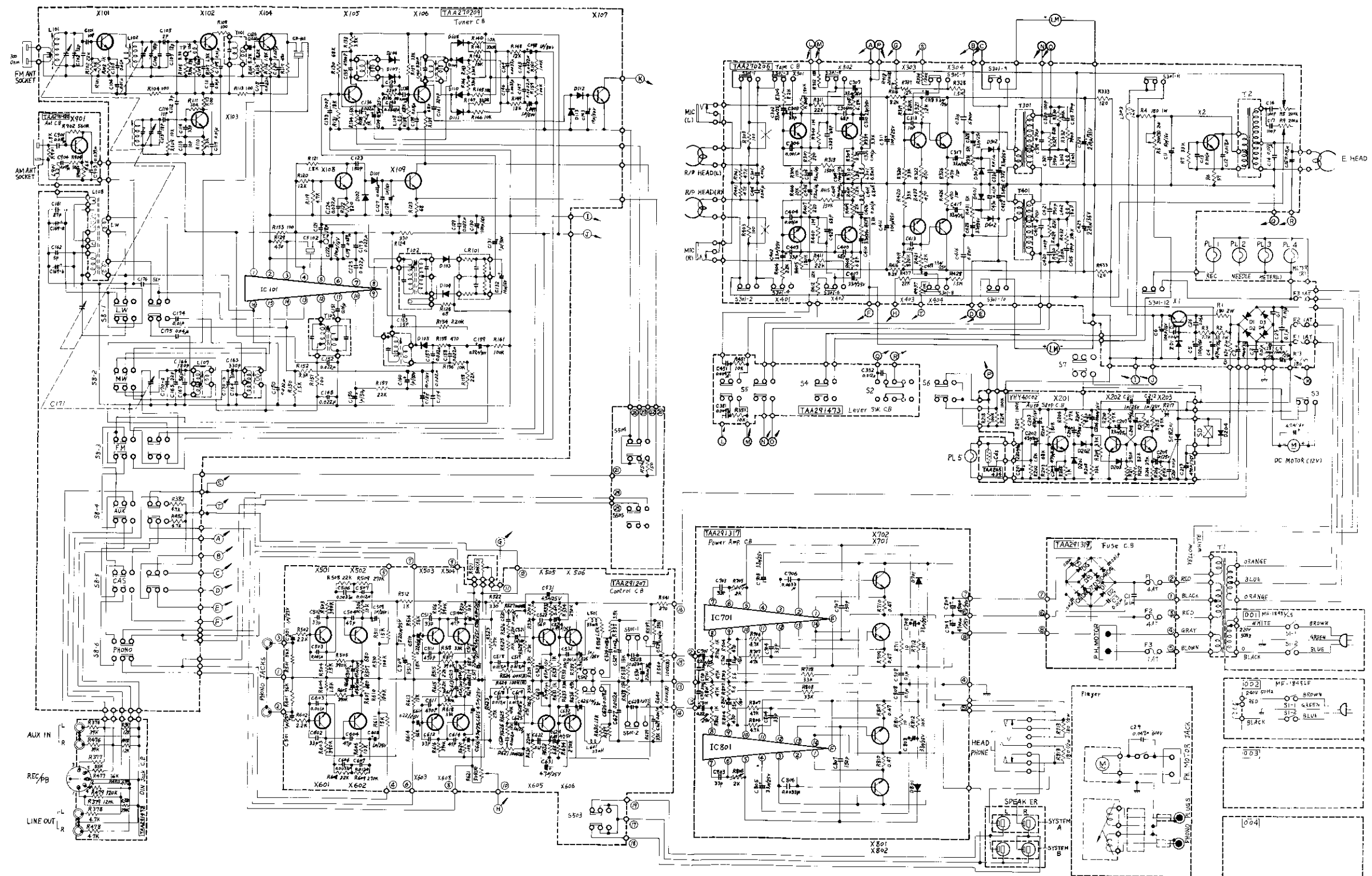

Fig. 49