

TELEVISEURS

SCHÉMA

SURCOUF

CAPITOLE

CROISEUR

CORSAIRE

SIRENE

FREGATE

ÉQUIPÉS DU CHASSIS
DE BASE N° 1470

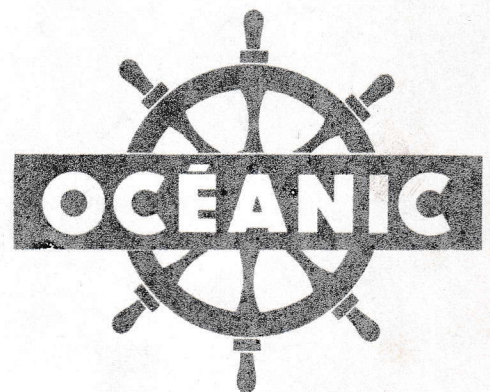

R.C. SEINE 56 B 1.383 - S.A. AU CAPITAL DE 10.510.500
119, Rue de Montreuil - PARIS-XI^e

Tél. : Lignes groupées : 307-71-59

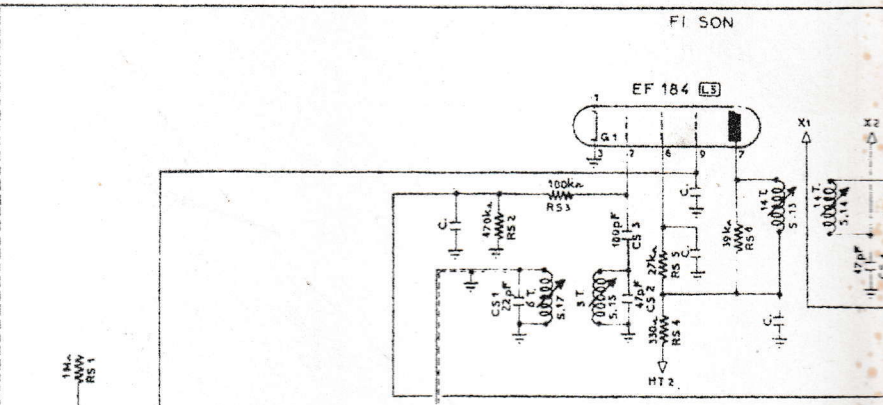
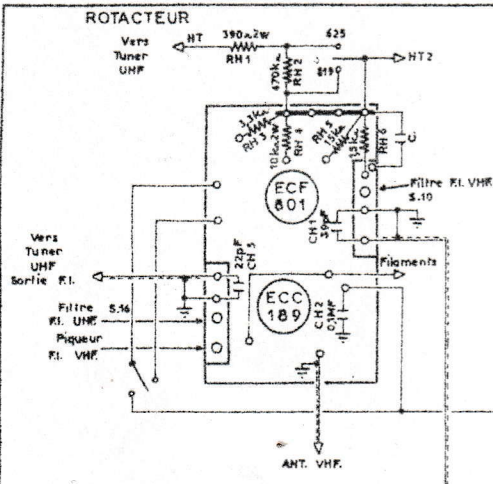

- ### OSCILLOGRAMMES
- A Video signal frame
 - B Video signal frame
 - C 10 V.C.C. Lignes
 - D 20 V.C.C. Lignes
 - E 130 V.C.C. Lignes
 - F 200 V.C.C. Lignes
 - G 45 V.C.C. Images
 - H 30 V.C.C. Images
 - I 75 V.C.C. Images
 - J 0,4 V.C.C. HT. Rése
 - K 0 V.C.C. HT. Rése

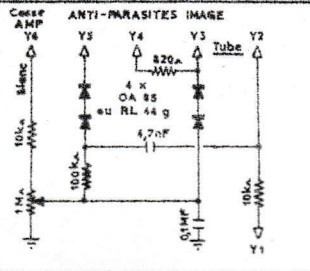
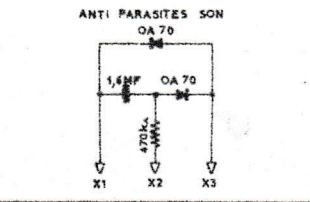

FAIRE LE COURT-CIRCUIT DE LA RV 41
1,2k, 3w EN VIDEO.

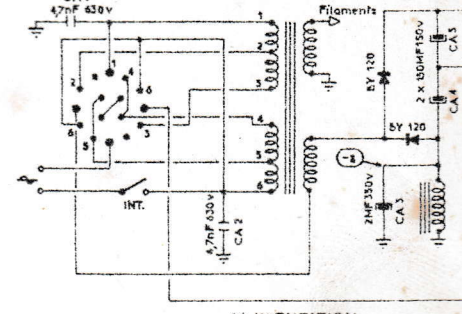
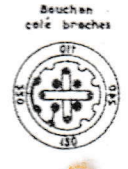
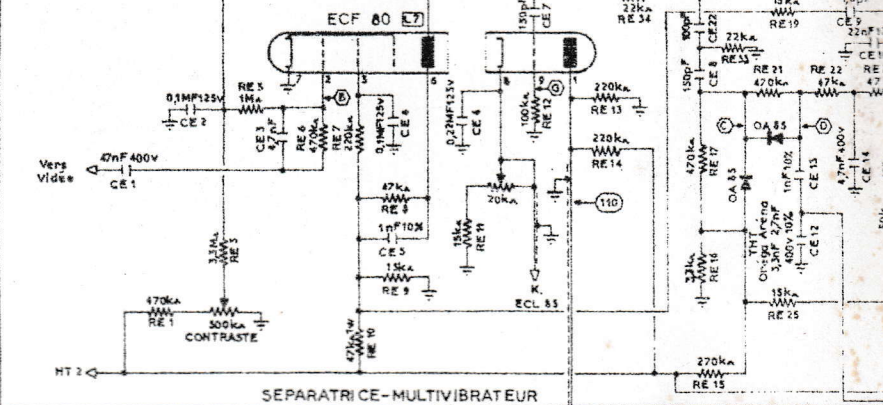
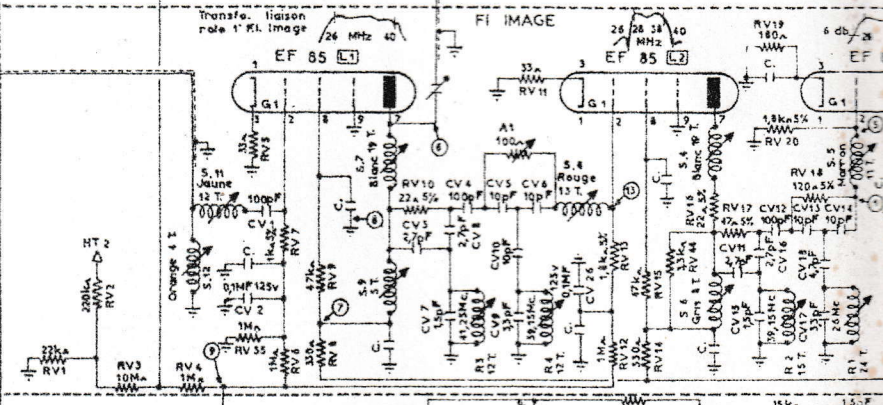
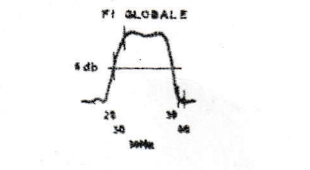
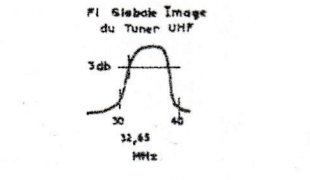

Résistances: 1/2 w miniatures

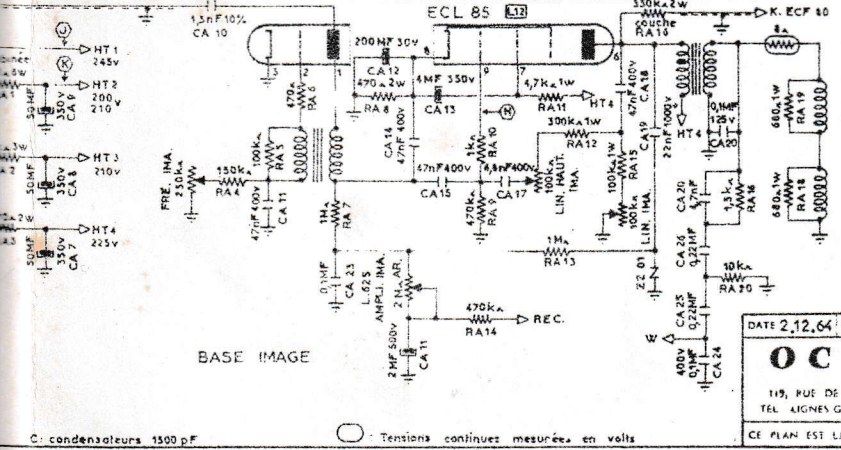
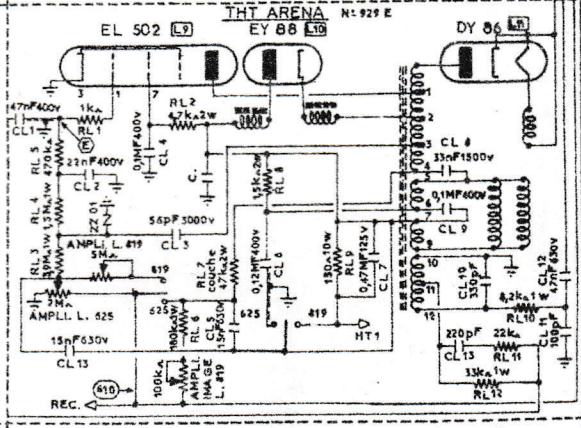
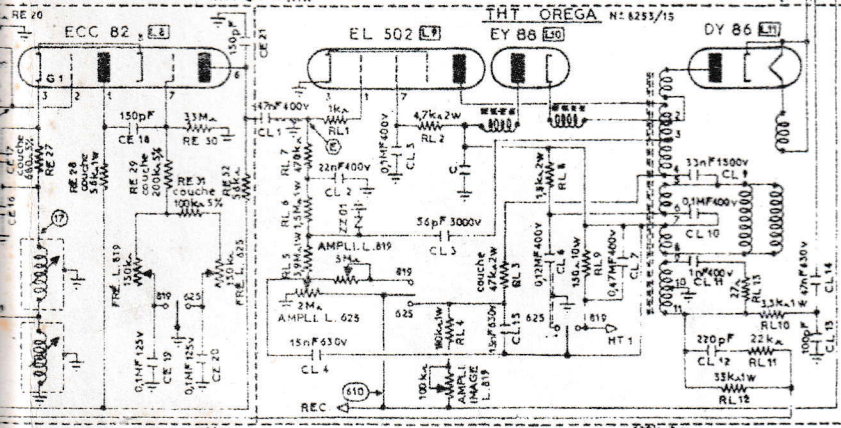
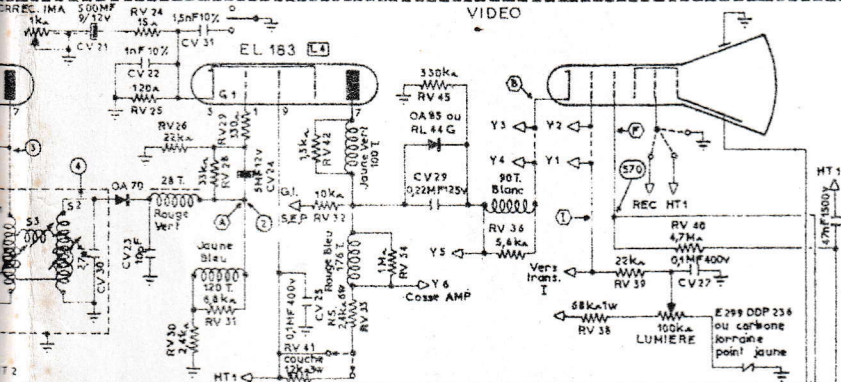
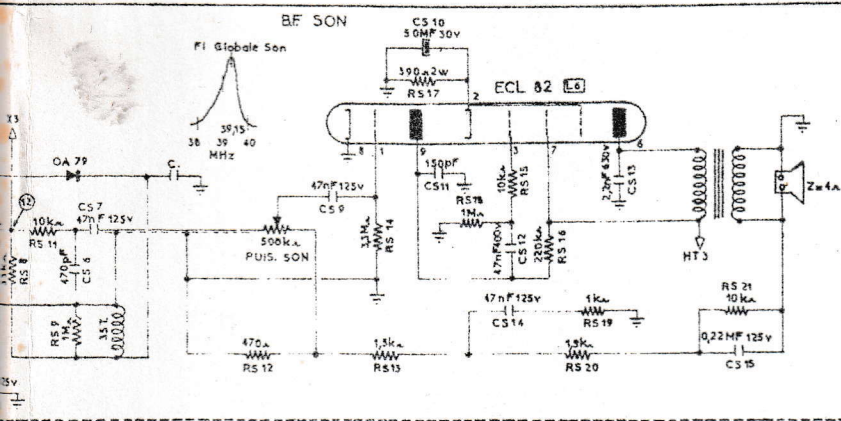

DATE 2.12.64 EX PALMANTIER VER

OCEANIC

119, RUE DE MONTREUIL - PARIS 11 -

TEL. AIGNEES GROUPEES DID 26 45 DOOR 71 59

SCHEMA TV 2-3

1471

3

C: condensateurs 1500 pF

○ Tensions continues mesurees en volts

CE PLAN EST LA PROPRIÉTÉ DE LA SOCIÉTÉ OCEANIC

COPIE OU COMMUNICATION INTERDIT

VOI DU 11 MARS 1965