

AMATEUR RADIO

DEFENSE



PUBLICATION OFFICES:

Monadnock Building
San Francisco - California

MARCH
1941

25 CENTS

Yearly Subscription \$2.50

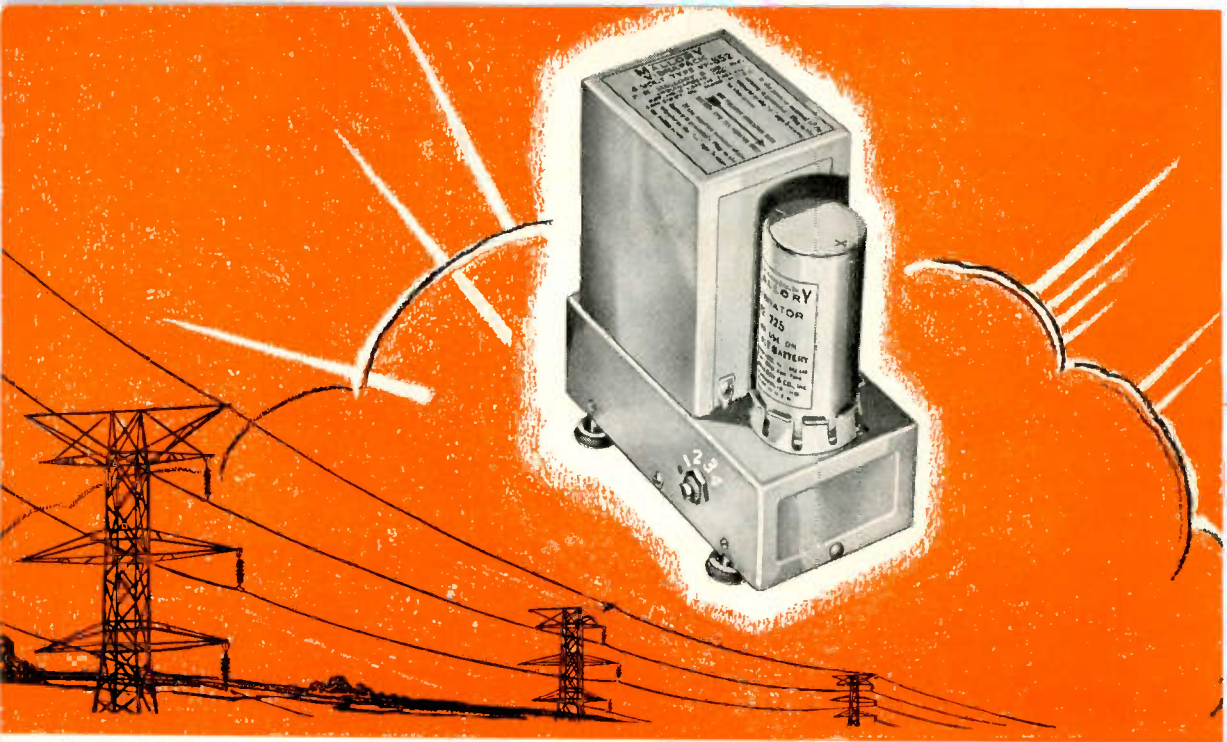

Vibrapacks

(TRADE MARK REG. U. S. PAT. OFFICE)

The Dependable Answer to Plate Voltage when...and where commercial electric power is not available

Radio operators, engineers and public address men everywhere have discovered that the most satisfactory and economical answer to dependable plate voltage from a storage battery source is a Mallyory Vibrapack. This *perfected* Vibrator type power supply is easy to use... efficient and gives long trouble-free service.

Mallyory Vibrapacks are available in both self-rectifying and tube-rectifying types. The complete line includes single and dual Vibrapacks, including types for operation with the 12 volt and 32 volt batteries commonly used in airplane, bus and boat service. Check the specifications of the complete line and see which one suits your needs.

THE COMPLETE VIBRAPACK LINE



Catalog Number	Nominal Operating Voltage	Nominal Output Voltage	Maximum Output Current	Type	Price
VP-551	6.3	125-150-175-200	100 ma.	Self-Rectifying	\$15.00
VP-552	6.3	225-250-275-300	100 ma.	Self-Rectifying	18.50
VP-553	6.3	125-150-175-200	100 ma.	Tube Rectifier	16.50
VP-554	6.3	225-250-275-300	100 ma.	Tube Rectifier	20.00
VP-555*	6.3	300	200 ma.	Tube Rectifier	37.50
VP-557*	6.3	400	150 ma.	Tube Rectifier	37.50
VP-G556	12.6	125-250-275-300	100 ma.	Self-Rectifying	20.00
VP-F558	32.	225-250-275-300	100 ma.	Tube Rectifying	20.00

P. R. MALLORY & CO., Inc.
INDIANAPOLIS INDIANA
Cable Address—PELMALLO

*Special Dual Packs for high output

More than ever INSIST ON

P. R. MALLORY & CO. Inc.
MALLORY
APPROVED
PRECISION PRODUCTS

VIBRATORS • VIBRAPACKS • CONDENSERS • VOLUME CONTROLS • ROTARY SWITCHES • SINGLE AND MULTIPLE PUSH BUTTON SWITCHES • RESISTORS
RADIO HARDWARE

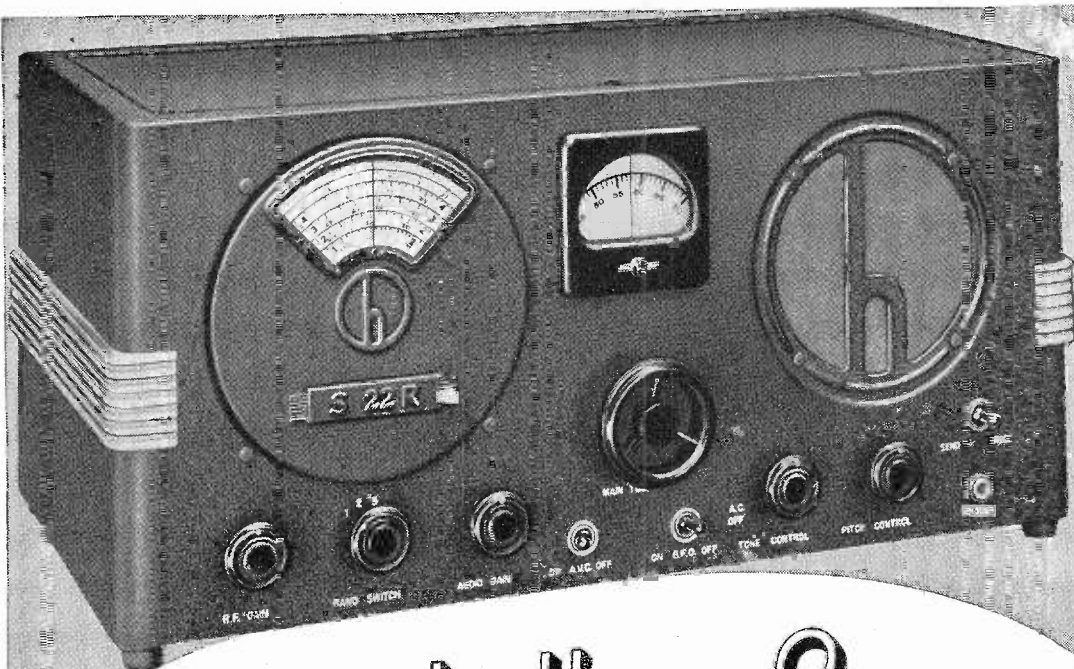

a new hallicrafters
 WITH 1941 IMPROVED FEATURES
The SKYRIDER MARINE
 (MODEL S-22R)

THIS communications model is truly an all purpose receiver: Covers Weather and Time Signals (NAA). Beacons and Aircraft Weather. Commercial wave lengths—Ship-to-Shore, Ship-to-Ship, (calling and working on the same band.) The Broadcast band. The Amateur Bands (160 to 20 meters inclusive.) Police, High Frequency Ship-to-Shore, Aircraft, Press and Government channels. Plus the International Short Wave channels. 4 Bands. Frequency range from 16.5 to 2730 meters

IMPROVED FEATURES—Two stages of IF—Greater sensitivity and selectivity. Permeability tuned IF transformers assure permanency of tuning.

Specialty treated variable mica condensers will maintain adjustment under all atmospheric changes.

Directly calibrated main tuning dial.

Permeability-tuned beat oscillator with control to change BFO setting.

All steel parts and chassis heavily copper plated and nickelled.

(18 mc. to 110 kc.). 110 volt AC/DC operation.

Easy logging is provided by mechanical bandsread with separate dial. The directly calibrated main tuning dial eliminates the use of confusing charts and tables. The improved image rejection at the higher frequencies is achieved through the use of a 1600 kc. IF amplifier. Tuning permanency is assured through permeability tuned IF transformers. The 1941 Sky Rider Marine (Model S-22R) will give the maximum in utility and dependability.

Highly efficient mechanical bandsread with separate dial provides easy logging.

Frequency range 16.5 to 2730 meters (18 mc. to 110 kc.). Band 1—110-410 kc. . . . Band 2—400-1500 kc. . . . Band 3—1.7-5.9 mc. . . . Band 4—5.3-18 mc. 8 Tubes. cabinet dimensions 18½" x 9½" x 8½"

The Sky Rider Marine (Model S-22R) complete with tubes and speaker; \$64.50 net.

the hallicrafters inc.
 CHICAGO, U. S. A.

USED BY 33 GOVERNMENTS • SOLD IN 89 COUNTRIES

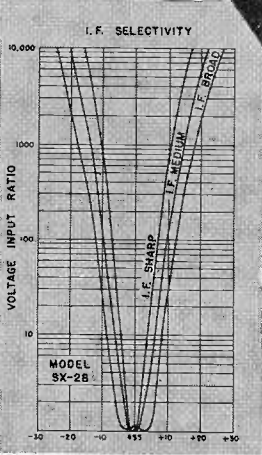
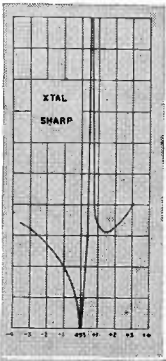

C Communications at its Best!

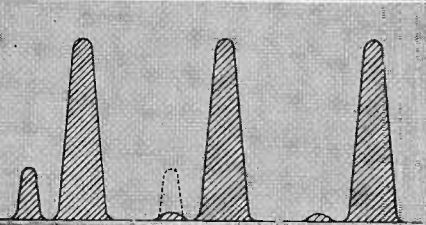
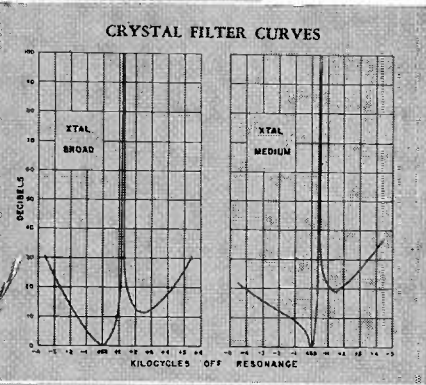

THE NEW 1941 Hallicrafters Model SX-28 offers communications at its best. The outstanding reception capabilities of this new model are already winning high praise for top quality performance.

Model SX-28 is a 6 band, 15 tube receiver giving you complete front part control over every phase of the circuit. 2 stages of preselection . . . high fidelity push-pull audio . . . calibrated electrical bandspread . . . micrometer scale on main tuning knob . . . 6 position selectivity control . . . band pass audio filter . . . automatic noise limiter . . . new crystal filter circuit . . . ball bearing tuning mechanism . . . semi-floating main tuning and bandspread condensers. Covers 550kc. to 43mc. Panel is exact rack size. Chassis has rigid girder construction. Hallicrafters-Jensen Bass Reflex speakers available. With crystal and tubes, less only speaker.....\$159.50

New 1941 Hallicrafter Catalog just off the press. 20 color pages illustrating the complete new 1941 Hallicrafter line—ask for your copy today! Or write the factory.

the hallicrafters inc.
CHICAGO, U. S. A.

USED BY 33 GOVERNMENTS • SOLD IN 89 COUNTRIES

Vol. 1 • No. 5

MARCH, 1941

★ ★ ★

STAFF

A. H. HALLORAN
Editorial Director

H. W. DICKOW
W6JYN
Managing Editor

L. R. HUBER
W7CRJ
Associate Editor

FRANK C. JONES
W6AJF
Technical Editor

C. C. ANDERSON
W6FFP
Engineering Draftsman

N. R. FARBMAN
W6SEM
Staff Photographer

L. L. FUNSTON
W6QQU
Illustrator

BUSINESS OFFICES

Monadnock Building
San Francisco, Calif.

Subscription Price:
\$2.50 per year in the
U.S.A. and its posses-
sions. Elsewhere \$3.00
per year.

Copyright 1941 by
Pacific Radio Publish-
ing Company. Techni-
cal matter must not
be reprinted without
permission.



AMATEUR RADIO DEFENSE

Published Monthly

By

Pacific Radio Publishing Co.

In the Interests of

Amateur Radio Defense Association



CONTENTS FOR MARCH

Chats With the Editors.....	4
The Editor's CQ.....	9
A.R.D.A. and the Seattle Black-Out Test; <i>John P. Gruble, W7RT</i>	12
All-Band, 'Phone-C.W. Transmitter-Receiver for Defense; <i>Robt. H. Browne, W6AHH</i>	16
High-Power Screen-Grid Transmitter..... <i>N. R. Farbman, W6SEM</i>	20
The Top-Loaded Antenna..... <i>Technical Staff</i>	27
"Techquiz"..... <i>C. C. Anderson, W6FFP</i>	29
Pee-Wee De-Luxe Transmitter-Receiver	33
Circuit of the Month.....	36
The War and the Radio Amateur.....	39
The Peaked Audio Filter..... <i>C. C. Anderson, W6FFP</i>	40
Heard on 160 Meters.....	44
QRM and QRN	47
News from Washington.....	48
It Once Was DX..... <i>Stanley Johnson, W6SZ</i>	49
Engineering Applications	51





Chats with the Editors

Our Front Cover

... If and when Uncle Sam goes to war, guns, planes and ships on the Yank side will move noticeably faster because of near-perfect communication, such as the naval reserve operators are being trained for in the picture on our front cover. Taken expressly for *Amateur Radio Defense* at NDK, Norfolk, Va., this picture symbolizes the speeded-up process under which the naval reserve is going ahead these days. Let no one kid himself, either: U. S. Navy radio operators are the world's best, just as our gunners and pilots are rated tops in world fighting performance. When you can hold up your end of a navy circuit, you've become an *operator!*

* * *

Commander Reinartz Addresses Amateurs

... From "*The Arc*," a monthly amateur bulletin issued at Asheville, N. C., and edited by James W. Harrison, W4FSE, we quote:

The North Carolina Floating Club, now in its tenth year, held its first 1941 meeting in Charlotte January 12 with 161 hams present. The program featured an address by Commander John Reinartz of the United States Navy.

Commander Reinartz's ham to ham talk, delivered in Johnny's own inimitable style, outlined methods by which the amateur could aid the Communications Board in the defense program now getting into full swing. He pointed out the necessity for the amateur to, now more than ever, call upon his ingenuity and common sense in finding ways to make himself more useful and that the future status of amateur radio depended upon the amateur making himself indispensable to the welfare of the people and the military and economic forces of the country. His listeners could gather from his well chosen words, carefully measured and weighed, that his superiors in Naval Communications were in full sympathy with the amateur and were cognizant of the amateurs' usefulness in the scheme of defense. One could surmise, more from that

which was left unsaid than from that which was actually uttered, that, if the amateur makes himself needed during the emergency which is upon the country, there will be no total "blackout" of amateur radio even should there be an actual state of war in which the United States is a belligerent. His address was eloquent in its plea for the further justification of amateur radio, and there could be no one who heard who could doubt that Johnny is first, last and always an amateur and that in the hands of such men as he and others of his like that amateur radio is in safe hands. But let not the matter be forgotten here. Let not the attitude of "let Reinartz and Talley and George keep us on the air" be our slogan. Let our own purposes and actions justify the continuation of our right in the spectra.

Commander Reinartz interspersed his address to the gathered hams with an example of how the amateur can use his knowledge and ingenuity in constructing a device which will graph a permanent visible record of any broadcasted signals. There might come a time when it would be to the advantage of the amateur to be able to so monitor such transmissions. Even a dormant imagination should be able to embrace the possibilities of such a scheme. Commander Reinartz will be glad to send a diagram of this device to any amateur who is genuinely interested. Enclose a stamped, addressed envelope with your request. His QRA is W3IBS and his QTH is: 1400 North Ivanhoe St., Arlington, Va.

* * *

THE WAR has put amateur radio into the limelight and the daily press has seen fit to exploit our achievements. A.R.D.A. is feeding syndicated material to a long list of papers now, and you'll read a lot about us PDQ. One of the largest pictorial magazines wants an armful of pictures and facts on A.R.D.A. membership activities. This is the first time in our 24 years of publishing history that we have been *asked* to compile amateur radio material for public consumption.

Modernize *YOUR* Station

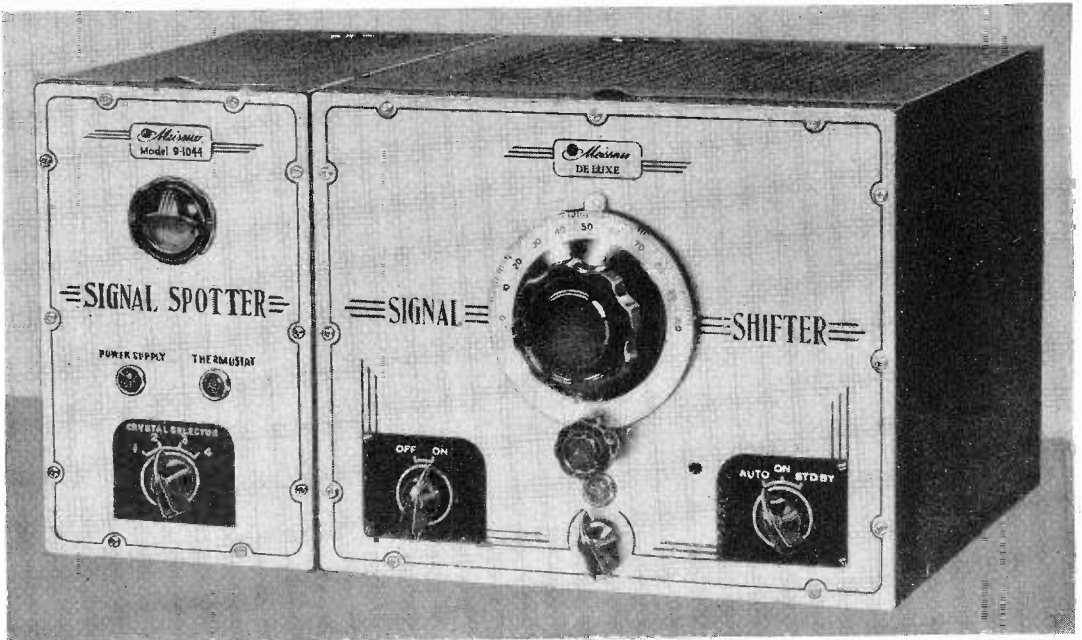

With this Outstanding Combination!

It's really surprising, the number of stations that are equipped with Meissner SIGNAL SHIFTERS! Of course we realize the instrument is "tops" but it's almost uncanny to get on the air and have station after station come back with, "I'm using a Meissner DeLuxe SIGNAL SHIFTER."

We are proud of this unsolicited praise of our product by ACTUAL USERS! When we stop to realize that the SIGNAL SHIFTER is accepted as one of the highly important necessities in a well equipped station — we just wouldn't be human if we failed to mention the fact!

A few weeks ago, we announced a companion unit to the popular SIGNAL SHIFTER — known as the SIGNAL SPOTTER. This unit is basically a crystal oscillator assembly in which four crystals can be used and instantly selected by the turn of a switch. FOUR CRYSTALS for spot-frequency operation — on band edges, Army and Navy networks and on "traffic" channels. The required operating power is supplied by the SIGNAL SHIFTER. A two-position *control-switch enables the operator to instantly select the type of excitation desired: "ECO," for full-band flexibility, or "XTAL," for spot-frequency operation.

*NOTE — This control switch is factory-mounted in the new 1941 model Signal Shifter, No. 9-1058. For addition of the Signal Spotter to previous model Signal Shifters, the switch is supplied separately, at no extra cost, with simple instructions for installation.

The SIGNAL SHIFTER-SIGNAL SPOTTER Combination provides the LAST WORD in a precision type frequency control system for the Amateur Station! Appearance? The Boys tell us that the "combination," shown in the photo above, is the "best looking equipment on the operating table!"

It has never been our policy to introduce so-called "new models" that would make previous models obsolete or "out of date." The SIGNAL SPOTTER is designed for use with the FIRST SIGNAL SHIFTER, placed on the market three years ago, as well as with the LATEST SIGNAL SHIFTER to come out of our lab! Regardless of WHEN your SIGNAL SHIFTER was purchased, it may be effectively used with the SIGNAL SPOTTER.

Don't fail to see this modern "combination" at your local Parts Jobber's — TODAY! You will experience a new thrill when you see the attractive, clean-cut appearance of this equipment — and a greater thrill when you give it an actual "on-the-air" test! Join the fast-stepping gang who are proud to say, "Frequency is controlled with Meissner Precision-Built Equipment."

SIGNAL SPOTTER, complete with tubes and coils

No. 9-1044 Amateur Net \$22.45

SIGNAL SHIFTER, New 1941 Model, complete with ECO-XTAL selector switch, tubes and coils for one band

No. 9-1058 Amateur Net \$47.50

Write Today for New Amateur Catalog! Address Dept. AD-3

MT. CARMEL ILLINOIS

"PRECISION-BUILT PRODUCTS"



Application for Enrollment



In Amateur Radio Defense Association

★ ★ ★

I PATRIOTICALLY pledging my service to the radio defense of the United States of America, I hereby apply for enrollment in the *AMATEUR RADIO DEFENSE ASSOCIATION*. I agree to keep my radio equipment in good working order, ready to meet emergencies which may arise as a result of foreign aggression or other catastrophes. I agree to participate in such tests and training in preparedness to meet disaster to normal communication facilities as may be asked of me, provided that I am not then engaged in other work which I deem more essential to my personal welfare.

IN RETURN for my pledge of service, I am to receive a Certificate of Enrollment in the *AMATEUR RADIO DEFENSE ASSOCIATION* and am to be advised, by radio or otherwise, of the activities of said association, all without financial obligation on my part. It is mutually understood that the costs of printing and mailing the Certificate of Enrollment will be borne by the Publishers of the magazine "*Amateur Radio Defense*," who pledge themselves to publicize the Association activities, to print technical information which will improve the practical effectiveness of my equipment, and to seek greater recognition for the amateur radio operator as a means for aiding the national defense.

Pledged at....., on this.....
Town State

day of....., 194....

Witness

Enrollee.....

Full Name.....

Complete Address.....

Call Letters..... When Received.....

Age..... Race or Color.....

Code Copying Speed (1. in Handwriting..... (2) On Typewriter.....

Present or Past Employment in Commercial Radio.....

Army or Navy Service.....

Present Station Equipment: Power..... Operating Bands.....

C. W.?..... Phone?..... ECO?.....

Antenna Type..... Receiver Type.....

Measuring or Direction-Finding Equipment.....

Academic Education:.....

Mobile Equipment (auto, boat, plane).....

Public Speaking or Writing Ability.....

Nautical Instruments Owned.....

Membership in Other Communication Networks.....

Organization Experience and Willingness to Enroll Others.....

Other Special Qualifications.....

The above information is needed for guidance in classification for specialized services. Please write it in detail and mail it to

AMATEUR RADIO DEFENSE,
Monadnock Bldg., San Francisco.

A handsome Certificate of Enrollment will be mailed free to each licensed amateur radio operator who requests it.

Attention C-W Men!

SHIP OPERATORS - AMATEURS

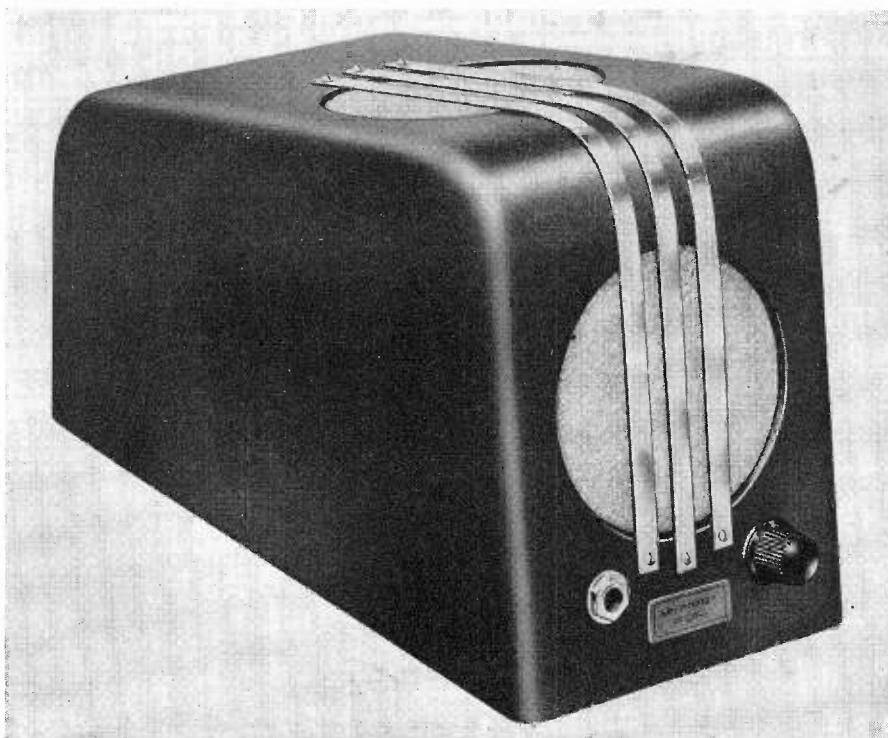

THIS IS THE NEW MEISSNER

"UNI-SIGNAL SELECTOR"

***Most Revolutionary Development in
Amateur Radio Since the "Rock-Crusher"
Was Discarded!***

Provides 100% readability—a combination electrical, mechanical and acoustical filter—this amazing device takes up where crystal selectivity leaves off—25-cycle band-width gives super selectivity to any receiver.

Connected in place of a regular speaker, it eliminates the interference without reducing the signal! Tube Hiss is completely gone—QRN, no longer troublesome! QRM is practically obsolete—cuts right through those South American phones!

Can not be used on phone reception—cut over switch on Selector connects standard speaker for phone reproduction. With Selector "ON," you never know the phones are on the air! Peaked at 1000 cycles, all signals come in with the same clear, ringing tone. Absence of back-ground noises makes the weakest signal quite readable.

Get yours now and begin at once to enjoy REAL C-W Reception! Only \$13.75 net—once this good news gets around, every C-W Ham will have one. See your Meissner Parts Jobber TODAY!!

ADDRESS DEPT. AD-3

 **Meissner** MT. CARMEL
ILLINOIS

"A FAMOUS NAME FOR TWO DECADES"

W2UK

U. S. high scorer in the 1937
and 1938 International DX
contests. The only station
ever to accomplish this feat.

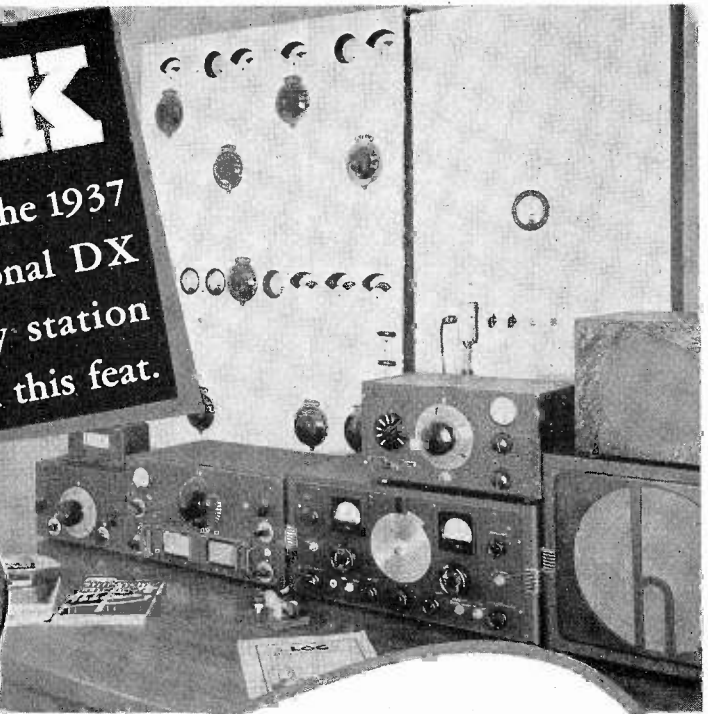

"The very nature of contest work
requires equipment that can stand
up under severe abuse, therefore
my station is 100% powered with
Eimac tubes in addition to KY21
rectifiers and Eimac Vacuum
Tank Condensers"

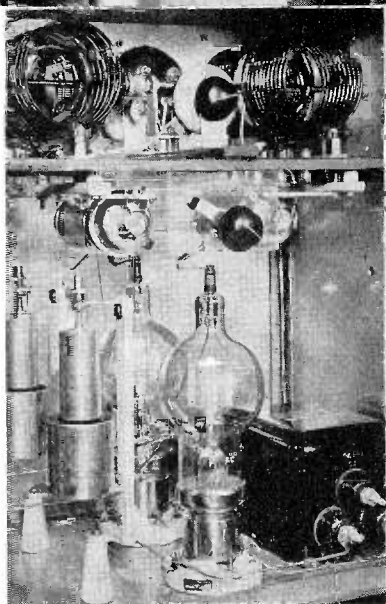

Ralph E. Thomas, owner and operator of Station W2UK uses a pair of Eimac 250TH's in the final and a pair of Eimac Vacuum Tank Condensers with band switching for two bands. A pair of 75T's used as the driver. Ralph's success in scoring highest two years in succession is remarkable—a good illustration of what can be accomplished by the intelligent use of good equipment of which Eimac tubes are a vital part.

Eimac 250TH's
and a pair of Eimac Vacuum
Tank Condensers make up
the final. Eimac KY21 tubes
for the rectifier and 75T's
for the driver.

Eimac TUBES

EITEL-McCULLOUGH, Inc. San Bruno, Calif.



The Editor's **CQ**

JOSEPH ADDISON, the famous English essayist, wrote: "Were a man's sorrows and disquietudes summed up at the end of his life, it would be found that he had suffered more from the apprehension of such evils as never happened to him than from the evils which had really be-

FEAR NOT

fallen him." This was a high-brow way of saying that a person should not risk missing half the joy of life by being afraid of what may not happen. Half our fears, unlike a good radio transmitter, are groundless.

This quotation covers the case of thousands of "fradio" amateurs who have lost a year of operating enjoyment because they feared a "blackout" of their stations in the event of war between the United States and the Axis Powers. Without stopping to reason the unlikelihood of a shutdown ruling, they voluntarily and unnecessarily relinquished the very privileges which they were afraid would be taken away from them!

Arguing from the precedent of the first World War, during which amateur radio was temporarily eclipsed, they figured that the same thing would happen again. They ignored the fact that precedent is a poor guide during a war where planes, and not cootie-infested trenches, are the first line of defense, and where mechanized offensive units have taken the place of infantry and cavalry. An adequate supply of gas and oil is today as vital to victory as is "food for the stomachs upon which an army travels." Whilst precedents based on old facts may suffice to win lawyer arguments and court decisions, they will not win a war waged with weapons conceived in the modern research laboratory.

Radio is among the more important of these new instrumentalities which played a minor part twenty-four years ago and which play a major role today. The radio operators of 1917 were few in number and used only spark transmitters and crystal receivers. The best professional equipment then had neither the range, reliability, nor portability of the average amateur station now. Amateur radio was not then essential to the national defense.

Today, on the other hand, it is most essential in functioning as a supplemental and standby service to commercial communication facilities. This fact was recognized by Chairman Fly of the Federal Communications Commission when he said (see Jan., 1941 A.R.D.) that the Commission "recognizes the new role of the amateur in helping to safeguard the national security. The amateur can rest confident that this Commission will not curtail his normal activities any more than the national security may justify."

This assurance, and the encouragement provided by the formation of the Amateur Radio Defense Association, are largely responsible for the fact that a great many old-timers are now getting new station licenses. Although they have lost their old call letters, and are far down in the alphabetical listings of the latest F.C.C. reports they still have their old skill and enthusiasm. They have finally awakened from the kind of coma which was induced by the scare-dope insidiously peddled in this country.

Nor is this awakening to the dawn of a better day confined solely to the United States. As we go to press, word comes that the radio hams in the British colony of Southern Rhodesia in South Africa have organized an "Auxiliary Defense Wireless Association" and are now back on the air, after having been frightened from it. Their example will undoubtedly be followed elsewhere as sane courage continues to supersede insane fear in the minds of men. Fear is one of the most potent weapons in the Nazi arsenal.

For further confirmation as to the unlikelihood of a curtailment of amateur privileges we quote from the report of an address by Commander John Reinartz of the United States Navy, as given elsewhere in these pages: "if the amateur makes himself needed during the emergency which is upon the country, there will be no total 'blackout' of amateur radio." Note the important proviso "if the amateur makes himself needed." ARDA members are quietly and effectively making themselves needed. They do not fear a shutdown of their stations. "The concessions of the weak are the concessions of fear."

TRX

FULL CRYSTAL
CONTROLLED
TRANSMITTER
AND RECEIVER

TECHNICAL DETAILS

10 watts output.

Full, press-to-talk
operation.

Speaker on front panel.
2 watts audio output.

Cast aluminum
construction.

Low battery drain.

Built-in efficient vibrator
supply.

Vibration and moisture-
proof construction.

Few controls.

Extremely rugged and
sturdy.

Dependable.

FOR BASE STATION or PORTABLE MOBILE SERVICE

THE absolute simplicity and lack of controls permits ready operation by non-technical personnel. The use of low frequency (1,500 to 5,000 kc range) greatly lessens the trouble experienced on UHF where signals may drop out when transmission is over irregular or hilly terrain. In addition to its suitability for mobile service, the TRX is excellent for base station work since the use of a 6 volt storage battery makes operation independent of power line failures.

TWO types of antennae are available. One, illustrated in the photograph, is a conventional automobile whip. The other, furnished on special order, is a highly efficient resonant type. Gain over the whip is approximately 6 DB. Conventional quarter wave antennas may also be used with the built-in loading network.

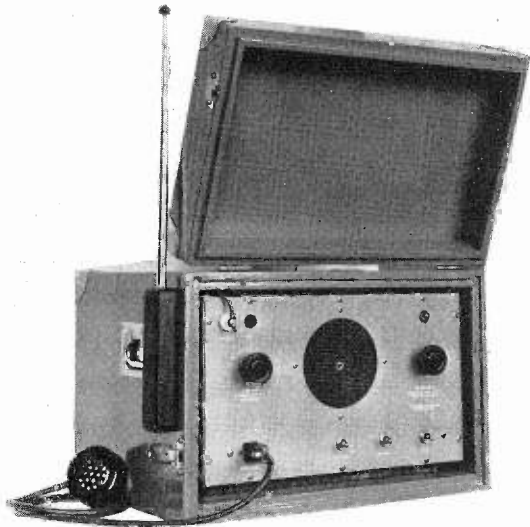

TECHNICAL RADIO INCORPORATED

TEGRAD

1083 MISSION ST., SAN FRANCISCO

CALIFORNIA

Now It Can Be Told



ACCTIONS speak louder than words. There has been a lot of idle talk in connection with the radio defense program, and many amateurs have wondered when—and where—the first decisive move would be made. It has just been made by Amateur Radio Defense Association.

To Mr. John P. Gruble, W7RT, Seventh Area Communication Officer for Amateur Radio Defense Association in Seattle, Washington, and to the many patriotic amateurs who so wholeheartedly cooperated with him—by deeds, and not by words—the radio fraternity owes a lasting debt of gratitude. For it was John P. Gruble who wrote the first chapter of the success story for our Association. The manner in which he and his associates conducted the emergency radio communication facilities during the recent Seattle black-out test is befitting the best in amateur radio—and in commercial communication to boot! Elsewhere in this issue is a complete account of a noteworthy achievement.

This is the time—and this is the place to talk about amateur radio's part in the defense program. When an emergency arises, men equal to the task can alone be depended upon to master the situation successfully. First information of the proposed black-out of Seattle reached us a few weeks ago. Area Communication Officer Gruble received a letter from Association offices, and briefly it contained the following instructions: "During the forthcoming black-out test in Seattle, Amateur Radio Defense Association will have an opportunity to prove its worth. This will be our first and foremost undertaking. Communicate with top-notch amateurs in your vicinity, making sure that only the most able men are approached. Prepare to establish communication on all of the amateur bands and make your plans known to Civic, State and Federal Officials. Contact Army and Naval radio executives in your area. Be prepared to cooperate fully with existing communication services. Your long years of radio and business leadership will enable you to perfect the plans for a totally-effective emergency communication system without minute instructions or details from Amateur Radio Defense Headquarters."

From the foregoing it is plain that no "drilling" or "coaching" or "prompting" was needed. Obviously, a man trained in radio does not need to be told what to do, how to

do it, or when to do it. Those who make up Amateur Radio Defense Association know the ropes. Emergencies are not new to them. It was our desire to prove to the amateur radio fraternity that a compact unit of *skilled* men can perform an infinitely greater service than a vast horde of recruits, and the results of the Seattle black-out test speak for themselves. Quickly, efficiently, and without blare of trumpets or crash of cymbals the Amateur Radio Defense group in the Pacific Northwest was banded together for *action*. Instructions were brief—each man told what was expected of him—and each man made good! There is no substitute for *experience* when an emergency arises. Amateur Radio Defense Association has rightfully earned its place in the defense program.

Previously it was rumored that our Association could hope for nothing more than a duplication of existing amateur radio facilities. Little did the rumor-mongers know that great numbers of skilled radio amateurs in the United States have chosen to associate themselves exclusively with Amateur Radio Defense Association. Our strength is in our ability to perform—not in mere numbers. The war in Europe has proved beyond a shadow of doubt that a small, compact and ultra-efficient force can outwit and gain mastery over a vastly greater force which lacks the ingenuity and ability of the former. And so it is with our Association. It will *act* when the need arises. Amateurs everywhere are "marking time," and ready to spring into action when the time is opportune. We won't bore you with a maze of inconsequential data, nor with useless tests, score-parties, or QRM on the air. We have a more serious job to perform. Our efforts are first being directed at the vulnerable points of the U.S.A.—and great quantities of letters are being exchanged with *experienced* amateurs everywhere, advising them what to do, in cooperation with our Association, when their services are required. This information is not for public consumption; it is in the hands of our leaders—and soon we will be able to relate other achievements as noteworthy as our Seattle black-out test.

If you can step up to a mike and tell others what to do . . . if you can *honestly* call yourself a *telegrapher* . . . if you are ready for action NOW, and without long training and drilling, we want YOU to join A.R.D.A.

Special Announcement

This issue of AMATEUR RADIO DEFENSE was purposely delayed for more than two weeks in order to bring you the first-hand account of amateur radio's part in the Seattle black-out test. Due to this delay, the April and May issues will be combined into one, in order to enable us to get back on a regular schedule.

Seattle Amateur Radio Defense Unit Takes Charge of Nation's First Black-Out Test



Area Communication Officer John P. Gruble and 20 Skilled Associates Prove Value of Amateur Facilities



Editor's Comment—

John P. Gruble, 7th Area Communication Officer, has helped write a new chapter in the history of amateur radio. Given 7 days' advanced notice to plan a complete Amateur Radio Defense system to handle the black-out test of Seattle, he devised and put into execution a plan of communication which functioned so successfully it has gained the admiration of all radio interests in the 7th Area. In order to get this already-delayed issue of A.R.D. to press, it was necessary to hold out a large group of maps, plans and detailed instructions which A.C.O. Gruble submitted to the participating amateur stations. The speed—the exactness and the comprehensive manner in which he laid the plans for coordinating all amateur efforts in his territory prove conclusively that Amateur Radio Defense Association's leadership is superb. In the next issue a follow-up article will be published, and you will be shown the entire "Plan of Action," with all of the block diagrams used to coordinate the amateur facilities. It is regrettable that this data could not be included in this issue; time could not be taken to make the draftings, engravings, etc. Stand-by for the next issue—and then you will learn how to correctly plan a defense unit of your own—and be ready to meet an emergency, just as it was met by the amateurs of Seattle.

amateur services into a common, effective unit of communication. John P. Gruble, 7th Area Communication Officer for Amateur Radio Defense Association, has accomplished this feat.

Before relating Mr. Gruble's account of the black-out test, the editors of A.R.D. desire to make it very plain that the American Legion's amateur radio efforts on the 160-meter band were of a distinct aid in correlating the emergency communications. On the other hand, the activities on all other bands—2½- to 80-meters—were handled by Seattle's amateur radio defenders. It is obvious that emergency traffic must be handled on *all bands*—'phone and c.w., without reservation, if the defense effort is to be all-out in character. Amateur Radio Defense Association has long known of the Legion's unexcelled ability to handle the 160-meter 'phone band, and it is truly inspiring to learn that the amateur radio defenders and Legionnaires cooperated so magnificently in making a success of the Seattle test.

Amateur Radio Defense Association had not fully completed its organization plans when the test was contemplated. Only through John P. Gruble's effort was it possible to instantly bring together a network of amateur stations on *all bands*—and were it not for his ability to make good in an

THIS is the story the amateurs have waited for. It is the answer to the oft-asked question: "*Why an Amateur Radio Defense Association?*" True, amateur radio has numerous emergency networks and many affiliated services. But it always remains for *one man—a leader*—to take it upon himself to bring all of the existing

emergency this story could not be written. The manner in which he planned the traffic routes so that the nation's capital could be informed of our progress from minute to minute, is an achievement second to none.

Amateurs in Seattle, and in other parts of the nation as well, have repeatedly "balked" when cooperation from radio amateur magazine publishers was to be part of any emergency program. The amateurs feel that this is "their work"—not the work of a magazine publisher. And rightfully so! In Seattle, for example, it was found that scores of amateurs had steadfastly *refused* to become associated with any emergency or defense radio undertaking sponsored by an amateur radio magazine publisher. The facts were made quite plain to us by Mr. Gruble. The amateurs feel that while they do the work—the magazines take the glory—and Mr. Amateur automatically becomes Public Sucker No. 1, whose principal contribution is one of a financial nature to swell the coffers of the publishing treasury. A solemn pledge is therefore made by the publishers of *Amateur Radio Defense* that they have absolutely no financial motive in mind—and that they would rather refund the vast subscription pool now on deposit in a local bank to all subscribers to this magazine if it will help strengthen our amateur radio defense program. To the Seattle amateurs, who brought this issue to a head—and who want to know where they stand—we make this statement: "You proved your worth. We want you to continue to cooperate to help strengthen the national defense. We do not want your money—but we need your support. You have shown the way for others to follow. Every person who is accepted for membership in Amateur Radio Defense Association can have our magazine free of cost.

A concerted attempt to sabotage the work of Amateur Radio Defense Association has been launched. It has been claimed that A.R.D. is published for financial reasons. There are 35,000 licensed radio amateurs in the United States who have not chosen to become affiliated with *any* national amateur radio organization—and A.R.D.A. came into the field to do something for this huge, unorganized majority—because it includes thousands of the top-notch amateur stations in the United States.

Now that our purpose has been re-stated, read what A.C.O. Gruble has to say about the Seattle black-out test—then decide for yourself whether or not A.R.D.A. has found its place in the defense program. And after you have read his brief account, which will be supplemented in our next issue, ask your-



Major Clarke, U. S. Army, Northwest Air District (left), was an interested spectator during Seattle's test blackout. John Gruble, W7RT (right), shown with one of the numerous 2½ meter rigs used by Seattle's amateur defense unit during the blackout.

self this question: "What would amateur radio have accomplished in Seattle were it *NOT* for this A.R.D.A. cooperation?"

We quote from Mr. Gruble's air-mail letter, received the day this magazine was put to press:



SEATTLE'S blackout was a fine success . . . there were a few places where lights were officially permitted (emergency defense orders at plants, such as Todd's Dry Docks, also one of the several of Boeing's Aircraft Plants) . . . but our amateur radio net detected, reported these lights as being on. Also, our net reported planes, and we got a good idea as to how many planes were apparently flying around . . . (we surmise about four) . . . also we learned from what point two airplanes took off from!! Had we wished, we could have, at any time, sent a message to any one of the 15 stations working in the net. We could have reached any part of the city by radio alone. NO land telephone was used. NO rehearsals were carried out. Everybody did his part well, and we did a fine job. The success of our work is due to no one fellow, but to all collectively.

Beginning at 10:40 P.M. (as per skeds outlined in the instructions), we began collecting messages regarding airplanes and lights from all Seattle RD stations. We collected a total of 15 messages from all parts of the city within about 20 minutes, and these messages came to us on 5 bands . . . we copied each message on paper; each message was complete, gave time, report of any planes, lights, etc., and was signed . . . all the messages were addressed to, and received at W7BL. W7BL used 3955kc, 1 kilowatt fone. For receiving W7BL's receiver was used, also my HQ120x and my 2½ meter rig. Between the two of us we worked cross-band on all the above bands, contacting the control stations for each band, gathering their traffic. At 11:10 P.M. (right after end of black-out which ended at 11) we sent a "general message," calling all amateur radio defense stations, asking them to immediately relay the message out of town. This message was copied by all our network members, and all of them

(Continued on next page)



John Gruble, W7RT, right, with 2½ meter rig, looks on at police radio receiving point in the County-City Bldg. Seated in center is Officer Baker of the Seattle Police Dept. To right (back turned) is Floyd Hatfield, W7ASV, who is in charge of KGPA and the radio department of the Seattle police. (Behind Officer, in background, grey hair, is Captain Prince, who has charge of Seattle Police Traffic Patrol.) (Note bulletin blackboard to right for instructions to various air raid officials)—This picture is in the City Council Chambers.



(except 2½ meters) immediately began to relay the message on to either prearranged skeds, or to first station worked out of town. We heard our stations relaying msgs to Oregon, Alaska, California, etc. W7VY had a schedule with WAR or W3CXL, the War Department at Washington, D. C.; W7GVH had a schedule

with Los Angeles; W7GYD had a schedule with several stations in Alaska. W7EK in Everett informed me that Everett gang got our message OK, and relayed it to California. Others did much relaying, but I haven't yet gotten a full report on where the messages went. All local men were asked to request a written verification from the stations copying the message, so it will be a little while before we get that dope.

We did two major things: (1) Showed that it is entirely possible to get a good, complete check of airplanes and light conditions for a city of this size with about 20 hams, and do it thoroughly within 20 minutes (could be done faster yet, too). (2) We showed that we had facilities to relay information out of town in a hurry. Also, of course, we co-ordinated the use of numerous bands with NO REHEARSALS.

Following are the locations of the stations taking part: W7HCU/7 used 2½ meters atop Queen Anne Hill . . . W7HQR/7 used 2½ meters on top of West Seattle Hill . . . W7IEK/7 (assisted by W7IAB) used 2½ meters from the top of the Harborview Hospital . . . W7RT/7 was located at W7BL, master control station . . . W7GUV/7 was located (2½) at the Central School 7th Avenue and Madison Street, where also is located the N.Y.A. ham station W7HYT . . . W7GUV/7 used rig donated by W7HCS . . . W7AUK operated the 75 meter fone rig at W7HYT. . . . All other stations worked from home locations. (During real emergencies home stations would get a gas plant each.)

The following stations were active on 112mc., 10 meters, 40 meters, 80 meter CW, 75 meter 'phone, and QRX on 160 meters. Of the stations given on the schedule charts, the following reported, and sent in a message, and also copied our general message in return, which most of them relayed to outside points (these stations were on the air, and did their part 100 per cent, making it a success for the Seattle ARD work):

On 2½: W7HCU/7, W7HQR/7, W7IEK/7, W7EUI, W7GUV/7, W7RT/7. (W7IAB helped at W7IEK/7—W7HCS furnished rig and helped at W7GUV/7).

On 10 meter fone: W7KO.
On 40 CW: W7FRU, W7VY, W7CE, W7GTD.
On 80 CW: W7GVH.

On 75 fone: W7BL, W7EKA, W7GYD, W7GMV (QRX), W7DDO, W7HYT. (W7AUK operated at W7HYT, as did W7GUV, W7HCS.) (W7RY, Seattle, was also QRX and relayed our general message upon copying it.) (W7RT at W7BL's, helping collect traffic.)

(Continued on page 24)



Left, Chester Beck, W7IAB, who helped W7IEK, Bob Engle, right, shown fighting the wind and cold high atop the Harborview Hospital during the test blackout. They were on one of the highest points in the city, and acted as the 2½ meter net control station. (It was chilly up there!) They successfully worked all 5 stations on their network, and collected messages, relayed them in total to W7BL via W7RT/7. Harborview Hospital is in mid-Seattle, and is on a hill as well.



N. R. Farbman, W6SEM, Staff Photographer for "Amateur Radio Defense," takes his amateur radio as seriously as his business of photography. Here you see him at his 500-watt 'phone-c.w. transmitter, described in the text. He has two receivers, a Hallicrafters SX-17 and an SX-24. To the far right, on the shelf, is a small stand-by 'phone transmitter. Other equipment includes an E.C.O., RME Pre-selector, Phone-CW Monitor, Universal Antenna Coupler Unit, three loudspeakers and miscellaneous test gear. W6SEM devotes most of his attention to the 10-meter band. All of the transmitter equipment was built by himself.

High Power RK-65 Transmitter

By N. R. Farbman, W6SEM

IN THE inaugural issue of A.R.D. mention was made that the description of station W6SEM would appear soon in these pages. My transmitter has just recently been completed, and it was deemed advisable to conduct an extensive series of tests on the

air before the technical details were disclosed.

It has been my good fortune to have at my disposal a small but complete machine shop, and any amateur who has labored with metal chasses and heavy power supply com-

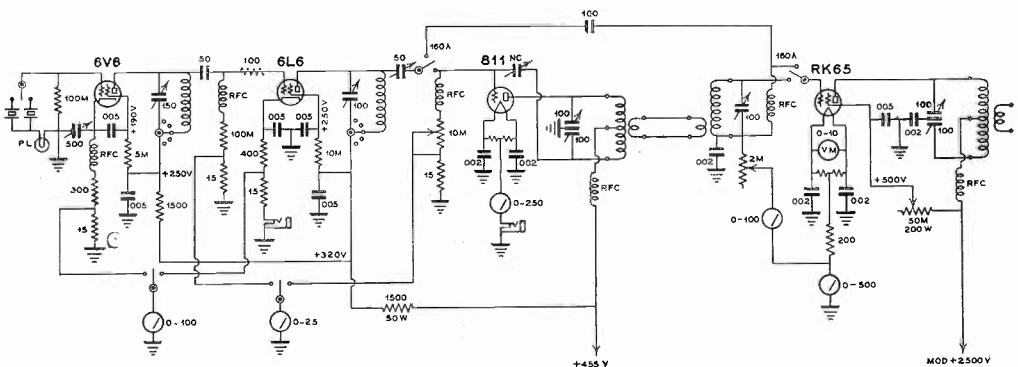

Complete Circuit Diagram of W6SEM's Exciter and Final.

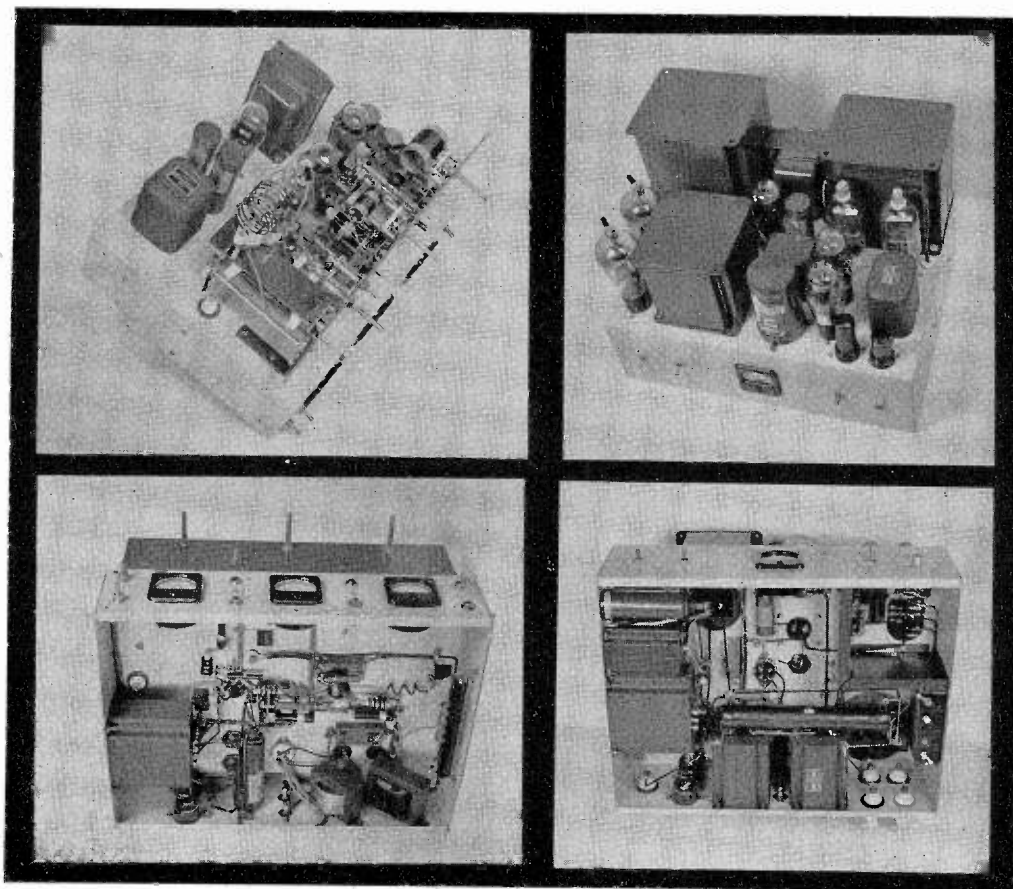

Upper Left: Looking into the exciter unit, which includes Jones Harmonic Oscillator, 6L6 buffer-doubler, TZ-40 buffer-doubler, and power supply for the complete exciter. Coil-switching is used for the oscillator and first buffer-doubler stage and plug-in coils for the last buffer-doubler.

Lower Left: Under-chassis view of the exciter unit, showing neat wiring and symmetrical arrangement of parts.

Upper Right: Complete TZ-40 modulator and speech amplifier for operation with crystal microphone. The power supply is an integral part of the unit, including the high voltage modulator source.

Lower Right: Under-chassis photograph of speech and modulator deck. Many components are crowded into a comparatively small space, but the chassis is 4-in. deep and room was found for all equipment. The speech channel is well shielded in a metal housing, seen at the upper right of the under-chassis view. The cover has been removed in order to show details of this shielded compartment.

ponents knows what it means to have on hand a set of good tools, a drill-press, lathe, grinder, polisher, and paint-spraying equipment. The photographs show the individual decks of the transmitter, from power supply to final r-f amplifier. Each deck was sprayed with several coats of Egyptian Lacquer, which dries almost instantly, and various shades of gray were used to give the finished product a pleasing appearance. Even the

transformers and chokes were sprayed with dark gray lacquer in order to remove the high-lights and thereby secure better photographs of the equipment for magazine illustration. I am a news photographer by profession, and it has been my good fortune to be appointed official staff photographer for *A.R.D.* In this latter assignment I have come into contact with all of the technical staff of the magazine, and before describing

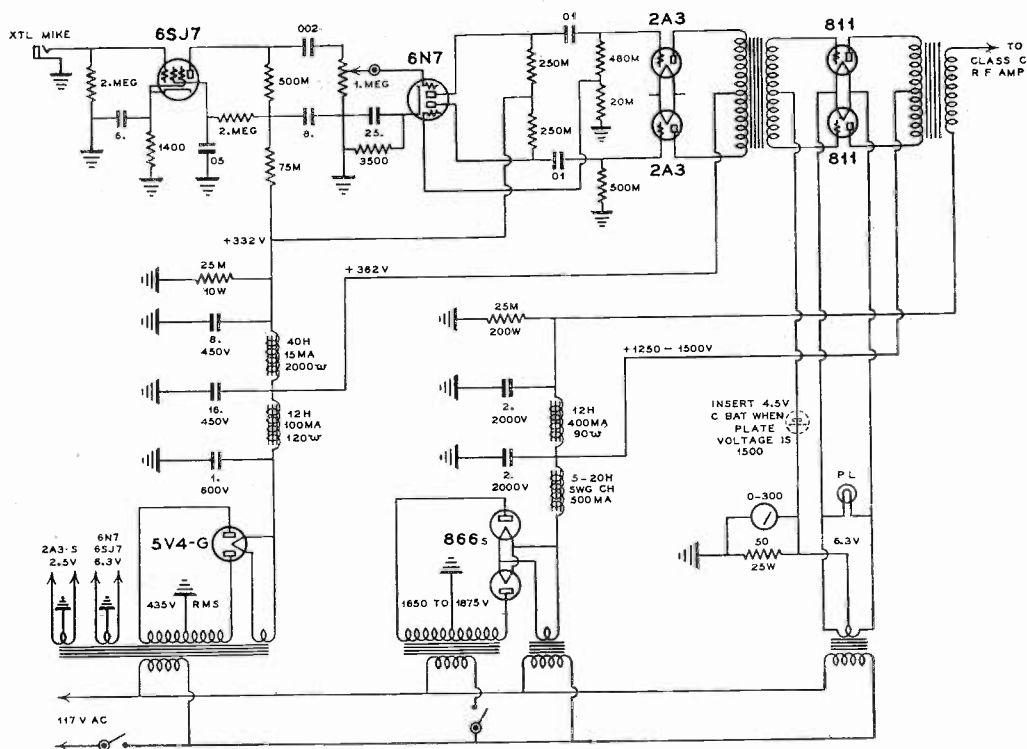

Complete schematic wiring diagram of speech amplifier and modulator with RCA-811s in final stage. This is the circuit as used by W6SEM, although TZ-40s or RCA-811s can be used without circuit modifications. The modulation transformer is a Kenyon unit, as is the high-voltage plate transformer, also the filter choke.

my transmitter I want to take "time out" to tell you a few things about the men who publish *A.R.D.* I came into amateur radio through wild enthusiasm displayed by Jack Rice, a fellow photographer on a contemporary San Francisco newspaper. He purchased the first cathode-modulated transmitter built. It was designed by Frank C. Jones, built by Clayton F. Bane and F. D. Wells of Technical Radio, and exhibited at the amateur radio convention year before last. I wanted to meet the men who designed and built that transmitter, so down to the Tecrad plant I roamed. There I met Clayton F. Bane, W6WB, and I told him I wanted to buy a 1-kw transmitter. "Have you got any money—or are you a radio amateur?" asked Bane. "I am with the San Francisco *Examiner*," I replied—and believing I was the owner of the paper, rather than a news photographer, he promptly quoted me a price in six figures for the transmitter I wanted to buy. "You see," said Bane, "when we sell a transmitter to an amateur, he expects us to keep it in operation for the rest of his

life, so we charge a good price at the start." Trying to get on the air with 1-kw seemed quite expensive, so I asked the old maestro how much he would charge to merely *tell* me how to build a big transmitter. "Oh, well, in that case, we will charge twice as much," said Bane, "because it would take us twice as long to tell you how to build it as it would take to manufacture it in our plant."

"Isn't there anything you can do to help an amateur design a big rig?" I asked. "Go into the lab and ask for F. D. Wells. If you can't locate him, just while CQ-10 meters, and you'll hear someone let out a yelp like a prospector who struck gold—that man will be Wells," said Bane. And sure enough it was. He answered my first CQ so vigorously you'd think I was a long-lost station. Introducing myself, I unfolded my 1-kw problem to him. Then he went into a huddle with Bane. Coming out of the huddle he told me they had an answer to my problem—an answer in three simple words. I'd heard that one before. "No, no, no," said Wells, "that's

not what our three words of advice were meant to be—so here they are—*SEE FRANK JONES.*” They wrote his address on a card, and escorted me to the front door, telling me en-route that Frank would be glad to accommodate me—that he gets out of bed at midnight to answer the telephone when some ham calls up to inquire about a cure for high-resistance joints and cold soldering irons.

Down to the *A.R.D.* offices I went. Nobody paid any attention to me as I walked in. One man was manipulating a slide-rule so fast I thought he was playing a trombone. “Must be Jones,” I surmised. Another was bent over a drafting board, mumbling to himself as he studied a circuit some reader had sent in the mails. “Must be Clyde Anderson,” I next surmised. Still nobody paid any attention to me. Then I spotted the advertising manager, and I knew I guessed right because just then he reached for the telephone and called the printer to give instructions for adding 32 pages to this issue of *A.R.D.* “Hold 16 pages in four colors for an *R.C.A.* tube advertisement,” he barked into the ‘phone, “and another 16 pages for the *National Company.*” (PS—see advertising section of this issue.)

I was about ready to give up, when suddenly I spotted a stack of photographs on the desk of the man with the slide-rule. “My, what *beautiful* photographs, Mr. Jones—and will you please give me a circuit for a 1-kw transmitter?” He had a twinkle in his eye. I knew I was making progress, at last “What will I modulate it with?” I asked. “Modulate WHAT?” queried Jones. “Oh, the transmitter you are designing for me,” I replied, as I almost went into self-oscillation. “Have you bought your parts?” he asked. “I have a pair of *Eimac* 100THs,” I said. The advertising manager jumped out of his chair and shouted: “We can’t give out circuits this month for *Eimac* tubes because we already have an advertising contract from them, and as soon as we get an advertisement from a tube manufacturer we stop showing his tubes in the magazine—until he catches up with us and warns us that he will cancel his advertising unless we get busy and show more of his tubes in our diagrams. The *Eimac* people haven’t telephoned this month, so it looks like we are safe for a while. Go out and buy yourself a big *Raytheon* screen-grid tube and I’ll put in a good word with Mr. Jones and see that you get your diagram. We’ll wire *Raytheon* that we are showing their tube in this issue and we’ll hound them for an ad.” Then he reached into his file and handed me an *R.C.A.* Transmitter Guide. “Here—take this manual home with you; it costs 15 cents if you buy it in a

radio store, but we get dozens of free copies from the *R.C.A.* because when they asked for our list of technical staff members we sent them dozens of different names, and we get all kinds of literature free. There’s a circuit in the manual that shows a swell modulator with a pair of *RCA-811s*. Go home and build it, and if it works as good as the *RCA* says it does, we’ll charge them double for their advertising.” “But I already have a pair of *Taylor* TZ-40 zero-bias tubes,” and you haven’t any advertising from *R.C.A.*,” I replied. “Well, said the advertising manager, “put the *Taylor* tubes in the modulator when you take a photograph of it, and the engineering draftsman will show *RCA-811s* in the circuit diagram—and we’ll get ads from *Taylor* and *RCA* both.”

“But what will I do with the pair of big *Eimac* tubes I already have?” I asked. “Oh, that’s easily taken care of,” he said, “after you build your smaller modulator you can use it as a driver for the big *Eimac* tubes, and in that way we’ll get an extra story for a future issue of the magazine and ask the *Eimac* people to double their advertising space.

I learned a lot of the innermost success secrets for publishing amateur radio magazines, but I still hadn’t been given the circuit for my 1-kw transmitter. Trying to get on the right side of everybody in the office, I walked over to Clyde Anderson’s drafting department and complimented him on his work. “It takes a lot of imagination to make these diagrams,” said Andy. “You should see some of the stuff we get in the mails. All kinds of screwy sketches—some showing nothing more than an antenna and a ground connection, and they expect me to fill-in the rest of the stuff and make a circuit that works. I also have another very important assignment; I erase from our diagrams the names of all manufacturers who do not advertise in our magazine, and I put in the names of those who do.”

“Well, well,” I remarked, “can you do that—can you take out one manufacturer’s tube and put a different make of tube in the diagram and still expect the transmitter to work successfully?” “Sure you can,” said Andy, “so long as they don’t forget to put the elements in the tube.” Then he whispered into my ear that he had just changed a lot of diagrams so that *H-K Gammatrons* could be shown, in order to sell more advertising space to *H & K*. “Suppose you make a diagram for a transmitter and the thing doesn’t work after it is built; what do you do then?” “Oh,” said Andy, “we simply prepare a new drafting and show tubes made by those who don’t advertise in our magazine.”

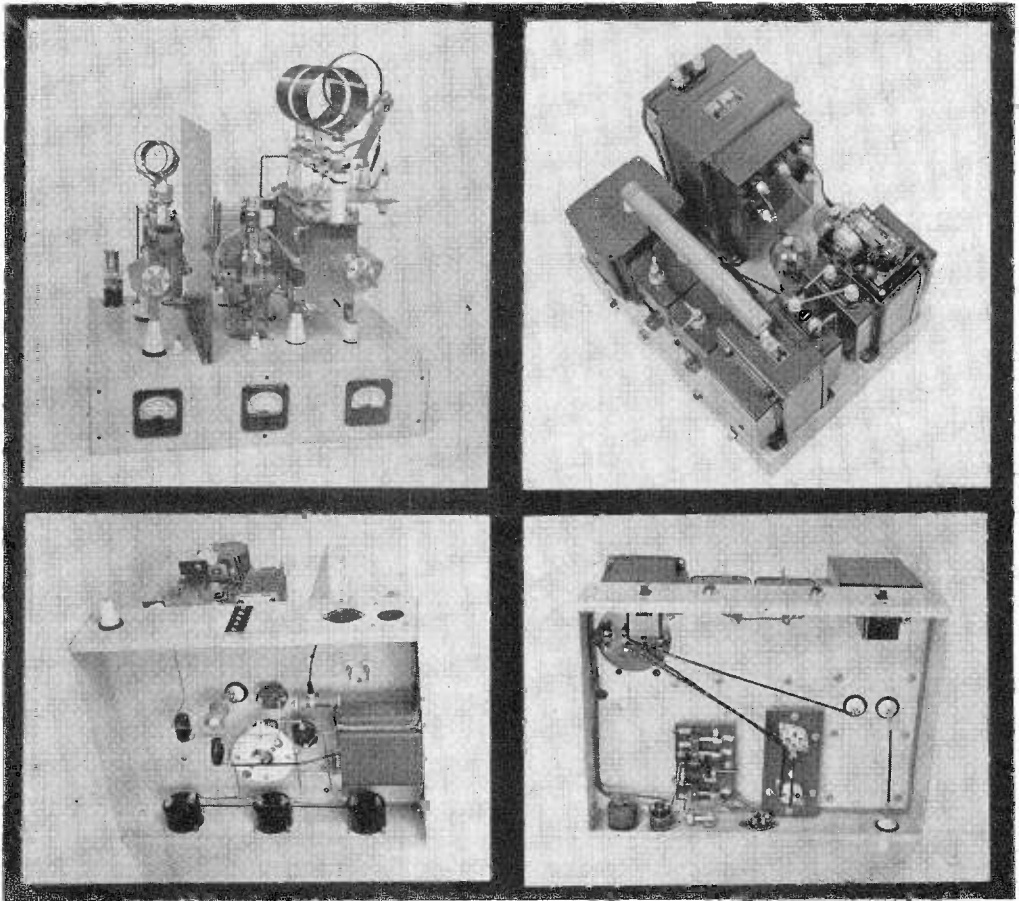

The Raytheon RK-65 screen-grid tube is shown in the final r-f amplifier, upper left illustration. For 160-meter operation a Cardwell padder tank is shunted across the main Cardwell tuning condenser. The plate inductance is a B & W unit with adjustable link. Grid and plate circuits are isolated with a large aluminum baffle, clearly seen in the picture. The lower left illustration is a bottom view of the final r-f stage. Filament transformer for the RK-65 and small components are clearly shown. The power supply for the final is illustrated in the upper right photo. It consists of a heavy-duty Thordarson transformer and two filter chokes, one of the swinging variety, the other a smoothing choke. Two 4-mfd. Aerovox oil-filled condensers, a pair of 866 rectifiers, heavy-duty Ohmite bleeder resistor and filament transformer for the rectifiers complete the high-voltage power deck. A realy for breaking the high-voltage source is seen atop one of the filter chokes. The illustration in the lower right portion of the group photo shows the under-side of the high-voltage power deck. Note the neat wiring arrangement.

Just then a man tapped me on the shoulder; he was Frank C. Jones. "Get away from those kibitzers," he said, "they're handing you an awful line of nonsense. They were only trying to kill time while I sketched a diagram for a 500-watt transmitter for you. Here it is. I would not advise you to go to a full kw; build this transmitter and follow the circuit constants precisely as I have

shown. *The circuit is self-explanatory.*"

So I built the transmitter. The photographs show the various chasses and also the front view of the completed job. The set has given exceptional performance on 10 meters.

I wanted to tell you the technical details of the transmitter, but Frank Jones told me they were self-explanatory . . . so there isn't anything I can add.



All-Band 'Phone - C. W. Portable Transmitter and Receiver

Here is the technical and general description of a complete low-power transmitter-receiver, for 'phone-c.w., 5- to 160-meters, self-contained except for the power supply. The author tells you some interesting facts about his equipment in the manuscript herewith.

By Robert D. Browne, W6AHH

MORE than a year ago when the war clouds first darkened the skies, it was my desire to have a complete, compact transmitter-receiver, suitable for operation on all bands from 160 meters to 10, capable of operating from a Vibrapack or a conventional 110-volt a.c. power supply, and sufficiently light in weight to make it a truly portable job. I wanted something I could readily transport from place to place, and on a moment's notice. Furthermore, the set should be able to operate with almost any kind of an antenna and for this reason a simple antenna coupling system with loading coil was made part of the rig. This portable equipment supplements my large c.w.-'phone rack-and-panel job at the home station, and once I knew that this arrangement would be useful for defense in time of emergency, I volunteered my equipment and my services to Amateur Radio Defense Association.

The receiver-transmitter which I will describe required more than a year of my spare time to build. I am a foreman in an electrical machine shop and I wanted my amateur equipment to be built as ruggedly and as neatly as the work we produce in our plant. So I didn't rush the job. When I decided to build this transmitter-receiver, an amateur buddy of mine, Dr. A. H. Havens, W6DEK, likewise was interested in building a small set—and so two of these jobs were built at the same time, exact duplicates, and many pleasant hours were devoted to the work by the both of us. When completed, the two jobs looked so much alike that we could not tell them apart, and I still don't know whether "Doc" is using my set, or if I am using his.

Before describing the sets, I would like to make mention of some of the rather unusual contacts that have been made. The sets were originally designed to give peak

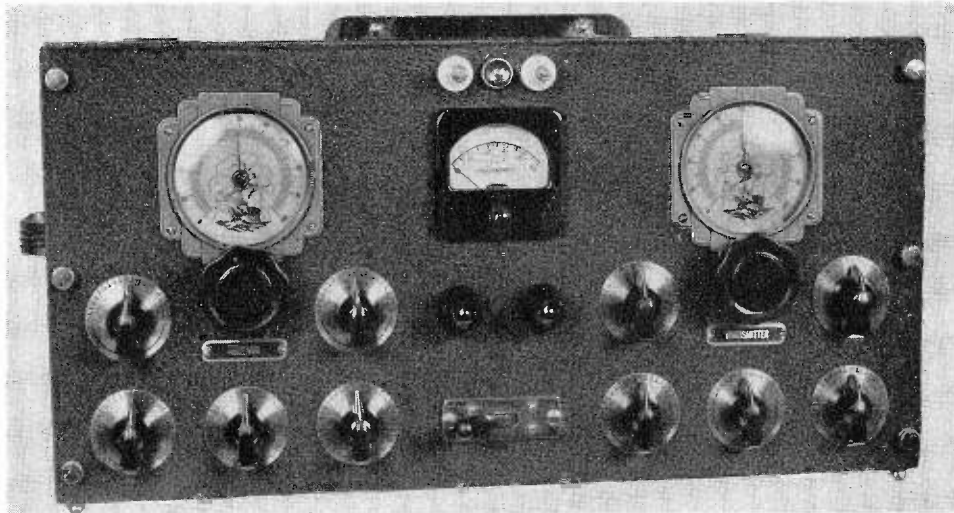

Front view of the complete receiver-transmitter in black cracked metal case. Note the symmetrical arrangement of the numerous controls and the splendid mechanical workmanship.

performance on 5-meters, the "hard" band, and care was taken to get the last fraction of a watt into the antenna in the UHF region. The results were pleasing. Contact was made on 5-meters with another amateur in Great Falls, Montana, more than 1,000 miles from my location. Considering that the final r-f amplifier for 5-meters operated with an 807, this can be considered fairly good DX. On the lower frequency bands it has been quite simple to contact amateurs in the Eastern states regularly on c-w, and numerous QSOs on 'phone have been had with 160- and 10-meter stations 1,000 miles away. For 5-meter contacts a 5-meter vertical doublet antenna was used.

Technical Description

THIS 5- to 160-meter, 'phone-c-w-transmitter-receiver is built into a metal cabinet only 8-in. x 8-in. x 16-in. The power unit is built upon a separate chassis. One power supply, delivering 400 volts at 250-ma., is ample for the entire set. The receiver and transmitter units are mounted on the common chassis, with the loud speaker inverted so that the top of the cabinet forms a baffle, as the illustration shows. Plug-in coils are used in all circuits, both for transmit and receive, and 5 coils are needed for each band of operation.

The crystal oscillator is a standard Jones twin-triode oscillator-doubler with a 6N7 operating at approximately 300 volts on the plate. The second section of the tube func-

tions in the doubler circuit, as the schematic diagram shows. From this circuit it is also seen how straight-through operation on the fundamental frequency is accomplished.

The oscillator is capacitively-coupled to the 807 final r-f amplifier and change-over from c.w. to 'phone operation is accomplished by the switching arrangement shown. The oscillator-doubler requires two plug-in coils, and these are interchangeable so that one set of coils can be made to cover two bands of operation. For example, with an 80-meter crystal and an 80-meter tank coil the oscillator the output is obviously on 80 meters, but this same 80-meter coil can be plugged-into the doubler stage when a 160-meter coil is used for the oscillator. This makes it unnecessary to wind duplicate sets of coils.

The 807 final r-f amplifier operates with 400 volts on the plate at approximately 70-ma. There is only one meter in the circuit; a 0-100-ma. d.c. milliammeter is permanently connected into the plate circuit of the final r-f stage.

The antenna coupler includes a tapped loading coil, as shown in the circuit details, and this coil is used for all bands of operation, except for 5 meters; in this arrangement a rotary switch with 11 contact points is connected so that the loading coil does not function on 5 meters. A lamp indicator is connected into the antenna lead, but lamps of various sizes are used for the several bands of operation. For 160 meters, a 2.5-volt 500-ma. lamp is used, and for 80, 40, 20 and

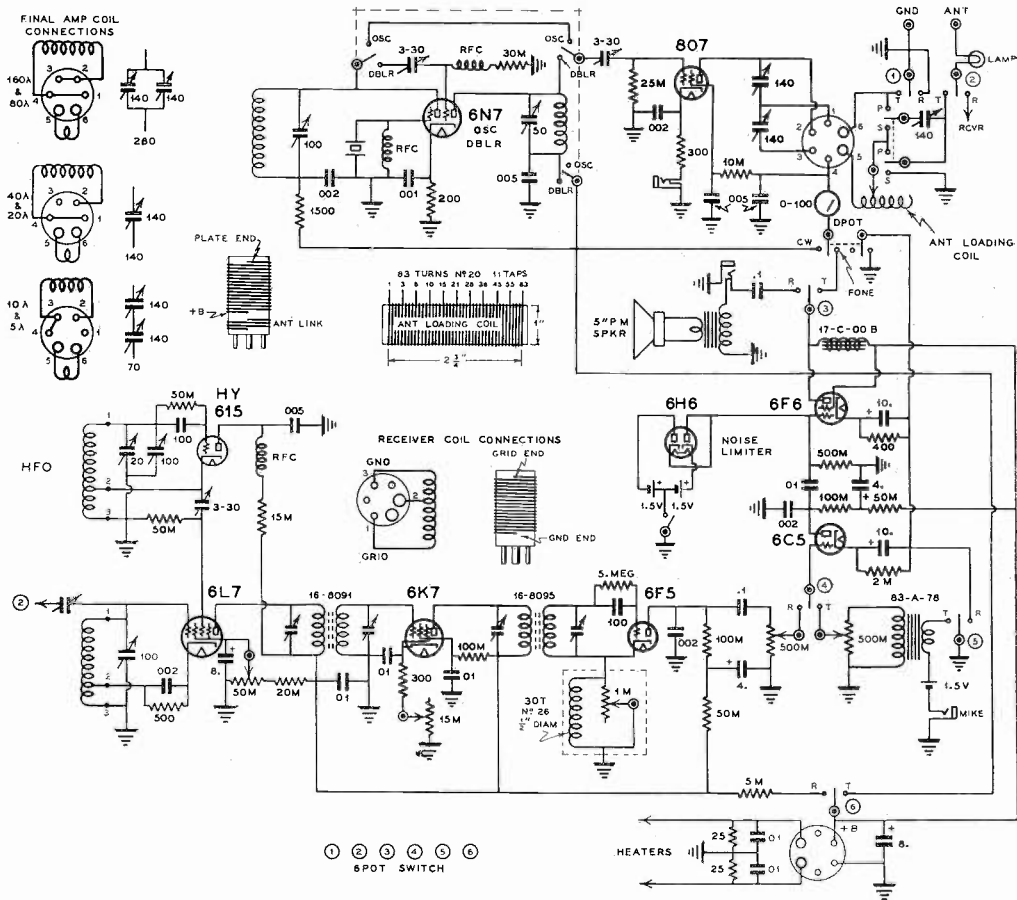

Transmitter Coil Data			Receiver Coil Data		
OSCILLATOR & DOUBLER	FINAL	ANT LINK	λ	1st DET & CATH. TAP	H.F. OSC. & CATH. TAP
72 turns № 22 1 1/8" space	42 turns № 18 1 3/8" space	10T № 20	160	72 turns № 24 1 1/2" space	37 turns № 24 13/16" space
35 turns № 20 1 3/8" space	26 turns № 18 1 3/8" space	7T № 20	80	35 turns № 20 1 3/8" space	26 turns № 20 1 3/8" space
18 turns № 20 1 3/8" space	15 turns № 18 1 3/8" space	4T № 20	40	20 turns № 20 1 3/8" space	16 turns № 20 1 3/8" space
10 turns № 18 1 3/8" space	9 turns № 18 1 3/8" space	3T № 20	20	12 turns № 18 1 3/8" space	8 turns № 18 1 3/8" space
3 1/2 turns № 18 1 3/8" space	6 turns № 18 1 3/8" space	2T № 20	10	8 turns № 18 1 3/8" space	4 turns № 18 1 3/8" space
4 turns № 14 1/2" diam. spaced 1/2" between turns	5 turns № 14 1/2" diam. spaced 1/2" between turns	2T № 20	5	4 turns № 14 1/2" diam. spaced 1/2" between turns	3 turns № 14 1/2" diam. spaced 1/2" between turns

5A COILS AIR CORE-ALL OTHERS WOUND ON BUD 1/4" DIAM FORMS. ENAMELED WIRE USED THROUGHOUT.

Complete Wiring Diagram and Coil Table for All-Band Portable Phone-C.W. Transmitter-Receiver

10 meters the lamp is of the 6-to-8-volt, 250-ma. size.

Keying for c.w. is accomplished in the cathode circuit of the final r-f amplifier, but the circuit can be modified to key the oscillator for break-in operation by means of convention circuit changes.

Self-oscillation of a tube of the 807 type is quite common in small, compact trans-

mitters. In this transmitter the 807 is not shielded. All tendency for self-excited oscillation was overcome by inserting a variable 3-30μmf. trimmer in the grid lead of the 807. Another trimmer of the same variety in the oscillator-doubler circuit was found necessary, and by careful adjustment of this small condenser it was possible to secure ample output from the oscillator-

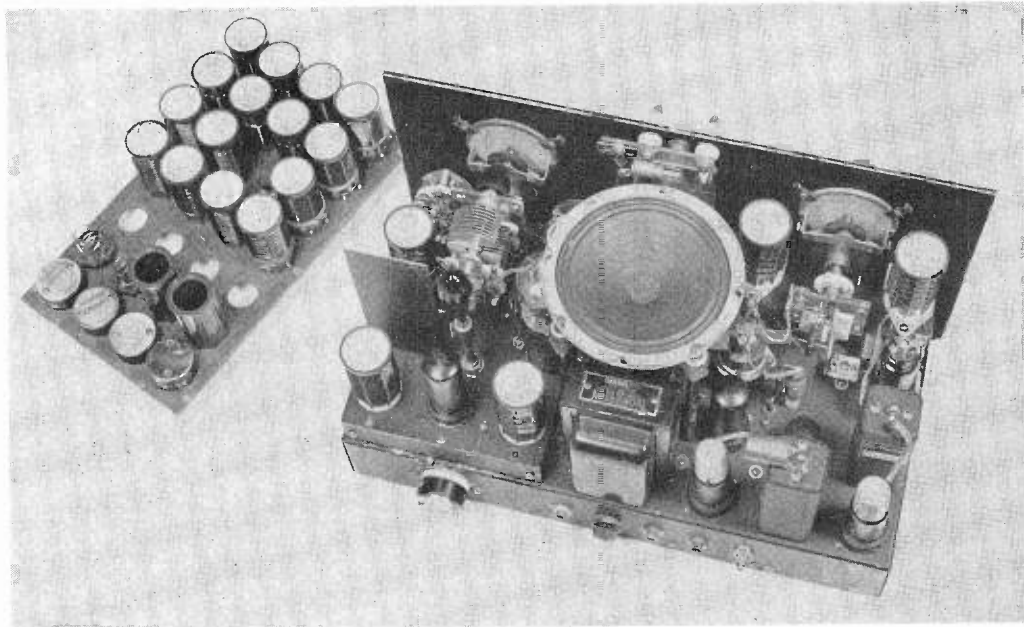

Looking into the complete set, the loudspeaker is seen mounted so that the top of the cabinet forms the speaker baffle. Coil rack and coils are also illustrated. The coil-winding data is given complete in the Table under the large schematic wiring diagram.

doubler to drive the 807 successfully for even the highest frequency band of operation. It was also necessary to insert an r-f choke in the grid circuit of the doubler section of the oscillator in order to secure maximum output for upward modulation in the 5- and 10-meter bands.

The speech channel begins with a 6C5 and a type F-1 carbon microphone. A 6F6 serves as a modulator, and there is ample modulation for operation in any band. This same 6F6 modulator functions as the final audio stage of the receiver circuit, with 275 volts on the plate for receiving, and 400 volts for transmitting. Although this latter value of voltage is rather high for a 6F6, the tube has been in service for 6 months and continues to function.

The receiver is the standard Jones "Super-Gainer" circuit, described previously in these pages. This simple superheterodyne circuit functions especially well on 5 meters, although an HY-615 should be used in the HFO, rather than the conventional 6C5. The HY-615 is responsible for the success of the receiver circuit on 5 meters. All tube shields in the receiver portion of the set are grounded. Hum in the 6F5 second detector grid circuit was completely eliminated by shielding the grid condenser and leak in this stage. The I.F. transformers are of the *Meissner* type, the catalog num-

ber being indicated in the circuit drafting. The cathode coil is shielded with a small, round metal can, such as the top of a tube shield.

Coils for all transmitter and receiver stages are wound on $\frac{1}{4}$ -in diameter plug-in forms, and 24 separate coils must be wound for all bands of operation. The 5-meter coils are "air-wound" and supported on cut-down plug-in coil forms. The antenna loading coil is wound on a 1-inch Isolantite form; the winding is $2\frac{3}{4}$ -in. long, the form proper is $3\frac{1}{3}$ -in. long. No. 20 enameled wire is used to wind the antenna coil. All of the plug-in coils are likewise wound with enameled wire.

Miscellaneous Details

The variable condenser shown alongside the encircled numeral "2" in the lower far left portion of the schematic wiring diagram is a 3-30 μ f. mica trimmer in the antenna circuit of the receiver.

The F-1 microphone operates successfully with 1.5 volts and a small flashlight cell will give long service.

Socket connections for the final r-f amplifier are *top* views. The circuit diagram does not indicate plug-in coils for the oscillator-doubler plate circuits, for reasons of

(Continued on page 38)

SEATTLE BLACK-OUT TEST

(Continued from Page 14)

On 160 fone: (Standing by for possible QSP) W7FVC, W7HWY, W7EUI.

Eight-page instructions were mimeographed by myself, and were mailed out to the members March 4 (I worked until 3.30 A.M.) . . . In addition to the stations mentioned on the schedule charts, copies were sent to W7EK, W7EGE, W7AKP (all in Everett, Washington) . . . also to W7HMA in Bremerton, Washington (who was in the American Legion net on 1905kc, and also on 2½ trying to work Seattle, but we were unsuccessful in making QSO) . . . Also to W7HZG in Pomeroy, Washington . . . W7EUI in Kirkland, Washington (across Lake Washington from Seattle). There is a great deal of interest on 2½ meters

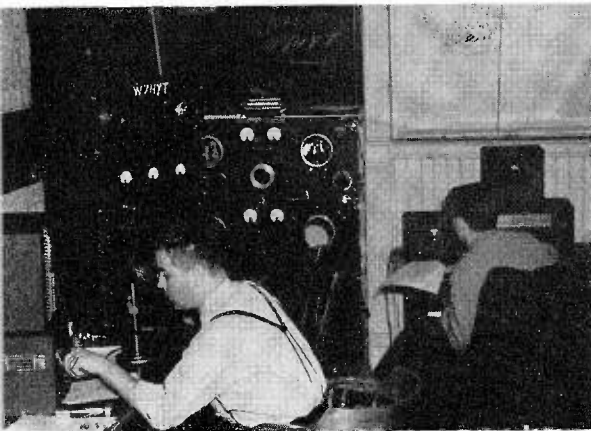

W7AUK, Herb Auckland, operates the layout at W7HYT, the Seattle N.Y.A. Radio Club station. The 125 watt 75 meter 'phone rig was used during the blackout, although other transmitters were available. From the same building roof, W7GUV and W7HCS used a 2½ meter rig during the test. W7HYT was net control station for 75 meter 'phones.



Some of Seattle's amateur radio defense members get together with their 2½ meter rigs at the west approach to the Lake Washington Pontoon Bridge. Left to right: Bill Boughten, W7HCU; George Coleman, W7FVC; John Gruble, W7RT; Bob Engle, W7IEK; George Minich, W7HCS; Bob Hanna, W7HQR. All of these men participated during the test blackout. The 2½ meter work was but a part of the extensive network arrangement used during the test.

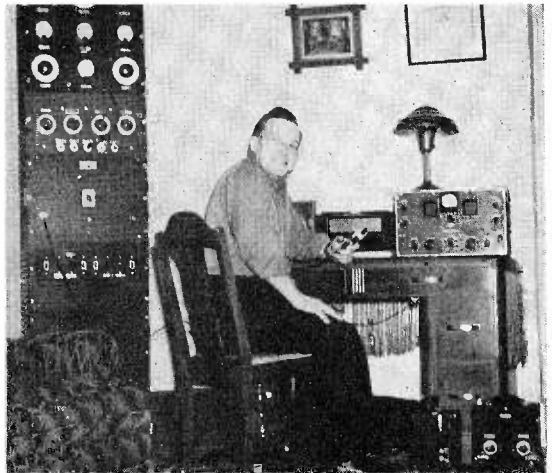

Art Dailey, W7BL, master control station for the Seattle amateur defense network. Rig to left is 1 KW 'phone on 3955kc. Several receivers were used. Note portable gear on floor lower right, which includes a transmitter for emergency operation on any band from 2½ to 160 meters. Art has been in ham radio and in broadcast work for over 20 years, is an ardent amateur and enjoys emergency work. Has much mobile equipment.

here now. . . I sure started something when I ordered a transceiver together with W7HCU . . . there are now 8 to 10 rigs here, and more coming on every day (Before that you couldn't find more than two or three in town. . .) By the way, last Thursday, March 6, W7FVC (George Coleman, who is a member of our local defense unit) went up in an airplane owned by a friend of his; he took up a 2½ meter rig, and W7HQR, W7HCU, W7HCS, and myself got on with our 2½ meter rigs. We kept good QSO with the plane as far out as Bremerton (think about 20 to 30 miles DX) and had a lot of fun talking to W7FVC, and listening to him describe the scenery at 4,000 to 7,000 feet up, also how he felt when the plane ran into fog and clouds, and how he jumped when another airplane passed by them in a cloud bank (W7FVC's plane was going 100 M.P.H. and the other ship passed them as if they were standing still, according to W7FVC).

W7EK in Everett, who has been working me each Sunday at 1 P.M. on 7156kc., and who is very interested in ARD work, will soon leave for a trip to Detroit. He will be on again after a few weeks off the air. W7EGE and W7AKP are the other two Everett hams who have been QSOing me, and who are very interested in emergency work.

W7HVT in Usk, Washington (near Spokane) applied for membership in ARD, and will be on sked as soon as he can get a crystal on 7156kc.

Well, after a little rest, will begin where we left off . . . we in Seattle will hold another meeting soon, decide what policies we'll follow, cook up another good test for ourselves, and keep going. Be sure and keep me posted on anything I should know and do so as soon as possible after getting the dope, as time is important. Will tell you about our next meeting after we hold it.

W7RT.

By the way, there is now some talk about staging a blackout of the whole Puget Sound area . . . if this comes to pass, watch a real A.R.D.A. layout go to work!



W9NFD Joins Amateur Radio Defense Association



AMATEUR Radio Defense Association takes pride in publishing the photograph of Mr. H. W. Lingenfelter, W9NFD, 4845 Chicago Ave., Minneapolis, Minnesota, for he has recently chosen to join our Association. Mr. Lingenfelter is an Illuminating Engineer with the Westinghouse Electric and Manufacturing Company, having served the company for 17 years. He has another hobby in addition to that of amateur radio; it is machinery. His home machine shop includes power tools, screw-cutting back-gear lathe, with milling attachments, grinder, drill press, air-compressor, etc. He states that this equipment served a genuine need when his transmitter was under construction.

Mr. Lingenfelter is another of the old-time wireless men of the spark-gap days; he had a 1-kw rotary on the air and used his initials

for call letters, as was the custom then. His present transmitter consists of an ECO with a pair of 24-As. 6L6 first buffer, 807 second buffer, and a pair of 812 in the final with 325 watts input. The modulator has a pair of 811s in class-B. The receiver is a Hallcrafters SX-25. The antenna is a half-wave off-center-fed single wire, 247.5-ft. long. Other equipment includes a Guthman U-10 frequency-meter-monitor and a National 3-inch oscilloscope. A Triplett Modulation Monitor has been added since the photograph was taken. W9NFD's primary interest is on 160 and 10 meters for 'phone, and on 40 for c.w. A Johnson "Q" antenna is used for 10-meter operation.

He is anxious to contact other A.R.D.A. Members. QRX for W9NFD.

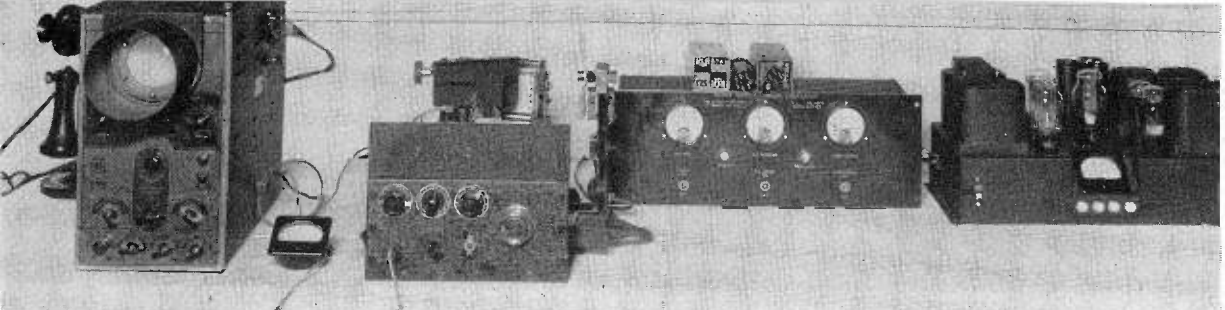

The Engineering Forum

By F. D. Wells, W6QUC

Item No. 12—Harmonic Suppressor

ALL single-ended amplifiers are rich in harmonic content, particularly when the ratio of C -to- L is low. As a consequence, when an antenna is coupled directly to the final amplifier, a sufficient amount of harmonic content is often radiated to produce a signal over very great distances,—up to 1,000 miles in some cases. If this harmonic output falls outside one of the amateur bands, and if the Radio Inspector is within a radius of 1,000 miles, a pink slip can usually be expected.

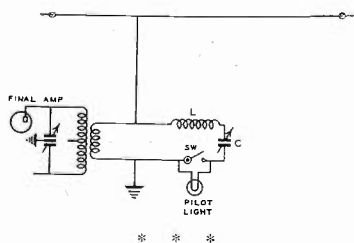

Fig. 1

Trap Circuit for Harmonic Elimination

A good example would be the case of a modulated final amplifier operating at approximately 1,850-kc. Second harmonic output would also be modulated, and the signal would be found at approximately 3,700-kc. in the 80-meter c.w. band. A tuned series trap, connected from antenna feeder to ground—in the case of a single-wire-fed antenna—will remove this undesired carrier. The trap is indicated as L and C in the accompanying diagram. The pilot light is used to tune the trap to 3,700-kc. in the above example.

The trap circuit must not be tuned to

1,850-kc., otherwise the *desired* carrier will be removed. When it is established that the L - C circuit is capable of tuning to approximately 3,700 -kc., the lamp will indicate resonance. The lamp can then be short-circuited and the 3,700-kc. output of the transmitter will automatically be short-circuited to ground. The size of the lamp depends upon the power output of the final amplifier. An ordinary pilot light is satisfactory for outputs up to 25 watts, and a 50-watt globe will suffice for power inputs up to 1-kw.

* * *

Item No. 13—Oscillator Improvement

The circuit in Fig. 2 is often used to obtain more output from the 6A6 in the 10-meter band when 40-meter crystals are in service. The first section of a 6A6 serves as a crystal oscillator on 40 meters, and the 20-meter second harmonic is emphasized by an additional 20-meter tuned circuit connected in series with the 40-meter tank. This arrangement obviates the need for quadrupling in the second section in order to obtain output on 10 meters from the 6A6.

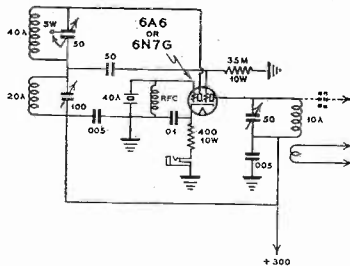

Fig. 2—Dual-triode circuit which delivers 10-meter output from a 40-meter crystal. An infinitely better circuit than one in which the second section of a dual-triode is required to function as a quadrupler.

Top-Loaded Antennas For 160 Meters



VERTICAL antennas are very desirable for 160-meter operation, but the height of a quarter-wave support structure would be well over 100 feet and some form of loading a shorter antenna then becomes necessary. Loading coils connected in series with the base of a short vertical antenna to a counterpoise or ground connection will result in very low radiation resistance, which means that the ratio of power lost in the ground resistance will be great as compared to the useful power represented by the radiation resistance. The radiation resistance in this type of antenna may be considerably less than 5 ohms, and 2 or 3 ohms of ground resistance may therefore waste as much as one-half of the power output.

A radiating antenna is most effective from the high-current portion, and consequently a base-loaded antenna is very much less effective than a top-loaded antenna, since the high current portion of the former will be confined largely to the base-loading coil. The top-loaded antenna has a loading coil connected in series with a radiator near the top of the antenna, and the base of the radiator can then be connected to a much smaller loading coil and series-tuning condenser to ground or counterpoise. This arrangement places the high current portion of the antenna into the actual radiator proper, with the result that the antenna may show 2 or 3 "R" points increase in transmitted signal strength over that of a base-loaded antenna of the same height.

The radiation resistance of a top-loaded antenna is usually in the neighborhood of 20 ohms, resulting in much less power waste in the ground lead resistance connection. It is necessary to have a capacitive element at the top of the loading coil in order to secure a reasonable amount of r-f current through the top-loading coil. Three methods of construction are shown in the accompanying

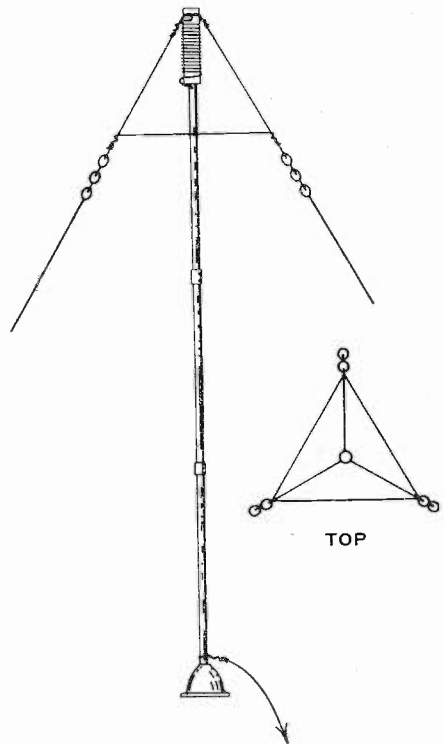

Guy wires are ideal for top capacity.

sketches. The number of turns of wire in the top-loading coil is an optimum for each particular length of antenna. The antenna tuning system at the base of the antenna can tune it to the desired resonant frequency in the 160-meter band. The top-loading coil can be varied over a few turns of wire without appreciable effect, providing the antenna is tuned to resonance at the operating frequency.

(Continued on next page)

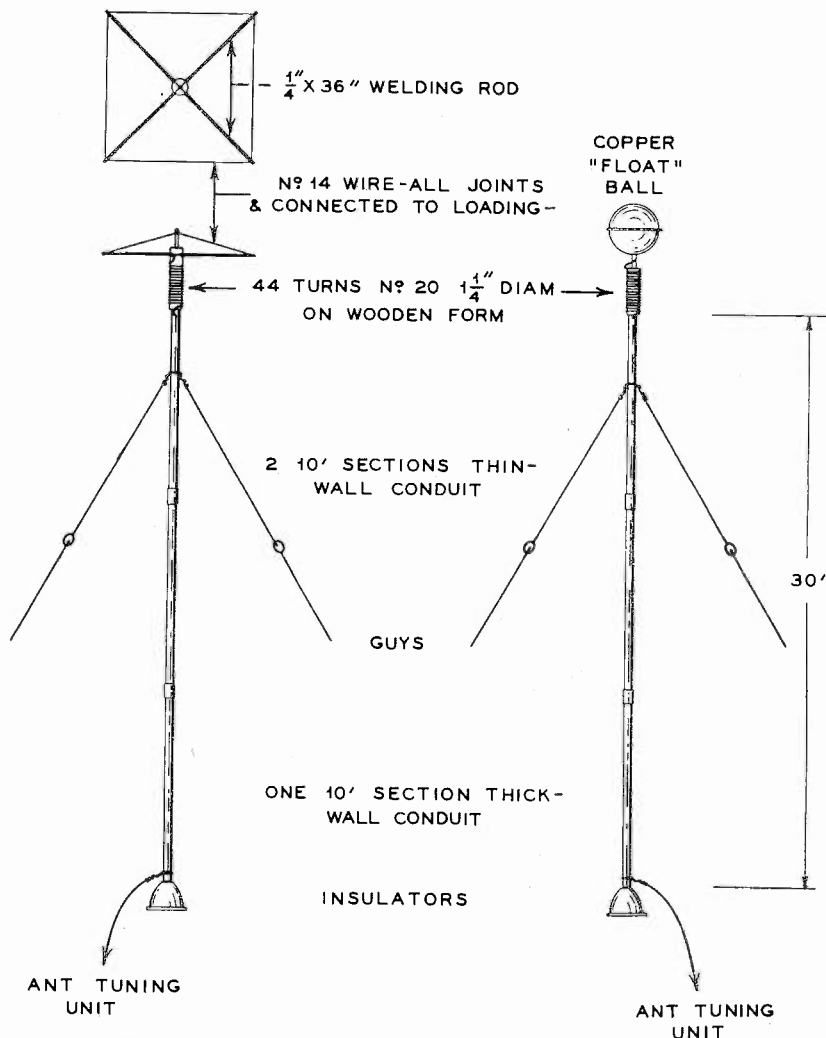

Left—Method of top-loading shown in "Radio." Right—Conventional copper ball, also suitable for top-loading.

The top-loading capacity can be very easily constructed by utilizing the top portions of the three guy wires, as illustrated in one of the sketches. These guy wires should be connected to the top of the loading coil. The first insulator, or string of insulators, in each guy wire should be placed a few feet below the top of the mast. A compromise value of 6-ft. from the top of the mast to the first insulator should be suitable for general 160-meter operation. An additional wire is then connected between the three guys at the point where the insulators are inserted, as shown in the sketch. This type of construction has the advantage of making some use of the guy wires other than that of supporting the mast. Two or three insulators should be connected in series in each of the three guys because this is the high-

voltage point of the antenna system.

The top-loading coil is usually weather-proofed by boiling it and its wooden form in a beeswax and paraffin mixture, and then thoroughly wrapping the coil with electrician's rubber tape.

The metal mast must be well insulated at the base; an insulator having good mechanical strength should be chosen. The antenna should be connected to a small base-loading coil, then coupled to the final tank coil, either inductively or by means of a link. A 200 μ mf. or 300 μ mf. series tuning condenser, connected to a multi-wire horizontal counterpoise or ground system placed under the antenna, will complete the system.

As shown in the sketches, the mast can be made of three pieces of thin-wall conduit, the total height of the mast being 30 feet.

The Winners - -

Score For Each . . . 1,000 Pct.
Wayne Miller, C. E. Thompson, W6UQ.
J. R. Welch, W6WC. Jim Scairpon, W2KAV.
Vernon O. Friesen, John Alanzman, W8OFW/W8VOG.
F. W. Schor, C. E. Lundy, W6CY.
Ralph U. Nadeau, C. J. Bolvin, WPDO/W8LVV.
W1ICS.
Lieut. A. W. Greenlee, W4HGM.
Paul D. Searles.

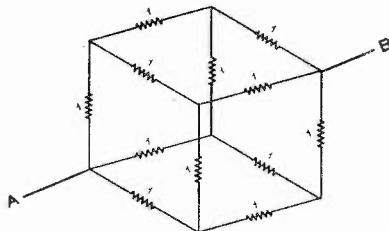

“Techquiz” Solved By 12 Readers

By C. C. Anderson, W6FFP

THE Radio Brain Trust has found the solution to the *Techquiz* brain-teaser. The answer to the resistor-cube problem presented in last month's *A.R.D.* proved more difficult than at first anticipated by the many who looked at the cube and casually remarked: "It's a cinch; the answer is one ohm." But the answer is *not* one ohm, in spite of scores of letters from those who insist that their answers are correct. Less than one per cent of the contestants found the correct answer. Strange is the fact that only the old-timers in radio solved the problem. And of more than passing interest is the fact that we have realized, for the first time, that this magazine is read by a great host of radio's "upper crust,"—professional engineers, authors of textbooks, commercial radio telegraphers, and well-known radio instructors.

The first to solve the problem correctly was Mr. Wayne Miller, located in the Engineering Building, Chicago. Incidentally, Mr. Miller is the author of "RADIO OPERATORS' LICENSE GUIDE," admittedly the best question-and-answer book available for those who are preparing to take the commercial exam. But before the correct answer came from Mr. Miller, the *Techquiz* editor's file was loaded with incorrect solutions, and the belief was prevalent in the publisher's offices that the problem would remain unsolved. It never rains but it pours—and the next morning came a letter from Mr. Paul D. Searles, Principal, C.I.T. Radio Schools, Portland, Oregon. He, too, found the correct answer, and his solution is given later in the text. But lo-and-behold, fortunes come in

groups of three (if you are superstitious), when into our domicile walked W6WC, Jimmy Welch, for many years a commercial radio telegrapher and chief custodian of radiation for Press Wireless in San Francisco. He related a sordid tale—how he had argued for days with a fellow engineer at the station who insists that the answer is *not* what W6WC calculates it to be. But it is.

No additional correct solutions were received until it was time to get this issue of the magazine to press. It seemed that the aforementioned three would share the initial honors—when suddenly an avalanche of letters came to the office, containing correct solutions from a few more contestants as shown in the *Score Box*. Special credit is here given to Messrs. Ralph U. Nadeau, W1ICS, 21 Amory St., Manchester, N. H., and John Alanzman, W8OFW-W8VOG, 413 S. Detroit Ave., Toledo, Ohio, for the thorough manner in which they went about the solution of the problem—somewhat along the lines shown by Editor-in-Chief Halloran later in this text. These two radio amateurs submitted beautifully prepared material, occupying six pages of sketches, formulae and data each. All told, the material submitted to the Contest Editor consumed something like 700 pages of copy from the many contestants, and it would be difficult to estimate how much writing paper and how many scratch pads were consumed by others who failed to submit answers for consideration. If this interest continues for the life of the contest the editors will be tempted to invest heavily in securities of the paper manufacturers.

TECHQUIZ PROBLEM No. 2

Here is the second Techquiz problem. Even if you failed to solve Problem No. 1, make an effort to solve Problem 2, because some of the earlier contestants may fail to solve the newer problem, thus giving you ample opportunity to compete for the trophy.

The Problem: What is the impedance of the same cube WHEN "A" AND "B" ARE CONNECTED TO a 110-VOLT, 60-CYCLE POWER SUPPLY and each resistor is replaced by a coil consisting of 33 turns of No. 40 D.C.C. wire, wound on a 1-inch diameter coil form, along a length of 1-inch? The resistance of the wire in each coil is assumed to be 10 ohms.

MAIL YOUR SOLUTION WITHOUT DELAY

Lieut. A. W. Greenlee, squadron flight commander in the U. S. Navy and owner and operator of one of amateur radio's most famed DX 'phone stations (W4HGM) in Pensacola, Fla., sent his answer to Techquiz just as the presses were made ready to roll for this issue of A.R.D. That puts him in the Score Box with a full 1,000 pct. for his correct solution, and thereby giving the Eastern amateurs the same number of points as the combined group in the West which first held a monopoly on the total number of correct answers. Lieutenant Greenlee's solution was the last to be received, but it ranks first in its amazing technical completeness, proving that when you serve Uncle Sam you've got to be *right*, no matter what you do.

By all means, fellow readers, don't give up, even if you lost out on the first problem. Some entirely new names may appear on the *Techquiz* horizon in future months, and you have ample opportunity to outwit the holders of initial honors.

Obviously, this *Techquiz* material is as simple as A-B-C (after the solutions are published), so let's proceed with the letters received from the three successful contestants, and see how they went about the task of solving the problem.

* * *

No. 1. Mr. Wayne Miller's Letter

Here is my solution to the February *Techquiz*:

- 1—Number resistors from 1 to 12,
- 2—Redraw diagram as shown.
- 3—Note that first section consists of three 1 ohm resistors in parallel, hence equals $\frac{1}{3}$ ohm,
- 4—Note that second section consists of six 1 ohm resistors in parallel, hence equals $\frac{1}{6}$ ohm.

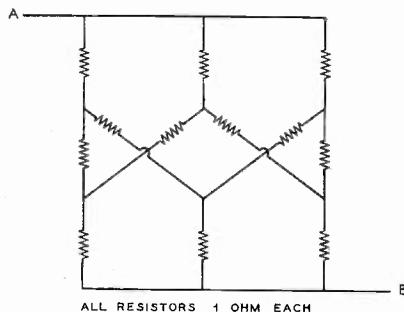

Fig. 1. Diagram for Problem as Presented.

- 5—Note that third section consists of three 1 ohm resistors in parallel, hence equals $\frac{1}{3}$ ohm,
- 6— $\frac{1}{3}$ plus $\frac{1}{6}$ plus $\frac{1}{3}$ equals $\frac{5}{6}$ ohm total resistance.

It can also be worked with higher math to show the same answer. Incidentally I used this problem in schools as a test years ago. (Signed) Wayne Miller

* * *

No. 2. Mr. Paul D. Searles' Letter

Here is my answer to your problem in the *Techquiz* page of February issue of the A.R.D. I had an enjoyable time writing the solution to this problem and hope that you feel it is adequate.

The resistance of this circuit is comparatively easy to find because of the fact that all resistances are equal. Therefore, because of the fact that all current paths at a point of current division have equal opposition, the current will divide equally according to the number of branches.

The sum of the series voltage drops will equal the voltage applies between A and B. Therefore:

$$E_{AB} = E_1 + E_2 + E_3 = E_1 + E_{10} + E_{11} = E_1 + E_8 + E_9, \text{ etc.}$$

It will only be necessary to use one branch.

$$E_{AB} = E_1 + E_2 + E_3$$

Since the resistance of each is the same, the voltage across each resistor will be directly proportional to the current. The current through R_1 will be one-third of the total current. The current through R_2 will be one-half of the current through R_1 , and the current through R_3 will again be one-third of the total current,

$$I_1 = \frac{1}{3}I \therefore E_{AB} = \frac{1}{3}IR + \frac{1}{6}IR + \frac{1}{3}IR$$

$$I_2 = \frac{1}{6}I \quad E_{AB} = \frac{5}{6}I$$

$$I_3 = \frac{1}{3}I \quad R_T = \frac{E_{AB}}{I} = \frac{\frac{5}{6}I}{I} = \frac{5}{6} = 0.833 \text{ ohms.}$$

If the resistors had been of unequal value it would have been necessary to draw up equations for the voltage drops in all the closed circuits and then solving the equations to find the unknown currents in terms of the total current. After that the resistance could be found by the following:

$$R_T = \frac{E_1 + E_2 + E_3}{I}$$

$$R_T = \frac{K_1 IR_1 + K_2 IR_2 + K_3 IR_3}{I} = \frac{K_1 R_1 + K_2 R_2 + K_3 R_3}{I}$$

K_1, K_2, K_3 —the factors by which the branch current are smaller than the total current.

Yours truly,

(Signed) Paul D. Searles,
Principal, O. I. T. Radio School,
831 SW Sixth Ave.,
Portland, Oregon.

* * *

No. 3. Mr. James R. Welch's Solution

Short and sweet is the solution submitted by W6WC. The answer is similar to that of Mr. Wayne Miller.

From the above, one could surmise that the "WC" in Jim Welch's amateur call denotes "Wizard Calculator."

No. 4. Our Editorial Director's Solution

SECURELY locked in the office safe until the first correct solution was received, there was an answer from our Mr. Arthur

H. Halloran, the editor-in-chief. This was intended for publication in the event that all contestants failed to find the correct answer. It is an absorbingly interesting bit of technical information, and so it is reproduced here for the benefit of those who wish to gain a thorough knowledge of all the factors involved in tracing the circuits, and the complete proof of the solution of the problem. Your humble scribe W6FFP, the Techquiz Editor, had the answer to the problem before it was presented for publication, and his solution is practically identical to the one submitted by Mr. Wayne Miller.

Here is Mr. Arthur H. Halloran's step-by-step solution which should find a place in every serious-minded experimenter's notebook:

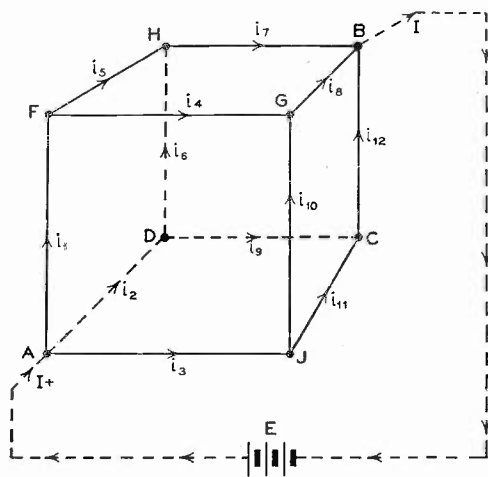

FIG. 2

Fig. 2. Diagram Completed Preparatory to Solution.

THE solution of Techquiz No. 1, as published in the Feb. issue, depends upon an understanding of three basic laws of electric circuits:

(I) Ohm's Law states that the voltage drop, e , across a resistance, r , through which a current, i , is flowing, is defined by

$$e = ir.$$

(II) Kirchhoff's Law for current flow states that the algebraic sum of the currents which flow toward a branch point (junction of two or more paths) in a closed circuit is equal to the algebraic sum of the currents which flow away from that point.

(III) Kirchhoff's Law for voltage drop states that the algebraic sum of the voltage drops in a closed circuit is equal to the applied voltage.

The preliminary steps in the solution are: (1) Complete the circuit by adding a voltage source, E, which supplies a current, I, as shown in Fig. 2.

(2) Designate the branch points by any arbitrarily chosen symbols, such as A, B, C, D, F, G, H, J, in Fig. 2.

(3) Indicate assumed directions of current flow by means of arrows between the points, and of current values by means of symbols such as I, i_1 , i_2 , etc. The actual choice of directions is immaterial, inasmuch as any conflict is cancelled in the final result. The general direction of positive flow is assumed to be from A to B.

(4) Denote the resistance between any two branch points by means of symbols such as R, r_1 , r_2 , etc. (Unnecessary in this problem because all the resistances are equal to 1-ohm.)

The next steps are to write the current equations for each point in accordance with Law (II), and the voltage drop equations for each branch, in accordance with Law (III), as follows:

At point A we have $I = i_1 + i_2 + i_3$. Since the resistances of the three branches are identical, the same current flows through each, whence $i_1 = i_2 = i_3$. Consequently, we can write

$$\begin{aligned} I &= 3i_1, \text{ whence } i_1 = I/3, \\ I &= 3i_2, \text{ whence } i_2 = I/3 \\ I &= 3i_3, \text{ whence } i_3 = I/3. \end{aligned}$$

Furthermore,, because the resistance of each branch is unity, the voltage drop along AR is $v_1 = i_1 = I/3$ the voltage drop along AD is $v_2 = i_2 = I/3$ the voltage drop along AJ is $v_3 = i_3 = I/3$.

At point B, by following the same procedure, we can readily prove that the voltage drops along HB, GB, and CB, respectively, are $i_7 = I/3$, $i_8 = I/3$, and $i_{12} = I/3$.

At point F, the current branches along FH and FG, and the current equation is $i_1 = i_5 + i_1$. Because of the equal unit resistances, we have $i_5 = i_1$, whence $i_5 = i_1/2 = I/6$, and $i_1 = i_1/2 = I/6$. These are also the numerical values for the voltage drops along the two branches.

At point D, by following the above procedure, we can readily find the voltage drop along DH to be $i_6 = I/6$, and along DC to be $i_9 = I/6$.

At point J, likewise, the voltage drop along JC is found to be $i_{11} = I/6$ and along JG to be $i_{10} = I/6$.

Having thus found the voltage drop along each of the 12 branches, there is no difficulty in finding the algebraic sum of the voltage drops along any possible path of current flow between A and B. A voltage drop is positive when the path follows a direction indicated by an arrow, and is negative when the direction of the path is opposite to that indicated by an arrow. The equivalent resistance of the entire circuit is then found by equating the algebraic sum to $E = IR$, in accordance with Law (III), and finally solving for R.

For example, in following a direct path from A to F to H to B, we pass successively through AF, with a voltage drop of $i_1 = I/3$, FH with a voltage drop of $i_5 = I/6$, and HB with a voltage drop of $i_7 = I/3$. Consequently, we can write

$$\begin{aligned} E = IR &= I/3 + I/6 + I/3 = I(1/3 + 1/6 + 1/3) = I(5/6) \\ \text{whence } R &= 5/6 \text{ ohm.} \end{aligned}$$

Or in following the path from A to F to H to D to C to B, we pass successively through AF, with a voltage drop of $i_1 = I/3$, FH, with a voltage drop of $i_5 = I/6$, HD, with a voltage drop of $-i_6 = -I/6$ (negative because opposite to direction of arrow), DC, with a voltage drop of $i_9 = I/3$, and CB, with a voltage drop of $i_{12} = I/3$. Wherefrom we have

$$\begin{aligned} E = IR &= I/3 + I/6 - I/6 + I/6 + I/3 \\ &= I(1/3 + 1/6 - 1/6 + 1/6 + 1/3) = I(5/6) \end{aligned}$$

$$\text{whence } R = 5/6 \text{ ohm.}$$

In following some roundabout path such as A to J to G to F to H to D to C to B, we would have the voltage drops for AJ = $i_3 = I/3$, for JG = $i_{10} = I/6$, for GF = $-i_4 = -I/6$, for FH = $i_5 = I/6$, for HD = $-i_6 = -I/6$ for DC = $i_9 = I/6$, and for CB = $i_{12} = I/3$, which figures to give $R = 5/6$ ohm.

The answer is always the same, no matter what path be followed. A direct path obviously gives easier figuring.

* * *

GOING UP!

THE F.C.C. reports that there are now 56,300 licensed amateurs in the U. S. A.—and more on the way. This is an all-time high. The war has scared a lot of people into amateur radio . . . and a lot of merchants out of it.

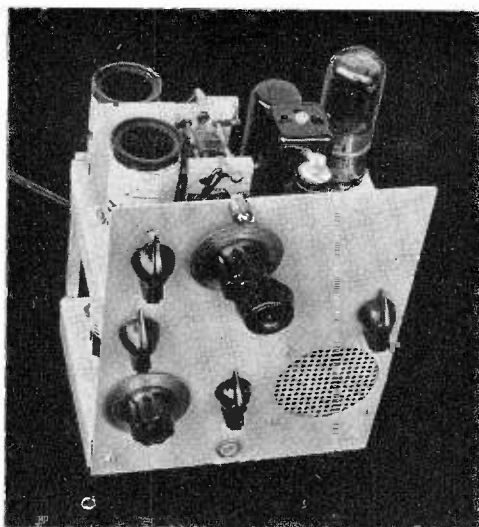

Front and top view of midget portable transmitter receiver for c.w. operation.

Pee-Wee De-Luxe

A TRANSMITTER-RECEIVER truly portable, whose overall dimensions are only $7\frac{1}{2}$ -in. high, 6-in. wide and $4\frac{1}{2}$ -in. deep, serves many useful purposes. It can consist of a crystal-controlled transmitter, built-in power supply, antenna switching circuit, and a complete superheterodyne receiver of the popular "Super Gainer" type.

The transmitter has a pair of 25L6GT beam power tubes connected in parallel as a straight pentode crystal oscillator. With an input of 15 watts, the carrier output on 80- and 40-meters is 8 watts when the oscillator is tuned to the point of best operation for c.w. keying. This is enough output to work reasonably long distances on c.w. The 25L6GT tubes are small in physical size and have 25-volt heaters. The heaters of the tubes in the complete unit are connected in series, since all of the heaters are rated at 0.3 amp. The total voltage drop across these heater circuits amounts to $112\frac{1}{2}$ volts, which permits connection of the heater circuit directly across the 110- or 115-volt a.c. line.

The crystal oscillator is arranged with two tubes in parallel in order to obtain high output without overloading the small beam power tubes. The crystal r-f current is less than 50 ma. with a 40-meter crystal, and approximately 80 ma. with an 80-meter crystal, which is far below the maximum rating.

Under load, the plate potential is 250 volts, and this must be reduced to approxi-

mately 110 or 120 volts for the screen-grids of the crystal oscillator tubes. The actual r-f output is greater when the screen-grid voltage is *reduced*; likewise, the cathode current is then much lower. The plate circuit is tuned with a midget 100 μf . tuning condenser and the antenna is coupled to this low impedance circuit through a 20-to-100 μf . mica trimmer condenser. This condenser is adjusted so as to load the crystal oscillator cathode current to about 80 ma., and the plate circuit is tuned to the high-frequency side of plate circuit resonance in order to insure good keying. This type of antenna coupling permits nearly any length of antenna wire which might be available for portable operation in hotels or auto camps. If the antenna is a multiple of half-waves in length, the antenna coupling condenser must be set at a very low value of capacity in order to prevent overloading of the crystal oscillator. A small $\frac{1}{4}$ -watt neon bulb, or a pilot lamp and loop of wire are very useful for adjusting the plate tuning and antenna coupling condensers to the particular antenna in use. The same antenna is used for either transmitting or receiving, changed over by means of a small dpdt rotary switch. One side of this switch transfers the plate supply voltage to either the transmitter or receiver.

The power supply has a 25Z6GT double rectifier in a voltage-doubling circuit which provides approximately 250 volts at 80 ma.

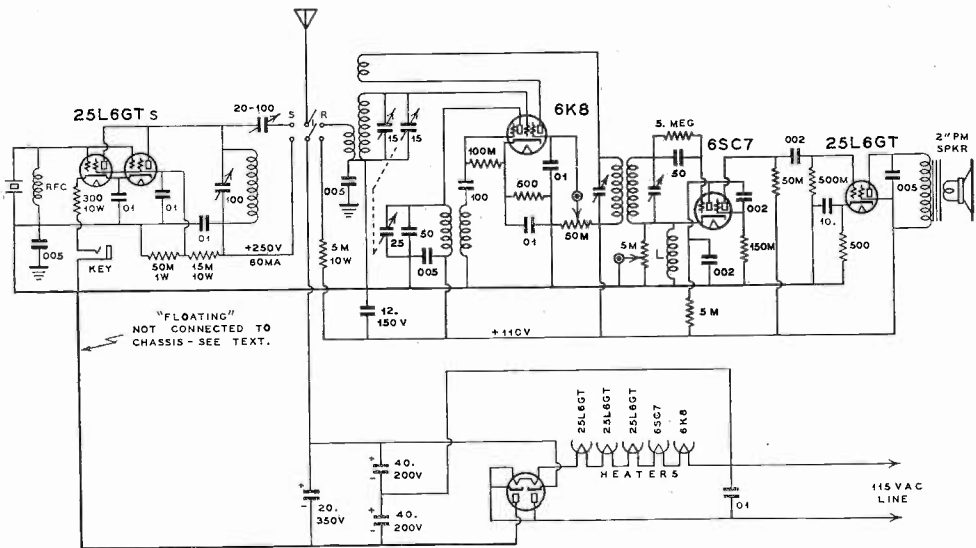

Complete wiring diagram for midget receiver-transmitter.

to the transmitter, or 120 volts through a dropping receiver to the receiver. The power supply has no transformers or filter chokes. Two 40 μ f. 200-volt electrolytic condensers in series are used in the voltage-doubling circuit, and a 20 μ f. 350-volt condenser across this combination provides an effective capacity of 40 μ f. across the plate supply to the crystal oscillator. This is sufficient capacity to permit operation without filter chokes. The same filter capacity is used in the receiver, together with a 12 μ f. 150-volt electrolytic condenser and a 5,000-ohm 10-watt resistor. This resistor drops the plate voltage to the desired value, and also serves the purpose of a filter choke for reducing a.c. hum. The receiver is designed primarily for c.w. reception and low-capacity coupling condensers will therefore suffice. The resultant a.c. hum in the 2-inch permanent magnet dynamic speaker is entirely negligible for c.w. reception. An .01 μ f. condenser is connected across the 110-volt line in order to reduce a.c. pick-up and also to prevent this circuit from acting as an antenna. The a.c. line can be used in this manner as an effective ground connection in the event no external ground is available for connection to the aluminum chassis. The negative B circuit is entirely insulated from the aluminum panel and chassis, and insulated coupling washers are required for supporting the various tuning condensers.

The receiver is one form of the "Super Gainer," in which a 6K8 tube serves as a regenerative first detector and high-frequency oscillator. Regeneration is obtained at the

signal frequency by means of a tickler coil connected in the detector circuit. The triode section of the tube is connected to a high-C tuned-plate oscillator circuit, which has good frequency stability for c.c. reception. Regeneration at the signal frequency improves the sensitivity of the receiver and aids in reducing image interference. The i.f. transformer frequency of 1600-kc. does not permit as much selectivity as could be had from a standard 465-kc. transformer; however, the image interference is much less with 1600-kc. The i.f. transformer couples the 6K8 mixer tube to the 6SC7 regenerative second detector. This tube is a twin triode, in which one section acts as a low-gain resistance-coupled audio amplifier for connection to a 25L6GT second audio amplifier; it drives a small 2-in. loud-speaker which is built into the set, and thus requires less space than would be needed for a pair of headphones. The 6SC7 detector is regenerative, and for c.w. reception it is made to oscillate by a cathode coil and variable resistor in the cathode circuit. The cathode coil is made by winding 150 turns of No. 34 dsc wire on a ceramic form of the kind used for a 1/2-watt, 1/2-meg. resistor. The resistor itself will have no effect upon the operation of the circuit. Regeneration is controlled by a midget 5000-ohm variable resistor shunted directly across this coil. The number of turns on the cathode coil depends upon the circuit Q, or losses in the i.f. transformer, since in some cases as few as 50 turns will give sufficient regeneration and oscillation in the second detector. The re-

sistors in the plate circuits of the 6SC7 tube are made purposely low in order to prevent audio feedback and also to limit the amount of audio gain to a value suitable for a small 2-in. loud-speaker. This type of receiver is extremely sensitive for c.w. reception and is much more selective than a t.r.f. or simple regenerative detector circuit.

The set is built on two 4x6x1-in. aluminum chasses which mount behind a 6x7½-in. front panel. The detector trimmer condenser is mounted on the front panel in order to take full advantage of the regenerative features of the 6K8 detector.

The receiver tuning condenser is a two-section *Tiny-Mite* unit, having 8 plates in each section. Three of the plates are removed from the detector section in order to permit close tracking between the two tuned circuits. The oscillator section has a 50 $\mu\mu\text{f.}$ "Silver Mike" (silver-plated mica condenser), of the low temperature coefficient type, connected in parallel to the 25 $\mu\mu\text{f.}$ variable condenser. The high-C in this circuit permits very good oscillator stability. Regeneration in the detector section is controlled by a midget 50,000-ohm potentiometer connected to the screen-grid of the 6K8 tube.

The receiver is lined-up by means of an all-wave test signal generator, first tuned to 1600-kc. in order to line-up the i.f. transformer. The secondary of this transformer is slightly detuned in order to permit the second detector to oscillate and act as a b.f.o. for c.w. reception. The oscillator and detector coils are made to track with the detector trimmer towards the setting of full capacity by spacing the turns on the coil form proper. The 40- and 80-meter signal from the test signal generator is used to align the front-end of the receiver. The tuning condenser has sufficient capacity to tune over the complete 80-meter band with a few degrees to spare at each end. The 40-meter band covers approximately one-third of the dial.

The coils for the receiver and transmitter are wound on 1¼-in. dia. plug-in forms. The transmitter coil has 25 turns of No. 22 dcc wire, wound to cover 1½-in. of space, for the 80-meter band. The 40-meter transmitter coil has 18 turns of No. 20 dcc wire, wound to cover 1½-in. of space. The receiver coils for 80 meters are all wound so that the tuned coil covers a winding space of 1-in., and the other coils are wound below the ground end of the tuning coils. The detector coil for 80 meters consists of 46 turns of No. 26 enam., with a 10-turn antenna coil wound just below it, and then a 10-turn tickler coil

wound below the latter winding, with all windings in the same direction. The oscillator coil for 80 meters has 22 turns of No. 22 dcc wire in the tuned plate circuit, and the untuned grid winding consists of 15 turns of No. 22 dcc, wound in the same direction, and below the plus B end of the plate coil. The grid and plate leads connect to the opposite ends of the coil form, in order to obtain oscillation.

The 40-meter detector coil has 24 turns of No. 24 dcc, with a 5-turn primary and a 6-turn tickler. The 40-meter oscillator coil has 12½ turns of No. 22 dcc in the plate circuit, and an untuned grid coil with 10 turns of No. 24 dcc.

* * *

Has It Happened to You?

ISN'T IT strange when an applicant for amateur license tells you he flunked the code test because he is positive the code machine had its governor removed—and rattled away at "much more" than 20 words per! We have yet to find the first unsuccessful code demon who rightfully blamed himself for failure in the Radio Inspector's office. On the other hand, have you heard the *successful* applicant brag how easy it was to pass the code test—and have you heard him relate that the machine seemed to send so slowly he feared it would stop before the required five minutes had elapsed? Well, it all depends upon how you come out in the end, doesn't it? It is a fact, however, that many can copy faster than 13 wpm at home, yet when they take the test in Uncle Sam's offices they fail so badly you'd think they studied the wrong kind of a code. They get what is commonly known as "Eagle Fright"—they see the eagle on the Inspectors' badge, and they shake in their boots. Yet there is no case on record to prove that the eagle has flown from that badge and landed on an applicant's nose. There is no need to fear the R. I.; he doesn't fear you. To him you are just another person seeking a license. Throw off the Uncle Sam complex; that fellow is your best friend.

Long years ago a very prominent amateur who contributed regularly to the editorial pages of a radio magazine we published in the hey-dey of the kitchen-built superheterodyne was so fearful of flunking the radio examination that he blackened his face with

(Continued on page 37)

Circuit Of The Month

No sooner had the February issue of A.R.D. been in circulation when a score of letters was received in connection with Frank C. Jones' suggested method of utilizing lower grid drive, feeding some audio voltage back into the grid circuit, and practically eliminating distortion in modulated r-f amplifiers. "What's this all about?" queried many. It's as simple as A-B-C and the method can be applied to any 'phone transmitter already built. So we were asked to show a complete circuit diagram, and tell all about it. Thus it became the "Transmitter Circuit of the Month"—and a very good one, too.

By The Technical Staff

THE "Circuit of the Month" for March is published in response to the ever-growing list of technical questions to reach the editor, and it revolves around a circuit consisting of a pair of *Eimac* 35Ts in push-pull in the final r-f amplifier.

The *Eimac* 35T has long been a popular tube among amateurs because of its ability to withstand more-than-usual overloading without injury. The circuit constants suggested for this transmitter are very conservative, since a pair of 35Ts are sometimes operated with inputs as high as 1-kw. for c.w. operation. The final r-f amplifier shown in the circuit operates with 400 watts input, because it is quite simple to obtain 200 watts of audio modulating power, and with a peak audio power of 400 watts, from a pair of RCA-811 zero-bias tubes. The 35Ts, in common with many other types of high- μ tubes, can be made to deliver excellent linearity with plate modulation, provided that some audio voltage is applied to the grid circuit, as shown in the diagram. Between 100 and 200 volts of audio power is all that will be required to insure excellent linearity.

Many amateurs have noticed a downward flicker in the plate current meter during modulation, even though an oscilloscope or other type of overmodulation indicator showed no carrier shift. This difficulty can usually be cured by connecting a small amount of the audio modulating voltage back into the grid circuit of the modulated amplifier. Distortion is present to a lesser degree in medium- or low- μ plate-modulated triodes, and the same audio feed-back circuit can therefore be applied to reduce the distortion of the modulated amplifier to a negligible value. The audio voltage can be obtained from a tap on the secondary of the modulation transformer through a high-voltage audio by-pass condenser of the type used in a high-voltage power supply filter

system, or the secondary of the modulation transformer can be connected in series with the negative high voltage lead, rather than in the positive high-voltage lead, as shown in the circuit diagram. When the transformer winding is connected into the negative high-voltage lead, the grid-leak circuit can be connected directly in series with the transformer tap and the 2mfd. high-voltage condenser can then be eliminated. The circuit is shown with the condenser in the more conventional arrangement merely in order to simplify the installation of this innovation in existing plate-modulated amplifiers. With audio feed-back into the grid circuit of the modulated amplifier it is possible to obtain excellent linearity of modulation at reduced values of d.c. grid current in the case of transmitter designs where insufficient grid drive is originally encountered.

A type-811 buffer or doubler was chosen as a driver, in the circuit shown, because of its low cost and high- μ characteristics. The 811 is an excellent frequency doubler and does not require as much grid drive as some other types of tubes which may be used for this service. The grid circuit for the 811 can be link-coupled by means of plug-in coils to either the doubler section of a 6A6 crystal oscillator, or to an ECO unit capable of supplying from 5 to 10 watts of r-f power. Any standard pentode or harmonic crystal oscillator can be substituted for the 6A6, if desired.

The 6A6 crystal oscillator should never be operated with more than 30-ma. of cathode current when the doubler section is not in service, or at 60-ma. when both sections of the tube are functioning. The 6A6 cathode current in the latter case will normally range between 40- and 60-ma., depending upon the plate voltage and degree of link-coupling to the buffer stage. The grid and cathode d.c. current values for the other

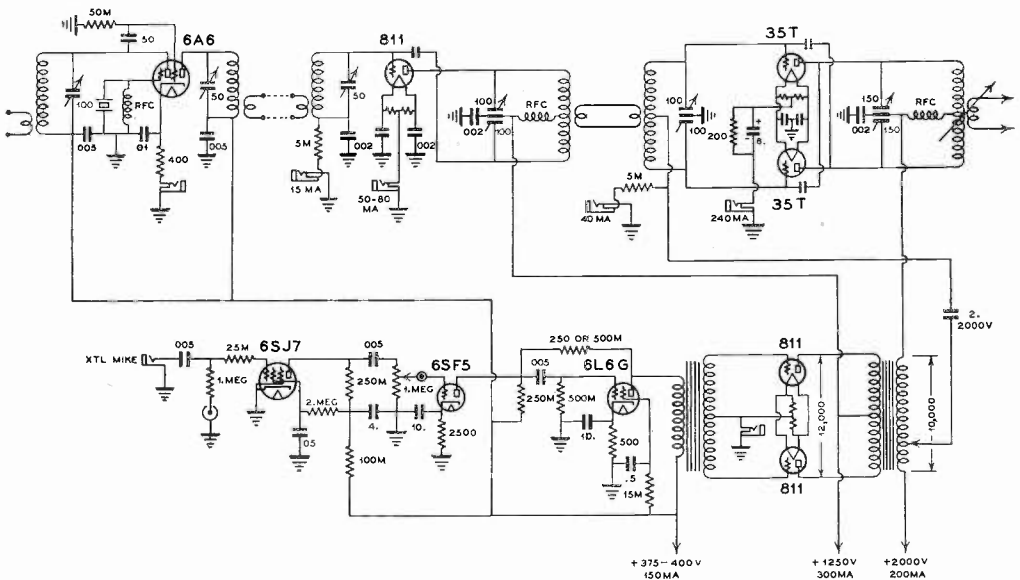

Aside from the innovation of feeding a small amount of audio modulating voltage back into the grid circuit of the modulated amplifier stage, for the purpose of preventing distortion, the wiring diagram above will give you the proper constants for a well-designed Eimac 35T push-pull transmitter. Paste this circuit in your note-book; refer to it when you need correct information for operation of 35Ts.

stages are indicated in the circuit diagram. Single-spaced tuning condensers are suitable for all circuits up to the plate of the buffer stage. The condenser air-gap for the buffer and final grid circuit should be 0.07-in. The plate tuning condenser in the final r-f amplifier should have an air-gap of at least 0.100-in.

For voice communication service a crystal microphone can be used with a high-gain 6SJ7 speech amplifier, built into the main audio system. Resistance coupling between the first three stages will eliminate some of the common hum problems, and will permit attainment of excellent voice quality. A 6L6G tetrode driver stage is connected through a conventional class-B input transformer to the grids of the class-B stage. The 6L6G is connected into an inverse feedback system consisting of a $\frac{1}{4}$ - or $\frac{1}{2}$ -meg. resistor between the plate and grid circuits of this stage. This inverse feedback circuit permits the tetrode to become an excellent class-B driver, with as much or more gain than a push-pull 45 or 2A3 stage. This type of circuit eliminates an interstage push-pull transformer; therefore the possibilities of hum pick-up are obviated. The 811 class-B modulator is used with zero bias for plate potentials as high as 1250 volts. At this voltage it is possible to easily obtain 40 watts of peak audio power, which is the amount

required to modulate 400 watts of input to the final r-f amplifier. This represents an average power of 200 watts with sine wave input, and approximately 100 watts of average speech audio power.

Three power supplies are required for this transmitter. The class-B modulator and r-f buffer stages should be operated from a 1250-volt supply with choke input to the filter system. It is desirable to use a two-section filter in this power supply, as well as in the low-voltage supply. The 2000-volt supply should be capable of handling 200-ma. of load current.

* * *

HAS IT HAPPENED TO YOU?

(Continued from page 35)

burnt cork in order to disguise himself when he appeared before the Radio Inspector. He decided to masquerade under the name of Sammy Brown, hopeful that he could get the examination questions, memorize them, return home to study, go back to the R. I. at some later date under his correct name, and pass the examination with ease. But when he walked into the Inspector's office at the Custom House the gal at the information desk let out an R99999 yowl. He forgot to blacken his hands. "Sammy Brown" dashed out of the office faster than a tube goes out when you hook the plate voltage to the filament terminals.

ALL-BAND PORTABLE

(Continued from page 23)

simplicity, but nevertheless all coils for these circuits are of the plug-in type.

A 10-meter crystal is used for 5-meter operation in the oscillator, with the doubler section on 5 meters, and with the final r-f amplifier always working in a straight-through manner.

All wiring is of the telephone-cable type, braided and laced so as to present a neat appearance.

There are six separate switches on the front panel. One is for the noise-limiter, which is used only for receiving 10-meter phone signals. The main switch is of the 6-pole double-throw anti-capacity telephone-type, such as a *Federal*. In one operation, this multi-pole switch changes the set from transmit to receive. Another switch, connected in the oscillator-doubler stage, allows the 807 to be driven straight through by the oscillator, or from the doubler section, as desired; in one position of the switch the doubler section is cut-out for straight-through operation. The antenna switch connects the 140 μ f. condenser either in series or parallel for tuning the antenna loading coil. This switch is a *Centralab* 3-position double-throw rotary unit. Antenna taps are selected by means of an 11-position rotary switch, connected to the respective taps on the coil.

The encircled numerals from 1 to 6 in the circuit drafting indicate the *arm* of the 6-pole anti-capacity switch, and *T*, *R*, the transmit or receive positions respectively. All encircled numerals indicate connections to the 6-pole switch.

Conclusion

The entire transmitter-receiver, without power supply, weighs less than 25 pounds. It can be operated successfully from a standard *Mallory Vibraback* power unit.

SUBSCRIBE NOW!

Dealer supplies of copies of A. R. D. are exhausted quickly. The demand for this magazine is growing fast. Subscribe now—and protect yourself against missing a single issue.

NEW PRODUCTS

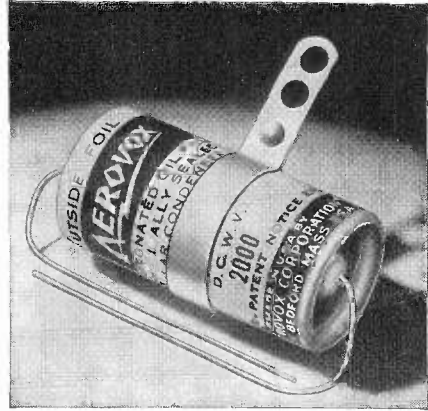

Midget Tubular Oil-Filled Condensers

GENUINE oil-impregnated, oil-filled condensers in handy tubular form are finding many uses in radio assemblies, particularly for vibrator applications, coupling functions, and in low-power transmitters and transreceivers, television receivers, amplifiers, and in test instruments and laboratory rigs. The —39 series manufactured by Aerovox Corporation of New Bedford, Mass., and now offered as a standard item, has a cadmium-plated brass can for thorough hermetic sealing, covered by a special varnished-paper jacket with spun-over ends to prevent the shorting or grounding of sharply-bent leads. There is a center mounting strap. These units are surprisingly low in cost, thereby providing the choice of a genuine oil-filled condenser where the usual wax-filled tubular might otherwise be used. Available in 400 v., 600 v., 1000 v., and 2000 v. ratings, .006 to .5 mfd. capacities.

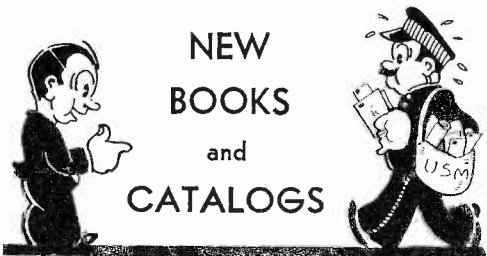

"Understanding Radio," by Watson, Welch and Eby. Published by McGraw-Hill Book Co., Inc., New York City. Price: \$2.80 per copy.

This simplified text of 600 pages offers an introduction to the radio field for anyone interested in it as a hobby or as a means of livelihood. The authors have used the book's manuscript for classroom instruction and the material is presented in such a form as to give the student a thorough understanding of fundamental radio and electrical theory, practical set construction, and operation of basis radio circuits. This book fills a vital need as a starting point in the radio field, because too many other books assume considerable knowledge of radio and electrical theory and circuits. It is recommended to anyone interested in learning why a circuit or a radio set performs certain functions.

The War Trend - And The Amateur

UNUSUAL interest was aroused by the publication in last month's *A.R.D.* "war-or-no-war" column. Numerous readers requested our "latest opinions" in each succeeding issue, so that the amateur will know where and how he stands. It is not the purpose of this magazine to predict the course of the war. Others more expert in calling the turn of events (99 per cent wrong, as a rule) will continue to tell you what to expect tomorrow. We are concerned primarily with the ultimate fate of the radio amateur. So we make our monthly prediction, and we pass it along to you for what it is worth. Since its inception, this magazine has correctly interpreted the amateur's position—has given the amateur renewed hope and confidence, and has played a major role in strengthening amateur radio defense of the nation. Therein lies our mission. This publication is not a commercial venture, has no salaried employees, solicits as much advertising as is needed to assure its continuance during the emergency, and is published by a group of men who served in the first World War.

There is practically no hope of a termination of hostilities during the current year. Radio amateurs can safely purchase new equipment now, while they can still get it, and without the penalty of a 20 per cent general price increase. It is an open secret that radio jobbers in many cities are laying in huge stocks of radio receivers and allied gear, knowing that a price increase is just around the corner, and also knowing that there will soon be a great scarcity of good communication equipment. We tell you this not because we are trying to build a false front for those who merchandise radio apparatus, or to build a market for our advertisers, because the few whose names appear in the pages of this magazine sell the major part of their production to interests far removed from amateur radio. The first effect the war will have on the amateur is the higher cost of equipment, then a scarcity will prevail, then you will take what you can get—when you can get it.

Now for the war picture. The Lend-Lease Bill will pass, of course—with or without amendments. Suppose, as some say, the bill is a war measure . . . what will happen to the radio amateur? Let's make a cold-

blooded summary of the situation. We will manufacture enormous quantities of war material for Britain. Does it seem logical to you that we will let this material lay on the docks and rot for want of shipping space? Why try to help Britain if we can't deliver the war supplies to her shores? The entire plan would otherwise be an idle gesture. If Britain hasn't the ships to take the goods to her homeland, we will deliver the supplies on our own ships, either transferred to the flag of another country, or flying the Stars and Stripes. It really doesn't matter what flag a war cargo ship flies. Hitler will try his best to sink as many ships as possible. If the war material is carried on U. S. ships, some of our ships will be sunk. If we get enough ships through the counter-blockade of Britain, the war will last a long, long time and Hitler will slowly but surely go down. To us it looks like a battle at sea—a stepped-up program to build ships and ships and ships, hoping that more and more of them will successfully run the counter-blockade. Why, then, should the amateurs in the U. S. A. be further restricted? There is no reason for a shut-down at this time, and it wouldn't make sense. If ships go down at sea, the amateur on land will stay on top. The sinking of ships (thousands of miles away should have no *direct* effect upon the status of the radio amateur. If our ships are sunk, and if war is declared as a result of these sinkings, it seems probable that we will send thousands of planes and thousands of American airmen to Britain in order to bomb hell out of Hitler . . . and keep it up until he is ready to quit.

In this case there still exists no valid reason why the amateurs should go off the air in the U. S. A. The situation—from the standpoint of the amateur—looks quite secure. Let's make the most of it.

For each young amateur called for military training, two newcomers will take his place on the air. And while the young fellows shoot bullets for Uncle Sam, the old men of amateur radio shoots bugs in their rigs. For the first time the oft-abused high-sign of ham radio—"OM"—take on a real significance. If you're an "OM," join Amateur Radio Defense Association now. Look for the application for enrollment elsewhere in this issue.

The Peaked Audio Filter

This subject is not new. Neither is its application. But the principle of operation of the very simple peaked audio filter herein described has not been properly treated before. It remained for the author to prove the actual worth of so simple a circuit, and every c.w. operator can benefit from its use.

By C. C. Anderson, W6FFP

HOW many times have you tried to copy a difficult c.w. signal, only to lose it when another of greater intensity, and only a few cycles removed from the listening frequency, suddenly blocked the desired signal out of the picture? Few c.w. men who have not been confronted with this aggravating problem. There is a solution, and perhaps the idea has already been tried by various experiments, but without locating the actual source of the trouble. If, for example, the signal to which you are listening is 35 db below the interfering signal only 50-cycles or less removed from it, a peaked audio filter, if properly designed, will practically eliminate the interfering signal. The action of the circuit is similar to that of a crystal filter, but without the single-signal effect. This filter has been used by the author for many years, and the results have been highly gratifying. The audio filter under discussion consists merely of an iron-core choke and a fixed condenser. The values of capacity and inductance determine the frequency of the signal to be received.

A resonant circuit is one which tends to reject all but a single desired frequency, and the experimenter must first choose the frequency or pitch of the signal he desires to copy. Many operators prefer 800 cycles, some 1,200 cycles, others 1,600 cycles. The higher frequencies seem to penetrate the noise level with greater ease, and are therefore often chosen for easier copying. A filter which passes the 1,600-cycle frequency has the advantage of rejecting the lower frequencies; these are so greatly attenuated that they are practically inaudible. A band-pass filter would obviously be more desirable, but it involves greater cost, and with few advantages. Undoubtedly, many experimenters have tried some form of peaked audio filter without the anticipated results, because the impedance of the filter *at resonance* was not properly matched to the headphones. The principal advantage of the peaked audio

filter described herein is that a mismatch of impedance actually chosen for the unwanted signal. Suppose, for example, that the impedance of the headphones is 40,000 ohms, such as a pair of *Trim Featherweights*. At resonance, the filter has but 10 ohms impedance. The mismatch, therefore, is 4,000-to-1, which is a highly undesirable condition, because there is a 75 db difference. The correct condition of operation would be one where the two impedances are equal, yet the actual mismatch must be that of the unwanted frequencies.

Design Considerations

FOR the sake of explanation, a design was worked around a 0.9-henry choke, which happened to be the value of one on hand in the author's station. The same design data, however, can be applied to a great number of combinations of inductance and capacity, depending upon the parts on hand, and also the frequency the operator desires.

With the 0.9-henry, 10-ohm choke on hand, equations were resorted to in order to determine its application to the filter circuit.

$$\text{Eq. 1 } Z = \sqrt{R^2 + (X_L - X_C)^2}$$

$$X_L = 2\pi fL$$

$$X_C = \frac{1}{2\pi fc}$$

$$\text{or } Z = \sqrt{R^2 + \left(2\pi fL - \frac{1}{2\pi fc}\right)^2}$$

Since this particular choke had but 10-ohms resistance, R_2 can be neglected, for the time being, without introducing too great an error in the solution. Consequently, the simple formula is used:

$$\text{Eq. 2 } Z = 2\pi fL - \frac{1}{2\pi fc}$$

Now X_L is the simple equation for finding inductive reactance, and X_C that for capacitance, bearing in mind that C is in farads. We are told that when the inductive reactance and capacitive reactance are equal, a condition known as *resonance* exists, and the inductance Z of that circuit is equal to the resistance, which in this case is 10 ohms. Disregarding the 10-ohm value, which to minute currents would cause but little voltage drop, it can then be assumed that Z is zero.

$$\text{Eq. 3 } Z = 0 = 2\pi fL - \frac{1}{2\pi fc}$$

$$\text{or } 2\pi fL = \frac{1}{2\pi fc}$$

To find the value of "f":

$$\text{Eq. 4 } f^2 = \frac{1}{4\pi^2 LC}, \text{ or } f = \frac{1}{2\pi \sqrt{LC}}$$

which is the familiar equation for finding the frequency of a resonant circuit, with L in henries and C in farads. Since the farad is a mighty large unit, and because all condensers are either millionths or fractions of millionths of a farad in value, it is quite simple to become confused when resorting to the decimal point when the square root of these millionths of a farad is to be extracted. A more simple method would be to revert to equation 3.

$$2\pi fL = \frac{1}{2\pi fc}$$

In order to make use of equation 3, it must be fairly well established that a 0.9-henry choke, or the particular value of choke you desire to use, is in the audio or radio spectrum, and then the selection of frequencies is made—the easiest method being some multiple of 10, so that the higher multiples can be quickly worked out from the first "tedious" process of multiplication. A good starting point would be 50 cycles, because it is easy to get 100, 200, 500, 1,000 etc., by simply multiplying the first result by 2, 4, 10, 20, etc. Substituting 50 for "f" in X_L :

$$2 \times 3.14 \times 50 \times 0.9 = 282.5 \text{ ohms.}$$

Hence, by merely multiplying 282.5 by the various multiples, a Table can be compiled for as many frequencies as may be desired, as follows:

TABLE I

Z_L in Ohms	f in C.P.S.
282.5	50
565	100
1130	200
2825	500
5650	1000
11300	2000
28250	5000

The next step is to determine the value of condenser which will produce resonance with the 0.9-henry choke at, say, 1000 cycles. By referring to Table 1, it is seen that X_L at 1000 cycles is 5650 ohms, and since at resonance X_C must be equal to X_L , the following equations are used:

$$X_C = \frac{1}{2\pi fc}; \quad C = \frac{1}{2\pi fX_C} \quad X_L = 560 = X_C \quad f = 1000$$

$$C = \frac{1}{2 \times 3.14 \times 1000 \times 5650} = \frac{1}{35,482,000} = .0000000207 \text{ Farads}$$

or .0207 μ f.

A condenser with a capacity of .0207 μ f. is of an odd size, and the common value of .02 was therefore chosen. In order to determine where this .02 condenser would place the resonant frequency, .02 was substituted for C in X_C and for 50 cycles the reactance was found to be 159,000 ohms. Again using the easy method for finding the reactance at the multiples of 50 cycles, it is necessary to *divide* by the simple multiple, the reason being that a capacitive reactance is an inverse proportion to the frequency; in other words the higher the frequency the less opposition the condenser offers to the alternating current. Combining the figures with those of Table I, a new table is then compiled, as follows:

TABLE II

X_L in Ohms	f in C.P.S.	X_C in Ohms
282.5	50	159,000
565	100	79,500
1130	200	39,750
2825	500	15,000
5650	1000	7,950
11300	2000	3,975
28250	5000	1,590

A close observation of Table II shows that at some point between 1000 and 2000 the two reactances are equal; 1200 cycles was tried for both X_L and X_C , with the result that X_L was 6780 and X_C 6650. Apparently 1200 cycles was too high a frequency and 1150 was then tried, with X_L turning out as 6500

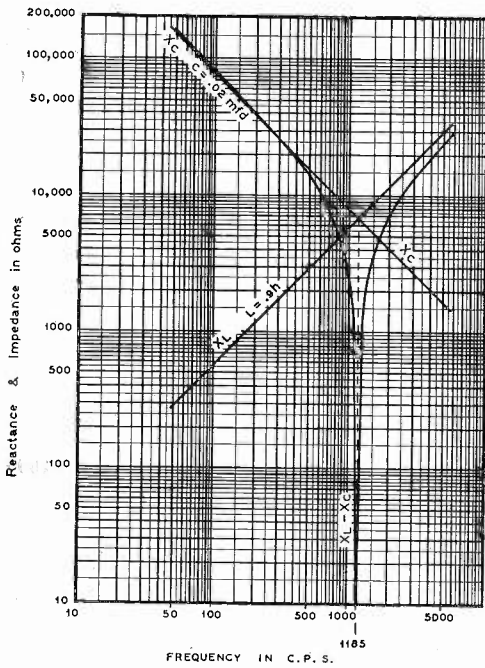

FIG. 1

and X_C 6920, a bit on the lower side. Therefore it was decided to take a chance on 1185 cycles, and X_L equalled 6700, and, fortunately, X_C then equalled 6700. Resonance for this particular combination is 1185 cycles, which is a very nice signal frequency for copying. An easier method would have been the use of logarithmic paper, plotting two points and 5000 for each reactance, then by drawing two lines and their intersection (being the only common point to them) would indicate the resonant frequency, as was done in Fig. 1. However, the interesting lines do not give a very good picture of the resonant curve, and thus by subtracting the X_C values from X_L of Table II, disregarding the minus signs—which merely indicate the predominating type of reactance—and plotting the new figure, a very nice resonant curve will result. It must be remembered that the curve as shown is the actual impedance curve, taking into consideration the 10-ohms of the choke. It is seen that by subtracting 6700 from 6700 the result is zero.

Now that all this mathematical data has been given, the reader will wonder what use he can make of the simple peaker audio filter. Recalling that the frequency of 1185 cycles is "a nice note to copy," it can readily be seen that use can be made of it at once—by placing the filter in the audio circuit of the receiver. Referring again to Table II it is seen that the reactance to frequencies of from 50 to 500 is quite high, and here your

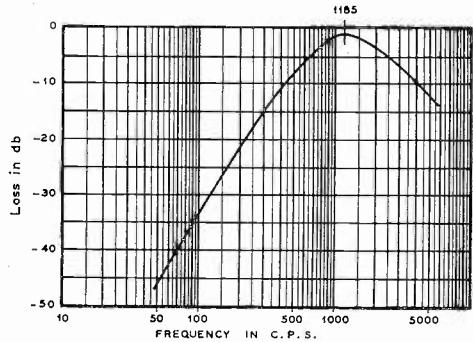

FIG. 2

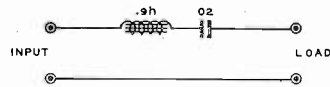
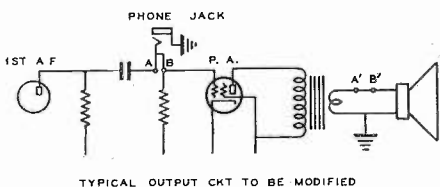

FIG. 3

enthusiasm can rise, because these are the most offensive frequencies to copy from the standpoint of a c.w. signal, and also from all sorts of noises from razors, autos, hum, etc., together with beats of other interfering signals close to the one which is to be copied.

After putting the circuit to a test at the headphone jack for the input and using the headphones as the load, an exasperating feeling is experienced—for the ear does not detect a cut-off of unwanted frequencies, as was expected. After applying a bit of logic to see just why no cut-off was noted, it is then plainly evident (after looking over the curves) that the impedance offered to those frequencies which are to be eliminated is very nearly equal to the impedance of the headphones in use. If this is the case, it can be seen that the current is being divided equally between the filter and the headphones, hence the voltage ratio is only one-half its original value, which is a drop of slightly less than 1 db. The human ear cannot detect a change of 3 db, and hence there is not a great enough ratio between the filter impedance and the load impedance. Referring to the impedance curve of Fig. 1, it will be seen that the impedance between 50 and 500 cycles varies from 160,000 to approximately 15,000 with an average of 82,000, in round numbers. Since the impedance as resonance was 10-ohms, the ratio of 82,000-to-10 is in the vicinity of 75 db, and the result is "silence." It is suddenly recalled that the voice coil winding of the output transformer is approximately 10 ohms. Consequently, with the filter inserted there, and with a 10-ohm load obtained from another output transformer with the 10-ohm winding



TYPICAL OUTPUT CKT TO BE MODIFIED

PROCEDURE: UNSOLDER A & B FROM JACK AND CONNECT TOGETHER. CUT UNGROUNDED SPEAKER LEAD AT A' B'. CONNECT TIP OF JACK TO A' AND SPRING OF JACK TO B'. RESULTING CKT IS SHOWN BELOW.

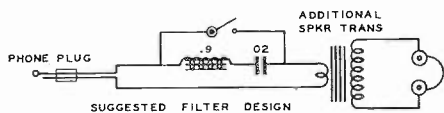
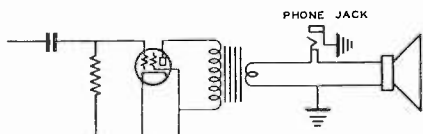

FIG. 4

connected to the filter, and the headphones across the high impedance winding, an approach to a good impedance match is had—at least at the resonant frequency—which is the one desired to give the loudest signal. *The net result is a large mismatch at all other frequencies of unwanted signals.*

You may be horrified at so high a level of power going into the headphones, but the writer has yet to find a time when he had too great a signal strength on some weak signal from a good DX station. For local communication it is merely necessary to cut down on the volume control.

Fig. 2 shows the actual response curve measured with a transmission set at the writer's disposal. Proper matching transformers were not readily at hand, else the losses would have been found to be greater. Also, the measuring set could not measure below -40 db, but this does not give a fair confirmation of the expected results. The loss was 0.7 db, mostly caused by mismatch to the set, and indicated resonance at 1200 cycles, probably due to the uncertain values of inductance and capacity—but there is no need to worry when a matter of only 15 cycles is involved.

The filter was put into operation by re-wiring the headphone jack on the receiver, and a switch is installed so as to short-out the filter when listening to 'phone conversation.

Fig. 3 shows the simple filter connection, and Fig. 4 shows a typical low-priced ama-

teur receiver output circuit and its modification for the filter application. It remains for the individual experimenter to select his own wiring arrangement, but the suggested method is by far the most simple, unless the filter is to be wired into the circuit so that it can be used both for loudspeaker and headphone reception.

New Tubes

RCA is making available the following new tubes:

- RCA 6SG7—Triple-Grid, Super-Control Amplifiers
- RCA 12SG7—Triple-Grid, Super-Control Amplifiers
- RCA 930—Gas Phototube

- The 6SG7 and 12SG7 are r-f amplifier pentodes of the metal type particularly recommended for use in high-frequency receivers. They feature high transconductance, very low grid-plate capacitance, and two separate cathode terminals. Because of these features, the 6SG7 and 12SG7 offer receiver engineers new facilities for improving the stage gain of receivers, particularly those designed for high-frequency and/or wide-band operation. At higher frequencies, the use of two cathode terminals permits of greater isolation of input and output circuits through elimination of the coupling inductance of a common cathode return. As a result, the input conductance can be maintained at a high value at high frequencies. The low value of grid-plate capacitance minimizes regenerative effects, while the high transconductance makes possible a high signal-to-noise ratio. Furthermore, the single-ended metal construction with its self-shielding shell and short internal leads is a practical consideration in obtaining high gain with stability.

- The 6SG7 and 12SG7 are alike except for heater rating. The heater of the 6SG7 is designed so that it can be operated in series with other 6.3-volt, 0.3-ampere types; likewise, the heater of the 12SG7 can be operated in series with other 12.6-volt, 0.15-ampere types.

- The new gas phototube, RCA 930, is recommended for use in sound reproduction and relay applications. Electrically, the 930 is like the type 923 with its high sensitivity and large response to red and near infra-red radiation. Physically, the 930 is like the type 929 with its simple, rugged, short construction and octal base. This combination makes the RCA 930 an outstanding phototube of particular interest to designers of new equipment utilizing phototubes.

* * *

Motor-Starting Capacitor Manual

REplete with practical application data, in addition to handy listings of electrolytic and oil motor-starting capacitors, the new 1941 edition of the Aerovox Industrial Capacitors Manual should be in the working library of every man engaged in servicing refrigerators and fractional horsepower motors utilizing capacitors. For the first time this edition introduces a numerical cross-section of Aerovox types with such data as A.C. voltage, actual range, nominal range, dimensions, illustrations, list price, and corresponding parts nos. of motor manufacturers. The alphabetical listings of motor types and their capacitor requirements, are more extensive than ever before. A copy of the manual is obtainable from the local jobber, or from Aerovox Corporation, New Bedford, Mass., on request.



Heard Only On 160

By Phillip Space

THERE'S something about 160 meters that keeps a ham glued to his microphone hour after hour, day after day, year after year. The familiar CQs of Clarence and Percival are known to every neighbor within a radius of five square blocks, and to a few hams as far as ten miles away, in some cases. Clarence and Percival do their telegraphing by mouth, rather than by hand, because if they used a telegraph key they fear they would be accused of sabotaging the amateur bands. This 160 meter business intrigued me, so I made it my business to interview Clarence and Percival in order to learn what makes this band so popular. It didn't take long to get the inside dope.

I first met Clarence. He has a fine station. He's an old-timer—been in ham radio seven months, he says. Flunked his ham examination nine times in a row, and finally passed the code test after so many trials that he remembered by heart every dot and dash on every piece of tape on the Radio Inspector's code sending machine. The man is smart. He has a real antenna; he reels it in every morning before the neighbors get up. It is a top-loaded affair, and from the angle of his antenna pole it was evident that something was loaded entirely too much. Clarence proved to be quite an interesting fellow. My interview revealed that he held to the belief that 160 meters was discovered in the dark ages by a man who thought he was working on 10 meters, only to realize he was on 160 after the pink slips came through for transmission of superfluous signals. It seems that he wound too many turns of wire on a too-large coil form, and he didn't want to admit that he bought too much wire in the first place. I asked him how a good tank circuit for 160 meters can be designed and he told me the easiest way to get on the band is to wrap a few dozen turns of heavy wire around a small beer barrel, use the spigot for a neutralizing condenser, and the beer in the barrel for a counterpoise. Anything works on 160, he says, and I began to

believe him after looking over his deluxe equipment. His friend Percival, who lives across the street, is on 160 meters also. He got on the band by winding too many turns of wire on a coil, glued the wire down so tightly that he couldn't remove it, and stayed on 160 because it was easier to do this than to remove some wire from the coil. The trouble-shooter from the Telephone Company still drops in on Percival to inquire if he has found a misplaced F-1 microphone unit in the neighborhood, but Percival is a truthful lad, and always gives the same answer to the Telephone Man. He tells me that when the Telephone people begin to use telegraph keys instead of microphones, he hopes to be able to get on c.w. for a change.

Clarence took me across the street to meet Percival. He had a better technical knowledge of radio than Clarence. I found out that it isn't necessary to neutralize a circuit on 160 meters because there are so many stray capacities floating around the



So many networks are being started on 160 meters that it will pay some enterprising stationery dealer to open a "Network Supply Store."

transmitter that they neutralize themselves. But Percival had a telegraph key nailed to his desk, and my curiosity became aroused. Quickly I inquired why a telegraph key in a 'phone station, and right back at me comes Percival with the correct technical answer, telling me that he uses the key to switch the a.c. power line on and off.

I took a squint at the tube in his final amplifier. It was so big that I felt sure he borrowed it from some nearby broadcasting station. I asked him if they gave him the tube because it was flat, and Percival told me to be myself, because anybody could see the tube was round. Not wanting to profess too much technical ignorance, I asked him why he put his tank condenser inside of the tank coil. He made me blush when he told me that this proved a sure cure for circulating tank currents, and cut down QRM in the neighborhood, because he still gets R9 signal reports from Clarence across the street. Clarence nodded in consent. Then Percival gave me a demonstration of 160 meter operation at its best. First, he wound the alarm clock, to make sure it would ring after the 647th CQ has been bellowed into the microphone. I put the cans on my head to listen in on his monitor. The stuff sounded something like this: Seek You,

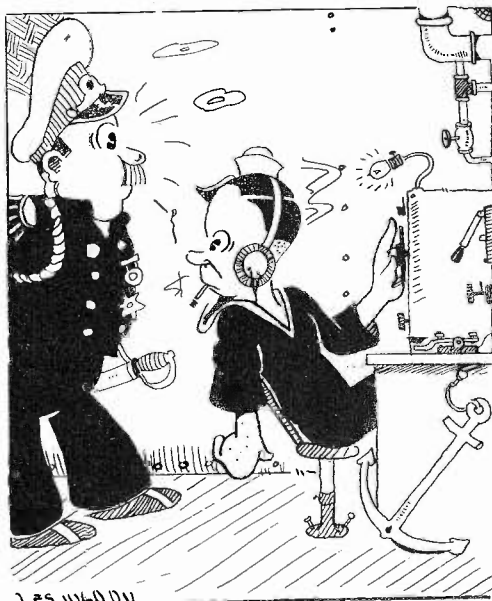

LES W6Q00

Captain: "Get to your battle station at once."

Ham Reservist: "I'm already there, Sir, I'm on 160 meters."

Seek You, Seek You, 160 meters—than a goshawful whine, whistle, blurb and squeak. It nearly tore the cans off my head. What in blazes could that awful noise be, I asked Percival. He gave me a disgusted look and said the noises were from some stray capacities which had finally found their correct hide-out in the circuit, and were so tickled that they began to whistle with delight. Clarence looked at me with a puzzled frown, but I recalled that Percival was the technical expert on 160, and he ought to know his stuff.

While Percival continued to call CQ-160, Clarence and I took a walk around the block to keep a sharp lookout for neighbors armed with sawed-off shotguns. We counted six of them within five minutes, and more were on the way.

Back into the shack, we found Percival nursing a bad r-f burn on his right hand. While trying to shut off the CQ alarm clock, he grabbed the tank condenser by mistake, and was cussing himself for forgetting to wear his heavy rubber gloves while calling CQ.

Now that the CQ calling was over, we sat in front of the receiver to await the results. Percival has a Super Splatter Spreader Model No. 84½. I noticed that he didn't move the dial, and still the signals came through. It didn't take long to learn that he had an all-band receiver—you'd hear the



It would be cheaper (and faster) to use the telephone, rather than the 160-meter band, but it isn't half as much fun.

same signal on all bands simultaneously, which is a real convenience in tuning, Percival says.

The first signal we heard was from the Control Station of Network No. 374, just placed into service to compete with Network No. 373. The control station was calling all network members with a radius of nine blocks. Urgent priority traffic was on the hook. It had been hanging there for a week, and was becoming more urgent than ever. Anybody who would interfere with this traffic would be reported to all Radio Inspectors in all amateur call areas and points south. Percival was shaking in his boots, because he was afraid of the big shot control operator who directs the affairs of the "Get Off This Frequency Net." So Percival wanted to get on the right side of the big shot, and came back at his priority CQ with a request to give him the traffic. It certainly was priority stuff, and how—the first message from a YL to her YM, demanding to know why he didn't meet her in front of the beer parlor. Percival says he would get a quick reply to the message, and ran right down to the place to find that both the YL and the YM had been pinched a week ago, and hadn't been bailed out yet.

Much important traffic is handled on 160 by Network No. 842, Clarence stated. It is not in competition with the Crab Net and

the Hair Net, but gives better service by guaranteeing delivery of all traffic before the ink fades from the message blanks. Percival had a bunch of traffic nailed on the wall, and he showed me some of the stuff. The first message read: DEAR HUBBY STOP HAVING GREAT TIME STOP SEND MORE FUNDS DONT STOP. SIGNED YOURS ALONE.

I noticed that the message check was 63 words, but I counted only 15, so I asked Percival what happened to the other 48 words, and he told me he ran out of paper and put the rest of the message on his shirt sleeve, and then his O.W. sent the shirt to the laundry.

I was completely sold on the service rendered by the networks, so I asked Clarence to take me to his shack so I could hear how Percival's signals sounded. Listening to Percival's voice, I asked Clarence how he was able to distinguish a vowel from a growl, and he told me that when he misses parts of the conversation he merely walks across the street to get the dope in person from Percival. Clarence had an ingenious technical innovation in his own transmitter. He had the final r-f tube connected up backwards. He told me he does this so he can talk back to Percival, without Percival hearing the conversation, otherwise Percival might get made at him!



Mister Q: "Well, Miss Match, I'm in the navy now. Won't be getting any pink slips for a whole year."

Miss Match: "I'd imagine they would look rather silly on you now."

QRM QRN

By LES FUNSTON WOORU





NEWS *from* WASHINGTON



Unlicensed Radio Operator Apprehended

FIELD inspectors of the Federal Communications Commission's Huntington, W. Va., office, acting in cooperation with the local United States Marshal, apprehended at Hubbell, that state, a youth who is alleged to have engaged in unlicensed broadcast which caused interference to authorized radio programs.

Using the non-existent call letters WBBQ, this offender transmitted entertainment that

"collided" with regular services. Amateurs, particularly, complained of the resultant interference.

The illegal station, which used a transmitter of approximately 25 watts and a steel vertical radiator, was located by means of the Commission's new direction finding equipment.

The operator has been charged with violation of Sections 301 and 318 of the Communications Act.

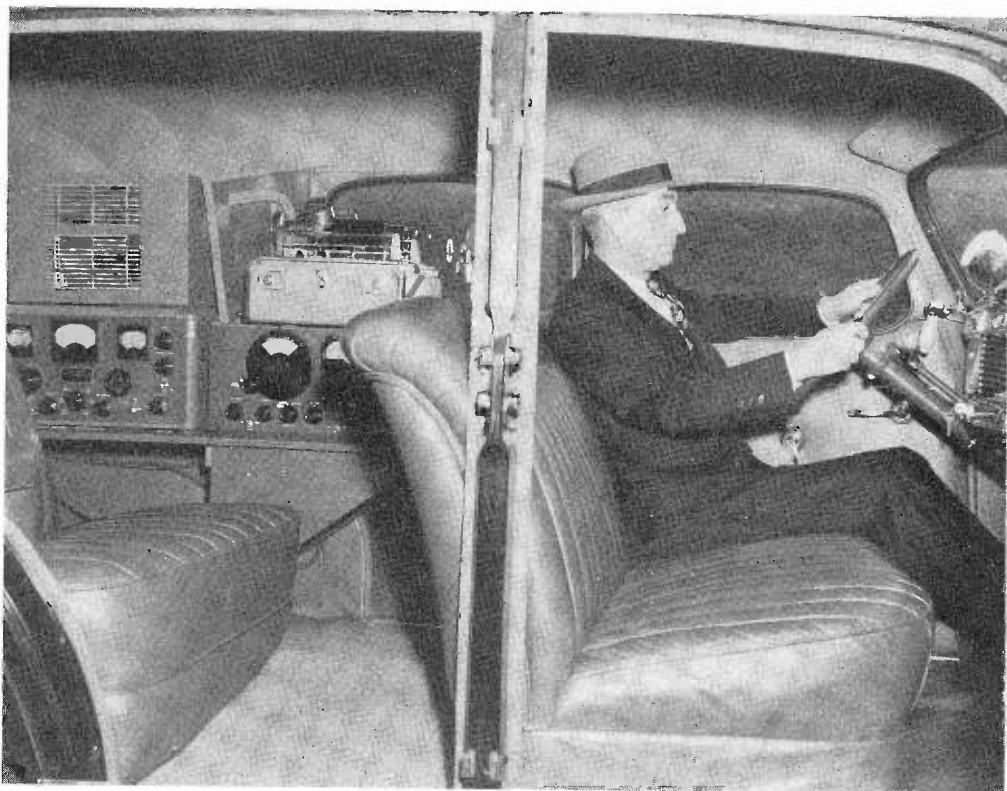

Traveling Radio Detective Ferrets Out Unlicensed Sending Stations with Hallicrafters Equipment

The fact that there are stations on the air without the proper authority has called for ingenious apparatus to aid the FCC in putting them out of commission. A radio monitoring officer is shown at the wheel of the car which carries Hallicrafters Equipment around on its detection tours. The apparatus can, by directional methods of converging lines, be worked out by moving from place to place, locate any "bootleg" station to within 100 yards. At the same time cylinders are used to record the broadcast. There are no identifying marks on the car.

It Once Was DX

By Stanley W. Johnson, W6SZ

... Flash! ... Amateurs of Southern Rhodesia on the air! ... That's right "on the air." Banded together under the name of the Auxiliary Defense Wireless Stations, A.D.W.S. for short, a competent group has formed a hard hitting defense unit for Southern Rhodesia. No helterskelter bouquet of lids, this association of oldtimers is highly qualified to handle traffic or any emergency which arises, and are at the present functioning under actual war conditions as an efficiently organized harmonious body, of serious minded men long skilled in the methods and the exacting requirements that make up a practical backbone for Home Defense Communications.

Well equipped with their own gear these chaps have thrown the full weight of their years of training and experience into the common cause of defending their homeland. The A.D.W.S. system is a carefully planned organization of well seasoned amateurs deployed over the five districts of Southern Rhodesia. The control of the system is located in a principal city, Bulawayo, with the individual stations allocated to the most advantageous spots for consistent and complete inter-station communication.

The A.D.W.S. is not a part of any of the regular pre-war Military Land, Sea, or Air Nets, but is a separate entity functioning as an independent, voluntary body of organized, intelligent, experienced, and loyal amateurs working as a Defense Unit in supplement to the Post Office and Military Communication Nets.

A minimum of required operating time is maintained and no midnight oil is wasted handling wads of traffic ... that is taken care of by the Military and P. O. organizations. Having already rendered valuable service this Amateur Home Defense Group has been paid the highest honors and I am informed that elsewhere in the Commonwealth and Dominions other groups are to be formed along similar lines. One of my friends in S. Rhodesia commented on our own ARDA and we quote, "Your ARDA will in emergency become automatically the VOICE and EARS of Home Defense for 130 million people spread over 3,613,189 square miles of W territory" ... WOW! are those ZE's sticklers for statistics! ...

... Another scoop on the vital place that Amateurs play under war conditions comes to me from England where one of the Bottle-necks, as you know, is the training of wireless operators for the Air Force. Two well known British Amateurs, G4PX and G4DH, decided that they were going to show the way that this problem could be solved and therefore founded an original "Homebrew" school for the training of recruits as Wireless Operators for the Air Force.

Working on their own time, resources, and Amateur equipment these two "Professor Hams" set about grabbing RAF recruits who had signed for service, but who were not as yet called up, and proceeded to pound their noggins' full of what it takes to ride herd as YRLESS Ops in a flying machine ... 1941 Model.

Impressed by the staggering figures of some 300 trained Radio Operators dropping off the 4PX 4DH "Living Room Assembly Line," the British Government has called for donations of all keys, buzzers, headphones, and other equipment that reposes in Ham junk boxes from the Orkney Islands to Plymouth. Training groups are springing up all over "G." and piloting the destinies of these future RAF pilots are the ordinary Amateurs just as you and I, greying



at the temples perhaps, but absolutely priceless in this "ALL OUT" Emergency.

* * *

... Wings Over the War Fronts ... To the former chief Op at ZB2B on the Rock of Gibraltar, Waddy Waddington, and Mrs. Waddy—our heartiest Congratulations on a VFB bouncing Junior Op. Also to our old friend and consistent R9Pluser of 20 meters, G3DO, Doug and Mrs. Edwards our congratulations on their blessed event which also is a VFB Junior Op.

* * *

... F8AY went through the harrowing nightmare that was Dunkirk, being evacuated in one of the small craft that rode the crests of bomb polluted waves for unending hours before being transferred to a larger vessel for passage to England. Jean is now on active duty in England with the Free French Forces. Between you and I, Jean has the Signal Corps Officer in his outfit becoming quite a 20-meter nut and figures he will have him breaking down and listening on the Ham bands any day now.

* * *

... I am in receipt of very good news for us all from my friend and that xdxr famous for the "Lady Godiva QSL Card," G6WX, Bill Malcolm, of COVENTRY. Bill in his letter of mid-February of this year tells me that he still is in the same old QTH and that though there is no question of our news reports in this country being correct about that phrase COVENTRYLIZE meaning to obliterate, he keenly sparks that indomitable will of all the "G's" in his own words. ... I am well. All that happens here only strengthens our determination; Buildings, Churches, Homes, and Men may fall, but our spirit, rises more and more with each bomb blast." Bill, instead of having a rifle on his shoulder, has that shoulder hitting the industrial wheel—and in no uncertain terms is contributing much to the war effort of industrial England.

* * *

... GM4DG, another oldtimer of the xdx lanes, is now doing his part as a Chief Radio Officer in His Majesty's Merchant Navy. Assigned to the Atlantic merchant fleet, this old Scot is having his share of close squeaks with everything the Jerries have been throwing at the convoys. Enemy subs, divebombers, warships; balloon barrages for protection and all are old stuff. In the middle of a convoy when an alert sounds for submarine off port bow, 4DG says the first chill that goes through you is like grabbing the final—unexpectedly ... it sure brings you up short.



Canadian Amateurs in England . . . This hamgathering photo taken by Miss Nellie Corry, G2YL, in Hants, England, introduces to our readers xdxers in the air service.
 First Row: **VE5ZM, VE3KE, VE3ATK, VE3AUB, VE3SC, G5AO, G6WY, VE3IM, VE3AMB.
 Second Row: VE3AYO, VE3JO, VE3APG, G8AY, VE3AAT, G15AJ, GM3CG, BR5WL, G6ZO.

. . . The THREE MUSKETEERS of British Columbia, the Wadsworth brothers, Barney, Bill, and Ed, are all in the service. As reported in a previous issue through oversight Ed, (VE5-AAD) is not in England with Bill, (VE5ZM) and Barney, but is stationed in Canada. Known throughout the Ham bands for their sledgehammer sigs, 5AAD and 5ZM—both xdxers—were also known for their homemade three-legged wooden tower which supported their General Rotary Beam 125 feet up in the ether, and which had one thousand seven hundred and forty 3/8 inch bolts holding it together. Bill and Ed the two "TOP HANDS" of the tower project are still up in the air. Bill, 5ZM as Pilot Officer with the RAF in England, while Ed 5AAD is wireless Op. rating L.A.C., with the Royal Canadian Air Force in Canada. Barney is still on the ground, as he was when he held the guys to the tower . . . is with an Artillery Unit in England. Bill and Barney have been in England since their arrival with first contingent of Canadian Voluntary Reservists in December of 1939.

. . . Last August Bill, 5ZM, was commissioned a Pilot Officer in the RAF and transferred out of the RCAF. He spent some time in special work at the Loughborough College for the RAF. Was later transferred to North Weald in Essex for several months and here assumed special duties in Administrative and Staff work. It was here that Bill was in midst of real action flying night after night during the two months incessant bombing siege of this QTH by the Jerries. Excitement died out here as the attack shifted to other locations and Bill was transferred again, this time to Cranwell where he became both an instructor and a student. During his stay there, Bill crammed into the old grey matter an ordinary three-year University course in Advanced Engineering. A glutton for hard work as well as a tough customer in a Spitfire, Bill has more than earned his spurs with the RAF and is one of the leading Canadians with this branch of the Service. We are glad to call him a Brother Ham. **See group photo above for 5ZM.

. . . Barney won't talk until he gets his commission with his outfit, but I have a suspicion

that he is going to jar us loose from our hats with the news when he lets go.

. . . Last, but by no means least, good old 5AAD, Brother Ed, up in the land of the Aurora Borealis, has one foot on the ground at the Sea Plane base of the RCAF. Ed says he is keeping his hand in at the mike as well as at a key and that he sure is going to be able to rip off them thar dots and dashes come the conclusion. Still nursing the flame of Ham Radio in his bosom by flirting with the Rx's over the 10, 20, and 40 meter bands in odd moments, Ed says and we quote, "Keep the Old Ham Spirit alive for us, all the Ham's in the service are longing for the day when we can sit down at the old rig again and tie into a good old-fashioned RAGCHEW!" **NOTE: If any of our readers want to drop a line to Ed, Bill, or Barney they would appreciate it, as they haven't heard much from the old W Gang of late. . . . Address all mail c/o of the DX Editor.

(Continued on Page 63)



VE5AAD

ENGINEERING APPLICATIONS

EIMAC 75T TRIODE

- The Eimac 75T is a radiation-cooled triode with tantalum elements and a rugged thoriated tungsten filament. This tube will deliver high power output at relatively low plate voltage because of its low amplification constant and high transconductance.

- The 75T is unconditionally guaranteed against tube failures caused by gas released internally. In common with all types of transmitter tubes, care should be taken to avoid parasitic oscillations in r-f circuits, since these may cause grid burn-out as well as a waste of power at undesired frequencies.

- The plate is designed to operate at a cherry red color at its normal dissipation rating of 75 watts. A perceptible red color is noted at 25 watts. The color of the anode can be used as a tuning indicator for resonance and output loading as one becomes familiar with the operation of tantalum plates tubes. The 75T should be operated in a vertical position and with ample ventilation around the bulb and seals.

- The values of grid driving power listed under typical operating conditions are for the actual grid driving power consumed by the grid as well as the power lost in the grid-bias source. The latter is the I²R loss in grid-leak and cathode bias resistor, or charging loss in the case of fixed bias supply. The net grid driving power is dissipated as heat in the grid and is nearly constant over a wide band of frequencies. Due to circuit losses, impedance mismatching, radiation losses, etc., in the grid and driver circuits, the apparent power required may be several times that listed in the Tables. For example, a typical grid circuit may have an impedance of 2,000 ohms with no plate voltage applied to the amplifier, and 4,000 ohms with heavy antenna load and applied plate voltage. If the driver circuit has perfect regulation, the grid current will drop 50 per cent, and the driver power output would be halved, as far as grid driving power is concerned. Each tuned circuit has a loss of from 5 to 15 per cent of the power delivered to it. These factors, even at radio frequencies in the range of 5-mc. will cause the apparent driver plate circuit efficiency to be from 25 to 35 per cent as a buffer, and even less as a doubler. This means that if 10 watts of grid drive (including bias loss) is needed, the buffer may require from 30 to 40 watts input at relatively low radio frequencies. The input may have to be doubled for 30-mc. operation and tripled for 45-mc., due to added circuit losses and dielectric and radiation losses at the higher frequencies. The apparent overall plate input of a doubler stage for 30-mc. to useful grid driving power may be only 10 per cent in actual operation, and 15 per cent as a buffer. This is typical of any well balanced and neutralized r-f amplifier in which there is no regeneration or parasitic oscillation.

- A tentative rule for driver tube power input is to multiply the grid driving power figures in the Table by 3 for frequencies below 4-mc., by 4 for frequencies between 10- and 4-mc., by 6 for 30-mc., and by 9 for 45-mc. If the driver is operated as a frequency doubler these factors should be increased 50 per cent.

- The values for output shown in the Tables are for actual tube output, and not for power input into the antenna, or other load circuit.

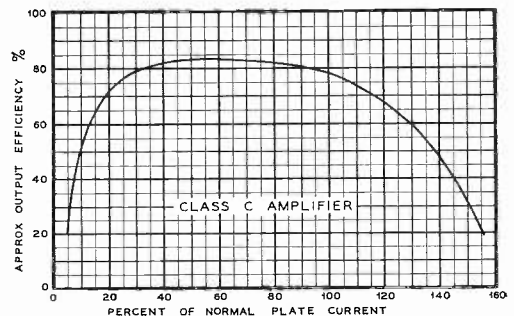
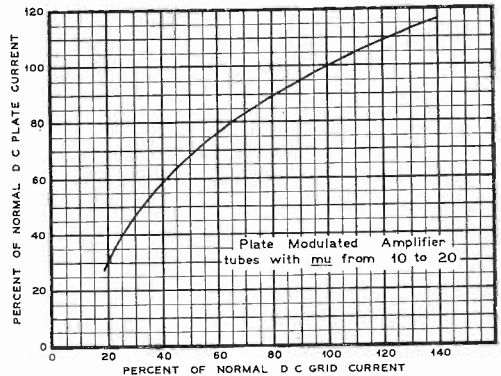

UHF and FM Service

- The very low interelectrode capacities and short connections to the grid and plate elements of the 75T result in good operation in the UHF region. At very high frequencies care should be taken to operate the tube within its rating of normal plate dissipation, as indicated by a cherry red color; likewise, overheating of the grid is indicated by bright or white-colored grid wires. Overheating can also take place in the grid or plate seals at the lead-through connection points. The seals can be cooled by affixing radiator connectors with cooling fins to the plate and grid leads, and by forced air ventilation if needed.

- The external plate circuit losses increase at very high frequencies, and a reduction in plate voltage or plate current may be necessary to avoid excessive plate dissipation. With properly designed high-Q circuits, operation at 50- and 100-mc. is comparable to that at low radio frequencies. The r-f current through the plate and grid seal leads will be greater in the UHF region, since the tube interelectrode capacities become a larger portion of the total circuit capacity and act as a tank condenser with correspondingly large values of circulating current. This effect, as well as the inductance of the grid and plate leads, may also cause neutralization difficulties in the UHF region. The short internal grid and plate leads tend to overcome this effect.

ENGINEERING APPLICATIONS

EIMAC 75T TRIODE (Cont'd)

• Grid driving power in the UHF region is approximately the same as at low frequencies, except for some increased r-f lead resistance and dielectric losses. The power consumed by the grid and grid-bias source will be the same; however, the circuit and radiation losses in the grid circuit and in the preceding driver plate circuit may require a driver stage with from 3 to 5 times as much input as would be needed at lower frequencies, such as at 3-mc., for example. Low-C parallel rod or concentric line resonant grid and plate circuits are desirable in order to develop the required values of peak r-f voltages needed for high efficiency operation. Low mu tubes are usually more difficult to drive in the UHF region, since high peak r-f voltage at low values of grid current is more difficult to obtain than low peak r-f voltage and high grid current needed for high-mu tubes.

Characteristics

Filament voltage	5 volts
Filament current	6.5 amperes
Amplification factor	10
Grid-plate capacity	2.3uuf.
Grid-filament capacity	2.2uuf.
Plate-filament capacity	0.3uuf.
Normal plate dissipation	75 watts
Base	Isolantite UX-4-prong
Grid lead diameter	0.060-in.
Plate lead diameter	0.070-in.
Overall height	7-in.
Maximum diameter	2 3/4-in.

MAXIMUM RATINGS

	Class-B A.F. or Telephony	Continuous Class-C Telephony	Frequency Modulation
Plate dissipation (watts)	75	75	75
Plate current (ma)	225	175	175
Plate voltage	3000	3000	3000
Grid current	35	30	30

The normal plate dissipation of 75 watts may limit the applied values of plate voltage or current to values lower than those listed, since the plate circuit efficiency (and plate dissipation) depend upon circuit and load adjustments.

FCC RATINGS

Power output High Level Modulation	100 watts
Power output Linear Amplifier	25 watts

TYPICAL OPERATION DATA PLATE MODULATED OR C.W. CLASS-C AMPLIFIER

	750	1,000	1,500	2,000
DC plate voltage	750	1,000	1,500	2,000
DC plate current (ma)	125	160	175	175
DC grid voltage	-150	-200	-300	-400
DC grid current (ma)	30	30	30	30
Grid driving power (watts)	10.5	12	16	20
DC power input (watts)	94	160	262	350
Plate dissipation (watts)	33	48	66	70
Plate efficiency (pct.)	65	70	75	80
Approx. carrier output (watts)	61	112	197	280

CLASS-C AMPLIFIER, C.W. OPERATION ONLY

	750	1,000	1,250	1,500	2,000	3,000
DC plate voltage	750	1,000	1,250	1,500	2,000	3,000
DC plate current	175	200	225	200	200	125
DC grid voltage	-100	-150	-175	-200	-300	-450
DC grid current	35	35	35	30	30	30
Grid driving power	10	13	15	12	16.5	22
Power input	131	200	280	300	350	375
Plate dissipation	51	60	70	75	70	75
Plate efficiency (pct.)	61	70	75	75	80	80
Approx. power output	80	140	210	225	280	300

ENGINEERING APPLICATIONS

CATHODE-MODULATED AMPLIFIER

DC plate voltage	750	1,000	1,000	1,500	1,500	2,000	2,000
DC plate current	75	100	120	113	140	90	150
DC grid voltage	-160	-200	-200	-300	-300	-450	-450
DC grid current	5	5	10	2	8	1.5	7
Grid driving power	1.2	1.5	4	1	3.2	1	4.5
Peak A-F grid voltage.....	100	125	170	165	190	200	225
Peak A-F cathode voltage ...	320	400	580	620	930	800	1,200
Avg. A-F power (sine wave)	12	20	35	35	65	36	90
DC power output	56	100	120	170	210	180	300
Plate dissipation	25	45	45	75	74	75	75
Plate efficiency (pct.)	55	55	62.5	56	65	58	65
Approx. carrier output	31	55	75	95	136	105	225
Cathode modulator load impedance.....	4,250	4,000	4,800	5,500	6,600	8,900	8,000

• Typical operating conditions are listed for a-f power to d.c. power input ratios of 20 and 30 per cent. The latter provides better linearity of modulation, as well as greater plate efficiencies and carrier output. For push-pull operation, currents will be doubled and CM impedance halved. For sine wave a-f voltage, the RMS values will be 0.707 times those listed in the tables.

VOICE COMMUNICATION GRID-MODULATED AMPLIFIER

DC plate voltage	750	1,000	1,250
DC plate current	60	75	90
DC grid voltage	-175	-175	-200
DC grid current	2.5	1.5	1.5
Approx. grid driving power	0.3	0.3	0.4
Peak A-F grid voltage	100	110	125
DC power input	45	75	112.5
Plate dissipation	31.5	50	73
Plate efficiency (pct.)	30	33	35
Approx. carrier output	13.5	25	40

• The grid circuit should be heavily loaded with a resistor in order to insure good regulation and a tendency for grid current reversal for any decrease in driver power output. The linearity and carrier shift characteristics are not as good as with high-level cathode or plate modulation.

CLASS-B AUDIO AMPLIFIER (2 TUBES)

DC plate voltage	750	1,000	1,250	1,500	2,000
Zero signal DC plate current	100	100	60	60	50
Max. signal DC plate current.....	350	350	320	280	240
DC grid bias	-40	-67.5	-110	-135	-190
Plate-to-plate load impedance	4,250	6,000	8,750	13,000	20,000
Approx. power output	145	200	250	275	325

The driver can be push-pull 2A3s with driver transformer pri. = 1:1.

½ sec.
Peak driving power approx. 12 watts.
DC grid bias can be adjusted to any value of zero signal d.c. plate current which is below the amount which will cause 75 watts of plate dissipation per tube.

FREQUENCY DOUBLER

DC plate voltage	750	1,000	1,000	1,500	1,500	2,000	2,000
DC plate current	133	110	125	100	110	82	100
DC grid voltage	-450	-600	-600	-750	-800	-1100	-1100
DC grid current	20	10	20	10	20	5	20
Grid driving power	13	8	17	10	22	6	25
DC power input	100	110	125	150	167	165	200
Plate dissipation	50	50	50	67	67	75	75
Plate efficiency (pct.)	50	55	60	55	60	55	62.5
Approx. output	50	60	75	83	100	90	125

ENGINEERING APPLICATIONS

OPERATION OF THE HK-54 AND HK-254 GAMMATRONS IN THE UHF REGION

• The Types HK-54 and HK-254 are well suited for operation in the UHF region from 30 to 200 megacycles as power amplifiers and frequency multipliers.

A unique combination of unusual constructional features makes possible this performance:

1. A totally enclosed plate and grid construction which confines all electrons to the useful space within the plate itself.
2. Short heavy plate and grid leads which keep the lead inductances low.
3. Low interelectrode capacities which simplify neutralization and further reduce the ill-effects of lead inductance.
4. The lack of internal insulation within the tube, which avoids the high losses which normally occur in such highly stressed insulating pieces at UHF.

Plate conversion efficiencies as power amplifiers on the order of 70% have been obtained at frequencies as high as 125 megacycles. Plate conversion efficiencies of 55 to 60% have been obtained in this region as single tube frequency doubler stages.

ELECTRICAL VALUES

• For service at these frequencies plate voltages from 1500 to 2000 volts are recommended. The following table indicates approximate value of plate current, bias, and grid leak resistors which are satisfactory to use:

Power Amplifier Unmodulated

(Values for two tubes)

	HK-54	HK-254	
Plate Volts.....	1500-2000	1500-2000	Volts
Plate Current.....	120	250	Ma.
Fixed Bias.....	150-200	150-200	Volts
Grid Leak.....	1500	1500	Ohms
Grid Current....	25	45	Ma.

Doubler, Tripler

(Values for 1 tube)

	HK-54	HK-254	
Plate Volts.....	1500-2000	1500-2000	Volts
Plate Current.....	50	80	Ma.
Fixed Bias.....	150-200	150-200	Volts
Grid Leak.....	50,000-75,000	50,000-75,000	Ohms
Grid Current....	6-8	6-8	Ma.

RESONANT CIRCUITS

• In order to obtain the results noted it is very essential that proper circuits be associated

with the tube. At ordinary frequencies the circuits need seldom be given much consideration except to attain the proper ratios of circulating energy to dissipated energy (loaded Q), and to tune over the desired frequency range. For operation in the UHF region it is necessary or desirable to observe the following additional points:

1. The circuits should be balanced to ground, as in push-pull circuits, in order to reduce radiation and magnetically coupled losses.
2. Tube leads and connecting leads should be short, with ample surface area of good conducting material. This is necessary because the reactance of the inductance per unit length of the lead is very high, and because most leads carry high charging currents. Avoid stranded leads.
3. Circuits with low ohmic losses are necessary because the stored energy in the circuit is inherently higher than necessary.
4. Insulator losses rise rapidly with frequency and only a minimum of good ceramic insulation should be used.
5. Because the reactances of all incidental capacitances are low and the reactances of all mutual inductances are high, the proximity of metal shelves, shields, and cabinets makes it necessary to consider their possible effect on the circuit. Care must be taken to bond all such pieces or assure solid contact wherever such pieces come together. Such pieces should have good conducting surfaces also to minimize the losses incidental to carrying the induced currents. Variations of contact which may shift the path of the current in these pieces only a matter of inches may have considerable reaction on the stability of the operating circuits.
6. Possible resonant circuits in the framework and shields should be avoided.
7. It is often advisable to think of the circulating energy associated with the UHF circuit as stored in the field near the line circuits, and of the field confined by the presence of the circuit itself and limited in extent by the stage compartment.
8. Balanced excitation of PA tubes can be obtained by floating the grid circuit, and making the grid leak the sole connection to the grid circuit midpoint.

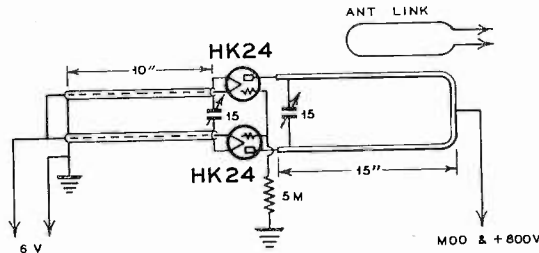

The push-pull HK-24 Gammatron tubes have parallel-tuned plate and filament circuits in the diagram above. The oscillator is of standard design. The plate tuning condenser can be made from a pair of aluminum disks, 1 1/2- to 2 1/2-in. dia. The spacing can be adjusted by securing the disks to machine screws which fit through the sides of the parallel rods in the plate circuit. The filament tuning condenser can be a single-spaced midget variable.

OPERATION OF THE HK-54 AND HK-254 GAMMATRONS IN THE UHF REGION

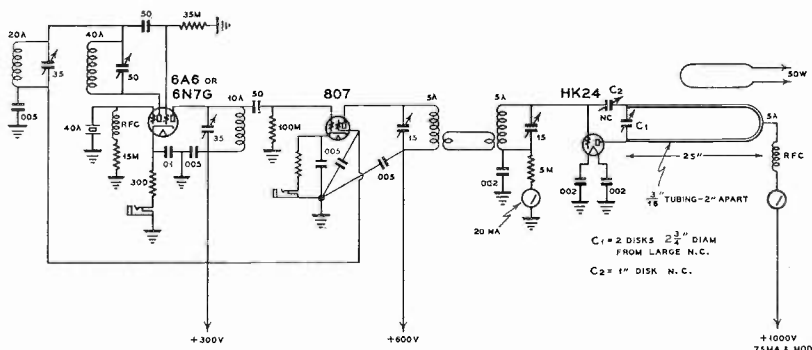

Another Gammatron tube well suited for operation in the ultra-high region is the type HK-24, the smallest tube in the Heintz and Kaufman line. A conventional uhf circuit, whose output is on 5-meters, is diagrammed above. The Jones Dual-Triode Harmonic Oscillator delivers output on 10-meters, when a 40-meter crystal is in service. Although the oscillator output is quite low, it is nevertheless ample to drive the grid circuit of the 807 stage as a doubler to 5-meters. The doubler is link-coupled to the single-ended HK-24 final r-f amplifier, also on 5-meters, and capable of delivering 50-watts of power into the antenna. Relatively low plate potentials are used through this transmitter and consequently it can be built for a reasonable cost. The tuning condenser shunted across the hair-pin plate-rod assembly can be a conventional neutralizing-type condenser with disks $2\frac{3}{4}$ -in. diameter, and the neutralizing condenser proper for the circuit shown can be of the standard midget type with 1-in. disks. Extreme care should be exercised in the mechanical design of the transmitter to make certain that the r-f leads are short and direct. The same precautions which apply to the HK-54 and HK-254, as related in the text below, hold true for the HK-24 in the circuit above.

NEUTRALIZATION

Conventional cross-connected neutralizing circuits for the push-pull amplifiers are satisfactory. However, the circuit must usually be arranged so that the connections to the neutralizing condensers as well as to the tube are short and of low inductance. This is necessary because both the plate and grid resonant circuits, when viewed as sections of transmission lines loaded with the fixed capacities of tube and neutralizing condensers, actually extend in physical dimension out to the dielectric region of the neutralizing condensers. It is usually difficult to attain sufficient physical length of circuit away from the tubes, and for this reason, one usually wishes to waste as little as possible of this length in the neutralizing leads.

Because of the mutual inductive coupling between plate and grid circuits by virtue of the charging currents flowing in the tube and neutralizing leads, it is usually of little value to introduce shielding between the grid and plate circuits.

The grid lead of the tube from the point of juncture of the neutralizing lead and grid circuit proper of the grid element of the tube itself represents an appreciable inductive reactance. The presence of the inductive reactance at this point in the circuit results in a regenerative feedback which is difficult to compensate for by throwing off the neutralizing condensers. It is sometimes desirable to series tune out this inductance.

It is not necessary to tune out the inductance of the filament leads. Simple bypass condensers

to the metal shelf will suffice. Tuning of the filament is not necessary because of the low tube capacities, and especially the filament to plate capacity which is unusually low in the GAMMATRON construction.

Practical elimination of parasitic oscillations is possible using the above technique and that of the usual considerations in the elimination of parasitics in ordinary circuits. It is sometimes possible to discover a very weak parasitic oscillation with both input and output circuits detuned considerably. Such an oscillation in a properly neutralized amplifier at these frequencies is inherent in the electronic action but seldom, if ever, will appear under normal operating conditions.

FREQUENCY MULTIPLICATION

The use of the HK-54 and HK-254 to double or triple in the UHF region is governed by the same circuit considerations as noted above. It is desirable to make a balanced plate circuit even in the case of single tube operation. It is desirable in attaining good tube efficiency to neutralize very crudely the feedback of the harmonic energy from the plate to grid circuit. If this is done in the single tube case, a balanced plate circuit will inherently result also.

The essential difference between power amplifier and doubler or tripler operation is that the latter cases require very high grid leak values in order to operate at the high efficiencies noted. Otherwise all the circuit comments made for the power amplifier apply with equal force to the frequency multiplier stages.

ENGINEERING APPLICATIONS

MEASURING DISTORTION IN AUDIO-FREQUENCY AMPLIFIERS

By the Engineering Department, Aerovox Corporation

THE simplest qualitative test for distortion in a Class A audio-frequency amplifier stage may be made, as shown in Figure 1, by applying a signal voltage of proper level to the

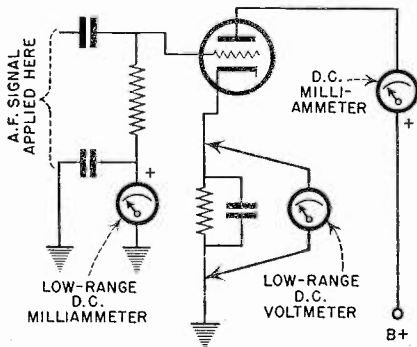

— SIMPLE AMPLIFIER STAGE WITH METERS FOR DETECTING DISTORTION —

Fig. 1

input and inspecting the circuit for one or all of the following abnormal conditions:

- Presence of d.c. grid current,
- Fluctuation of the d.c. plate current,
- Fluctuation of the d.c. cathode voltage, if the circuit employs cathode resistor bias.

Each of these indications generally occurs in a positive direction, and each will disappear upon removal of the signal. It must be borne in mind, however, that this method is purely rudimentary in nature and serves only to detect the presence of distortion. One or two of the indications may be absent, depending upon the main cause of the trouble.

The three simple indications are well known and frequently used by servicemen and P.A. testers who have no equipment suitable for making quantitative distortion measurements, but must, in the course of routine testing, localize distortion without reference to the actual per cent harmonic energy present.

The cathode circuit effects noted above are due to fluctuations in the voltage drop across the cathode resistor, occasioned by variations in the d.c. component of plate current. The current indicated by the plate-circuit milliammeter is the average value of the fluctuating "signal" plate current, is identical with the d.c. component, and is the current that produces the cathode resistor drop. These facts may be better comprehended when it is remembered

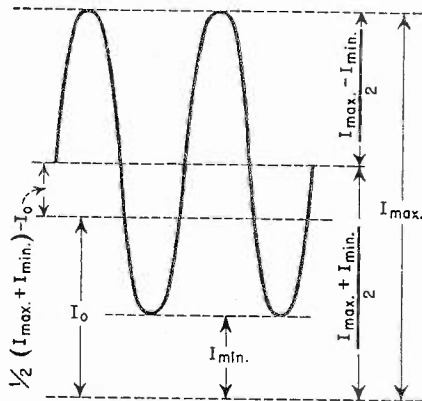

Fig. 2

that fluctuating signal plate current (Figure 2) is an alternating current, corresponding to the signal, superimposed upon a direct current. It will be evident from the fundamental relations of this combination that the average value of plate current, as indicated by the plate-circuit milliammeter, will be constant in the company of the alternating component under distortionless operating conditions.

Figure 2 is a graphical representation of signal plate current. I_{max} is the maximum value reached by the fluctuating plate current; I_0 , the zero-signal value; I_{min} , the minimum value. From these values, it may be shown that the per cent second-harmonic content (often the most troublesome distortion factor) is equal to:

$$\frac{\frac{1}{2} (I_{max.} + I_{min.}) - I_0}{I_{max.} - I_{min.}} \times 100$$

Quantitative methods of checking distortion are harmonic analyses, and are concerned with measurement of the actual amount of energy present in each separate harmonic of the signal frequency (or in the total harmonic content) and establishment of percentages with respect to the fundamental frequency. The most representative methods employed in wave analysis and the apparatus necessary thereto will be described presently.

OSCILLOSCOPIC METHOD

- The cathode ray oscilloscope is notably useful in the observation of wave shapes. When the horizontal plates of the ray tube are en-

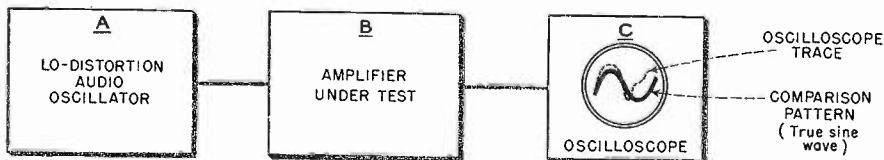

Fig. 3

MEASURING DISTORTION IN AUDIO-FREQUENCY AMPLIFIERS—Continued

energized by a saw-tooth wave sweep-oscillator-amplifier circuit to furnish the linear time base, and a signal voltage which it is desired to observe is applied to the vertical plates through a substantially flat-response amplifier, the cathode ray trace will be an exact reproduction of the applied signal voltage.

An audio-frequency amplifier may be checked for distortion with the oscilloscope in the manner illustrated in Figure 3. A is an audio oscillator possessing an output voltage wave form of known purity, B is the amplifier under test, and C is an oscilloscope having horizontal and vertical amplifiers with substantially flat fre-

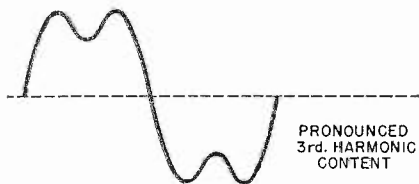

Fig. 4

quency responses. The units are connected in the order shown.

It is the purpose of the oscillator to supply a signal of as pure wave form as practicable to the amplifier, and that of the oscilloscope to reproduce the wave shape of the signal after it has passed through the amplifier. In order that as little distortion as possible be introduced by the instruments themselves, the oscillator used for such a test must be of exceptionally high quality and the amplifiers in the oscilloscope must possess an excellent frequency characteristic. Likewise, the oscilloscope sweep circuit must be uncompromisingly linear in its characteristic.

If the amplifier had no distortion at all, the signal it delivered to the oscilloscope would be an exact reproduction of the input signal wave form. This is never encountered in practice, however, the most efficient amplifier arrangement being beset with the distortion characteristics of its tubes and other components.

For observations, a perfect sine wave (or, better still, a tracing of a single cycle from the test oscillator) might be inscribed on the transparent viewing screen of the oscilloscope, and signals from the amplifier matched to this pattern to discover variations from the original shape due to amplifier distortion. In making such a test, it would of course be necessary to adjust both oscilloscope amplifier gain controls in such manner that the maximum amplitude and width of the signal trace coincided with those dimensions of the inscribed pattern.

With the low percentages encountered with most well-designed amplifying equipment, it will be difficult to estimate the percentage of harmonic content from the reproduced wave shape, in the oscilloscopic method, unless the operator makes use of the transparent screens furnished by some oscilloscope manufacturers for the purpose. These screens carry printed patterns of single cycles corresponding to the shapes obtained (variations from true sinusoidal) with various low percentages of distortion. Severe cases would result in images similar to Figure 4 which is an exaggerated representation of pronounced third-harmonic content.

FREQUENCY BRIDGES

• Certain bridge circuits, notably the Wien bridge (see Figure 5) can be used for the identification of frequencies in the audio-frequency spectrum. If an alternating voltage is delivered to the bridge circuit, the latter may be adjusted for a null at that particular signal frequency. The null point would not hold for the same voltage of another frequency. Thus, the adjustable element of the bridge might be calibrated to read directly in cycles per second.

The Wien bridge in its most useful form for this purpose would have its constants so chosen that the ratio arm, R_3 is twice the ohmic value of R_1 , the condensers C_1 and C_2 are equal in capacitance, and the two simultaneously adjustable resistance legs, R_3 and R_4 are at all positions equal. Under these conditions, the fre-

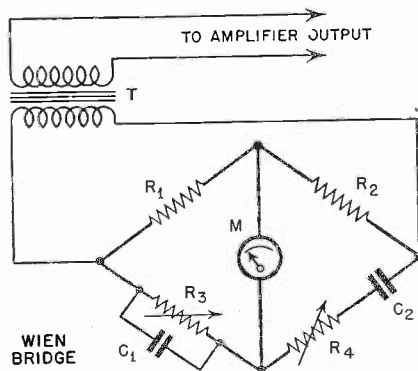

Fig. 5

quency of the impressed voltage at null would be equal to:

$$\frac{1}{2\pi RC}$$

Where:

- Frequency is in cycles per second,
- R is the resistance of R_3 or R_4 in ohms,
- C is the capacitance of C_1 or C_2 in farads.

Since the bridge may be balanced for only one frequency at a time, it would appear that any residual voltage indicated by the vacuum-tube voltmeter, M at null would be due to some other frequency or frequencies (such as harmonics of the fundamental). And this harmonic voltage would be due to the total of harmonic voltages present. As such, the bridge might be connected, as shown in Figure 5, to the output circuit of an audio-frequency amplifier which is passing a signal from a high-quality audio oscillator.

While the device might be used as shown as such a harmonic totalizer, the percentage total harmonic content with respect to the readings of the meter before and after null would not be reliable, nor would its error be uniform for all frequencies. These facts are due to the peculiar nature of the bridge to attenuate various harmonics unequally.

MEASURING DISTORTION IN AUDIO-FREQUENCY AMPLIFIERS—Continued

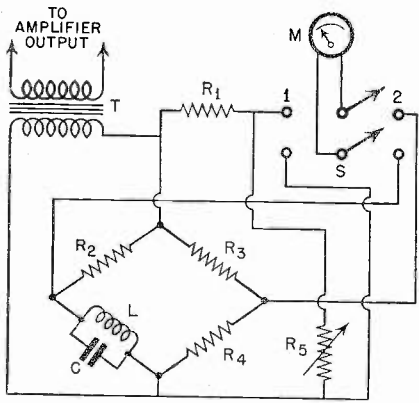

Fig. 6

Another popular type of bridge harmonic totalizer (due to UTC) is shown in Figure 6. Here, three legs of the bridge, R_2 , R_3 , and R_4 , contain pure resistance, while the fourth leg contains the shielded parallel resonant circuit, LC which is resonant at the test frequency. The transformer, T, like the one shown in the bridge previously described, must have an excellent frequency characteristic.

At resonant frequency of LC, the inductive reactance of the tuned circuit equals the capacitive reactance, the former is cancelled by the latter, and the bridge balances as if all four legs were pure resistance. Any voltage applied by the circuit to the vacuum-tube voltmeter is then due to harmonics of the test frequency (and it is assumed that these harmonics have been delivered to the bridge by the amplifier under measurement).

In operation, the double-pole, double-throw switch, S is thrown to position 2 and the bridge balanced with the assistance of the vacuum-tube voltmeter, M as a null indicator. The reading at null (due to harmonics) is recorded. The switch is then thrown to position 1 and R_5 is adjusted until the meter gives the same reading (as before at null). The following calculation may be performed to determine the per cent of total harmonics from this operation:

$$\% H = \frac{R_5}{R_4 + R_5} \times 100$$

or:
A dial indicator attached to the potentiometer R_5 may be calibrated directly in these percentages.

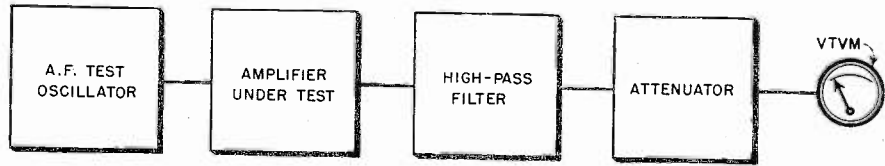

Fig. 7

FILTER-METER

- A very efficient method of measuring total harmonic content in the signal delivered by an audio-frequency amplifier makes use of the arrangement employed in the distortion and noise meters found in broadcast stations. (See Figure 7).

In this arrangement, the signal from a high-quality sine-wave audio test oscillator is fed into the amplifier under test. The amplifier output is connected to a high-pass filter which removes the test frequency but leaves all of its harmonics.

The actual voltage due to the harmonics is then measured by means of an attenuator and vacuum-tube voltmeter. This measurement is one of total harmonic distortion, but it is entirely possible to arrange additional flat-response amplification with various high-pass filters to remove the various harmonics singly along with the fundamental.

WAVE ANALYZER

- The wave analyzer, a highly-developed and refined form of heterodyne vacuum-tube voltmeter, provides the most advanced, accurate, and complete means of measuring amplifier distortion by determining the various harmonic voltage magnitudes. The instrument is tunable to the fundamental and any of a series of its harmonics separately, so that wave forms of considerable complexity may be investigated. At the same time, measurements of hum and noise amplitude are made available. In effect it is a highly selective electronic voltmeter.

The representative wave analyzer (General Radio) receives the signal to be inspected through an input channel embracing an input multiplier, amplifier, and pad. The frequencies accepted by the input channel lie in the range 20 to 16,000 cycles per second—the entire common audio-frequency spectrum. A local heterodyne oscillator stage supplies heterodyning voltage of such frequency variation that throughout the signal input range, an intermediate frequency of 50 kc. may be produced. The dial controlling this oscillator is graduated in the frequencies admitted by the input channel.

The fixed-frequency 50 kc. i.f. channel is extremely sharp, containing three quartz crystals and is preceded by a balanced modulator, the output of which contains the upper and lower sidebands obtained from the heterodyning process. The carrier is suppressed. The super-selective i.f. channel is followed by a 50 kc. amplifier and the indicating instrument.

In operation, the wave analyzer is tuned to the fundamental test frequency and then to the successive harmonics to an extent determined by the amount of frequency tuning range between the fundamental and the 16 kc. limit of the dial. The harmonic amplitudes are indicated directly by the meter.

RECEIVER TUNED CIRCUITS

By the Engineering Department, Aerovox Corporation

TUNING, as performed in radio reception, consists essentially in setting certain circuits to admit signal voltages of one frequency while excluding those of all other frequencies. Selectivity is a measure of the extent to which this action is achieved. A circuit is said to be selective when it enables the complete rejection of unwanted frequencies, even those which lie quite close to the desired signal. All receiver tuned circuits should provide selectivity.

The important tuned circuits of a receiver are identical with the basic arrangement shown in Figure 1, consisting of a capacitance connected in parallel with an inductance, or are elaborations of this same arrangement. In order that the circuit may be adjusted, the property of one of its elements is made variable; although it would be entirely possible, though difficult of manipulation, to have both variable. The majority of systems, for numerous reasons of electrical and mechanical practicability, employ a variable condenser, rather than an adjustable inductance.

The tuned circuits of a receiver may be operated as series tuned circuit or parallel tuned circuit. The characteristics of the series tuned circuit are essentially the same as those of the parallel tuned circuit, except that the series tuned circuit depends on a line current increase for its operation while the parallel tuned circuit depends upon a line current decrease for its operation. Therefore, the selectivity of the series tuned circuit depends primarily on a low line resistance, while the selectivity of a parallel tuned circuit depends primarily on a source of high series resistance.

From a study of the antenna or coupling transformer of a radio frequency or intermediate frequency stage, it will be noted that the grid circuit is a tuned series circuit as the voltage is induced in the coil, and therefore can be considered acting in series with the coil and the condenser. The plate circuit, however, of an i.f. transformer is a parallel tuned circuit in series with the plate impedance of the tube. Since this plate impedance is fairly high, the parallel circuit gives the maximum voltage gain and selectivity possible.

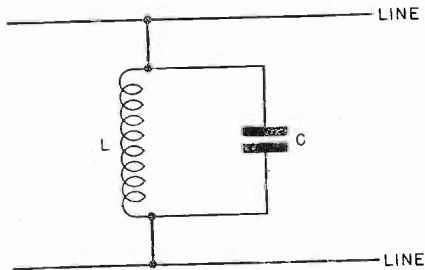

Fig. 1

The property of parallel resonance which is associated with circuits of the type in Figure 1 is the underlying modus operandi of the tuned circuit, and an understanding of the principles governing the parallel resonant circuit is essential to a full comprehension of tuned circuit operation and design.

The Parallel Resonant Circuit

• An alternating current views the parallel resonant circuit of Figure 1 as an inductive reactance in shunt with a capacitive reactance. And in flowing down through this combination, the current will encounter separate impeding effects in the two legs, the two reactances acting upon it by different amounts depending upon the frequency of the current alternations and the values of the coil and condenser components.

At some one critical frequency, for any given inductance and capacitance values, the inductive reactance and capacitive reactance will be equal. Because of the nature of the two kinds of reactance, the impeding action of the circuit will be almost entirely due to the capacitive element at frequencies below this critical frequency and largely to the inductive at frequencies higher. At this critical frequency of resonance, the two reactances, being equal and of opposite algebraic sign, will neutralize each other, leaving the coil resistance (which is generally negligible in comparison with the coil reactance) as the sole circuit property remaining to impede the passage of current.

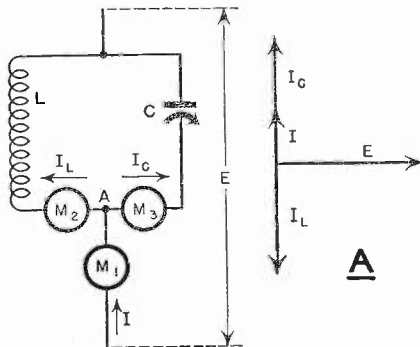

Figs. 2 and 2A

Consider three suitable a.c. ammeters; M_1 , M_2 , and M_3 , connected in the manner illustrated in Figure 2. When an alternating current, I , is caused to flow into the circuit by action of an impressed e.m.f., its intensity will be indicated by the meter M_1 . This current, termed the line current, will divide at the junction point, A; a portion (I_c , the condenser current) flowing through the capacitive leg of the circuit will actuate M_3 . And the other (I_L , the coil current) flowing through the inductive leg will actuate M_2 . The readings of M_2 and M_3 will be unequal and that of M_1 may be less than either of the former.

If then the capacitance of the condenser C is adjusted throughout its range, I_c and I_L will gradually tend to become equal, while at the same time the line current, I , will be growing steadily smaller. Assuming that the capacitance range of C is appropriate, there will be one setting of this condenser at which C and L will have the proper relation to render the circuit resonant at the frequency of the applied voltage. I will fall to a very low value, approaching

RECEIVER TUNED CIRCUITS—Continued

zero, at resonance, while the large magnitude and near equality of I_c and I_L at that point indicate that the reactive properties of the circuit have very nearly disappeared. Because of the high current in the circuit, the voltage developed across LC will be at its peak.

Beyond resonance, I_c and I_L will again become unequal as the capacitance of the condenser is varied further, the condenser current continuing to move upward; the coil current downward.

Thus, it may be seen that the proper adjustment of L and C at any frequency will result in the appearance of a maximum voltage (the resonant voltage) across the combination and minimum current (line current) in the external circuit. And when the circuit is connected to a voltage-operated device, such as to the grid-cathode input of a vacuum tube, voltages of desired frequencies may be selected and applied to the device by resonating the circuit. This is the basic function of the receiver tuned circuit.

The resonant frequency, f may be determined from the equation:

$$(1) \quad f = \frac{1}{2\pi\sqrt{LC}}$$

From which:

$$(2) \quad L = \frac{1}{4\pi^2 f^2 C}$$

And

$$(3) \quad C = \frac{1}{4\pi^2 f^2 L}$$

f is in cycles per second,

C in farads, and L in henries.

f in each case is taken to be the resonant frequency.

The above equations hold for both series and parallel circuits.

In the case of pure capacitance in parallel with pure inductance, the simple vector relations of Figure 2A would apply. Here, I_c is leading the applied voltage, E by 90 degrees, while E leads I_L by 90 degrees. I , the line current, leads E by 90 degrees when I_c is greater than I_L and lags E by 90 degrees when I_L is greater than I_c . When $I_c = I_L$ (parallel resonance), I is zero.

Inductive reactance equals ωL and capacitive reactance equals $1/\omega C$. Actually the coil possesses some resistance which appears as a re-

sistance in series with L (see Figure 3) and while:

$$(4) \quad I_c = -X_c E = -\omega C E = -2\pi f C E,$$

$$(5) \quad I_L = E / \sqrt{R^2 + X_L^2} = E / \sqrt{R^2 + (\omega L)^2} \\ = E / \sqrt{R^2 + (2\pi f L)^2}$$

Condenser loss encountered in practice (which appears as a resistance associated with C) has not been considered here.

With respect to phase, the line current I (the vector sum of I_c and I_L) is:

$$(6) \quad I = E \sqrt{\left(\omega C - \frac{X_L}{R^2 + X_L^2}\right)^2 + \left(\frac{R}{R^2 + X_L^2}\right)^2}$$

The vector relations of Figure 3B apply. At resonance, the line current I is at its minimum value (I_r), is in phase with E , and is equal to $ER/R^2 + (X_L)^2$.

The vector diagram of the series circuit is shown in Figure 3C. It should be noted that this diagram is similar to the diagram for the parallel circuit except that the voltages replace the currents.

The Nature of C

• In Figures 1, 2 and 3, capacitance associated with the coil in parallel resonant circuits is represented by the condenser component C. Actually, however, C represents not just the capacitance of the condenser but the total capacitances acting in shunt with the coil. And these include (1) the actual condenser capacitance, (2) the distributed capacitance of the coil, and (3) stray shunt capacitance due to wiring and to coil and condenser terminals, all of which act in parallel to resonate the circuit. Wherever C appears in the foregoing formulas it has the inclusive meaning:

$$(7) \quad C = C_c + C_d + C_s$$

Where:

C = total capacitance resonating the circuit,

C_c = condenser capacitance,

C_d = distributed capacitance of the coil, and

C_s = all stray capacitance due to wiring, etc.

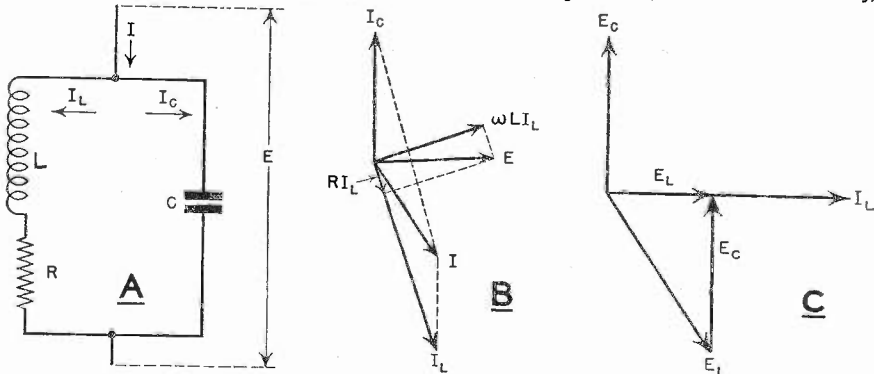

Fig. 3

RECEIVER TUNED CIRCUITS—Continued

For these reasons, the coil L may be discovered to possess a natural resonant frequency, even with no condenser as such connected across it, because the small distributed, and stray capacitances form with it a parallel resonant circuit. It is highly important that these extra capacitances be kept as low as possible if consequential losses are to be avoided in receiver tuned circuits and full advantage is to be taken of the variable condenser range. Hence, increased turn spacing or lattice winding is resorted to in efficient circuits to reduce distributed coil capacitance.

Tuning Range

• From equation (1) it is seen that in any variable condenser-fixed coil parallel resonant circuit the maximum and minimum frequencies at which the circuit may be resonated will be determined by the maximum and minimum capacitances in shunt with the coil. Neglecting distributed and stray properties, these limiting capacitances may be taken as those of the tuning condenser. The wider the capacitance range of the latter, the wider will be the frequency band over which the circuit may be resonated.

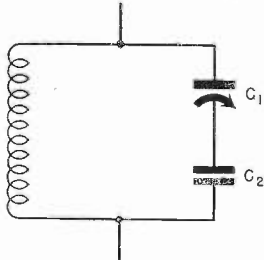

Fig. 4

Often in practice, the maximum resonant frequency of a tuned circuit is chosen as some multiple of the minimum frequency, the ratio of 2:1 being quite common in some applications, although a slightly higher ratio (nearly 3 to 1) is encountered in broadcast tuners. In the case of amateur band-spreading, the band of frequencies covered by the tuned circuits is only a few kilocycles wide, representing a ratio of less than 1.5:1 in some cases.

If it is desired to multiply or divide the resonant frequency of any parallel resonant circuit by any factor, and the fixed inductance value, original frequency, and original capacitance are known, the capacitance of the condenser at the new frequency will be equal to the capacitance at the original frequency divided by the square of the factor.

$$(8) \quad C_2 = \frac{C_1}{n^2}$$

$$(9) \quad f_2 = n f_1$$

Where:

C_1 = capacitance at original frequency,

C_2 = capacitance at new frequency,

f_1 = original frequency,

f_2 = new frequency,

n = factor by which the original frequency is to be multiplied.

Thus, to double the resonant frequency (or to provide a tuning range of 2 to 1) the capacitance must be quartered—the tuning condenser must have a capacitance range of 4:1. Or to halve f , C must be quadrupled. Within practical limits, any desired frequency range may be achieved by employing the condenser which gives the proper amount of capacitance variation in conjunction with the inductance capable of resonating at the band-limit frequencies.

Range Extension—Trimmer and Padder

• It is obvious from the foregoing that the range of capacitance variation in the condenser will decide the frequency range of the tuned circuit, and that any extension of the capacitance limits above and/or below their normal positions will correspondingly widen or narrow the band of response.

In order to bring about such changes in the limiting values of C , mechanical alterations would be possible, although hardly practicable, in the tuning condenser by addition or removal of plates. However, such a procedure would involve much labor and would affect both maximum and minimum values very nearly to the same degree, and this is not always desirable when setting a frequency range.

The same results may be accomplished electrically by interposing auxiliary condensers in series or parallel with the main tuning capacitance to operate on the latter's maximum to minimum capacities according to the following relations for the parallel connection:

$$(10) \quad C_{\min} = C_{\min_c} + C_a$$

$$C_{\max} = C_{\max_c} + C_a$$

For the series connection:

$$(11) \quad C_{\min} = \frac{1}{\frac{1}{C_{\min_c}} + \frac{1}{C_a}}$$

$$C_{\max} = \frac{1}{\frac{1}{C_{\max_c}} + \frac{1}{C_a}}$$

Where:

C = resultant minimum or maximum capacitance,

C_c = condenser capacitance at maximum or minimum as indicated,

C_a = auxiliary capacitance.

From (10) a variable condenser having a maximum and minimum capacitance rating of 100 and 10 mmfd. would have its range altered to cover 35 to 125 mmfd. by connecting a 25 mmfd. auxiliary condenser in parallel. And if the auxiliary capacitance is made 100 mmfd., the resultant capacitance range would become 110 to 200 mmfd. If the auxiliary (trimmer) condenser were variable between these values of 25 and 100 mmfd., then any number of maximum and minimum values (and corresponding widths of bandspreads) could be obtained by properly setting it. By application of relations (1) and (9) various frequency coverages could be determined. It must be remembered, of course, that where C appears in those equations and formulas it is taken to be the complex term appearing on the right-hand side in (10).

ENGINEERING APPLICATIONS

RECEIVER TUNED CIRCUITS—Continued

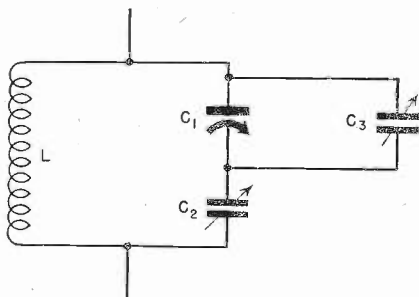

It may be desirable, however, to restrict the maximum capacitance of C without greatly affecting the minimum, in order to achieve a desired frequency range, and in such a case an auxiliary capacitance (padder) is connected in series with C (see Figure 4) and the relations of (11) apply.

In this series combination, if the tuning condenser C_1 has a range of 10-100 mmfd. and the padder C_2 a fixed value of 100 mmfd., then the capacitance range of C_1 is transformed to 9-50 mmfd. (equation 11). Note that the tuning condenser maximum has been altered considerably more than its minimum. If the value of C_2 is

reduced to 50 mmfd., the range becomes 8.3-33.3 mmfd., and if it is reduced further to 25 mmfd., the range becomes 7.1-20 mmfd. Note also that as C_2 is reduced in capacitance it has less reducing effect upon the maximum value of C_1 , while at the same time not altering the C_1 minimum tremendously.

The conventional receiver tuned circuit employs the arrangement shown in Figure 5 with both trimmer (C_3) and padder (C_2) made variable to achieve any desired amount of band-spread or band compression. The relations of (10) and (11) are combined to explain the circuit.

In Figure 5, the total working capacitance in parallel with L, neglecting distributed and stray properties, is

$$(12) \quad C = \frac{1}{\frac{1}{C_2} + \frac{1}{C_1 + C_3}}$$

and equation (1) becomes:

$$(13) \quad f = \frac{1}{2\pi \sqrt{L \left(\frac{1}{C_2} + \frac{1}{C_1 + C_3} \right)}}$$

RADIO OPERATORS WANTED

• The National Defense program is creating innumerable openings for Commercial Radio Operators. Now is the time to capitalize on your radio training and experience by obtaining a commercial operator's license and taking advantage of the many opportunities presented. The "RADIO OPERATORS' LICENSE GUIDE" has been especially prepared as a study and reference manual for those radiomen having considerable training and experience who are unfamiliar with the exact requirements for a commercial operator's license. Containing over 1,250 questions and answers to the new type examinations, it will aid you to successfully pass the tests. Only three dollars postpaid or purchase from your local parts distributor.

WAYNE MILLER

CHICAGO, ILL. THE ENGINEERING BLDG.

PRICED FROM \$3.35 up

QUARTZ CRYSTALS

For uniformly reliable operating characteristics there are none better than Bliley Crystal Units. Ask your Bliley Distributor for a copy of descriptive circular A-8.

BLILEY ELECTRIC CO., ERIE, PA.

It Once Was DX

(Continued from Page 50)

... VK2VV is with the Anzacs in Libya chasing the Is all over the place. As wireless Op with the Armored Tank Units has been clattering and rattling over the now famed march of Wavell's army. Saw advanced action at Matruh, Maktila, Sidi Barrani, Salum, Fort Capuzzo, and Bardia. Stinging sand storms and heavy enemy fire are tough. I am told, but the Aussies are running with wide open throttle and devil may care drives come little ones or big ones. Eric says "Hell on wheels" is a mild term for a tankful of Aussies.

* * *

... GW3KY, as yet uncalled to active service, says he is all O.K. and still doing business from the same old QTH. Visiting xdxers are now being treated to a hospitable snack in keeping with the Amateur atmosphere, namely ... "Ham burghers." Also tells me that though technical and experimental Ham Radio is pretty quiet, the "Bull" sessions with visiting xdxers can fill an air-raid shelter so full of hot air that cold nights don't mean a thing. Wants a bucketful of the far-famed California "sunshine" ... can any of you W6 Chamber of Commerce pluggers accommodate the gentleman from Wales?

* * *

... That's all for this time, and the Dx Editor wants to again thank the many Xdxers in W for the fine dope and Photos they have been flooding the mail bag with; asks that the good work be kept up and invites some of the others who have as yet not contributed to do so. Address all mail to the Attention of the Dx Editor, ARD., Monadnock Bldg., S. F. ... W6SZ.

NEW PRODUCTS

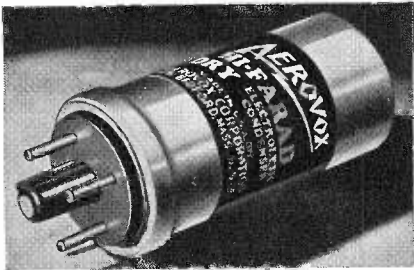

Plug-In Electrolytics Now Standard Items

ORIGINALLY made to order for military, aircraft, police radio, sound system, and other users of continuous-service equipment, the Aerovox plug-in electrolytics are now listed in the latest catalog and made available as standard jobber items.

These unique plug-in condensers, developed and manufactured by Aerovox Corporation of New Bedford, Mass., are provided with a specially-constructed octal base which fits into the standard octal socket. Such units are readily removable for substitution testing and checking and replacement, in much the same manner and ease as regular radio tubes. This feature is vitally important in continuous-service equipment, wherein electrolytic condensers must be instantly replaceable when necessary.

Aerovox plug-in electrolytics are now available in the 525 v. surge 450 v. D.C.W. rating, and in 10 to 80 mfd. single-section, 10-10 and 20-20 double-section, 10-10-10 triple-section, and the 10 x 10 x 450 + 20 x 25 combination.

Now—a high-powered

RADIO ENGINEERING LIBRARY

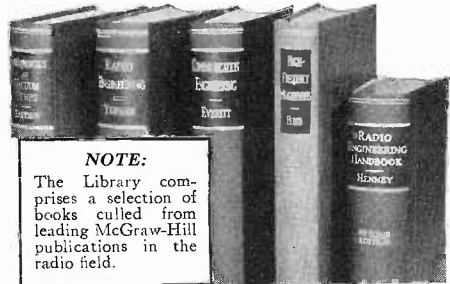

NOTE:

The Library comprises a selection of books culled from leading McGraw-Hill publications in the radio field.



especially selected by radio specialists of McGraw-Hill publications



to give most complete, dependable coverage of facts needed by all whose fields are grounded on radio fundamentals



available at a special price and terms

These books cover circuit phenomena, tube theory, networks, measurements, and other subjects—give specialized treatments of all fields of practical design and application. They are books of recognized position in the literature—books you will refer to and be referred to often. If you are a practical designer, researcher or engineer in any field based on radio, you want these books for the help they give in hundreds of problems throughout the whole field of radio engineering.

5 volumes, 3319 pages, 2289 illustrations

1. Eastman's FUNDAMENTALS OF VACUUM TUBES
2. Terman's RADIO ENGINEERING
3. Everitt's COMMUNICATION ENGINEERING
4. Hund's HIGH FREQUENCY MEASUREMENTS
5. Henney's RADIO ENGINEERING HANDBOOK

10 DAYS' FREE EXAMINATION

SPECIAL LOW PRICE

EASY TERMS

These valuable books cost you only \$23.50 under this offer. Add these standard works to your library now; pay small monthly installments, while you use the books.

SEND THIS EXAMINATION COUPON

McGraw-Hill Book Co., 330 W. 42 St., N. Y.

Send me Radio Engineering Library, 5 vols., for 10 days' examination on approval. In 10 days I will send \$2.50, plus few cents postage, and \$3.00 monthly till \$23.50 is paid, or return books postpaid. (We pay postage on orders accompanied by remittance of first installment.)

Name.....
Address.....
City and State.....
Position.....
Company..... ARD 3-41
(Books sent on approval in U. S. and Canada only.)

Constant Voltage

FOR YOUR LABORATORY, YOUR PRODUCT, OR YOUR PRODUCTION LINE



STEADY-VOLT

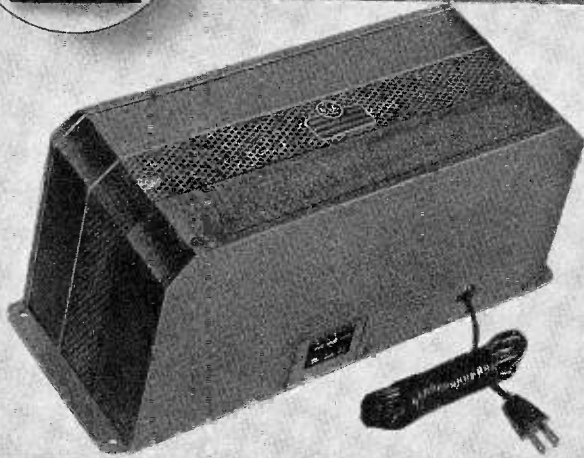

- ★ ACCURACY 1%
- ★ INDEPENDENT OF LOAD
- ★ NO MOVING PARTS
- ★ HIGH POWER FACTOR
- ★ HIGH EFFICIENCY
- ★ NEGLIGIBLE TIME CONSTANT
- ★ LOW DISTORTION
- ★ LOW TEMPERATURE RISE

AUTOMATIC VOLTAGE REGULATORS 95-130 VOLT INPUTS . . . 110, 115, 120 VOLTS OUTPUT \pm 1%

The UTC automatic voltage regulator is NEW. It involves no moving parts and effects instantaneous correction for either transient or chronic line voltage fluctuations.

STANDARD TYPES

Type No.	Capacity VA — 60 Cyc.	Net Price
AR-1	15	\$12.00
AR-2	30	15.00
AR-3	60	21.00
AR-4	120	28.00
AR-5	250	46.00
AR-6	500	67.00
AR-7	1000	110.00
AR-8	2000	200.00

Designs for 220 volt service available at 25% increase in price, for 50 cycle units; increase price 25% for 42 cycles, 35% increase for 25 cycles, increase price 100%. Special secondary voltages available to customers' specifications at small increase in price.

SPECIAL UNITS

The unique design of these regulators makes possible the construction of special units with relative ease. The output can be arranged to provide filament and plate voltage, or any other special voltages that may be required. Write for details.



CHARACTERISTICS OF TYPICAL UNIT

UNITED TRANSFORMER CORP.

150 VARICK STREET ★ NEW YORK, N. Y.
EXPORT DIVISION: 100 VARICK STREET NEW YORK, N. Y. CABLES: "ARLAB"

THERE'S NO SECRET TO THE ENDURANCE

OF P. R. MALLORY & CO. Inc.
MALLORY
TRANSMITTING
CAPACITORS

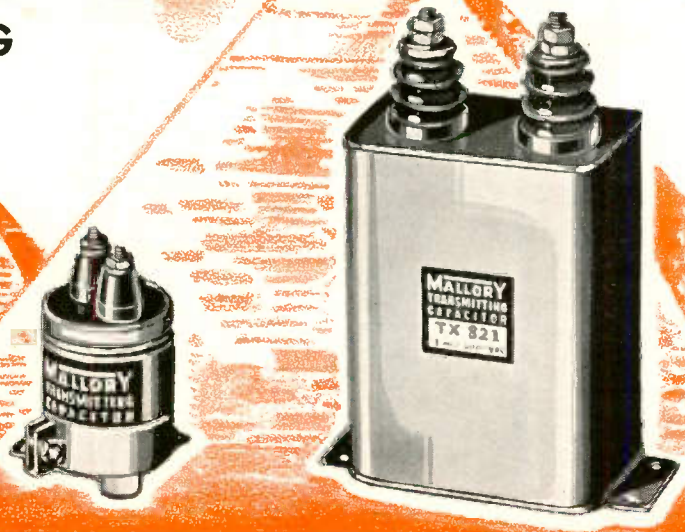

THEY HAVE X-64 IMPREGNANT!

Mallory X-64 designates the exclusively developed synthesized plastic dielectric which contributes so much to the amazing performance records established by Mallory Transmitting Capacitors. X-64 is a non-oxidizing, non-polar translucent resin of exceptional stability.

Check these direct advantages:

- ✓ Excellent for high temperature operation up to 200°F (93°C). Power factor decreases with increasing temperature throughout normal operating temperature range.
- ✓ At high temperatures the power factor is below that of other types of dielectrics at normal temperatures.
- ✓ Capacitor may be mounted in any position without danger of leakage.
- ✓ Semi-solid impregnant provides anchorage for capacitor components and helps resist effects of extreme vibration and physical shock.
- ✓ Average breakdown higher than usual for oils or wax.
- ✓ Capacity change with temperature less than 12% from -80°F to +200°F.
- ✓ Extremely high insulation resistance—long life—low leakage.
- ✓ High dielectric constant (K). Smaller size with maintained quality.
- ✓ Non-inflammable.
- ✓ Moisture-repellent.
- ✓ Low vapor pressure.

P. R. MALLORY & CO., Inc., INDIANAPOLIS, INDIANA Cable Address — FEMMALLO

More
than ever
INSIST ON

P. R. MALLORY & CO. Inc.
MALLORY
APPROVED
PRECISION PRODUCTS

VIBRATORS • VIBRAPACKS • CONDENSERS • VOLUME
CONTROLS • ROTARY SWITCHES • SINGLE AND
MULTIPLE PUSH BUTTON SWITCHES • RESISTORS
RADIO HARDWARE

FOUND!

**MORE RELIABLE
COMMUNICATION WITH
INSTANT HEATING TUBES**



Top: View of R.F. Channel

Below: Transmitter installed. Note sending and receiving antennae and "Voice of Safety" speaker.

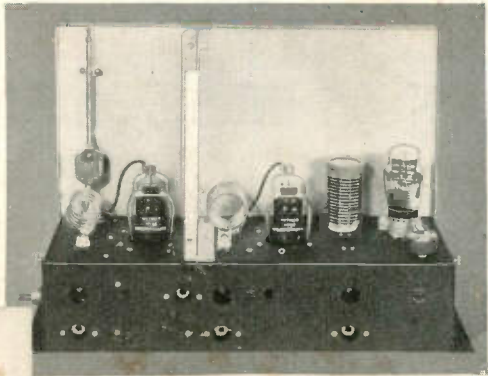

HY69
\$3.50 Net

HY31Z
\$3.50 Net

Hytron had one thing in mind when it engineered the HY69 and the HY31Z, and that was to provide tubes for mobile communications work which would provide greater power output with less battery consumption, thus assuring more reliable communications. Instant-heating tubes were the answer, because their use eliminated filament drain during standby.

Proven by over a full year of service in the field, there is no longer any doubt as to their superiority. Thousands of HY69's are in use in mobile and field station transmitters from Coast to Coast. Take, for example, the Radio-Telephone Transmitter (illustrated above) which was designed for the Salem, Mass., Police Department. This transmitter, which has given astonishing results beyond anything hitherto used by the Department, was made possible solely through the use of the Hytron HY69's and HY31Z's. For complete constructional details see the November 1940 issue of "Communications."

The HY69 is also an ideal tube for AC-operated transmitters, since it can be used as an oscillator, buffer, frequency multiplier, final amplifier, or modulator. Its 40-watt plate dissipation allows full input when plate modulated. The HY69 will deliver 42 watts CCS phone carrier as compared with 24-watts for the cathode equivalent HY61/807.

Hytron transmitting tubes are licensed by Radio Corporation of America for both the manufacturers' and users' protection.

Available in 12-volt series for aircraft and marine installations.

HYTRONIC



LABORATORIES

A DIVISION OF THE HYTRON CORP

Lafayette St., Salem, Mass.