

EUROPOWER PMP1000/PMP3000/PMP5000

User Manual

en

Version 1.0 November 2006



www.behringer.com



EUROPOWER PMP1000/PMP3000/PMP5000

IMPORTANT SAFETY INSTRUCTIONS



CAUTION: To reduce the risk of electric shock, do not remove the top cover (or the rear section). No user serviceable parts inside; refer servicing to qualified personnel.

WARNING: To reduce the risk of fire or electric shock, do not expose this appliance to rain and moisture. The apparatus shall not be exposed to dripping or splashing and no objects filled with liquids, such as vases, shall be placed on the apparatus.



This symbol, wherever it appears, alerts you to the presence of uninsulated dangerous voltage inside the enclosure—voltage that may be sufficient to constitute a risk of shock.



This symbol, wherever it appears, alerts you to important operating and maintenance instructions in the accompanying literature. Please read the manual.

- 1) Read these instructions.
- 2) **Keep these instructions.**
- 3) **Heed all warnings.**
- 4) **Follow all instructions.**
- 5) **Do not use this apparatus near water.**
- 6) **Clean only with dry cloth.**
- 7) **Do not block any ventilation openings. Install in accordance with the manufacturer's instructions.**
- 8) **Do not install near any heat sources such as radiators, heat registers, stoves, or other apparatus (including amplifiers) that produce heat.**
- 9) **Do not defeat the safety purpose of the polarized or grounding-type plug. A polarized plug has two blades with one wider than the other. A grounding type plug has two blades and a third grounding prong. The wide blade or the third prong are provided for your safety. If the provided plug does not fit into your outlet, consult an electrician for replacement of the obsolete outlet.**
- 10) **Protect the power cord from being walked on or pinched particularly at plugs, convenience receptacles, and the point where they exit from the apparatus.**
- 11) **The apparatus shall be connected to a MAINS socket outlet with a protective earthing connection.**

12) Where the MAINS plug or an appliance coupler is used as the disconnect device, the disconnect device shall remain readily operable.

13) Only use attachments/accessories specified by the manufacturer.

14) Use only with the cart, stand, tripod, bracket, or table specified by the manufacturer, or sold with the apparatus. When a cart is used, use caution when moving the cart/apparatus combination to avoid injury from tip-over.



15) **Unplug this apparatus during lightning storms or when unused for long periods of time.**

16) **Refer all servicing to qualified service personnel. Servicing is required when the apparatus has been damaged in any way, such as power supply cord or plug is damaged, liquid has been spilled or objects have fallen into the apparatus, the apparatus has been exposed to rain or moisture, does not operate normally, or has been dropped.**

17) **CAUTION - These service instructions are for use by qualified service personnel only. To reduce the risk of electric shock do not perform any servicing other than that contained in the operation instructions unless you are qualified to do so.**



EUROPOWER PMP1000/PMP3000/PMP5000

FOREWORD



Dear Customer,

Welcome to the team of EUROPOWER users and thank you very much for expressing your confidence in BEHRINGER products by purchasing this power mixer.

It is one of my most pleasant tasks to write this letter to you, because it is the culmination of many months of hard work delivered by our engineering team to reach a very ambitious goal: to present you three outstanding power mixers that give you maximum flexibility and

performance with a unique sound character and broad range of striking functions. The task to design the new PMP series certainly meant a great deal of responsibility, which we assumed by focusing on you, the discerning user and musician. It also meant a lot of work and night shifts to accomplish this goal. But it was fun, too. Developing a product usually brings a lot of people together, and what a great feeling it is when everybody who participated in such a project can be proud of what we've achieved.

It is our philosophy to share our joy with you, because you are the most important member of the BEHRINGER team. With your highly competent suggestions for new products you've greatly contributed to shaping our company and making it successful. In return, we guarantee you uncompromising quality as well as excellent technical and audio properties at an extremely favorable price. All of this will enable you to fully unfold your creativity without being hampered by budget constraints.

We are often asked how we can make it to produce such high-grade devices at such unbelievably low prices. The answer is quite simple: it's you, our customers! Many satisfied customers means large sales volumes enabling us to get better conditions of purchase for components, etc. Isn't it only fair to pass this benefit back to you? Because we know that your success is our success, too!

I would like to thank all people whose help on "Project PMP" has made it all possible. Everybody has made very personal contributions, starting from the designers of the unit to the many staff members in our company and finally to you, the user of BEHRINGER products.

My friends, it's been worth the trouble!

Thank you very much,

Uli Behringer

TABLE OF CONTENTS

1 INTRODUCTION	4
1.1 Before you get started	4
1.1.1 Shipment	4
1.1.2 Initial operation	4
1.1.3 Online registration	4
1.2 The manual	4
2 CONTROL ELEMENTS	5
2.1 Mono and stereo channels	5
2.1.1 Input section	5
2.2 Equalizer and FBQ	6
2.3 Effects section	7
2.4 Main and monitor section	7
2.4.1 Connectors	8
2.5 Rear panel	8
3 DIGITAL EFFECTS PROCESSOR	8
4 INSTALLATION	9
4.1 Mains connection	9
4.2 Audio connections	9
4.3 Loudspeaker connections	10
5 WIRING EXAMPLES	11
6 SPECIFICATIONS	14
7 WARRANTY	16
FCC—FEDERAL COMMUNICATIONS COMMISSION COMPLIANCE INFORMATION	17

en

CAUTION!

 We would like to point out that high volume levels may damage your hearing and/or your headphones. Please move down all faders in the MAIN section before turning on the device. Always make sure that the appropriate volume is set.

1 INTRODUCTION

Congratulations! With the PMP1000/PMP3000/PMP5000 you have acquired a state-of-the-art power mixer that sets new standards. Right from the very start it has been our goal to design a revolutionary unit that can be used for a wide variety of applications. Indeed, this overwhelming power mixer gives you plenty of functionality and a broad range of connection and expansion options.

Your PMP features our revolutionary **COOLAUDIO** amplifier technology, which reduces the weight and size of the unit considerably and ensures extremely high output power.





Further advantages are the integrated **Voice Canceller** that removes vocal passages from playbacks, the **FBQ** function, which detects feedback frequencies, and the **Speaker Processing** function for loudspeaker alignment—all with a resolution of **24 bits** and **40 kHz**. Plus, our tried and tested **XENYX Mic Preamps** give you crystal-clear audio free of noise and distortion when using microphones.

BEHRINGER is a company with its roots in professional recording studio technology. For many years we have been successful in developing products for studio and live use. These include microphones and 19" units of all types (compressors, enhancers, noise gates, tube processors, headphone amplifiers, digital effects, DI boxes, etc.), monitor and P.A. speakers and professional live and recording mixers. Our entire technical know-how has gone into your PMP power mixer.

1.1 Before you get started

1.1.1 Shipment

Your PMP was carefully packed at the factory and the packaging is designed to protect the unit from rough handling. Nevertheless, we recommend that you carefully examine the packaging and its contents for any signs of physical damage which may have occurred during transit.

-  **If the unit is damaged, please do NOT return it to BEHRINGER, but notify your dealer and the shipping company immediately. Otherwise, claims for damage or replacement may not be granted.**
-  **We recommend that you use a flight case, so as to give your power mixer optimum protection during use or transport.**
-  **Always use the original packing carton to prevent damage during storage or transport.**
-  **Make sure that children cannot play unsupervised with the device or its packaging.**
-  **Please ensure proper disposal of all packing materials.**

1.1.2 Initial operation

Be sure that there is enough air space around the unit for cooling and, to avoid overheating, please do not place the EUROPOWER near radiators, etc.

 **Blown fuses must be replaced by fuses of the same type and rating! Please refer to the "SPECIFICATIONS" for details.**

The mains connection is made using the enclosed power cord and a standard IEC receptacle. It meets all of the international safety certification requirements.

 **Please make sure that all units have a proper ground connection. For your own safety, never remove or disable the ground conductor from the unit or on the AC power cord.**

To avoid damage on the device, do not

- earth the loudspeaker outputs
- connect the loudspeaker outputs to each other
- connect the loudspeaker outputs to those of other amplifiers

IMPORTANT NOTES CONCERNING INSTALLATION

The sound quality may diminish within the range of powerful broadcasting stations and high-frequency sources. Increase the distance between the transmitter and the device and use shielded cables for all connections.

1.1.3 Online registration

Please do remember to register your new BEHRINGER equipment right after your purchase by visiting www.behringer.com (alternatively www.behringer.de) and kindly read the terms and conditions of our warranty carefully.

Should your BEHRINGER product malfunction, our goal is to have it repaired as quickly as possible. To arrange for warranty service, please contact the retailer from whom the equipment was purchased. Should your BEHRINGER dealer not be located in your vicinity, you may directly contact one of our subsidiaries. Corresponding contact information is included in the original equipment packaging (Global Contact Information/European Contact Information). Should your country not be listed, please contact the distributor nearest you. A list of distributors can be found in the support area of our website (www.behringer.com).

Registering your purchase and equipment with us helps us process your repair claims quicker and more efficiently.

Thank you for your cooperation!

1.2 The manual

This manual is designed to give you both an overview of all control elements and to provide details about how to use them. To provide you with a clear structure, we have grouped the control elements according to their function. They can easily be found on the enclosed numbered illustrations. If you need more detailed information on specific topics, please visit our web site at www.behringer.com.

2 CONTROL ELEMENTS

A detailed description of all functions of your power mixer can be found in the following chapters. Please also refer to the enclosed sheet with the numbered illustrations to get a good overview of the control layout.

2.1 Mono and stereo channels

- [1] Use the *TRIM* control to adjust the input gain. Be sure to set this control fully counter-clockwise before you connect or disconnect a signal source to an input. TRIM controls both the microphone and the LINE input. The black scale shows the microphone **gain** (+10 to +60 dB on channels with XENYX MIC PREAMPS and 0 to +40 dB on conventional microphone inputs; PMP1000 only, channels 5/6 and 7/8).

The "LINE" scale indicates the **sensitivity** of the LINE input, ranging from +10 to -40 dBu.

PMP1000: The mono/stereo combination channels 5/6 and 7/8 have a **sensitivity** of +20 to -20 dBu.

- [2] The *LEVEL SET* LED illuminates when an optimum operating level has been adjusted.
- [3] The mono channels are equipped with a high-slope *LOW CUT* filter eliminating unwanted low-frequency signals like rumble noise.
- [4] PMP3000/PMP5000 (stereo channels): Press the *A/B* button to switch from 1/4" jacks to RCA connectors, and vice versa. Position "A" = 1/4" jacks; position "B" = RCA connectors.
- [5] The *HIGH* control in the EQ section governs the high frequency range of the respective channel.
- [6] Use the *MID* control to boost or cut the midrange frequencies.
- [7] PMP5000: The PMP5000 has an additional semi-parametric filter for the midrange frequencies in the mono channels (tunable from 100 Hz to 8 kHz). Adjust the boost/cut with the *MID* control, and the frequency with the *FREQ* control.

The stereo channels contain a stereo EQ section. The cut-off frequencies of the high and low bands are 12 kHz and 80 Hz respectively, while the center frequencies of the high-mid and low-mid bands are 3 kHz and 400 Hz respectively.

- [8] The *LOW* control allows you to boost/cut the low frequency range.
- [9] With the *MON(ITOR)* control you can adjust the volume of each channel in the monitor mix.
- [10] The PMP3000 and PMP5000 feature a second *MON* control (*MON 2*) for the volume of the second monitor bus.
- [11] The *FX* control determines the signal level sent from each channel to the built-in effects processor; this signal is also present at the *FX SEND* jack (see [64]).
- [12] The PMP5000 has two *FX* controls (*FX 1* and *FX 2*), so that you can use two effects simultaneously. Accordingly, the PMP5000 also has two effect aux buses, which have one output jack in common (see [46] and [64]).

 **Please note that the effects processor signal will be inaudible, as long as the FX TO MON/MAIN controls [40], [41], [42] are set fully counter-clockwise.**

- [13] The *PAN(ORAMA)* control determines the position of the channel signal in the stereo main mix.
- [14] The *BAL(ANCE)* control for the stereo channels corresponds to the *PAN* control for the mono channels. It determines the relative volume of the left and right input signals before they are routed to the stereo main output.

- [15] PMP3000/PMP5000: When you press the *PFL* button (Pre Fader Listening) the left LED [34] shows the pre-fader input gain of the channel. Adjust the optimum input gain (0 dB) with the *TRIM* control [1]. When *PFL* is on, the corresponding LED illuminates.

If the *LEVEL SET* LED [2] is illuminated constantly, the signal is within the optimum operating level range. However, if the *CLIP* LED indicates that the input gain is too high, you should reduce the level slightly with the *TRIM* control. The *CLIP* LED should never be illuminated all the time, only with signal peaks.

- [16] The *MUTE* switch mutes the channel in the main mix. The pre-fader signals (monitor buses) remain operative. When *MUTE* is pressed, the corresponding control LED illuminates.
- [17] The channel fader controls the channel signal level in the main mix.

2.1.1 Input section

- [18] Each mono input channel is equipped with a balanced microphone input (XLR connector) which provides +48 V phantom power for condenser microphones at the touch of a button (see rear panel).

PMP1000: The two stereo channels 5/6 and 7/8 have an additional balanced XLR microphone input with +48 V phantom power.

 **Be sure to switch off your audio system before you activate the phantom power supply to protect your monitor speakers from switch-on thumps.**

- [19] Each mono input features one *LINE IN* connector (1/4" jack), which can be used with either balanced or unbalanced signals.

 **Please remember to use either the microphone or the line input on a specific channel. Never use both at the same time!**

 **When you connect a mono line signal to a stereo channel, always use the left input. The mono signal will then be reproduced by both sides equally.**

 **PMP1000: This does not apply to the mono/stereo combination channels 5/6 and 7/8.**

- [20] *INSERT I/O*. Insert points or simply inserts are used to process a signal with dynamic processors or equalizers. They are pre-fader, pre-EQ and pre-MON/FX SEND. Unlike reverb and other effects, which are usually added to the dry signal, dynamic processors usually process the entire signal. So, aux send buses are not the best solution. Dynamic processors need to be inserted directly into the signal path. Once processed, the signal then returns to the mixing console at the same point where it left. Signal interruption takes place only if a plug is inserted into the corresponding jack (1/4" stereo plug: tip = signal output, ring = input). All mono input channels are equipped with inserts.

- [21] The stereo channels have a *TRIM* control for gain adjustment, with the input **sensitivity** ranging from +20 to -20 dB.

PMP1000: The stereo channels 5/6 and 7/8 feature an additional XLR connector for microphones whose **gain** can be set from 0 to +40 dB.

- [22] Each stereo channel has two line-level inputs (1/4" jacks) for the left and right channels. If only the jack marked "L" is used, the channel is mono. The signal will then be reproduced on both sides.

 **PMP1000: This does not apply to the mono/stereo combination channels 5/6 and 7/8.**

EUROPOWER PMP1000/PMP3000/PMP5000

 **PMP1000:** Channels 13/14 and 15/16 are routed to the main mix without additional tone or volume adjustment. For example, using the channels 13/14 and 15/16 you can connect a submixer and utilize the PMP1000's power amplifier.

[23] **PMP3000:** The stereo channels 9/10 and 11/12 are equipped with additional RCA connectors.

PMP5000: The stereo channels 13/14 and 15/16 are equipped with additional RCA connectors.

 **PMP3000/PMP5000:** Please note that you need to set the A/B selector [4] to A (1/4") or B (RCA) when you connect a signal to the input.

[24] **PMP3000/PMP5000:** Each of the two stereo channels has two monitor controls (MON 1/2) and a *LEVEL* control [25]. Like the other channels, they also feature a PFL switch.

[25] Instead of a fader this channel has a rotary *LEVEL* control.

[26] The phantom power supply provides the voltage necessary for the operation of condenser microphones. Use the *PHANTOM* switch to activate the supply for the XLR connectors of the input channels. The +48 V LED will illuminate when phantom power is on. In most cases, dynamic microphones can still be used, as long as they are connected in a balanced configuration. If in doubt, please contact the manufacturer of your microphone!

 **With phantom power switched on, you must never connect microphones to the console (or to a stage/wall box). Also, be sure to mute the monitor/P.A. speakers, before you turn on the phantom power supply. After switching on, please allow the system to stabilize for about one minute, before you adjust the input gain.**

 **Caution! Never use unbalanced XLR connectors (pins 1 and 3 interconnected) on the MIC input jacks, if you are going to use the phantom power supply.**

[27] The *AMP MODE* switch determines the mode of operation of the PMP amplifier stage:

PMP1000:

MAIN: In the "MAIN" position the mixer works as a stereo amplifier.

MON: In this mode the monitor signal is present at OUTPUT A [71] and the main signal at OUTPUT B [70] (both are mono).

BRIDGE (bridged mono mode): In *BRIDGE AMP MODE* the output power of OUTPUT A is added to that of OUTPUT B, i.e. OUTPUT B delivers twice its normal output power.

PMP3000/PMP5000:

MAIN L/MAIN R. In position MAIN MIX, the mixer works as a stereo amplifier.

MON 1/MONO. In this mode the monitor 1 signal is present at OUTPUT A [71] and the main signal at OUTPUT B [70] (both are mono).

BRIDGE (bridged mono mode): In *BRIDGE AMP MODE* the output power of OUTPUT A is added to that of OUTPUT B, i.e. OUTPUT B delivers twice its normal output power.

 **In BRIDGE mode, always connect only one loudspeaker with an impedance of at least 8 Ω to the OUTPUT B jack! Please note that OUTPUT A must NEVER be used in BRIDGE mode!**

 **In all other operating modes, the minimum impedance of the speaker must not fall below 4 Ω.**

 **Please note that the power delivered to the speaker connected to OUTPUT B in BRIDGE AMP MODE is considerably higher than the power provided to the speakers wired to the parallel speaker outputs. Please read the information given on the rear panel of the power mixer.**

 **Information on how to properly connect your speaker with regard to polarity can be found on the rear of the unit (PIN assignment) (see also [71] and [72]).**

[28] **PMP5000:** Use the *BEHRINGER SPEAKER PROCESSING* switch to activate a filter that allows you to adapt the mixer to the characteristics of your loudspeakers. If the speakers have a limited frequency response in the bass range, this function allows you to filter this range at the output signal of the mixer and thus adapt it optimally to the frequency response of the speakers.

[29] **PMP1000/PMP5000:** If *STANDBY* is pressed, all input channels are muted. During pauses you can prevent the microphones from picking up noise or interference, which would then be reproduced by the P.A. system or possibly damage the speaker diaphragms. The benefit is that all faders can be left untouched while you play back music from CD via the CD/TAPE inputs (see [55]). There is also no need to move the faders and lose your mix.

2.2 Equalizer and FBQ

[30] Your power mixer features a graphic 7-band equalizer, which allows you to fine-tune the sound depending on the room acoustics. In the center position the frequency response is not effected. To boost or cut a certain frequency range, simply move the corresponding fader upward or downward respectively.

 **Please note that the equalizer behaviour depends on the position of the AMP MODE switch (see [27]).**

[31]



Press the *FBQ IN* switch to activate the Feedback Detection system (the FBQ will be active only if you have switched on the equalizer [33] before). Frequencies causing feedback are shown by brightly lit fader LEDs. All other LEDs will be darker. Now, cut the frequency range in question until feedback disappears (the LED gets darker or goes out). This function is available for both the main and monitor mix.

PMP1000: The switch *FBQ FEEDBACK DETECTION* performs the same function as on the PMP3000 and PMP5000.

[32] Use the *MAIN/MON 1* switch to select whether the equalizer processes the main or the monitor mix. When not pressed, the stereo equalizer processes only the main mix. When the switch is pressed, the EQ processes only the monitor mix.

PMP1000: The *MAIN MIX/MONITOR* switch performs the same function as on the PMP3000 and PMP5000.

[33] Press the *EQ IN* switch to activate the equalizer. The fader LEDs illuminate when the EQ is on.

[34] Use this LED display to control the output level of the main signal. The upper *LIM* LED illuminates when the internal amp protection circuit responds to levels that are too high.

PMP1000: The POWER LED is illuminated when you switch the unit on.

 **The LIM LEDs and the LED display do NOT light up when an external signal is fed in via the PWR AMP INSERT jacks [61].**



2.3 Effects section

- [35] List of all multi-effects processor presets.
- [36] The LED level meter on the effects module should always show a sufficiently high level. Make sure that the Clip LED illuminates with signal peaks only. If it is constantly illuminated, the effects processor is overloading, which can lead to unpleasant distortion. The *FX SEND* fader (PMP1000) or *FX/FX 1/2* fader (PMP3000/PMP5000) controls the level sent to the effects module and to the FX SEND output jacks.
- [37] The effects display always reads the currently selected preset.
- [38] PMP3000/PMP5000: Press the *FX1/2 IN* switch to activate the effects processor.
- [39] PMP1000/PMP3000: Turn the *PROGRAM* control to select an effects algorithm (preset number starts flashing). Press this control to activate the effect selected (PMP5000: *FX 1/2 (PUSH)*).
- PMP1000: The effects processor is operative all the time. Adjust the effect intensity for the MAIN or MON signals with controls [40] or [42] respectively.**
 PMP5000: The PMP5000 has two separate effects processors, which can be used independently of one another. Enable one or both processors with the *FX1/2 IN* [38] buttons.
- [40] PMP3000/PMP5000: The *FX 1/2 TO MON 1* control allows you to set the intensity of the multi-effects processors in the monitor mix. No effect is sent to the monitor mix when this control is set fully counter-clockwise.
 PMP1000: The *FX TO MON* control performs the same function as on the PMP3000 and PMP5000.
- [41] The *FX 1/2 TO MON 2* control allows you to determine the effect intensity of the multi-effects processor in the monitor 2 mix. No effect is sent to the monitor 2 mix with this control turned fully counter-clockwise.
- [42] The *FX 1/2 TO MAIN* control allows you to determine the effect intensity of the multi-effects processor in the main mix. No effect is sent to the main mix with this control turned fully counter-clockwise.
 PMP1000: The *FX TO MAIN* control performs the same function as on the PMP3000 and PMP5000.

2.4 Main and monitor section

- [43] The *SURROUND* control determines the effect intensity. This is a built-in effect, which widens the stereo panorama, thus making the sound more lively and transparent.
- [44] Press the *XPQ TO MAIN* switch to activate this effect.
- [45] Pressing the *AFL* switch (after-fader listening) activates the solo function. If AFL is on for the corresponding channel in the main section, you will only hear the signal from this channel. Its volume can be adjusted with the fader. Switching AFL on has no effect on the main or monitor mix, as long as you don't move the fader. In this way, you can monitor one or several selected signals via the PHONES/CTRL jack [65]. When AFL is on, the corresponding control LED illuminates.
- The PMP1000 does not have an AFL function.**
- [46] PMP1000: *FX SEND* fader.
 PMP3000: *FX* fader.
 PMP5000: *FX 1/2* fader.
 This is the master send fader for the signal routed to the effects processor and to the FX SEND output [63] (see also [11] and [12]).
- [47] PMP1000: *MON SEND* fader.
 PMP3000/PMP5000: *MON 1/2* fader.
 These faders are used to set the monitor output volume (see also [9] and [10]).
- [48] PMP1000: The main mix allows you to control the volume from the Main 1 output with both faders.
 PMP3000/PMP5000: The *MAIN 1* fader controls the volume of the EUROPOWER. The main signal is also provided at the MAIN 1 output (see also [58]).
- [49] PMP3000/PMP5000: The *MONO* fader controls the mono mix signal (see also [63]).
- [50] PMP5000: The *SUB FILTER* filters out frequencies above the selected setting, so that only low frequencies are sent to an (active) subwoofer via the MONO OUT [63]. Set this switch to "On" to activate the filter.
- [51] PMP5000: The *SUB FREQ* control determines the cut-off frequency for the subwoofer output. This value can be adjusted from 30 to 200 Hz.
- [52] The *PHONS/CTRL R* control adjusts the headphone or control room volume (see also [65]).
- [53] PMP3000/PMP5000: The *MAIN 2* control determines the volume at the MAIN 2 output (see also [59]), which is the same signal as at MAIN 1, but with extra output jacks and separate volume control.
- [54] PMP3000/PMP5000: With the *CD/TAPE IN* control you can adjust the volume of the line signal present at the CD/TAPE INPUT [55]. Use the PFL switch to monitor the signal.
 PMP1000: With the *CD/TAPE RET* fader you can adjust the line signal applied to the CD/TAPE INPUT [55]. Use the CD/TAPE MUTE switch to mute the channel.

EUROPOWER PMP1000/PMP3000/PMP5000

2.4.1 Connectors

[55] Use the *CD/TAPE INPUT* jacks (RCA) to connect an external stereo signal, such as a CD player, tape deck or other line-level sources.

[56]  The *VOICE CANCELLER* filters vocal-specific frequencies from the *CD/TAPE INPUT* signal. This function can be used for karaoke, i.e. you can remove the vocals from a song and then sing along with the music yourself.

[57] The *CD/TAPE OUTPUT* provides the line level stereo signal (e.g. for a DAT recorder).

 **If the *CD/TAPE OUT* signal is connected to a recording machine whose output signal is returned to the *CD/TAPE IN*, feedback can occur when you activate the record function on the recording machine. So, disconnect the *CD/TAPE IN* from the recording machine before you start recording or set the *CD/TAPE* input signal to zero!**

[58] *PMP1000*: The *MAIN OUT* jacks allow you to send the main line level signal to an external amplifier, when, for example, you want to use the mixer and effects section. The *PMP3000* and *PMP5000* have two separately controllable line level *MAIN* outputs [59] (*MAIN 1/2*).

[60] Connect your monitor power amps or active monitor speakers to the *MON 1/2 SEND* to monitor the signal mix created with the *MON* controls or to route it to the musicians on stage.

[61] The *PMP* Series comes with a *POWER AMP INSERT* connection that is provided for various applications. This connection enables you to use the power amplifier of the device to amplify the output signal of another preamp. For example, it is possible to connect a larger mixer or preamp output (line signal) of an instrument amplifier. In this case, you only need an unbalanced, mono jack cable.

Furthermore, it is possible to use the *POWER AMP INSERT* as a conventional insert to add a compressor or graphic equalizer to the signal path, for instance. Here, a balanced, stereo jack cable is required and the assignment of tip and ring needs to be observed according to Figure 4.5 (see Chapter 4.2 "Audio Connections"). In this case, the ring is the so-called *Send*, which is connected to the input of the additional device, and the tip is referred to as *Return*, which is connected to the output of the additional device.

Lastly, it is possible to tap the output signal of the device's mixer section from the *POWER AMP INSERT* in order to use a second, external power amp. A balanced, stereo jack cable is required with the ring (not the tip) connected to the input of the external power amp. If you want to use the internal and external power amps at the same time, just wire the connector's ring and tip together.

[62] The *FOOTSWITCH* jack is for a standard footswitch. You can activate an "effect bypass", thereby muting the effects processor. Use a dual foot switch for the *PMP5000*, so that you can enable/disable *FX1* and *FX2* independently of each other. In this case, the tip of the 1/4" plug controls *FX1*, and the ring *FX2*.

[63] *PMP3000/PMP5000*: The *MONO OUT* is for connecting a subwoofer. The *PMP5000* has the additional possibility of setting the low-frequency range for the subwoofer.

Use the *SUB FILTER* control [50] to adjust the frequency.

[64] The *FX SEND* connector can be used to route the *FX SEND* signal from the input channel, for example, to the input of an external effects device. Since the *PMP5000* has two *FX* controls per input signal (see [12]), both *FX SEND 1+2* are present at one jack.

 **Please note: The *SEND* signal is in parallel with the *FX SEND* jacks and with the effects processor, so that both can be controlled together by one control.**

 **For the *FX* signals, use a 1/4" stereo plug connected as follows: *FX1* = tip; *FX2* = ring**

[65] The *PHONS/CTRL* connector allows you to connect a pair of stereo headphones or an (active) monitor speaker.

2.5 Rear panel

[66] The mains connection is via a standard *IEC* receptacle. An appropriate power cord is supplied with the unit.

[67] *FUSE HOLDER*. Before connecting the unit to the mains, ensure that the voltage setting matches your local voltage. Blown fuses should only be replaced by fuses of the same type and rating. Please also read the information given in the "SPECIFICATIONS".

[68] Use the *POWER* switch to put your *PMP* into operation. The *POWER* switch should always be in the "Off" position before connecting your unit to the mains.

 **Please note: The *POWER* switch does not fully disconnect the unit from the mains. Unplug the power cord completely when the unit is not used for prolonged periods of time.**

[69] *SERIAL NUMBER*.

[70] This is where you find the cooling fan of the unit.
The *PMP5000* has two cooling fans.

[71] *OUTPUT A (LEFT)* provides either the left stereo main signal or the monitor signal in mono, depending on the operating mode selected (see [27]). NEVER use this output in bridged mono mode.

[72] *OUTPUT B (RIGHT/BRIDGE)* provides either the right stereo main signal, the main mix signal (mono) or the bridged mono signal, depending on the operating mode selected.

 **In *BRIDGE* mode always connect only one loudspeaker with an impedance of at least 8 Ω to the *OUTPUT B* jack! NEVER use *OUTPUT A* in *BRIDGE* mode!**

 **In all other operating modes the impedance of the connected loudspeaker must not fall below 4 Ω.**

3 DIGITAL EFFECTS PROCESSOR

24-BIT MULTI-EFFECTS PROCESSOR

This built-in effects module produces high-grade standard effects such as reverb, chorus, flanger, delay and various combination effects. The integrated effects module has the advantage of requiring no wiring. This way, the danger of creating ground loops or uneven signal levels is eliminated at the outset, completely simplifying the handling. These effect presets are designed to be added to dry signals.

 **Turn down the *FX* controls in those channel strips whose signals you don't wish to process.**

EUROPOWER PMP1000/PMP3000/PMP5000

4 INSTALLATION

4.1 Mains connection

The mains connection is made using the enclosed power cord and a standard IEC receptacle. It meets all of the international safety certification requirements.

Blown fuses must be replaced by fuses of the same type and rating.

 **Please make sure that all units have a proper ground connection. For your own safety, never remove or disable the ground conductor from the unit or of the AC power cord.**

4.2 Audio connections

The inputs and outputs of your BEHRINGER EUROPOWER are unbalanced 1/4" mono jacks—except for the mono channel line inputs, which are balanced 1/4" stereo jacks. Of course, all inputs and outputs work with both balanced and unbalanced connectors. The tape in and outputs are on RCA connectors.

 **Please ensure that only qualified personnel install and operate the PMP. During installation and operation, the user must have sufficient electrical contact to earth. Electrostatic charges might affect the operation of the unit.**

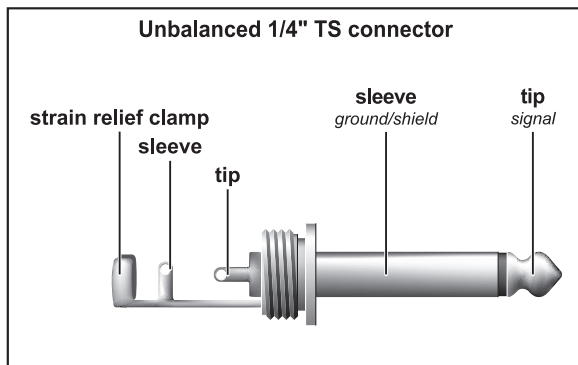

Fig. 4.1: 1/4" TS connector

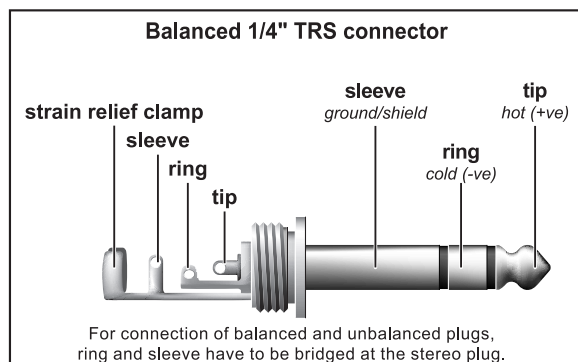

Fig. 4.2: 1/4" TRS connector

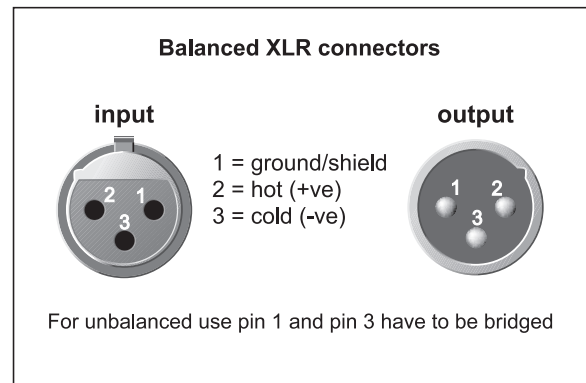

Fig. 4.3: XLR connectors

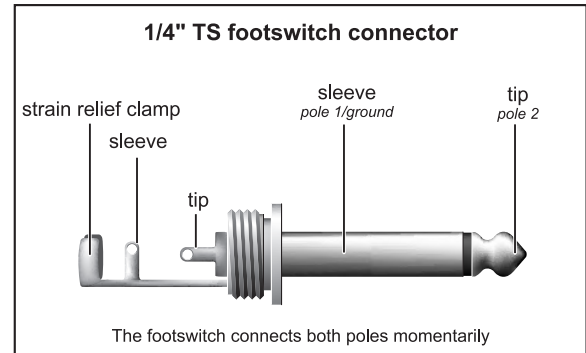

Fig. 4.4: 1/4" mono plug for footswitch

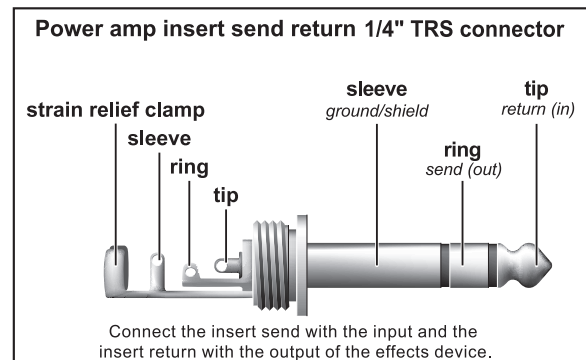

Fig. 4.5: Stereo 1/4" TRS connector for power amp ISR connection

en

EUROPOWER PMP1000/PMP3000/PMP5000

4.3 Loudspeaker connections

Your power mixer is equipped with high-quality loudspeaker connectors (compatible to Neutrik® Speakon®), which ensure safe and trouble-free operation. The Speakon® connector was especially developed for high-power loudspeakers. Once it is plugged in, it safely locks into position and cannot be accidentally disengaged. It prevents the occurrence of electrical shock and ensures the correct polarity. Each of the loudspeaker jacks carries only the assigned single signal (see the information given on the rear panel of the power mixer).

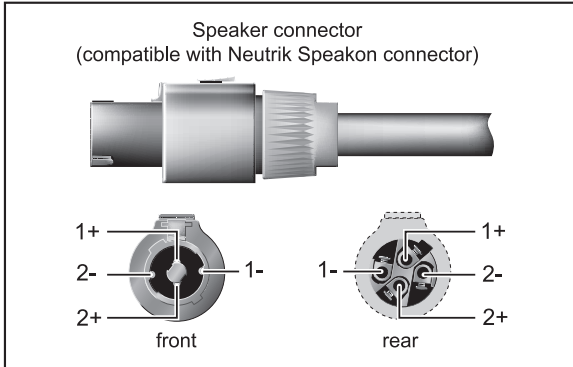

Fig. 4.6: Professional speaker connector with polarity allocation

Please be sure to only use commercial Speakon® cables (type NL4FC) for connecting your loudspeakers to the power mixer. Please check the pin assignment of your loudspeakers and cables dependent on the PMP speaker output you choose.

EUROPOWER PMP1000/PMP3000/PMP5000				
OUTPUT A	1+	1-	2+	2-
MAIN L	x	x		
MONITOR	x	x		
MONO	x	x		
OUTPUT B			x	x
OUTPUT B	1+	1-	2+	2-
MAIN R	x	x		
MONO	x	x		
MONO	x	x		
BRIDGE	x		x	

Tab. 4.1: Polarity configuration of speaker connectors

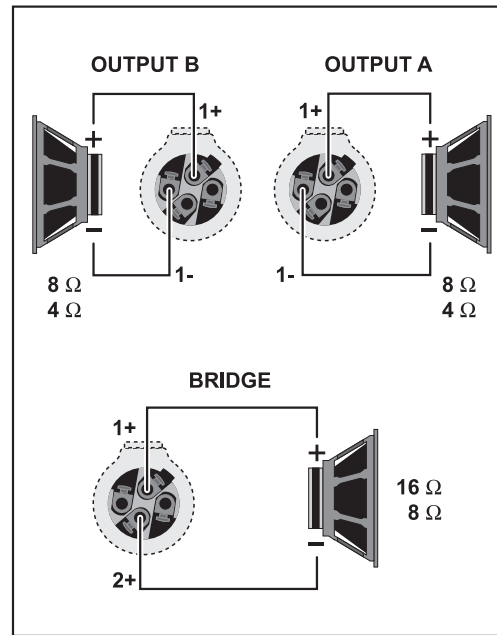

Fig. 4.7: Speakon® pin assignment

EUROPOWER PMP1000/PMP3000/PMP5000

5 WIRING EXAMPLES

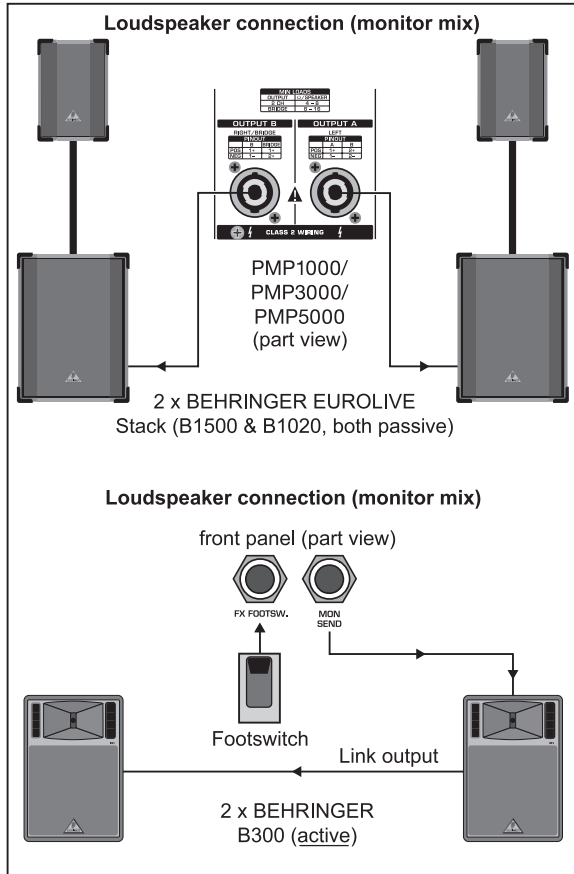

Fig. 5.1: Stereo operation

For stereo operation the POWER AMP switch [27] must be set to its upper position (MAIN or MAIN L/MAIN R). Outputs A and B provide the stereo main signal for passive speakers. The preamp monitor output is connected to two parallel active speakers, which are used as on-stage monitors. Use the footswitch to enable/disable the effects processor.

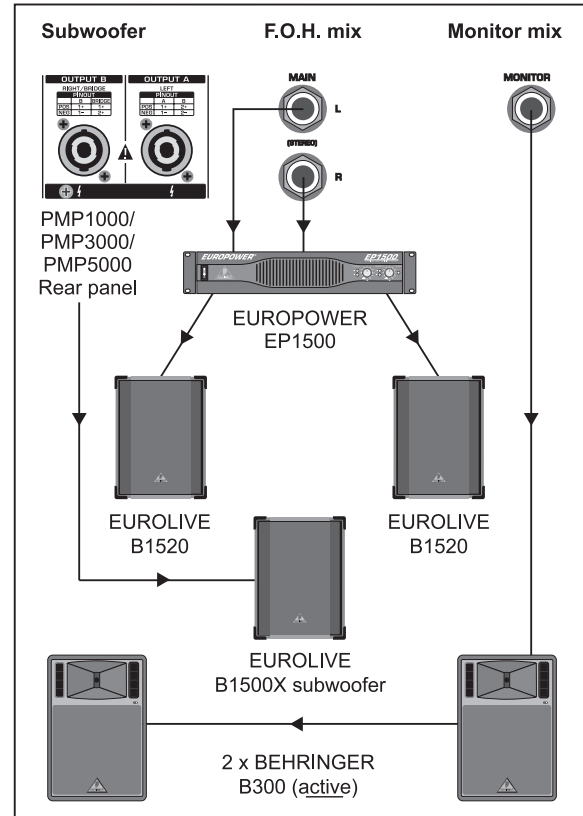

Fig. 5.2: Bridged mono operation

This illustration shows the power mixer with a sub-woofer connected to OUTPUT B. For a bridged mono operation to OUTPUT B, the AMP MODE selector switch [27] must be set to its lower position "BRIDGE". A separate stereo power amp (BEHRINGER EUROPOWER EP1500) connected to the preamp main outputs delivers the stereo main signal. Two active monitor speakers for on-stage operation are connected to the preamp monitor output.

EUROPOWER PMP1000/PMP3000/PMP5000

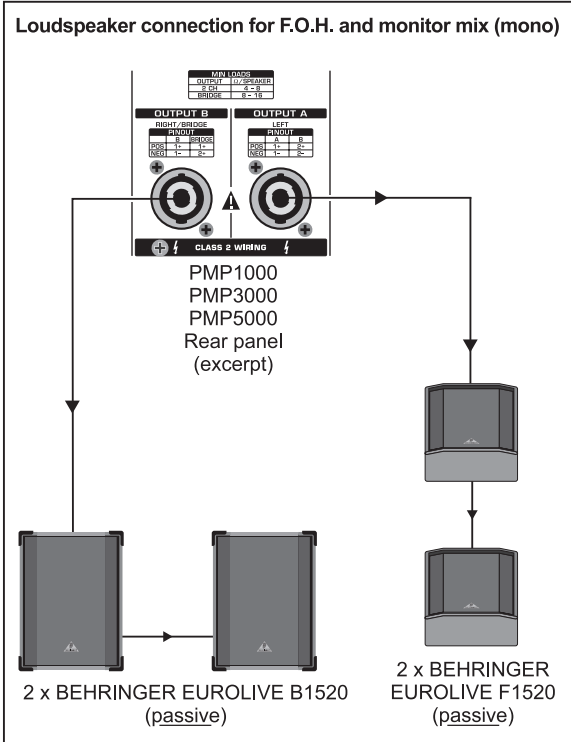

Fig. 5.3: Dual mono operation

For a dual mono operation, the AMP MODE switch [27] must be set to its **center** position (MON1/MONO for PMP3000/PMP5000 or MON for PMP1000)! The two loudspeaker outputs provide the main and the monitor signals, separately from each another. Each of these signals is then sent to two speakers wired in parallel.

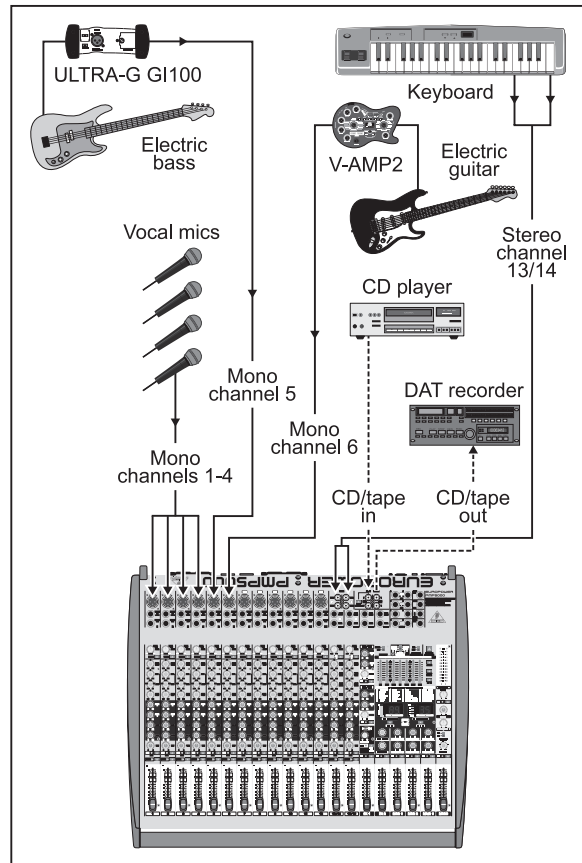

Fig. 5.4: Standard set-up (example)

The illustration shows just one channel configuration possible, comprising mono and stereo sources and additionally the tape input/output for recording the mix signal or feeding in a playback signal.

EUROPOWER PMP1000/PMP3000/PMP5000

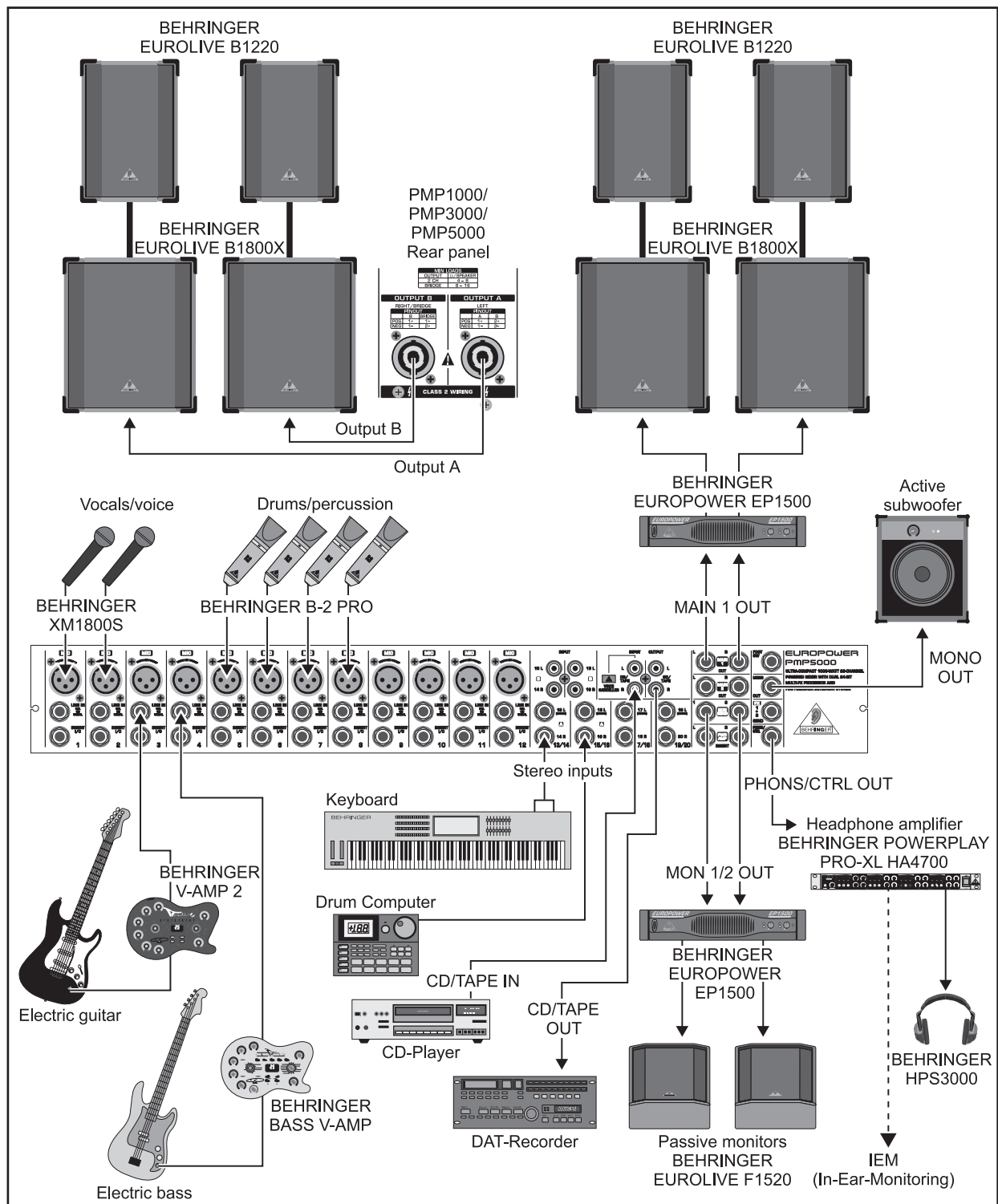

Fig. 5.5: Expanded set-up

This application is an expanded set-up based on the standard set-up as shown in fig. 5.4, and provides additional connection options. Again, this is just an example, which can be expanded in various ways.

EUROPOWER PMP1000/PMP3000/PMP5000

6 SPECIFICATIONS

	PMP1000	PMP3000	PMP5000
MICROPHONE INPUTS			
Type	XLR, electronically balanced, discrete input circuit		
Mic E.I.N. (20 Hz - 20 kHz)			
@ 0 Ω source resistance	-134 dB / 136 dB A-weighted		
@ 50 Ω source resistance	-131.5 dB / 134 dB A-weighted		
@ 150 Ω source resistance	-129 dB / 131 dB A-weighted		
Frequency response	< 10 Hz - 155 kHz (-1 dB)		
	< 10 Hz - > 200 kHz (-3 dB)		
Gain	+10 dB, +60 dB		
Max. input level	+12 dBu @ +10 dB gain		
Impedance	approx. 2.6 k Ω balanced / 1.3 k Ω unbalanced		
Signal-to-noise ratio	109 dB / 112 dB A-weighted (0 dBu IN @ +10 dB gain)		
Distortion (THD+N)	0.002% / 0.0018% A-weighted		
MONO LINE INPUTS			
Type	1/4" TS connectors, balanced		
Impedance	approx. 20 k Ω		
Max. input level	+21 dBu		
STEREO LINE INPUTS			
Type	1/4" TRS connectors, unbalanced		
Impedance	> 3.6 k Ω		
Max. input level	+22 dBu		
EQUALIZER			
Low	80 Hz / \pm 15 dB		
Mid	2.5 kHz / \pm 15 dB	100 Hz - 8 kHz / \pm 15 dB	
High	12 kHz / \pm 15 dB		
CD/TAPE INPUT			
Type	RCA		
Impedance	approx. 3.6 k Ω , balanced		
Max. input level	+21 dBu		
PRE AMP OUTPUTS			
MAIN			
Type	1/4" TRS connectors, unbalanced		
Impedance	approx. 150 Ω , unbalanced		
Max. output level	+21 dBu		
MONITOR			
Type	1/4" TRS connectors, unbalanced		
Impedance	approx. 150 Ω , unbalanced		
Max. output level	+21 dBu		
STEREO OUTPUTS			
Type	-	1/4" TRS connectors, unbalanced	
Impedance	-	approx. 150 Ω , unbalanced	
Max. output level	-	+21 dBu	
Type	RCA	RCA	
Impedance	approx. 1 k Ω	approx. 1 k Ω	
Max. output level	+21 dBu	+21 dBu	
MAIN MIX SYSTEM DATA			
Noise			
MAIN MIX @ - ∞	-102 dB/-106 dB A-weighted		-96 dB/-100 dB A-weighted
Channel fader - ∞			
MAIN MIX @ 0 dB	-88 dB/-91 dB A-weighted		-86 dB/-89 dB A-weighted
Channel fader - ∞			
MAIN MIX @ 0 dB	-84 dB/-86 dB A-weighted		-83 dB/-85 dB A-weighted
Channel fader @ 0 dB			
LOUDSPEAKER OUTPUTS			
Type	compatible to NEUTRIK [®] SPEAKON [®]		
Load impedance			
MAIN L/R	4 - 8 Ω		
MONITOR/MAIN MONO	4 - 8 Ω		
MAIN MONO/MAIN MONO	4 - 8 Ω		
BRIDGE	8 - 16 Ω		

EUROPOWER PMP1000/PMP3000/PMP5000

	PMP1000	PMP3000	PMP5000
DSP			
Converter	24-Bit Delta-Sigma, 64/128-times oversampling		
Dynamics D/A	90 dB		
Sampling rate	46.875 kHz		
Delay Time	max. 5 s		
Signal run time (Line In à Line Out)	approx. 1.5 ms		
DISPLAY			
Type	dual 7-segment LED		2 dual 7-segment LED
AMPLIFIER			
OUTPUT POWER			
RMS @ 1 % THD (sine wave), both channels driven:			
8 Ω per channel	90 W		215 W
4 Ω per channel	130 W		450 W
RMS @ 1 % THD (sine wave), bridged mode:			
8 Ω	200 W		900 W
Peak Power, both channels driven:			
8 Ω per channel	135 W		300 W
4 Ω per channel	250 W		600 W
Peak Power, bridged mode:			
8 Ω	500 W		1200 W
POWER SUPPLY (EU/A)			
Mains voltage	100 - 240 V~, 50 / 60 Hz		230 V~, 50 Hz
Power consumption	500 W		1000 W
Fuse	T 5 A H 250 V		T 6,3 A H 250 V
Mains connector	Standard IEC receptacle		
POWER SUPPLY (UL)			
Mains voltage	100 - 240 V~, 50 / 60 Hz		120 V~, 60 Hz
Power consumption	500 W		1000 W
Fuse	T 5 A H 250 V		T 10 A H 250 V
Mains connector	Standard IEC receptacle		
POWER SUPPLY (J)			
Mains voltage	100 - 240 V~, 50 / 60 Hz		100 V~, 50 / 60 Hz
Power consumption	500 W		1000 W
Fuse	T 5 A H 250 V		T 10 A H 250 V
Mains connector	Standard IEC receptacle		
POWER SUPPLY (CN)			
Mains voltage	100 - 240 V~, 50 / 60 Hz		220 V~, 50 Hz
Power consumption	500 W		1000 W
Fuse	T 5 A H 250 V		T 6,3 A H 250 V
Mains connector	Standard IEC receptacle		
PHYSICAL/WEIGHT			
Dimensions (H x W x D)	4 7/8" x 15 3/8" x 16 3/4"	4 7/8" x 18 3/4" x 18 1/8"	4 7/8" x 23 1/2" x 19 1/2"
	122 x 390 x 425 mm	122 x 476 x 460 mm	122 x 596 x 496 mm
Weight	15.435 lb.	23.815 lb.	28.665 lb.
	8 kg	10.8 kg	13.3 kg



BEHRINGER is constantly striving to maintain the highest professional standards. As a result of these efforts, modifications may be made from time to time to existing products without prior notice. Specifications and appearance may differ from those listed or illustrated.

EUROPOWER PMP1000/PMP3000/PMP5000

7 WARRANTY

§ 1 OTHER WARRANTY RIGHTS AND NATIONAL LAW

1. This warranty does not exclude or limit the buyer's statutory rights provided by national law, in particular, any such rights against the seller that arise from a legally effective purchase contract.
2. The warranty regulations mentioned herein are applicable unless they constitute an infringement of national warranty law.

§ 2 ONLINE REGISTRATION

Please do remember to register your new BEHRINGER equipment right after your purchase by visiting www.behringer.com (alternatively www.behringer.de) and kindly read the terms and conditions of our warranty carefully.

Registering your purchase and equipment with us helps us process your repair claims quicker and more efficiently.

Thank you for your cooperation!

§ 3 WARRANTY

1. BEHRINGER (BEHRINGER International GmbH including all BEHRINGER subsidiaries listed on the enclosed page, except BEHRINGER Japan) warrants the mechanical and electronic components of this product to be free of defects in material and workmanship for a period of one (1) year* from the original date of purchase, in accordance with the warranty regulations described below. If the product shows any defects within the specified warranty period that are not excluded from this warranty as described under § 5, BEHRINGER shall, at its discretion, either replace or repair the product using suitable new or reconditioned parts. In the case that other parts are used which constitute an improvement, BEHRINGER may, at its discretion, charge the customer for the additional cost of these parts.
2. If the warranty claim proves to be justified, the product will be returned to the user freight prepaid.
3. Warranty claims other than those indicated above are expressly excluded.

§ 4 RETURN AUTHORIZATION NUMBER

1. To obtain warranty service, the buyer (or his authorized dealer) must call BEHRINGER (see enclosed list) during normal business hours **BEFORE** returning the product. All inquiries must be accompanied by a description of the problem. BEHRINGER will then issue a return authorization number.
2. Subsequently, the product must be returned in its original shipping carton, together with the return authorization number to the address indicated by BEHRINGER.
3. Shipments without freight prepaid will not be accepted.

§ 5 WARRANTY REGULATIONS

1. Warranty services will be furnished only if the product is accompanied by a copy of the original retail dealer's invoice. Any product deemed eligible for repair or replacement under the terms of this warranty will be repaired or replaced.

2. If the product needs to be modified or adapted in order to comply with applicable technical or safety standards on a national or local level, in any country which is not the country for which the product was originally developed and manufactured, this modification/adaptation shall not be considered a defect in materials or workmanship. The warranty does not cover any such modification/adaptation, irrespective of whether it was carried out properly or not. Under the terms of this warranty, BEHRINGER shall not be held responsible for any cost resulting from such a modification/adaptation.

3. Free inspections and maintenance/repair work are expressly excluded from this warranty, in particular, if caused by improper handling of the product by the user. This also applies to defects caused by normal wear and tear, in particular, of faders, crossfaders, potentiometers, keys/buttons, tubes, guitar strings, illuminants and similar parts.

4. Damages/defects caused by the following conditions are not covered by this warranty:

- ▲ improper handling, neglect or failure to operate the unit in compliance with the instructions given in BEHRINGER user or service manuals.
- ▲ connection or operation of the unit in any way that does not comply with the technical or safety regulations applicable in the country where the product is used.
- ▲ damages/defects caused by force majeure or any other condition that is beyond the control of BEHRINGER.

5. Any repair or opening of the unit carried out by unauthorized personnel (user included) will void the warranty.

6. If an inspection of the product by BEHRINGER shows that the defect in question is not covered by the warranty, the inspection costs are payable by the customer.

7. Products which do not meet the terms of this warranty will be repaired exclusively at the buyer's expense. BEHRINGER will inform the buyer of any such circumstance. If the buyer fails to submit a written repair order within 6 weeks after notification, BEHRINGER will return the unit C.O.D. with a separate invoice for freight and packing. Such costs will also be invoiced separately when the buyer has sent in a written repair order.

§ 6 WARRANTY TRANSFERABILITY

This warranty is extended exclusively to the original buyer (customer of retail dealer) and is not transferable to anyone who may subsequently purchase this product. No other person (retail dealer, etc.) shall be entitled to give any warranty promise on behalf of BEHRINGER.

§ 7 CLAIM FOR DAMAGES

Failure of BEHRINGER to provide proper warranty service shall not entitle the buyer to claim (consequential) damages. In no event shall the liability of BEHRINGER exceed the invoiced value of the product.

* Customers in the European Union please contact BEHRINGER Germany Support for further details.

Technical specifications and appearance subject to change without notice. The information contained herein is correct at the time of printing. The names of companies, institutions or publications pictured or mentioned and their respective logos are registered trademarks of their respective owners. Their use neither constitutes a claim of the trademarks by BEHRINGER nor affiliation of the trademark owners with BEHRINGER. BEHRINGER accepts no liability for any loss which may be suffered by any person who relies either wholly or in part upon any description, photograph or statement contained herein. Colours and specification may vary slightly from product. Products are sold through our authorised dealers only. Distributors and dealers are not agents of BEHRINGER and have absolutely no authority to bind BEHRINGER by any express or implied undertaking or representation. No part of this manual may be reproduced or transmitted in any form or by any means, electronic or mechanical, including photocopying and recording of any kind, for any purpose, without the express written permission of BEHRINGER International GmbH. BEHRINGER® is a registered trademark.

ALL RIGHTS RESERVED. © 2006 BEHRINGER International GmbH,
Hanns-Martin-Schleyer-Str. 36-38, 47877 Willich-Münchheide II, Germany.
Tel. +49 2154 9206 0, Fax +49 2154 9206 4903

EUROPOWER PMP1000/PMP3000/PMP5000

FEDERAL COMMUNICATIONS COMMISSION

COMPLIANCE INFORMATION



Responsible party name: BEHRINGER USA, Inc.
Address: 18912 North Creek Parkway, Suite 200
Bothell, WA 98011, USA
Phone/Fax No.: Phone: +1 425 672 0816,
Fax: +1 425 673 7647

hereby declares that the product

EUROPOWER PMP1000/3000/5000

complies with the FCC rules as mentioned in the following paragraph:

This equipment has been tested and found to comply with the limits for a Class B digital device, pursuant to part 15 of the FCC Rules. These limits are designed to provide reasonable protection against harmful interference in a residential installation. This equipment generates, uses and can radiate radio frequency energy and, if not installed and used in accordance with the instructions, may cause harmful interference to radio communications. However, there is no guarantee that interference will not occur in a particular installation. If this equipment does cause harmful interference to radio or television reception, which can be determined by turning the equipment off and on, the user is encouraged to try to correct the interference by one or more of the following measures:

- ▲ Reorient or relocate the receiving antenna.
- ▲ Increase the separation between the equipment and receiver.
- ▲ Connect the equipment into an outlet on a circuit different from that to which the receiver is connected.
- ▲ Consult the dealer or an experienced radio/TV technician for help.

This device complies with Part 15 of the FCC rules. Operation is subject to the following two conditions: (1) this device may not cause harmful interference, and (2) this device must accept any interference received, including interference that may cause undesired operation.

Important information:

Changes or modifications to the equipment not expressly approved by BEHRINGER USA can void the user's authority to use the equipment.

en