

SERVICE MANUAL **& PARTS LIST** (with price)

POCKET TELEVISION

TV-600B

DECEMBER 1994

	Page
Specifications.....	1
Block Diagram	2
Circuit Description.....	3
Adjustment	
Linear PCB.....	5
A/D PCB	9
Troubleshooting	10
Printed Circuit Boards	11
Wiring Diagram	15
Exploded View / Disassembly.....	16
Electrical Parts List	17
Mechanical Parts List.....	23
IC and Transistor Lead Identification	24
Schematic Diagrams and Waveforms	26

CASIO®

SCHMATIC DIAGRAMS AND WAVEFORMS

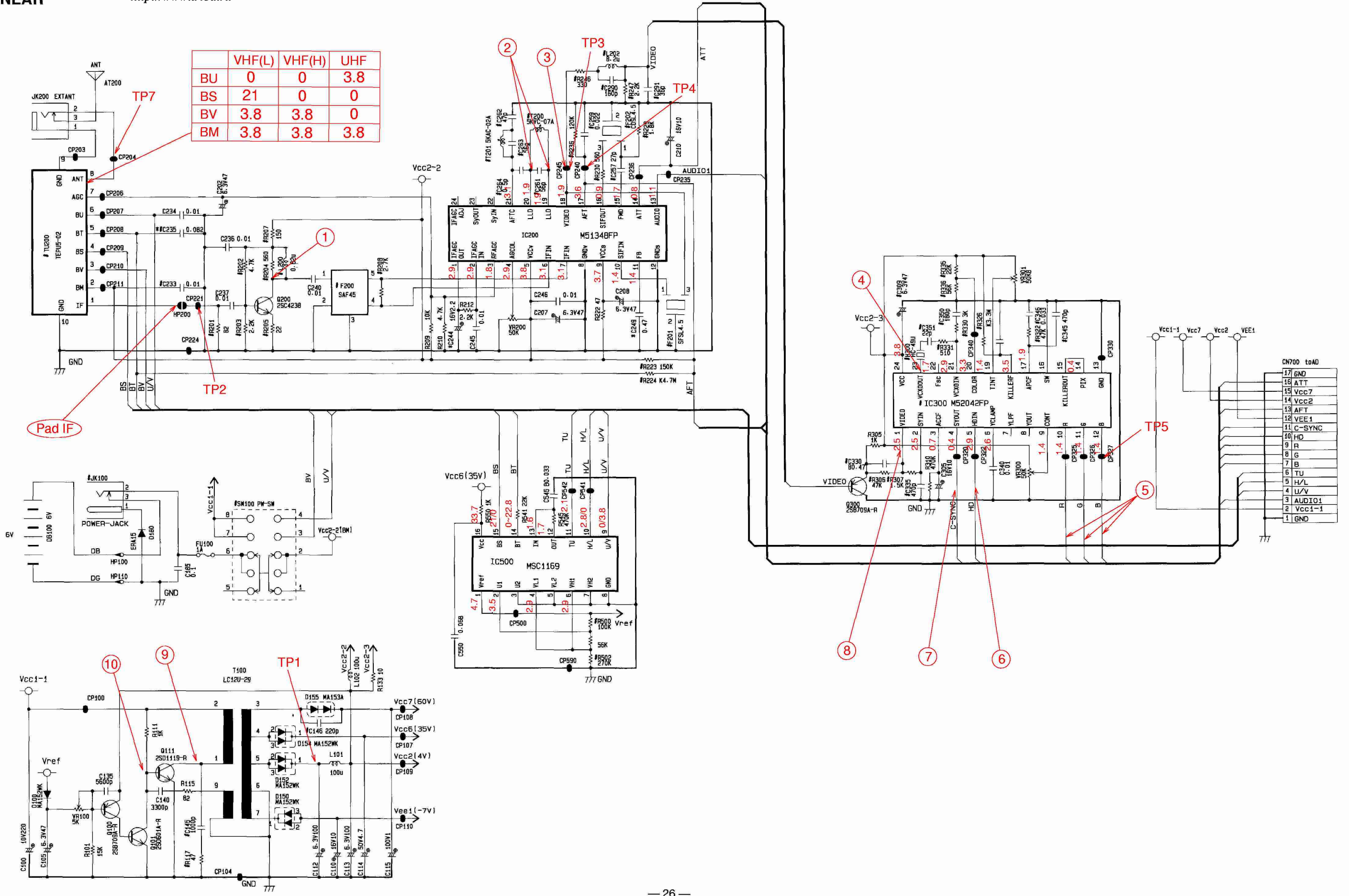

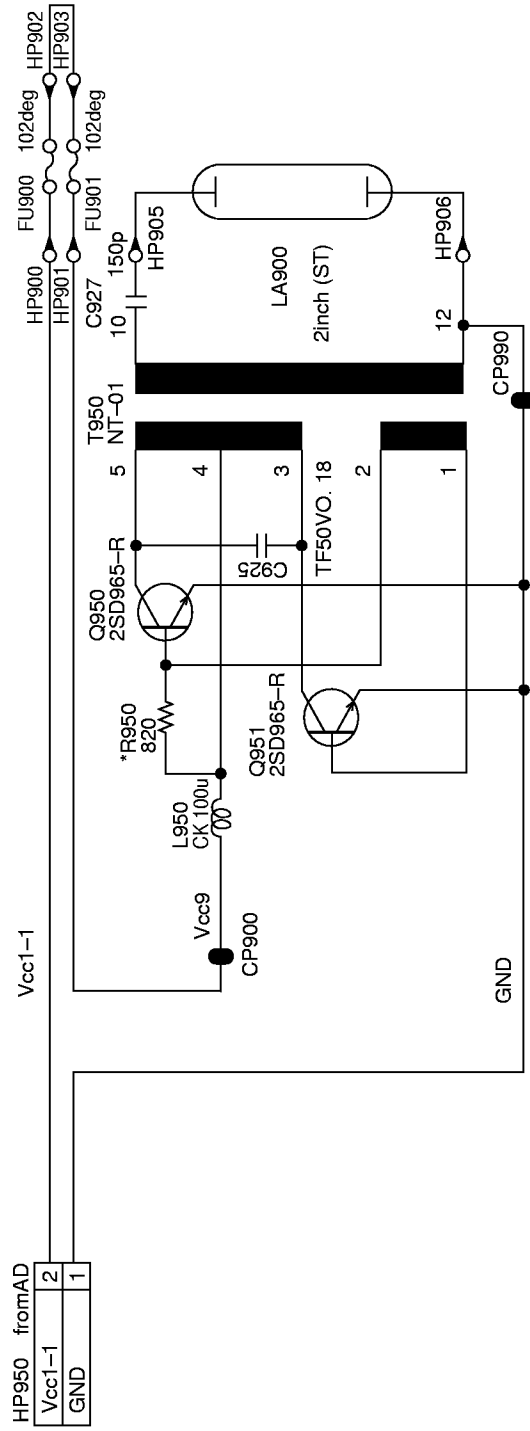

WAVEFORMS

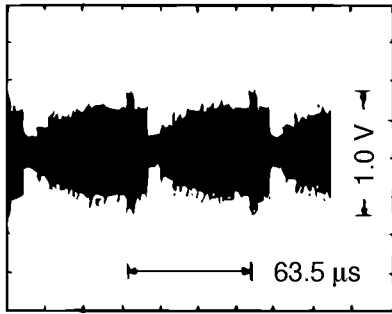

① Q200 Collector

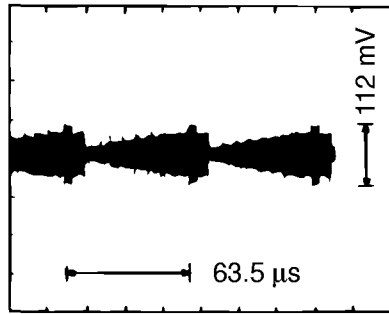

② IC200 Pin 19

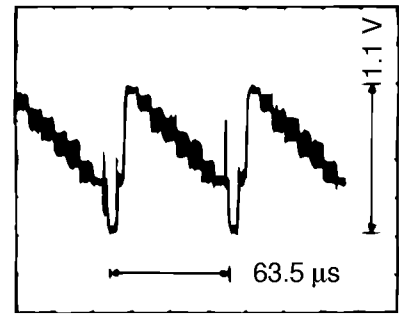

③ IC200 Pin 18

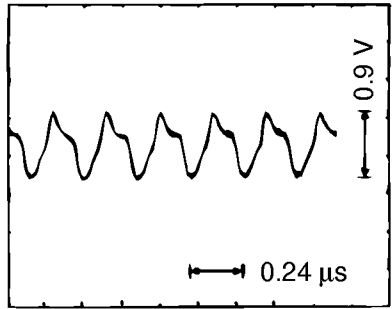

④ IC300 Pin 23

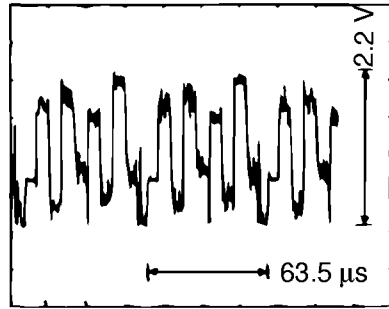

⑤ IC300 Pins 10, 11, 12

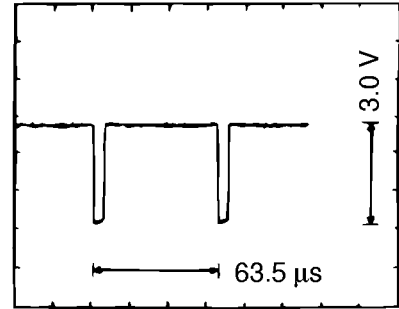

⑥ IC300 Pin 5

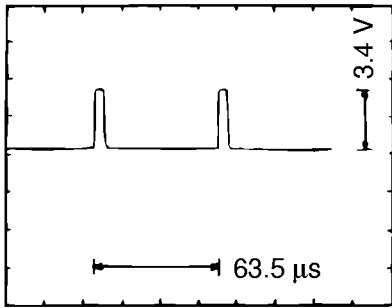

⑦ IC300 Pin 4

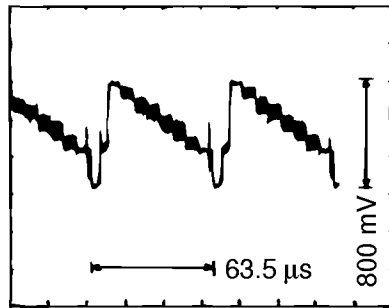

⑧ IC300 Pin 1

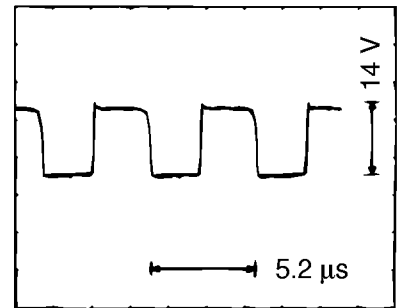

⑨ Q111 Collector

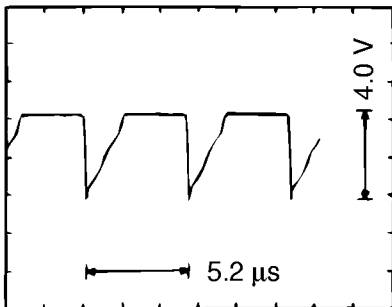

⑩ Q111 Base

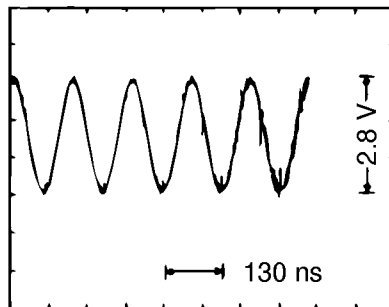

⑪ IC700 Pin 16

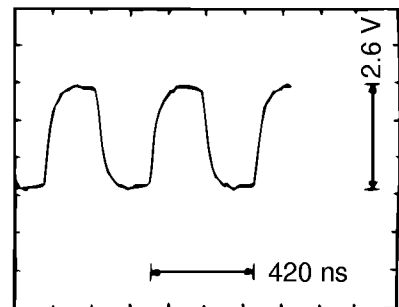

⑫ IC700 Pin 14