

Service Manual

PIONEER
The Art of Entertainment

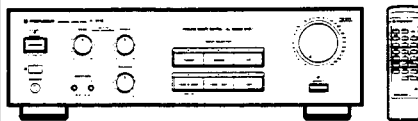

ORDER NO.
ARP2552

STEREO AMPLIFIER **A-351R**

A-351R HAS THE FOLLOWING:

Type	Power Requirement	Remarks
HEWZ	AC 220 V-230 V, 240 V (switchable)*	
HE	AC 220 V-230 V, 240 V (switchable)*	
HB	AC 220 V-230 V, 240 V (switchable)*	

* Change the connection of the power transformer's primary wiring.

- This manual is applicable to HEWZ, HE and HB types.
- For HE and HB types, refer to page 18.

CONTENTS

1. EXPLODED VIEWS, PACKING AND PARTS LIST	2
2. SCHEMATIC AND PCB CONNECTIONS DIAGRAMS	6
3. PCB PARTS LIST	15
4. FOR HE AND HB TYPES	18
5. PANEL FACILITIES	20
6. SPECIFICATIONS	22

PIONEER ELECTRONIC CORPORATION 4-1, Meguro 1-Chome, Meguro-ku, Tokyo 153, Japan
PIONEER ELECTRONICS SERVICE INC. P.O. Box 1760, Long Beach, California 90801 U.S.A.
PIONEER ELECTRONICS OF CANADA, INC. 300 Allstate Parkway Markham, Ontario L3R 0P2 Canada
PIONEER ELECTRONIC [EUROPE] N.V. Haven 1087 Keetberglaan 1, 9120 Melsele, Belgium
PIONEER ELECTRONICS AUSTRALIA PTY. LTD. 178-184 Boundary Road, Braeside, Victoria 3195, Australia TEL: [03] 580-9911
© PIONEER ELECTRONIC CORPORATION 1992

FF JUN. 1992 Printed in Japan

1. EXPLODED VIEWS, PACKING AND PARTS LIST

NOTES:

- Parts marked by "NSP" are generally unavailable because they are not in our Master Spare Parts List.
- The Δ mark found on some component parts indicates the importance of the safety factor of the part. Therefore, when replacing, be sure to use parts of identical designation.
- Parts marked by "⊙" are not always kept in stock. Their delivery time may be longer than usual or they may be unavailable.

1.1 PARTS LIST

Mark	No.	Description	Parts No.	Mark	No.	Description	Parts No.
	1	ROTARY KNOB S (PLS)	AAB1276		31	PACKING CASE	AHD2229
	2	ROTARY KNOB L (PLS)	AAB1277		32	PACKING SHEET	AHG1016
	3	PUSH KNOB	AAD1366	NSP	33	TERMINAL SCREW	AKE-031
	4	POWER KNOB	AAD1984		34	PANEL BASE	AMB1951
	5	FUNCTION KNOB	AAD2214		35	INDICATING LENS	AMR1160
	6	PUSH KNOB	AAD2221		36	INSULATOR ASSY	AMR2140
	7	SENSOR WINDOW	AAK1783	NSP	37	CHASSIS	ANA1110
	8	LENS (PLS)	AAK2048		38	FRONT PANEL	ANB1493
NSP	9	SP SWITCH ASS'Y	AWZ4109	NSP	39	REAR PANEL	ANC1847
	10	NAME PLATE (METAL)	AAM1029	NSP	40	TRANS ASS'Y	AWZ4111
	11	SCREW	ABA-298		41	METAL BONNET	ANE1363
	12	SCREW (STEEL)	ABA1011	NSP	42	HEAT SINK	ANH1319
	13	SCREW (STEEL)	ABA1047		43	OPERATING INSTRUCTIONS (German)	ARC1328
	14	SCREW (STEEL)	ABA1048	⊙	44	AF ASS'Y	AWZ4107
	15	SCREW	ABA1054	⊙	45	CONTROL ASS'Y	AWZ4108
	16	SCREW	ABA1082		46	REMOTE CONTROL UNIT (CU-A002)	AXD1260
	17	COIL SPRING	ABH1064		47	BATTERY LID	AZA1297
	18	SPRING B	ABH1082		48	SCREW	BBZ30P060FZK
	19	NUT	ABN-065		49	NUT	NK90FUC
Δ	20	AC POWER CORD	ADG1021		50	LED LENS	PNW2019
NSP	21	MOTOR VOL ASS'Y	AWZ4110		51	SCREW	VMZ30P060FMC
NSP	22	PCB SUPPORT	AEC1215		52	FUSE(FU1)(T1.25A/250V)	AEK-509
NSP	23	PCB SUPPORT	AEC1216	Δ	53	TRANSISTOR(Q1)	2SC3180N
NSP	24	PCB SUPPORT	AEC1232	Δ	54	TRANSISTOR(Q2)	2SC3180N
NSP	25	BARRIER	AEC1241	Δ	55	TRANSISTOR(Q3)	2SA1263N
	26	SHEET	AEE1014		56	TRANSISTOR(Q4)	2SA1263N
NSP	27	BINDER	AEP-215	Δ	57	POWER TRANSFORMER(T1)	ATS1421
NSP	28	BATTERY(R03,AAA)	AEX-021				
	29	FRONT PAD	AHA1336				
	30	REAR PAD	AHA1337				

2. SCHEMATIC AND PCB CONNECTIONS DIAGRAMS

2.1 SCHEMATIC DIAGRAM

A

B

C

D

E

F

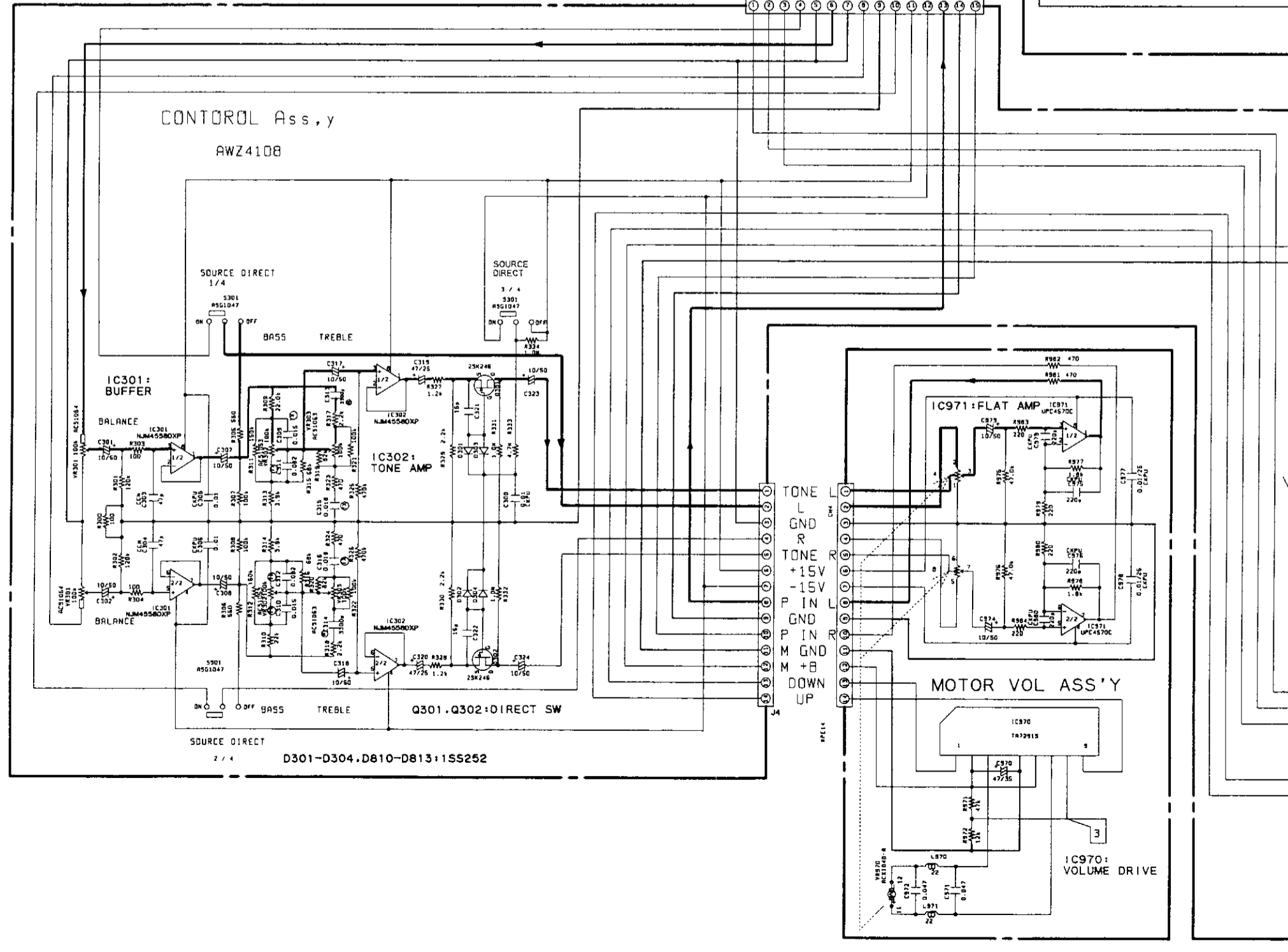
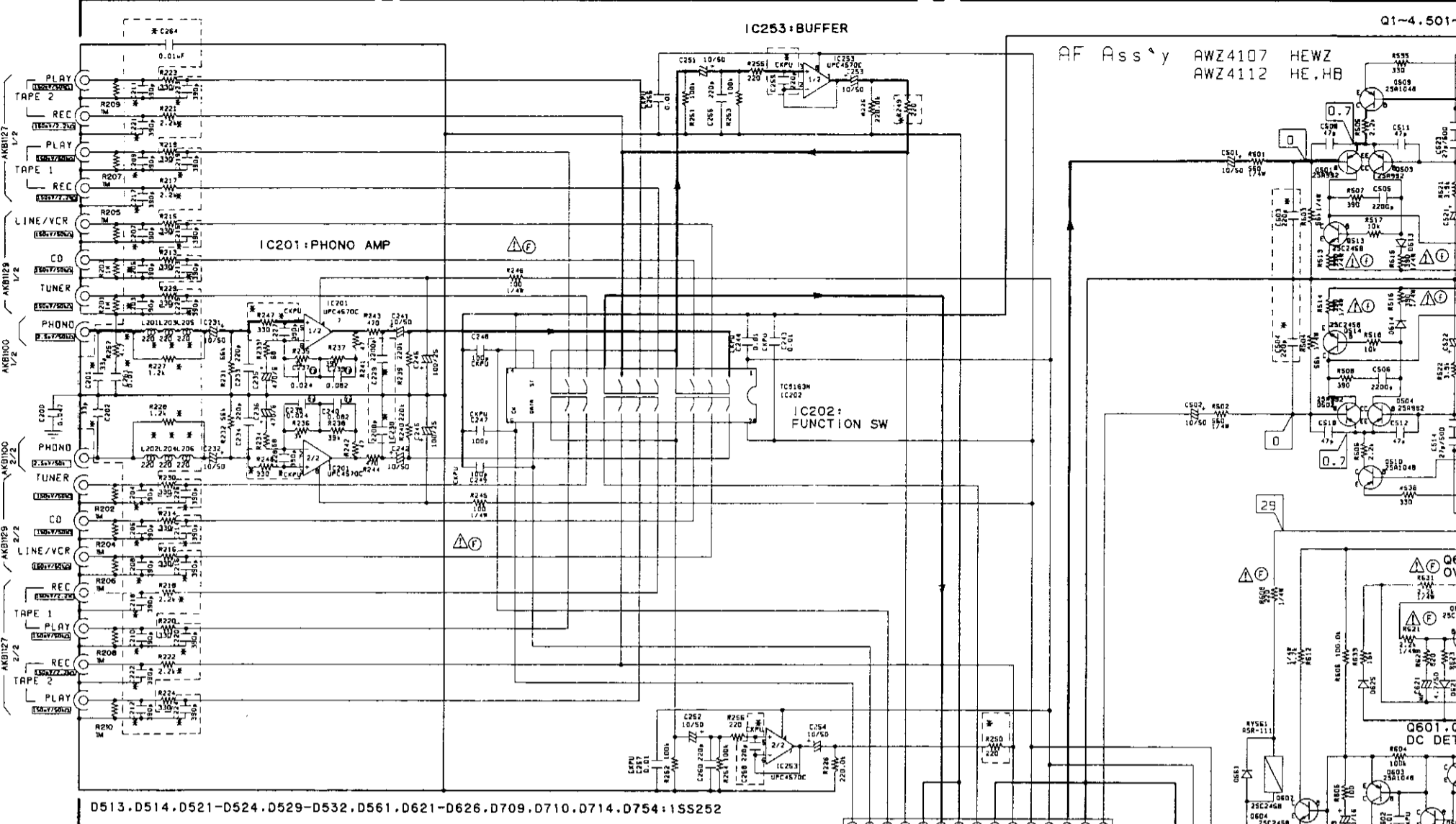

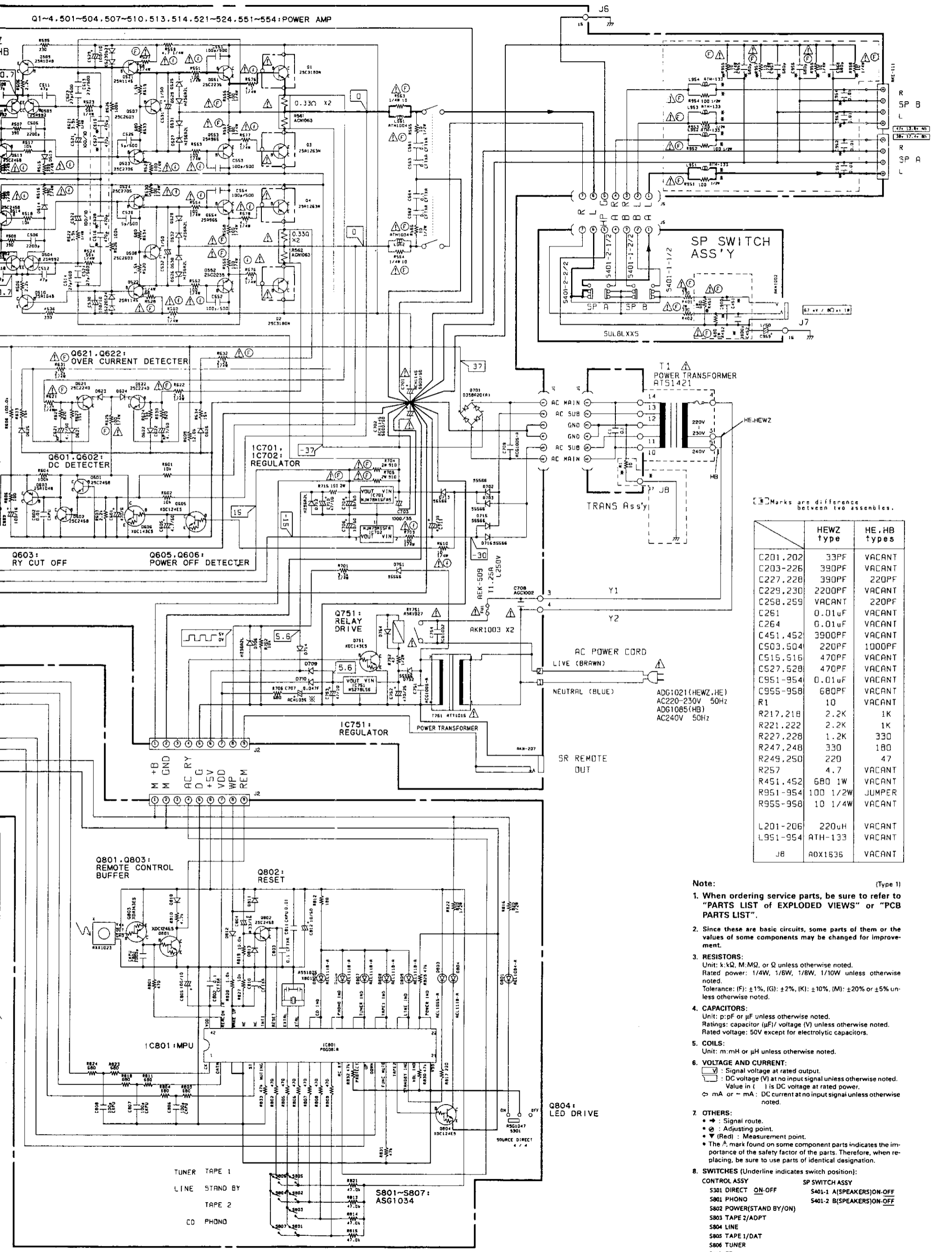

Ⓜ Marks are difference between two assemblies.

	HEWZ type	HE, HB types
C201-202	33PF	VACANT
C203-226	390PF	VACANT
C227-228	390PF	220PF
C229-230	2200PF	VACANT
C258-259	VACANT	220PF
C261	0.01uF	VACANT
C264	0.01uF	VACANT
C451-452	3900PF	VACANT
C503-504	220PF	1000PF
C515-516	470PF	VACANT
C527-528	470PF	VACANT
C951-954	0.01uF	VACANT
C955-958	680PF	VACANT
R1	10	VACANT
R217-218	2.2K	1K
R221-222	2.2K	1K
R227-228	1.2K	330
R247-248	330	180
R249-250	220	47
R257	4.7	VACANT
R451-452	680 1W	VACANT
R951-954	100 1/2W	JUMPER
R955-958	10 1/4W	VACANT
L201-206	220uH	VACANT
L951-954	ATH-133	VACANT
J8	ADX1535	VACANT

Note: (Type 1)

- When ordering service parts, be sure to refer to "PARTS LIST of EXPLODED VIEWS" or "PCB PARTS LIST".
- Since these are basic circuits, some parts of them or the values of some components may be changed for improvement.
- RESISTORS:**
Unit: k:K, M:MQ, or Ω unless otherwise noted.
Rated power: 1/4W, 1/6W, 1/8W, 1/10W unless otherwise noted.
Tolerance: (F): ±1%, (G): ±2%, (K): ±10%, (M): ±20% or ±5% unless otherwise noted.
- CAPACITORS:**
Unit: p:pF or μF unless otherwise noted.
Ratings: capacitor (μF)/ voltage (V) unless otherwise noted.
Rated voltage: 50V except for electrolytic capacitors.
- COILS:**
Unit: m:mH or μH unless otherwise noted.
- VOLTAGE AND CURRENT:**
Ⓜ : Signal voltage at rated output.
Ⓜ : DC voltage (V) at no input signal unless otherwise noted.
Value in () is DC voltage at rated power.
Ⓜ : mA or - mA : DC current at no input signal unless otherwise noted.
- OTHERS:**
• : Signal route.
Ⓜ : Adjusting point.
Ⓜ (Red) : Measurement point.
• The Ⓜ mark found on some component parts indicates the importance of the safety factor of the parts. Therefore, when replacing, be sure to use parts of identical designation.
- SWITCHES (Underline indicates switch position):**
CONTROL ASSY SP SWITCH ASSY
S301 DIRECT ON-OFF S401-1 A(SPEAKERS)ON-OFF
S801 PHONO S401-2 B(SPEAKERS)ON-OFF
S802 POWER(STAND BY)ON
S803 TAPE 2/ADPT
S804 LINE
S805 TAPE 1/DAT
S806 TUNER
S807 CD

1.2 EXTERIOR

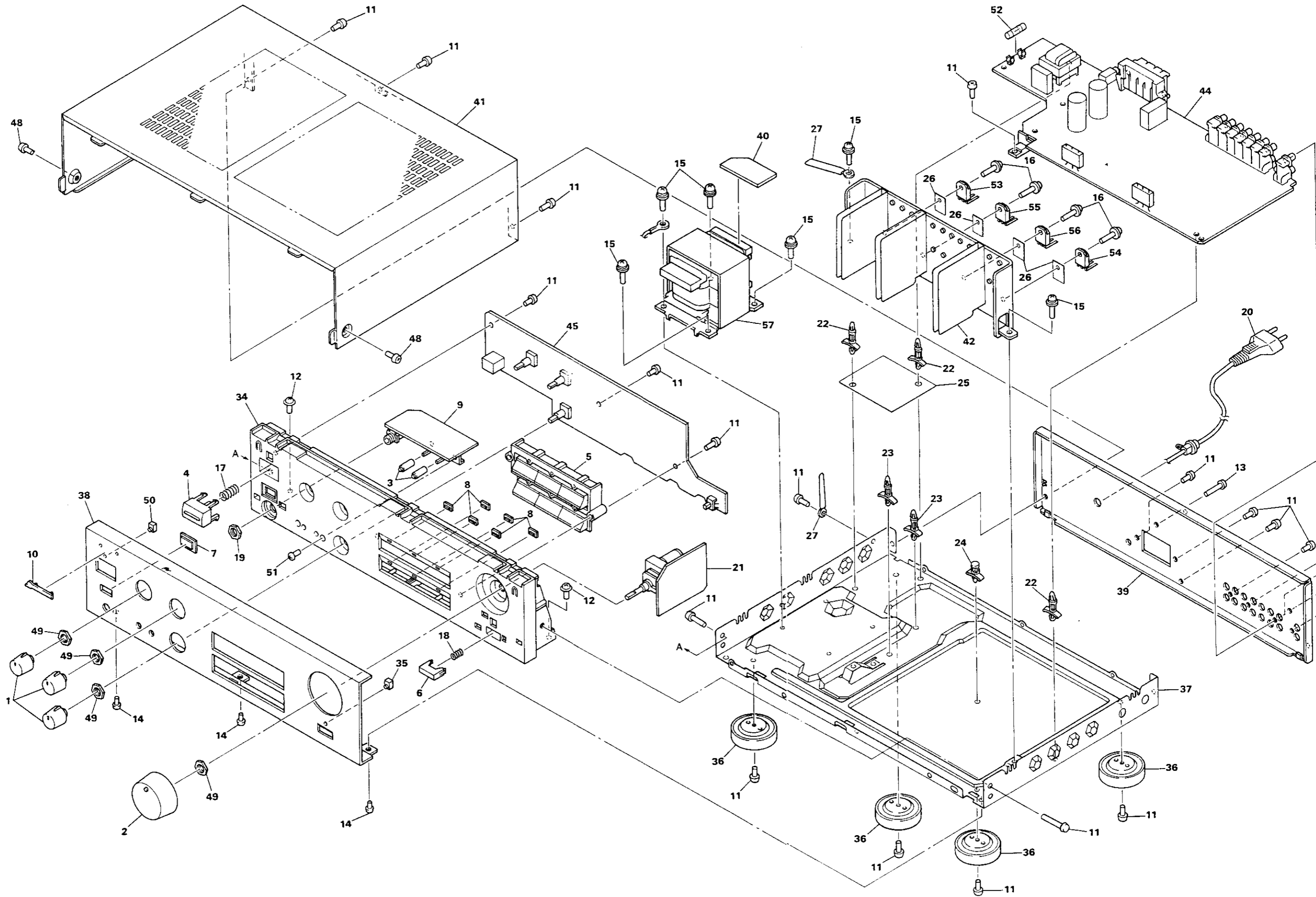

1.3 PACKING

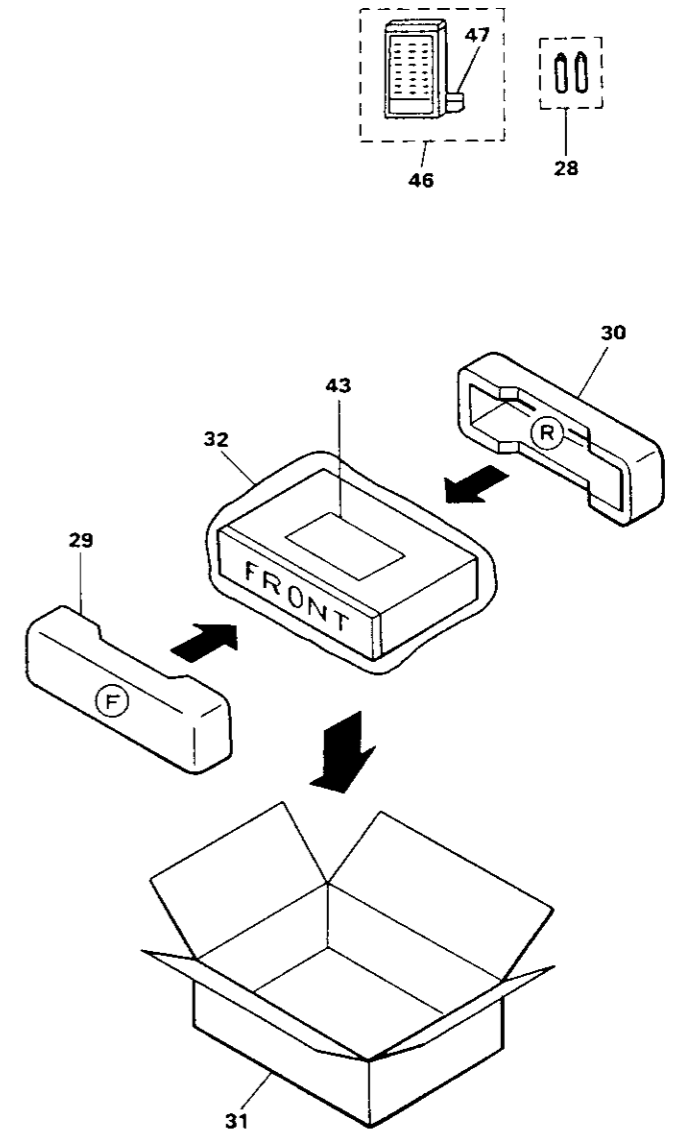
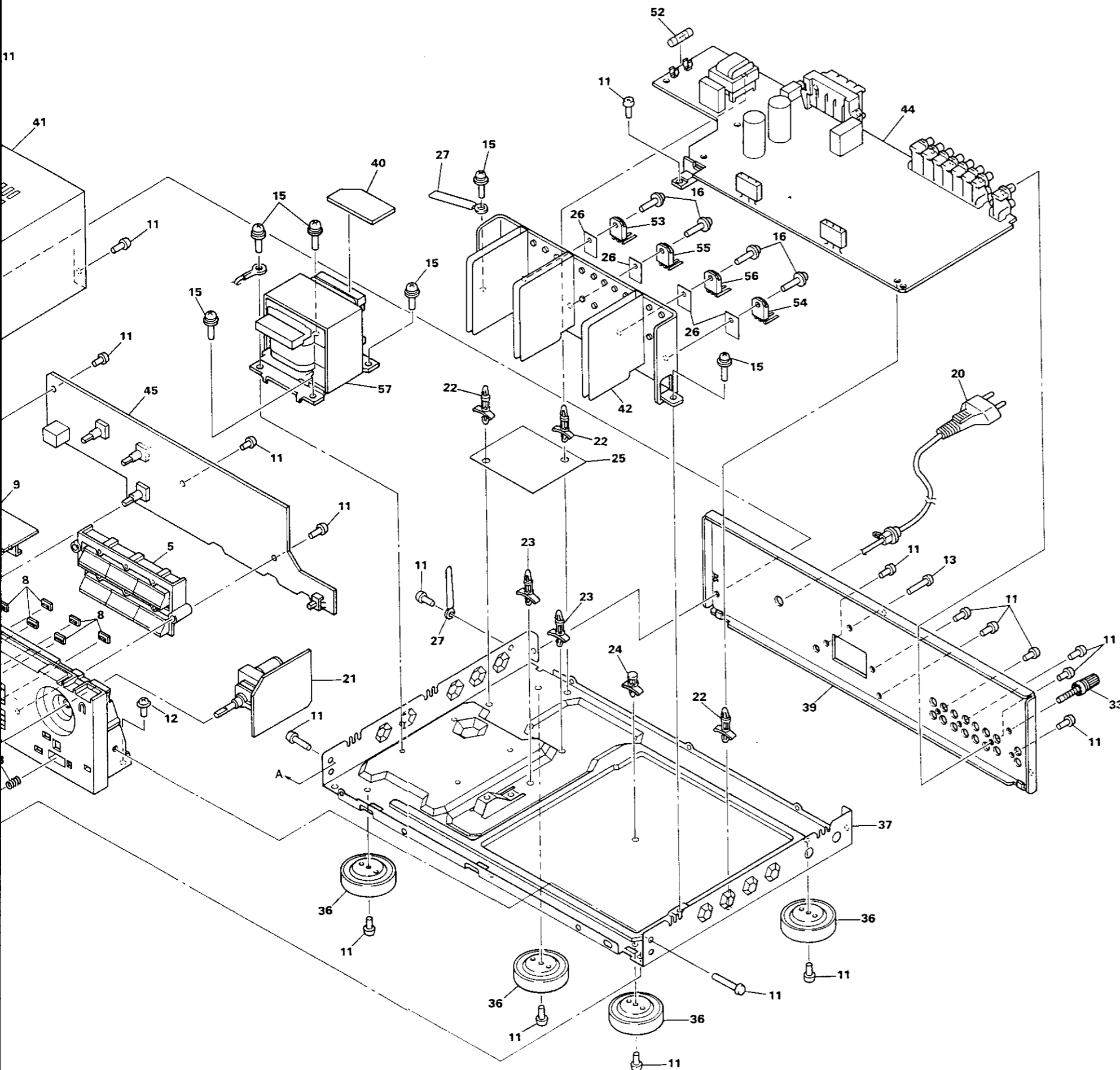

2.2 PCB CONNECTIONS DIAGRAM

AF ASS'Y (AWZ4107 FOR HEWZ TYPE)
(AWZ4112 FOR HE AND HB TYPES)

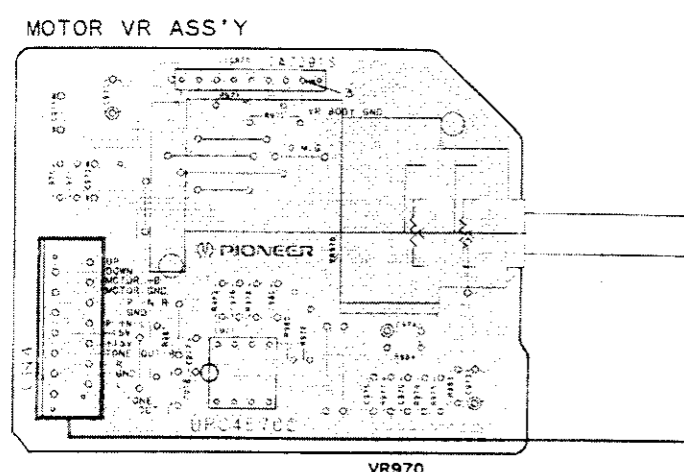
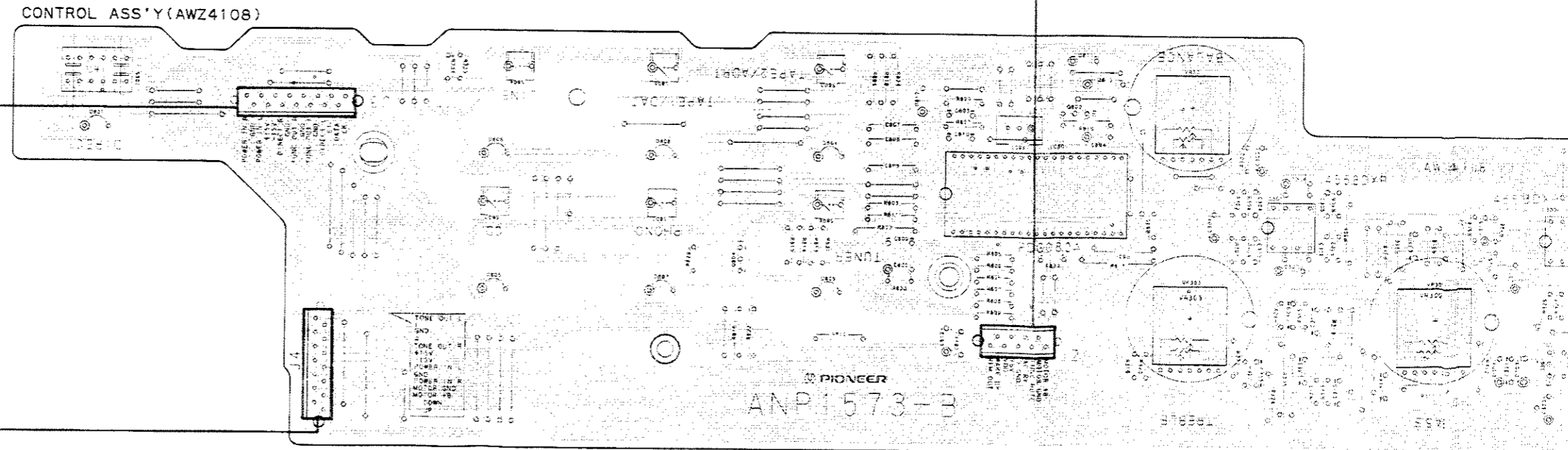
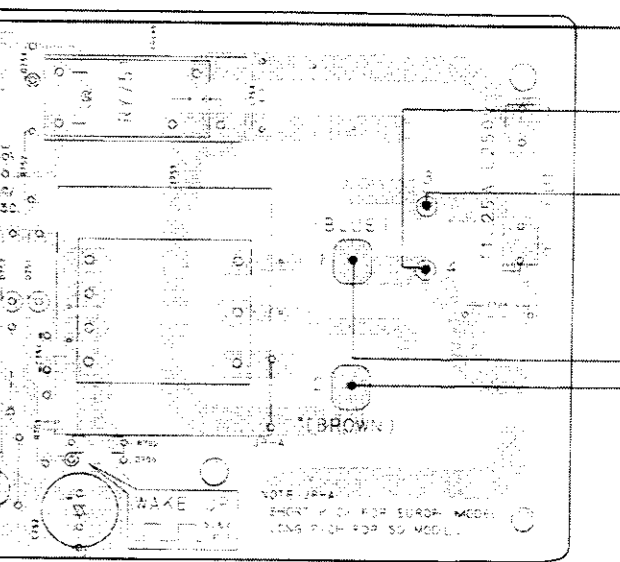
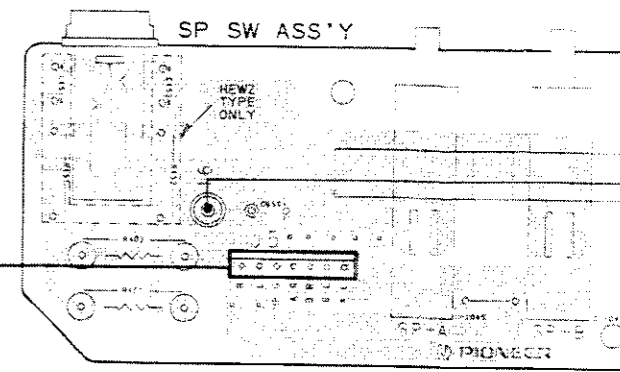

A
B
C
D

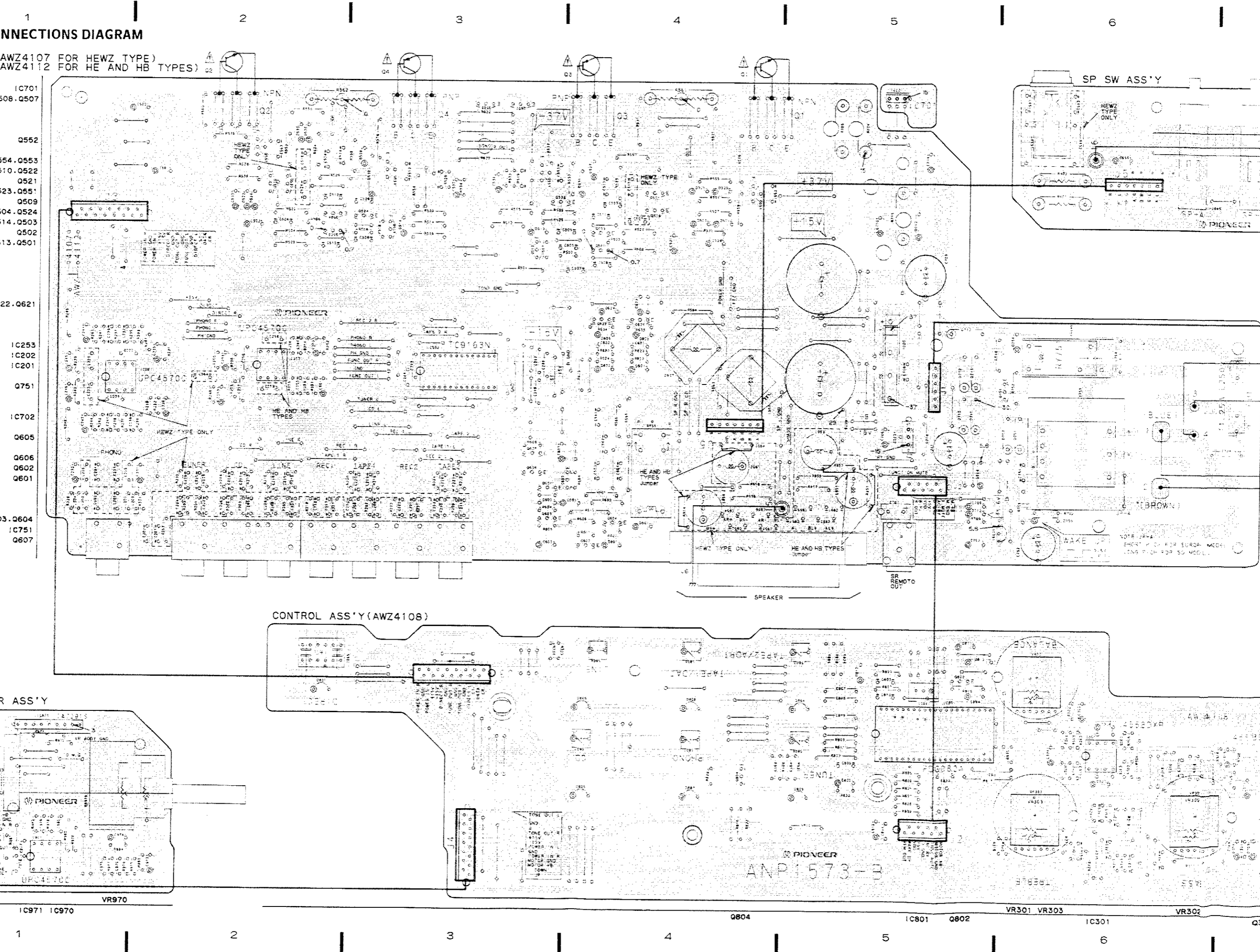

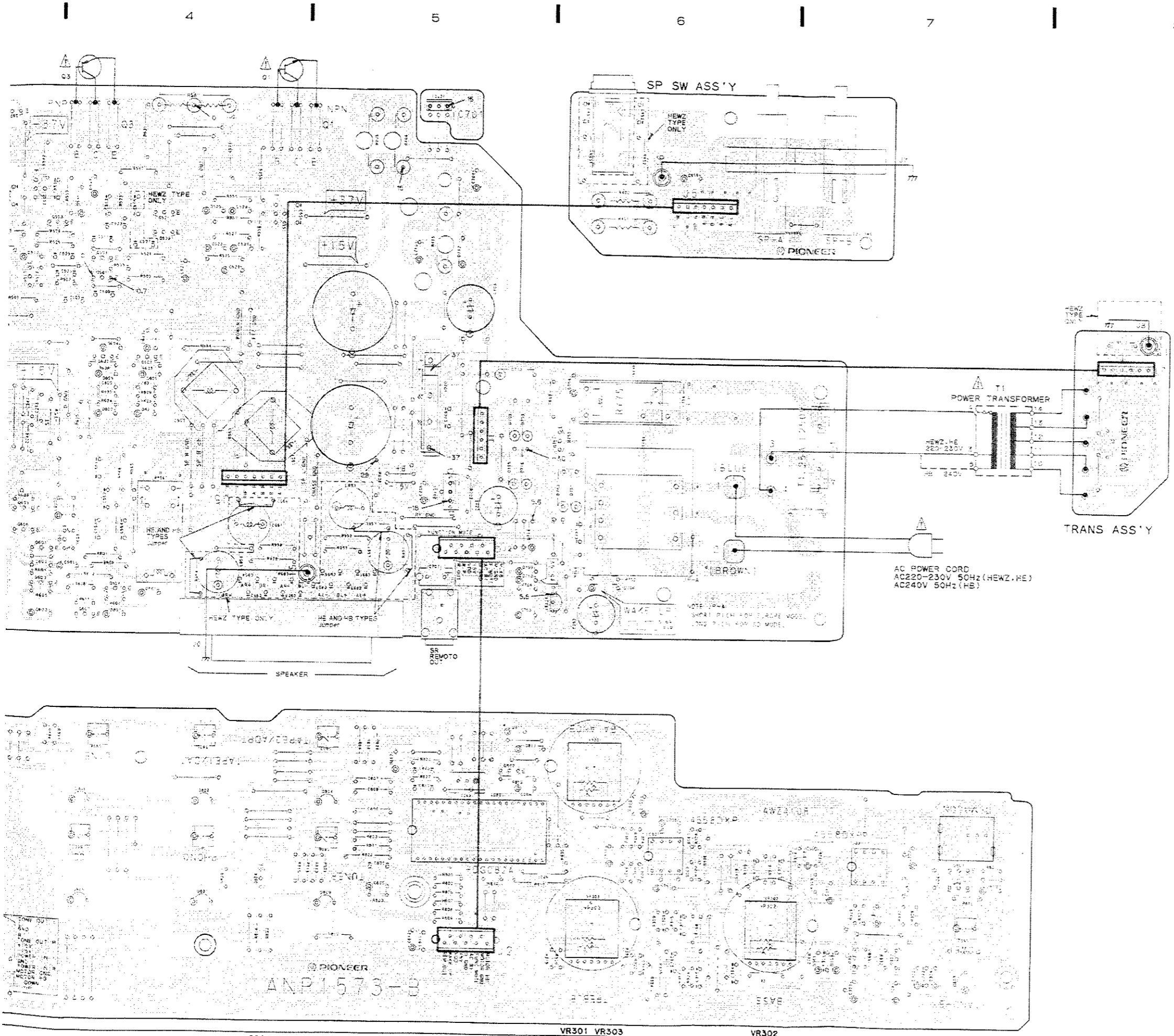

NOTE

1. This P.C.B. connection diagram is viewed from the parts mounted side.
2. The parts which have been mounted on the board can be replaced with those shown with the corresponding wiring symbols listed in the following Table.

P.C.B. pattern diagram indication	Corresponding part symbol	Part Name
		Transistor
		Radiator type transistor
		Diode
		Resistor
		Capacitor (Polarity)
		Capacitor (Non-polarity)

Others

P.C.B. pattern diagram indication	Part Name
IC	IC
S	Switch
RY	Relay
L	Coil
F	Filter
VR	Variable resistor or Semi-fixed resistor

3. The capacitor terminal marked with ⊕ (double circles) shows negative terminal.
4. The diode terminal marked with ⊕ (double circles) shows cathode side.
5. The transistor terminal to which E is affixed shows the emitter.

Line Voltage Selection

- Line Voltage can be changed as follows :
1. Disconnect the AC power cord.
 2. Remove the top cover.
 3. Change the connection of the power transformer primary taps.
 4. Stick the line voltage label on the rear panel.

Part No.	Description
AAX - 193	220 V label
AAX - 192	240 V label

4

5

6

7

8

9

A

B

C

D

4

5

6

7

8

9

11

This P.C.B. connection diagram is viewed from the foil side.

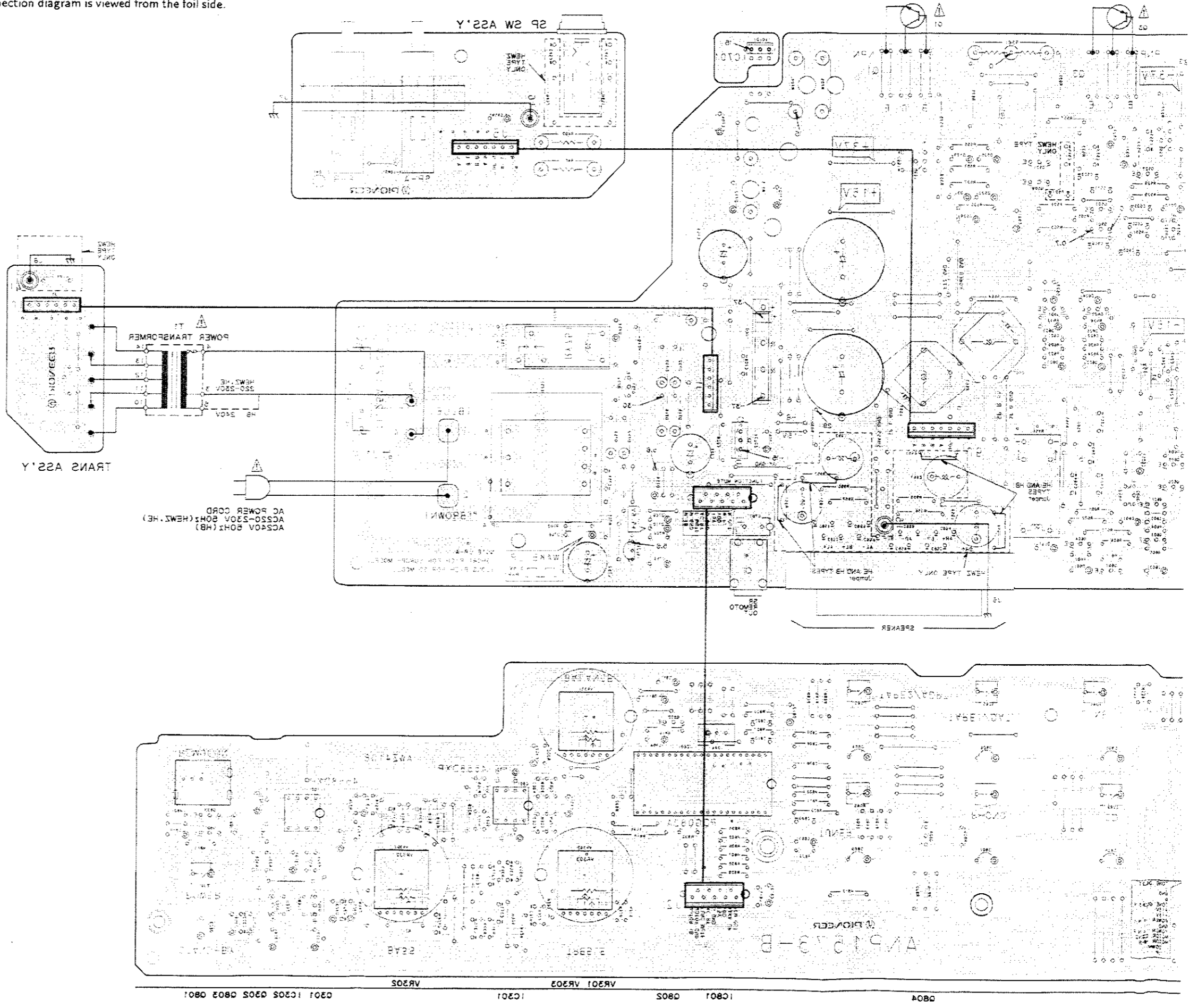

A
B
C
D
E
F
G
H
I
J
K
L
M
N
O
P
Q
R
S
T
U
V
W
X
Y
Z

2.5 PCB CONNECTIONS DIAGRAM

AF ASS'Y (AW24108 FOR HE AND HB TYPES)
AF ASS'Y (AW24107 FOR HEWZ TYPE)

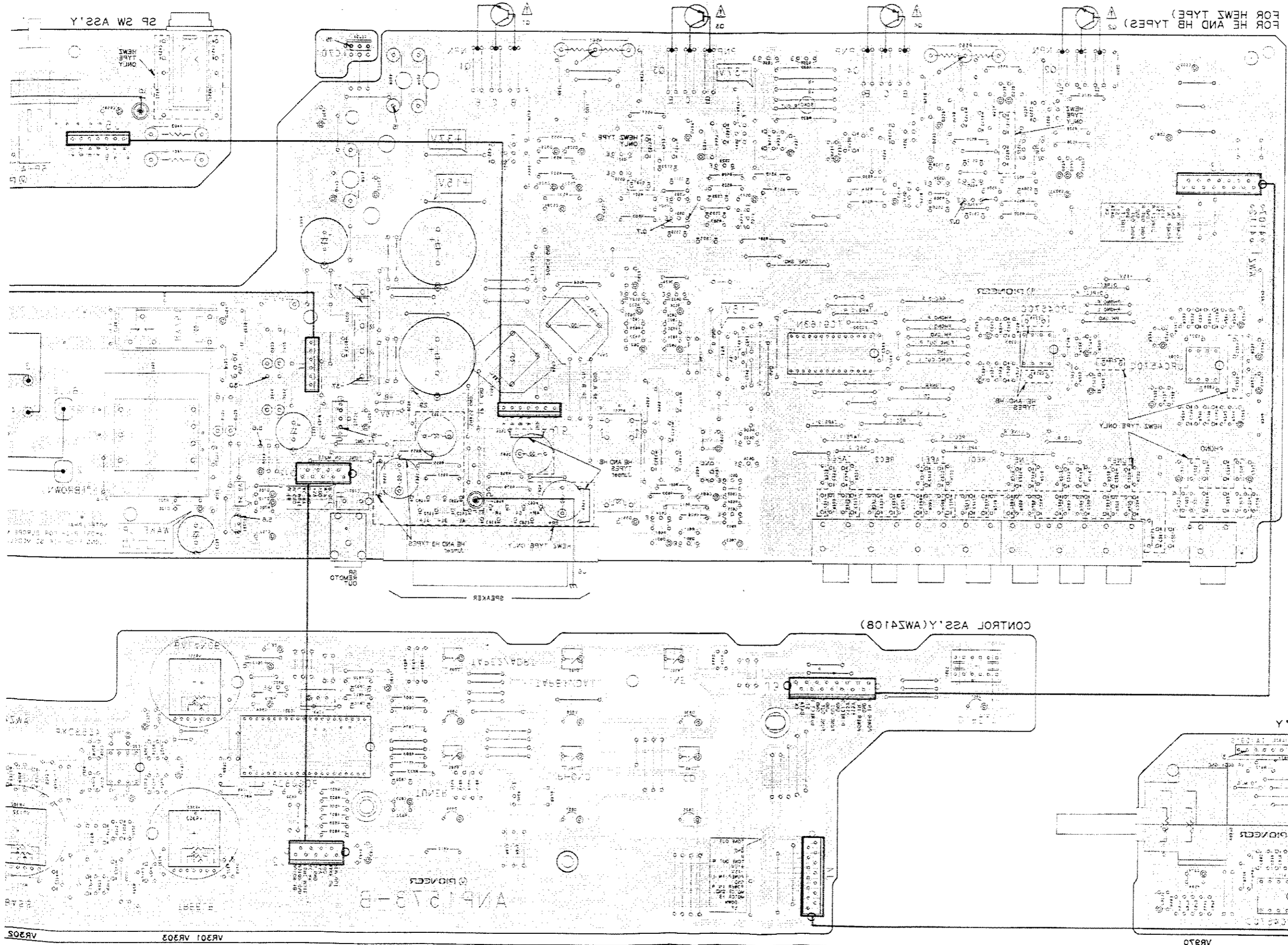

- 0208.0207
- 0252
- 0254.0253
- 0210.0255
- 0251
- 0253.0251
- 0209
- 0204.0254
- 0214.0203
- 0205
- 0212.0201
- 0255.0251
- 1C29
- 1C201
- 1C205
- 0251
- 1C205
- 0202
- 0206
- 0205
- 0201
- 0203.0204
- 1C251
- 0207

A
B
C
D

- VR30
- VR303
- VR303
- 1C201

- 1C21
- 1C20
- VR30

1
2
3
4
5
6

1
2
3
4
5
6

3. PCB PARTS LIST

NOTES:

- Parts marked by "NSP" are generally unavailable because they are not in our Master Spare Parts List.
- The Δ mark found on some component parts indicates the importance of the safety factor of the part. Therefore, when replacing, be sure to use parts of identical designation.
- Parts marked by "⊙" are not always kept in stock. Their delivery time may be longer than usual or they may be unavailable.
- When ordering resistors, first convert resistance values into code form as shown in the following examples.

Ex.1 When there are 2 effective digits (any digit apart from 0), such as 560 ohm and 47k ohm (tolerance is shown by J = 5%, and K = 10%).

560Ω → 56 × 10 ¹ → 561	RD1/8PM	$\overline{561}$ J
47kΩ → 47 × 10 ³ → 473	RD1/4PS	$\overline{473}$ J
0.5Ω → 0R5	RN2H	$\overline{0R5}$ K
1Ω → 010	RS1P	$\overline{010}$ K

Ex.2 When there are 3 effective digits (such as in high precision metal film resistors).

5.62kΩ → 562 × 10 ¹ → 5621	RN1/4PC	$\overline{5621}$ F
---------------------------------------	---------	---------------------

Mark No.	Description	Parts No.	Mark No.	Description	Parts No.
LIST OF ASSEMBLIES			D706	ZENER DIODE	HZS6A2L
⊙ AF ASS'Y		AWZ4107	D709,710	DIODE	1SS252
⊙ CONTROL ASS'Y		AWZ4108	D712	ZENER DIODE	HZS6A2L
NSP SP SWITCH ASS'Y		AWZ4109	D713	DIODE	S5566
NSP MOTOR VOL ASS'Y		AWZ4110	D714	DIODE	1SS252
NSP TRANS ASS'Y		AWZ4111	D715,716	DIODE	S5566
			D751,752	DIODE	S5566
			D754	DIODE	1SS252
AF ASS'Y			RELAYS		
SEMICONDUCTORS			RY561	RELAY	ASR-111
IC201	IC	UPC4570C	Δ RY751	RELAY	ASR1027
IC202	E-SW IC	TC9163N	COILS, TRANSFORMER		
IC253	IC	UPC4570C	L201-206	AXIAL INDUCTOR	LAU221K
IC701	REGULATOR IC	NJM78M15FAS	L561,562	COIL	ATH1004
IC702	REGULATOR IC	NJM79M15FA	L951-954	COIL	ATH-133
IC751	REGULATOR IC	M5278L56(A)	Δ T751	POWER TRANSFORMER	ATT1015
Q501-504	TRANSISTOR	2SA992	CAPACITORS		
Q507,508	TRANSISTOR	2SC2603	C200	CERAMIC CAPACITOR	CKCYF473Z50
Q509,510	TRANSISTOR	2SA1048	C201,202	CERAMIC CAPACITOR	CCMSL330J50
Q513,514	TRANSISTOR	2SC2458	C203-226	CERAMIC CAPACITOR	CKMYB391K50
Q521,522	TRANSISTOR	2SA1145	C227,228	CERAMIC CAPACITOR	CKPUYB391K50
Q523,524	TRANSISTOR	2SC2705	C229,230	CERAMIC CAPACITOR	CKCYB222K50
Q551,552	TRANSISTOR	2SC2235	C231,232	ELECT. CAPACITOR	CEAS100M50
Q553,554	TRANSISTOR	2SA965	C233,234	CERAMIC CAPACITOR	CCCSL221J50
Q601,602	TRANSISTOR	2SC2458	C235,236	ELECT. CAPACITOR	CEAS471M6
Q603	TRANSISTOR	2SA1048	C237,238	AUDIO FILM CAPACITOR	CFTXA243J50
Q604	TRANSISTOR	2SC2458	C239,240	AUDIO FILM CAPACITOR	CFTXA823J50
Q605	TRANSISTOR	XDC124ES	C241,242	ELECT. CAPACITOR	CEAS100M50
Q606	TRANSISTOR	XDC143ES	C243,244	CERAMIC CAPACITOR	CKPUYF103Z25
Q607	TRANSISTOR	2SC2458	C245,246	ELECT. CAPACITOR	CEAS101M25
Q621,622	TRANSISTOR	2SC2240	C247-249	CERAMIC CAPACITOR	CKPUYB101K50
Q751	TRANSISTOR	XDC143ES	C251-254	ELECT. CAPACITOR	CEAS100M50
D513-524	DIODE	1SS252	C255	CERAMIC CAPACITOR	CCCSL221J50
D525-528	ZENER DIODE	HZS6A2L	C256,257	CERAMIC CAPACITOR	CKPUYF103Z25
D529-532	DIODE	1SS252	C260	CERAMIC CAPACITOR	CCCSL221J50
D561	DIODE	1SS252	C261,264	CERAMIC CAPACITOR	CKCYF103Z50
D601	ZENER DIODE	HZS12AL	C501,502	ELECT. CAPACITOR	CEAS100M50
D621-626	DIODE	1SS252			
D701	DIODE	D3SBA20(A)			
D702,703	DIODE	S5566			

Mark	No.	Description	Parts No.
	C503,504	CERAMIC CAPACITOR	CCCSL221J50
	C505,506	CERAMIC CAPACITOR	CKCYB222K50
	C509-512	CERAMIC CAPACITOR	CCMSL470J50
	C513,514	CERAMIC CAPACITOR	CCCSL270K500
	C515,516	CERAMIC CAPACITOR	CKCYB471K50
	C521,522	ELECT. CAPACITOR	CEAS101M10
	C523,524	CERAMIC CAPACITOR	CCCSL270K500
	C525,526	CERAMIC CAPACITOR	CCCSL050C500
	C527,528	CERAMIC CAPACITOR	CKCYB471K50
	C529,530	ELECT. CAPACITOR	CEAS101M10
	C531,532	ELECT. CAPACITOR	CEAS010M50
	C551-554	CERAMIC CAPACITOR	CCCSL101K500
	C561-564	AUDIO FILM CAPACITOR	CFTXA104J50
	C601	ELECT. CAPACITOR	CEAS471M6
	C602	CERAMIC CAPACITOR	CKPUYF103Z25
	C603	ELECT. CAPACITOR	CEAS101M16
	C605	ELECT. CAPACITOR	CEAS4R7M50
	C621,622	ELECT. CAPACITOR	CEANP4R7M50
△	C701,702	ELECTROLYTIC CAPACIT	ACH1145
	C703	ELECT. CAPACITOR	CEAS102M35
	C704,706	ELECT. CAPACITOR	CEAS100M50
	C707	CAPACITOR	ACH1135
△	C708	CKA (0.01/AC400V)	ACG1002
	C709	CKA (0.01/AC250V)	ACG1005
	C710	ELECT. CAPACITOR	CEAS470M10
	C711	ELECT. CAPACITOR	CEAS471M35
	C751	CKA (0.01/AC250V)	ACG1005
	C752	ELECT. CAPACITOR	CEAS471M25
	C753	ELECT. CAPACITOR	CEAS470M10
△	C754	CKA (0.01/AC400V)	ACG1002
	C951-954	CERAMIC CAPACITOR	CKCYF103Z50
	C955-958	CERAMIC CAPACITOR	CKCYB681K50

RESISTORS

△	R245,246	CARBON FILM RESISTOR	RD1/4PMF101J
	R501,502	CARBON FILM RESISTOR	RD1/4PM561J
	R503,504	CARBON FILM RESISTOR	RD1/4PM563J
△	R513-516	FUSIBLE RESISTOR	RFA1/4PS391J
	R521,522	CARBON FILM RESISTOR	RD1/4PM392J
	R523,524	CARBON FILM RESISTOR	RD1/4PM563J
△	R527,528	CARBON FILM RESISTOR	RD1/4PMF680J
△	R529,530	FUSIBLE RESISTOR	RFA1/4PS101J
△	R551-554	FUSIBLE RESISTOR	RFA1/4PS101J
△	R555-558	CARBON FILM RESISTOR	RD1/4PMF101J
△	R559,560	FUSIBLE RESISTOR	RFA1/4PS4R7J
△	R561,562	RESISTOR (0.33, 5W)	ACN1063
△	R563,564	CARBON FILM RESISTOR	RD1/4PMF100J
△	R565,566	CARBON FILM RESISTOR	RD1/2PMF100J
△	R575-578	FUSIBLE RESISTOR	RFA1/4PS4R7J
△	R608	CARBON FILM RESISTOR	RD1/4PMF221J
△	R610	FUSIBLE RESISTOR	RFA1/4PS100J
	R612	CARBON FILM RESISTOR	RD1/4PM472J
△	R621,622	CARBON FILM RESISTOR	RD1/4PMF222J
△	R625	CARBON FILM RESISTOR	RD1/4PMF101J
△	R631,632	CARBON FILM RESISTOR	RD1/4PMF222J
	R701	CARBON FILM RESISTOR	RD1/4PM332J
△	R703	FUSIBLE RESISTOR	RFA1/4PS101J
△	R704,705	METAL OXIDE RESISTOR	RS2LMF911J
△	R715	METAL OXIDE RESISTOR	RS2LMF151J

Mark	No.	Description	Parts No.
	R752	CARBON FILM RESISTOR	RD1/2PM470J
△	R951-954	CARBON FILM RESISTOR	RD1/2PMF101J
△	R955-958	CARBON FILM RESISTOR	RD1/4PMF100J
	Other resistors		RD1/8PM□□□□J

OTHERS

PIN JACK(2P)	AKB1100
PIN JACK(6P)	AKB1129
PIN JACK(8P)	AKB1127
JACK	AKN-207
SPEAKER TERMINAL 8-P	AKE-111

CONTROL ASS'Y

SEMICONDUCTORS

IC301,302	OP-AMP IC	NJM4558DXP
IC801	SYSTEM CONTROL MPU	PDG082A
Q301,302	N-FET	2SK246
Q801	TRANSISTOR	XDC124ES
Q802	TRANSISTOR	2SC2458
Q803	TRANSISTOR	XDA143ES
Q804	TRANSISTOR	XDC124ES
D301-304	DIODE	1SS252
D801	LED	AEL1084
D803	LED(RED)	AEL1065
D804-809	LED(RED)	AEL1118
D810-813	DIODE	1SS252

SWITCHES

S301	PUSH SWITCH	ASG1047
S801-807	SWITCH	ASG1034

CAPACITORS

C300	CERAMIC CAPACITOR	CKPUYF103Z25
C301,302	ELECT. CAPACITOR	CEAS100M50
C303,304	CERAMIC CAPACITOR	CCMSL470J50
C305,306	CERAMIC CAPACITOR	CKPUYF103Z25
C307,308	ELECT. CAPACITOR	CEAS100M50
C309,310	AUDIO FILM CAPACITOR	CFTXA153J50
C311,312	AUDIO FILM CAPACITOR	CFTXA823J50
C313,314	MYLAR FILM CAPACITOR	CQMA332K50
C315,316	AUDIO FILM CAPACITOR	CFTXA183J50
C317,318	ELECT. CAPACITOR	CEAS100M50
C319,320	ELECT. CAPACITOR	CEAS470M25
C321,322	CERAMIC CAPACITOR	CCCSL150J50
C323,324	ELECT. CAPACITOR	CEAS100M50
C801	CERAMIC CAPACITOR	CKPUYB102K50
C802,803	AUDIO FILM CAPACITOR	CFTXA104J50
C804	ELECT. CAPACITOR	CEAS330M16
C805	ELECT. CAPACITOR	CEAS101M10
C806-808	CERAMIC CAPACITOR	CKPUYB101K50
C810	AUDIO FILM CAPACITOR	CFTXA104J50
C811	CERAMIC CAPACITOR	CKPUYF103Z25
C812	ELECT. CAPACITOR	CEAS100M50

RESISTORS

VR301	VARIABLE RESISTOR	ACS1054
VR302,303	VARIABLE RESISTOR	ACS1053
R816	CARBON FILM RESISTOR	RD1/2PM821J
R822	CARBON FILM RESISTOR	RD1/2PM821J
Other resistors		RD1/8PM□□□□J

Mark No.	Description	Parts No.
OTHERS		
X801	CERAMIC RESONATOR (f=4.0MHz)	ASS1025
	REMOTE RECEIVER UNIT	AXX1023

SP SWITCH ASS'Y

SWITCH		
S401	PUSH SWITCH	SUL8LXXS
CAPACITORS		
C451,452	CERAMIC CAPACITOR	CKCYB392K50
C959	ELECT. CAPACITOR	CEAS010M50
RESISTORS		
△ R401,402	METAL OXIDE RESISTOR	RS2LMF331J
△ R451,452	METAL OXIDE RESISTOR	RS1PMF681J

OTHERS		
	JACK	AKN1002

MOTOR VOL ASS'Y

SEMICONDUCTORS		
IC970	MECHANISM DRIVER IC	TA7291S
IC971	IC	UPC4570C
COILS		
L970,971	AXIAL INDUCTOR	LAU220K
CAPACITORS		
C970	ELECT. CAPACITOR	CEAS470M35
C971,972	CERAMIC CAPACITOR	CKCYX473M25
C973,974	ELECT. CAPACITOR	CEAS100M50
C975,976	CERAMIC CAPACITOR	CKPUYB221K50
C977,978	CERAMIC CAPACITOR	CKPUYF103Z25
C979,980	CERAMIC CAPACITOR	CKPUYB221K50
RESISTORS		
VR970	VARIABLE RESISTOR	ACX1040
	Other resistors	RD1/8PM□□□J
OTHER		
CN4	CONNECTOR(14P)	KPE14

TRANS ASS'Y

CAPACITOR		
C1		CQMXA104J100
RESISTOR		
R1	CARBONFILM RESISTOR	RD1/8PM100J

4. FOR HE AND HB TYPES

CONTRAST OF MISCELLANEOUS PARTS

NOTES:

- Parts marked by "NSP" are generally unavailable because they are not in our Master Spare Parts List.
- The Δ mark found on some component parts indicates the importance of the safety factor of the part. Therefore, when replacing, be sure to use parts of identical designation.
- Parts marked by "⊙" are not always kept in stock. Their delivery time may be longer than usual or they may be unavailable.

A - 351R/HE, HB and A - 351R/HEWZ have the same construction except for the following :

Mark	Symbol & Description	Part No.			Remarks
		HEWZ type	HE type	HB type	
Δ	AC Power cord	ADG1021	ADG1021	ADG1085	
⊙	AF assembly	AWZ4107	AWZ4112	AWZ4112	
NSP	SP SWITCH assembly	AWZ4109	AWZ4113	AWZ4113	
NSP	TRANS assembly	AWZ4111	AWZ4220	AWZ4220	
	Operating instructions (German)	ARC1328	
	Operating instructions (English/French//German/ Italian/Dutch/Swedish/ Spanish/Portuguese)	ARE1225	
	Operating instructions (English)	ARB1355	

AF ASSEMBLY

AWZ4112 and AWZ4107 have the same construction except for the following :

Mark	Symbol & Description	Part No.		Remarks
		AWZ4107	AWZ4112	
	C201, 202	CCMSL330J50	
	C203 - 226	CKMYB391K50	
	C227, 228	CKPUYB391K50	CKPUYB221K50	
	C229, 230	CKCYB222K50	
	C233,234,255,260	CCCSL221J50	CKMYB221K50	
	C258, 259	CKMYB221K50	
	C261, 264	CKCYF103Z50	
	C503, 504	CCCSL221J50	CQMA102J50	
	C515,516,527,528	CKCYB471K50	
	C951 - 954	CKCYF103Z50	
	C955 - 958	CKCYB681K50	
	L201 - 206	LAU221K	
	L951 - 954	ATH - 133	
	R217,218,221,222	RD1/8PM222J	RD1/8PM102J	
	R227,228	RD1/8PM122J	RD1/8PM331J	
	R247,248	RD1/8PM331J	RD1/8PM181J	
	R249,250	RD1/8PM221J	RD1/8PM470J	
	R257	RD1/8PM4R7J	
⚠	R951 - 954	RD1/2PMF101J	
⚠	R955 - 958	RD1/4PMF100J	

SP SWITCH ASSEMBLY

AWZ4113 and AWZ4109 have the same construction except for the following :

Mark	Symbol & Description	Part No.		Remarks
		AWZ4109	AWZ4113	
	C451,452	CKCYB392K50	
⚠	R451,452	RS1PMF681J	

TRANS ASSEMBLY

AWZ4220 and AWZ4111 have the same construction except for the following :

Mark	Symbol & Description	Part No.		Remarks
		AWZ4111	AWZ4220	
	R1	RD1/8PM100J	

5. PANEL FACILITIES

FRONT PANEL

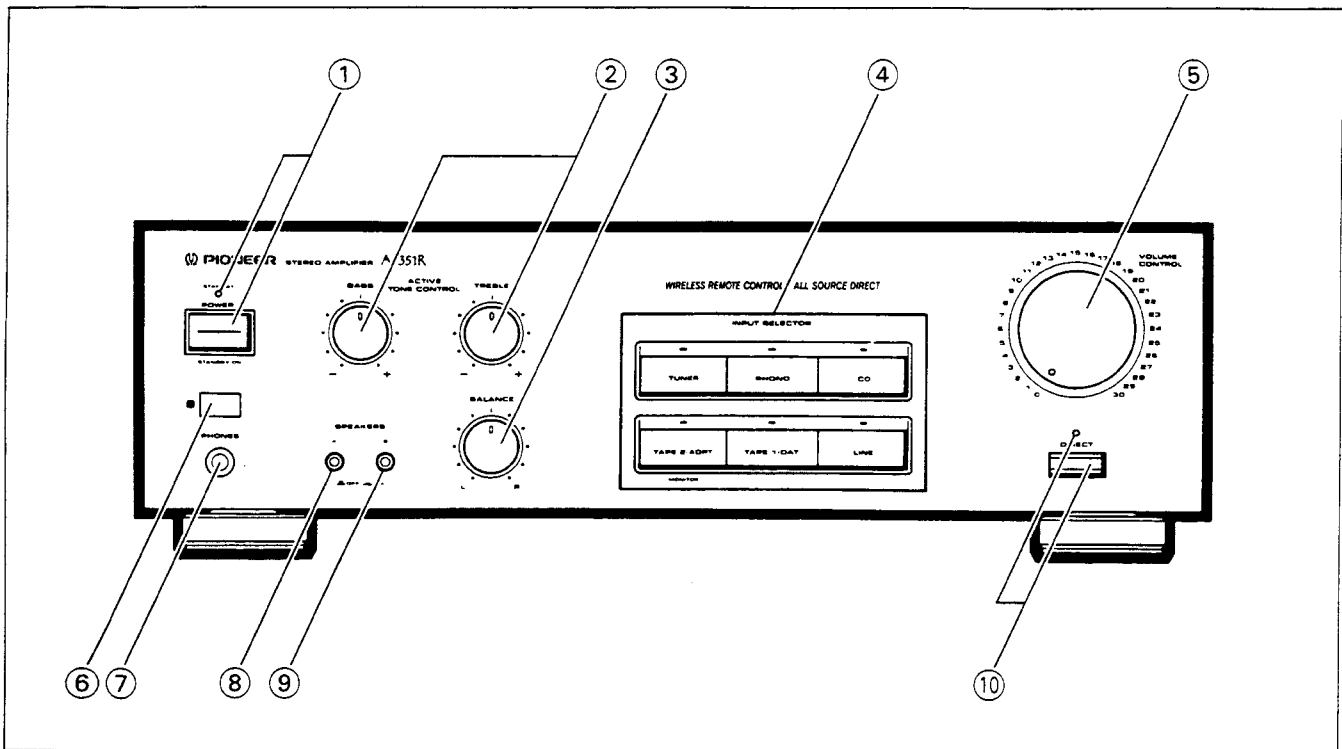

① POWER STANDBY/ON switch/indicator

To use the amplifier, press the POWER STANDBY/ON switch to ON, so that the STANDBY indicator goes off. When the STANDBY indicator lights, the unit is in STANDBY.

When set to the STANDBY position, the main power flow is cut and the unit is no longer fully operational. A minute flow of power feeds the unit to maintain operation readiness.

② ACTIVE tone control

The effect of the main unit's tone control becomes more noticeable when the volume is decreased, so it can be adjusted to achieve the same effect as the Loudness function.

TREBLE tone control

Use to adjust the high-frequency tone at low volume level. The center position is the flat (normal) position. When turned to the right, high-frequency tones are emphasized; when turned to the left, high-frequency tones are de-emphasized.

NOTE:

- This control does not operate when DIRECT button is in the on position.
- At volume levels lower than "12", the set tone control effect is obtained.
- At volume levels higher than "12", the effect becomes increasingly weaker.

BASS tone control

Use to adjust the low-frequency tone at low volume level. The center position is the flat (normal) position. When turned to the right, low-frequency tones are emphasized; when turned to the left, low-frequency tones are de-emphasized.

NOTE:

- This control does not operate when DIRECT button is in the on position.
- At volume levels lower than "12", the set tone control effect is obtained.
- At volume levels higher than "12", the effect becomes increasingly weaker.

③ BALANCE control

Should normally be left in the center position. Adjust balance if the sound is louder from one of the speakers. If the right side is louder, turn toward the L position and if the left side is louder, turn toward the R position.

NOTE:

This function does not operate when DIRECT button is in the on position.

④ INPUT SELECTOR buttons/indicators

Use to select the playback source.

TUNER:

For AM or FM broadcast reception with a tuner.

PHONO:

For record playback with a turntable.

CD:

For compact disc playback with a CD player.

LINE:

For playback with a component connected to LINE terminal.

TAPE 1/DAT:

For playback with a cassette deck or digital audio cassette deck connected to TAPE 1/DAT terminals.

TAPE 2/ADPT:

For playback with a cassette deck or adaptor connected to TAPE 2/ADPT terminals.

NOTE:

When the **DIRECT** button is set to ON, the input to be reduced is always selected with the **INPUT SELECTOR** except **TAPE 2/ADPT**, regardless of whether the **TAPE 2/ADPT** indicator lights or not. Furthermore, when the **TAPE 2/ADPT** indicator is ON, signals input through **TAPE 2/ADPT** are output at **TAPE 1/DAT REC**.

⑤ VOLUME CONTROL

Use to adjust the volume level.

NOTE:

This unit is equipped with a circuit that attenuates **TONE** effect as volume is turned up.

⑥ Remote control sensor window

⑦ PHONES jack

When using headphones, insert the plug into this jack.

⑧ SPEAKERS A selector button

Use this button to listen to the speaker systems connected to **SPEAKERS A** terminals.

ON (▲): Depressed position: Sound is heard from the speaker systems.

OFF (■): Released position: No sound is heard from the speaker systems. Set to this position when listening with headphones.

⑨ SPEAKERS B selector button

Use this button to listen to the speaker systems connected to **SPEAKERS B** terminals.

ON (▲): Depressed position: Sound is heard from the speaker systems.

OFF (■): Released position: No sound is heard from the speaker systems. Set to this position when listening with headphones.

⑩ DIRECT button/indicator

Use this button/indicator when you do not wish to pass the output from input terminal equipment through the various frequency adjusting circuits (**BASS, TREBLE, BALANCE**).

on: The indicator lights: The signals input through the input terminals are reproduced without passing through the various frequency adjusting circuits. This results in flat, pure sound which is a more faithful reproduction of the input source.

off: The indicator goes out: The signal passes through the various frequency adjusting circuits.

REAR PANEL

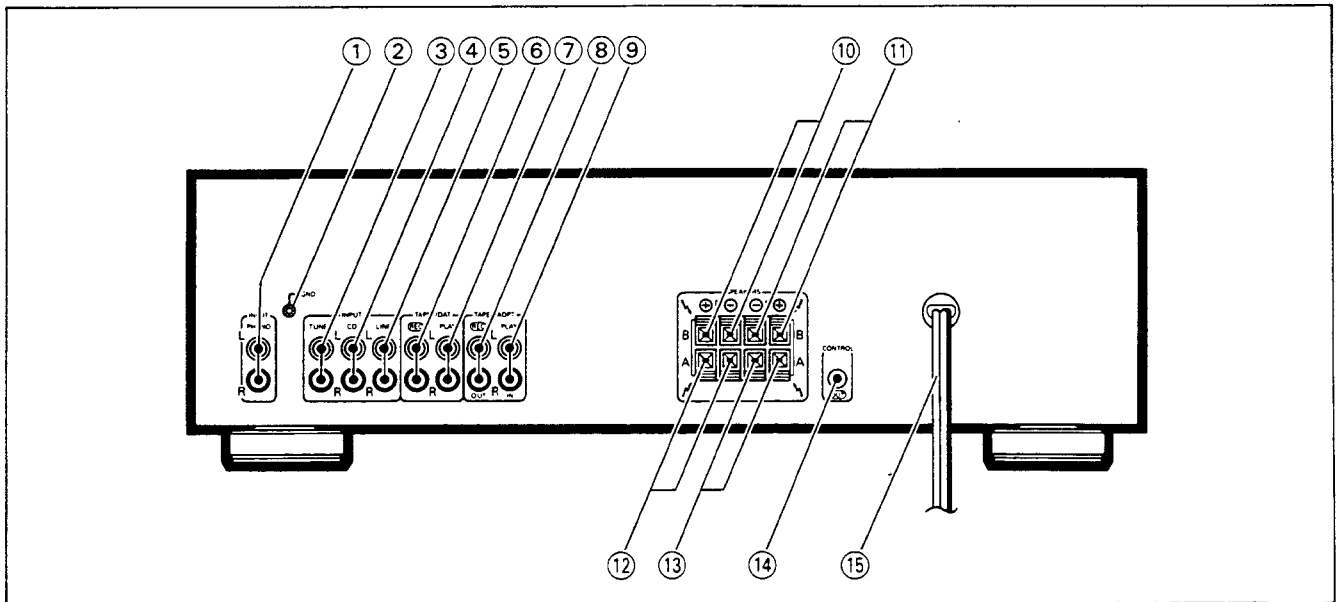

① PHONO terminals

② Turntable ground terminal (GND)

③ TUNER terminals

④ CD terminals

⑤ LINE terminals

⑥ TAPE 1/DAT REC terminals

⑦ TAPE 1/DAT PLAY terminals

⑧ TAPE 2/ADPT REC (OUT) terminals

⑨ TAPE 2/ADPT PLAY (IN) terminals

⑩ SPEAKERS B terminals (right channel)

⑪ SPEAKERS B terminals (left channel)

⑫ SPEAKERS A terminals (right channel)

⑬ SPEAKERS A terminals (left channel)

⑭ CONTROL OUT jack

This jack is for output of control signals when operating other components bearing the  mark with the attached remote control unit.

⑮ Power cord

Connect this cord to an AC wall socket, or the AC outlet of an audio timer.

6. SPECIFICATIONS

Verstärkerteil

Dauerleistung (beide Kanäle ausgesteuert bei 20 Hz bis 20 kHz)**	
Klirrfaktor 0,07 %, 8 Ω	30 W + 30 W*
Dauerleistung nach DIN (beide Kanäle ausgesteuert bei 1 kHz)	
Klirrfaktor 1,0 %, 4 Ω	45 W + 45 W
Klirrfaktor 1,0 %, 8 Ω	35 W + 35 W
Dynamikleistung (mit EIA-Dynamik-Testsignal)	
4 Ω	60 W
Gesamtklirrfaktor**	
20 Hz bis 20 kHz, 30 W, 8 Ω	0,07 %*

• Die oben aufgeführten Daten gelten bei 230 V.

Eingangsempfindlichkeit/-impedanz

PHONO (MM)	2,5 mV/50 kΩ
CD, TUNER, LINE, TAPE 1/DAT, TAPE 2/ADPT	150 mV/50 kΩ

PHONO-Übersteuerungsgrenze

1 kHz, Klirrfaktor 0,1 % (MM)	150 mV
-------------------------------	--------

Ausgangspegel/-impedanz

Ausgang TAPE 1/DAT, TAPE 2/ADPT	150 mV/2,2 kΩ
---------------------------------	---------------

Frequenzgang

PHONO (MM)	20 Hz bis 20 kHz ± 0,5 dB
CD, TUNER, LINE, TAPE 1/DAT, TAPE 2/ADPT	5 Hz bis 70 kHz ± 0,5 dB*

Klangregler (Lautstärkeregl.: - 30 dB)

BASS	± 8 dB (100 Hz)
TREBLE	± 8 dB (10 kHz)

Signal-Rauschabstand (IHF-Kurzschluß, A-Netzwerk)

PHONO (MM, 5 mV Eingang)	84 dB*
CD, TUNER, LINE, TAPE 1/DAT, TAPE 2/ADPT	103 dB*

Signal-Rauschabstand (DIN, Dauerleistung/50 mW)

PHONO (MM)	69 dB/65 dB*
CD, TUNER, LINE, TAPE 1/DAT, TAPE 2/ADPT	89 dB/69 dB*

Stromversorgung/Sonstiges

Netzanschluß	a.c. 220 — 230 V, 50/60 Hz
Leistungsaufnahme	325 W
Abmessungen (B x T x H)	420 x 336 x 125 mm
Gewicht (ohne Verpackung)	5,6 kg

Zubehör

Fernbedienung	1
Batterien (IEC R03, Trockenbatterie)	2
Bedienungsanleitung	1

HINWEIS:

Änderungen der technischen Daten und des Designs zum Zwecke der Verbesserung vorbehalten.

* Gemessen mit aktiviertem Direkteingangstaste (DIRECT).

** Gemessen mit Tonspektrumanalysator.

Service Manual

 **PIONEER**
The Art of Entertainment

ORDER NO.
ARP2740

STEREO AMPLIFIER

A-302R

● Refer to the service manual ARP2552 for A-351R/HEWZ.

A-302R HAS THE FOLLOWING :

Type	Power Requirement	Remarks
HEWZ	AC220 - 230V, 240V (switchable)*	
HE	AC220 - 230V, 240V (switchable)*	
HB	AC220 - 230V, 240V (switchable)*	
HL	AC220 - 230V, 240V (switchable)*	

*Change the connection of the power transformer's primary wiring.

● This manual is applicable to A-302R/HEWZ, HE, HB and HL.

www.manualscenter.com

1. CONTRAST OF MISCELLANEOUS PARTS

NOTES:

- Parts marked by "NSP" are generally unavailable because they are not in our Master Spare Parts List.
- The Δ mark found on some component parts indicates the importance of the safety factor of the part. Therefore, when replacing, be sure to use parts of identical designation.
- Parts marked by "☉" are not always kept in stock. Their delivery time may be longer than usual or they may be unavailable.

A-302R/HEWZ, HE, HB, HL and A-351R/HEWZ have the same construction except for the following :

Mark	Symbol & Description	Part No.					Remarks
		A-351R/HEWZ	A-302R/HEWZ	A-302R/HE	A-302R/HB	A-302R/HL	
☉	AF ASSY	AWZ4107	AWZ4107	AWZ4112	AWZ4112	AWZ4112	*1
NSP	SP SWITCH ASSY	AWZ4109	AWZ4109	AWZ4113	AWZ4113	AWZ4113	*1
NSP	TRANS ASSY	AWZ4111	AWZ4111	AWZ4220	AWZ4220	AWZ4220	*1
Δ	AC power cord	ADG1021	ADG1049	ADG1049	ADG1118	ADG1049	
	AC cord stopper	AEC - 882	AEC - 882	AEC - 882	AEC - 882	
	Name plate (METAL)	AAM1029	AAM1058	AAM1058	AAM1058	AAM1058	
	Front panel	ANB1493	ANB1564	ANB1564	ANB1564	ANB1564	
	Packing case	AHD2229	AHD2564	AHD2564	AHD2565	AHD2564	
	Spacer	AHB1110	
	Operating instructions (German)	ARC1328	ARC1431	
	Operating instructions (English/ French/German/Italian/Dutch/ Swedish/Spanish/Portuguese)	ARE1285	
	Operating instructions (English)	ARB1438	ARB1438	

*1: AWZ4112, AWZ4113 and AWZ4220 are the same as those of A-351R/HE which is shown in the service manual ARP2552 for A-351R/HEWZ, HE and HB.

**● Packing
(For A-302R/HB)**

