

Service Manual

PIONEER
The future of sound and vision.

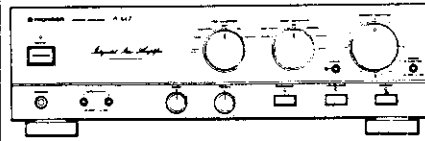

The illustration shows model A-447.
L'illustration montre le modèle A-447.

STEREO AMPLIFIER

A-447

A-447-S

A-337

A-337-S

MODEL A-447, A-447-S, A-337 AND A-337-S HAVE FOLLOWING VERSIONS:

Type	Applicable model				Power requirement	Export destination
	A-447	A-447-S	A-337	A-337-S		
HE	○	—	○	—	AC220V, 240V (switchable) *	European continent
HEWZ	○	○	○	○	AC220V, 240V (switchable) *	West Germany
SD	○	—	○	—	AC110V, 120-127V, 220V, 240V (switchable)	Kingdom of Saudi Arabia and General market
KUC	—	—	○	—	AC120V only	U.S.A. and Canada
KC	○	—	—	—	AC120V only	Canada

* Change the primary wiring.

- This manual is applicable to the A-447/HE, HEWZ, A-447-S/HEWZ, A-337/HE, HEWZ and A-337-S/HEWZ types.
- As to the A-447/HEWZ and A-447-S/HEWZ types, refer to pages 34 – 36.
- The A-447-S is the same as the A-447 except for color.
- As to the A-337/HEWZ and A-337-S/HEWZ types, refer to pages 37 – 39.
- The A-337-S is the same as the A-337 except for color.
- Ce manuel pour le service comprend les explications de réglage en français.
- Este manual de servicio trata del método ajuste escrito en español.

CONTENTS

1. SAFETY INFORMATION	2	5. FOR A-447/HEWZ AND A-447-S/HEWZ TYPES	35
2. EXPLODED VIEWS, PACKING AND PARTS LIST	3	6. FOR A-337/HEWZ AND A-337-S/HEWZ TYPES	38
3. FOR A-447/HE TYPE	7	7. PANEL FACILITIES	41
4. FOR A-337/HE TYPE	23	8. SPECIFICATIONS	44

PIONEER ELECTRONIC CORPORATION 4-1, Meguro 1-Chome, Meguro-ku, Tokyo 153, Japan
PIONEER ELECTRONICS SERVICE INC. P.O. Box 1760, Long Beach, California 90801 U.S.A.
PIONEER ELECTRONICS OF CANADA, INC. 505 Cochrane Drive, Markham, Ontario L3R 8E3 Canada
PIONEER ELECTRONIC [EUROPE] N.V. Keetberglaan 1, 2740 Beveren, Belgium
PIONEER ELECTRONICS AUSTRALIA PTY. LTD. 178-184 Boundary Road, Braeside, Victoria 3195, Australia TEL: [03] 580-9911
 © PIONEER ELECTRONIC CORPORATION 1990

SEV MAY. 1990 Printed in Japan

This service manual is intended for qualified service technicians; it is not meant for the casual do-it-yourselfer. Qualified technicians have the necessary test equipment and tools, and have been trained to properly and safely repair complex products such as those covered by this manual.

Improperly performed repairs can adversely affect the safety and reliability of the product and may void the warranty. If you are not qualified to perform the repair of this product properly and safely, you should not risk trying to do so and refer the repair to a qualified service technician.

WARNING

Lead in solder used in this product is listed by the California Health and Welfare agency as a known reproductive toxicant which may cause birth defects or other reproductive harm (California Health & Safety Code, Section 25249.5).

When servicing or handling circuit boards and other components which contain lead in solder, avoid unprotected skin contact with the solder. Also, when soldering do not inhale any smoke or fumes produced.

1. SAFETY INFORMATION

(FOR USA MODEL ONLY)

1. SAFETY PRECAUTIONS

The following check should be performed for the continued protection of the customer and service technician.

LEAKAGE CURRENT CHECK

Measure leakage current to a known earth ground (water pipe, conduit, etc.) by connecting a leakage current tester such as Simpson Model 229-2 or equivalent between the earth ground and all exposed metal parts of the appliance (input/output terminals, screwheads, metal overlays, control shaft, etc.). Plug the AC line cord of the appliance directly into a 120V AC 60Hz outlet and turn the AC power switch on. Any current measured must not exceed 0.5mA.

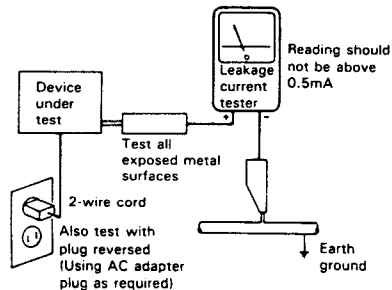

AC Leakage Test

ANY MEASUREMENTS NOT WITHIN THE LIMITS OUTLINED ABOVE ARE INDICATIVE OF A POTENTIAL SHOCK HAZARD AND MUST BE CORRECTED BEFORE RETURNING THE APPLIANCE TO THE CUSTOMER.

2. PRODUCT SAFETY NOTICE

Many electrical and mechanical parts in the appliance have special safety related characteristics. These are often not evident from visual inspection nor the protection afforded by them necessarily can be obtained by using replacement components rated for voltage, wattage, etc. Replacement parts which have these special safety characteristics are identified in this Service Manual.

Electrical components having such features are identified by marking with a Δ on the schematics and on the parts list in this Service Manual.

The use of a substitute replacement component which does not have the same safety characteristics as the PIONEER recommended replacement one, shown in the parts list in this Service Manual, may create shock, fire, or other hazards.

Product Safety is continuously under review and new instructions are issued from time to time. For the latest information, always consult the current PIONEER Service Manual. A subscription to, or additional copies of, PIONEER Service Manual may be obtained at a nominal charge from PIONEER.

2. EXPLODED VIEWS, PACKING AND PARTS LIST

NOTES:

- Parts without part number cannot be supplied.
- The Δ mark found on some component parts indicates the importance of the safety factor of the part. Therefore, when replacing, be sure to use parts of identical designation.
- Parts marked by "⊙" are not always kept in stock. Their delivery time may be longer than usual or they may be unavailable.

2.1 PARTS LIST OF A-447/HE

Mark	No.	Description	Parts No.	Mark	No.	Description	Parts No.
	1	ROTARY KNOB S (PLS)	AAB1155		36	METAL BONNET	AZN1799
	2	ROTARY KNOB L (PLS)	AAB1160		37	BOTTOM PLATE	
	3	ROTARY KNOB R (PLS)	AAB1162		38	P.C.B HOLDER	
	4	ROTARY KNOB M (PLS)	AAB1164		39	HEAT SINK	
	5	PUSH KNOB C	AAD1366		40	ROD	ANR-879
	6	KNOB (POWER)	AAD1535		41	OPERATING INSTRUCTIONS	ARE1162
	7	PUSH KNOB	AAD1536		42	SCREW	BBT30P060FZK
	8	PUSH KNOB C	AAD1803		43	NUTS	NK90FZB
	9	NAME PLATE (METAL)	AAM1029		44	SCREW	VMZ30P060FCU
	10	SCREW	ABA-298	Δ	45	C1 CAPACITOR	CQMXA104J100
	11	SCREW (STEEL)	ABA1009	Δ	46	FU1 FUSE(T2.5A)	AEK-403
	12	SCREW (STEEL)	ABA1011	Δ	47	Q1 TRANSISTOR	2SC3281
	13	SCREW (STEEL)	ABA1016	Δ	48	Q2 TRANSISTOR	2SC3281
	14	SCREW (STEEL)	ABA1048	Δ	49	Q3 TRANSISTOR	2SA1302
	15	SCREW (STEEL)	ABA1050	Δ	50	Q4 TRANSISTOR	2SA1302
	16	SCREW 3X14	ABA1082	Δ	51	Q5 TRANSISTOR	2SC4137
	17	SPRING B	ABH-052	Δ	52	Q6 TRANSISTOR	2SC4137
	18	SPRING B	ABH1034		53	S1 SWITCH	ASU1035
	19	NUT	ABN-065		54	S2 SWITCH	ASU1036
Δ	20	AC POWER CORD	ADG1049	Δ	55	T1 POWER TRANSFORMER	ATS1277
	21	RIVET	AEC-441		56	TONE ASS'Y	AWZ2858
	22	STRAIN RELIEF	AEC-882		57	AF COMPLEX ASS'Y	AWZ2861
	23	SHEET	AEE1014		58	LED ASS'Y	
	24	STYROL PROTECTOR	AHA1335		59	SHIELD ASS'Y	
	25	PACKING CASE	AHD1861		60	HEADPHONE ASS'Y	
	26	COVER	AHG1016		61	POWER SW ASS'Y	
	27	TERMINAL SCREW			62	GND SCREW	ABA1047
	28	JUMPER PLUG	AKM1019		63	BINDER	
	29	PANEL BASE (PLS)	AMB1651		64	R1, R2 RESISTORS	RD1/4PM100J
	30	INDICATING LENS	AMR1160			(HEWZ type only)	
	31	INSULATOR ASS'Y	AMR2140				
	32	ARM	AMR2142				
	33	CHASSIS					
	34	FRONT PANEL	ANB1395				
	35	REAR PANEL					

2.2 PARTS LIST OF A-337/HE

Mark	No.	Description	Parts No.	Mark	No.	Description	Parts No.
	1	ROTARY KNOB S (PLS)	AAB1155	Δ	46	FU1 FUSE (T1.6A)	AEK-405
	2	ROTARY KNOB L (PLS)	AAB1160	Δ	47	Q1 TRANSISTOR	2SC3181N
	3	ROTARY KNOB R (PLS)	AAB1162	Δ	48	Q2 TRANSISTOR	2SC3181N
	4	ROTARY KNOB M (PLS)	AAB1166	Δ	49	Q3 TRANSISTOR	2SA1264N
	5	PUSH KNOB C	AAD1366	Δ	50	Q4 TRANSISTOR	2SA1264N
	6	KNOB (POWER)	AAD1535	Δ	51	Q5 TRANSISTOR	2SC4137
	7	PUSH KNOB	AAD1536	Δ	52	Q6 TRANSISTOR	2SC4137
	8	PUSH KNOB C	AAD1803		53	S1 SWITCH	ASU1035
	9	NAME PLATE (METAL)	AAM1029		54	S2 SWITCH	ASU1036
	10	SCREW	ABA-298	Δ	55	T1 POWER TRANSFORMER	ATS1278
	11	SCREW (STEEL)	ABA1009		56	TONE ASS'Y	AWZ2866
	12	SCREW (STEEL)	ABA1011		57	AF COMPLEX ASS'Y	AWZ2867
	13	SCREW (STEEL)	ABA1016		58	LED ASS'Y	
	14	SCREW (STEEL)	ABA1048		59	SHIELD ASS'Y	
	15	SCREW (STEEL)	ABA1050		60	HEADPHONE ASS'Y	
	16	SCREW 3X14	ABA1082		61	POWER SW ASS'Y	
	17	SPRING B	ABH-052		62	-----	
	18	SPRING B	ABH1034		63	BINDER	
	19	NUT	ABN-065		64	R1, R2 RESISTORS	RD1/4PM100J
	20	AC POWER CORD	ADG1049	Δ		(HEWZ type only)	
	21	RIVET	AEC-441				
	22	STRAIN RELIEF	AEC-882				
	23	SHEET	AEE1014				
	24	STYROL PROTECTOR	AHA1335				
	25	PACKING CASE	AHD1863				
	26	COVER SHEET	AHG1016				
	27	TERMINAL SCREW					
	28	JUMPER PLUG	AKM1019				
	29	PANEL BASE (PLS)	AMB1651				
	30	INDICATING LENS	AMR1160				
	31	INSULATOR ASS'Y	AMR2140				
	32	-----					
	33	CHASSIS					
	34	FRONT PANEL	ANB1397				
	35	REAR PANEL					
	36	METAL BONNET	AZN1799				
	37	BOTTOM PLATE					
	38	P.C.B HOLDER					
	39	HEAT SINK					
	40	ROD	ANR-879				
	41	OPERATING INSTRUCTIONS	ARE1162				
	42	SCREW	BBT30P060FZK				
	43	NUTS	NK90FZB				
	44	SCREW	VMZ30P060FCU				
Δ	45	C1 CAPACITOR	CQMXA473J100				

2.3 PACKING

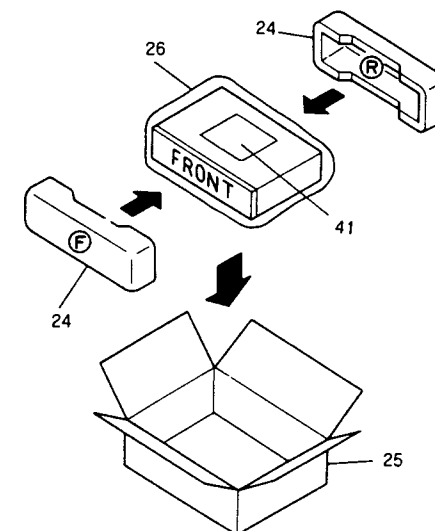

2.4 EXTERIOR

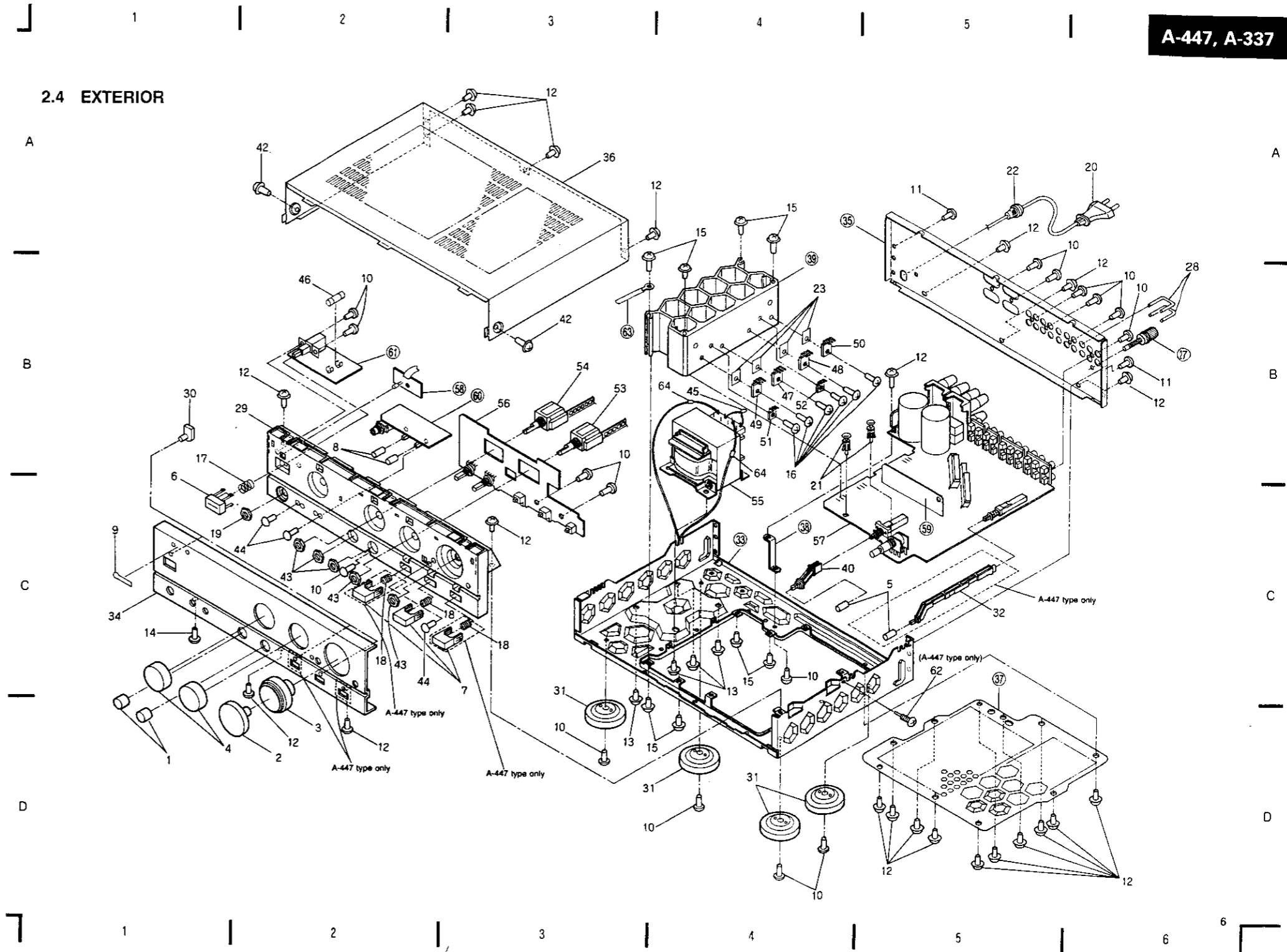

3. FOR A-447/HE TYPE 3.1 SCHEMATIC DIAGRAM

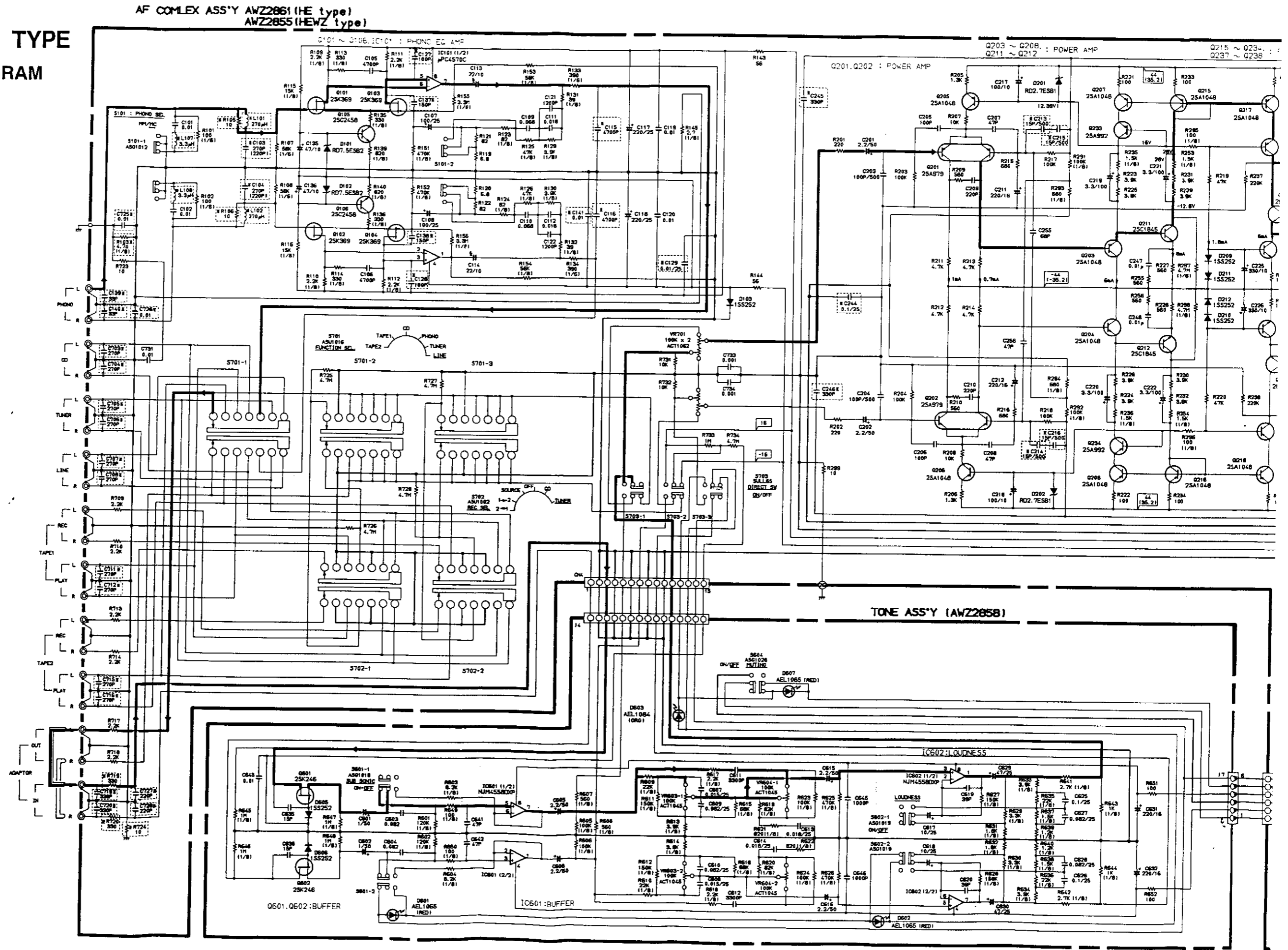

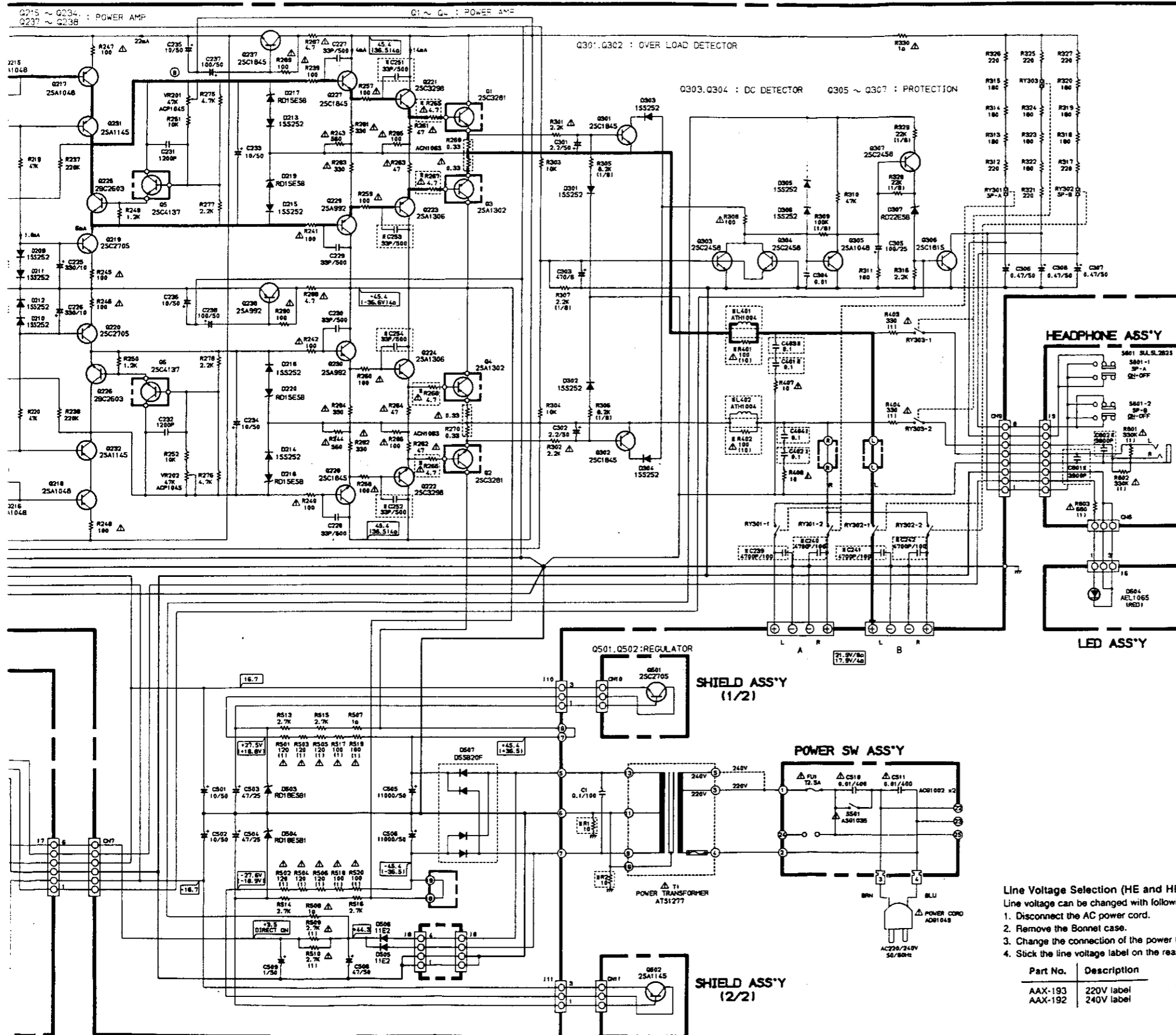

- This circuit diagram is based on the HE version.
- Parts with an asterisk (*) are different from this prepared for the HEWZ version.
- Refer to the comparison list.

⊠ Marks are difference between two assemblies.

	A-447/HE AWZ2861	A-447/HEWZ AWZ2855
AF COMPLEX ASS'Y		
L101, L102	VACANT (OPEN)	ATH1010
L107, L108	VACANT (JAMPER WIRE)	LAU3R3K
L401, L402	VACANT (OPEN)	ATH1009
C103, C104	CCCSL221J50	CCCSL271J50
C115, C116	COMA472K50	COMA392K50
C127, C128	VACANT (OPEN)	CCDSL101J50
C129	VACANT (OPEN)	CKPYX103N25
C137, C138	VACANT (OPEN)	CCCSL151J50
C139, C140	VACANT (OPEN)	CCCSL330J50
C141	VACANT (OPEN)	CKCYF103Z50
C213, C214	CCCSL150K500	CCCSL080D500
C215, C216	CCCSL150K500	VACANT (JAMPER WIRE)
C239-C242	VACANT (OPEN)	COMXA472J100
C244	VACANT (OPEN)	CKDYX104M25
C245, C246	VACANT (OPEN)	CKCYB331K50
C251-C254	CCCSL330K500	CCCSL680K500
C401, C402	CFTXA104J50	CFTXA473J50
C403, C404	CFTXA104J50	VACANT (JAMPER WIRE)
C703-C708	VACANT (OPEN)	CCCSL271J50
C711, C712	VACANT (OPEN)	CCCSL271J50
C715, C716	VACANT (OPEN)	CCCSL271J50
C719, C720	CKCYB331K50	CCCSL271J50
C725	CKCYF103Z50	CCDSL221J50
C726	VACANT (OPEN)	CKCYF103Z50
C727, C728	VACANT (JAMPER WIRE)	CCCSL221J50
R103	VACANT (OPEN)	RD1/8PM4R7J
R105, R106	RDR1/8PM100J	RD1/8PM472J
R265-R268	RFA1/4MPS4R7J	RFA1/4MPS470J
R401, R402	RD1/4MPL100J	RD1/4MPL101J
R719, R720	VACANT (OPEN)	RD1/8PM331J
R724	VACANT (OPEN)	RD1/8PM100J
HEAD PHONE ASS'Y	AWZ2862	AWZ2857
C801, C802	VACANT (OPEN)	CKCYB332K50
OTHERS		
R1, R2	VACANT (OPEN)	RD1/4PM100J

- RESISTORS:**
Indicated in Ω , 1/8, 1/4W, $\pm 5\%$ tolerance unless otherwise noted
K; k Ω , M; M Ω , (F); $\pm 1\%$, (G); $\pm 2\%$, (K); $\pm 10\%$, (M); $\pm 20\%$ tolerance.
- CAPACITORS:**
Indicated in capacity (μ F) / voltage (V) unless otherwise noted; p; pF
Indication without voltage is 50V except electrolytic capacitor.
- VOLTAGE CURRENT:**
 - V : Signal voltage at (60W + 60W/8 Ω , 80W + 80W/4 Ω) output (1kHz).
 - : DC voltage (V) at no input signal.
 - Value in () is DC voltage at rated power.
 - mA : DC current at no input signal.
 - mV : Signal voltage at FM 400Hz \pm 75Hz DEV.
- OTHERS**
 - : Signal route.
 - ⊙ : Adjusting point.
 - ⊠ : The mark found on some component parts indicates the importance of the safety factor of the part. Therefore, when replacing, be sure to use parts of identical designation.
 - * marked capacitor and resistor have parts number.
 - This is the basic schematic diagram, but the actual circuit way vary due to improvements in design.
- SWITCHES (The underline indicates the switch position)**
 - S601 : SUBSONIC (ON-OFF)
 - S602 : LOUDNESS (ON-OFF)
 - S604 : MUTING (ON-OFF)
 - S101 : PHONO SEL (MM-MC)
 - S701 : FUNCTION SEL (TAPE 2 - TAPE 1 - CD - PHONO - TUNER - LINE)
 - S702 : REC SEL (2-1 - 1-2 - SOURCE - OFF - CD - TUNER)
 - S703 : DIRECT SW (ON - OFF)
 - S801-1 : SPEAKERS-A (ON-OFF)
 - S801-2 : SPEAKERS-B (ON-OFF)
 - S501 : POWER SW (ON - OFF)

Line Voltage Selection (HE and HEWZ types)
Line voltage can be changed with following steps.

1. Disconnect the AC power cord.
2. Remove the Bonnet case.
3. Change the connection of the power transformer lead wire.
4. Stick the line voltage label on the rear panel.

Part No.	Description	220V	240V
AAX-193	220V label	—	---
AAX-192	240V label	---	—

AF COMPLEX ASS'Y
 AWZ2861 (HE type)
 AWZ2855 (HEWZ type)

3.2 P.C. BOARDS CONNECTION DIAGRAM

- Parts with an asterisk (*) are different according to versions, HE or HEWZ. Refer to page 10 for details.

A

AC POWER CORD
 AC220/240V
 50/60HZ

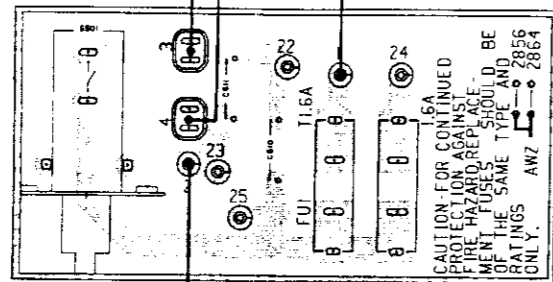

POWER SW ASS'Y

T1
 POWER TRANSFORMER

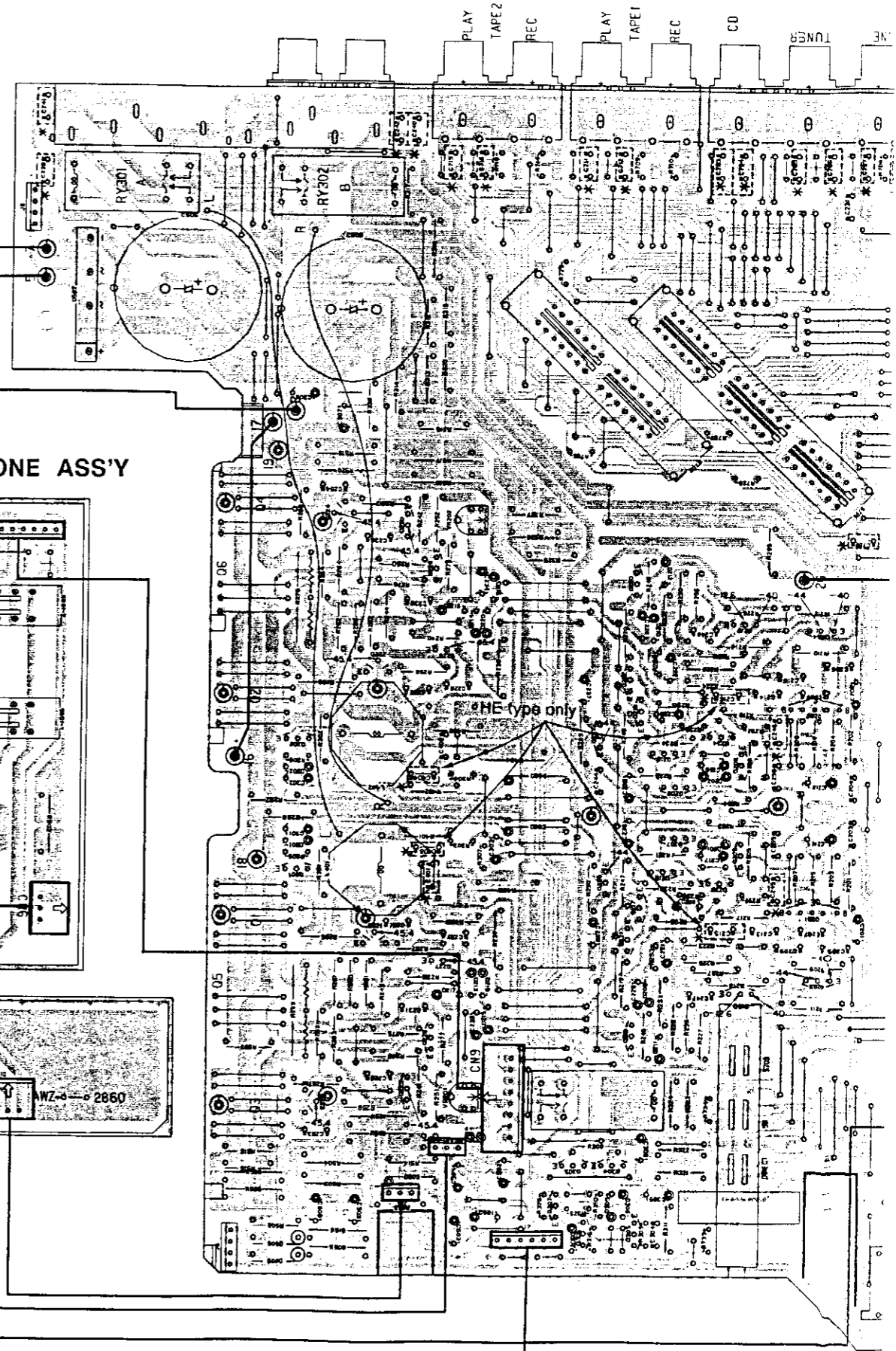
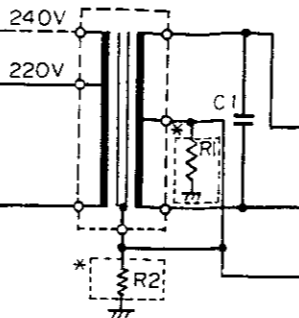

HEADPHONE ASS'Y

LED ASS'Y

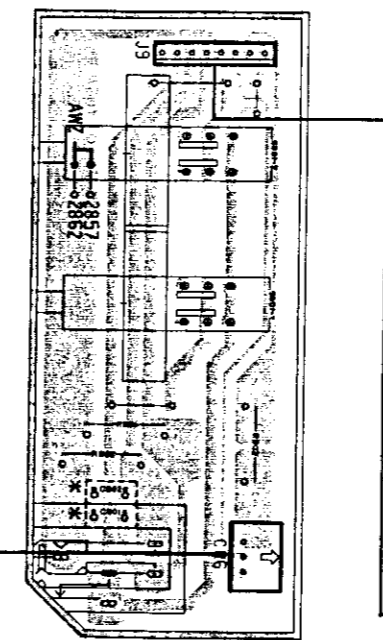
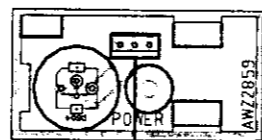

B

C

tone ASS'Y (AWZ2858)

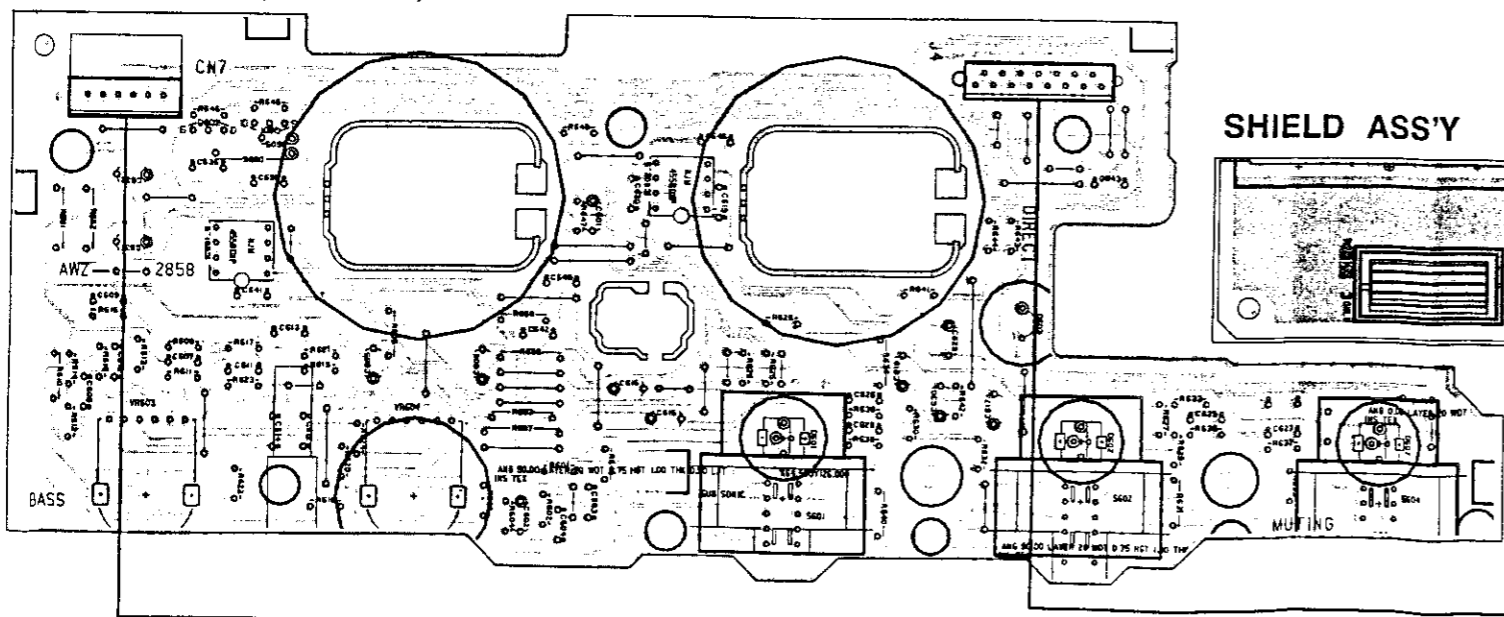

SHIELD ASS'Y

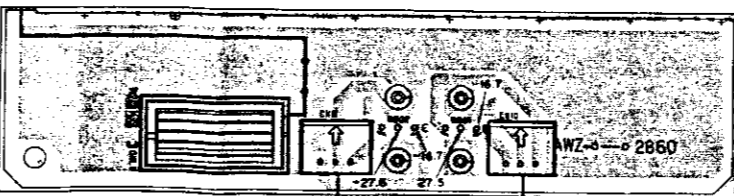

D

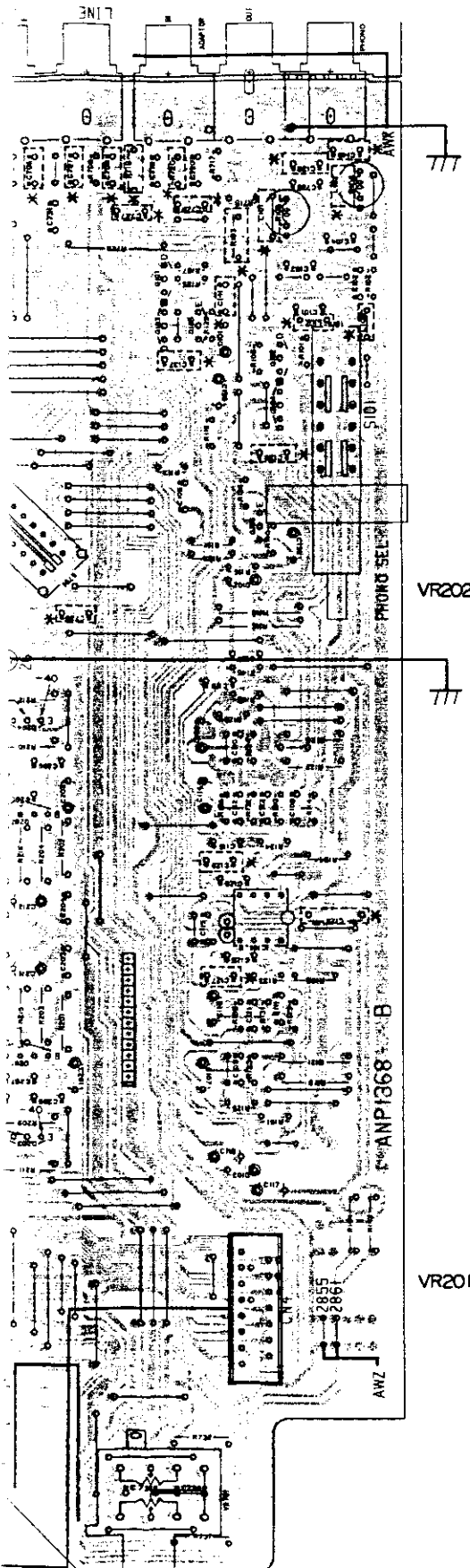

- Q101
- Q103
- Q105
- Q102
- Q104
- Q106
- VR202 Q224
- Q230
- Q226 Q220
- Q212
- Q222 Q204
- Q228 Q232
- Q218
- Q202
- Q302 Q237
- Q234
- Q216 IC101
- Q206
- Q208
- Q207
- Q205
- Q301 Q238
- Q215
- Q233
- Q221 Q217
- Q201
- Q227 Q231
- Q203
- Q225 Q219
- Q229
- VR201 Q223
- Q303
- Q304
- Q307
- Q306
- Q305

1. This P.C.B. connection diagram is seen from the parts mount side.
2. The parts mounted on to the P.C.B. can be replaced with those shown in the following correspondence table with wiring marks.

Indication of the P.C.B. pattern	Symbol of corresponding parts	Parts name
		Transistor
		Radiator type transistor
		Diode
		Resistor
		Condenser (Polar type)
		Condenser (Non-polar type)

Others

Wiring mark on the P.C.B. pattern diagram	Parts list
IC	IC
S	Switch
RY	Relay
L	Coil
F	Filter
VR	Variable resistor or semi-fixed resistor

3. The condenser terminal marked with double circles (©) represents (-) terminal.
4. The diode terminal marked with double circles (©) represents the cathode side.
5. The transistor terminal marked with "E" represents an emitter.

View from soldering side

This P.C.B. connection diagram is viewed from the foil side.

- Q101
- Q103
- Q102
- Q105
- Q104
- Q106
- Q554
- Q530
- Q556
- Q550
- Q515
- Q504
- Q558
- Q535
- Q518
- Q505
- Q534
- Q516
- Q508
- Q508
- Q507
- Q502
- Q502
- Q538
- Q501
- Q512
- Q533
- Q517
- Q501
- Q531
- Q503
- Q552
- Q519
- Q558
- Q553
- Q303
- Q304
- Q301
- Q306
- Q302

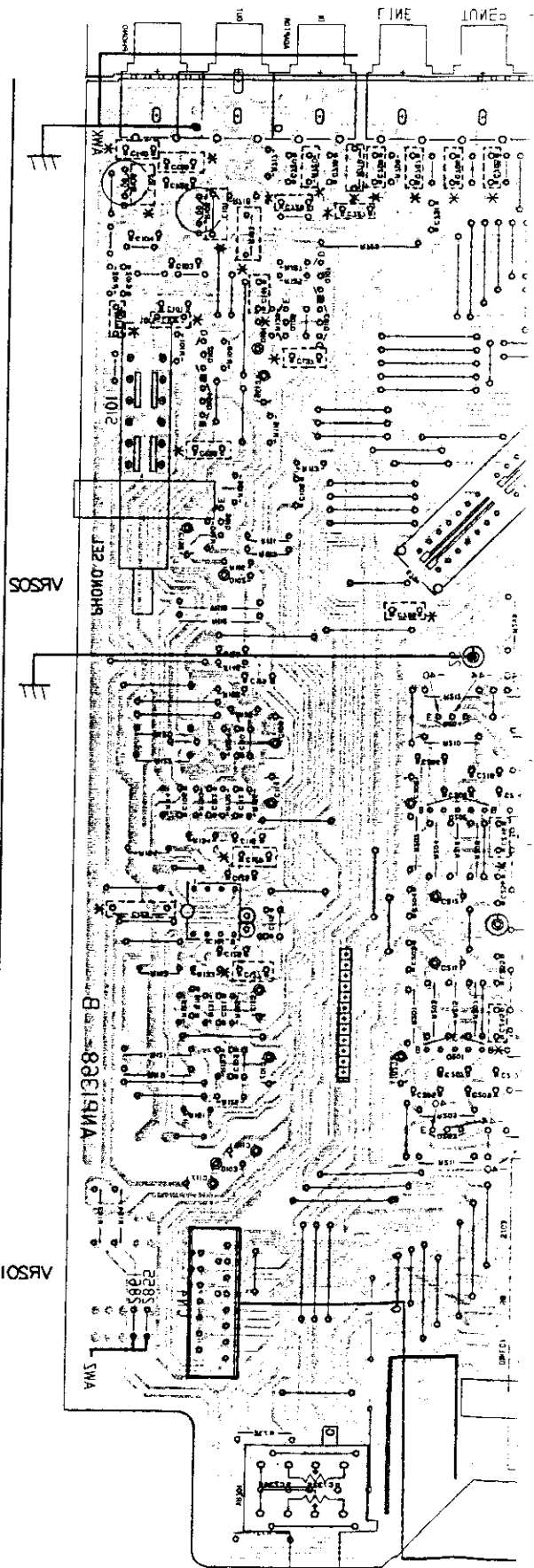

3.2 P.C. BOARDS CONNECTION DIAGRAM

- Parts with an asterisk (*) are different according to versions, HE or HEWZ. Refer to page 10 for details.

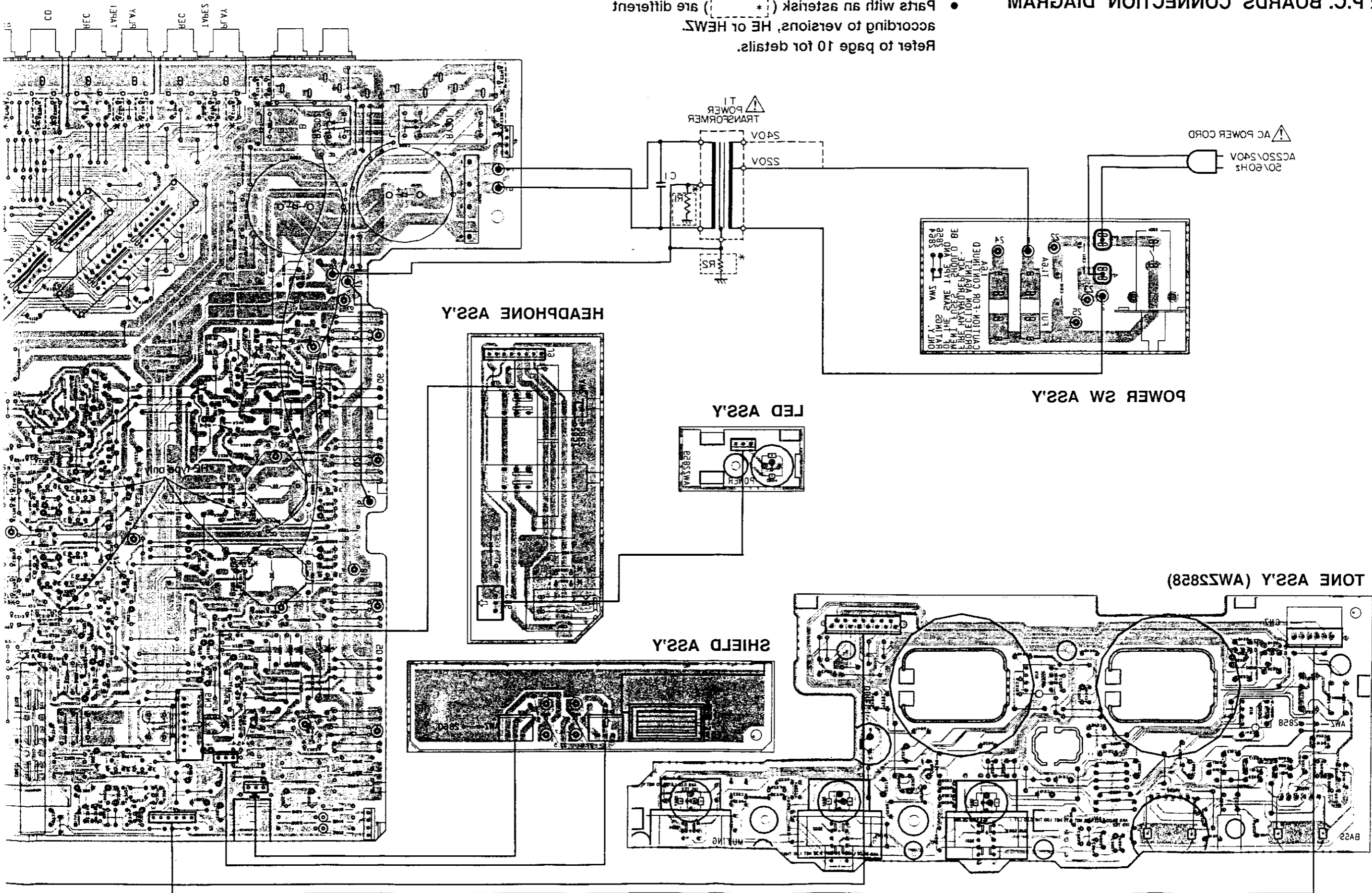

AWZ5282 (HEWZ type)
AWZ5281 (HE type)
AF COMPLEX ASSY

A
B
C
D

3.3 P.C.B's PARTS LIST

NOTES:

- Parts without part number cannot be supplied.
- Parts marked by "△" are not always kept in stock. Their delivery time may be longer than usual or they may be unavailable.
- The △ mark found on some component parts indicates the importance of the safety factor of the part. Therefore, when replacing, be sure to use parts of identical designation.
- When ordering resistors, first convert resistance values into code form as shown in the following examples.
 - Ex. 1 When there are 2 effective digits (any digit apart from 0), such as 560 ohm and 47k ohm (tolerance is shown by J = 5%, and K = 10%).

560Ω	56 × 10 ¹	561	RD14PS	□ □ J
47kΩ	47 × 10 ³	473	RD14PS	□ □ J
0.5Ω	0RS		RN2H	□ □ K
1Ω	010		RS1P	□ □ K
 - Ex. 2 When there are 3 effective digits (such as in high precision metal film resistors).

5.62kΩ	562 × 10 ¹	5621	RN14SR	□ □ □ F
--------	-----------------------	------	--------	---------

Mark No.	Description	Parts No.	Mark No.	Description	Parts No.
LED ASS'Y					
SEMICONDUCTOR					
	D604 LED(RED)	AEL1065			
SHIELD ASS'Y					
SEMICONDUCTORS					
	Q501 TRANSISTOR	2SC2705			
	Q502 TRANSISTOR	2SA1145			
OTHERS					
	CN10,CN11 JUMPER CONNECTOR 3-P	KPC3			
HEADPHONE ASS'Y					
RESISTORS					
△	R801,R802 METAL OXIDE RESISTOR	RS1PMF331J			
△	R803 METAL OXIDE RESISTOR	RS1LMF681J			
SWITCH					
	S801 PUSH SWITCH	SUL5L2B2S			
OTHERS					
	CN6 JUMPER CONNECTOR 3-P JACK	KPC3 AKN1002			
POWER SW ASS'Y					
CAPACITORS					
△	C510,C511 CKA (0.01/AC400V)	ACG1002			
SWITCH					
△	S501 PUSH SWITCH	ASG1035			
TONE ASS'Y (AWZ2858)					
SEMICONDUCTORS					
	IC601,IC602 IC	NJM4558DXP			
	Q601,Q602 N-FET	2SK246			
	D601,D602 LED(RED)	AEL1065			
	D603 LED	AEL1084			
	D605,D606 DIODE	1SS252			
	D607 LED(RED)	AEL1065			

Mark No.	Description	Parts No.
△	R269,R270 RESISTOR (0.33, 5W)	ACN1063
	R275-R278 CARBON FILM RESISTOR	RD14PM□□□J
△	R281-R284 FUSIBLE RESISTOR	RFA14PS331J
△	R285,R286 FUSIBLE RESISTOR	RFA14PS101J
△	R287,R288 CARBON FILM RESISTOR	RD14PMF4R7J
△	R289,R290 FUSIBLE RESISTOR	RFA14PS101J
	R299 CARBON FILM RESISTOR	RD14PM100J
△	R301,R302 CARBON FILM RESISTOR	RD14PMF222J
△	R308 CARBON FILM RESISTOR	RD14PMF101J
	R311-R315 CARBON FILM RESISTOR	RD14PM□□□J
	R317-R327 CARBON FILM RESISTOR	RD14PM□□□J
△	R330 CARBON FILM RESISTOR	RD14PMF010J
△	R401,R402 CARBON FILM RESISTOR	RD14PMFL100J
△	R403,R404 METAL OXIDE RESISTOR	RS1LMF331J
△	R407,R408 CARBON FILM RESISTOR	RD14PMFL100J
△	R501,R502 METAL OXIDE RESISTOR	RS1PMF121J
△	R503,R504 METAL OXIDE RESISTOR	RS1LMF121J
△	R505,R506 METAL OXIDE RESISTOR	RS1PMF121J
△	R507,R508 CARBON FILM RESISTOR	RD14PMF010J
△	R509,R510 METAL OXIDE RESISTOR	RS1LMF272J
	R513-R516 CARBON FILM RESISTOR	RD14PM272J
△	R517-R520 METAL OXIDE RESISTOR	RS1PMF101J
	R731,R732 CARBON FILM RESISTOR	RD14PM103J
	OTHER RESISTORS	RD18PM□□□J
SWITCHES		
	S101 PUSH SWITCH	ASG1012
	S701 SWITCH	ASU1016
	S702 SWITCH	ASU1002
	S703 PUSH SWITCH	SULL6S
OTHERS		
	CN4 JUMPER CONNECTOR	KPE15
	CN9 JUMPER CONNECTOR	KPC8
	RY301,RY302 RELAY	ASR-112
	RY303 RELAY	ASR-111
	PHONO JACK 4-P	AKB1007
	PHONO JACK 6-P	AKB1008
	PHONO JACK 6-P	AKB1024
	SPEAKER TERMINAL 8-P	AKE1011

Mark No.	Description	Parts No.	Mark No.	Description	Parts No.
	Q211,Q212 TRANS	2SC1845		C219-C222 ELECTR. CAPACITOR	CEAS3R3M100
	Q215-Q218 TRANC	2SA1048		C225,C226 ELECTR. CAPACITOR	CEAS331M10
	Q219,Q220 TRANC	2SC2705		C227-C230 CERAMIC CAPACITOR	CCCSL330K500
	Q221,Q222 TRANSISTOR	2SC3298		C231,C232 CERAMIC CAPACITOR	CKCYB122K50
	Q223,Q224 TRANSISTOR	2SA1306		C233-C236 ELECTR. CAPACITOR	CEAS100M50
	Q225,Q226 TRANSISTOR	2SC2603		C237,C238 ELECTR. CAPACITOR	CEAS101M50
	Q227,Q228 TRANSISTOR	2SC1845		C247,C248 AUDIO FILM CAPACITOR	CFTXA103J50
	Q229,Q230 TRANSISTOR	2SA992		C251-C254 CERAMIC CAPACITOR	CCCSL330K500
	Q231,Q232 TRANSISTOR	2SA1145		C255 CERAMIC CAPACITOR	CCCSL680J50
	Q233,Q234 TRANSISTOR	2SA992		C256 CERAMIC CAPACITOR	CCDSL470J50
	Q237 TRANSISTOR	2SC1845		C301,C302 ELECTR. CAPACITOR	CEAS2R2M50
	Q238 TRANSISTOR	2SA992		C303 ELECTR. CAPACITOR	CEAS471M6
	Q301,Q302 TRANSISTOR	2SC1845		C304 CERAMIC CAPACITOR	CKCYF103Z50
	Q303,Q304 TRANSISTOR	2SC2458		C305 ELECTR. CAPACITOR	CEAS101M25
	Q305 TRANSISTOR	2SA1048		C306-C308 ELECTR. CAPACITOR	CEASR47M50
	Q306 TRANSISTOR	2SC1815		C401-C404 AUDIO FILM CAPACITOR	CFTXA104J50
	Q307 TRANSISTOR	2SC2458		C501,C502 ELECTR. CAPACITOR	CEAS100M50
	D101,D102 ZENER DIODE	RD7.5ESB2		C503,C504 ELECTR. CAPACITOR	CEAS470M25
	D103 DIODE	1SS252		C505,C506 ELECTR. CAPACITOR (15000/5V)	ACH1078
	D201,D202 ZENER DIODE	RD2.7ESB1		C508 ELECTR. CAPACITOR	CEAS470M50
	D209-D216 DIODE	1SS252		C509 ELECTR. CAPACITOR	CEAS101M50
	D217-D220 ZENER DIODE	RD15ESB		C719,C720 CERAMIC CAPACITOR	CKCYB331K50
	D301-D306 DIODE	1SS252		C725 CERAMIC CAPACITOR	CKCYF103Z50
	D307 ZENER DIODE	RD22ESB		C731 CERAMIC CAPACITOR	CKCYF103Z50
	D503,D504 ZENER DIODE	RD18ESB1		C733,C734 CERAMIC CAPACITOR	CKDYF102Z50
	D505,D506 DIODE	11E2	COILS & FILTERS		
	D507 DIODE	D5SB20F		L401,L402 COIL	ATH1004
CAPACITORS					
	C101,C102 AUDIO FILM CAPACITOR	CFTXA103J50	RESISTORS		
	C103,C104 CERAMIC CAPACITOR	CCCSL221J50		VR201,VR202 SEMI-FIXED(47K)	ACP1045
	C105,C106 CERAMIC CAPACITOR	CKCYB472K50		VR701 VARIABLE(100K-20AX2)	ACT1062
	C107,C108 ELECTR. CAPACITOR	CEXA101M25		R101,R102 CARBON FILM RESISTOR	RDR14PM101J
	C109,C110 AUDIO FILM CAPACITOR	CFTXA683J50		R105-R108 CARBON FILM RESISTOR	RDR18PU□□□J
	C111,C112 AUDIO FILM CAPACITOR	CFTXA183J50		R119-R122 CARBON FILM RESISTOR	RDR14PM□□□J
	C113,C114 ELECTR. CAPACITOR	CEANP220M10		R133,R134 CARBON FILM RESISTOR	RDR14PM391J
	C115,C116 MYLOR FILM CAPACITOR	QOMA472K50		R143,R144 CARBON FILM RESISTOR	RD14PM560J
	C117,C118 ELECTR. CAPACITOR	CEAS221M25		R201-R204 CARBON FILM RESISTOR	RDR14PM□□□J
	C119,C120 CERAMIC CAPACITOR	CKCYF103Z50		R205-R214 CARBON FILM RESISTOR	RD14PM□□□J
	C121,C122 MYLOR FILM CAPACITOR	QOMA122J50		R215-R218 CARBON FILM RESISTOR	RDR14PM□□□J
	C135,C136 ELECTR. CAPACITOR	CEAS470M10		'219-R234 CARBON FILM RESISTOR	RD14PM□□□J
	C201,C202 ELECTR. CAPACITOR	CEEA2R2M50		237,R238 CARBON FILM RESISTOR	RDR14PM224J
	C203,C204 MICA CAPACITOR	CCCSL101K500		1239-R242 FUSIBLE RESISTOR	RFA14PS101J
	C205,C206 CERAMIC CAPACITOR	CCCSL101J50		△ R243,R244 CARBON FILM RESISTOR	RD14PMF561J
	C207,C208 CERAMIC CAPACITOR	CCCSL470J50		△ R245-R248 FUSIBLE RESISTOR	RFA14PS101J
	C209,C210 CERAMIC CAPACITOR	CCCSL221J50		R249-R252 CARBON FILM RESISTOR	RD14PM□□□J
	C211,C212 ELECTR. CAPACITOR	CEEA221M16		R255,R256 CARBON FILM RESISTOR	RD14PM561J
	C213-C216 CERAMIC CAPACITOR	CCCSL150K500		△ R257-R260 FUSIBLE RESISTOR	RFA14PS101J
	C217,C218 ELECTR. CAPACITOR	CEAS101M10		△ R261-R264 FUSIBLE RESISTOR	RFA14PS470J
				△ R265-R268 FUSIBLE RESISTOR	RFA14PS4R7J

3.4 ADJUSTMENT

ADJUSTMENT OF IDLE CURRENT

- Connect wire as shown in Fig. 3-1.
- After power ON, aging lasts for 5 mins with no-load.
- In the Lch VR201 should be adjusted so that both terminal voltages of R269 may attain to 20 mV (± 3 mV).
- In the Rch VR202 should be adjusted so that both terminal voltages may attain to 20 mV (± 3 mV).

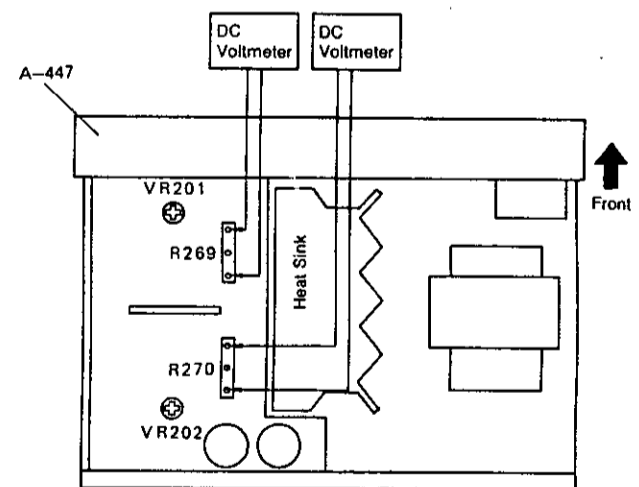
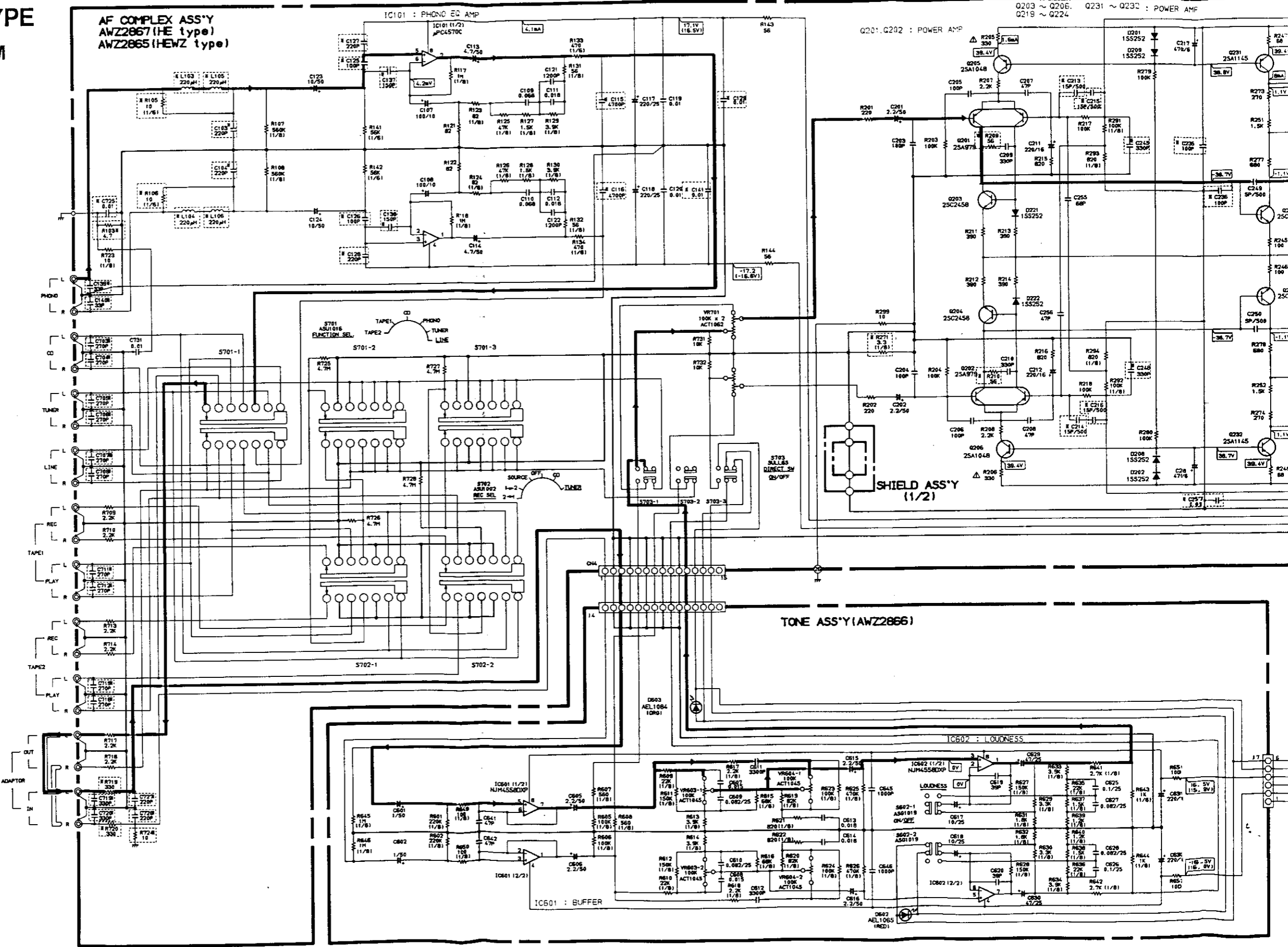
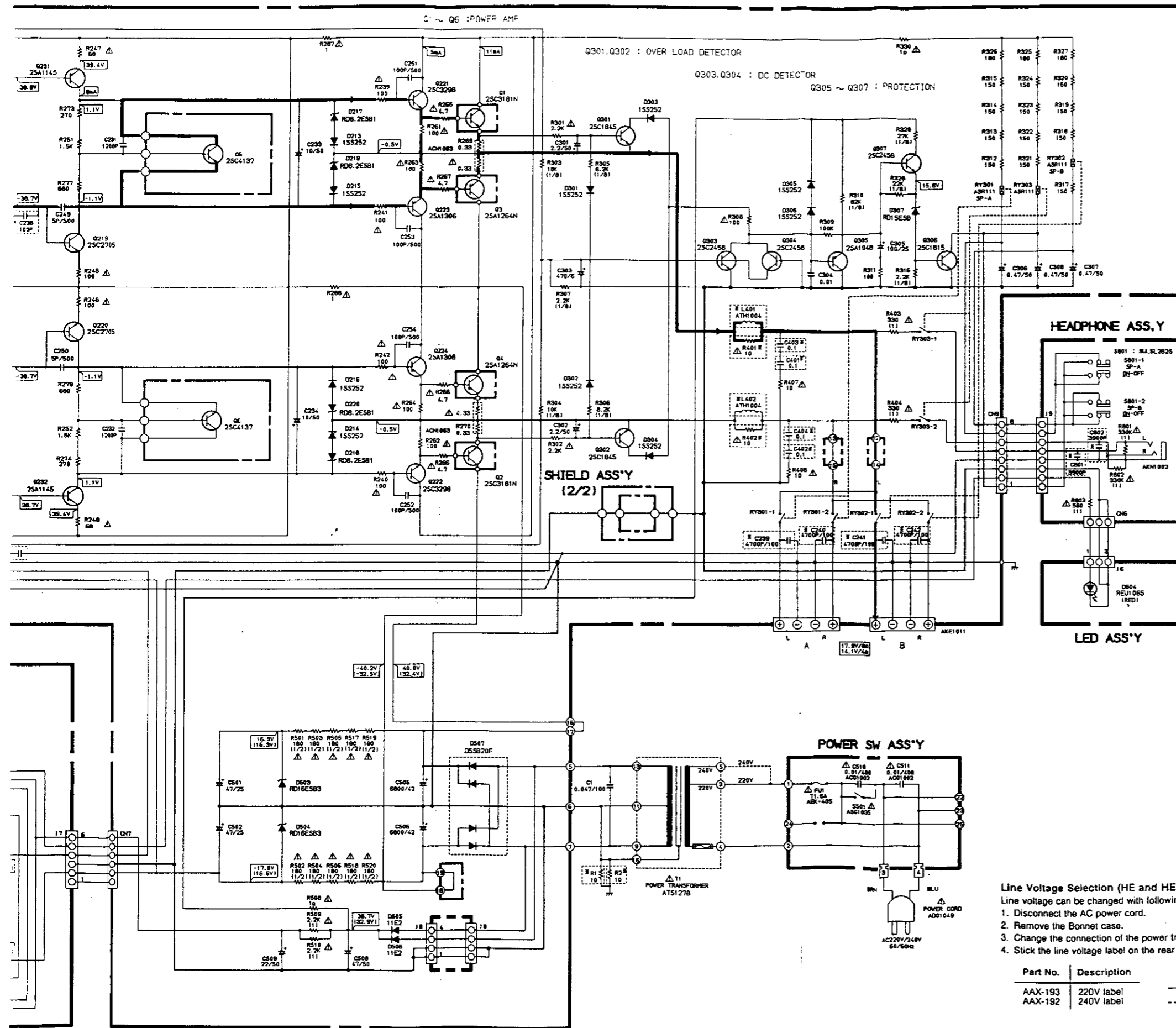

Fig. 3-1 Adjustment Drawing

4. FOR A-337/HE TYPE
4.1 SCHEMATIC DIAGRAM





- This circuit diagram is based on the HE version.
- Parts with an asterisk (*) are different from this prepared for the HEWZ version.
- Refer to the comparison list.

△ Marks are difference between two assemblies.

AF COMPLEX ASS'Y	A-337/HE AWZ2867	A-337/HEWZ. A-337-S/HEWZ AWZ2865
L103 -L106 L401, L402	VACANT (OPEN) ATH1004	LAU221K ATH1009
C103, C104 C115, C116 C125, C126 C127, C128 C129	CCCSL221J50 CDMA472K50 VACANT (OPEN) VACANT (OPEN) VACANT (OPEN)	CCCSL330J50 CDMA392K50 CCCSL101J50 CCCSL221J50 CKPYX103N25
C139, C140 C141 C213, C214 C215, C216 C235, C236	VACANT (OPEN) VACANT (OPEN) CCCSL150K500 CCCSL150K500 CCCSL101J50	CCCSL330J50 CKCYF103Z50 CCCSL080D500 VACANT (OPEN) CEASOR1M50
C239-C242 C245, C246 C257 C401, C402 C403, C404	VACANT (OPEN) VACANT (OPEN) VACANT (OPEN) CFTXA104J50 CFTXA104J50	COMXA472J100 CKCYB331K50 CKCYF103Z50 CFTXA473J50 VACANT (JAMPER WIRE)
C703-C708 C711, C712 C715, C716 C719, C720 C725	VACANT (OPEN) VACANT (OPEN) VACANT (OPEN) CKCYB331K50 CKCYF103Z50	CCCSL271J50 CCCSL271J50 CCCSL271J50 CCCSL271J50 CCCSL221J50
C727, C728 R103 R105, R106 R200, R210 R271	VACANT (OPEN) VACANT (OPEN) RDR1/8PM100J RD1/4PM331J VACANT (OPEN)	CCCSL221J50 RD1/8PM4R7J RD1/8PM332J RD1/4PM560J RD1/8PM3R3J
R401, R402 R719, R720 R724	RD1/4PMFL100J VACANT (JUMPER WIRE) VACANT (OPEN)	RD1/4PMFL101J RD1/8PM331J RD1/8PM100J
HEAD PHONE ASS'Y	AWZ2862	AWZ2857
C801, C802	VACANT (OPEN)	CKCYB392K50
OTHERS		
R1, R2	VACANT (OPEN)	RD1/4PM100J

- RESISTORS:**
Indicated in Ω, 1/8, 1/4W, ± 5% tolerance unless otherwise noted
K; kΩ, M; MΩ, (F); ± 1%, (G); ± 2%, (K); ± 10%, (M); ± 20% tolerance.
- CAPACITORS:**
Indicated in capacity (μF) / voltage (V) unless otherwise noted p; pF.
Indication without voltage is 50V except electrolytic capacitor.
- VOLTAGE CURRENT:**
 - V : Signal voltage at (40W + 40W/8Ω, 50W + 50W/4Ω) output (1kHz).
 - DC : DC voltage (V) at no input signal.
 - Value in () is DC voltage at rated power.
 - mA : DC current at no input signal.
 - mV : Signal voltage at FM 400Hz ± 75Hz DEV.
- OTHERS**
 - : Signal route.
 - ⊙ : Adjusting point.
 - The △ mark found on some component parts indicates the importance of the safety factor of the part. Therefore, when replacing, be sure to use parts of identical designation.
 - * marked capacitor and resistor have parts number.
 - This is the basic schematic diagram, but the actual circuit way vary due to improvements in design.
- SWITCHES (The underline indicates the switch position)**
 - S501 : POWER SW (ON-OFF)
 - S602 : LOUDNESS (ON-OFF)
 - S701 : FUNCTION SEL (TAPE 2 - TAPE 1 - CD - PHONO - TUNER - LINE)
 - S702 : REC SEL (2-1 - 1-2 - SOURCE - OFF - CD - TUNER)
 - S703 : SULLES (ON - OFF)
 - S801-1 : SPEAKERS-A (ON-OFF)
 - S801-2 : SPEAKERS-B (ON-OFF)

Line Voltage Selection (HE and HEWZ types)

- Line voltage can be changed with following steps.
1. Disconnect the AC power cord.
 2. Remove the Bonnet case.
 3. Change the connection of the power transformer lead wire.
 4. Stick the line voltage label on the rear panel.

Part No.	Description	220V	240V
AAX-193	220V label	—	---
AAX-192	240V label	---	—

AF COMPLEX ASS'Y
 AWZ2867 (HE type)
 AWZ2865 (HEWZ type)

4.2 P.C. BOARDS CONNECTION DIAGRAM

- Parts with an asterisk (*) are different according to versions, HE or HEWZ. Refer to page 26 for details.

A

B

C

D

AC POWER CORD
 AC220/240V
 50/60Hz

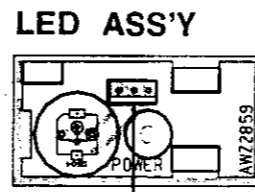
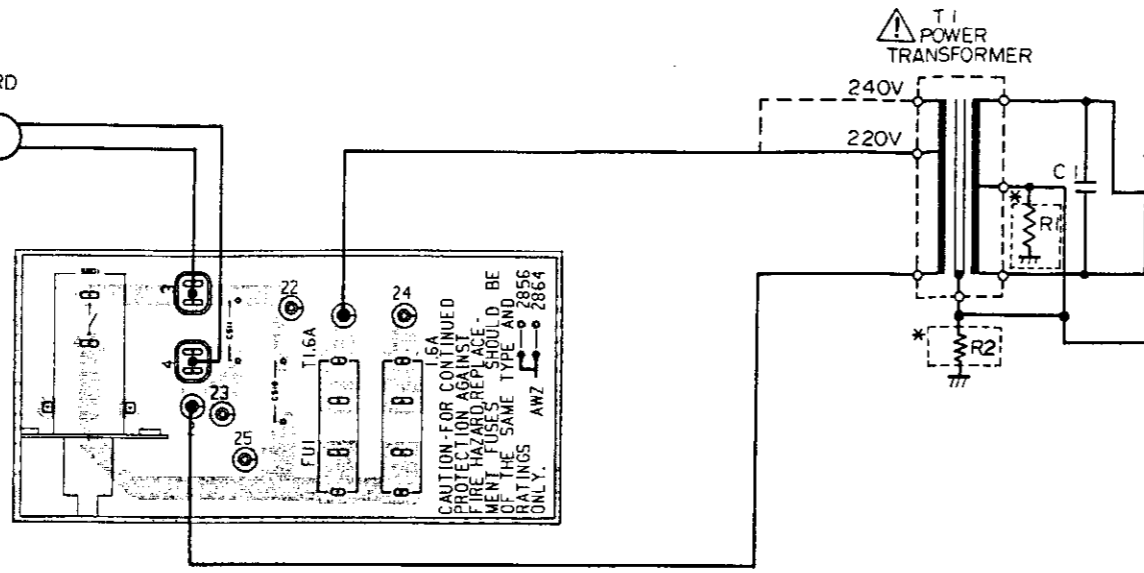

HEADPHONE ASS'Y

TONE ASS'Y (AWZ2866)

SHIELD ASS'Y

AWZ-2860

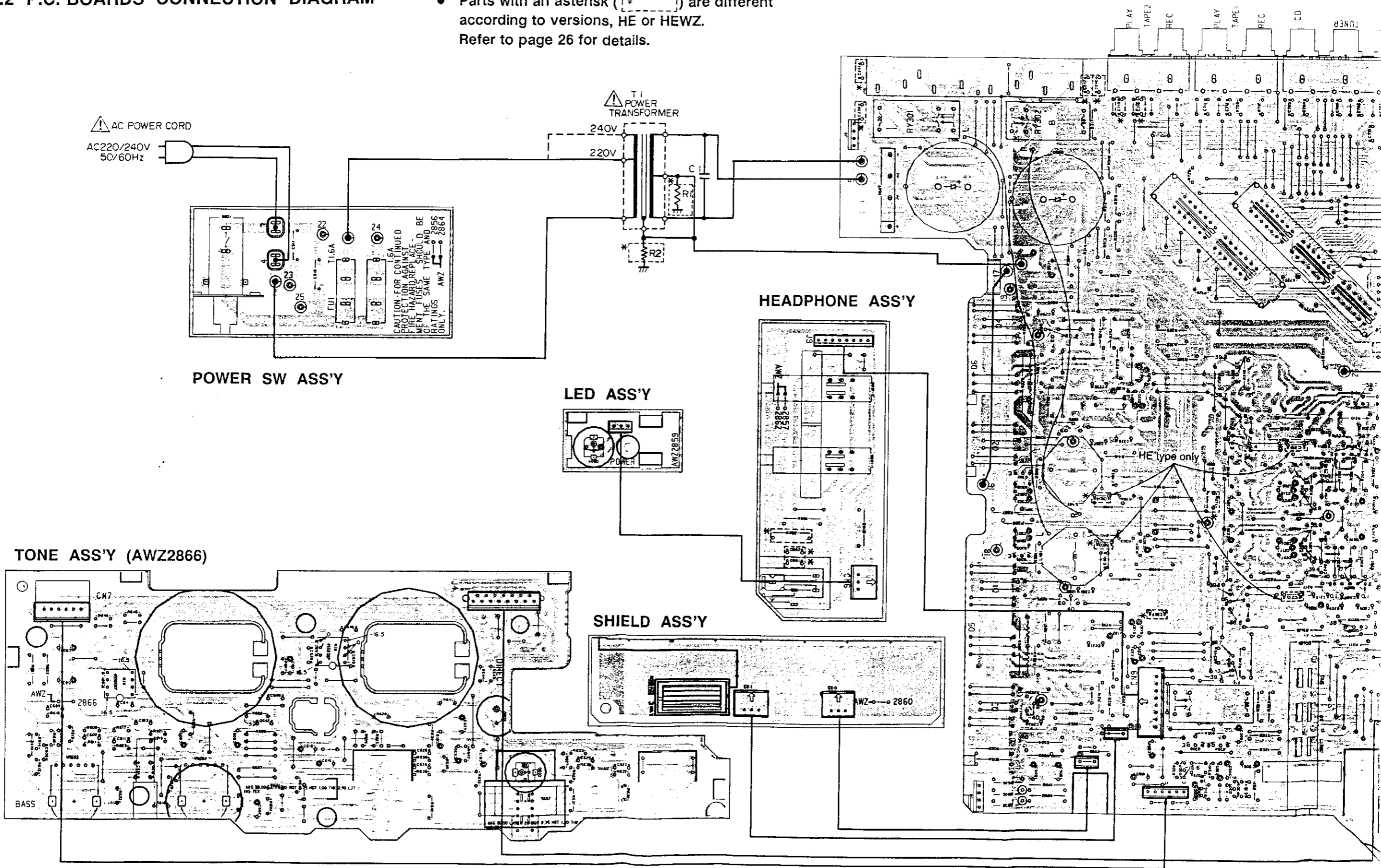

AF COMPLEX ASS'Y
 AWZ2867 (HE type)
 AWZ2865 (HEWZ type)

are different
 or HEWZ.
 ils.

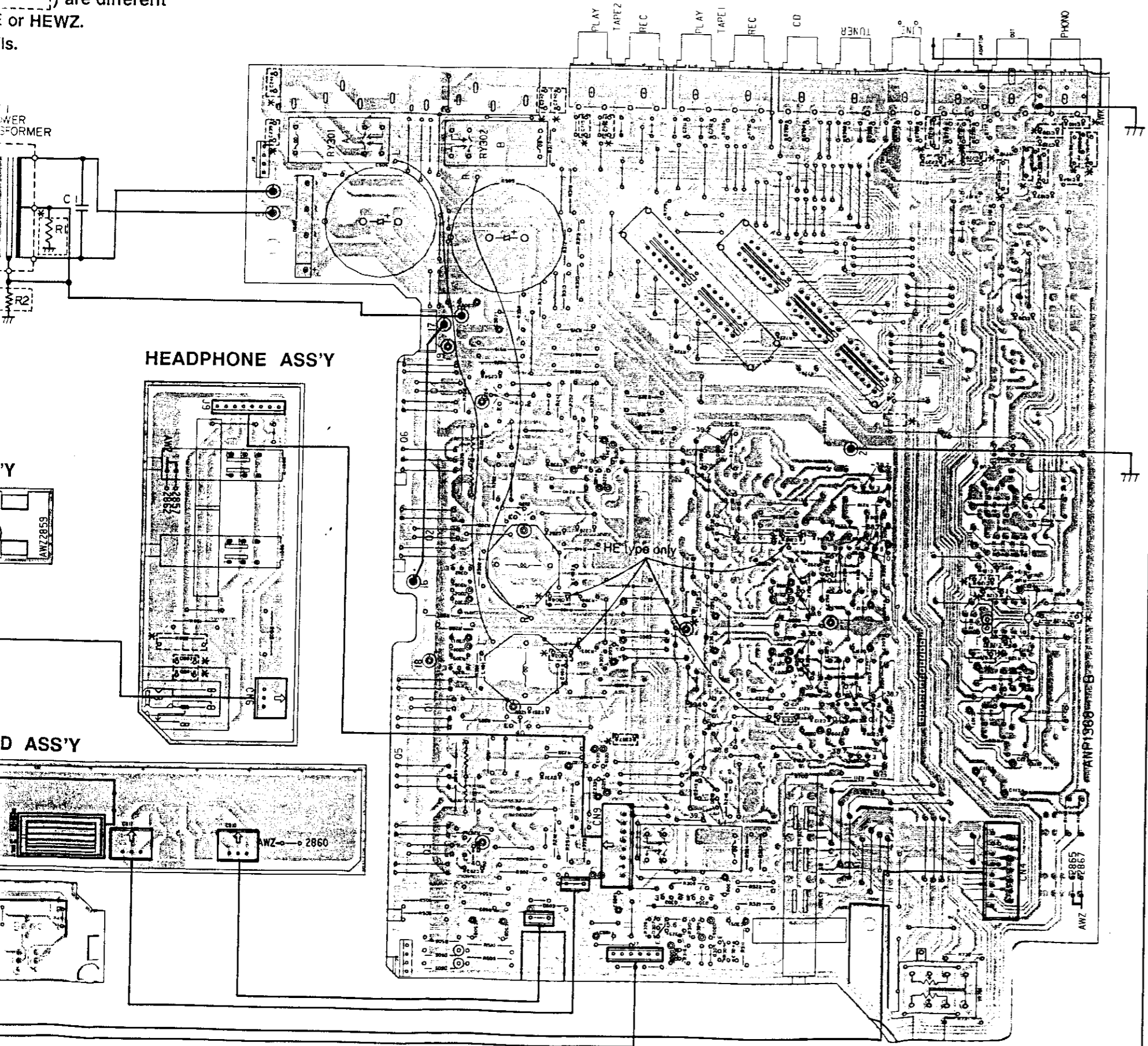

- Q224
- Q220
- Q204
- Q222
- Q232
- Q202
- Q302
- Q206
- IC101
- Q205
- Q301
- Q201
- Q221
- Q231
- Q203
- Q219
- Q223
- Q303
- Q304
- Q307
- Q306
- Q305

1. This P.C.B connection diagram is seen from the parts mount side.
2. The parts mounted on to the P.C.B can be replaced with those shown in the following correspondence table with wiring marks.

Indication of the P.C.B. pattern	Symbol of corresponding parts	Parts name
Q504 EO ○ ○	or EO ○ ○	Transistor
Q215 ○ ○ ○	or ○ ○ ○	Radiator type transistor
D203 ◎ ○	D203	Diode
R237 ○ — R237 — ○	R237	Resistor
C513 ◎ ○	◎ ○	Condenser (Polar type)
C518 □ ○ ○	□ ○ ○	Condenser (Non-polar type)

Others

Wiring mark on the P.C.B pattern diagram	Parts list
IC	IC
S	Switch
RY	Relay
L	Coil
F	Filter
VR	Variable resistor or semi-fixed resistor

3. The condenser terminal marked with double circles (◎) represents (-) terminal.
4. The diode terminal marked with double circles (◎) represents the cathode side.
5. The transistor terminal marked with "E" represents an emitter.

A
 B
 C
 D

AW528e5 (HEW3 type)
AW528e7 (HE type)
AF COMPLEX ASSY

(*) are different
HE or HEW3
details.

A ● View from soldering side

This P.C.B. connection diagram is viewed from the foil side.

B
C
D

Q534
Q550
Q504
Q555
Q335
Q505
Q305
Q506
Q508
IC101
Q502
Q501
Q511
Q521
Q503
Q51a
Q552
Q303
Q304
Q301
Q302

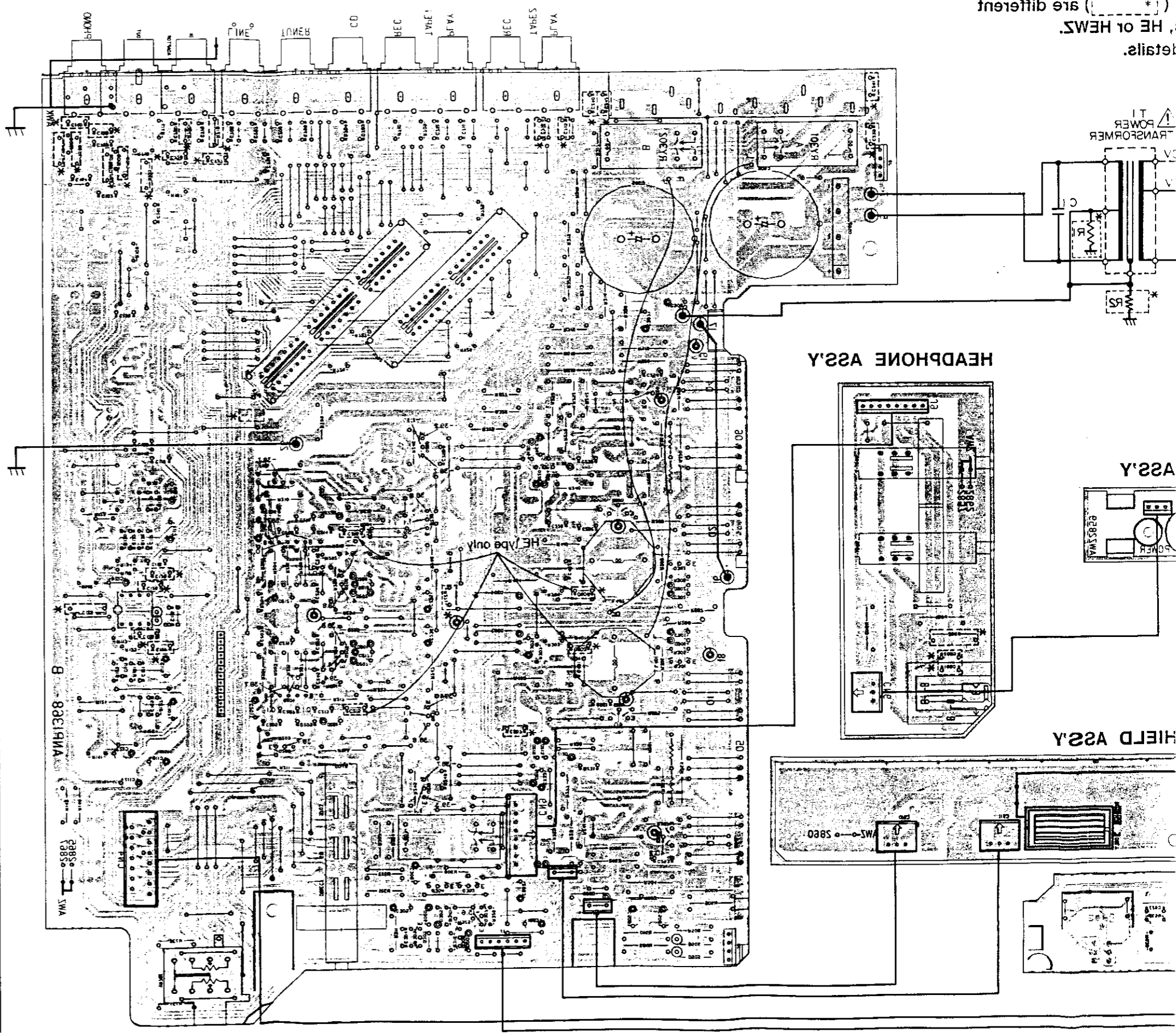

4.2 P.C. BOARDS CONNECTION DIAGRAM

- Parts with an asterisk (*) are different according to versions HE or HEWZ. Refer to page 26 for details.

AW32865 (HEWZ type)
AW32867 (HE type)
AF COMPLEX ASS'Y

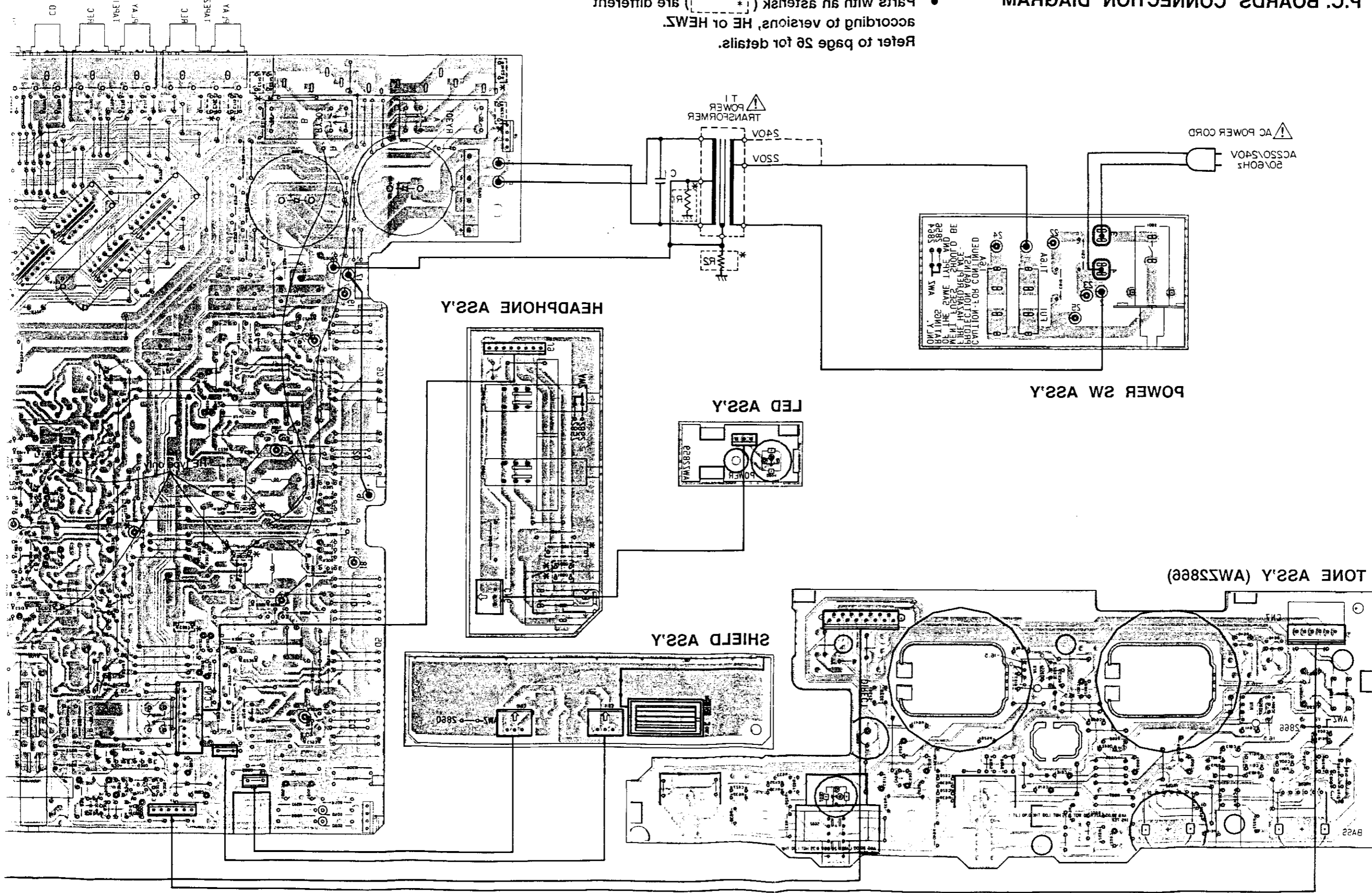

A
B
C
D

6

2

4

3

5

1

6

2

4

3

5

1

4.3 P.C.B's PARTS LIST

NOTES:

- Parts without part number cannot be supplied.
- Parts marked by "⊗" are not always kept in stock. Their delivery time may be longer than usual or they may be unavailable.
- The Δ mark found on some component parts indicates the importance of the safety factor of the part. Therefore, when replacing, be sure to use parts of identical designation.
- When ordering resistors, first convert resistance values into code form as shown in the following examples.

Ex. 1 When there are 2 effective digits (any digit apart from 0), such as 560 ohm and 47k ohm (tolerance is shown by J = 5%, and K = 10%).

560Ω	56 × 10 ¹	561.....	RD14PS ⊗ ⊗ ⊗ J
47kΩ	47 × 10 ³	473.....	RD14PS ⊗ ⊗ ⊗ J
0.5Ω	0R5.....		RN2H ⊗ ⊗ ⊗ K
1Ω	010.....		RS1P ⊗ ⊗ ⊗ K

Ex. 2 When there are 3 effective digits (such as in high precision metal film resistors).

5.62kΩ	562 × 10 ¹	5621.....	RN14SR ⊗ ⊗ ⊗ F
--------	-----------------------	-----------	----------------

Mark	No.	Description	Parts No.	Mark	No.	Description	Parts No.	
LED ASS'Y				C609,C610	CERAMIC CAPACITOR		CKDYX823M25	
SEMICONDUCTOR				C611,C612	CERAMIC CAPACITOR		CKCYB332K50	
D604 LED(RE D)				AEL1065	C613,C614	CERAMIC CAPACITOR	CKDYX183M25	
SHIELD ASS'Y				C615,C616	ELECTR. CAPACITOR		CEAS2R2M50	
No parts supplied with the SHIELD Ass'y.				C617,C618	ELECTR. CAPACITOR		CEAS100M25	
HEADPHONE ASS'Y				C619,C620	CERAMIC CAPACITOR		CCDSL390J50	
RESISTORS				C625,C626	CERAMIC CAPACITOR		CKDYX104M25	
Δ R801,R802	METAL OXIDE RESISTOR	RS1PMF331J	C627,C628	CERAMIC CAPACITOR		CKDYX823M25		
Δ R803	METAL OXIDE RESISTOR	RS1LMF561J	C629,C630	ELECTR. CAPACITOR		CEAS470M25		
SWITCH				C631,C632	ELECTR. CAPACITOR		CEAS221M16	
S801	PUSH SWITCH	SUL5L2B2S	C641,C642	CERAMIC CAPACITOR		CCCSL470J50		
OTHERS				C645,C646	CERAMIC CAPACITOR		CKCYB102K50	
JACK		AKN1002	RESISTORS		VR603,VR604	VARIABLE(100K-20AX2)	ACT1045	
CN6	JUMPER CONNECTOR 3-P	KPC3	R651,R652	CARBON FILM RESISTOR		RD14PM101J		
POWER SW ASS'Y				OTHER RESISTORS		RD18PM□□□□J		
CAPACITORS				SWITCH		S602	PUSH SWITCH	ASG1019
Δ C510,C511	CKA (0.01/AC400V)	ACG1002	AF COMPLEX ASS'Y (AWZ2867)					
SWITCH				SEMICONDUCTORS				
Δ S501	PUSH SWITCH	ASG1035	IC101	OP-AMP IC		M5220P		
TONE ASS'Y (AWZ2866)				Q201,Q202	TRANSISTOR		2SA979	
SEMICONDUCTORS				Q203,Q204	TRANSISTOR		2SC2458	
IC601,IC602	OP-AMP IC	NJM4558DXP	Q205,Q206	TRANSISTOR		2SA1048		
D505,D506	DIODE	11E2	Q219,Q220	TRANSISTOR		2SC2705		
D602	LED(RE D)	AEL1065	Q221,Q222	TRANSISTOR		2SC3298		
D603	LED	AEL1084	Q223,Q224	TRANSISTOR		2SA1306		
CAPACITORS				Q231,Q232	TRANSISTOR		2SA1145	
C601,C602	ELECTR. CAPACITOR	CEAS010M50	Q301,Q302	TRANSISTOR		2SC1845		
C605,C606	ELECTR. CAPACITOR	CEAS2R2M50	Q303,Q304	TRANSISTOR		2SC2458		
C607,C608	CERAMIC CAPACITOR	CKDYX153M25	Q305	TRANSISTOR		2SA1048		
				Q306	TRANSISTOR		2SC1815	
				Q307	TRANSISTOR		2SC2458	
				D201,D202	DIODE		1SS252	
				D207,D208	DIODE		1SS252	

Mark No.	Description	Parts No.
D213-D216	DIODE	1SS252
D217-D220	ZENER DIODE	RD8.2ESB1
D221,D222	DIODE	1SS252
D301-D306	DIODE	1SS252
D307	ZENER DIODE	RD15ESB
D503	ZENER DIODE	RD16ESB3
D504	ZENER DIODE	RD16ESB3
D507	DIODE	D5SB20F
COILS & FILTERS		
L401,L402	COIL	ATH1004
CAPACITORS		
C103,C104	CERAMIC CAPACITOR	CCCSL221J50
C107,C108	ELECTR. CAPACITOR	CEAS101M10
C109,C110	AUDIO FILM CAPACITOR	CFTXA683J50
C111,C112	AUDIO FILM CAPACITOR	CFTXA183J50
C113,C114	ELECTR. CAPACITOR	CEAS4R7M50
C115,C116	MYLOR FILM CAPACITOR	CQMA472K50
C117,C118	ELECTR. CAPACITOR	CEAS221M25
C119,C120	CERAMIC CAPACITOR	CKCYF103Z50
C121,C122	MYLOR FILM CAPACITOR	CQMA122J50
C123,C124	ELECTR. CAPACITOR	CEAS100M50
C201,C202	ELECTR. CAPACITOR	CEEA2R2M50
C203-C206	CERAMIC CAPACITOR	CCCSL101J50
C207,C208	CERAMIC CAPACITOR	CCCSL470J50
C209,C210	CERAMIC CAPACITOR	CKCYB331K50
C211,C212	ELECTR. CAPACITOR	CEEA221M16
C213-C216	CERAMIC CAPACITOR	CCCSL150K500
C217,C218	ELECTR. CAPACITOR	CEAS471M6
C231,C232	CERAMIC CAPACITOR	CKCYB122K50
C233,C234	ELECTR. CAPACITOR	CEAS100M50
C235,C236	CERAMIC CAPACITOR	CCCSL101J50
C249,C250	CERAMIC CAPACITOR	CCCSL050C500
C251-C254	CERAMIC CAPACITOR	CCCSL101K500
C255	CERAMIC CAPACITOR	CCCSL680J50
C256	CERAMIC CAPACITOR	CCDSL470J50
C301,C302	ELECTR. CAPACITOR	CEAS2R2M50
C303	ELECTR. CAPACITOR	CEAS471M6
C304	CERAMIC CAPACITOR	CKCYF103Z50
C305	ELECTR. CAPACITOR	CEAS101M25
C306-C308	ELECTR. CAPACITOR	CEASR47M50
C401-C404	AUDIO FILM CAPACITOR	CFTXA104J50
C501,C502	ELECTR. CAPACITOR	CEAS470M25
C505,C506	ELECTR. CAPACITOR (6800/42V)	ACH1077
C508	ELECTR. CAPACITOR	CEAS470M50
C509	ELECTR. CAPACITOR	CEAS220M50
C719,C720	CERAMIC CAPACITOR	CKCYB331K50
C725	CERAMIC CAPACITOR	CKCYF103Z50
C731	CERAMIC CAPACITOR	CKCYF103Z50

Mark No.	Description	Parts No.
RESISTORS		
VR701	VARIABLE(100K-20AX2)	ACT1062
R105,R106	CARBON FILM RESISTOR	RDR1/6PU100J
R121,R122	CARBON FILM RESISTOR	RDR1/4PM820J
R133,R134	CARBON FILM RESISTOR	RDR1/6PU471J
R141,R142	CARBON FILM RESISTOR	RDR1/6PU563J
R143,R144	CARBON FILM RESISTOR	RD1/4PM560J
R201-R204	CARBON FILM RESISTOR	RDR1/4PM□□□J
△ R205,R206	CARBON FILM RESISTOR	RD1/4PMF331J
R207-R214	CARBON FILM RESISTOR	RD1/4PM□□□J
R215-R218	CARBON FILM RESISTOR	RDR1/4PM□□□J
△ R239-R242	FUSIBLE RESISTOR	RFA1/4PS101J
△ R245,R246	FUSIBLE RESISTOR	RFA1/4PS101J
△ R247,R248	CARBON FILM RESISTOR	RD1/4PMF680J
R251,R252	METALFILM RESISTOR	RN1/4PQ1501F
△ R261-R264	CARBON FILM RESISTOR	RD1/4PMF101J
△ R265-R268	FUSIBLE RESISTOR	RFA1/4PS4R7J
△ R269,R270	RESISTOR (0.33, 5W)	ACN1063
R273,R274	CARBON FILM RESISTOR	RD1/4PM271J
R277-R280	CARBON FILM RESISTOR	RD1/4PM□□□J
△ R287,R288	CARBON FILM RESISTOR	RD1/4PMF010J
R299	CARBON FILM RESISTOR	RD1/4PM100J
△ R301,R302	CARBON FILM RESISTOR	RD1/4PMF222J
△ R308	CARBON FILM RESISTOR	RD1/4PMF101J
R311-R315	CARBON FILM RESISTOR	RD1/4PM□□□J
R317-R327	CARBON FILM RESISTOR	RD1/4PM□□□J
△ R330	CARBON FILM RESISTOR	RD1/4PMF010J
△ R401,R402	CARBON FILM RESISTOR	RD1/4PMFL100J
△ R403,R404	METAL OXIDE RESISTOR	RS1LMF331J
△ R407,R408	CARBON FILM RESISTOR	RD1/4PMFL100J
R501-R506	CARBON FILM RESISTOR	RD1/2PM181J
△ R508	CARBON FILM RESISTOR	RD1/4PMF010J
△ R509,R510	METAL OXIDE RESISTOR	RS1LMF222J
R517-R520	CARBON FILM RESISTOR	RD1/2PM181J
R731,R732	CARBON FILM RESISTOR	RD1/4PM103J
OTHER RESISTORS		RD1/8PM□□□J
SWITCHES		
S701	SWITCH	ASU1016
S702	SWITCH	ASU1002
S703	PUSH SWITCH	SULL6S
OTHERS		
CN4	JUMPER CONNECTOR	KPE15
CN9	JUMPER CONNECTOR	KPC8
RY301-RY303	RELAY	ASR-111
	PHONO JACK 6-P	AKB1007
	PHONO JACK 6-P	AKB1008
	PHONO JACK 6-P	AKB1024
	SPEAKER TERMINAL 8-P	AKE1011

5. FOR A-447/HEWZ AND A-447-S/HEWZ TYPES

NOTES:

- Parts without part number cannot be supplied.
- The △ mark found on some component parts indicates the importance of the safety factor of the part. Therefore, when replacing, be sure to use parts of identical designation.
- Parts marked by "⊗" are not always kept in stock. Their delivery time may be longer than usual or they may be unavailable.

5.1 Contrast of Miscellaneous Parts

The A-447/HEWZ and A-447-S/HEWZ types are the same as the A-447/HE type with the exception of the following sections.

Mark	Symbol & Description	Parts No.			Remarks
		A-447/HE type	A-447/HEWZ type	A-447-S/HEWZ type	
	AF COMPLEX ASS'Y	AWZ2861	AWZ2855	AWZ2855	
	HEADPHONE ASS'Y	Non supply	Non supply	Non supply	
	POWER SW ASS'Y	Non supply	Non supply	Non supply	
	ROTARY KNOB S (PLS)	AAB1155	AAB1155	AAB1156	
	ROTARY KNOB L (PLS)	AAB1160	AAB1160	AAB1161	
	ROTARY KNOB R (PLS)	AAB1162	AAB1162	AAB1163	
	ROTARY KNOB M (PLS)	AAB1164	AAB1164	AAB1165	
	PUSH KNOB C	AAD1366	AAD1366	AAD1367	
	KNOB (POWER)	AAD1535	AAD1535	AAD1537	
	PUSH KNOB	AAD1536	AAD1536	AAD1538	
	PUSH KNOB C	AAD1803	AAD1803	AAD1804	
	SCREW	BBT30P060FZK	BBT30P060FZK	ABA-274	
	PACKING CASE	AHD1861	AHD1861	AHD1862	
	PANEL BASE (PLS)	AMB1651	AMB1651	AMB1652	
	FRONT PANEL	AMB1395	AMB1395	AMB1396	
	BONNET CASE	AZN1799	AZN1799	AZN1800	
	OPERATING INSTRUCTIONS	ARE1162	-----	-----	
	OPERATING INSTRUCTIONS	-----	ARC1213	ARC1213	
	R1, R2	-----	RD1/4PM100J	RD1/4PM100J	

5.2 P.C.B's PARTS LIST

NOTES:

- Parts without part number cannot be supplied.
- Parts marked by "⊙" are not always kept in stock. Their delivery time may be longer than usual or they may be unavailable.
- The Δ mark found on some component parts indicates the importance of the safety factor of the part. Therefore, when replacing, be sure to use parts of identical designation.
- When ordering resistors, first convert resistance values into code form as shown in the following examples.

Ex. 1 When there are 2 effective digits (any digit apart from 0), such as 560 ohm and 47k ohm (tolerance is shown by J = 5%, and K = 10%).

560Ω	56 × 10 ¹	561.....	RD14PS ⊙ ⊙ ⊙ J
47kΩ	47 × 10 ³	473.....	RD14PS ⊙ ⊙ ⊙ J
0.5Ω	0R5.....		RN2H ⊙ ⊙ ⊙ K
1Ω	010.....		RS1P ⊙ ⊙ ⊙ K

Ex. 2 When there are 3 effective digits (such as in high precision metal film resistors).

5.62kΩ	562 × 10 ¹	5621.....	RN14SR ⊙ ⊙ ⊙ F
--------	-----------------------	-----------	----------------

Mark	No.	Description	Parts No.	Mark	No.	Description	Parts No.
POWER SW ASS'Y							
CAPACITORS							
Δ	C510,C511	CKA (0.01/AC400V)	ACG1002				
SWITCH							
Δ	S501	PUSH SWITCH	ASG1035				
HEADPHONE ASS'Y							
CAPACITORS							
	C801,C802	CERAMIC CAPACITOR	CKCYB392K50				
RESISTORS							
Δ	R801,R802	METAL OXIDE RESISTOR	RS1PMF331J				
Δ	R803	METAL OXIDE RESISTOR	RS1LMF681J				
SWITCH							
	S801	PUSH SWITCH	SUL5L2B2S				
OTHERS							
	CN6	JUMPER CONNECTOR 3-P JACK	KPC3 AKN1002				
AF COMPLEX ASS'Y (AWZ2855)							
SEMICONDUCTORS							
	IC101	IC	UPC4570C				
	Q101-Q104	N-FET	25K369				
	Q105,Q106	TRANSISTOR	25C2458				
	Q201,Q202	TRANSISTOR	25A979				
	Q203-Q208	TRANSISTOR	25A1048				
	Q211,Q212	TRANSISTOR	25C1845				
	Q215-Q218	TRANSISTOR	25A1048				
	Q219,Q220	TRANSISTOR	25C2705				
	Q221,Q222	TRANSISTOR	25C3298				
	Q223,Q224	TRANSISTOR	25A1306				
	Q225,Q226	TRANSISTOR	25C2603				
	Q227,Q228	TRANSISTOR	25C1845				
	Q229,Q230	TRANSISTOR	25A992				
	Q231,Q232	TRANSISTOR	25A1145				
	Q233,Q234	TRANSISTOR	25A992				

Mark	No.	Description	Parts No.	Mark	No.	Description	Parts No.
	C139,C140	CERAMIC CAPACITOR	CCCSL330J50		R219-R234	CARBON FILM RESISTOR	RD14PM ⊙ ⊙ ⊙ J
	C141	CERAMIC CAPACITOR	CKCYF103Z50		R237,R238	CARBON FILM RESISTOR	RDR14PM224J
	C201,C202	ELECTR. CAPACITOR	CEEA2R2M50	Δ	R239-R242	FUSIBLE RESISTOR	RFA14PS101J
	C203,C204	CERAMIC CAPACITOR	CCCSL101K500	Δ	R243,R244	CARBON FILM RESISTOR	RD14PMF561J
	C205,C206	CERAMIC CAPACITOR	CCCSL101J50	Δ	R245-R248	FUSIBLE RESISTOR	RFA14PS101J
	C207,C208	CERAMIC CAPACITOR	CCCSL470J50		R249-R252	CARBON FILM RESISTOR	RD14PM ⊙ ⊙ ⊙ J
	C209,C210	CERAMIC CAPACITOR	CCCSL221J50		R255,R256	CARBON FILM RESISTOR	RD14PM561J
	C211,C212	ELECTR. CAPACITOR	CEEA221M16	Δ	R257-R260	FUSIBLE RESISTOR	RFA14PS101J
	C213,C214	CERAMIC CAPACITOR	CCCSL080D500	Δ	R261-R268	FUSIBLE RESISTOR	RFA14PS470J
	C217,C218	ELECTR. CAPACITOR	CEAS101M10	Δ	R269,R270	RESISTOR (0.33, 5W)	ACN1063
	C219-C222	ELECTR. CAPACITOR	CEAS3R3M100		R275-R278	CARBON FILM RESISTOR	RD14PM ⊙ ⊙ ⊙ J
	C225,C226	ELECTR. CAPACITOR	CEAS331M10	Δ	R281-R284	FUSIBLE RESISTOR	RFA14PS331J
	C227-C230	CERAMIC CAPACITOR	CCCSL330K500	Δ	R285,R286	FUSIBLE RESISTOR	RFA14PS101J
	C231,C232	CERAMIC CAPACITOR	CKCYB122K50	Δ	R287,R288	CARBON FILM RESISTOR	RD14PMF4R7J
	C233-C236	ELECTR. CAPACITOR	CEAS100M50	Δ	R289,R290	FUSIBLE RESISTOR	RFA14PS101J
	C237,C238	ELECTR. CAPACITOR	CEAS101M50		R299	CARBON FILM RESISTOR	RD14PM100J
	C239-C242	POLYESTER CAPACITOR	COMXA472J100	Δ	R301,R302	CARBON FILM RESISTOR	RD14PMF222J
	C244	CERAMIC CAPACITOR	CKDYX104M25	Δ	R308	CARBON FILM RESISTOR	RD14PMF101J
	C245,C246	CERAMIC CAPACITOR	CKCYB331K50		R311-R315	CARBON FILM RESISTOR	RD14PM ⊙ ⊙ ⊙ J
	C247,C248	AUDIO FILM CAPACITOR	CFTXA103J50		R317-R327	CARBON FILM RESISTOR	RD14PM ⊙ ⊙ ⊙ J
	C251-C254	CERAMIC CAPACITOR	CCCSL680K500	Δ	R330	CARBON FILM RESISTOR	RD14PMF010J
	C255	CERAMIC CAPACITOR	CCCSL680J50	Δ	R401,R402	CARBON FILM RESISTOR	RD14PMFL101J
	C256	CERAMIC CAPACITOR	CCDSL470J50	Δ	R403,R404	METAL OXIDE RESISTOR	RS1LMF331J
	C301,C302	ELECTR. CAPACITOR	CEAS2R2M50	Δ	R407,R408	CARBON FILM RESISTOR	RD14PMFL100J
	C303	ELECTR. CAPACITOR	CEAS471M6	Δ	R501-R507	METAL OXIDE RESISTOR	RS1PMF121J
	C304	CERAMIC CAPACITOR	CKCYF103Z50	Δ	R507,R508	CARBON FILM RESISTOR	RD14PMF010J
	C305	ELECTR. CAPACITOR	CEAS101M25	Δ	R509,R510	METAL OXIDE RESISTOR	RS1LMF272J
	C306-C308	ELECTR. CAPACITOR	CEASR47M50		R513-R516	CARBON FILM RESISTOR	RD14PM272J
	C401,C402	AUDIO FILM CAPACITOR	CFTXA473J50	Δ	R517-R520	METAL OXIDE RESISTOR	RS1PMF101J
	C501,C502	ELECTR. CAPACITOR	CEAS100M50		R731,R732	CARBON FILM RESISTOR	RD14PM103J
	C503,C504	ELECTR. CAPACITOR	CEAS470M25		OTHER RESISTORS	RD18PM ⊙ ⊙ ⊙ J	
	C505,C506	ELECTR. CAPACITOR (16000/5V)	ACH1078		SWITCHES		
	C508	ELECTR. CAPACITOR	CEAS470M50		S101	PUSH SWITCH	ASG1012
	C509	ELECTR. CAPACITOR	CEAS010M50		S701	SWITCH	ASU1016
	C703-C708	CERAMIC CAPACITOR	CCCSL271J50		S702	SWITCH	ASU1002
	C711,C712	CERAMIC CAPACITOR	CCCSL271J50		S703	PUSH SWITCH	SULL6S
	C715,C716	CERAMIC CAPACITOR	CCCSL271J50		OTHERS		
	C725	CERAMIC CAPACITOR	CCDSL221J50		CN4	JUMPER CONNECTOR	KPE15
	C726	CERAMIC CAPACITOR	CKCYF103Z50		CN9	JUMPER CONNECTOR	KPC8
	C727,C728	CERAMIC CAPACITOR	CCCSL221J50		RY301,RY302	RELAY	ASR-112
	C731	CERAMIC CAPACITOR	CKCYF103Z50		RY303	RELAY	ASR-111
	C733,C734	CERAMIC CAPACITOR	CKDYF102Z50			PHONO JACK 6-P	AKB1007
						PHONO JACK 6-P	AKB1008
						PHONO JACK 6-P	AKB1024
						SPEAKER TERMINAL 8-P	AKE1011
RESISTORS							
	VR201,VR202	VR(47K)	ACP1045				
	VR701	VARIABLE(100K-20AX2)	ACT1062				
	R101,R102	CARBON FILM RESISTOR	RDR16PU101J				
	R107,R108	CARBON FILM RESISTOR	RDR16PU563J				
	R119-R121	CARBON FILM RESISTOR	RDR14PM ⊙ ⊙ ⊙ J				
	R133,R134	CARBON FILM RESISTOR	RDR16PU391J				
	R143,R144	CARBON FILM RESISTOR	RD14PM560J				
	R201-R204	CARBON FILM RESISTOR	RDR14PM ⊙ ⊙ ⊙ J				

6. FOR A-337/HEWZ AND A-337-S/HEWZ TYPES

NOTES:

- Parts without part number cannot be supplied.
- The Δ mark found on some component parts indicates the importance of the safety factor of the part. Therefore, when replacing, be sure to use parts of identical designation.
- Parts marked by "⊙" are not always kept in stock. Their delivery time may be longer than usual or they may be unavailable.

6.1 Contrast of Miscellaneous Parts

The A-337/HEWZ and A-337-S/HEWZ types are the same as the A-337/HE type with the exception of the following sections.

Mark	Symbol & Description	Parts No.			Remarks
		A-337/HE type	A-337/HEWZ type	A-337-S/HEWZ type	
	AF COMPLEX ASS'Y	AWZ2867	AWZ2865	AWZ2865	
	HEADPHONE ASS'Y	Non supply	Non supply	Non supply	
	POWER SW ASS'Y	Non supply	Non supply	Non supply	
	ROTARY KNOB S (PLS)	AAB1155	AAB1155	AAB1156	
	ROTARY KNOB L (PLS)	AAB1160	AAB1160	AAB1161	
	ROTARY KNOB R (PLS)	AAB1162	AAB1162	AAB1163	
	ROTARY KNOB M (PLS)	AAB1166	AAB1164	AAB1167	
	PUSH KNOB C	AAD1366	AAD1366	AAD1367	
	KNOB (POWER)	AAD1535	AAD1535	AAD1537	
	PUSH KNOB	AAD1536	AAD1536	AAD1538	
	PUSH KNOB C	AAD1803	AAD1803	AAD1804	
	SCREW	BBT30P060FZK	BBT30P060FZK	ABA-274	
	PACKING CASE	AHD1863	AHD1863	AHD1864	
	PANEL BASE (PLS)	AMB1651	AMB1651	AMB1652	
	FRONT PANEL	AMB1397	AMB1397	AMB1398	
	BONNET CASE	AZN1799	AZN1799	AZN1800	
	OPERATING INSTRUCTIONS	ARE1162	-----	-----	
	OPERATING INSTRUCTIONS	-----	ARC1213	ARC1213	
	R1, R2	-----	RD1/4PM100J	RD1/4PM100J	

6.2 P.C.B's PARTS LIST

NOTES:

- Parts without part number cannot be supplied.
- Parts marked by "⊙" are not always kept in stock. Their delivery time may be longer than usual or they may be unavailable.
- The Δ mark found on some component parts indicates the importance of the safety factor of the part. Therefore, when replacing, be sure to use parts of identical designation.
- When ordering resistors, first convert resistance values into code form as shown in the following examples.

Ex. 1 When there are 2 effective digits (any digit apart from 0), such as 560 ohm and 47k ohm (tolerance is shown by J = 5%, and K = 10%).

560Ω	56 × 10 ¹	561.....	RD1/4PS ⊙ ⊙ ⊙ J
47kΩ	47 × 10 ³	473.....	RD1/4PS ⊙ ⊙ ⊙ J
0.5Ω	0R5.....		RN2H ⊙ ⊙ ⊙ K
1Ω	010.....		RS1P ⊙ ⊙ ⊙ K

Ex. 2 When there are 3 effective digits (such as in high precision metal film resistors).

5.62kΩ	562 × 10 ¹	5621.....	RN1/4SR ⊙ ⊙ ⊙ F
--------	-----------------------	-----------	-----------------

Mark	No.	Description	Parts No.	Mark	No.	Description	Parts No.
		POWER SW ASS'Y				D213-D216 DIODE	1SS252
		CAPACITORS				D217-D220 ZENER DIODE	RD8.2ESB1
		Δ C510,C511 CKA (0.01/AC400V)	ACG1002			D221,D222 DIODE	1SS252
		SWITCH				D301-D306 DIODE	1SS252
		Δ S501 PUSH SWITCH	ASG1035			D307 ZENER DIODE	RD15ESB
		HEADPHONE ASS'Y				D503,D504 ZENER DIODE	RD16ESB3
		CAPACITORS				D507 DIODE	D5SB20F
		C801,C802 CERAMIC CAPACITOR	CKCYB392K50			COILS & FILTERS	
						L103-L106 AXIAL INDUCTOR	LAU221K
						L401,L402 COIL	ATH1009
		RESISTORS				CAPACITORS	
		Δ R801,R802 METAL OXIDE RESISTOR	RS1PMF331J			C103,C104 CERAMIC CAPACITOR	CCCSL330J50
		Δ R803 METAL OXIDE RESISTOR	RS1LMF561J			C107,C108 ELECTR. CAPACITOR	CEAS101M10
		SWITCH				C109,C110 AUDIO FILM CAPACITOR	CFTXA683J50
		S801 PUSH SWITCH	SUL5L2B2S			C111,C112 AUDIO FILM CAPACITOR	CFTXA183J50
		OTHERS				C113,C114 ELECTR. CAPACITOR	CEAS4R7M50
		CN6 JUMPER CONNECTOR 3-P JACK	KPC3 AKN1002			C115,C116 MYLOR FILM CAPACITOR	CQMA392K50
		AF COMPLEX ASS'Y (AWZ2865)				C117,C118 ELECTR. CAPACITOR	CEAS221M25
		SEMICONDUCTORS				C119,C120 CERAMIC CAPACITOR	CKCYF103Z50
		IC101 OP-AMP IC	M5220P			C121,C122 MYLOR FILM CAPACITOR	CQMA122J50
		Q201,Q202 TRANSISTOR	2SA979			C123,C124 ELECTR. CAPACITOR	CEAS100M50
		Q203,Q204 TRANSISTOR	2SC2458			C125,C126 CERAMIC CAPACITOR	CCCSL101J50
		Q205,Q206 TRANSISTOR	2SA1048			C127,C128 CERAMIC CAPACITOR	CCDSL221J50
		Q219,Q220 TRANSISTOR	2SC2705			C129 CERAMIC CAPACITOR	CKPYX103N25
						C139,C140 CERAMIC CAPACITOR	CCDSL330J50
						C141 CERAMIC CAPACITOR	CKCYF103Z50
		Q221,Q222 TRANSISTOR	2SC3298			C201,C202 ELECTR. CAPACITOR	CEEA2R2M50
		Q223,Q224 TRANSISTOR	2SA1306			C203,C206 CERAMIC CAPACITOR	CCCSL101J50
		Q231,Q232 TRANSISTOR	2SA1145			C207,C208 CERAMIC CAPACITOR	CCCSL470J50
		Q301,Q302 TRANSISTOR	2SC1845			C209,C210 CERAMIC CAPACITOR	CKCYB331K50
		Q303,Q304 TRANSISTOR	2SC2458			C211,C212 ELECTR. CAPACITOR	CEEA221M16
		Q305 TRANSISTOR	2SA1048			C213,C214 CERAMIC CAPACITOR	CCCSL080D500
		Q306 TRANSISTOR	2SC1815			C217,C218 ELECTR. CAPACITOR	CEAS471M6
		Q307 TRANSISTOR	2SC2458			C231,C232 CERAMIC CAPACITOR	CKCYB122K50
		D201,D202 DIODE	1SS252			C233,C234 ELECTR. CAPACITOR	CEAS100M50
		D207,D708 DIODE	1SS252			C235,C236 ELECTR. CAPACITOR	CEAS0R1M50

Mark No.	Description	Parts No.
C239,C242	POLYESTER CAPACITOR	COMXA472J100
C245,C246	CERAMIC CAPACITOR	CKCYB331K50
C249,C250	CERAMIC CAPACITOR	CCCSL050C500
C251-C254	CERAMIC CAPACITOR	CCCSL101K500
C255	CERAMIC CAPACITOR	CCCSL680J50
C256	CERAMIC CAPACITOR	CCDSL470J50
C257	CERAMIC CAPACITOR	CKCYF103Z50
C301,C302	ELECTR. CAPACITOR	CEAS2R2M50
C303	ELECTR. CAPACITOR	CEAS471M6
C304	CERAMIC CAPACITOR	CKCYF103Z50
C305	ELECTR. CAPACITOR	CEAS101M25
C306-C308	ELECTR. CAPACITOR	CEASR47M50
C401,C402	AUDIO FILM CAPACITOR	CFTXA473J50
C501,C502	ELECTR. CAPACITOR	CEAS470M25
C505,C506	ELECTR. CAPACITOR (6800/42V)	ACH1077
C508	ELECTR. CAPACITOR	CEAS470M50
C509	ELECTR. CAPACITOR	CEAS220M50
C703-C720	CERAMIC CAPACITOR	CCCSL271J50
C725-C728	CERAMIC CAPACITOR	CCDSL221J50
C731	CERAMIC CAPACITOR	CKCYF103Z50

Mark No.	Description	Parts No.
VR701	VARIABLE(100K-20AX2)	ACT1062
R121,R122	CARBON FILM RESISTOR	RDR1/4PM820J
R133,R134	CARBON FILM RESISTOR	RDR1/6PU471J
R141,R142	CARBON FILM RESISTOR	RDR1/6PU563J
R143,R144	CARBON FILM RESISTOR	RD1/4PM560J
R201-R204	CARBON FILM RESISTOR	RDR1/4PM□□□J
R205,R206	CARBON FILM RESISTOR	RD1/4PMF331J
R207-R214	CARBON FILM RESISTOR	RD1/4PM□□□J
R215-R218	CARBON FILM RESISTOR	RDR1/4PM□□□J
R239-R246	FUSIBLE RESISTOR	RFA1/4PS101J
R247,R248	CARBON FILM RESISTOR	RD1/4PMF680J
R251,R252	METALFILM RESISTOR	RN1/4PQ1501F
R261-R264	CARBON FILM RESISTOR	RD1/4PMF101J
R265-R268	FUSIBLE RESISTOR	RFA1/4PS4R7J
R269,R270	RESISTOR (0.33, 5W)	ACN1063
R273,R274	CARBON FILM RESISTOR	RD1/4PM271J
R277-R280	CARBON FILM RESISTOR	RD1/4PM□□□J
R287,R288	CARBON FILM RESISTOR	RD1/4PMF010J
R299	CARBON FILM RESISTOR	RD1/4PM100J
R301,R302	CARBON FILM RESISTOR	RD1/4PMF222J
R308	CARBON FILM RESISTOR	RD1/4PMF101J
R311-R315	CARBON FILM RESISTOR	RD1/4PM□□□J
R317-R327	CARBON FILM RESISTOR	RD1/4PM□□□J
R330	CARBON FILM RESISTOR	RD1/4PMF010J
R401,R402	CARBON FILM RESISTOR	RD1/4PMFL101J

Mark No.	Description	Parts No.
R403,R404	METAL OXIDE RESISTOR	RS1LMF331J
R407,R408	CARBON FILM RESISTOR	RD1/4PMFL100J
R501-R506	CARBON FILM RESISTOR	RD1/2PM181J
R508	CARBON FILM RESISTOR	RD1/4PMF010J
R509,R510	METAL OXIDE RESISTOR	RS1LMF222J
R517-R520	CARBON FILM RESISTOR	RD1/2PM181J
R731,R732	CARBON FILM RESISTOR	RD1/4PM103J
OTHER RESISTORS		RD1/8PM□□□J
SWITCHES		
S701	SWITCH	ASU1016
S702	SWITCH	ASU1002
S703	PUSH SWITCH	SULL6S
OTHERS		
CN4	JUNPER CONNECTOR	KPE15
CN9	JUNPER CONNECTOR	KPC8
RY301-RY303	RELAY	ASR-111
	PHONO JACK 4-P	AKB1007
	PHONO JACK 6-P	AKB1008
	PHONO JACK 6-P	AKB1024
	SPEAKER TERMINAL 8-P	AKE1011

7. PANEL FACILITIES

[FRONT PANEL]

The illustration shows model A-447. Model A-337 is not equipped ⑦, ⑧ and ⑩.

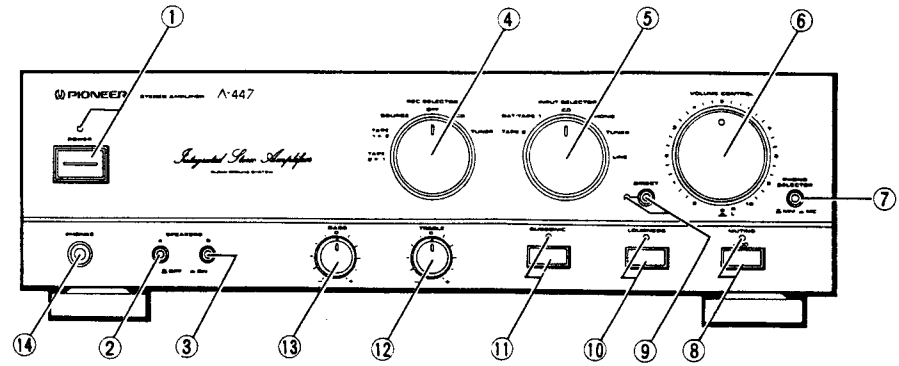

① POWER switch/indicator

Press to turn power to the unit ON and OFF. When the power is on, the indicator lights.

② SPEAKERS A selector switch

Use this switch to listen to the speaker systems connected to SPEAKERS A terminals.

ON (▲): Depressed position: Sound is heard from the speaker systems. OFF (■): Released position: No sound is heard from the speaker systems. Set to this position when listening with headphones.

③ SPEAKERS B selector switch

Use this switch to listen to the speaker systems connected to SPEAKERS B terminals.

ON (▲): Depressed position: Sound is heard from the speaker systems. OFF (■): Released position: No sound is heard from the speaker systems. Set to this position when listening with headphones.

④ REC SELECTOR switch

When this switch is set to a position other than SOURCE or OFF, the equipment selected by REC SELECTOR switch can be recorded from, irrespective of the settings of INPUT SELECTOR and DIRECT switches.

TUNER: To record from the equipment connected to TUNER terminals. CD: To record from the equipment connected to CD terminals. OFF: In this position, nothing from REC terminals of DAT/TAPE 1 and TAPE 2 is output. Set to this position when not recording; the cassette deck will be disconnected, improving sound quality. SOURCE: To record from the equipment selected by INPUT SELECTOR switch. TAPE: 1 ▶ 2: To record (copy) from the cassette deck of DAT/TAPE 1 terminals, to the cassette deck of TAPE 2 terminals. 2 ▶ 1: To record (copy) from the cassette deck of TAPE 2 terminals, to the cassette deck of DAT/TAPE 1 terminals.

⑤ INPUT SELECTOR switch

Use to select the playback source.

LINE:

For playback with a component connected to LINE terminal.

TUNER:

For AM or FM broadcast reception with a tuner.

PHONO:

For record playback with a turntable.

NOTE:

- With the A-337, you can use an MM cartridge or a high-output MC cartridge (over 1 mV).
- According to the type of cartridge used with the A-447, you can select MM or MC with the PHONO SELECTOR switch.

CD:

For compact disc playback with a CD player.

DAT/TAPE 1:

For playback with a cassette deck or digital audio tape deck connected to DAT/TAPE 1 terminals.

TAPE 2:

For playback with a cassette deck connected to TAPE 2 terminals.

⑥ VOLUME CONTROL

Use to adjust the volume level.

This volume knob consists of two volume controls. Because you can adjust L (left) and R (right) channel volume levels independently, it also functions as a balance control.

[Example]

To raise R (right) channel volume level, prevent the L knob from turning with one hand, and turn the R knob with the other hand.

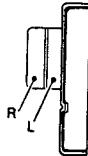

NOTE:

This unit is equipped with a circuit that attenuates LOUDNESS and TONE effect as volume is turned up.

⑦ PHONO SELECTOR switch (A-447 only)

Set in accordance with the type of cartridge used with your turntable.

MM (■):

Set to this position when using a moving magnet cartridge, or a moving coil cartridge with a high output of 1 mV or more.

MC (▲):

Set to this position when using a moving coil cartridge.

⑧ MUTING switch (A-447 only)

Use to temporarily cut sound volume.

on: The indicator lights.

The sound is cut off.

off: The indicator goes off.

The sound will return to its previous volume.

⑨ DIRECT switch/indicator

Use this switch/indicator when you do not wish to pass the output from input terminal equipment through the various frequency adjusting circuits (BASS, TREBLE, SUBSONIC, LOUDNESS) and adaptor terminals (ADAPTOR).

on:

The indicator lights: The signals input through the input terminals are reproduced without passing through the various frequency adjusting circuits. This results in flat, pure sound which is a more faithful reproduction of the input source.

off:

The indicator goes out: The signal passes through the various frequency adjusting circuits.

⑩ LOUDNESS switch/indicator

Use when listening at low volume levels.

on:

The indicator lights: Boosts low and high frequencies to give added punch to playback even at low volume levels.

off:

The indicator goes off: Should normally be left in this position.

NOTE:

This switch does not operate when DIRECT switch is in the on position.

⑪ SUBSONIC filter switch/indicator (A-447 only)

Use this switch when playing records with coarse grooves.

on:

The indicator lights: In this position, frequencies of 17 Hz and below are cut, eliminating super-low-frequency noise caused by coarse record grooves, and thus helping prevent sound distortion.

off:

The indicator goes off: Leave in this position for normal playback.

NOTE:

This switch does not operate when DIRECT switch is in the on position.

⑫ TREBLE tone control

Use to adjust the high-frequency tone. The center position is the flat (normal) position. When turned to the right, high-frequency tones are emphasized; when turned to the left, high-frequency tones are de-emphasized.

NOTE:

• This control does not operate when DIRECT switch is in the on position.

• At volume levels lower than "4", the set tone control effect is obtained.

• At volume levels higher than "4", the effect becomes increasingly weaker.

⑬ BASS tone control

Use to adjust the low-frequency tone. The center position is the flat (normal) position. When turned to the right, low-frequency tones are emphasized; when turned to the left, low-frequency tones are de-emphasized.

NOTE:

• This control does not operate when DIRECT switch is in the on position.

• At volume levels lower than "4", the set tone control effect is obtained.

• At volume levels higher than "4", the effect becomes increasingly weaker.

⑭ PHONES jack

When using headphones, insert the plug into this jack.

[REAR PANEL]

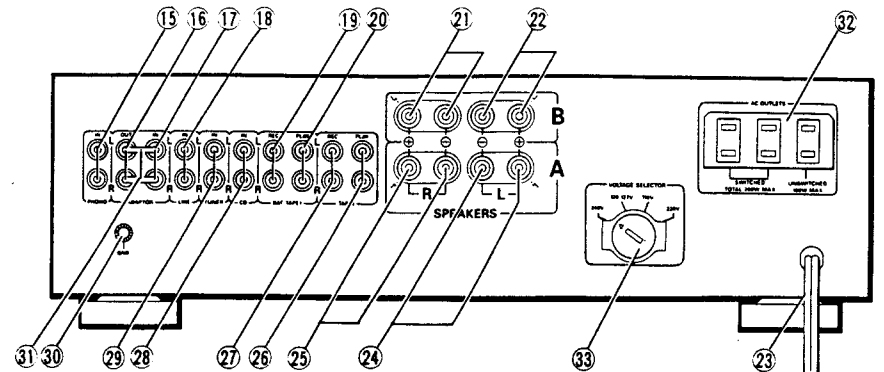

⑮ PHONO terminals

⑯ ADAPTOR OUT terminals

⑰ ADAPTOR IN terminals

⑱ LINE terminals

⑲ DAT/TAPE 1 REC terminals

⑳ DAT/TAPE 1 PLAY terminals

㉑ SPEAKERS B terminals (right channel)

㉒ SPEAKERS B terminals (left channel)

㉓ Power cord

Connect this cord to an AC wall socket, or the AC outlet of an audio timer.

㉔ SPEAKERS A terminals (left channel)

㉕ SPEAKERS A terminals (right channel)

㉖ TAPE 2 PLAY terminals

㉗ TAPE 2 REC terminals

㉘ CD terminals

㉙ TUNER terminals

㉚ Turntable ground terminal (GND)

㉛ Shorting bars

㉜ AC OUTLETS

㉝ VOLTAGE SELECTOR (multi-voltage models)

8. SPECIFICATIONS

[A-447]

Amplifier Section

Continuously Average Power Output is 60 Watts per channel, min., at 8 ohms from 20 Hertz to 20,000 Hertz, with no more than 0.009% total harmonic distortion.

Continuous power output (both channels driven at 20 Hz to 20 kHz)**	
T.H.D. 0.009 %, 8 Ω	60 W + 60 W*
T.H.D. 0.02 %, 4 Ω	80 W + 80 W*
Dynamic power output (on EIA dynamic test signal)	
8 Ω/4 Ω/2 Ω	75 W/110 W/150 W
Total harmonic distortion **	
20 Hz to 20 kHz, 60 W, 8 Ω	0.009 %*
20 Hz to 20 kHz, 80 W, 4 Ω	0.02 %*
Input sensitivity/impedance	
PHONO (MM)	2.5 mV/50 kΩ
PHONO (MC)	0.2 mV/100 Ω
CD, TUNER, LINE, TAPE	150 mV/40 kΩ
PHONO overload level	
1 kHz, T.H.D. 0.008 % (MM/MC)	150 mV/12 mV
Output level/impedance	
TAPE REC, ADAPTOR OUTPUT	150 mV/2.2 kΩ
Frequency response	
PHONO (MM)	20 Hz to 20 kHz ± 0.3 dB
PHONO (MC)	20 Hz to 20 kHz ± 0.5 dB
CD, TUNER, LINE, TAPE	5 Hz to 100 kHz ± 1/2 dB*
Tone control (volume control set at -30 dB position)	
BASS	± 8 dB (100 Hz)
TREBLE	± 8 dB (10 kHz)
Loudness contour (volume control set at -30 dB position)	
	+ 5 dB (100 Hz)/+ 3 dB (10 kHz)
Filter (SUBSONIC)	
	17 Hz (12 dB/oct.)
Signal-to-Noise ratio (IHF short circuit, A network)	
PHONO (MM, 5 mV input/MC, 0.5 mV input)	93 dB/74 dB*
CD, TUNER, LINE, TAPE	108 dB*
Muting	-∞

Power Supply/Miscellaneous

Power requirements

Canadian model	AC 120 V, 60 Hz
Other destination models	AC 110 V/120-127 V/220 V, 240 V (Switchable), 50/60 Hz

Power Construction

Canadian model	430 VA (CSA)
Other destination models	550 W

AC outlets

switched (x 2)	200 W
unswitched (x 1)	100 W

Dimensions 420 (W) x 352 (D) x 126 (H) mm

16-9/16 (W) x 13-7/8 (D) x 5 (H) in

Weight (without package) 8.1 kg (17 lb 14 oz)

Accessories

Operating instructions	1
------------------------	---

NOTE:

Specifications and design subject to possible modification without notice, due to improvements.

* Measured with DIRECT switch set to on.

** Measured by Audio Spectrum Analyzer.

[A-337]

Amplifier Section

Continuous Average Power Output is 40 watts*** per channel, min., at 8 ohms from 20 Hertz to 20,000 Hertz, with no more than 0.02 % total harmonic distortion.

Continuous power output (both channels driven at 20 Hz to 20 kHz)**	
T.H.D. 0.02 %, 8 Ω	40 W + 40 W*
T.H.D. 0.02 %, 4 Ω	50 W + 50 W*
Dynamic power output (on EIA dynamic test signal)	
8 Ω/4 Ω/2 Ω	55 W/90 W/100 W
Total harmonic distortion **	
20 Hz to 20 kHz, 40 W, 8 Ω	0.02 %*
20 Hz to 20 kHz, 50 W, 8 Ω	0.03 %*
Input sensitivity/impedance	
PHONO (MM)	2.5 mV/50 kΩ
CD, TUNER, LINE, TAPE	150 mV/40 kΩ
PHONO overload level	
1 kHz, T.H.D. 0.02 % (MM)	150 mV
Output level/impedance	
TAPE REC, ADAPTOR OUTPUT	150 mV/2.2 kΩ
Frequency response	
PHONO (MM)	20 Hz to 20 kHz ± 0.3 dB
CD, TUNER, LINE, TAPE	5 Hz to 100 kHz ± 1/2 dB*
Tone control (volume control set at -30 dB position)	
BASS	± 8 dB (100 Hz)
TREBLE	± 8 dB (10 kHz)
Loudness contour (volume control set at -30 dB position)	
	+ 5 dB (100 Hz)/+ 3 dB (10 kHz)
Signal-to-Noise ratio (IHF short circuit, A network)	
PHONO (MM, 5 mV input)	89 dB*
CD, TUNER, LINE, TAPE	108 dB*

Power Supply/Miscellaneous

Power requirements

U.S., Canadian models	AC 120 V, 60 Hz
Other destination models	AC 110 V/120-127 V/220 V, 240 V (Switchable), 50/60 Hz

Power Construction

U.S., Canadian model	260 W (UL), 330 VA (CSA)
Other destination models	410 W

AC outlets

switched (x 2)	200 W
unswitched (x 1)	100 W

Dimensions 420 (W) x 352 (D) x 126 (H) mm

16-9/16 (W) x 13-7/8 (D) x 5 (H) in

Weight (without package) 6.9 kg (15 lb 3 oz)

Accessories

Operating instructions	1
------------------------	---

NOTE:

Specifications and design subject to possible modification without notice, due to improvements.

* Measured with DIRECT switch set to on.

** Measured by Audio Spectrum Analyzer.

*** Measured pursuant to the Federal Trade Commission's Trade Regulation rules on Power Output Claims for Amplifiers.