

Service Manual

PIONEER®
The future of sound and vision.

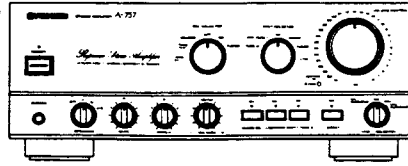

ORDER NO.
ARP1816

STEREO AMPLIFIER

A-757

MODEL A-757 HAS FIVE VERSIONS:

Type	Power requirement	Export destination
HEZ	AC220V,240V (switchable)	West Germany
HE	AC220V,240V (switchable)	European continent
HB	AC220V,240V (switchable)	United Kingdom
KUC	AC120V only	U.S.A. and Canada
SD	AC110V,120V-127V,220V,240V (switchable)	U.S.Military

- This manual is applicable to the A-757/HEZ and HE types.
- For the HE type, refer to page 21 – 32.
- For the other types, refer to additional service manual.

CONTENTS

1. EXPLODED VIEWS AND PARTS LIST	2	5. FOR HE TYPE	21
2. SCHEMATIC DIAGRAM	6	6. SPECIFICATIONS	33
3. P.C. BOARDS CONNECTION DIAGRAM	9	7. PANEL FACILITIES	34
4. ELECTRICAL PARTS LIST	17		

PIONEER ELECTRONIC CORPORATION 4-1, Meguro 1-Chome, Meguro-ku, Tokyo 153, Japan
PIONEER ELECTRONICS SERVICE INC. P.O. Box 1760, Long Beach, California 90801 U.S.A.
PIONEER ELECTRONICS OF CANADA, INC. 505 Cochrane Drive, Markham, Ontario L3R 8E3 Canada
PIONEER ELECTRONIC [EUROPE] N.V. Keetberglaan 1, 2740 Beveren, Belgium
PIONEER ELECTRONICS AUSTRALIA PTY. LTD. 178-184 Boundary Road, Braeside, Victoria 3195, Australia TEL: [03] 580-9911
 © **PIONEER ELECTRONIC CORPORATION 1989**

YA MAY 1989 Printed in Japan.

1. EXPLODED VIEWS AND PARTS LIST

NOTES:

- Parts without part number cannot be supplied.
- The Δ mark found on some component parts indicates the importance of the safety factor of the part. Therefore, when replacing, be sure to use parts of identical designation.
- Parts marked by "⊙" are not always kept in stock. Their delivery time may be longer than usual or they may be unavailable.

Mark	No.	Part No.	Description	Mark	No.	Part No.	Description
Δ	1	2SA1265N	TRANSISTOR Q 3	56	AAD1560	DIRECT KNOB	
Δ	2	2SA1265N	TRANSISTOR Q 4	57	AAD1561	POWER KNOB	
Δ	3	2SA1265N	TRANSISTOR Q 5	58	
Δ	4	2SA1265N	TRANSISTOR Q 6	59	ARC1146	OPERATING INSTRUCTIONS	
Δ	5	2SC3182N	TRANSISTOR Q 1	60	AEA1010	SPACER SET	
Δ	6	2SC3182N	TRANSISTOR Q 2	61	AHA1070	STYROL PROTECTOR	
Δ	7	2SC3182N	TRANSISTOR Q 7	62	AHD1632	PACKING CASE	
Δ	8	2SC3182N	TRANSISTOR Q 8	63	ANE1075	METAL BONNET	
	9	RD1/4PM100J	CARBON FILM RESISTOR	64	
	10	RD1/4PM4R7J	CARBON FILM RESISTOR	65		SPEAKER SWITCH	
Δ	11	ACH1045	ELECTROLYTIC CAPACITOR	66	AWZ2345	tone AMP	
Δ	12	ATS1087	POWER TRANSFORMER T 1	67		REC OUT	
Δ	13	ATS1088	POWER TRANSFORMER T 2	68	AWZ2347	INPUT SELECTOR	
Δ	14	ASG-553	PUSH SWITCH S 1	69			
	15	ASU1024	SWITCH S 3	70	AWZ2330	POWER AMP	
	16	ASU1025	SWITCH S 2	71	AWZ2331	POWER SUPPLY	
	17	ASU1026	SWITCH S 4	72	AWZ2332	SPEAKER TERM	
	18	AKM1019	JUMPER PLUG	73	AWZ2333	PHONO AMP	
Δ	19	AEK-400	FUSE(T4A)FU 1	74		HEAD PHONE	
Δ	20	ADG1049	AC POWER CORD	75		SHIELD	
	21	ANL 1024	LONG SHAFT ASSY	76		TERMINAL SCREW	
	22	AMR1158	FOOT	77		EARTH LEAD	
	23	AMR1159	FOOT	78		TRANS FRAME	
	24	ABE1009	WASHER	79		RIGHT FRAME	
	25	ABF1017	WASHER	80		REAR PANEL	
	26	ABH1034	SPRING	81		PANEL STAY	
	27	ABH1056	SPRING	82		BOTTOM PLATE	
	28	AEC-818	MICA SHEET	83		HEAT SINK	
	29	AEC-882	STRAIN RELIEF	84		HEAT SINK	
	30	AEH1005	ADHESIVE TAPE	85		HEAT SINK HOLDER	
	31	ABA-298	SCREW	86		VOLUME HOLDER	
	32	ABA1004	SCREW (STEEL)	87		SHIELD CASE(SP)	
	33	ABA1009	SCREW (STEEL)	88		SHIELD CASE B	
	34	ABA1011	SCREW (STEEL)	89		SHIELD PLATE	
	35	ABA1034	SCREW	90		CUSHION RUBBER C	
	36	ABA1047	SCREW (STEEL)	91		CUSHION SPACER	
	37	ABA1048	SCREW (STEEL)	92		CUSHION RUBBER	
	38	ABA1050	SCREW (STEEL)	93		
	39	ABA1082	SCREW	94		PCB HOLDER	
	40	ABA1088	SCREW	95		NYLON RIVET	
	41	ABN-048	FLANGE NUT M9	96		SPACER	
	42	ABN-065	NUT	97		SPACER	
	43	BBZ40P080FZK	SCREW	98		BINDER	
	44	NK90FCU	NUT	99		CLAMPER	
	45	VMZ30P060FCU	SCREW	100		
	46	AMR1178	HOLDER	101			
	47	ANB1294	FRONT PANEL	102		PUSH JOINT	
	48	AMB1200	BASE	103			
	49	AAM1029	NAME PLATE (METAL)	104		SHEET	
	50	AMR1160	INDICATING LENS				
	51	AAB1107	ROTARY KNOB L				
	52	AAB1108	ROTARY KNOB M				
	53	AAB1109	ROTARY KNOB S				
	54	AAD1016	KNOB (PLASTIC)				
	55	AAD1536	PUSH KNOB				

1

2

3

4

5

6

A

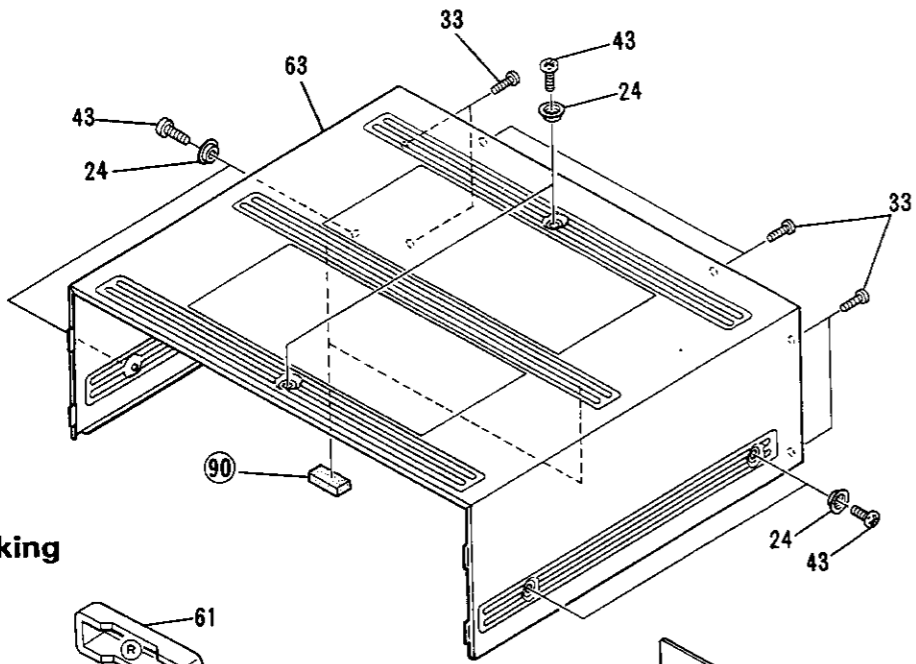

B

Packing

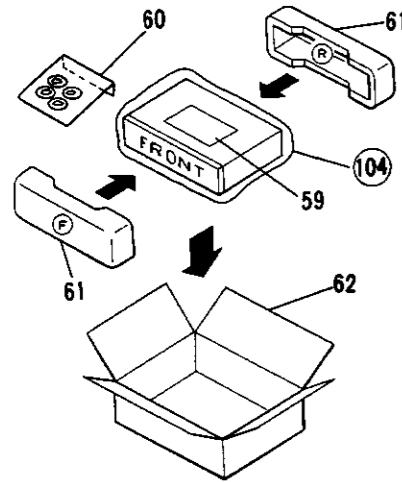

C

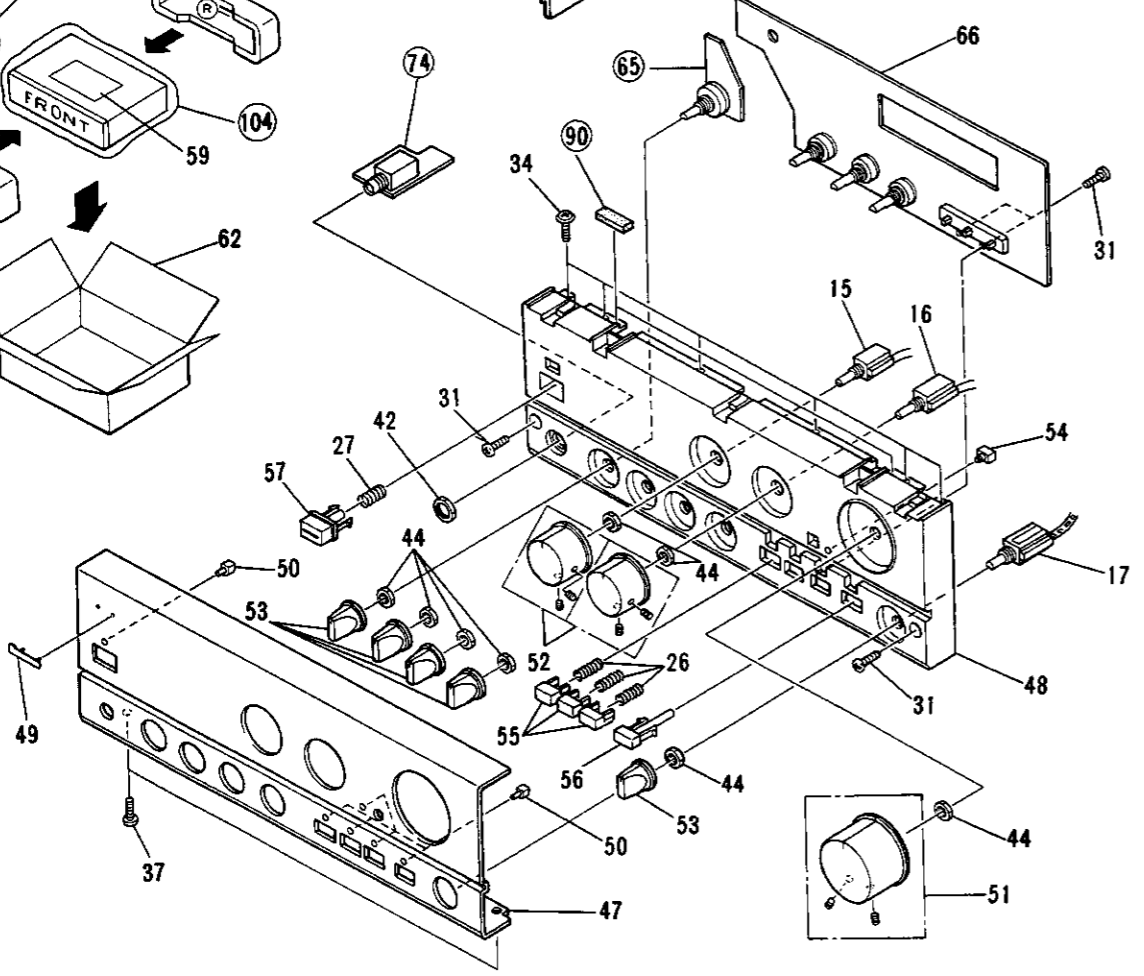

D

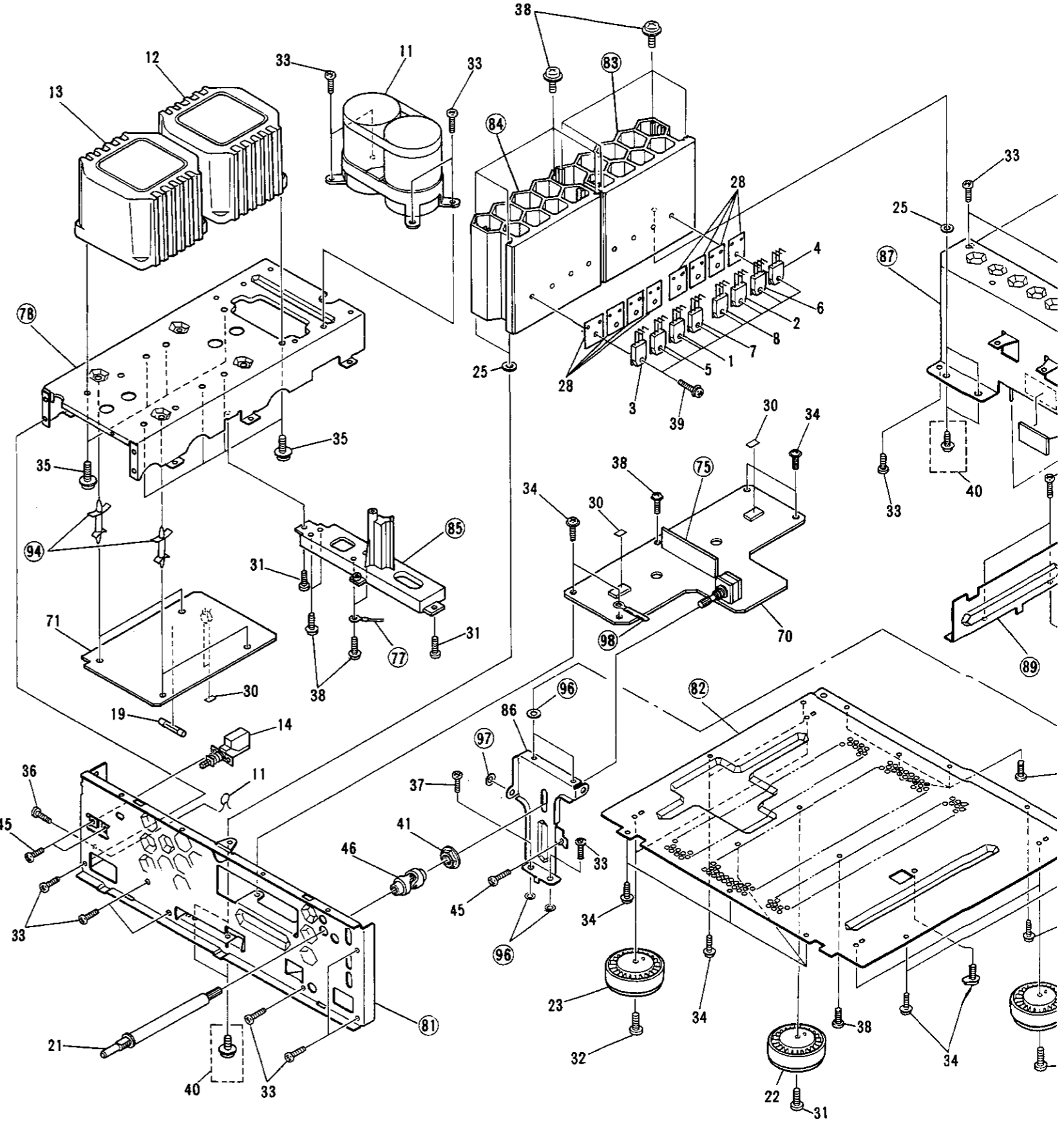

1

2

3

4

5

6

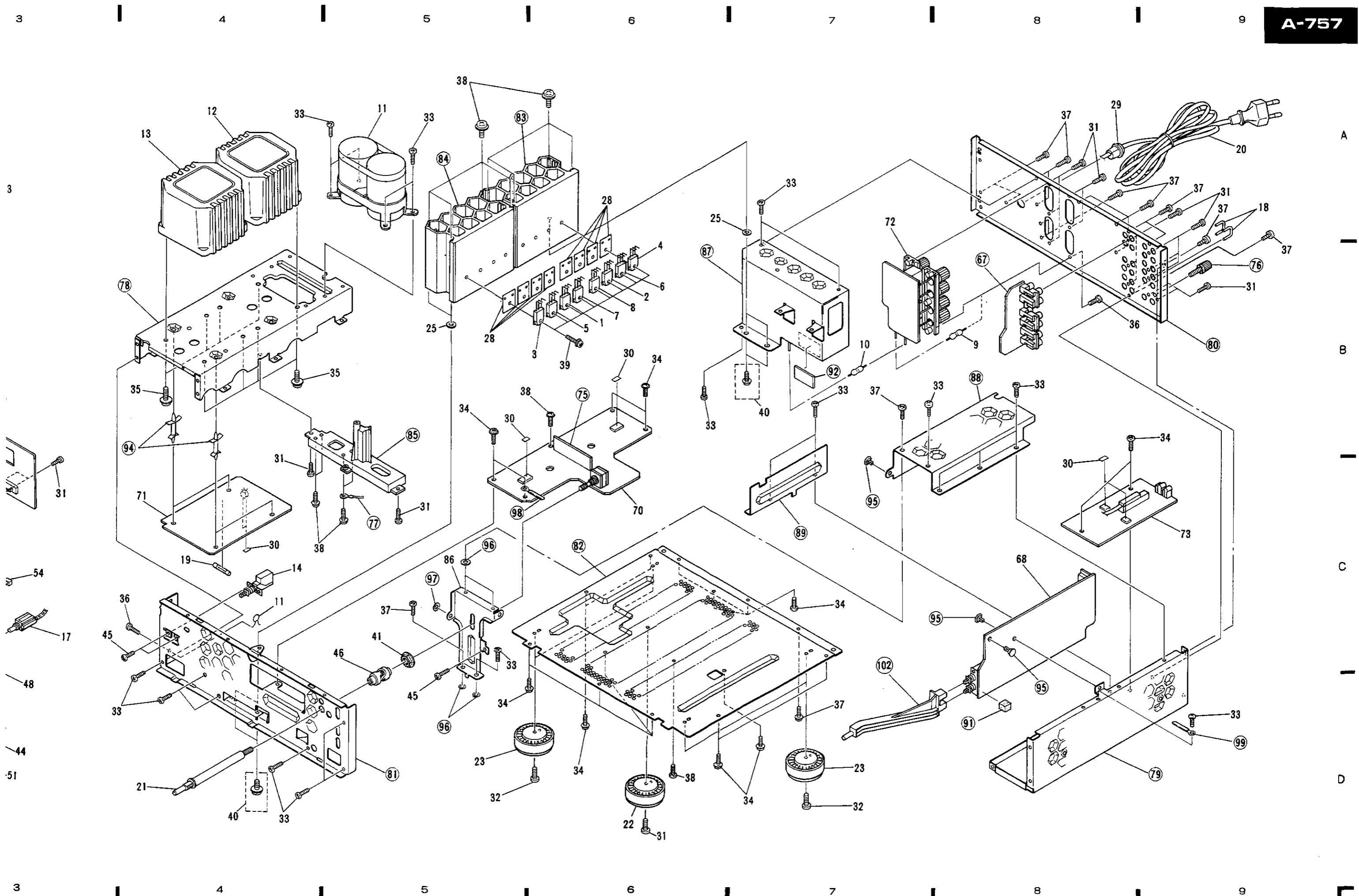

2. SCHEMATIC DIAGRAM

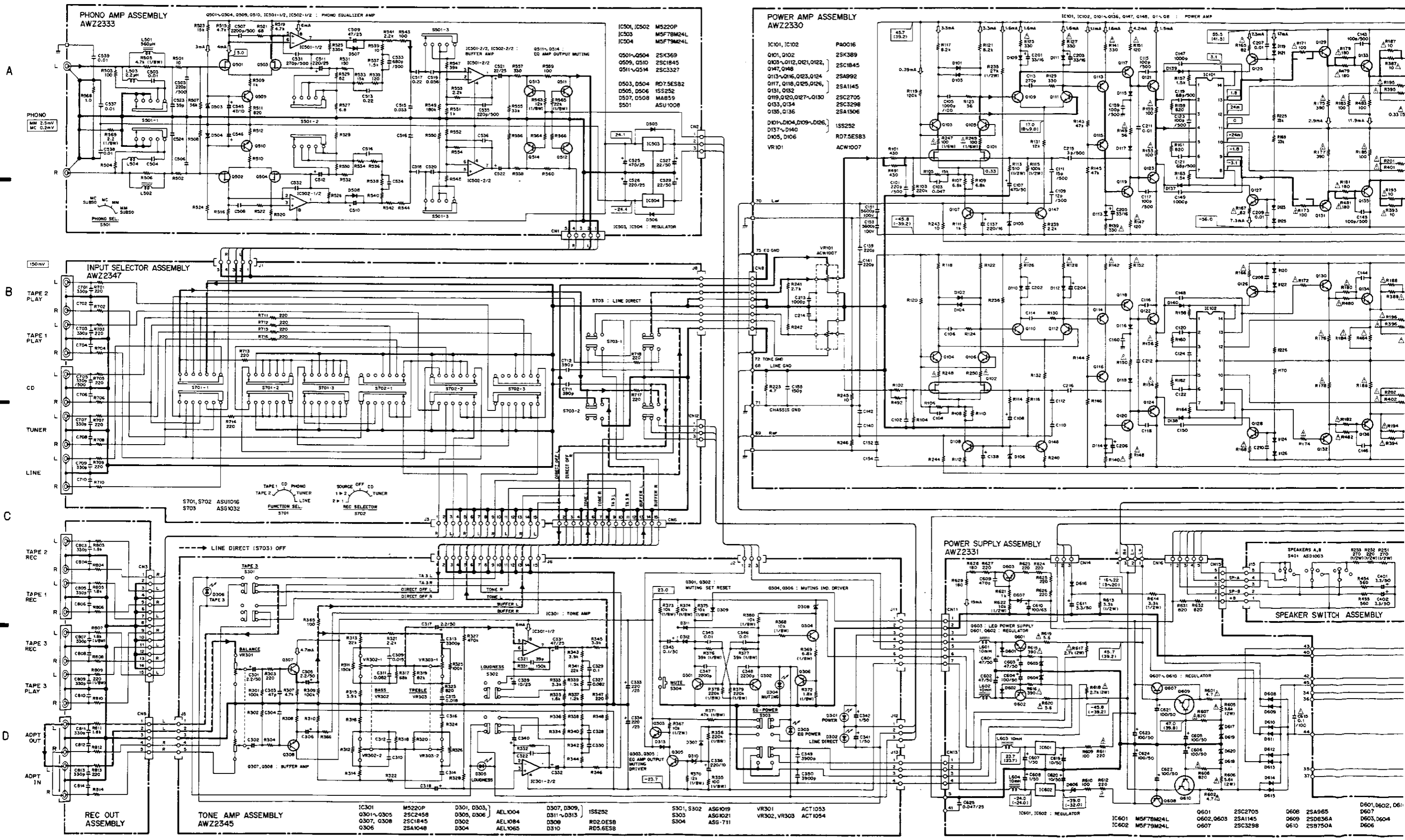

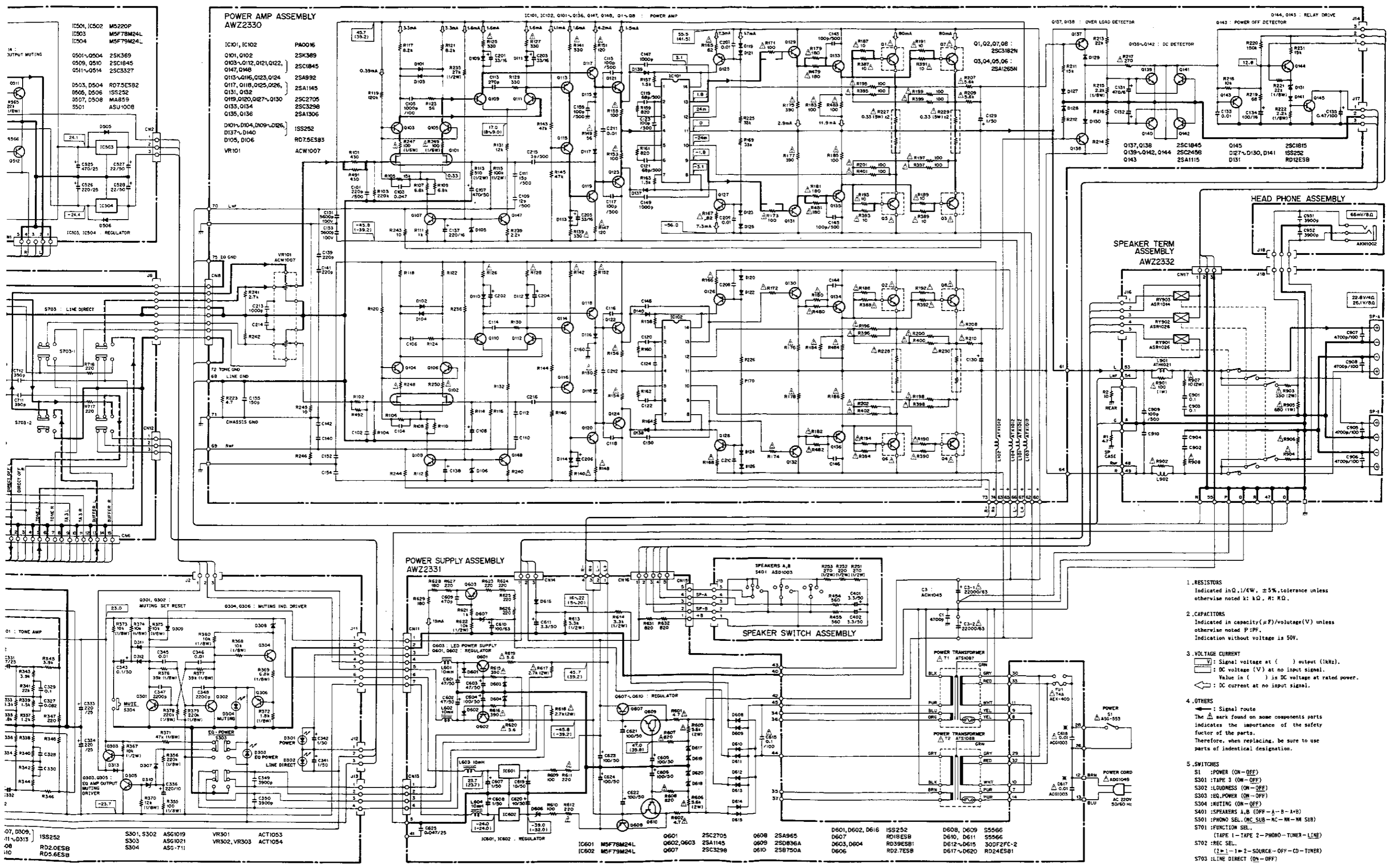

IC501, IC502 M5220P
 IC503 M5F78M24L
 IC504 M5F78M24L

D501~D504 2SK369
 D505, D510 2SC1845
 D511~D514 2SC327

D503, D504 R07.5ESB2
 D505, D506 ISS252
 D507, D508 MAR59
 S501 ASU100B

REGULATOR

PA0016
 Q101, Q102 2SK369
 Q103~Q112, Q121, Q122, Q147, Q148 2SC1845
 Q113~Q116, Q123, Q124 2SA992
 Q117, Q118, Q125, Q126, Q131, Q132 2SA1145
 Q119, Q120, Q127~Q130 2SC2705
 Q133, Q134 2SC3298
 Q135, Q136 2SA1306

ISS252
 R07.5ESB3
 ACW1007

VR101 ACW1007

REGULATOR

LINE DIRECT

LINE GND

CHASSIS GND

IC601 M5F78M24L
 IC602 M5F78M24L

Q601, Q602, Q603 2SC2705
 Q604, Q605 2SC3298

REGULATOR

Q301, Q302 M5220P
 Q303, Q304 M5F78M24L

D301~D304 2SK369
 D305, D306 2SC1845
 D307, D308 2SC327

M5220P
 M5F78M24L

ISS252
 RD2.0ESB
 RD5.6ESB

ASG1019
 ASG1021
 ASG-711

VR301, VR302, VR303 ACT1053
 ACT1054

Q1 : TONE AMP
 Q2 : EQ AMP OUTPUT MUTING DRIVER
 Q3 : EQ POWER
 Q4 : EQ LINE DIRECT
 Q5 : EQ POWER
 Q6 : EQ LINE DIRECT



Q7, D309, D11~D313 1SS252
 S303, S304 ASG1021
 S304 ASG-711

- RESISTORS**
 Indicated in Ω, 1/4W, ±5% tolerance unless otherwise noted k: kΩ, M: MΩ.
- CAPACITORS**
 Indicated in capacity (μF)/voltage (V) unless otherwise noted P: pF.
 Indication without voltage is 50V.
- VOLTAGE CURRENT**
 V: Signal voltage at () output (kHz).
 V: DC voltage (V) at no input signal.
 Value in () is DC voltage at rated power.
 ←: DC current at no input signal.
- ARROWS**
 →: Signal route
 The Δ mark found on some components parts indicates the importance of the safety factor of the parts. Therefore, when replacing, be sure to use parts of identical designation.
- SWITCHES**
 S1 : POWER (ON-OFF)
 S301 : TAPE 3 (ON-OFF)
 S302 : LOUDNESS (ON-OFF)
 S303 : EQ POWER (ON-OFF)
 S304 : MUTING (ON-OFF)
 S401 : SPEAKERS A, B (OFF-A-B-A+B)
 S501 : PHONO SEL. (MC SUB-NC-NR-NR SUB)
 S701 : FUNCTION SEL.
 (TAPE 1-TAPE 2-PHONO-TUNER-LINE)
 S702 : REC SEL.
 (2=1-1=2-SOURCE-OFF-CD-TUNER)
 S703 : LINE DIRECT (ON-OFF)

3. P.C. BOARDS CONNECTION DIAGRAM

NOTE

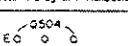
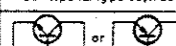
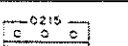
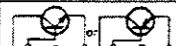
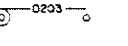
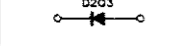
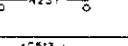
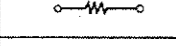
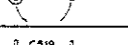
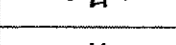
1. This P.C.B. connection diagram is viewed from the parts mounted side.
2. The parts which have been mounted on the board can be replaced with those shown with the corresponding wiring symbols listed in the following Table.

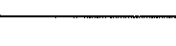
P.C.B. pattern diagram indication	Corresponding part symbol	Part Name
		Transistor
		Radiator type transistor
		Diode
		Resistor
		Capacitor (Polarity)
		Capacitor (Non-polarity)

Others

P.C.B. pattern diagram indication	Part Name
IC	IC
S	Switch
RY	Relay
L	Coil
F	Filter
VR	Variable resistor or Semi-fixed resistor

3. The capacitor terminal marked with ⊕ (double circles) shows negative terminal.
4. The diode terminal marked with ⊕ (double circles) shows cathode side.
5. The transistor terminal to which E is affixed shows the emitter.

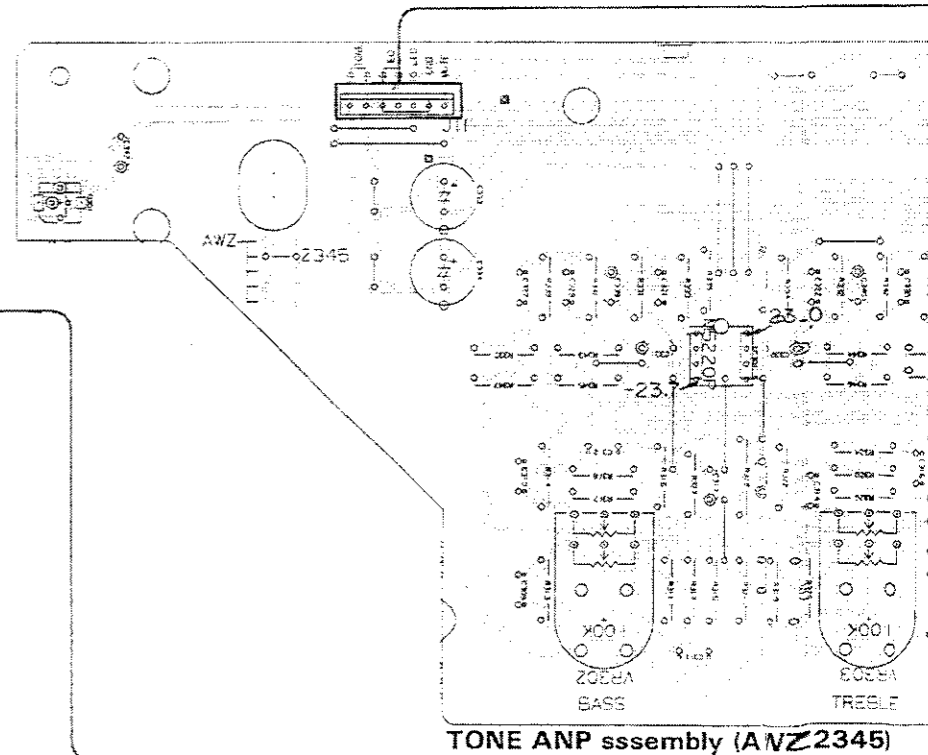
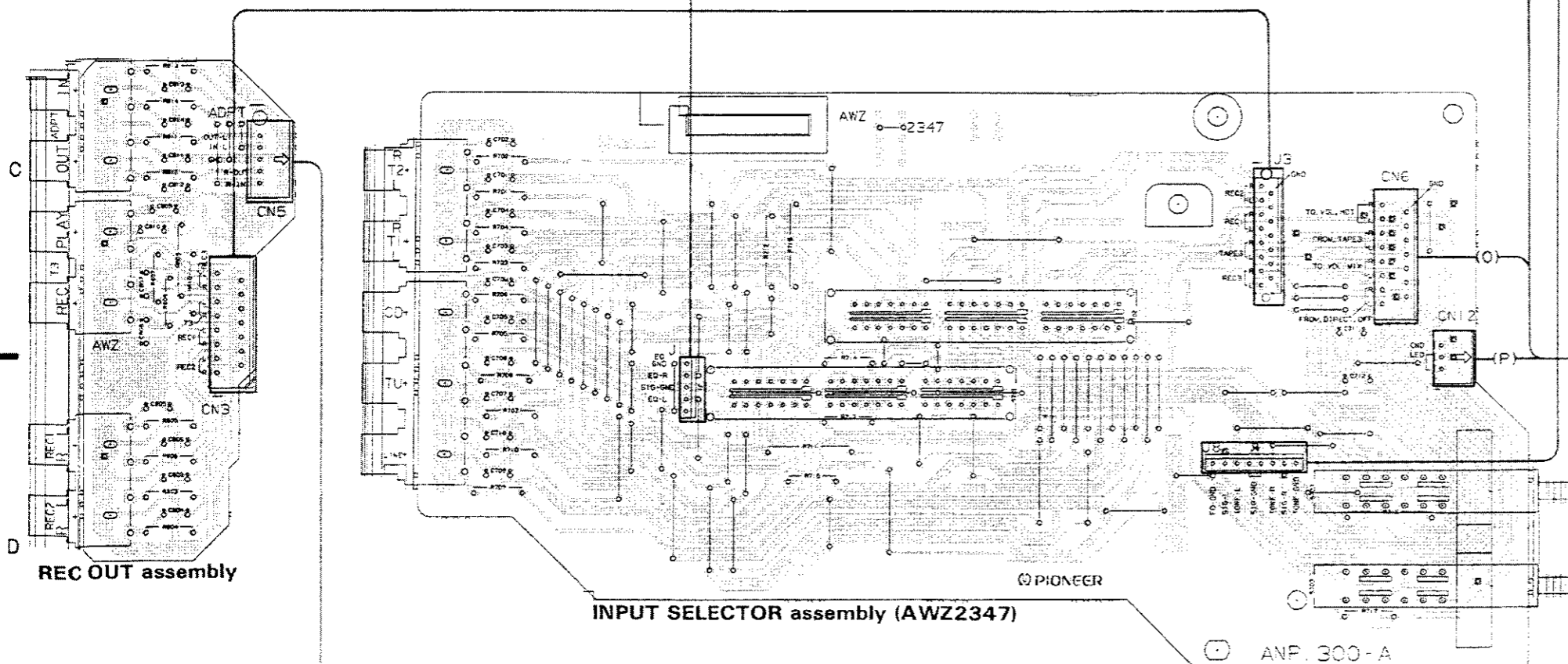
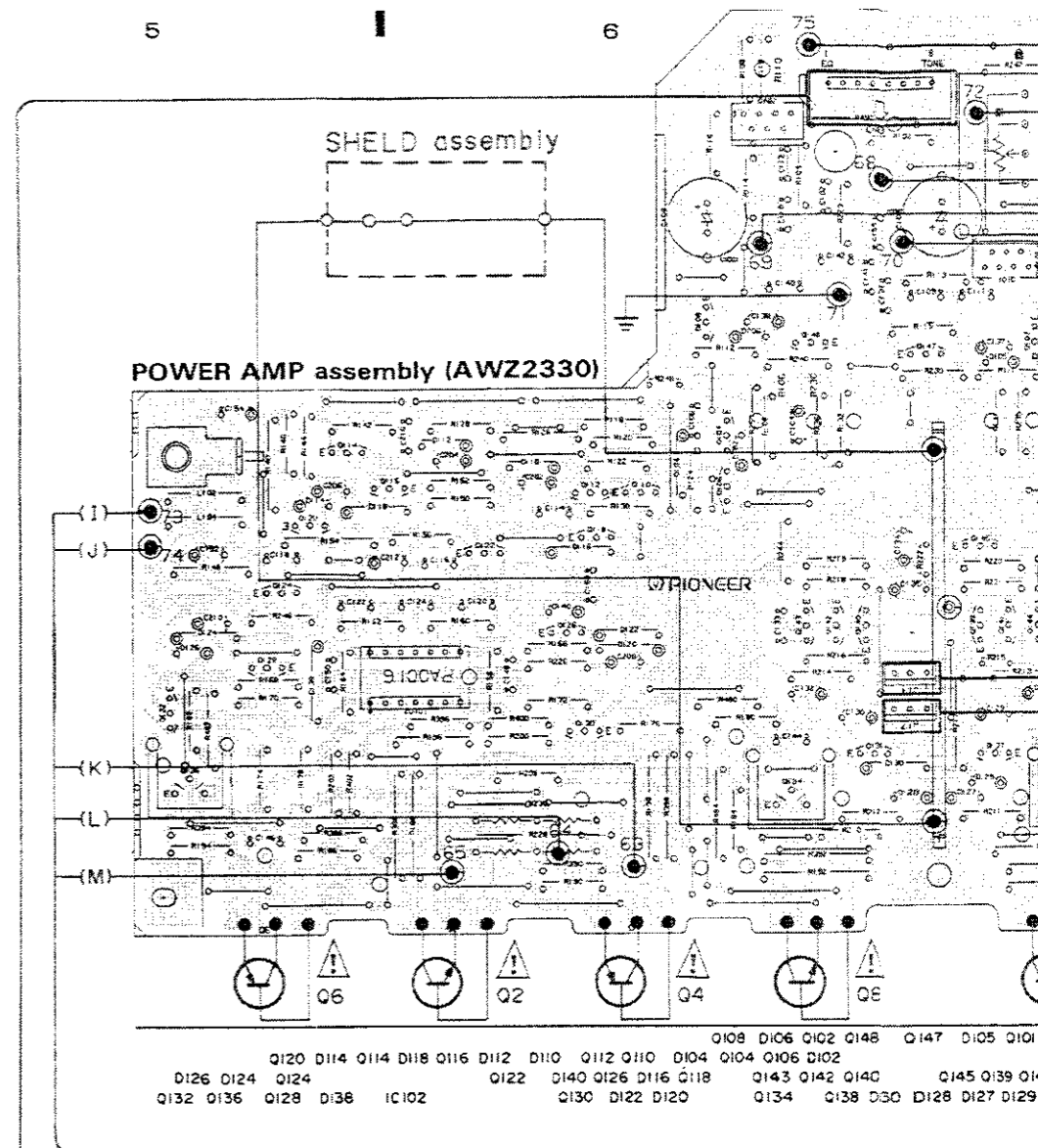
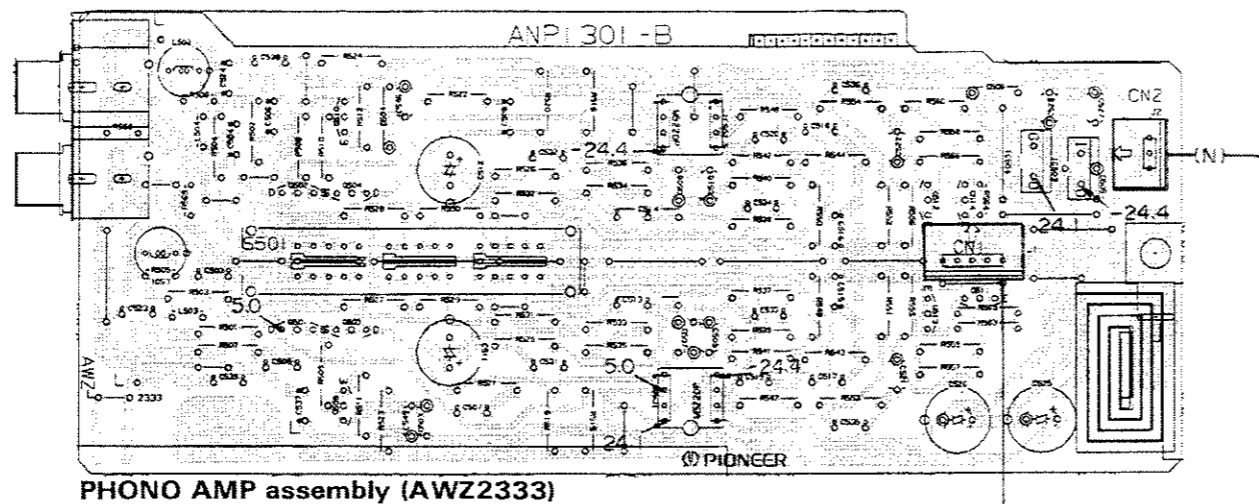

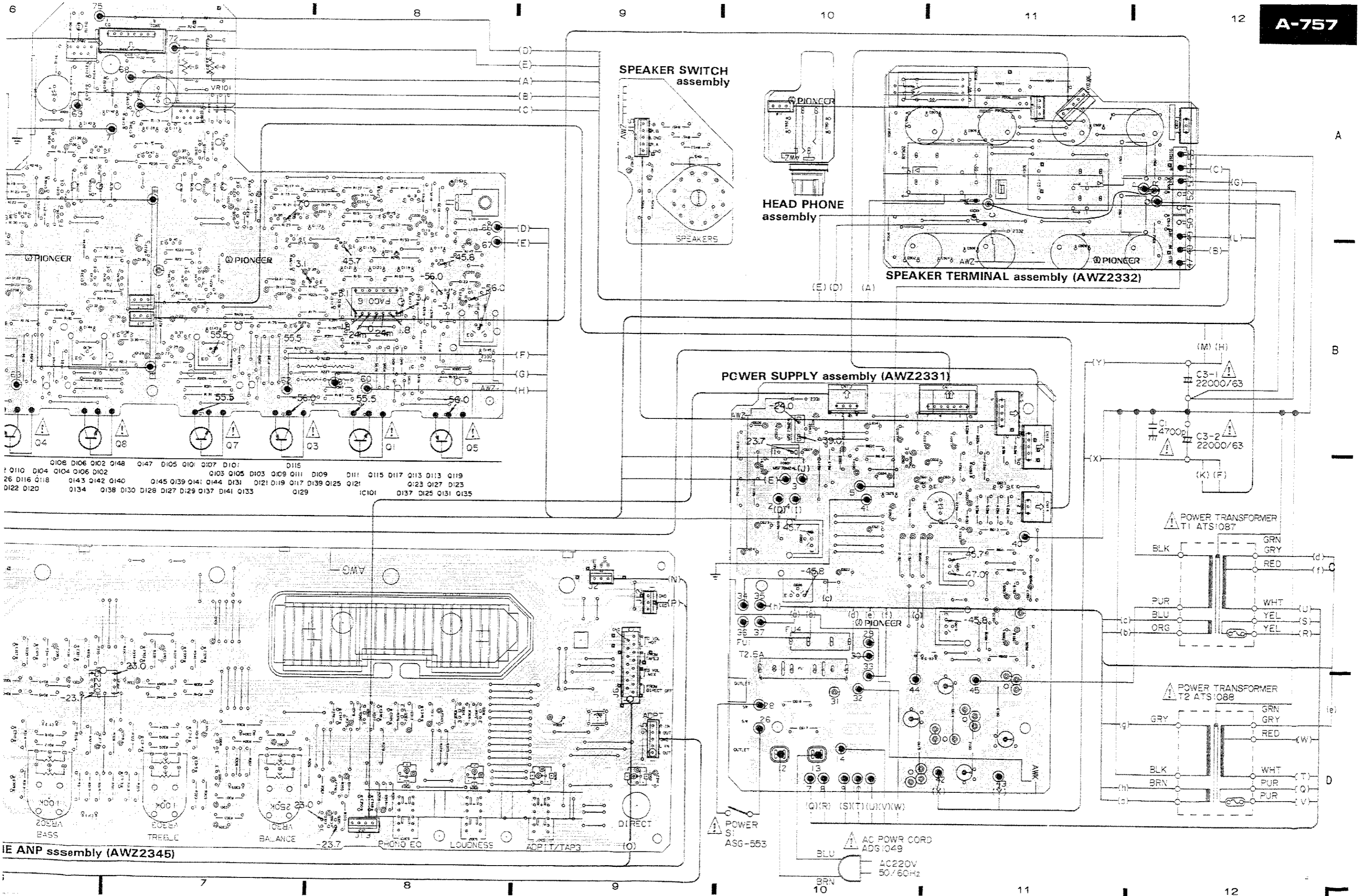

IE ANP ssembly (AWZ2345)

POWER SUPPLY ASG-553

AC POWER CORD ADS1049 AC220V 50/60Hz

2. SCHEMATIC AND P.C.BOARDS DIAGRAM

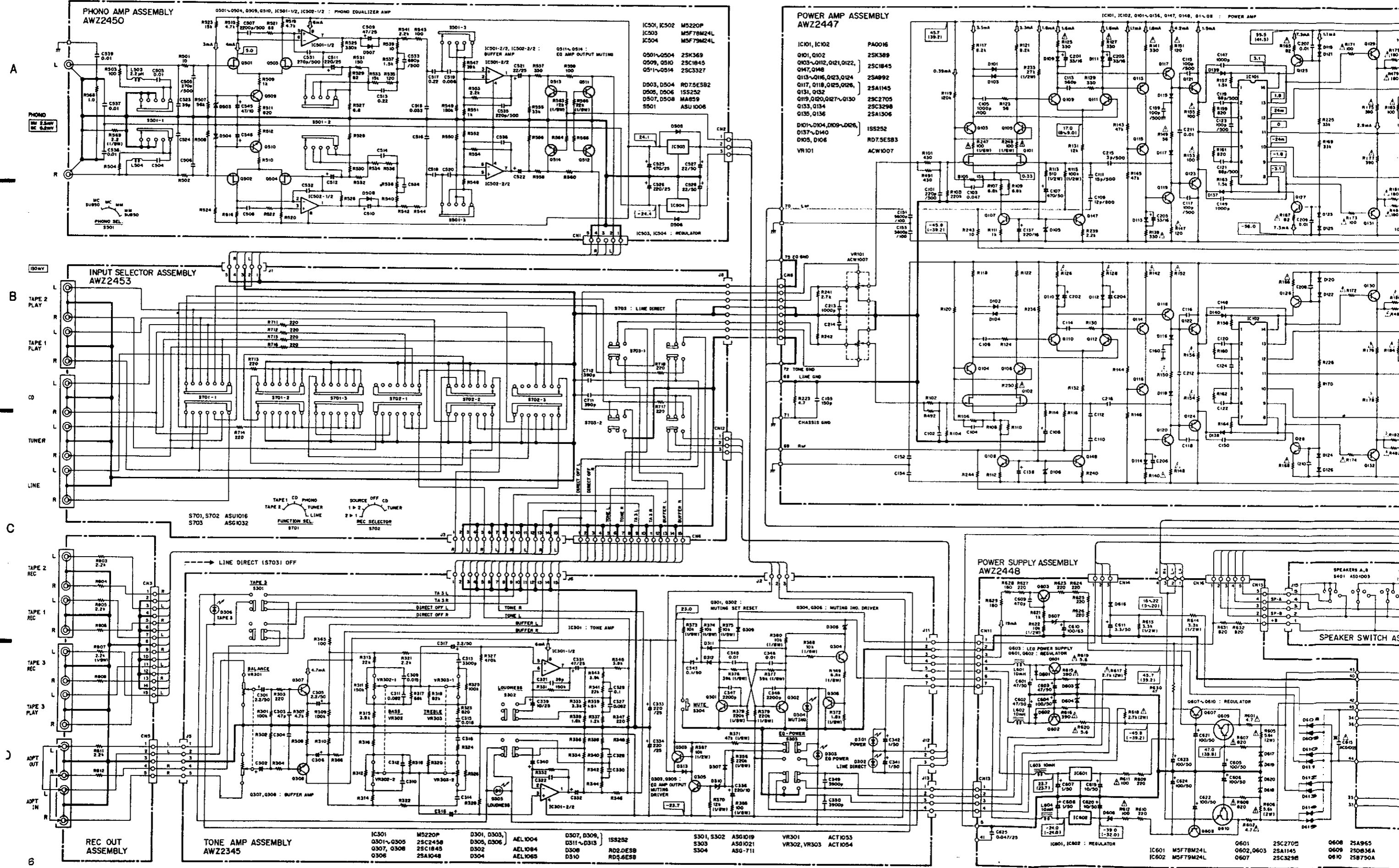

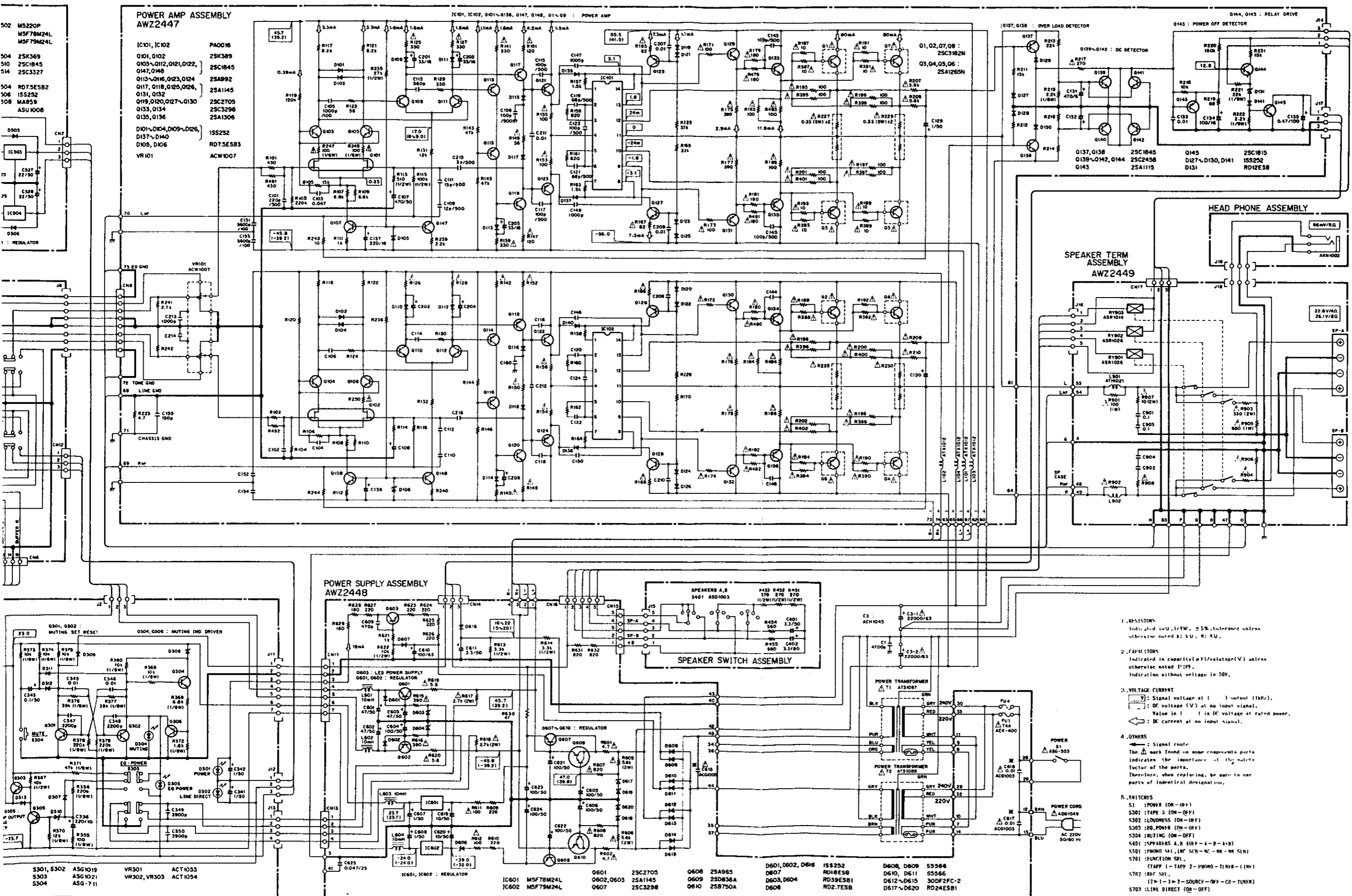

A

B

C

D

- RESISTORS
Indicated in Ω, 1/W, ±5% tolerance unless otherwise noted: K, M, μ.
- CAPACITORS
Indicated in capacity (pF)/voltage (V) unless otherwise noted: μF.
Indication without voltage is 50V.
- VOLTAGE/CURRENT
V: Signal voltage at () output (1kHz).
DC: DC voltage (V) at no input signal.
Value in () is DC voltage at rated power.
A: DC current at no input signal.
- OTHERS
S: Signal route.
The Δ mark found on some component parts indicates the importance of the quality factor of the parts. Therefore, when replacing, be sure to use parts of identical designation.
- SWITCHES
S1: POWER (ON-OFF)
S301: TAP 3 (ON-OFF)
S302: LOUDNESS (ON-OFF)
S303: EQ. POWER (ON-OFF)
S304: MUTING (ON-OFF)
S401: SPEAKERS A, B (OFF-A-B-A-B)
S501: PHONO S-1, (OFF-SW-NC-ON-ARM-SLN)
S701: FUNCTION SW.
(TAPP 1-TAPP 2-PHONO-TUNER-1-1N)
S702: TRF SW.
(T-1-T-2-SOURCE-OFF-CD-TUNER)
S703: LINE DIRECT (ON-OFF)

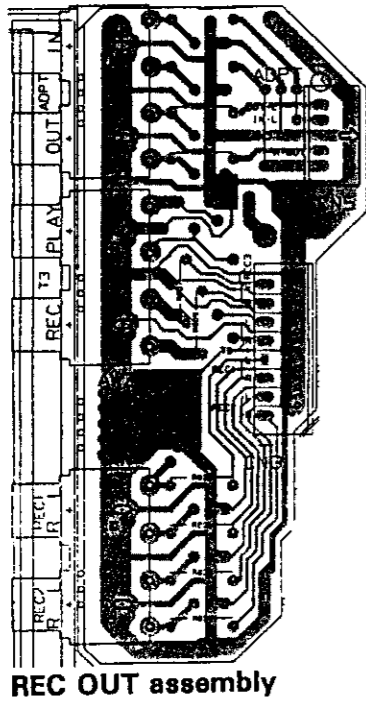

REC OUT assembly

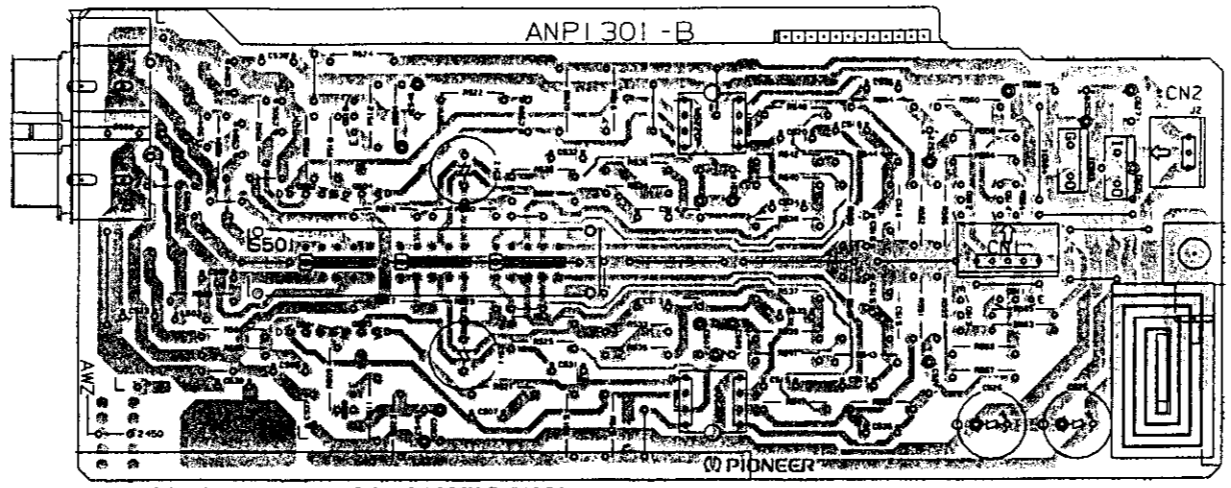

PHONO AMP assembly (AWZ2450)

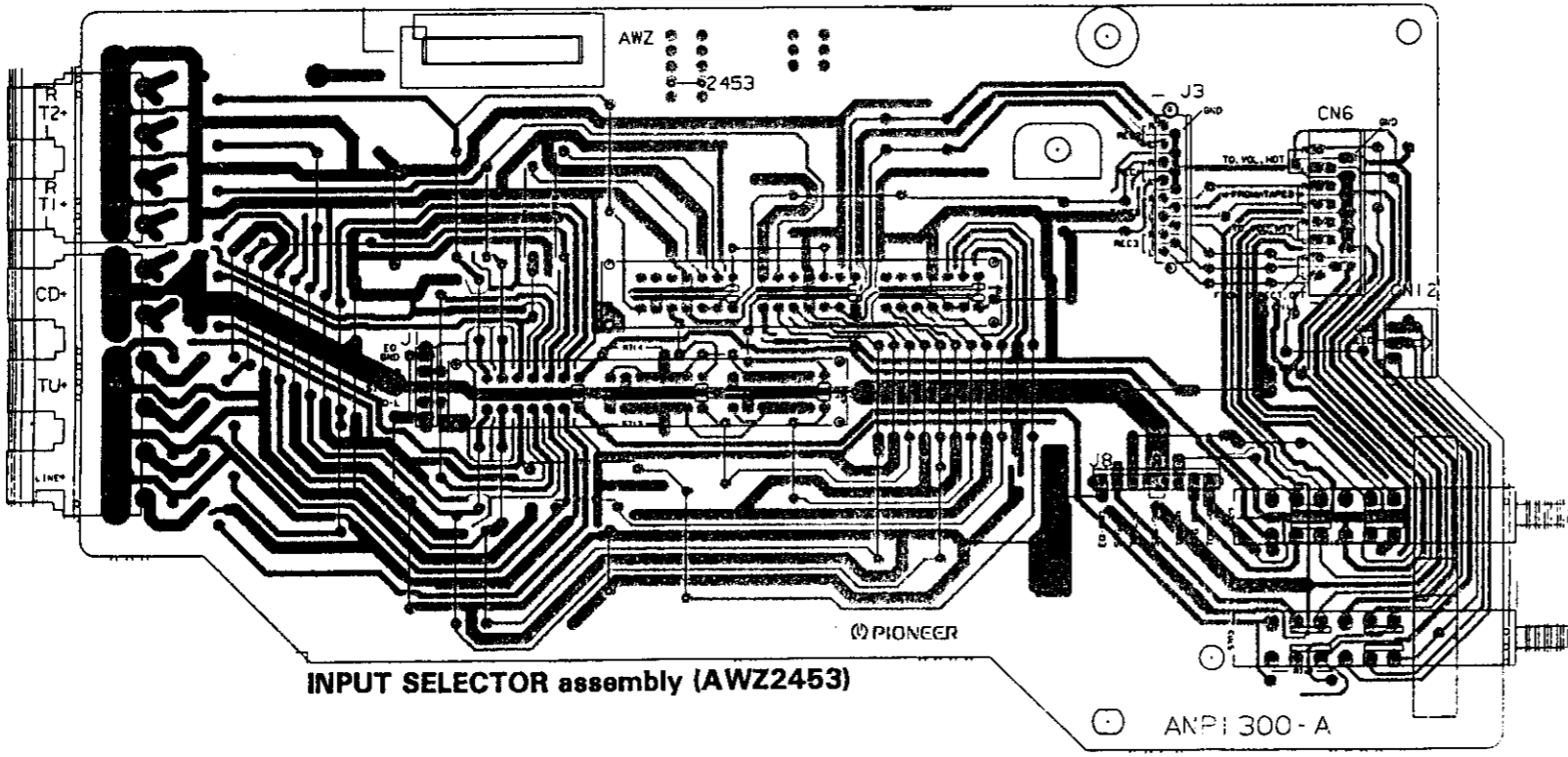

INPUT SELECTOR assembly (AWZ2453)

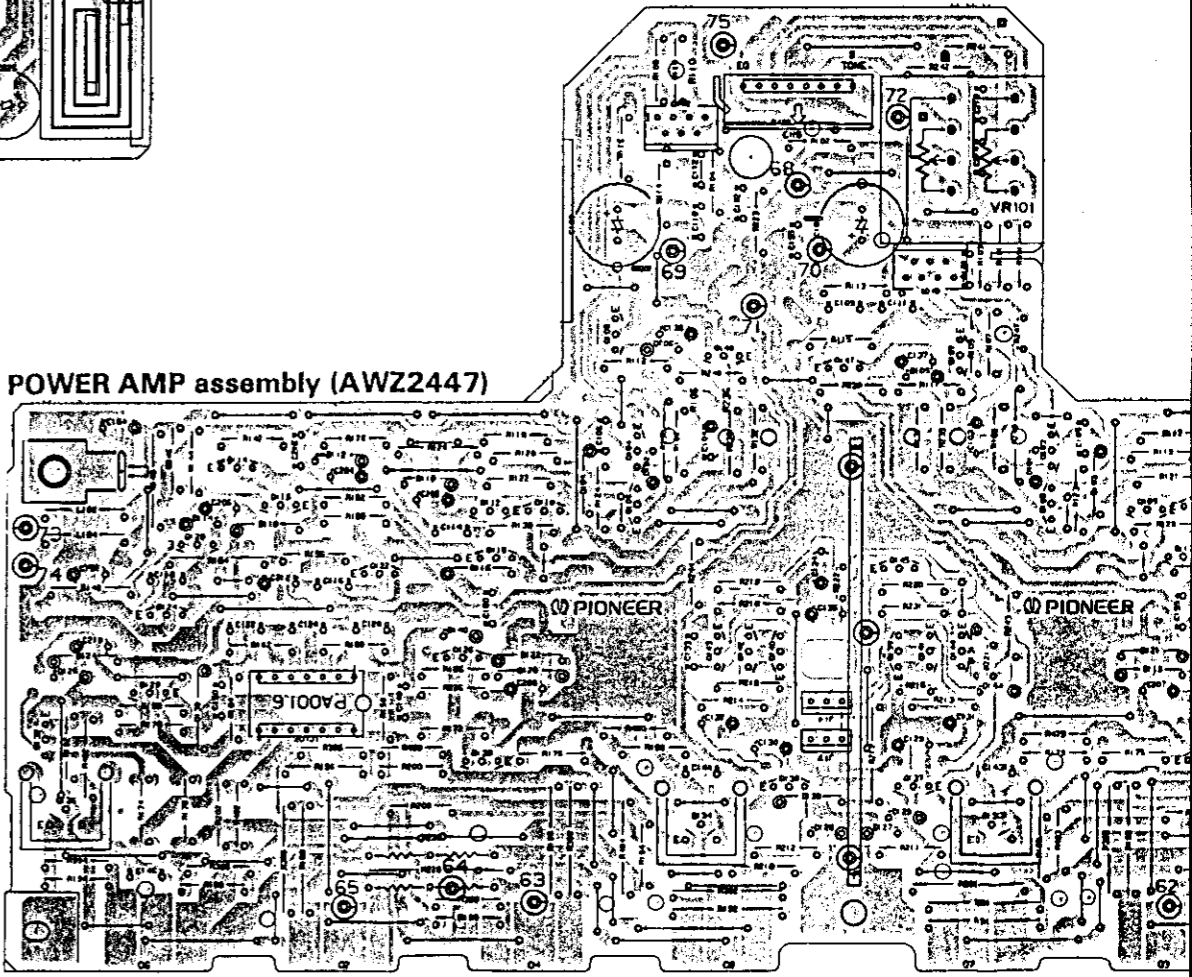

POWER AMP assembly (AWZ2447)

Q108 Q106 Q102 Q148 Q147 Q105 Q101 Q107
 Q103 Q105 Q103 Q109 Q104
 Q126 Q124 Q124 Q122 Q140 Q126 Q116 Q118 Q143 Q142 Q140 Q145 Q139 Q141 Q144 Q131 Q121 Q119 Q101
 Q132 Q136 Q128 Q138 IC102 Q130 Q122 Q120 Q134 Q138 Q130 Q128 Q127 Q129 Q137 Q141 Q133

- NOTE
1. This P.C.B. connection diagram is viewed from the parts mounted side.
 2. The parts which have been mounted on the board can be replaced with those shown with the corresponding wiring symbols listed in the following Table.

P.C.B. pattern diagram indication	Corresponding part symbol	Part Name
EG 0504		Transistor
Q215		Radiator type transistor
D203		Diode
R237		Resistor
C313		Capacitor (Polarity)
C318		Capacitor (Non-polarity)

P.C.B. pattern diagram indication	Part Name
IC	IC
S	Switch
RY	Relay
L	Coil
F	Filter
VR	Variable resistor or Semi-fixed resistor

3. The capacitor terminal marked with ⊖ (double circles) shows negative polarity.
4. The diode terminal marked with ⊖ (double circles) shows cathode side.
5. The transistor terminal to which a symbol shows the emitter.

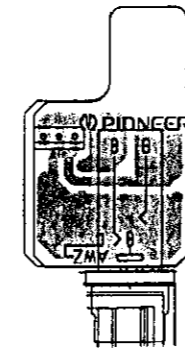
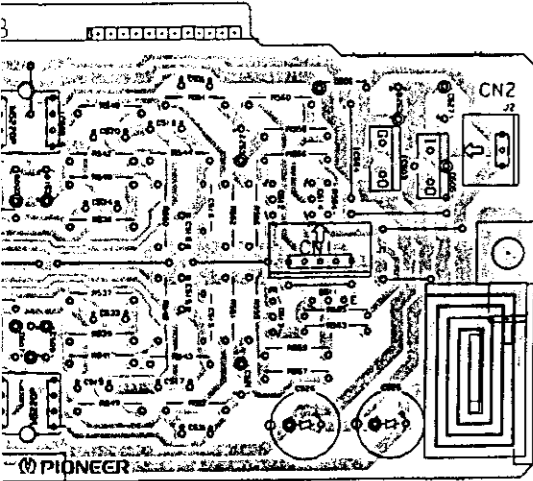

HEAD PHONE assembly

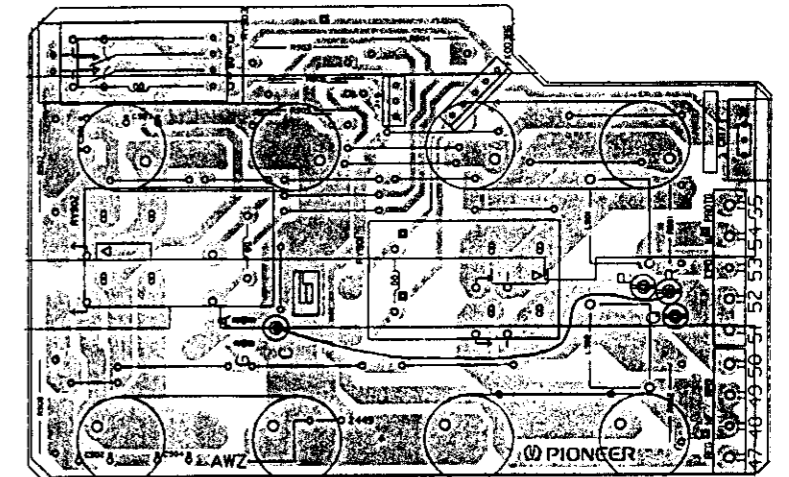

SPEAKER TERMINAL assembly (AWZ2449)

POWER AMP assembly (AWZ2447)

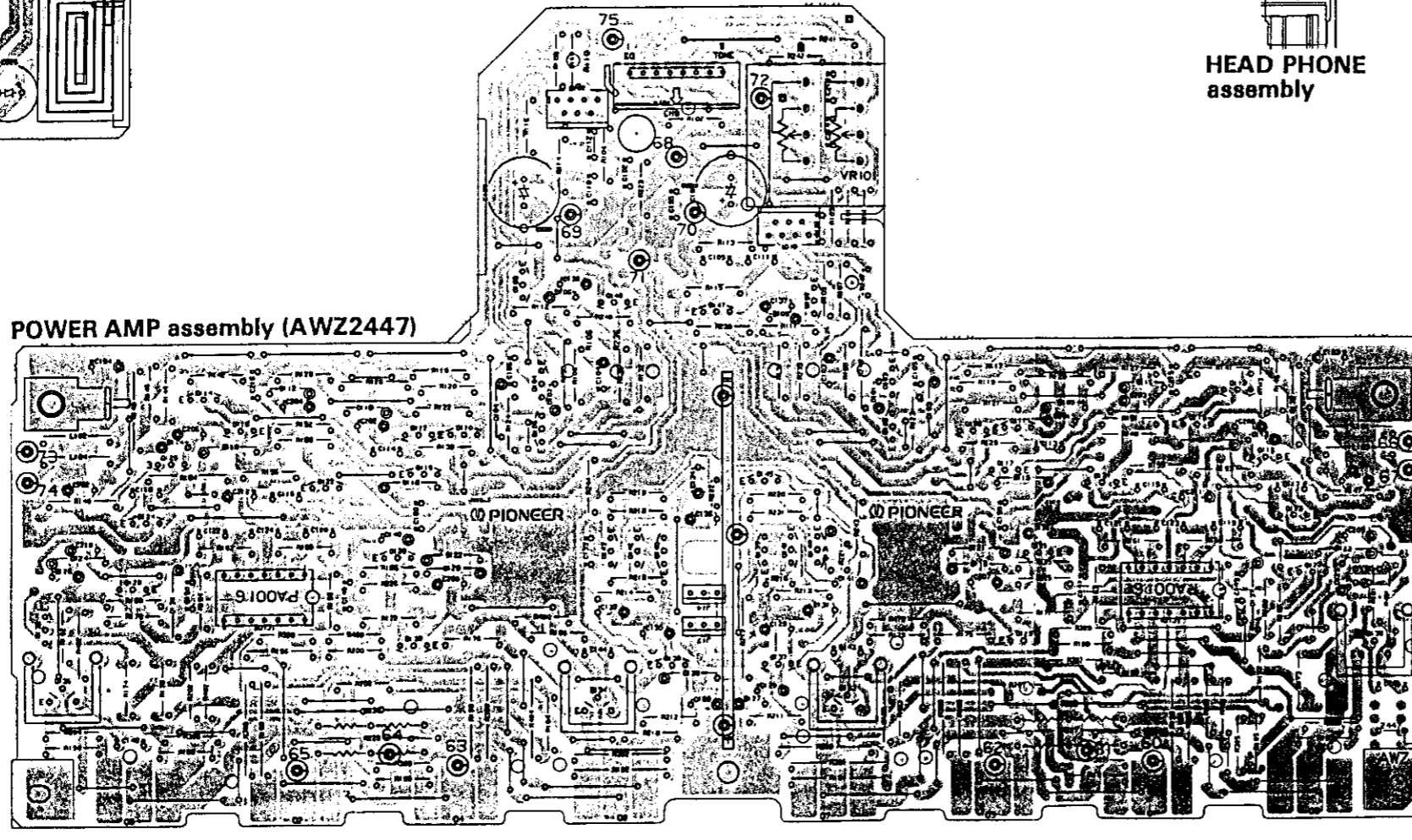

Q108 D106 Q102 Q148 Q147 D105 Q101 Q107 Q103 Q105 D103 Q109 Q111 D109 D111 Q115 D117 Q113 D113 Q119
 D126 D124 Q124 Q122 D140 Q126 D116 Q118 Q143 Q142 Q140 Q145 Q139 Q141 Q144 D131 D121 D119 Q117 D139 Q125 Q121 Q123 Q127 D123
 Q132 Q136 Q128 D138 IC102 Q130 D122 D120 Q134 Q138 D130 D128 D127 D129 Q137 D141 Q133 Q129 IC101 D137 D125 Q131 Q135

NOTE

- This P.C.B. connection diagram is viewed from the parts mounted side.
- The parts which have been mounted on the board can be replaced with those shown with the corresponding wiring symbols listed in the following Table.

P.C.B. pattern diagram indication	Corresponding part symbol	Part Name
		Transistor
		Radiator type transistor
		Diode
		Resistor
		Capacitor (Polarity)
		Capacitor (Non-polarity)

Others

P.C.B. pattern diagram indication	Part Name
IC	IC
S	Switch
RY	Relay
L	Coil
F	Filter
VR	Variable resistor or Semi-fixed resistor

- The capacitor terminal marked with ⊙ (double circles) shows negative terminal.
- The diode terminal marked with ⊙ (double circles) shows cathode side.
- The transistor terminal to which E is affixed shows the emitter.

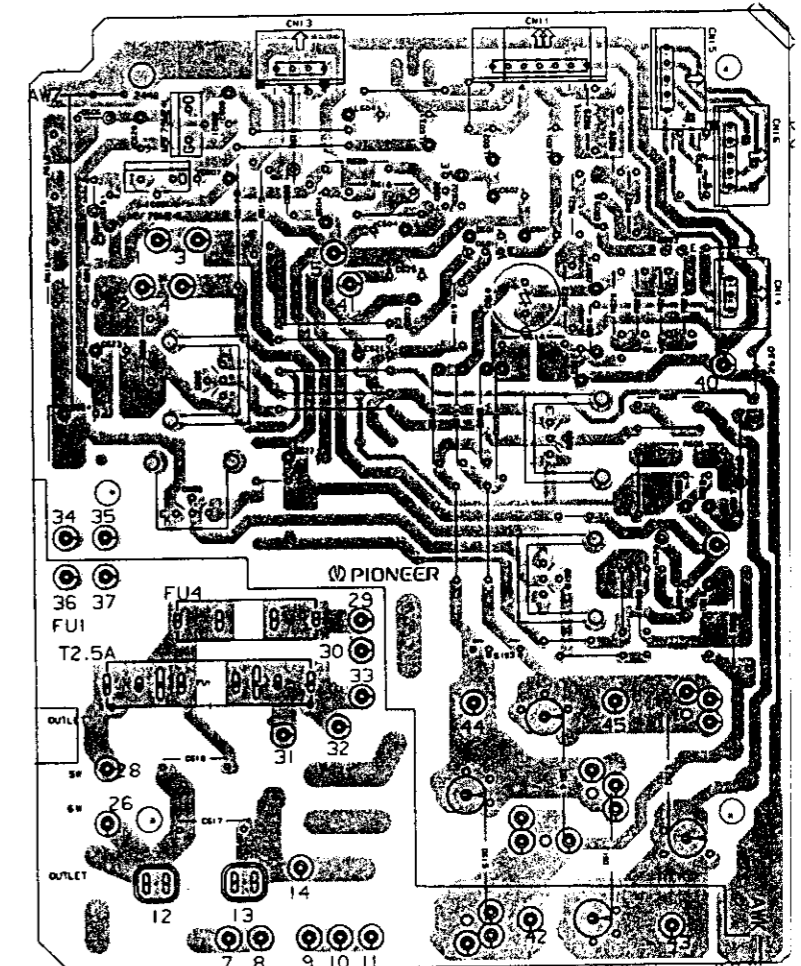

POWER SUPPLY assembly (AWZ2448)

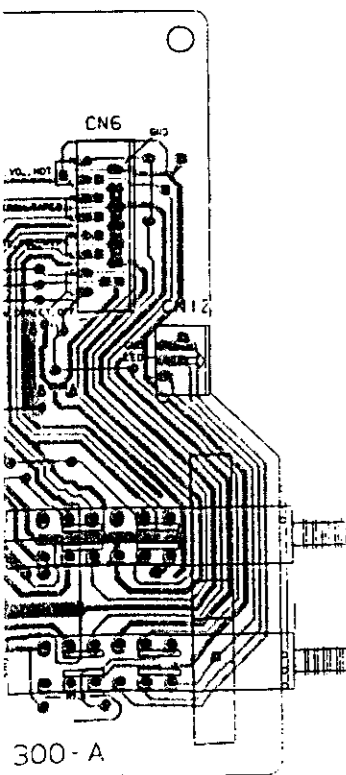

300-A

B

C

D

NOTE:
This picture shows the foil side of the printed circuit.

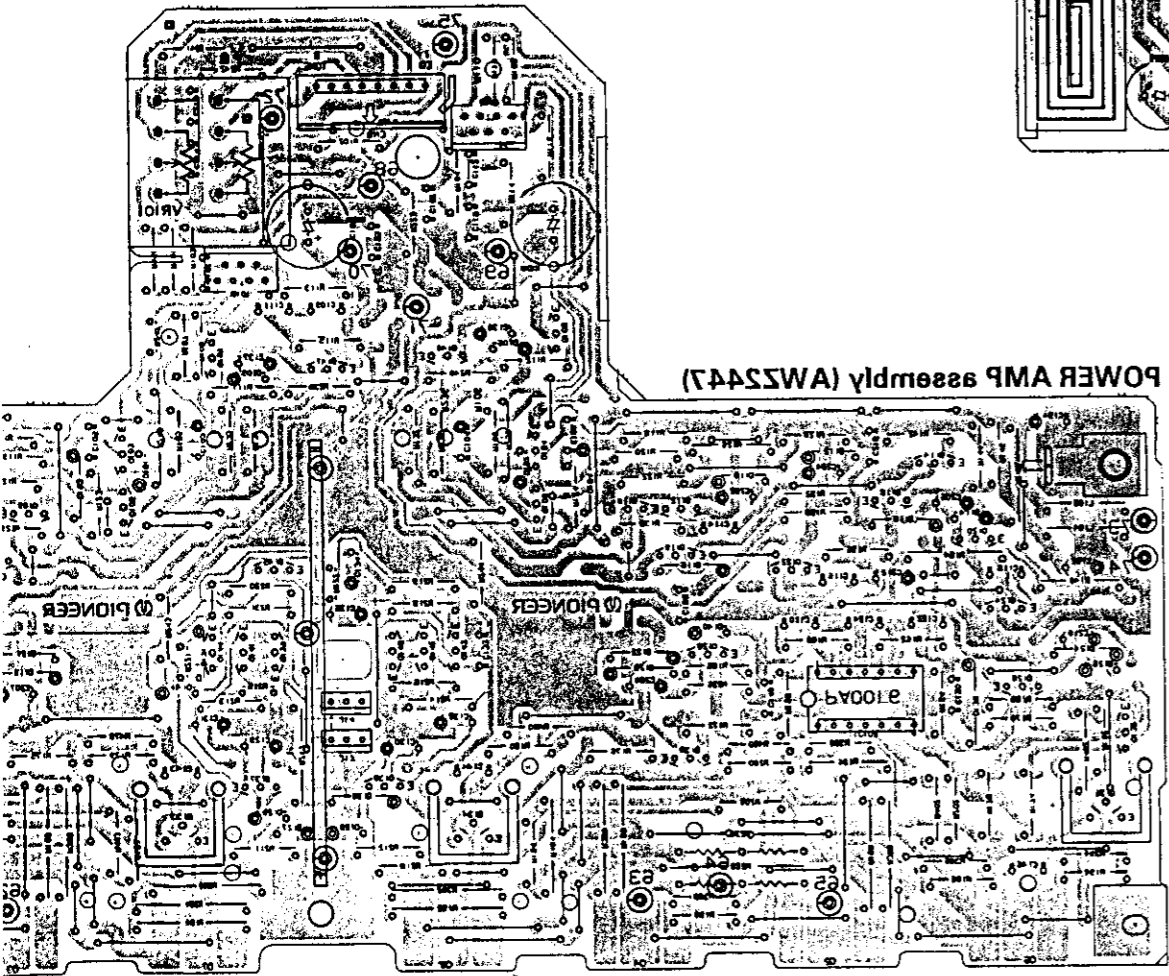

POWER AMP assembly (W22447)

0125 0126 0128 0129 0130 0131 0132 0133 0134 0135 0136 0137 0138 0139 0140 0141 0142 0143 0144 0145 0146 0147 0148 0149 0150 0151 0152 0153 0154 0155 0156 0157 0158 0159 0160 0161 0162 0163 0164 0165 0166 0167 0168 0169 0170 0171 0172 0173 0174 0175 0176 0177 0178 0179 0180 0181 0182 0183 0184 0185 0186 0187 0188 0189 0190 0191 0192 0193 0194 0195 0196 0197 0198 0199 0200

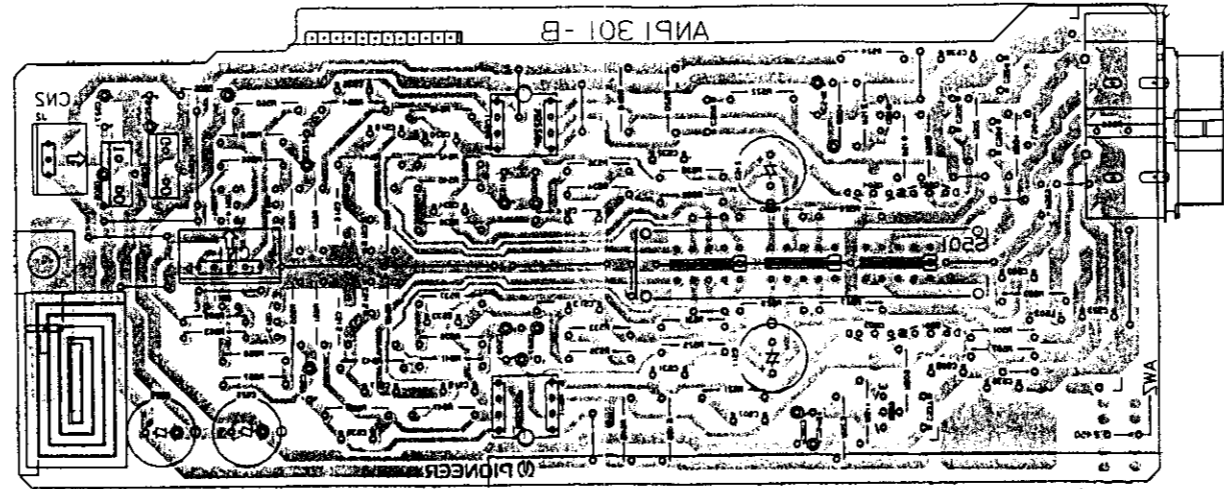

PHONO AMP assembly (W22450)

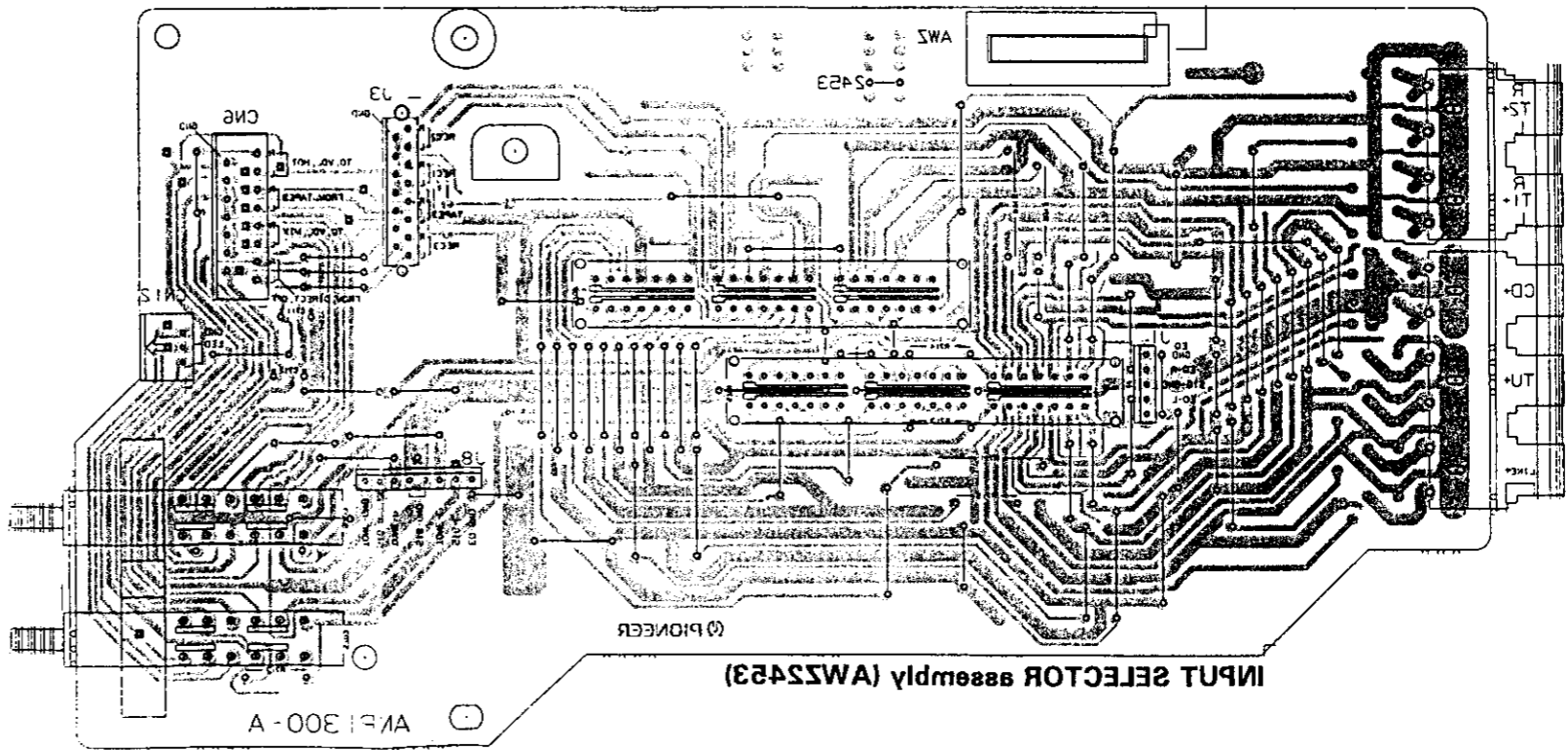

INPUT SELECTOR assembly (W22453)

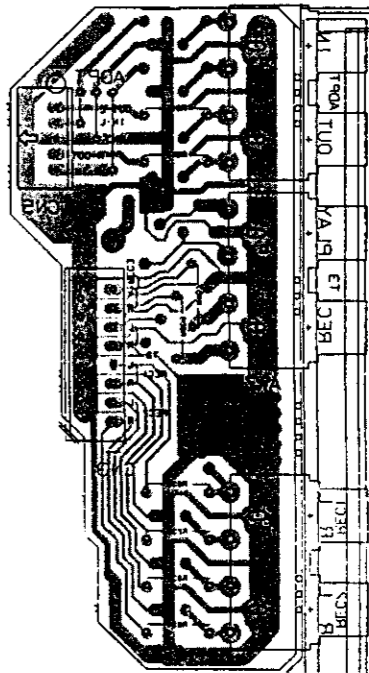

REC OUT assembly

A

B

C

D

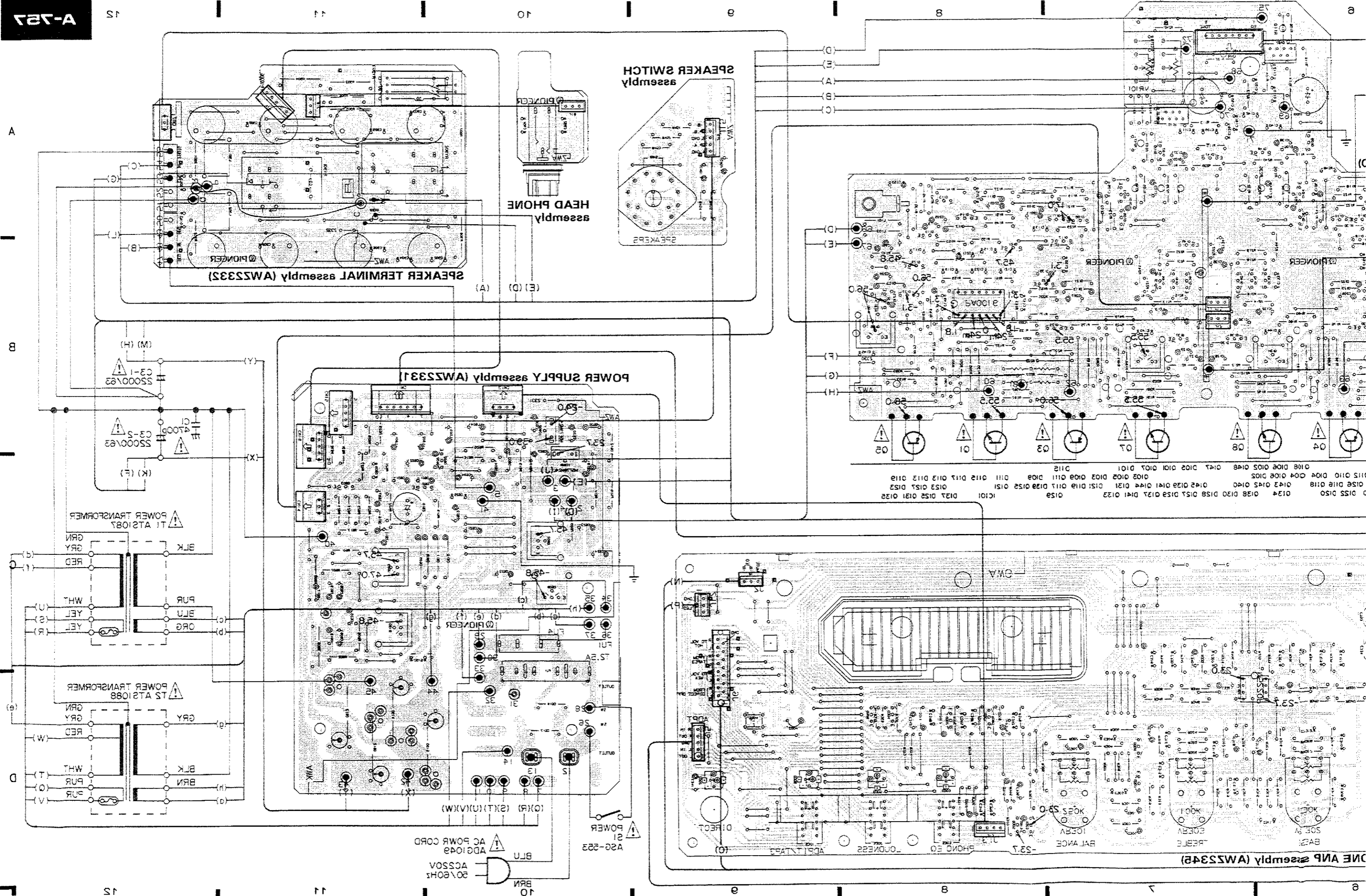

5.2 SCHEMATIC DIAGRAM

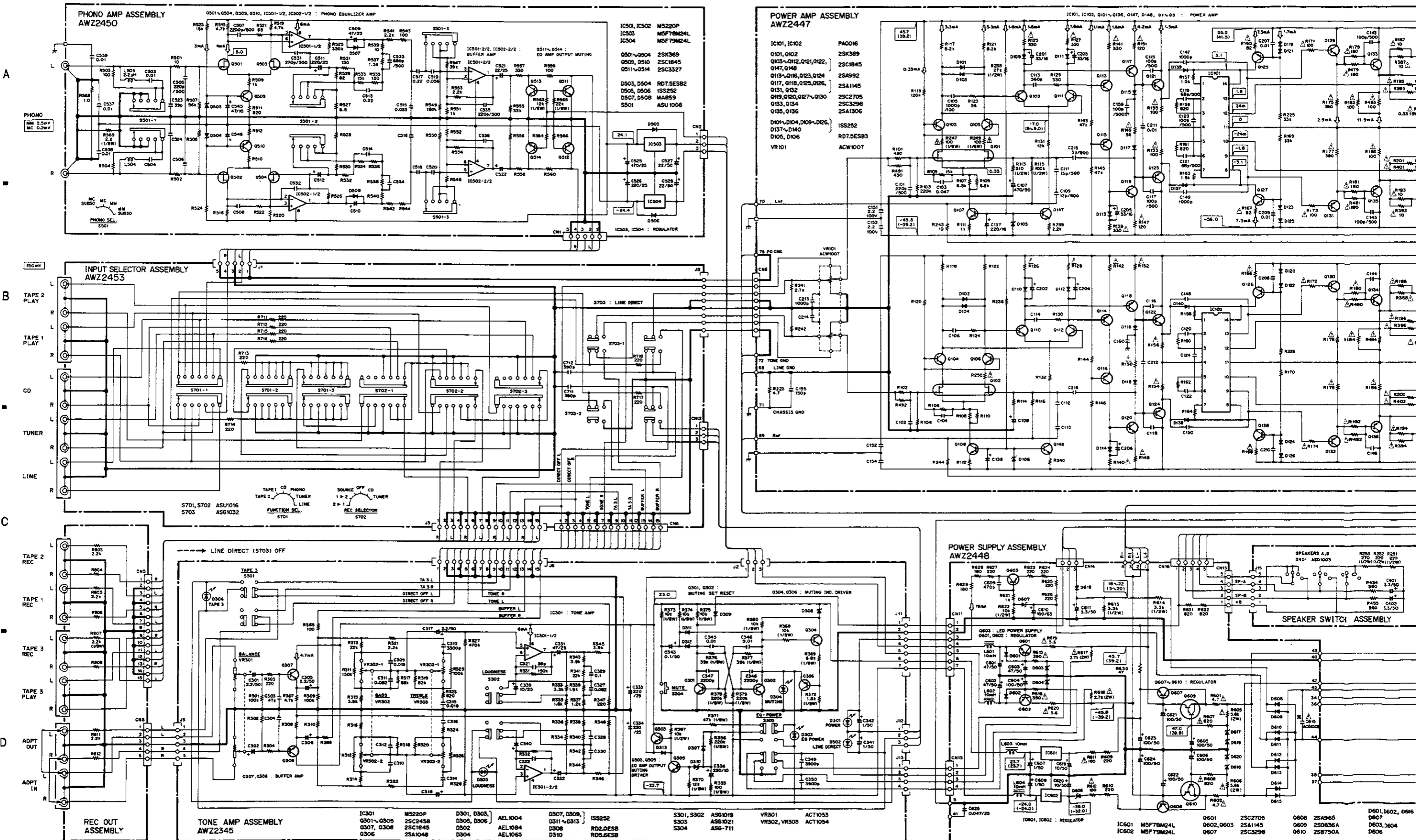

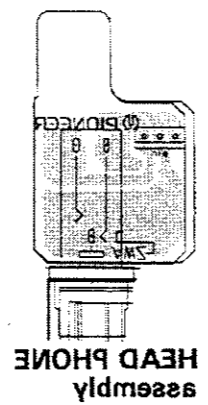
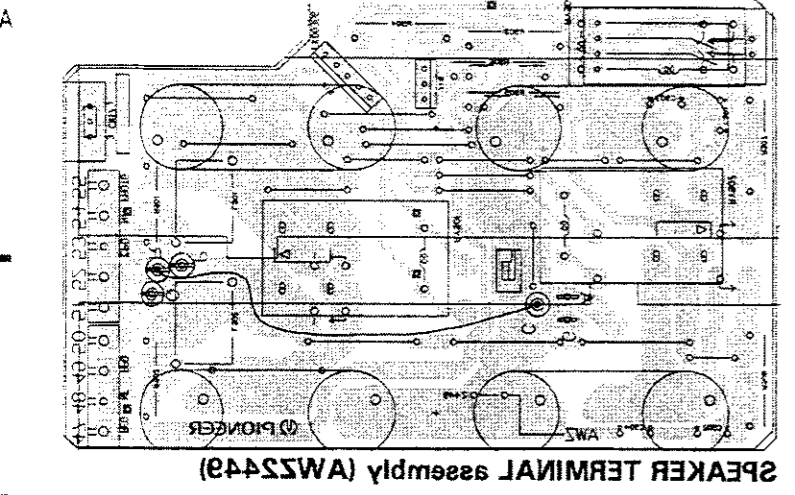

NOTE:
This picture shows the foil side of the printed circuit.

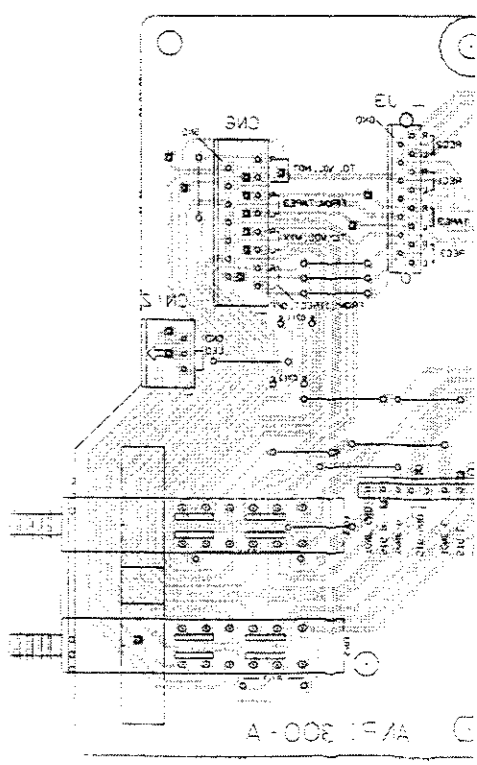
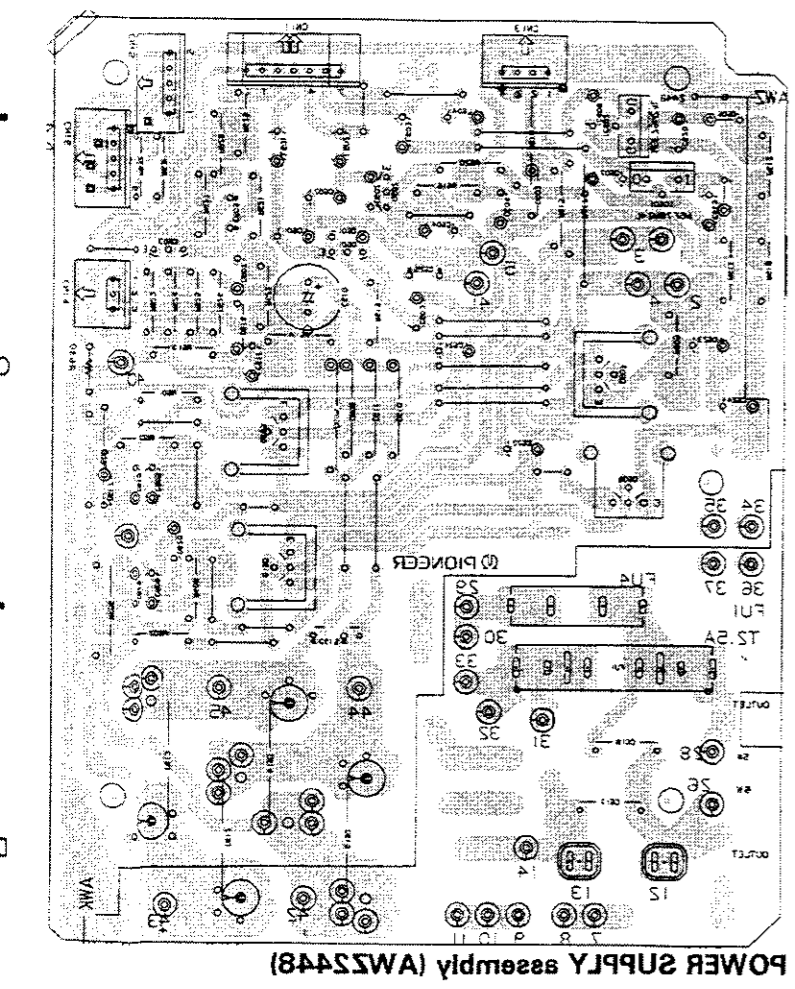
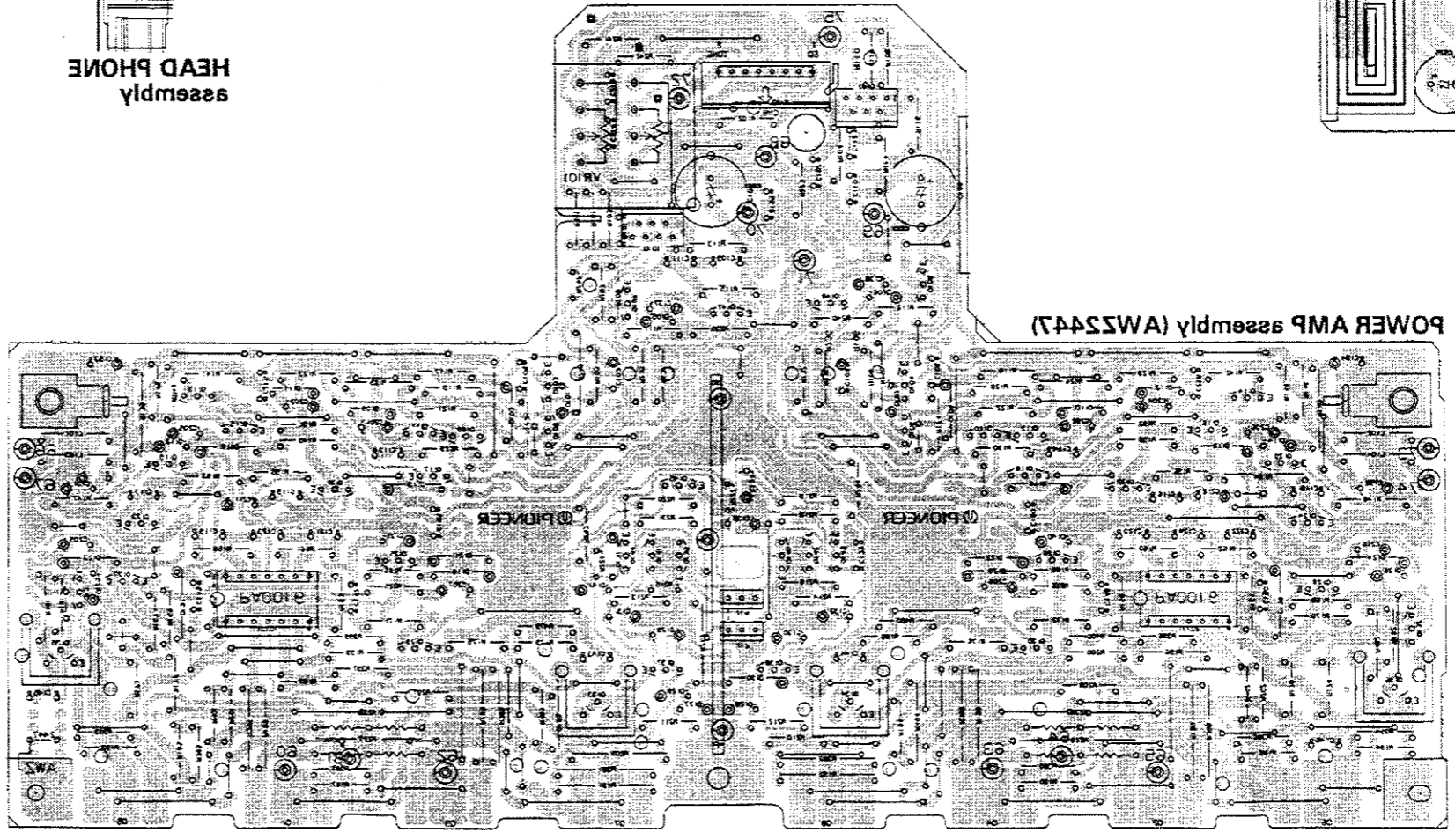
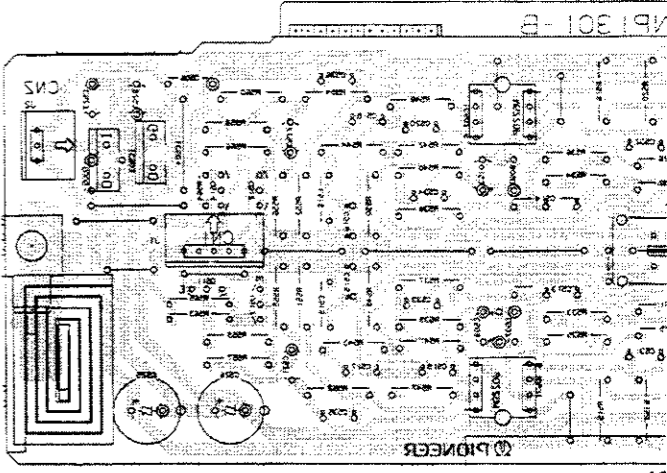

2.3 P.C. BOARD PATTERNS

A
B
C
D

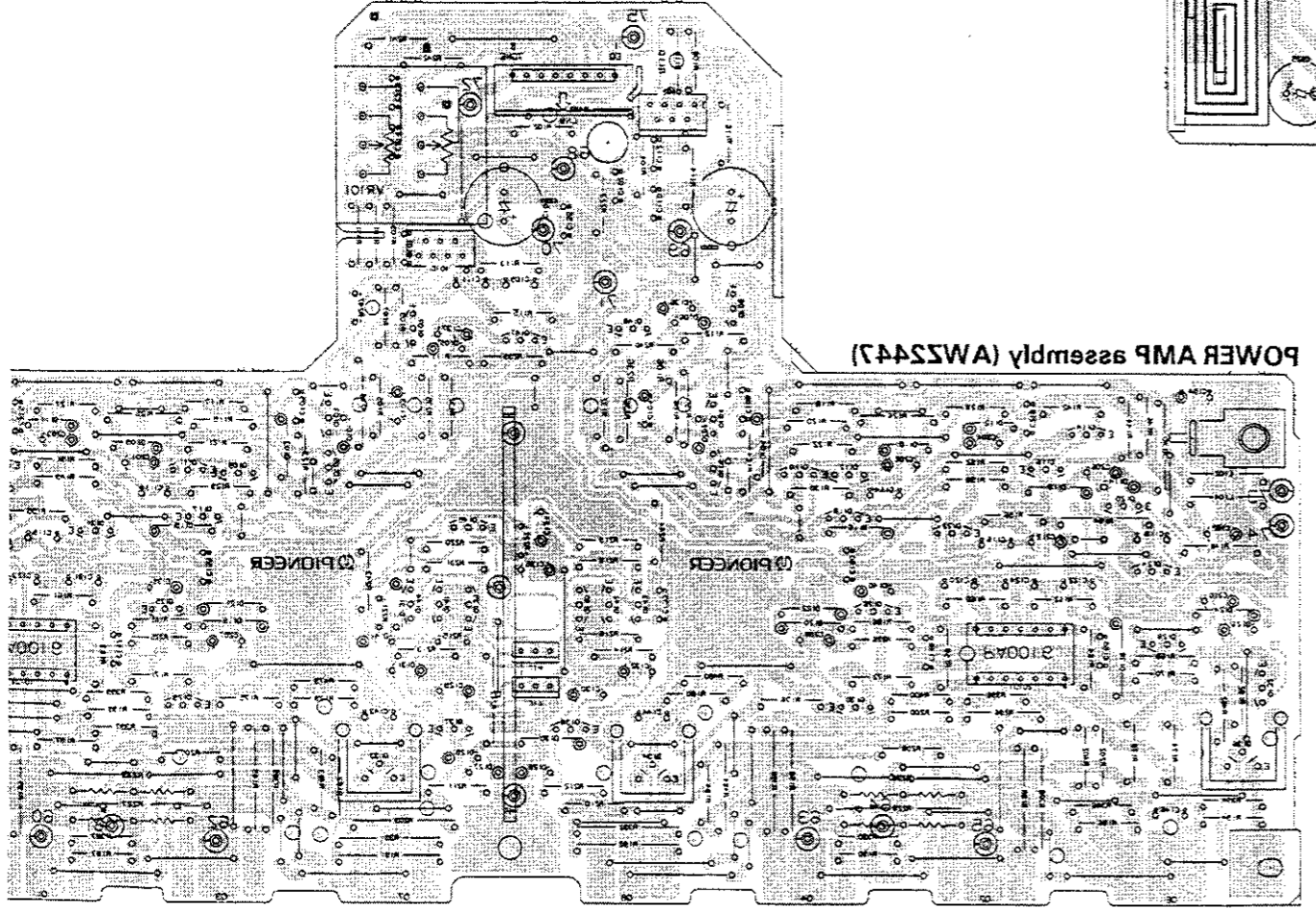
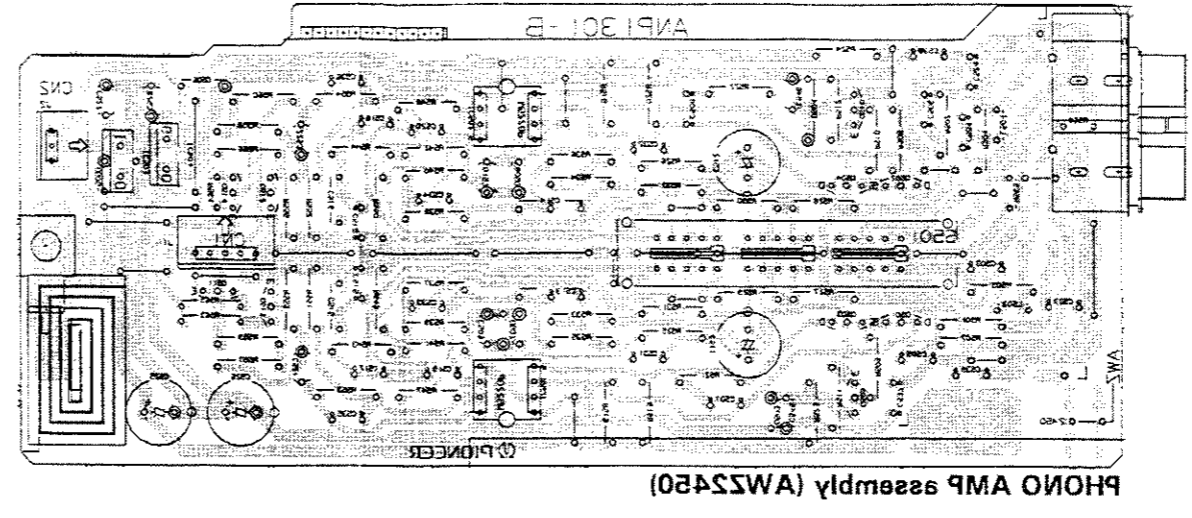
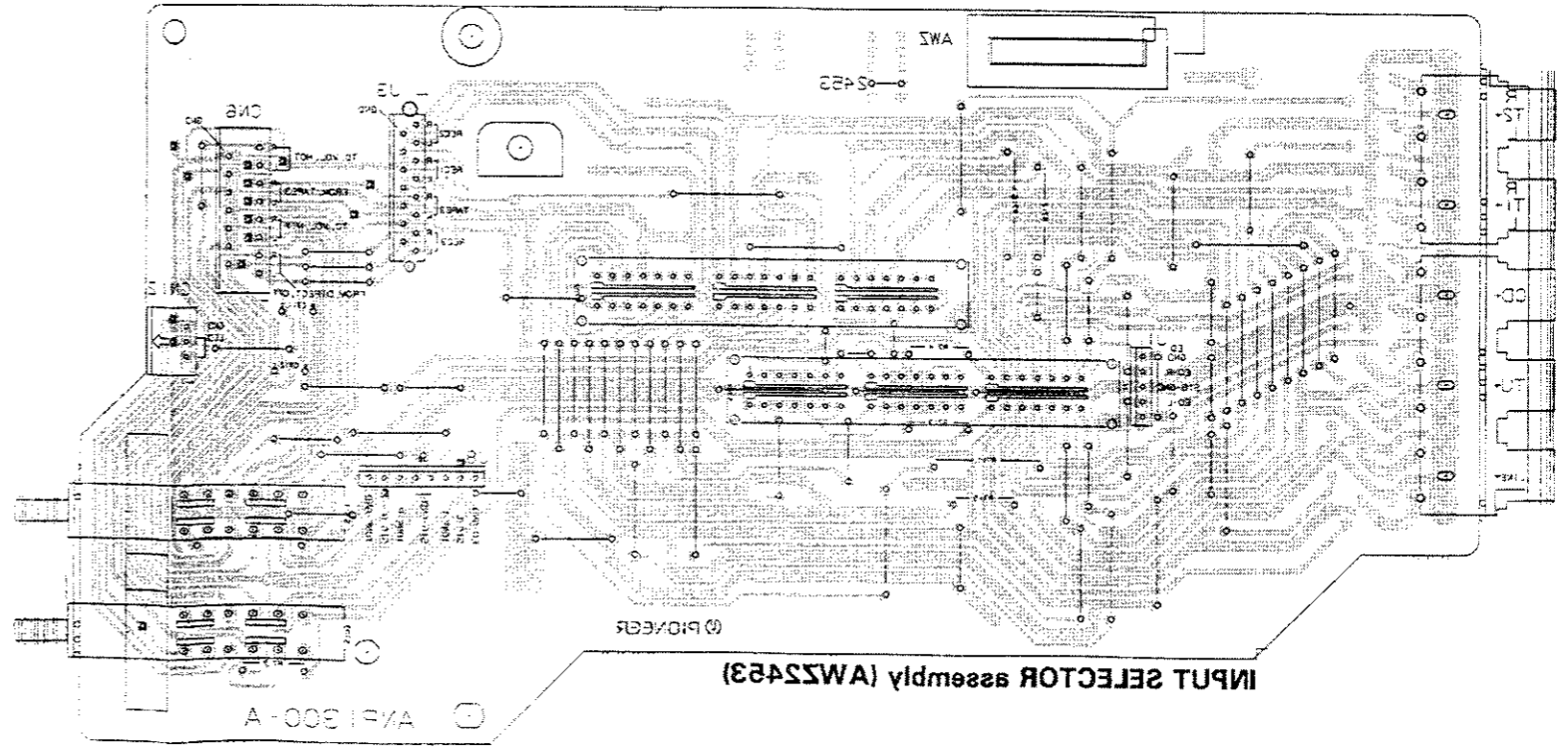
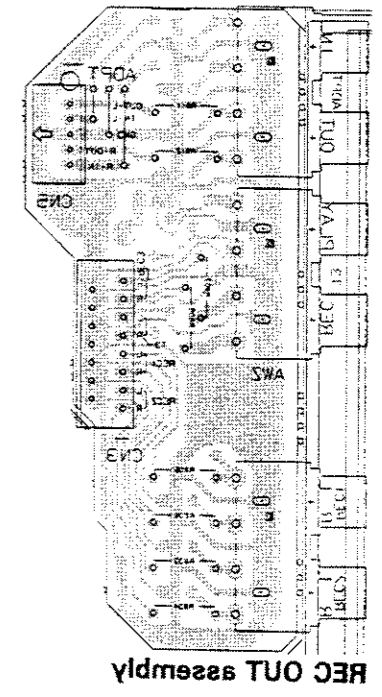

NOTE:
This picture shows the foil side of the printed circuit.

1 2 3 4 e

1 2 3 4 e

5.3 P.C. BOARD PATTERNS

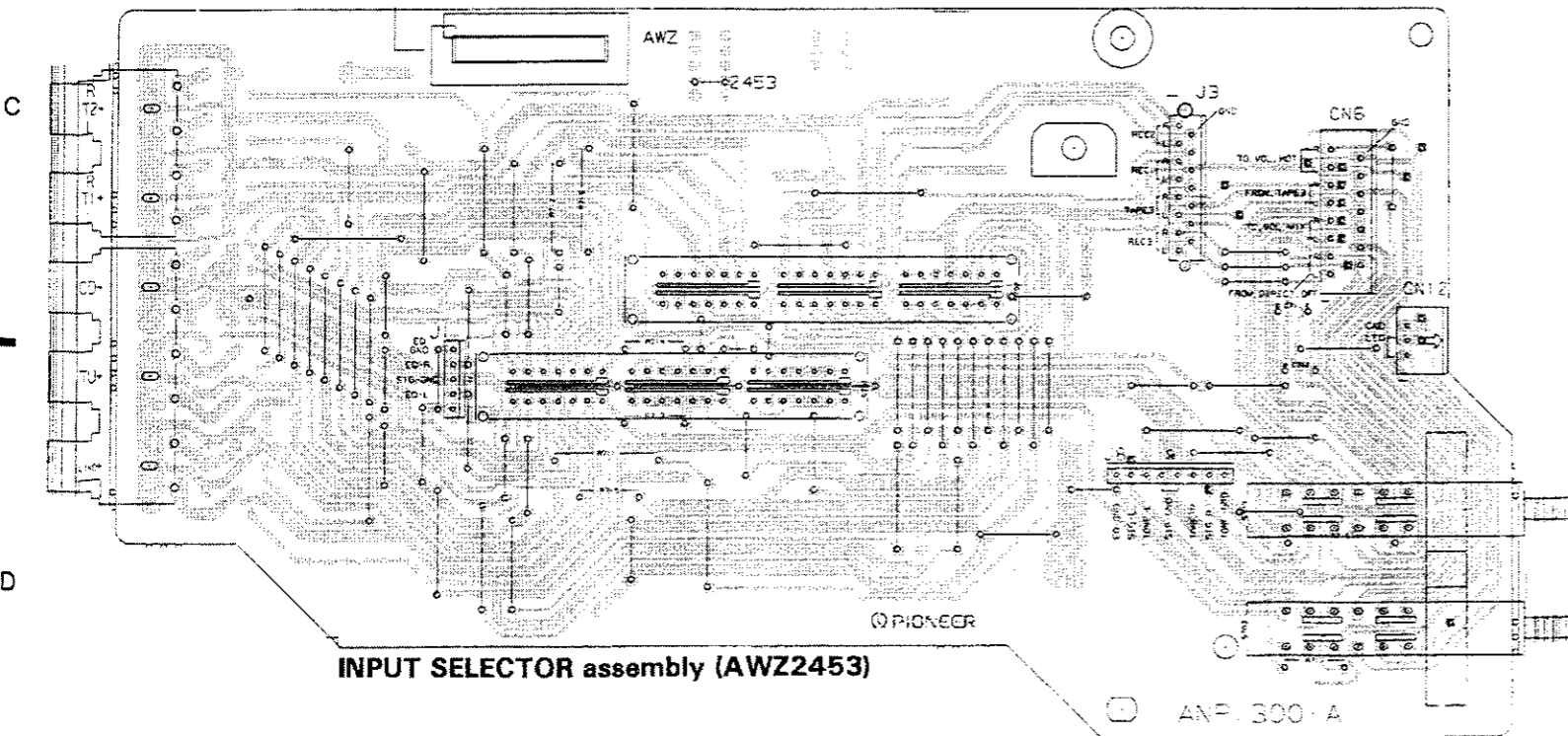
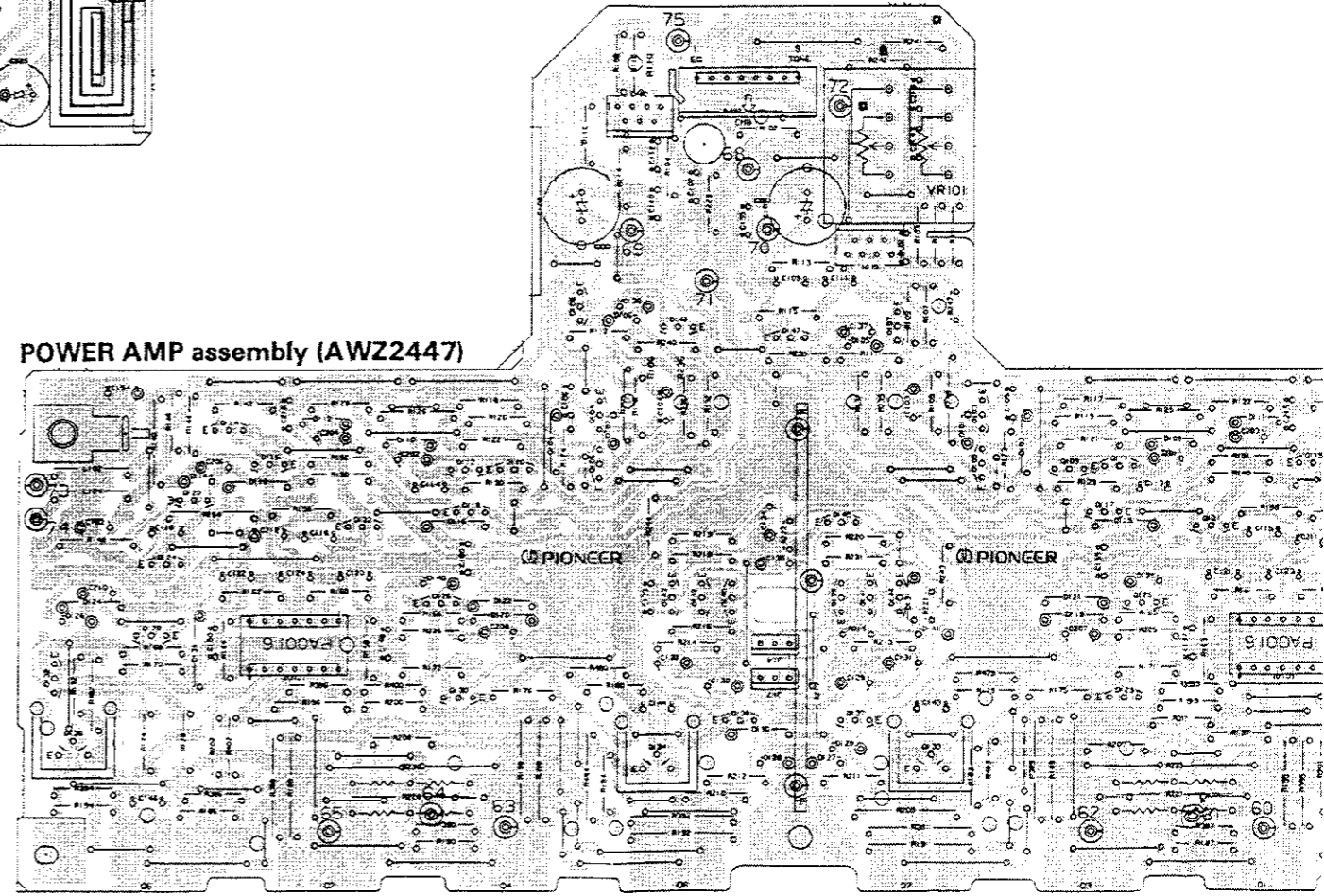
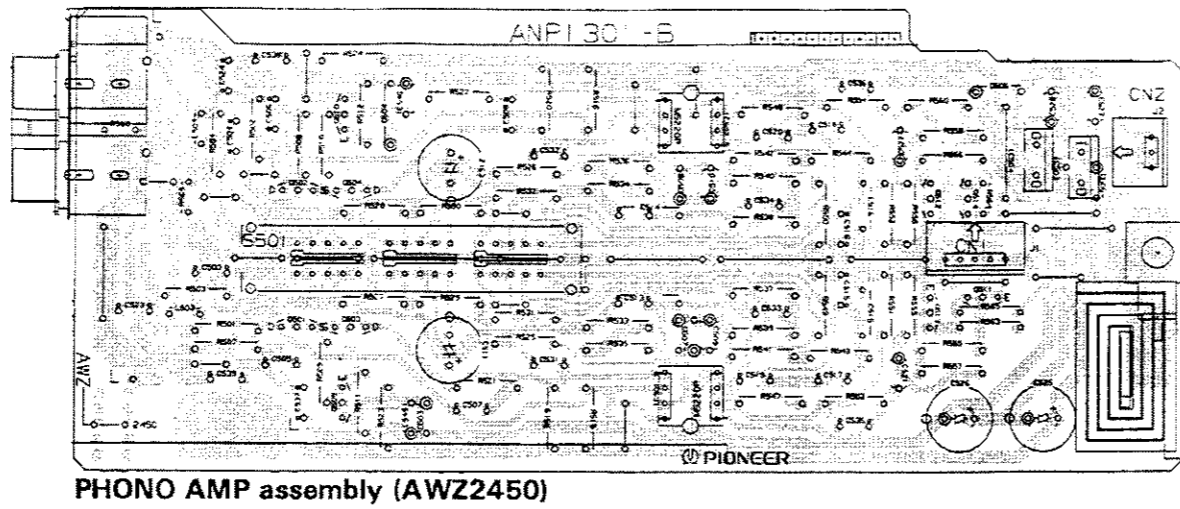
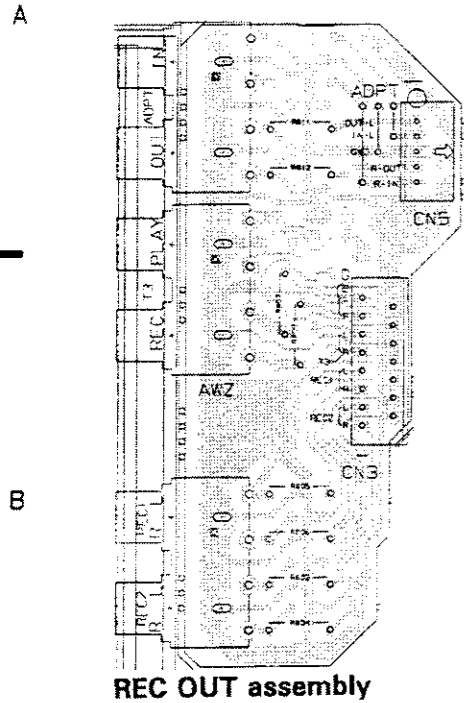

Q120	D114	D118	Q116	D112	D110	Q112	Q110	D104	Q104	Q106	D102	Q108	Q106	Q102	Q148	Q147	D105	Q101	Q107	Q103	Q105	D103	Q109	Q111	D109	D111	Q115	D126	D124	Q124	Q122	D140	Q126	D116	Q118	Q143	Q142	Q140	Q145	Q139	Q141	Q144	D131	D121	D119	Q117	D139	Q25	Q121	Q132	Q136	Q128	D138	IC102	Q130	Q122	D120	Q134	Q138	D130	D128	D127	D129	Q137	D141	Q133	Q129	IC101
------	------	------	------	------	------	------	------	------	------	------	------	------	------	------	------	------	------	------	------	------	------	------	------	------	------	------	------	------	------	------	------	------	------	------	------	------	------	------	------	------	------	------	------	------	------	------	------	-----	------	------	------	------	------	-------	------	------	------	------	------	------	------	------	------	------	------	------	------	-------

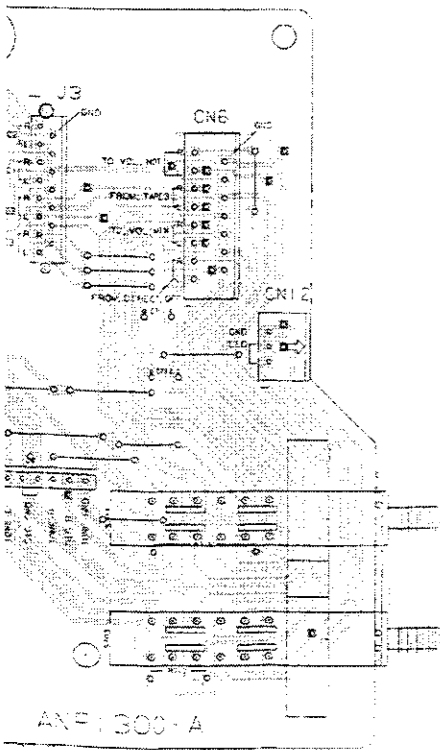
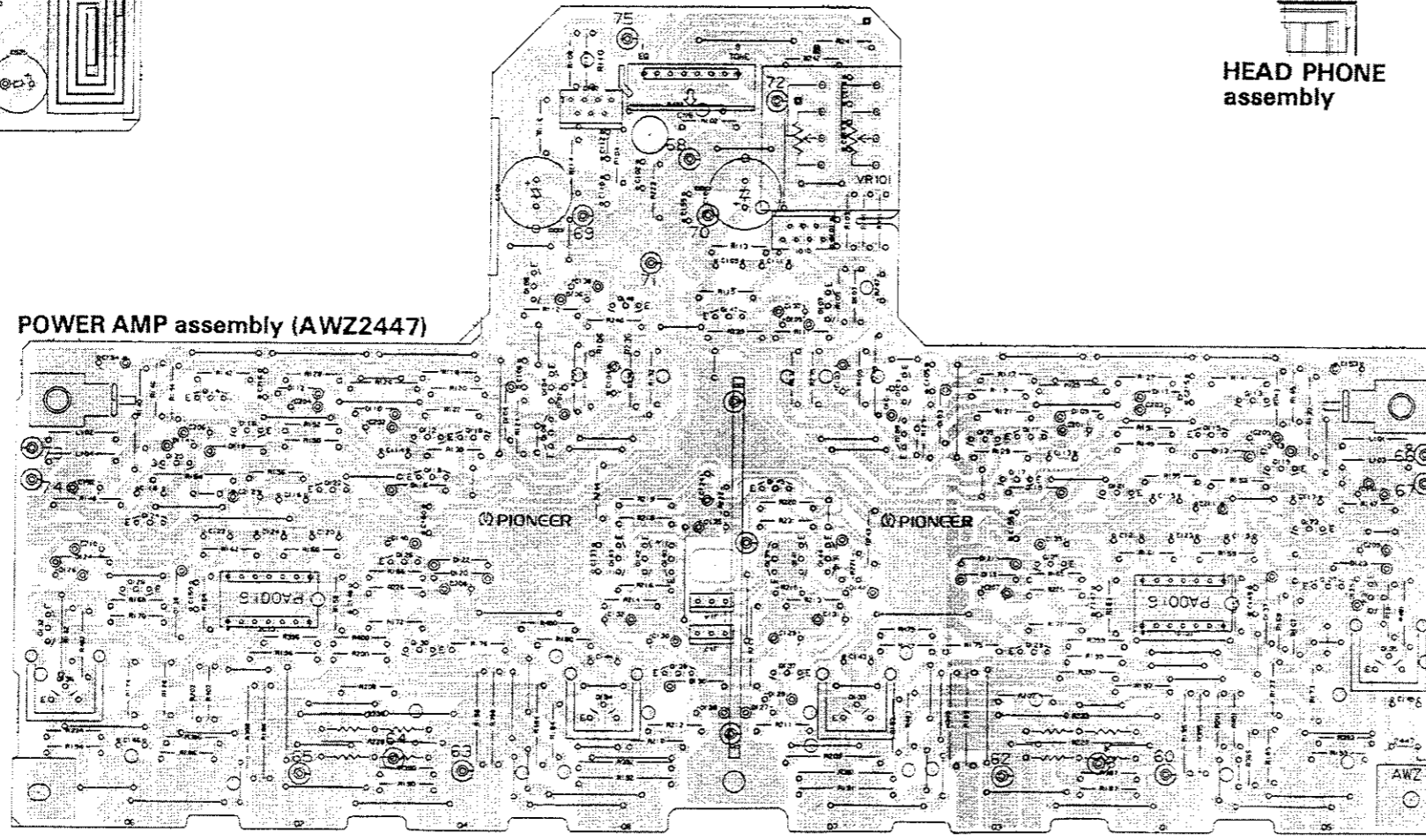
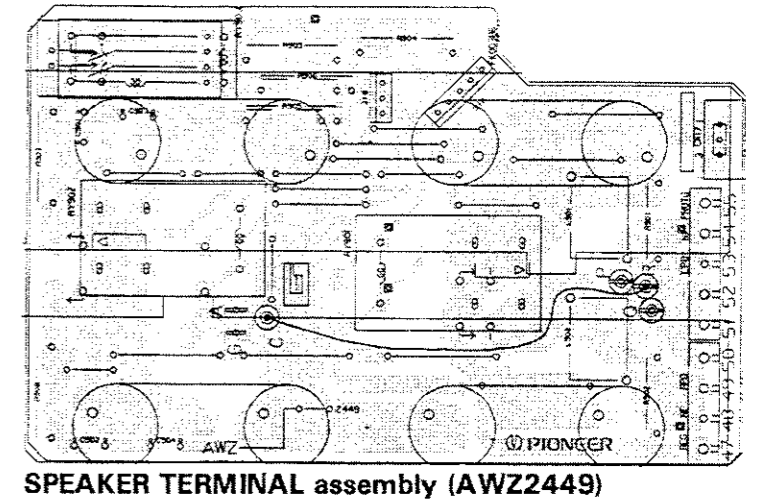
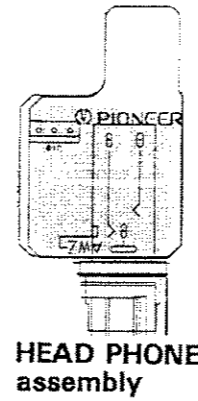
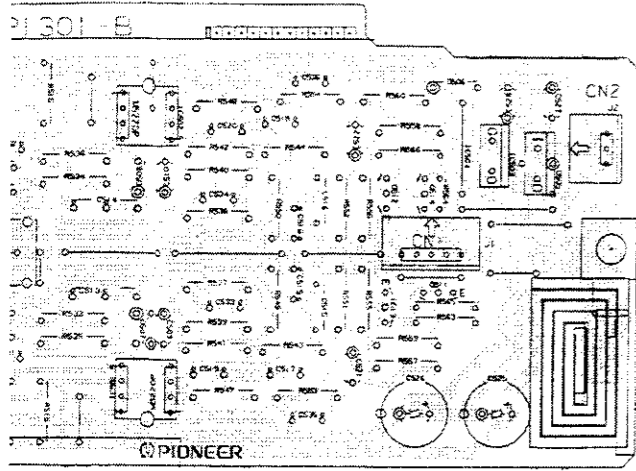

Q108 D106 Q102 Q148 Q147 D105 Q101 Q107
 Q120 D114 Q114 D118 Q116 D112 D110 Q112 Q110 D104 Q104 Q106 Q102 Q103 Q105 Q103 Q109 Q111 D109 D111 Q115 D117 Q113 D113 Q119
 Q126 D124 Q124 Q122 D140 Q126 D116 Q118 Q143 Q142 Q140 Q145 Q139 Q141 Q144 D131 D121 D119 Q117 D139 Q125 Q121 Q123 Q127 D123
 Q132 Q136 Q128 D138 IC102 Q130 D122 D120 Q134 Q138 D130 D128 D127 D129 Q137 D141 Q135 Q129 IC101 Q137 Q125 Q131 Q135

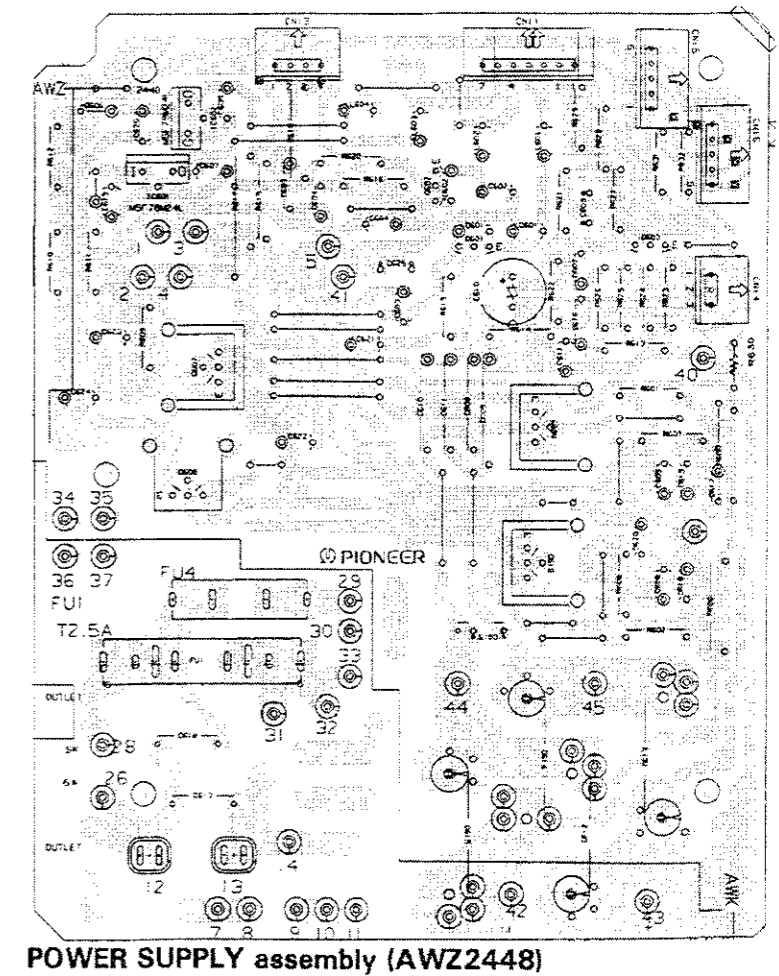

SWITCHES

Mark	Symbol & Description	Part No.
	S304 Tact switch (MUTING)	ASG-711
	S301,S302 Push switch (TAPE 3, LOUDNESS)	ASG1019
	S303 Push switch (EQ.POWER)	ASG1021

CAPACITORS

Mark	Symbol & Description	Part No.
	C321,C322	CCCSL390J50
	C303,C304	CCCSL470J50
	C343	CEASOR1M50
	C341,C342	CEASO10M50
	C339,C340	CEAS100M25
	C301,C302,C305,C306,C317,C318	CEAS2R2M50
	C336	CEAS221M10
	C333,C334	CEAS221M25
	C331,C332	CEAS470M25
	C329,C330	CFTXA104J50
	C309,C310	CFTXA153J50
	C315,C316	CFTXA183J50
	C311,C312,C327,C328	CFTXA823J50
	C347,C348	CKCYB222K50
	C349,C350	CKCYB392K50
	C345,C346	CKCYF103Z50
	C313,C314	CQMA332K50

RESISTORS

Mark	Symbol & Description	Part No.
	VR301 (250k x 2)	ACT1053
	VR302,VR303 (100k x 2)	ACT1054
	R367	RD1/2PM103J
	R355,R356,R368-R380	RD1/8PM□□□J
	Other resistors	RD1/4PM□□□J

REC OUT assembly

CAPACITORS

Mark	Symbol & Description	Part No.
	C803-C814	CKCYB331K50

RESISTORS

Mark	Symbol & Description	Part No.
	R803-R806,R811-R814	RD1/4PM□□□J
	R807-R810	RD1/8PM□□□J

OTHERS

Mark	Symbol & Description	Part No.
	Terminal 4P (TAPE 1-3,ADAPTER)	AKB1009

INPUT SELECTOR assembly (AWZ2347)

SWITCHES

Mark	Symbol & Description	Part No.
	S703 Push switch (LINE DIRECT)	ASG1032
	S701,S702 Remote slide switch (FUNCTION SEL., REC SEL.)	ASU1016

CAPACITORS

Mark	Symbol & Description	Part No.
	C701-C704,C707-C710	CKCYB331K50
	C711,C712	CKCYB391K50
	C705,C706	CKCYB331K500

RESISTORS

Mark	Symbol & Description	Part No.
	R701-R712	RDR1/4PM221J
	R713-R718	RD1/4PM221J

OTHERS

Mark	Symbol & Description	Part No.
	Terminal 4P (TAPE 1,TAPE 2)	AKB1007
	Terminal 6P (CD,TUNER,LINE)	AKB1029

POWER AMP assembly (AWZ2330)

SEMICONDUCTORS

Mark	Symbol & Description	Part No.
	IC101,IC102	PA0016
	Q143	2SA1115
	Q117,Q118,Q125,Q126,Q131,Q132	2SA1145
	Q135,Q136	2SA1306
	Q113-Q116,Q123,Q124	2SA992
	Q145	2SC1815
	Q103-Q112,Q121,Q122,Q137,Q138,Q147,Q148	2SC1845
	Q139-Q142,Q144	2SC2458
	Q119,Q120,Q127-Q130	2SC2705
	Q133,Q134	2SC3298
	Q101,Q102	2SK389
	D131 Zener diode	RD11ESB
	D105,D106 Zener diode	RD7.5ESB3
	D101-D104,D109-D130,D137-D140,D141	1SS252

COILS

Mark	Symbol & Description	Part No.
	L101-L104 (Bead filter)	ATX1012

CAPACITORS

Mark	Symbol & Description	Part No.
	C139-C142	CCCSL221J50

4. ELECTRICAL PARTS LIST

NOTES:

- Parts without part number cannot be supplied.
- Parts marked by "⊙" are not always kept in stock. Their delivery time may be longer than usual or they may be unavailable.
- The Δ mark found on some component parts indicates the importance of the safety factor of the part. Therefore, when replacing, be sure to use parts of identical designation.
- When ordering resistors, first convert resistance values into code form as shown in the following examples.

Ex. 1 When there are 2 effective digits (any digit apart from 0), such as 560 ohm and 47k ohm (tolerance is shown by J = 5%, and K = 10%).

560 Ω	56×10^1	561.....	RD1/4PS	Δ	Δ	Δ	J
47k Ω	47×10^3	473.....	RD1/4PS	Δ	Δ	Δ	J
0.5 Ω	0R5.....		RN2H	Δ	Δ	Δ	K
1 Ω	010.....		RSIP	Δ	Δ	Δ	K

Ex. 2 When there are 3 effective digits (such as in high precision metal film resistors).

5.62k Ω	562×10^1	5621.....	RN1/4SR	Δ	Δ	Δ	F
----------------	-------------------	-----------	---------	----------	----------	----------	---

Miscellaneous parts

P.C. BOARD ASSEMBLIES

Mark	Symbol & Description	Part No.
	SPEAKER SWITCH assembly	
	TONE AMP assembly	AWZ2345
	REC OUT assembly	
	INPUT SELECTOR assembly	AWZ2347
	POWER AMP assembly	AWZ2330
	POWER SUPPLY assembly	AWZ2331
	SPEAKER TERMINAL assembly	AWZ2332
	PHONO AMP assembly	AWZ2333
	HEAD PHONE assembly	
	SHIELD assembly	

OTHERS

Mark	Symbol & Description	Part No.
Δ	Q3-Q6 Transistor	2SA1265N
Δ	Q1,Q2,Q7,Q8 Transistor	2SC3182N
Δ	S1 Push switch (POWER)	ASG-553
	S3 Remote slide rotary switch	ASU1024
	S2 Remote slide rotary switch	ASU1025
	S4 Remote slide rotary switch	ASU1026
Δ	T1 Power transformer (AC220V/240V)	ATS1087
Δ	T2 Power transformer (AC220V/240V)	ATS1088
Δ	FU1 Fuse (T4A/250V)	AEK-400
Δ	C3 Electrolytic capacitor (22000 μ F/63)	ACH1045
Δ	R2 Carbon film resistor	RD1/4PM100J
Δ	R1 Carbon film resistor	RD1/4PM4R7J
Δ	AC Power cord	ADG1049
	Strain relief	AEC-882

SPEAKER SWITCH assembly SWITCH

Mark	Symbol & Description	Part No.
	S401 Rotary switch (SPEAKERS)	ASD1003

CAPACITORS

Mark	Symbol & Description	Part No.
	C401,C402	CEAS3R3M50

RESISTORS

Mark	Symbol & Description	Part No.
	R451 - R453	RD1/2PM
	R454,R455	RD1/4PM561J

TONE ANP assembly (AWZ2345)

SEMICONDUCTORS

Mark	Symbol & Description	Part No.
	IC301	M5220P
	Q306	2SA1048
	Q301 - Q305	2SC2458
	Q307,Q308	2SC1845
	D301,D303,D305,D306	AEL1004
	LED assembly	
	D304 LED	AEL1005
	D302 LED	AEL1004
	D308 Zener diode	RD2.0:SB
	D310 Zener diode	RD5.6:SB
	D307,D309,D311 - D313	1SS25Z

COILS

Mark	Symbol & Description	Part No.
	L901,L902 AF Choke coil (2.7 μ H)	ATH1021

CAPACITORS

Mark	Symbol & Description	Part No.
	C909,C910	CCDSL101K500
	C901 - C904	CFTXA104J50
	C905 - C908	CQMXA472J100

RESISTORS

Mark	Symbol & Description	Part No.
\triangle	R901,R902	RS1LMF101J
\triangle	R905,R906	RS1PMF681J
\triangle	R903,R904,R907,R908	RS2LMF□□□J

OTHER

Mark	Symbol & Description	Part No.
	Terminal 4P (SPEAKER)	AKE1006

PHONO AMP assembly (AWZ2333)

SEMICONDUCTORS

Mark	Symbol & Description	Part No.
	IC503	M5F78M24L
	IC504	M5F79M24L
	IC501,IC502	M5220P
	Q509,Q510	2SC1845
	Q511 - Q514	2SC3327
	Q501 - Q504	2SK369
	D503,D504 Zener diode	RD7.5ESB2
	D507,D508	MA859
	D505,D506	1SS252

SWITCH

Mark	Symbol & Description	Part No.
	S501 Remote slide switch (PHONO SEL.)	ASU1008

COILS

Mark	Symbol & Description	Part No.
	L501,L502 (560 μ H)	ATH1024
	L503,L504 (2.2 μ H)	LAU2R2M

CAPACITORS

Mark	Symbol & Description	Part No.
	C535,C536,C505,C506	CCCSL221K500
	C531,C532	CCCSL271K500
	C545,C546	CEAS470M10
	C521,C522	CEXA220M25
	C527,C528	CEXA220M50
	C523,C524	CCDSL390J50

Mark	Symbol & Description	Part No.
	C511,C512,C526	CEXA221M25
	C509,C510	CEXA470M25
	C525	CEXA471M25
	C503,C504	CFTXA103J50
	C517,C518	CFTXA224J50
	C519,C520	CFTXA563J50
	C507,C508	CKCYB222K500
	C533,C534	CKCYB681K500
	C537,C538	CKCYF103Z50
	C539	CKDYF103Z50
	C513,C514	CQPXA224J2A
	C515,C516	CQPXA333J2A

RESISTORS

Mark	Symbol & Description	Part No.
	R505,R506,R563 - R566,R568, R569	RD1/8PM□□□J
	R501 - R504,R507,R508, R527 - R544	RDR1/4PM□□□J
	Other resistors	RD1/4PM□□□J

OTHERS

Mark	Symbol & Description	Part No.
	Terminal 1P (PHONO L)	AKB1027
	Terminal 1P (PHONO R)	AKB1028

HEAD PHONE assembly

CAPACITORS

Mark	Symbol & Description	Part No.
	C951,C952	CKCYB392K50

OTHERS

Mark	Symbol & Description	Part No.
	Jack (HEAD PHONE)	AKN1002

SHIELD assembly

No parts are supplied with SHIELD assembly

Mark	Symbol & Description	Part No.
	C113,C114	CCCSL271J50
	C135	CEASR47M100
	C129,C130	CEAS010M50
	C155	CCDSL151J50
	C134	CEAS101M16
	C131,C132	CEAS471M6
	C137,C138	CEEA221M16
	C107,C108	CEEA471M50
	C201-C206	CEYA330M16
	C103,C104	CFTXA473J50
	C147-C150	CKCYB102K50
	C133	CKCYF103Z50
	C207-C212	CKDYF103K50
	C213,C214	CKDYF102Z50
	C215,C216	CMA030D500
	C115-C118,C123,C124, C143-C146,C159,C160	CMA101J500
	C111,C112	CMA150J500
	C101,C102	CMA221J500
	C109,C110	CMA120J500
	C119-C122	CMA680J500
	C105,C106	CQMXA102J100
	C151-C154	CQMXA562J100

RESISTORS

Mark	Symbol & Description	Part No.
	VR101 (60k × 2)	ACW1007
△	R227-R230 (0.33 × 2) R113-R116 R101-R104,R111,R112,R123, R124,R129,R130,R223, R239-R246,R491,R492	ACN-139 RDR1/2PM□□□J RDR1/4PM□□□J
△	R131,R132,R235,R236 R247-R250	RD1/2PM□□□J RDR1/6PU101J
	R105-R110,R117-R122, R143-R146,R157-R164,R169, R170,R211-R214,R218-R220, R225,R226,R231	RD1/4PM□□□J
△	R125-R128,R139-R142,R149, R150,R153-R156,R183-R186 R195-R202,R385,R386 R395-R402,R483,R484 R215,R216,R221,R222	RFA1/4PS□□□J RD1/8PM□□□J
△	Other resistors	RD1/4PMF□□□J

POWER SUPPLY assembly (AWZ2331)**SEMICONDUCTORS**

Mark	Symbol & Description	Part No.
	IC601	M5F78M24L
	IC602	M5F79M24L

Mark	Symbol & Description	Part No.
	Q602,Q603	2SA1145
	Q608	2SA965
	Q610	2SB750A
	Q601	2SC2705
	Q607	2SC3298
	Q609	2SD836A
	D607 Zener diode	RD18ESB
	D606 Zener diode	RD2.7ESB
	D617-D620 Zener diode	RD24ESB1
	D603,D604 Zener diode	RD39ESB1
	D610,D611,D608,D609	S5566
	D601,D602,D616	1SS252
	D612-D615	30DF2FC-2

COILS

Mark	Symbol & Description	Part No.
	L601-L604 Inductor (10mH)	LTA103J

CAPACITORS

Mark	Symbol & Description	Part No.
△	C617,C618 (0.01/400V) C607,C608 C619,C620 C604-C606,C621-C624 C610	ACG1003 CEAS010M50 CEAS100M50 CEAS101M50 CEAS101M63
	C611 C601-C603 C609 C625 C615	CEAS3R3M50 CEAS470M50 CKCYB471K50 CKCYX473M25 CQMXA104J100

RESISTORS

Mark	Symbol & Description	Part No.
△	R613,R614,R622	RD1/2PM□□□J
△	R615,R616	RD1/4PMF391J
△	R608	RD1/4PM821J
△	R601,R602,R611,R612,R619, R620	RFA1/4PS□□□J
△	R605,R606 R617,R618	RS2LMF562J RS2LMF272J
	Other resistors	RD1/4PM□□□J

SPEAKER TERMINAL assembly (AWZ2332)**RELAYS**

Mark	Symbol & Description	Part No.
	RY901,RY902 Relay	ASR1026
	RY903 Relay	ASR1014

5. FOR HE TYPE

5.1 CONTRAST OF MISCELLANEOUS PARTS

NOTES:

- Parts without part number cannot be supplied.
- The Δ mark found on some component parts indicates the importance of the safety factor of the part. Therefore, when replacing, be sure to use parts of identical designation.
- Parts marked by "©" are not always kept in stock. Their delivery time may be longer than usual or they may be unavailable.

The A-757/HE type is the same as the A-757/HEZ type with the exception of the following sections.

Mark	Symbol & Description	Part No.		Remarks
		A-757/HEZ type	A-757/HE type	
	REC OUT assembly	Non supply	Non supply	
	INPUT SELECTOR assembly	AWZ2347	AWZ2453	
	POWER AMP assembly	AWZ2330	AWZ2447	
	POWER SUPPLY assembly	AWZ2331	AWZ2448	
	SPEAKER TERMINAL assembly	AWZ2332	AWZ2449	
	PHONO AMP assembly	AWZ2333	AWZ2450	
	HEAD PHONE assembly	Non supply	Non supply	
Δ	R2 Carbon film resistor	RD1/4PM100J	
Δ	R1 Carbon film resistor	RD1/4PM4R7J	
	Operating instructions (German)	ARC1146	
	Operating instructions (English, German, French, Italian, Dutch, Swedish, Spanish, Portuguese)	ARE1126	

REC OUT assembly

The REC OUT assembly (HE type) is the same as the REC OUT assembly (HEZ type) with the exception of the following sections.

Mark	Symbol & Description	Part No.		Remarks
		HEZ type	HE type	
	C803-C814	CKCYB331K50	
	R803-R806,R811,R812	RD1/4PM182J	RD1/4PM222J	
	R807,R808	RD1/8PM182J	RD1/8PM222J	
	R809,R810	RD1/8PM221J	
	R813,R814	RD1/4PM221J	

INPUT SELECTOR assembly (AWZ2453)

The INPUT SELECTOR assembly (AWZ2453) is the same as the INPUT SELECTOR assembly (AWZ2347) with the exception of the following sections.

Mark	Symbol & Description	Part No.		Remarks
		AWZ2347	AWZ2453	
	C701,C704,C707-C710	CKCYB331K50	
	C705,C706	CKCYP331K500	
	R701-R710	RDR1/4PM221J	

POWER AMP assembly (AWZ2447)

The POWER AMP assembly (AWZ2447) is the same as the POWER AMP assembly (AWZ2330) with the exception of the following sections.

Mark	Symbol & Description	Part No.		Remarks
		AWZ2330	AWZ2447	
	C113,C114	CCCSL271J50	CKCYB561K50	
	C139-C142	CCCSL221J50	
	C151-C154	CQMXA582J100	CEXA2R2M2A	
	C155	CCDSL151J50	
Δ	R245,R246	RD1/4PM100J	
Δ	R171-R174	RD1/4PMF181J	RFA1/4PS101J	
Δ	R175-R178	RD1/4PMF821J	RFA1/4PS391J	
Δ	R179-R182	RD1/4PMF181J	RFA1/4PS181J	

POWER SUPPLY assembly (AWZ2448)

The POWER SUPPLY assembly (AWZ2448) is the same as the POWER SUPPLY assembly (AWZ2331) with the exception of the following sections.

Mark	Symbol & Description	Part No.		Remarks
		AWZ2331	AWZ2448	
Δ	C615	CQMXA104J100	ACG1005	
	R609,R610	RD1/4PM101J	RFA/4PS221J	
	D611,R612	RFA1/4PS221J	RD1/4PM101J	
	R626	RD1/4PM221J	RAF1/4PS221J	
	R630	RAF1/4PS470J	

SPEAKER TERMINAL assembly (AWZ2449)

The SPEAKER TERMINAL assembly (AWZ2449) is the same as the SPEAKER TERMINAL assembly (AWZ2332) with the exception of the following sections.

Mark	Symbol & Description	Part No.		Remarks
		AWZ2332	AWZ2449	
	C905-C908 C909,C910	CQMXA472J100 CCDSL101K500	

PHONO AMP assembly (AWZ2450)

The PHONO AMP assembly (AWZ2450) is the same as the PHONO AMP assembly (AWZ2333) with the exception of the following sections.

Mark	Symbol & Description	Part No.		Remarks
		AWZ2333	AWZ2450	
	L501,L502 (560 μ H) L503,L504	ATH1024 LAU2R2M	
	C505,C506 C523,C524	CCCSL221K500 CCDSL390J50	CCCSL271K500	
	R505,R506	RD1/BPM472J	

HEAD PHONE assembly

The HEAD PHONE assembly (HE type) is the same as the HEAD PHONE assembly (HEZ type) with the exception of the following sections.

Mark	Symbol & Description	Part No.		Remarks
		HEZ type	HE type	
	C951,C952	CKCYB392K50	

5. FOR HE TYPE

5.1 CONTRAST OF MISCELLANEOUS PARTS

NOTES:

- Parts without part number cannot be supplied.
- The \triangle mark found on some component parts indicates the importance of the safety factor of the part. Therefore, when replacing, be sure to use parts of identical designation.
- Parts marked by "⊙" are not always kept in stock. Their delivery time may be longer than usual or they may be unavailable.

The A-757/HE type is the same as the A-757/HEZ type with the exception of the following sections.

Mark	Symbol & Description	Part No.		Remarks
		A-757/HEZ type	A-757/HE type	
	REC OUT assembly	Non supply	Non supply	
	INPUT SELECTOR assembly	AWZ2347	AWZ2453	
	POWER AMP assembly	AWZ2330	AWZ2447	
	POWER SUPPLY assembly	AWZ2331	AWZ2448	
	SPEAKER TERMINAL assembly	AWZ2332	AWZ2449	
	PHONO AMP assembly	AWZ2333	AWZ2450	
	HEAD PHONE assembly	Non supply	Non supply	
\triangle	R2 Carbon film resistor	RD1/4PM100J	
\triangle	R1 Carbon film resistor	RD1/4PM4R7J	
	Operating instructions (German)	ARC1146	
	Operating instructions (English, German, French, Italian, Dutch, Swedish, Spanish, Portuguese)	ARE1126	

REC OUT assembly

The REC OUT assembly (HE type) is the same as the REC OUT assembly (HEZ type) with the exception of the following sections.

Mark	Symbol & Description	Part No.		Remarks
		HEZ type	HE type	
	C803-C814	CKCYB331K50	
	R803-R806,R811,R812	RD1/4PM182J	RD1/4PM222J	
	R807,R808	RD1/8PM182J	RD1/8PM222J	
	R809,R810	RD1/8PM221J	
	R813,R814	RD1/4PM221J	

INPUT SELECTOR assembly (AWZ2453)

The INPUT SELECTOR assembly (AWZ2453) is the same as the INPUT SELECTOR assembly (AWZ2347) with the exception of the following sections.

Mark	Symbol & Description	Part No.		Remarks
		AWZ2347	AWZ2453	
	C701,C704,C707-C710 C705,C706 R701-R710	CKCYB331K50 CKCYP331K500 RDR1/4PM221J	

POWER AMP assembly (AWZ2447)

The POWER AMP assembly (AWZ2447) is the same as the POWER AMP assembly (AWZ2330) with the exception of the following sections.

Mark	Symbol & Description	Part No.		Remarks
		AWZ2330	AWZ2447	
⚠ ⚠ ⚠ ⚠	C113,C114 C139-C142 C151-C154 C155 R245,R246 R171-R174 R175-R178 R179-R182	CCCSL271J50 CCCSL221J50 CQMXA562J100 CCDSL151J50 RD1/4PM100J RD1/4PMF181J RD1/4PMF821J RD1/4PMF181J	CKCYB581K50 CEXA2R2M2A RFA1/4PS101J RFA1/4PS391J RFA1/4PS181J	

POWER SUPPLY assembly (AWZ2448)

The POWER SUPPLY assembly (AWZ2448) is the same as the POWER SUPPLY assembly (AWZ2331) with the exception of the following sections.

Mark	Symbol & Description	Part No.		Remarks
		AWZ2331	AWZ2448	
⚠	C615 R609,R610 D611,R612 R626 R630	CQMXA104J100 RD1/4PM101J RFA1/4PS221J RD1/4PM221J	ACG1005 RFA/4PS221J RD1/4PM101J RAF1/4PS221J RAF1/4PS470J	

SPEAKER TERMINAL assembly (AWZ2449)

The SPEAKER TERMINAL assembly (AWZ2449) is the same as the SPEAKER TERMINAL assembly (AWZ2332) with the exception of the following sections.

Mark	Symbol & Description	Part No.		Remarks
		AWZ2332	AWZ2449	
	C905 - C908 C909, C910	CQMXA472J100 CCDSL101K500	

PHONO AMP assembly (AWZ2450)

The PHONO AMP assembly (AWZ2450) is the same as the PHONO AMP assembly (AWZ2333) with the exception of the following sections.

Mark	Symbol & Description	Part No.		Remarks
		AWZ2333	AWZ2450	
	L501, L502 (560 μ H) L503, L504	ATH1024 LAU2R2M	
	C605, C506 C523, C524	CCCSL221K500 CCDSL390J50	CCCSL271K500	
	R605, R506	RD1/8PM472J	

HEAD PHONE assembly

The HEAD PHONE assembly (HE type) is the same as the HEAD PHONE assembly (HEZ type) with the exception of the following sections.

Mark	Symbol & Description	Part No.		Remarks
		HEZ type	HE type	
	C951, C952	CKCYB392K50	

6. SPECIFICASIONS

[A-757]

Continuous power output (both channels driven at 20 Hz to 20 kHz) **	
T.H.D. 0.003%, 8 Ω	95W + 95W *
T.H.D. 0.005%, 4 Ω	140W + 140W *
DIN continuous power output (both channels driven)	
1 kHz, T.H.D. 1.0%, 8 Ω	100W + 100W
1 kHz, T.H.D. 1.0%, 4 Ω	150W + 150W
Power bandwidth	
0.05%, 8 Ω	5 Hz – 70 kHz *
Damping factor	
(1 kHz/20 Hz to 20 kHz), 8 Ω	200/70
Dynamic power output (on EIA dynamic test signal)	
4 Ω / 2 Ω	200W/300W
Total harmonic distortion **	
20 Hz to 20 kHz, 95W, 8 Ω	0.003% *
20 Hz to 20 kHz, 140W, 4 Ω	0.005% *
Inter-modulation distortion (at rated output)	0.003% *
Input sensitivity/impedance	
PHONO (MM)	2.5 mV/50 k Ω
PHONO (MC)	0.2 mV/100 Ω
CD, TUNER, LINE, TAPE	150 mV/50 k Ω
PHONO overload level	
1 kHz, T.H.D. 0.008% (MM/MC)	200 mV/19 mV
Output level/impedance	
TAPE REC, ADAPTOR OUTPUT	150 mV/2.2 k Ω
Frequency response	
PHONO (MM), 20 Hz to 20 kHz	± 0.2 dB
PHONO (MC), 20 Hz to 20 kHz	± 0.3 dB
CD, TUNER, LINE, TAPE (1 Hz to 150 kHz)	+0 -3 dB *

Tone control (volume control set at -40 dB position)

BASS	± 8 dB (100 Hz)
TREBLE	± 8 dB (10 kHz)
MUTING	-∞
Loudness contour (volume control set at -40 dB position)	
	+5 dB (100 Hz)/+3 dB (10 kHz)
Filter (SUBSONIC)	17 Hz (12 dB/oct.)
Signal-to-Noise ratio (IHF short circuit, A network)	
PHONO (MM, 5 mV input/MC, 0.5 mV input)	95 dB/77 dB *
CD, TUNER, LINE, TAPE	110 dB *
Signal-to-Noise ratio (DIN, continuous power/50 mW)	
PHONO (MM)	74 dB/65 dB *
CD, TUNER, LINE, TAPE	92 dB/68 dB *

Power Supply/Miscellaneous

Power requirements	a.c. 220 Volts ~, 50/60 Hz
Power consumption	820W
Dimensions	420 (W) × 435 (D) × 162 (H) mm
Weight (without package)	19.5 kg

Accessories

Operating instructions	1
Cushion spacer set	1

NOTE:

Specifications and design subject to possible modification without notice, due to improvements.

* Measured with the DIRECT switch set to ON.

** Measured by Audio Spectrum Analyzer.

Be sure to place the unit on a level surface so that it stands firmly on all its feet. If wobbly, adjust by attaching the supplied cushion spacers to one or more feet.

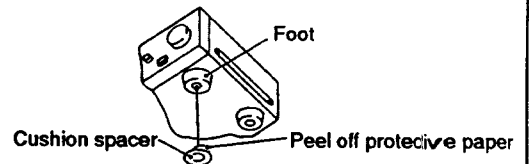

7. PANEL FACILITIES

The illustration shows model A-757.
Model A-656 is not equipped ⑦ and ⑬.

L'illustration montre le modèle A-757.
Le modèle A-656 n'est pas équipé des éléments ⑦ et ⑬.

Die Abbildung zeigt Modell A-757.
Modell A-656 ist nicht mit Bedienelementen ⑦ und ⑬
ausgestattet.

Il modello nell'illustrazione è l' A-757.
Il modello A-656 non possiede i No. ⑦ e ⑬.

De afbeelding toont model A-757.
Model A-656 is niet uitgerust met de bedieningsorganen
⑦ en ⑬.

På bildeln visas modell A-757.
Modell A-656 saknar ⑦ och ⑬.

Il modello nell'illustrazione è l' A-757.
Il modello A-656 non possiede i No. ⑦ e ⑬.

Esta ilustração mostra o modelo A-757.
O modelo A-656 não possui os recursos ⑦ e ⑬.

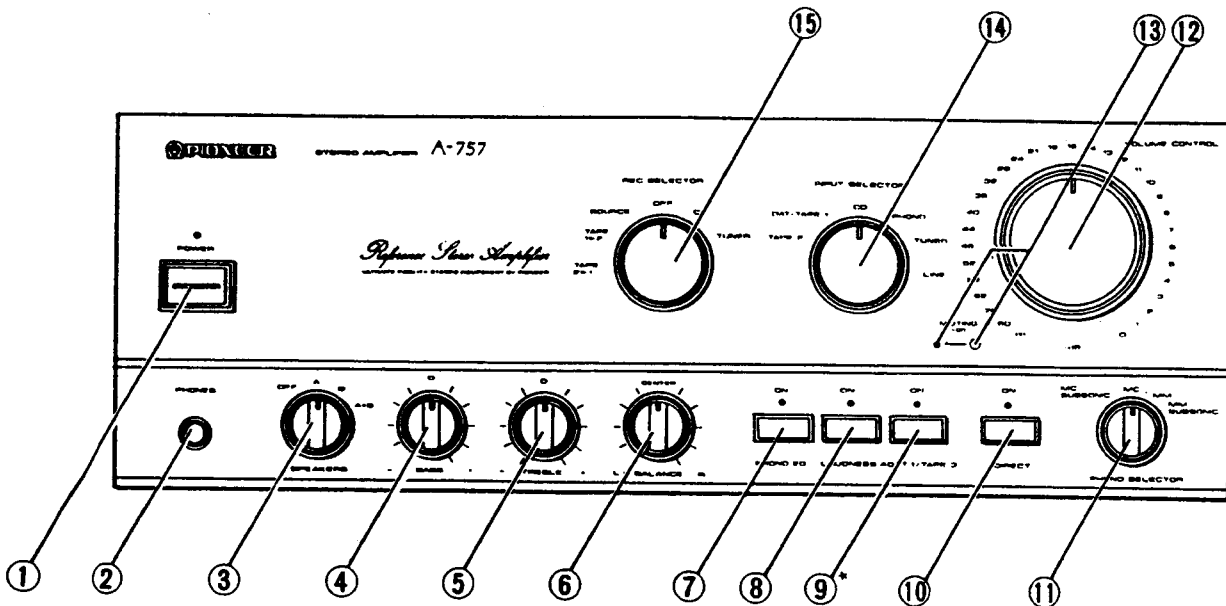

* A-656...ADPT/TAPE 3
A-757...ADPT 1/TAPE 3

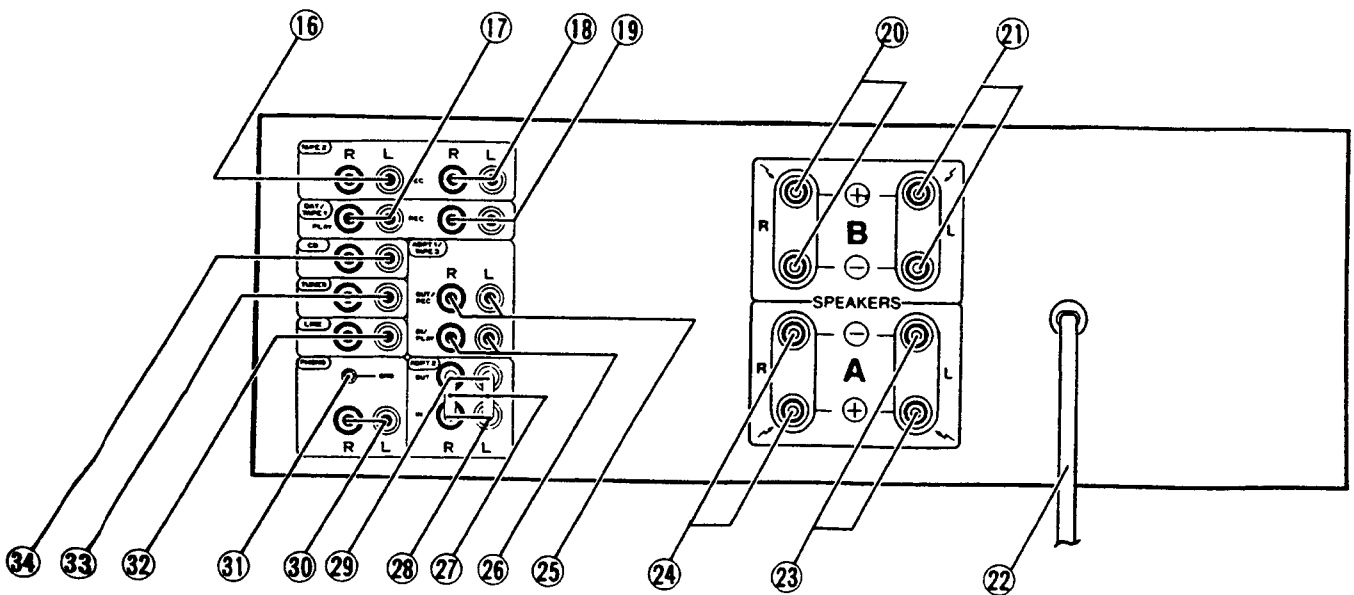

See page 2 for Panel Facilities.

[FRONT PANEL]

① POWER switch/Indicator

Press to turn power to the unit ON and OFF.
When the power is ON, indicator lights.

② PHONES jack

When using headphones, insert the plug into this jack.

③ SPEAKERS selector switch

Use this switch to listen to the speaker systems connected to the SPEAKERS terminals.

OFF:

Released position: No sound is heard from the speaker system.
Set to this position when listening with headphones.

A:

For reproduction of sound with the speaker systems connected to the SPEAKERS A terminals.

B:

For reproduction of sound with the speaker systems connected to the SPEAKERS B terminals.

A + B:

For reproduction of sound with the speaker systems connected to SPEAKERS A and B terminals.

④ BASS tone control

Use to adjust the low-frequency tone at low volume level. The center position is the flat (normal) position. When turned to the right, low-frequency tones are emphasized; when turned to the left, low-frequency tones are de-emphasized.

NOTE:

This function does not operate when the DIRECT switch is in the ON position.

⑤ TREBLE tone control

Use to adjust the high-frequency tone at low volume level. The center position is the flat (normal) position. When turned to the right, high-frequency tones are emphasized; when turned to the left, high-frequency tones are de-emphasized.

NOTE:

This function does not operate when the DIRECT switch is in the ON position.

⑥ BALANCE control

Should normally be left in the center position. Adjust balance if the sound is louder from one of the speakers. If the right side is louder, turn toward the LEFT position and if the left side is louder, turn toward the RIGHT position.

NOTE:

This function does not operate when the DIRECT switch is in the ON position.

⑦ PHONO EQ switch/Indicator (A-757 only)

When not using a phono input, turn the phono equalizer power circuit off in order to prevent it from collecting noise during playback of other sources.

ON:

The indicator lights: Always set to this position when using a phono input. Immediately after turning ON, audio signal will be muted for several seconds until circuit operation becomes stable.

OFF:

The indicator goes off: Set to this position when not using a phono input.

⑧ LOUDNESS switch/Indicator

Use when listening at low volume levels.

ON:

The indicator lights: Boosts low and high frequencies to give added punch to playback even at low-volume.

OFF:

The indicator goes off: Should normally be left in this position.

NOTE:

This switch does not operate when the DIRECT switch is in the ON position.

⑨ ADPT 1/TAPE 3 switch/Indicator (ADPT/TAPE 3 switch in the A-656)

Use this switch to listen to tape playback, or to listen to the sounds being recorded during tape recording.

ON:

The indicator lights: Press when listening to the playback sound of the tape deck or the adaptor connected to the ADPT 1/TAPE 3 IN/PLAY terminals, or to monitor the sound being recorded on the tape deck connected to the ADPT 1/TAPE 3 OUT/REC terminals.

OFF:

The indicator goes off: Normally leave the switch in this position.

NOTE:

When the DIRECT switch is set to ON, this function does not operate and no signal is output at the ADPT 1/TAPE 3 OUT/REC terminals.

⑩ DIRECT switch/Indicator

Use this switch when you do not wish to pass the output from input terminal equipment through the various frequency adjusting circuits and adaptor terminals (ADPT 1/TAPE 3, ADPT 2, BASS, TREBLE, BALANCE, LOUDNESS).

ON:

When the switch is in this position, the indicator lights and the signals input from the input terminals are reproduced without passing through the various frequency-adjusting circuits. This results in flat, pure sound which is a more faithful reproduction of the input source.

OFF:

When the switch is in this position the indicator goes out and the signal passes through the various frequency adjusting circuits.

⑪ PHONO SELECTOR switch

Set in accordance with the type of cartridge used in you turntable.

MM:

Set to this position when using a moving magnet cartridge, or a MC (moving coil) cartridge with high output of 1 mV or more.

MC:

Set to this position when using a moving coil cartridge.

MM SUBSONIC/MC SUBSONIC:

Subsonic filter for moving coil or moving magnet cartridges to cut ultralow frequency noise less than 17 Hz generated when playing a warped record.

When using a high-output moving coil cartridge, set this switch to MM or MM SUBSONIC.

⑫ VOLUME CONTROL

Use to adjust volume level.

NOTE:

This unit is equipped with a circuit that attenuates the effect of tone and loudness controls at volume is turned up.

⑬ MUTING switch/Indicator (A-757 only)

Use to temporarily cut sound volume.

ON:

The indicator lights. The sound volume will be cut off.

OFF:

The indicator goes off. The sound will return to its previous volume.

⑭ INPUT SELECTOR switch

Use to select playback source.

LINE:

Set to this position when listening to the programs from a component connected to the LINE terminals.

TUNER:

Set to this position when listening to AM or FM broadcasts with a tuner.

PHONO:

Set to this position when listening to record playback on a turntable.

CD:

Set to this position when listening to a compact disc playback with a CD player.

DAT/TAPE 1:

For playback with a tape deck or digital audio tape deck connected to the DAT/TAPE 1 terminals.

TAPE 2:

For playback with a tape deck connected to the TAPE 2 terminals.

⑮ REC SELECTOR switch

Switch to select recording signal. When set at other than SOURCE or OFF position, signals can be recorded during playback of the equipment selected by INPUT SELECTOR switch.

TUNER:

To record from a TUNER.

CD:

To record from a CD player.

OFF:

In this position nothing from the REC terminals of DAT/TAPE 1 and TAPE 2 will be output. Select it when not recording; output to tape decks will be disconnected, improving sound quality.

SOURCE:

To record the equipment selected by INPUT SELECTOR switch.

TAPE:**1 ► 2**

To record (copy) from the tape deck of DAT/TAPE 1 terminals, over to the tape deck of TAPE 2 terminals.

2 ► 1

To record (copy) from the tape deck of TAPE 2 terminals, over to the tape deck of DAT/TAPE 1 terminals.

NOTE:

The REC SELECTOR switch has no effect on the recording out put of the ADPT 1/TAPE 3 terminals.

[REAR PANEL]

⑮ TAPE 2 PLAY terminals.

⑰ DAT/TAPE 1 PLAY terminals.

⑱ TAPE 2 REC terminals.

⑲ DAT/TAPE 1 REC terminals.

⑳ SPEAKERS B terminals (right channel).

㉑ SPEAKERS B terminals (left channel).

㉒ Power cord.

Connect this cord to an AC wall socket, or the AC outlet of an audio timer.

㉓ SPEAKERS A terminals (left channel).

㉔ SPEAKERS A terminals (right channel).

㉕ ADPT 1/TAPE 3 OUT/REC terminals.

ADPT/TAPE 3 OUT/REC terminals. (A-656 only).

㉖ ADPT 1/TAPE 3 IN/PLAY terminals.

ADPT/TAPE 3 IN/PLAY terminals. (A-656 only).

㉗ Shorting bars. (A-757 only).

㉘ ADPT 2 IN terminals. (A-757 only).

㉙ ADPT 2 OUT terminals. (A-757 only).

㉚ PHONO terminals.

㉛ Turntable ground terminal (GND).

㉜ LINE terminals.

㉝ TUNER terminals.

㉞ CD terminals.