

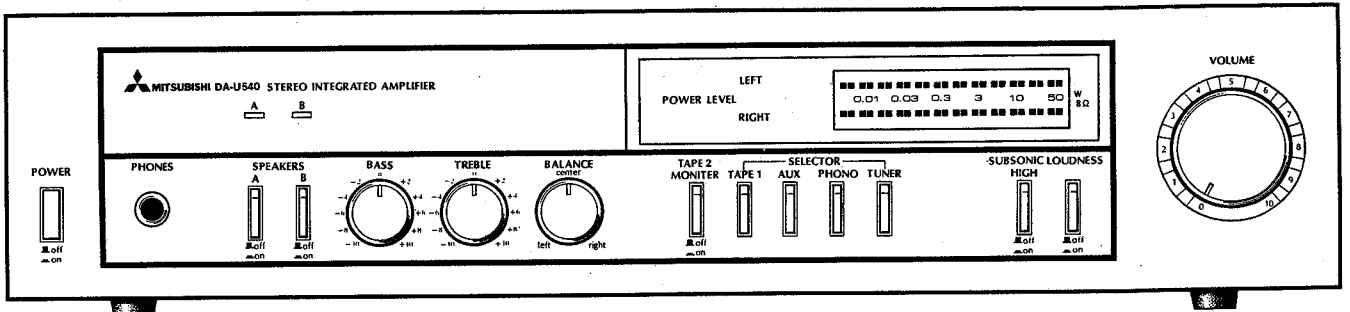

SERVICEANLEITUNG

INTEGRIERTER STEREO-VERSTÄRKER

MODELL DA-U540/U640



DA-U540

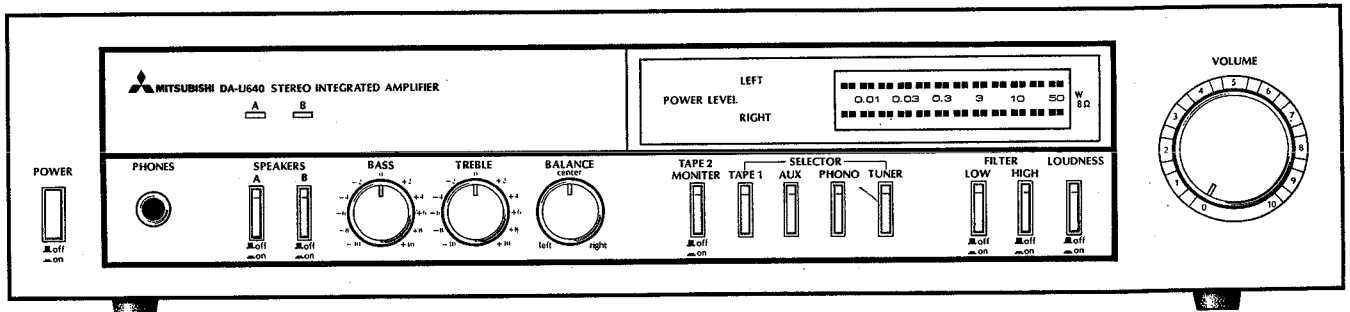

DA-U640

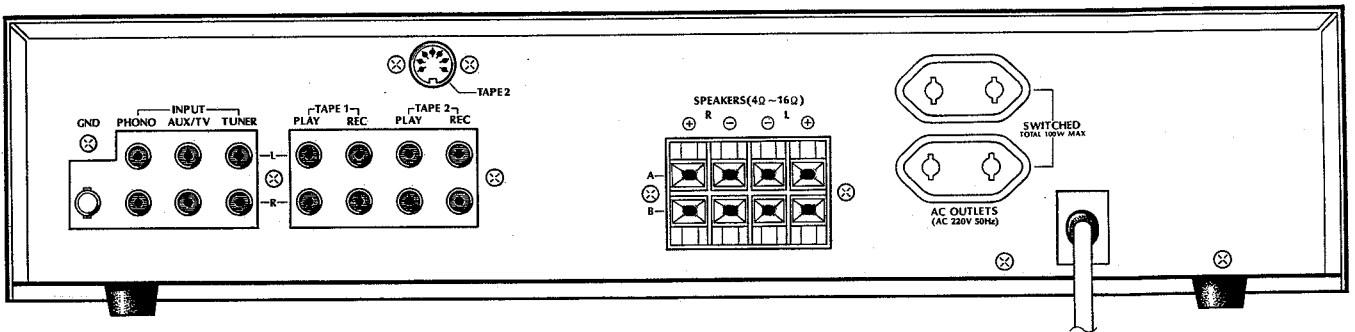

(DA-U540/U640)

TECHNISCHE DATEN

DA-U640 [DA-U540]

1. VORVERSTÄRKERTEIL

Eingangsempfindlichkeit/Impedanz
(bei Nennleistung, 8 Ohm, 1 kHz)

- PHONO 2,5 mV/50 kOhm
- TUNER, AUX, PLAY 1, 2 (Cinch) 150 mV/45 kOhm
- PLAY 1, 2 (DIN) 150 mV/45 kOhm

Übersteuerungspunkt Phono

(1 kHz, 0,1% Klirrfaktor) 200 mV/[160 mV]

Ausgangspegel/Impedanz

- REC 1, 2 (Cinch) 150 mV/600 Ohm
- REC 1, 2 (DIN) 50 mV/100 kOhm

Frequenzgang

PHONO ±0,3 dB [±0,5 dB] von 20 Hz bis 20 kHz
(RIAA STD)

TUNER, AUX, BAND 1, 2 $\pm 1^{+0,5}$ dB von 10 Hz bis 60 kHz

Klangregler

- BASS ± 8 dB bei 100 Hz
- HÖHEN ±10 dB bei 10 kHz

Filter

- SUBSONIC 15 Hz (6 dB/oct)
- HÖHEN 7 kHz (6 dB/oct)

Loudness (Lautstärkeregl. auf Stellung -30 dB) +7 dB bei 100 Hz
+5 dB bei 10 kHz

Brumm und Rauschen (bei kurzgeschlossenem Eingang)

- PHONO 74 dB
- TUNER, AUX, PLAY 1, 2 94 dB

Brumm und Rauschen (DIN, 2 x 50 mW)

- PHONO 63 dB
- TUNER, AUX, PLAY 1, 2 65 dB

2. VERSTÄRKERTEIL

Ausgangsleistung 50W [30W] Dauerleistung pro Kanal bei

gleichzeitigem Betrieb beider Kanäle an 8 Ohm bei 1 kHz und Klirrfaktor 0,02%

64 W [38W] Dauerleistung pro Kanal

bei gleichzeitigem Betrieb beider Kanäle an 4 Ohm bei 1 kHz mit Klirrfaktor 0,05%

Klirrfaktor 0,01% bei 25 W [15W] Ausgangsleistung pro Kanal bei gleichzeitigem Betrieb beider Kanäle an 8 Ohm, gemessen bei 1 kHz.

Intermodulation

(70 Hz und 7 kHz, 4 : 1) 0,03% bei Nennleistung pro Kanal an 8 Ohm, 0,02% bei 25 W pro Kanal an 8 Ohm.

Leistungsbandbreite (IHF) 10 Hz bis 40 kHz bei Klirrfaktor 0,1% an 8 Ohm.

Dämpfungsfaktor 25 von 20 Hz bis 20 kHz an 8 Ohm.

3. ALLGEMEINES

Leistungsaufnahme 370W [240W] (IEC nominal)

Abmessung (B x H x T) 424 x 105 x 305 mm

Gewicht 7 kg [6,3 kg]

Konstruktion und technische Daten können zum Zweck der Verbesserung ohne Ankündigung geändert werden.

Zerlegen

1. Die zwei Schrauben von beiden Seiten des Gehäuses (oberer Deckel) entfernen.
2. Die Abbildung 1 gezeigten elf Schrauben von der Grundplatte (unterer Deckel) entfernen.



Abb.1

3. Den Lautstärkeknopf und dann die drei Schrauben an der oberen Seite der Platte (Vorderseite) entfernen. Für weiteren Auseinanderbau auch die Buchse J15 entfernen.
4. Den in Teil A von Abbildung 2 der Plattenrückseite gezeigten Knopf sowie die 5 Muttern und 6 Schrauben entfernen.

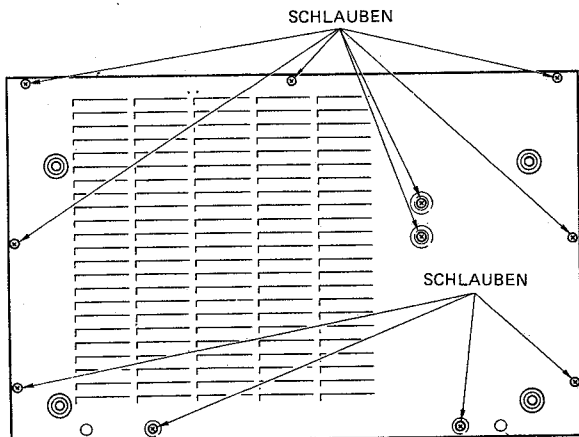

Abb.2

Einstellung der Leistungsanzeige

Ein Signal von 1 kHz einspeisen. Lautstärke so einstellen, daß an den Lautsprecherausgängen eine Wechselspannung von 16 V gemessen wird.

Danach durch drehen von Regler VR601, VR701 Leistungsanzeige auf 32 W einstellen.

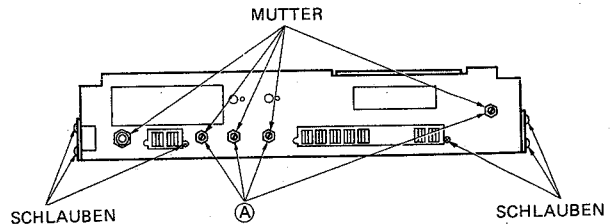
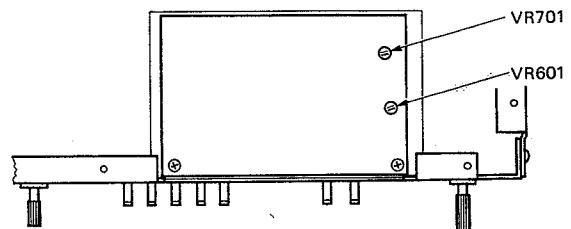

VERDRAHTUNG (DA-U540)

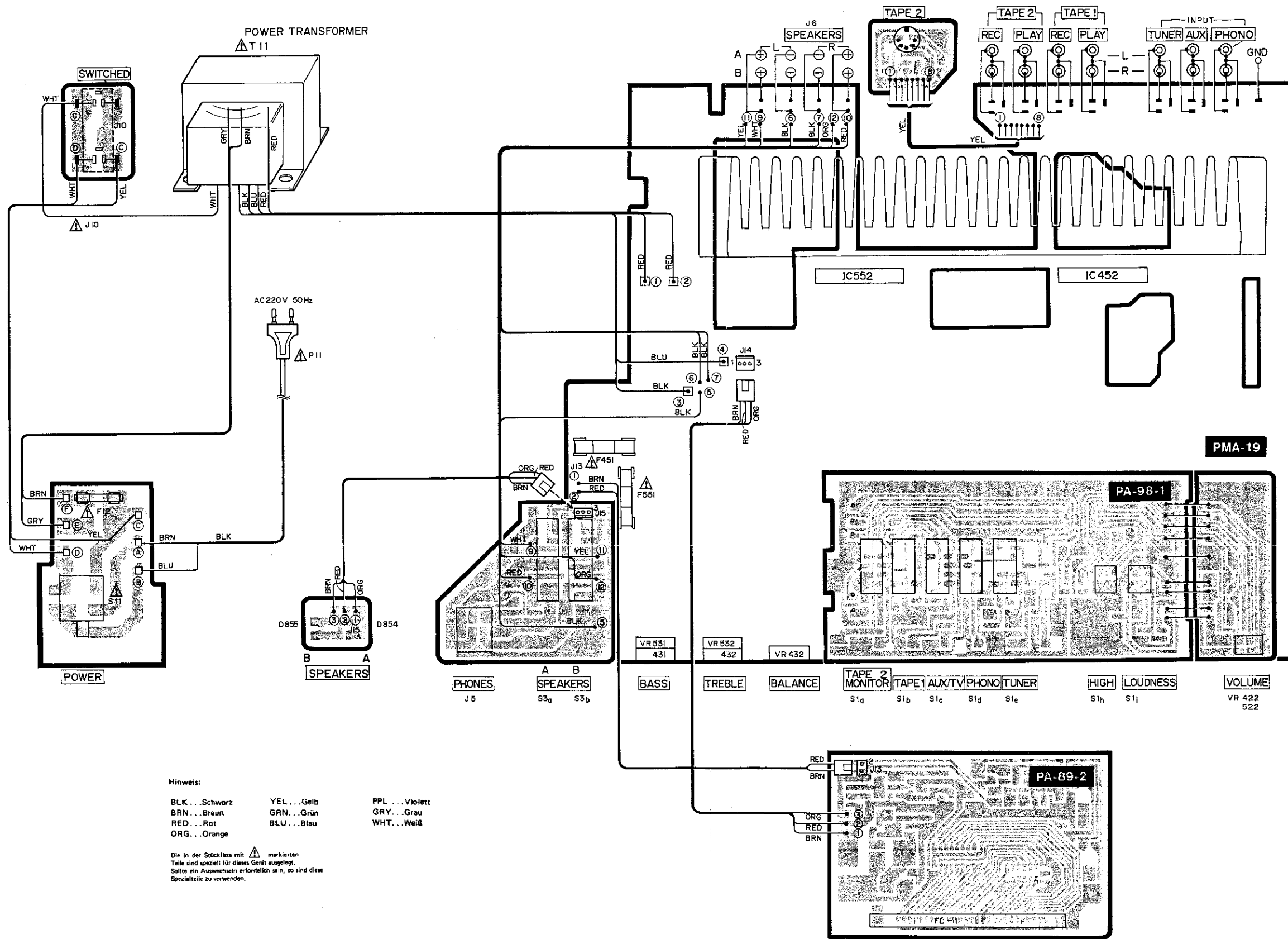

Hinweis:

BLK...Schwarz	YEL...Gelb	PPL...Violett
BRN...Braun	GRN...Grün	GRY...Grau
RED...Rot	BLU...Blau	WHT...Weiß
ORG...Orange		

Die in der Stückliste mit Δ markierten Teile sind speziell für dieses Gerät ausgelegt. Sollte ein Auswechseln erforderlich sein, so sind diese Spezialteile zu verwenden.

SCHALTBILD (DA-U540)

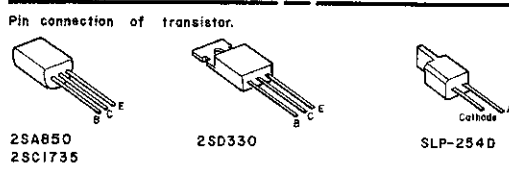
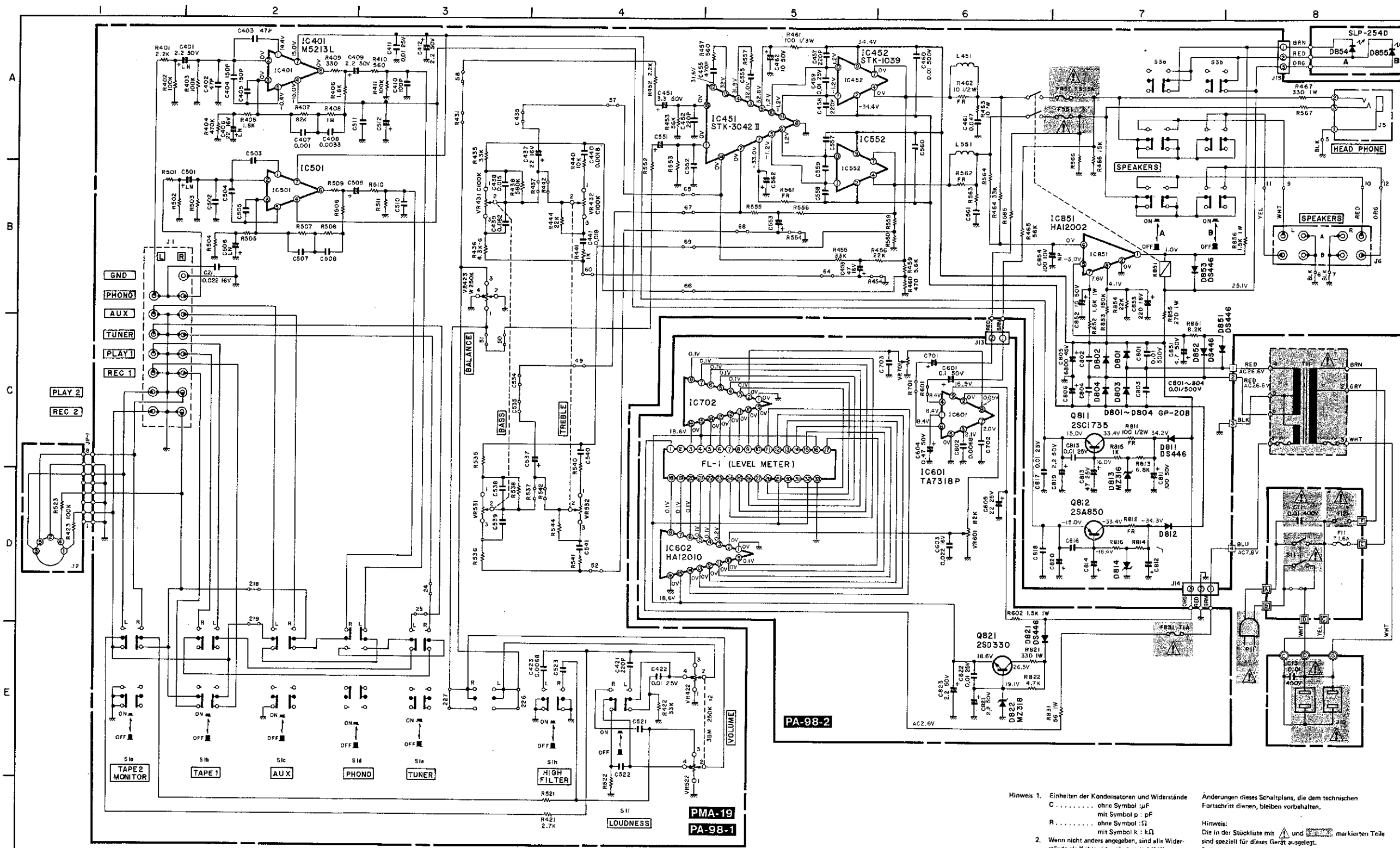

Hinweis 1. Einheiten der Kondensatoren und Widerstände
 C ohne Symbol μF
 mit Symbol p : pF
 R ohne Symbol Ω
 mit Symbol k : k Ω

2. Wenn nicht anders angegeben, sind alle Widerstände als Kohlewiderstände mit 1/4 W ausgebildet.

Änderungen dieses Schaltplans, die dem technischen Fortschritt dienen, bleiben vorbehalten.

Hinweis:
 Die in der Stückliste mit Δ und \square markierten Teile sind speziell für dieses Gerät ausgelegt.
 Sollte ein Auswechseln erforderlich sein, so sind diese Spezialteile zu verwenden.

LEITERPLATTEN (DA-U540)

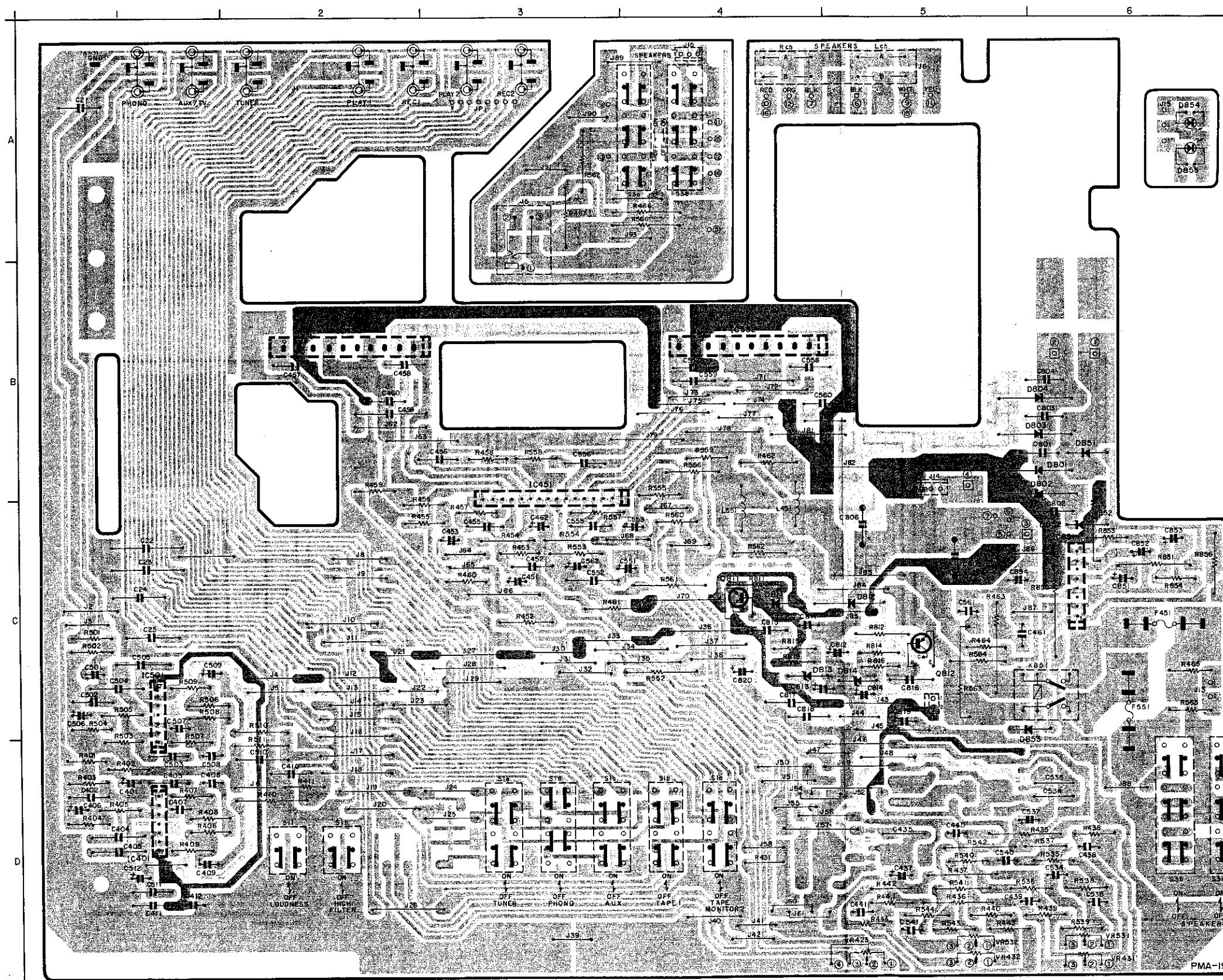

Symbol No.	Address	Symbol No.	Address	Symbol No.	Address	Symbol No.	Address
C21	A-1	C806	C-5	R453	C-3	S3a	A-4
C22	C-1	C807	-	R454	-	S3b	D-6
C23	C-1	C808	-	R455	C-2		A-4
C24	C-1	C809	-	R456	B-2		D-6
C25	C-1	C810	-	R457	C-3		
		C811	C-4	R458	B-3	VR423	D-5
C401	D-1	C812	C-5	R459	B-2	VR431	D-6
C402	D-1	C813	C-4	R460	C-3	VR432	D-5
C403	D-1	C814	C-5	R461	C-3	VR531	D-6
C404	D-1	C815	C-4	R462	B-4	VR532	D-5
C405	D-1	C816	C-5	R463	C-5		
C406	D-1	C817	C-4	R464	C-5		
C407	D-1	C818	C-4	R465	C-6		
C408	D-1	C819	C-5	R466	A-4		
C409	D-1	C820	C-4	R467	A-3		
C410	D-2						
C411	D-1	C851	C-6	R501	C-1		
C412	D-1	C852	C-6	R502	C-1		
		C853	C-6	R503	C-1		
		C854	C-5	R504	C-1		
C437	D-5			R505	C-1		
C438	D-6			R506	C-1		
C439	D-5	D801	B-6	R507	C-1		
C440	D-5	D802	B-6	R508	C-1		
C441	D-5	D803	B-6	R509	C-1		
		D804	B-6	R510	C-2		
				R511	C-2		
C451	C-3	D811	C-4				
C452	C-3	D812	C-5				
C453	C-3	D813	C-4	R535	D-6		
C454	-	D814	C-5	R536	D-5		
C455	C-3	D815	B-6	R537	-		
C456	B-3	D816	C-6	R538	D-6		
C457	B-2	D817	C-6	R539	D-6		
C458	B-2	D818	C-6	R540	D-5		
C459	B-2	D819	A-6	R541	D-5		
C460	B-2	D820	A-6	R542	-		
C461	C-6			R543	D-5		
C462	C-3	F451	C-6	R544	D-5		
		C551	C-6				
C501	C-1			R552	C-4		
C502	C-1	IC401	D-1	R553	C-3		
C503	D-1	IC451	B-3	R554	-		
C504	C-1	IC452	B-2	R555	B-4		
C505	C-1	IC501	C-1	R556	B-4		
C506	C-1	IC552	B-4	R557	C-3		
C507	C-1	IC851	C-6	R558	B-3		
C508	D-1			R559	B-4		
C509	C-1	K851	C-6	R560	C-4		
C510	D-2			R561	C-4		
C511	D-1	L451	C-4	R562	C-4		
C512	D-1	L551	C-4	R563	C-5		
				R564	C-5		
C534	D-6	Q811	C-4	R565	C-6		
C535	-	Q812	C-5	R566	A-4		
C536	-			R567	A-3		
C537	D-6	R401	D-1				
C538	D-6	R402	D-1	R811	C-4		
C539	-	R403	D-1	R812	C-5		
C540	D-5	R404	D-1	R813	C-4		
C541	D-5	R405	D-1	R814	C-5		
		R406	D-1	R815	C-4		
C551	C-4	R407	D-1	R816	C-5		
C552	C-3	R408	D-1				
C553	C-4	R409	D-1				
C554	-	R410	D-2	R851	C-6		
C555	C-3	R411	D-2	R852	C-6		
C556	B-3			R853	C-6		
C557	B-4	R435	D-6	R854	C-6		
C558	B-4	R436	D-5	R855	C-6		
C559	B-4	R437	-	R856	C-6		
C560	B-4	R438	D-6				
C561	C-5	R439	D-5	S1a	D-4		
C562	C-3	R440	D-6	S1b	D-4		
		R441	D-5	S1c	D-3		
C801	B-6	R442	-	S1d	D-3		
C802	C-6	R443	D-5	S1e	D-3		
C803	B-6	R444	D-5	S1h	D-2		
C804	B-6			S1i	D-2		
C805	C-5	R452	C-3				

SCHALTBILD (DA-U640)

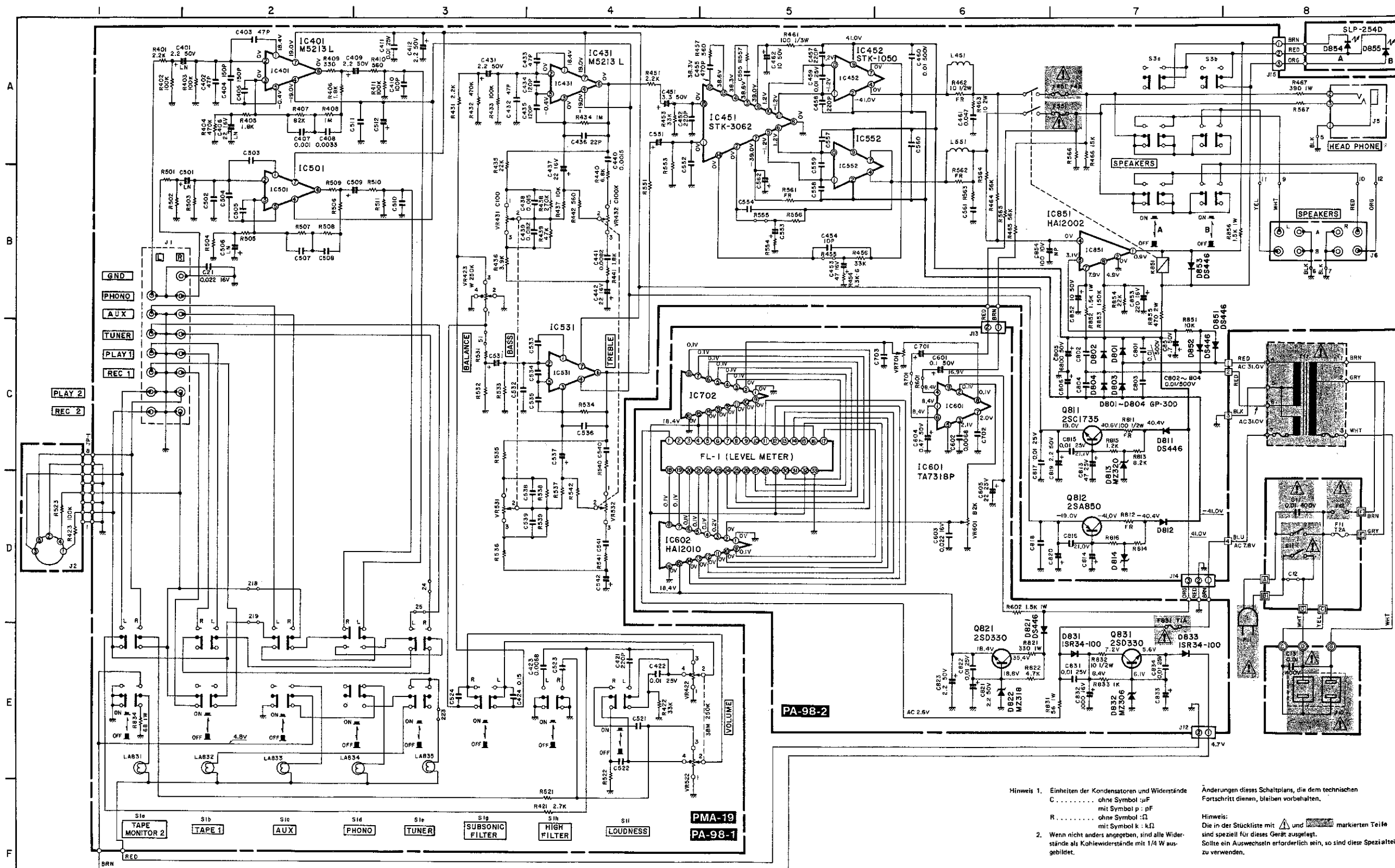

Hinweis 1. Einheiten der Kondensatoren und Widerstände
 C ohne Symbol : μ F
 mit Symbol p : pF
 R ohne Symbol : Ω
 mit Symbol k : k Ω

2. Wenn nicht anders angegeben, sind alle Widerstände als Kohlewiderstände mit 1/4 W ausgeführt.

Änderungen dieses Schaltplans, die dem technischen Fortschritt dienen, bleiben vorbehalten.

Hinweis: Die in der Stückliste mit Δ und \square markierten Teile sind speziell für dieses Gerät ausgelegt. Sollte ein Auswechseln erforderlich sein, so sind diese Spezialteile zu verwenden.

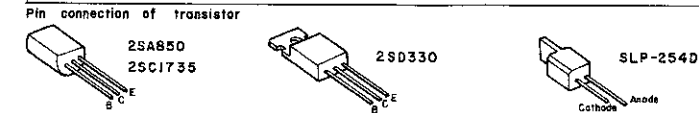

LEITERPLATTEN (DA-U640)

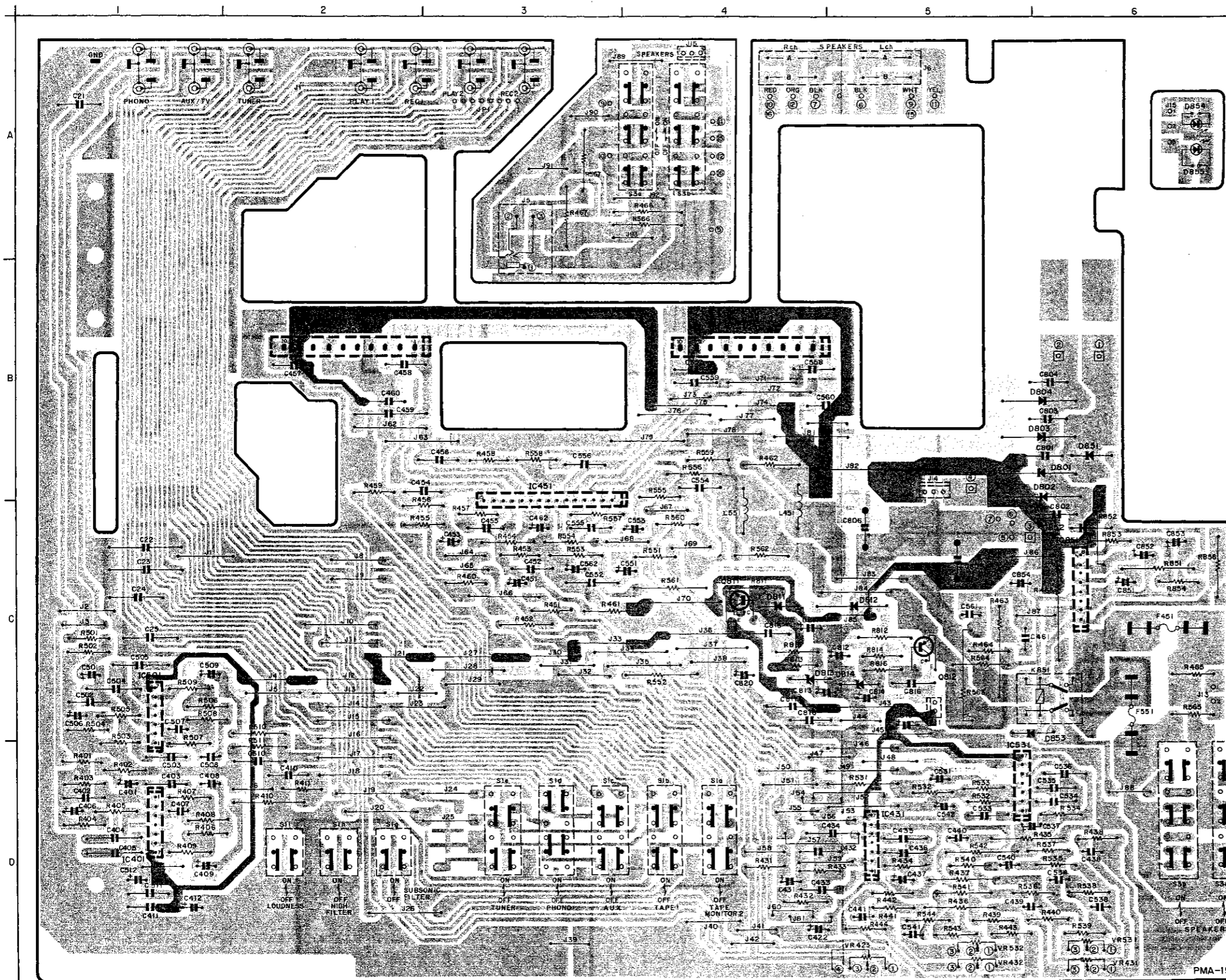

Symbol No.	Address	Symbol No.	Address	Symbol No.	Address	Symbol No.	Address
C21	A-1	C557	B-4	R410	D-2	R566	A-4
C22	C-1	C558	B-4	R411	D-2	R567	A-3
C23	C-1	C559	B-4				
C24	C-1	C560	B-4	R431	D-4	R811	C-4
C25	C-1	C561	C-5	R432	D-4	R812	C-5
		C562	C-3	R433	D-4	R813	C-4
C401	D-1			R434	D-5	R814	C-5
C402	D-1	C801	B-6	R435	D-6	R815	C-4
C403	D-1	C802	C-6	R436	D-5	R816	C-5
C404	D-1	C803	B-6	R437	D-5		
C405	D-1	C804	B-6	R438	D-6	R851	C-6
C406	D-1	C805	C-5	R439	D-5	R852	C-6
C407	D-1	C806	C-5	R440	D-6	R853	C-6
C408	D-1	C807	-	R441	D-5	R854	C-6
C409	D-1	C808	-	R442	D-5	R855	C-6
C410	D-2	C809	-	R443	D-5	R856	C-6
C411	D-1	C810	-	R444	D-5		
C412	D-1	C811	C-4			S1a	D-4
		C812	C-5	R451	C-3	S1b	D-4
C422	D-4	C813	C-4	R452	C-3	S1C	D-3
		C814	C-4	R453	C-3	S1d	D-3
C431	D-4	C815	C-4	R454	C-3	S1e	D-3
C432	D-5	C816	C-5	R455	C-2		
C433	D-4	C817	C-4	R456	B-2	S1g	D-2
C434	D-5	C818	C-4	R457	C-3	S1h	D-2
C435	D-5	C819	C-5	R458	B-3	S1i	D-2
C436	D-5	C820	C-4	R459	B-2		
C437	D-5			R460	C-3	S3a	A-4
C438	D-6	C851	C-6	R461	C-3		D-6
C439	D-5	C852	C-6	R462	B-4	23b	A-4
C440	D-5	C853	C-6	R463	C-5		D-6
C441	D-5	C854	C-5	R464	C-5		
				R465	C-6	VR423	D-5
C451	C-3	D801	B-6	R466	A-4	VR431	D-6
C452	C-3	D802	B-6	R467	A-3	VR432	D-5
C453	C-3	D803	B-6				
C454	B-2	D804	B-6	R501	C-1	VR531	D-6
C455	C-3			R502	C-1	VR532	D-5
C456	B-3			R503	C-1		
C457	B-2	DB11	C-4	R504	C-1		
C458	B-2	DB12	C-5	R505	C-1		
C459	B-2	DB13	C-4	R506	C-1		
C460	B-2	DB14	C-5	R507	C-1		
C461	C-6			R508	C-1		
C462	C-3	DB51	B-6	R509	C-1		
		DB52	C-6	R510	C-2		
C501	C-1	DB53	C-6	R511	C-2		
C502	C-1	DB54	A-6				
C503	D-1	DB55	A-6				
C504	C-1			R531	D-5		
C505	C-1	F451	C-6	R532	D-5		
C506	C-1	F551	C-6	R533	D-5		
C507	C-1			R534	D-6		
C508	D-1	IC401	D-1	R535	D-6		
C509	C-1	IC431	D-5	R536	D-5		
C510	D-2	IC451	B-3	R537	D-6		
C511	D-1	IC452	B-2	R538	D-6		
C512	D-1	IC501	C-1	R539	D-6		
		IC531	D-5	R540	D-6		
C531	D-5	IC552	B-4	R541	D-5		
C532	-	IC851	C-6	R542	D-5		
C533	D-5			R543	D-5		
C534	D-6	K851	C-6	R544	D-5		
C535	D-6			R551	C-4		
C536	D-6	L451	C-4	R552	C-4		
C537	D-6	L551	C-4	R553	C-3		
C538	D-6			R554	C-3		
C539	-	Q811	C-4	R555	B-4		
C540	D-5	Q812	C-5	R556	B-4		
C541	D-5			R557	B-3		
C542	D-5	R401	D-1	R558	B-3		
		R402	D-1	R559	B-4		
C551	C-4	R403	D-1	R560	C-4		
C552	C-3	R404	D-1	R561	C-4		
C553	C-4	R405	D-1	R562	C-4		
C554	B-4	R406	D-1	R563	C-5		
C555	C-3	R407	D-1	R564	C-5		
C556	B-3	R408	D-1	R565	C-6		
		R409	D-1				

VERDRAHTUNG (DA-U640)

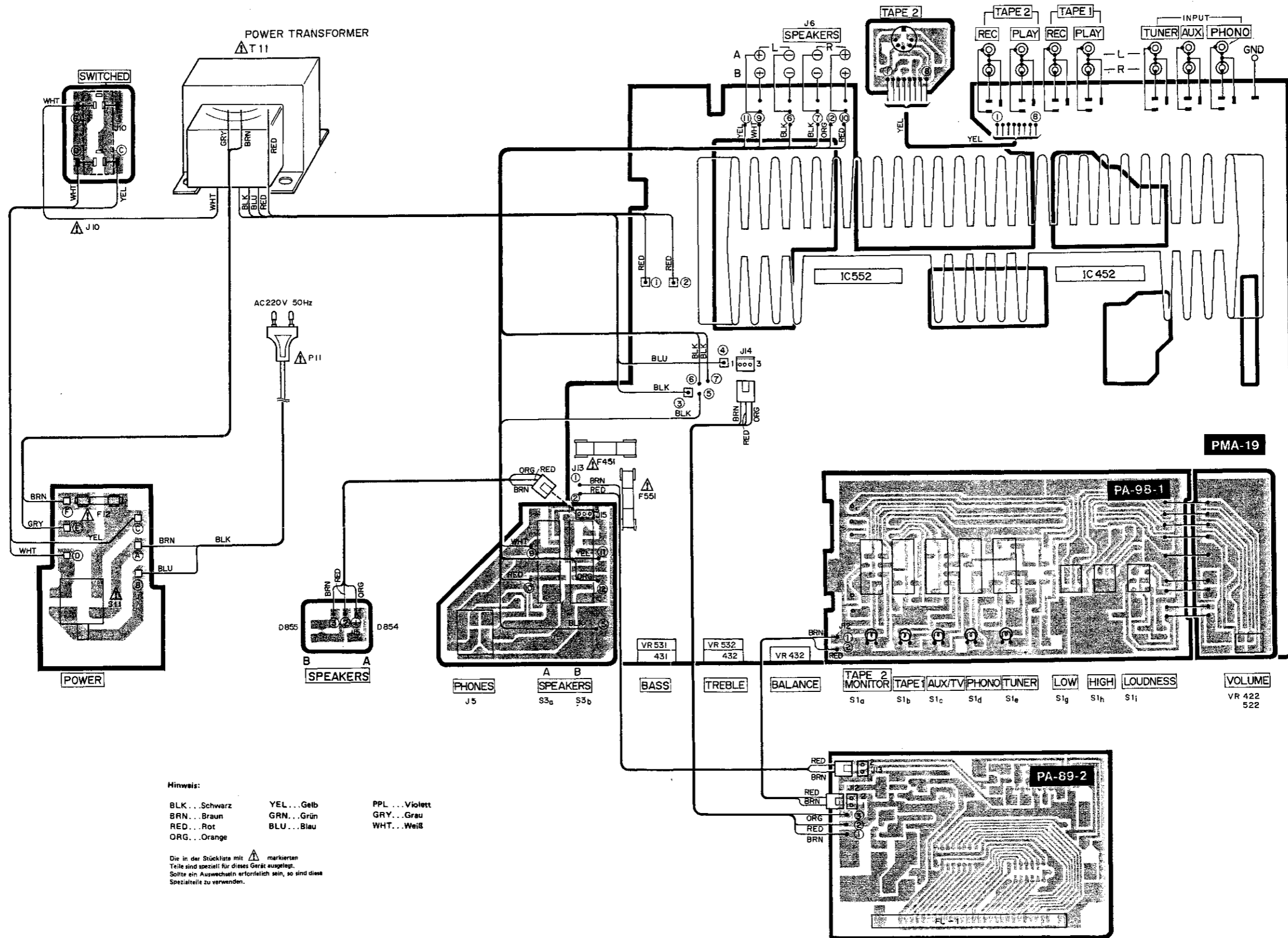

Hinweis:

- | | | |
|---------------|------------|---------------|
| BLK...Schwarz | YEL...Gelb | PPL...Violett |
| BRN...Braun | GRN...Grün | GRY...Gru |
| RED...Rot | BLU...Blau | WHT...Weiß |
| ORG...Orange | | |

Die in der Stückliste mit markierten Teile sind speziell für dieses Gerät ausgelegt. Sollte ein Auswechseln erforderlich sein, so sind diese Spezialteile zu verwenden.

LEITERPLATTEN (DA-U540)

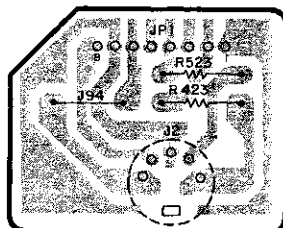
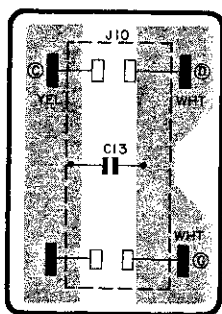
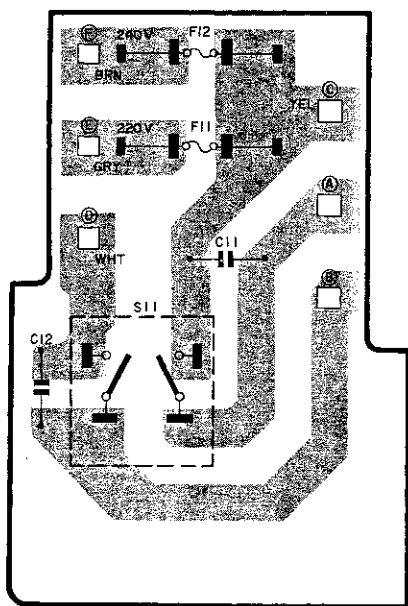
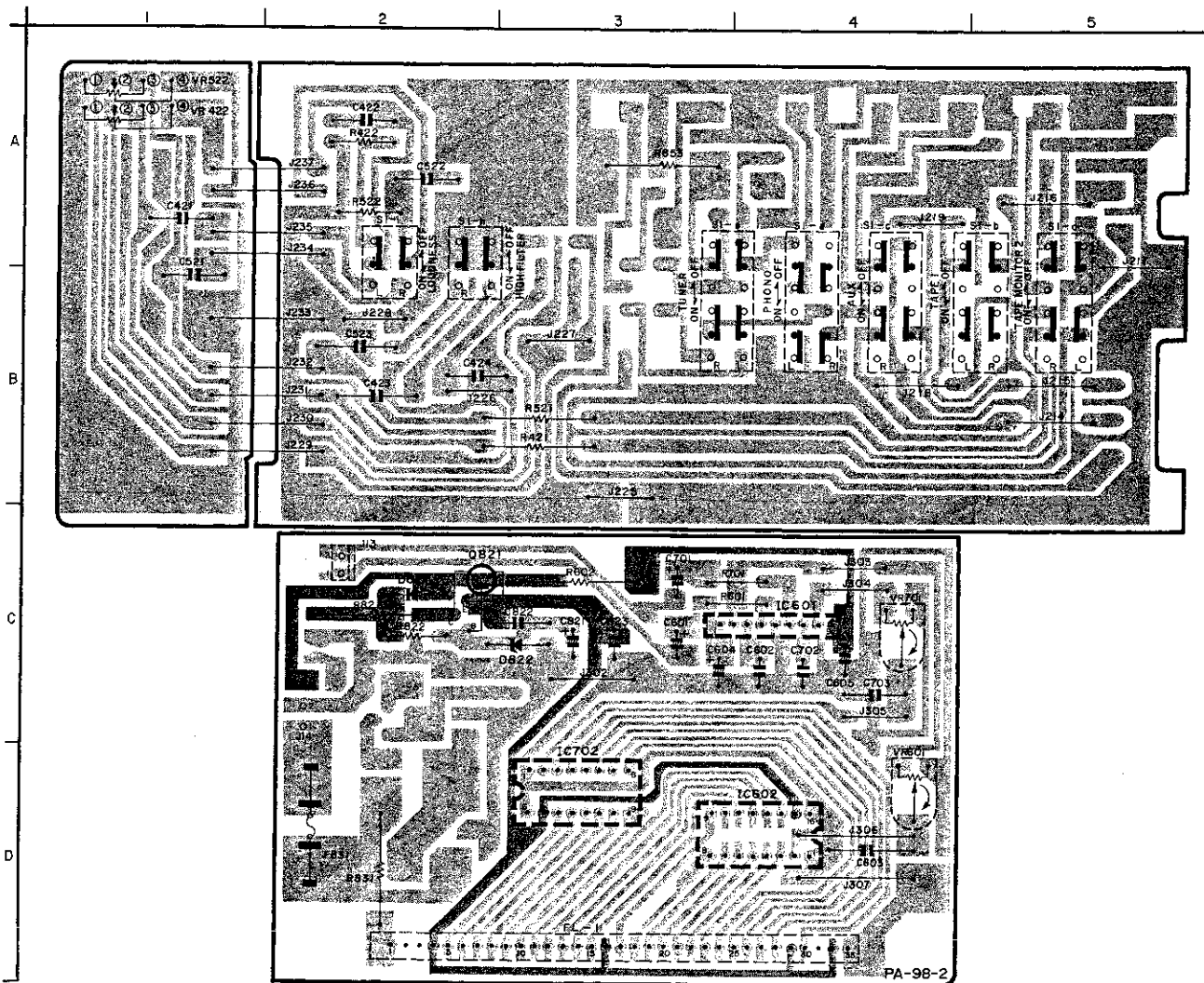

Symbol No.	Address
C421	A-1
C422	A-2
C423	B-2
C424	B-2
C521	A-1
C522	A-2
C523	B-2
C601	C-3
C602	C-4
C603	D-4
C604	C-3
C605	C-4
C701	C-3
C702	C-4
C703	C-4
C821	C-3
C822	C-3
C823	C-3
D821	C-2

Symbol No.	Address
F831	D-2
FL-1	D-3
IC601	C-4
IC602	D-4
IC702	D-3
Q821	C-2
R421	B-3
R422	A-2
R521	B-3
R522	A-2
R601	C-3
R602	C-3
R821	C-2
R822	C-2
R831	D-2
R853	A-3
S1 a	A-5
S1-b	A-5

Symbol No.	Address
S1-c	A-4
S1-d	A-4
S1-e	A-3
S1-h	A-2
S1-i	A-2
VR422	A-1
VR522	A-1
VR601	D-4
VR701	C-4

EXPLOSIONSDARSTELLUNG

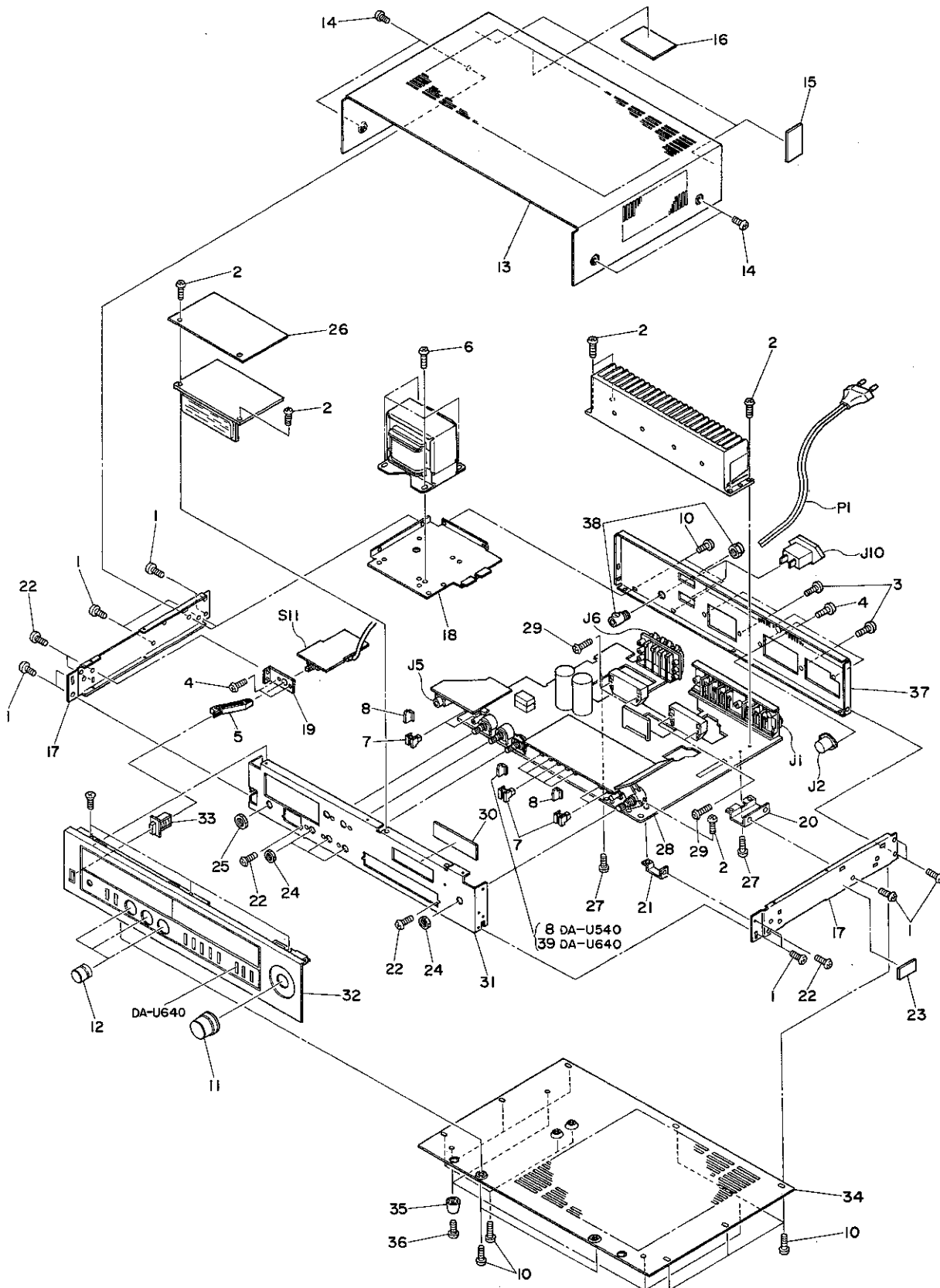

TEILELISTE (DA-U640/U540)

Hinweis: Die in der Stückliste mit Δ und \square markierten Teile sind speziell für dieses Gerät ausgelegt. Sollte ein Auswechseln erforderlich sein, so sind diese Spezialteile zu verwenden.

Nr.	Teile-Nr.	Benennung
1		Schraube
2		Schraube
3		Schraube T 1-3 x 10
4		Schraube B M3 x 6
5		Gelenk
6		Schraube B M4 x 5
7		Knopf
8	M07554200	Knopf
9		Schraube F M3 x 6
10		Schraube
11	M07554201	Knopf (Volumen)
12	M07554202	Knopf (Baß/Hohen/ Balance)
13	M07554104	Gehäuse (Spitze)
14		Schraube B M4 x 6
15		Kissen-Gummi
16		Platte
17		Halter U
18		Halter U
19		Halter L
20		Halter U
21		Halter U
22		Schraube B M3 x 6
23		Kissen-Gummi
24		Mutter M7
25		Mutter M12
26		Abstandhalter
27		Schraube M3 x 8
28		Gedruckte Leiterplatte (PMA-19)
29		Schraube M3 x 14
30		Abdeckung
31		Frontplatte
32	M07555100	Platte-Satz (DA-U640)
	M07554100	Platte-Satz (DA-U540)
33	M05200123	Knopf-Satz
34	M07554106	Grundplatte
35	M07554190	Gerätefuß
36		Metallschraube
37	M07559102	Rückward
38		Klemme
39	M07555200	Knopf (DA-U640)

Nr.	Teile-Nr.	Benennung
Dioden		
D810	M07447321	GP-30D (DA-U640)
D810	M07229323	GP-20D (DA-U540)
D802	M07447321	GP-30D (DA-U640)
D802	M07229323	GP-20D (DA-U540)
D803	M07447321	GP-30D (DA-U640)
D803	M07229323	GP-20D (DA-U540)
D804	M07447321	GP-30D (DA-U640)
D804	M07229323	GP-20D (DA-U540)
D811	M07554320	DS446-AT
D812	M07554320	DS446-AT
D813	M07493320	MZ320 (DA-U640)
D813	M07492322	MZ316 (DA-U540)
D814	M07493320	MZ320 (DA-U640)
D814	M07492322	MZ316 (DA-U540)
D821	M07554320	DS446-AT
D822	M07504320	MZ318
D831	M07391320	1SR34-100 (DA-U640)
D832	M07492320	MZ306 (DA-U640)
D833	M07391320	1SR34-100 (AA-U640)
D851	M07554320	DS446-AT
D852	M07554320	DS446-AT
D853	M07554320	DS446-AT
D854	M07510325	SLP-254D (LED)
D855	M07510325	SLP-254D (LED)
Transistoren		
Q811	M07128303	2SC1735 (D)
Q812	M07133304	2SA850 (D)
Q821	M07061304	2SD330 (E)
Q831	M07061304	2SD330 (E) (DA-U640)
ICs		
IC401	M07388343	M5213L
IC431	M07388343	M5213L (DA-U640)
IC451	M07554310	STK3042 (MK2) (DA-U540)
IC451	M07504343	STK-3062 (DA-U640)
IC452	M07461343	STK-1050 (DA-U640)
IC452	M07464344	STK-1039 (DA-U540)
IC501	M07388343	M5213L
IC531	M07388343	M5213L (DA-U640)

Nr.	Teile-Nr.	Benennung
IC552	M07461343	STK-1050 (DA-U640)
IC552	M07464344	STK-1039 (DA-U540)
IC601	M07504344	TA7318P
IC602	M07504345	HA12010
IC702	M07504345	HA12010
IC851	M07447343	HA12002
Elektronische Teile		
C11	M07554430	C-Keramik-400V 472M
C13	M07554430	C-Keramik-400V 472M
C460	M07492360	C-Keramik-500V 103M (DA-U640)
C560	M07492360	C-Keramik-500V 103M (DA-U640)
C801	M07492360	C-Keramik-500V 103M
C802	M07492360	C-Keramik-500V 103M
C803	M07492360	C-Keramik-500V 103M
C804	M07492360	C-Keramik-500V 103M
C805	M07493360	C-Elect-50V 6800 (DA-U640)
C805	M07492361	C-Elect-45V 6800 (DA-U540)
C806	M07493360	C-Elect-50V 6800 (DA-U640)
C806	M07492361	C-Elect-45V 6800 (DA-U540)
F11	M07325492	Sicherung 2A Semco (DA-U640)
F11	M07362492	Sicherung 1,6A Semco (DA-U540)
F451	M07362490	Sicherung 4A Semco (DA-U640)
F451	M07362491	Sicherung 3,15A Semco (DA-U540)
F551	M07362491	Sicherung 3,15A Semco (DA-U540)
F651	M07362490	Sicherung 4A semco (DA-U640)
F831	M07352490	Sicherung 1A Semco
FL-1	M07504565	Leuchtstoffröhre F1P24AW11YS
J1	M07554480	Anschlussplatte
J2	M07554470	Buchse (DIN)
J5	M05202446	Klinke (Phone)
J6	M07461575	Leuchtstoffröhre (Eingang)
K851	M07514465	Relais
L451	M07492530	Spule
L551	M07492530	Spule
LA831	M07504250	Lampe (DA-U640)
LA832	M07504250	lampe (DA-U640)
LA833	M07504250	Lampe (AA-U640)

Nr.	Teile-Nr.	Benennung
LA834	M07504250	Lampe (DA-U640)
LA835	M07504250	Lampe (DA-U640)
P11	M05209700	Netzleitung
S1	M07555355	Drucktaster (DA-U640)
S1	M07554356	Drucktaster (DA-U540)
S3a, b	M07554355	Drucktaster (Lautsprecherwähler)
S11	M05113430	Drucktaster (Netz)
T11	M07555500	Transformator-Netz (DA-U640)
T11	M07554500	Transformator-Netz (DA-U540)
VR422	M07504401	VR-W-B250K 25 (VOLUME)
VR522		
VR423	M07229401	Poti-Standard-W-250K20 (BALANCE)
VR431	M07363400	VR-W-C100K20 (BASS)
VR531		
VR432	M07363400	VR-W-C100K20 (TREBLE)
VR532		
VR601	M07440437	Trimpoti-B2K
VR701	M07440437	Trimpoti-B2K

VERPACKUNGSANLEITUNG (DA-U540/U640)

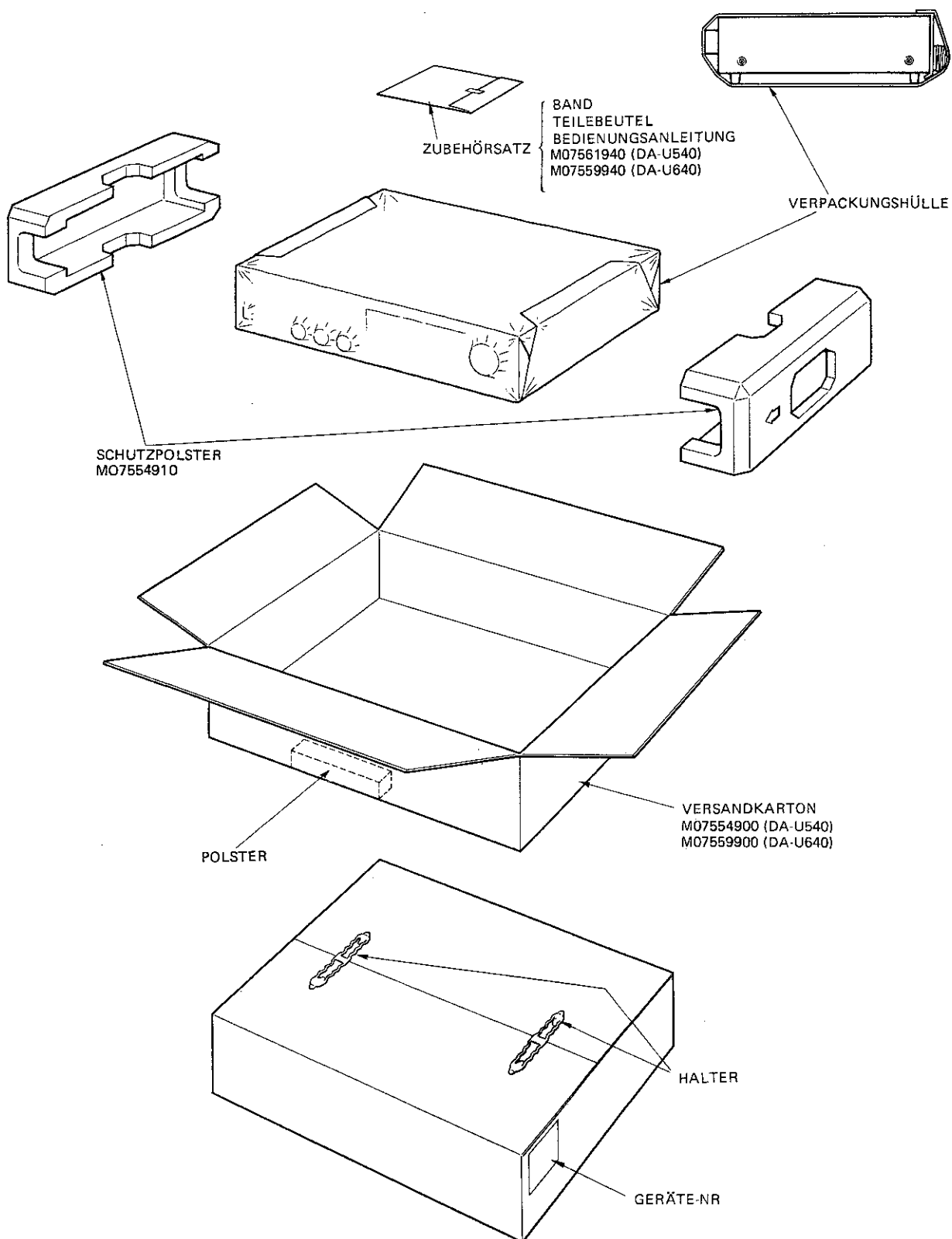

ÄQUIVALENTER SCHALTPLAN DER VERWENDETEN ICs.

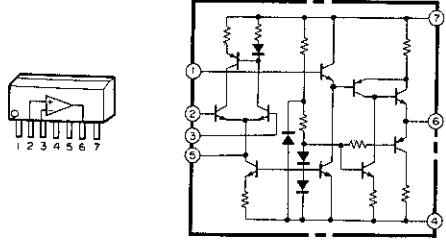
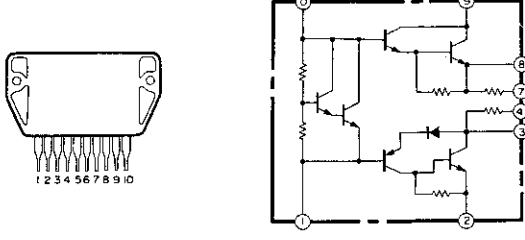
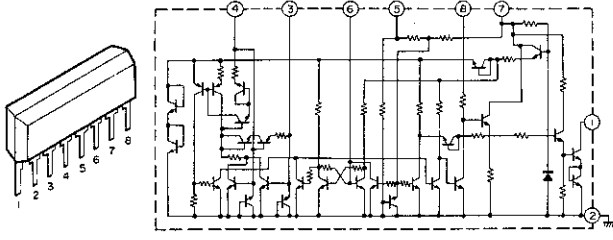
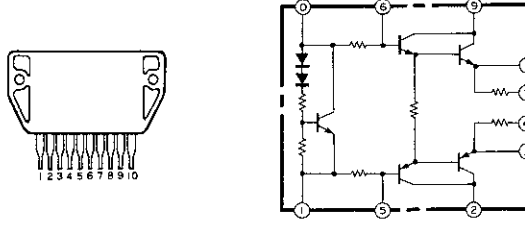
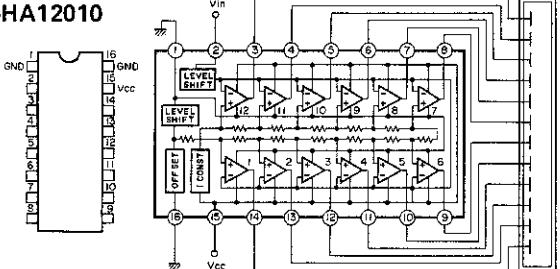
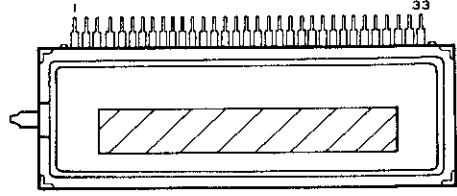
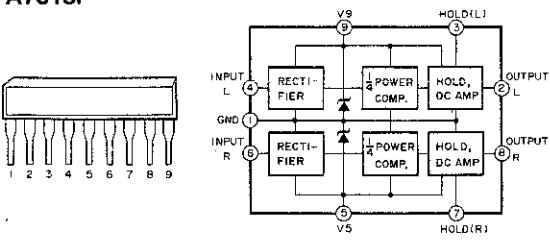
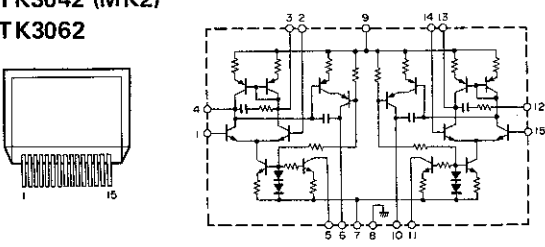
<p>IC-M5213L</p> 	<p>IC-STK1039</p> 																																																																																																														
<p>IC-HA12002</p> 	<p>IC-STK1050</p> 																																																																																																														
<p>IC-HA12010</p> 	<p>TUBE-FLUOR FIP24AW11YS</p>  <table border="1" data-bbox="810 1279 1401 1406"> <tr> <td>P(1)</td><td>P(2)</td><td>P(3)</td><td>P(4)</td><td>P(5)</td><td>P(6)</td><td>P(7)</td><td>P(8)</td><td>P(9)</td><td>P(10)</td><td>P(11)</td><td>P(12)</td><td>P(13)</td> </tr> <tr> <td>0.01</td><td>0.03</td><td>0.3</td><td>3</td><td>10</td><td>50</td><td></td><td></td><td></td><td></td><td></td><td></td><td></td> </tr> <tr> <td>P(A)</td><td>P(B)</td><td>P(C)</td><td>P(D)</td><td>P(E)</td><td>P(F)</td><td>P(G)</td><td>P(H)</td><td>P(I)</td><td>P(J)</td><td>P(K)</td><td>P(L)</td><td>P(M)</td> </tr> </table> <table border="1" data-bbox="820 1458 1385 1559"> <tr> <td>Terminal No.</td><td>1</td><td>2</td><td>3</td><td>4</td><td>5</td><td>6</td><td>7</td><td>8</td><td>9</td><td>10</td><td>11</td><td>12</td><td>13</td><td>14</td><td>15</td><td>16</td><td>17</td> </tr> <tr> <td>Connection Electrode</td><td>F</td><td>I</td><td>C</td><td>I</td><td>C</td><td>G</td><td>P(A)</td><td>P(B)</td><td>P(C)</td><td>P(D)</td><td>P(E)</td><td>P(F)</td><td>P(1)</td><td>P(2)</td><td>P(3)</td><td>P(4)</td><td>P(5)</td> </tr> <tr> <td>Terminal No.</td><td>18</td><td>19</td><td>20</td><td>21</td><td>22</td><td>23</td><td>24</td><td>25</td><td>26</td><td>27</td><td>28</td><td>29</td><td>30</td><td>31</td><td>32</td><td>33</td><td></td> </tr> <tr> <td>Connection Electrode</td><td>P(7)</td><td>P(8)</td><td>P(9)</td><td>P(10)</td><td>P(11)</td><td>P(12)</td><td>P(13)</td><td>P(14)</td><td>P(15)</td><td>P(16)</td><td>G</td><td>P(L)</td><td>I</td><td>C</td><td>P(D)</td><td>F</td> </tr> </table>	P(1)	P(2)	P(3)	P(4)	P(5)	P(6)	P(7)	P(8)	P(9)	P(10)	P(11)	P(12)	P(13)	0.01	0.03	0.3	3	10	50								P(A)	P(B)	P(C)	P(D)	P(E)	P(F)	P(G)	P(H)	P(I)	P(J)	P(K)	P(L)	P(M)	Terminal No.	1	2	3	4	5	6	7	8	9	10	11	12	13	14	15	16	17	Connection Electrode	F	I	C	I	C	G	P(A)	P(B)	P(C)	P(D)	P(E)	P(F)	P(1)	P(2)	P(3)	P(4)	P(5)	Terminal No.	18	19	20	21	22	23	24	25	26	27	28	29	30	31	32	33		Connection Electrode	P(7)	P(8)	P(9)	P(10)	P(11)	P(12)	P(13)	P(14)	P(15)	P(16)	G	P(L)	I	C	P(D)	F
P(1)		P(2)	P(3)	P(4)	P(5)	P(6)	P(7)	P(8)	P(9)	P(10)	P(11)	P(12)	P(13)																																																																																																		
0.01		0.03	0.3	3	10	50																																																																																																									
P(A)	P(B)	P(C)	P(D)	P(E)	P(F)	P(G)	P(H)	P(I)	P(J)	P(K)	P(L)	P(M)																																																																																																			
Terminal No.	1	2	3	4	5	6	7	8	9	10	11	12	13	14	15	16	17																																																																																														
Connection Electrode	F	I	C	I	C	G	P(A)	P(B)	P(C)	P(D)	P(E)	P(F)	P(1)	P(2)	P(3)	P(4)	P(5)																																																																																														
Terminal No.	18	19	20	21	22	23	24	25	26	27	28	29	30	31	32	33																																																																																															
Connection Electrode	P(7)	P(8)	P(9)	P(10)	P(11)	P(12)	P(13)	P(14)	P(15)	P(16)	G	P(L)	I	C	P(D)	F																																																																																															
<p>IC-TA7318P</p> 																																																																																																															
<p>IC-STK3042 (MK2) IC-STK3062</p> 																																																																																																															

LEITERPLATTEN (DA-U640)

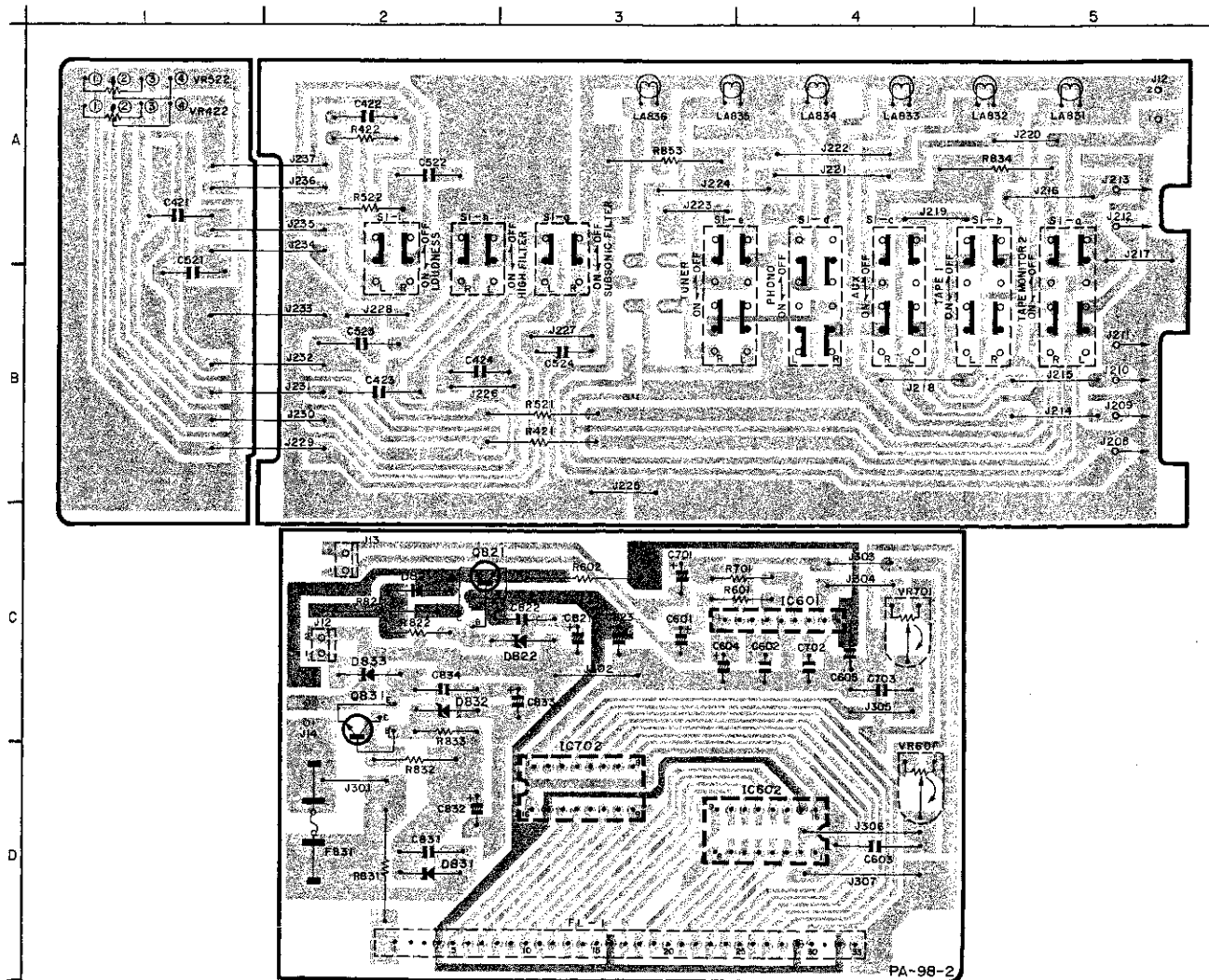

Symbol No.	Address	Symbol No.	Address	Symbol No.	Address	Symbol No.	Address
C421	A-1	C832	D-2	Q821	C-2	S1-c	A-4
C422	A-2	C833	C-3	Q831	C-2	S1-d	A-4
C423	B-2	C834	C-2	R421	B-3	S1-e	A-3
C424	B-2	D821	C-2	R422	A-2	S1-g	A-3
C521	A-1	D822	C-3	R521	B-3	S1-h	A-2
C522	A-2	D831	D-2	R522	A-2	S1-i	A-2
C523	B-2	D832	C-2	R601	C-3	VR422	A-1
C524	B-3	D833	C-2	R602	C-3	VR522	A-1
C601	C-3	F831	D-2	R701	C-3	VR601	D-4
C602	C-4	FL-1	D-3	R821	C-2	VR701	C-4
C603	D-4	IC601	C-4	R822	C-2		
C604	C-3	IC602	D-4	R831	D-2		
C605	C-4	IC702	D-3	R832	D-2		
C701	C-3	LA831	A-5	R833	C-2		
C702	C-4	LA832	A-5	R834	A-5		
C703	C-4	LA833	A-4	R853	A-3		
C821	C-3	LA834	A-4	S1-a	A-5		
C822	C-3	LA835	A-3	S1-b	A-5		
C823	C-4	LA836	A-3				
C831	D-2						

