

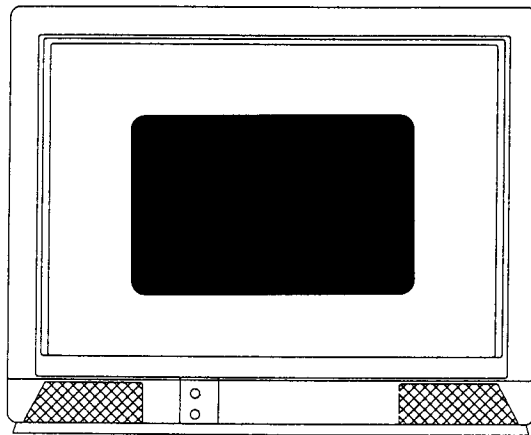

MITSUBISHI

Service Manual

COLOUR TV



MODEL

CT-21A5LST
CT-21A5STX
CT-25A5STX

CAUTION

Before servicing this chassis, it is important that the serviceman reads the "SAFETY PRECAUTIONS" in this service manual.

SPECIFICATION

• Power Input	AC 230V; 50Hz [CT-21A5LST] AC 240V; 50Hz [CT-21/25A5STX]	• Chassis	E14SF
• Power Consumption	88W [CT-21A5LST/STX] 97W [CT-25A5STX]	• Picture tube	A51EAL55X01 21" 90° Deflection [21" model] A59ECY13X01 25" 110° Deflection [25" model]
• Reception System	CCIR-I	• Picture high voltage	26.5kV (at 1.0mA)
• Colour System	PAL, 60PAL	• Cabinet Dimensions	495(W)×447(H)×485(D)mm [CT-21A5LST/STX] 572(W)×505(H)×442(D)mm [CT-25A5STX]
• Reception	VHF 44.5~60.5MHz, 174~214MHz [CT-21A5LST] UHF 470~870MHz CATV 68~89MHz, 104~470MHz [CT-21A5LST]	• Weight(Approx.)	21.9kg [CT-21A5LST/STX] 26.2kg [CT-25A5STX]
• Intermediate Frequency	Video IF Carrier 39.5MHz Sound IF Carrier 33.5MHz		
• Aerial Input	75Ω		
• Speaker	100mm Round type 2pcs 40mm × 70mm 2pcs		

MITSUBISHI ELECTRIC

CONTENTS

SAFETY PRECAUTIONS	1
CONTROLS AND CABINET PARTS	2
LEAD DRESS	3
LEAD CONNECTOR COLOUR CODE	4
ELECTRICAL ADJUSTMENTS	5
LOCATION OF TEST POINTS AND ADJUSTMENT	6
Audio Circuit Adjustment	
1. VCO Coil Adjustment	7
2. Audio Deflection Coil Adjustment	7
VIF Circuit Adjustment	
3. RF AGC Adjustment	8
Power Circuit Adjustment	
4. B4 Voltage Adjustment	8
CRT Circuit Adjustment	
5. Cut off, White Adjustment	9
6. Focus Adjustment	10
7. Black Level Adjustment	10
Deflection Circuit Adjustment	
8. Horizontal Centre Adjustment	11
9. East West PCC Adjustment (25" model only)	11
10. Horizontal Width Adjustment (25" model only)	12
11. Vertical Height, Vertical Linearity, Vertical Centre Adjustment	12
Video Circuit Adjustment	
12. Sub Cont Adjustment	13
PARTS LIST	14
CIRCUIT DIAGRAM	

SAFETY PRECAUTIONS

NOTICE: Observe all cautions and safety related notes located inside the receiver cabinet and on the receiver chassis.

WARNING

1. An isolation transformer should be used between the television receiver and the AC supply point before any test/service is performed on a LIVE chassis television receiver.
2. Operation of these receivers outside the cabinet or with the cover removed, involves a shock hazard from the receiver power supplies. Work on the receiver should not be attempted by anyone who is not thoroughly familiar with precautions necessary when working on high voltage equipment.
3. Do not install, remove or handle the picture tube in any manner unless shatter-proof goggles are worn. People not so equipped should be kept away while the picture tube is being handled. Keep the picture tube away from the body while handling.
4. When service is required, observe the original lead dressing. Extra precaution should be given to assure correct lead dressing in the high voltage area. Where a short-circuit has occurred, replace those components that indicate evidence of overheating.

X-RADIATION WARNING

The surface of the cathode ray tube may generate X-Radiation. Precaution during service and, if possible, the use of a lead apron is recommended for shielding while handling.

When replacing the cathode ray tube use only the designated replacement part since it is a critical component with regard to X-Radiation as noted above (No high-voltage adjustments are provided). The high-voltage specification is described on cover page.

LEAKAGE CURRENT COLD CHECK

Before returning the receiver to the customer, it is recommended that leakage current be measured according to the following methods.

With the AC plug removed from the AC source, place a jumper across the live and neutral prongs of the main plug. Turn the receiver AC switch on. Using an 500V D.C Insulation Tester, connect one lead to the jumpered AC plug and touch the other lead to each exposed metal part (antennas, screwheads, etc.), particularly any exposed metal part having a return path to the chassis. Exposed metal parts having a return path to the chassis should have a minimum resistance reading of 4 meg ohm. Any resistance below this value indicates an abnormality which requires corrective action.

CONTROLS AND CABINET PARTS

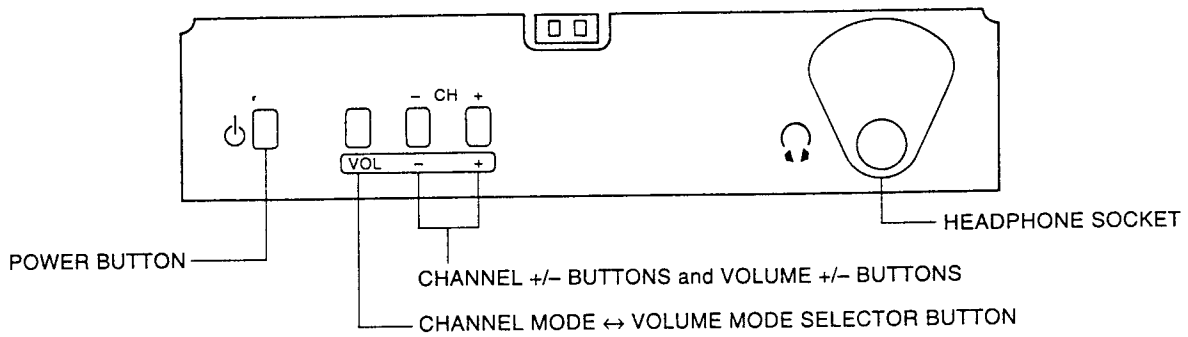
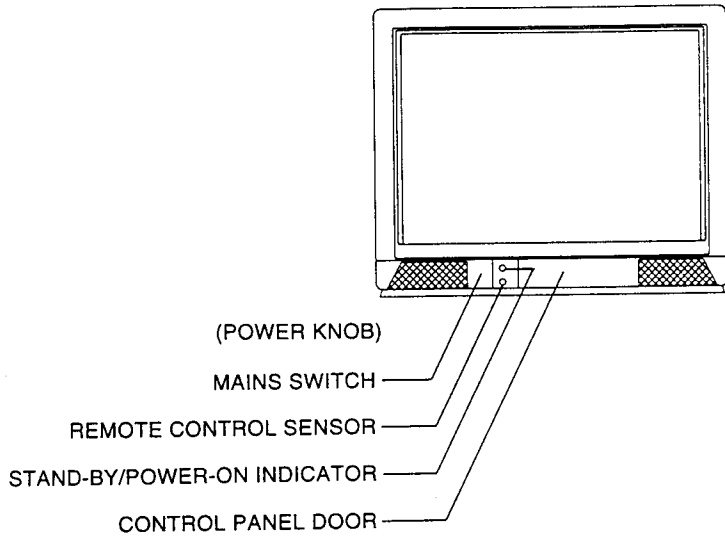

SCARTS SOCKET CONNECTORS

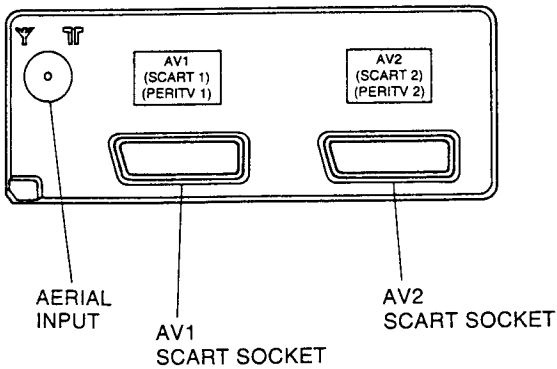
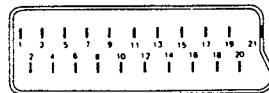

MODE PIN	AV1	AV2	MODE PIN	AV1	AV2
1	AUDIO OUT R		12	NOT CONNECTED	
2	AUDIO IN R		13	RED EARTH	NOT CONNECTED
3	AUDIO OUT L		14	BLANKING EARTH	NOT CONNECTED
4	AUDIO EARTH		15	RED IN	NOT CONNECTED
5	BLUE EARTH	NOT CONNECTED	16	RGB STATUS (BLANKING)	NOT CONNECTED
6	AUDIO IN L		17	VIDEO EARTH	
7	BLUE IN	NOT CONNECTED	18	VIDEO IN EARTH	
8	FUNCTION SWITCH		19	VIDEO OUT	
9	GREEN EARTH	NOT CONNECTED	20	VIDEO IN	
10	NOT CONNECTED		21	SOCKET EARTH	
11	GREEN IN	NOT CONNECTED			

LEAD DRESS

The lead wires clamped are listed in the table below.

Note: The inner wires are clamped so that they do not come close to the heat generating or high-tension parts. After servicing route all wires in their original position.

The anode lead wires are routed so no tensile strength is applied to the anode cap. If the mounting angle of the anode cap and the route of the anode lead wires are changed. Return them to the initial angle and route.

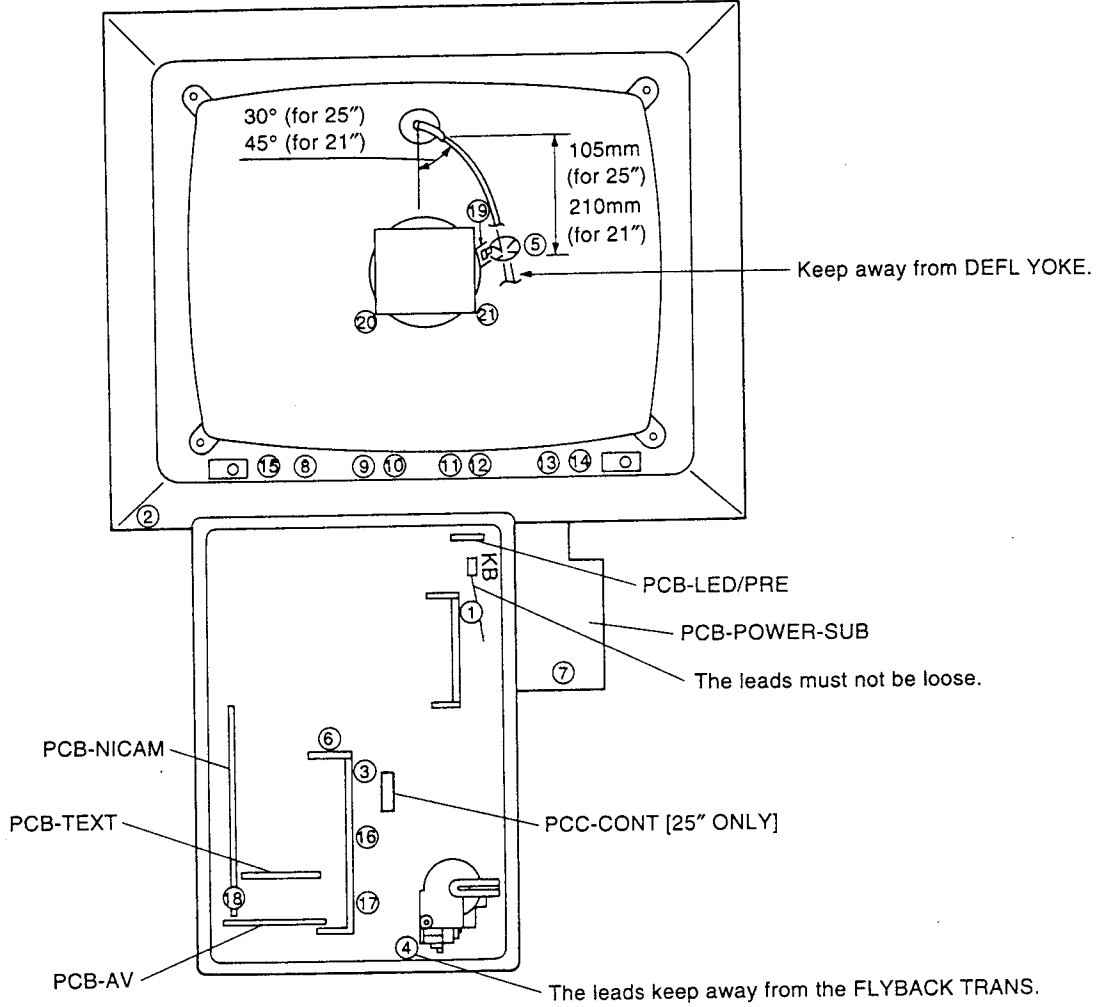

CLAMPER LIST FOR CONNECTOR LEAD

CONNECTOR LEAD	CLAMP
ANODE-LEAD	⑤ must be held by ⑱
DD	⑥
DJ-SP393	② - ⑮ - ⑧ - ⑨ - ⑩ - ⑪ - ⑫ - ⑬ (21" only) - ⑭
DJ-SP394	②
DK	② (Loop DK to take up slack)
DY	③ (1 loop) - ⑯ - ⑰
FOCUS-LEAD	④ - ⑲
GA	⑥ - ⑱ - ⑳
KB	①
LB	④ - ⑲
PC	⑦ (1 loop 21" only) - ①
SA	⑯ - ⑰
SCREEN LEAD	④ - ⑲

LEAD CONNECTOR COLOUR CODE

Lead connectors show the connector names by colour codes of leads, not printed any connector names. When connecting or removing them, identify connector names according to colour codes in the table below. Colour Codes (See Pin Nos. 1 and 2 of connectors)

Colour	Code
BLACK	A
BROWN	B
RED	C
ORANGE	D
YELLOW	E
GREEN	NOT USED (GROUND)
BLUE	G
VIOLET	H
GREY	J
WHITE	K
PINK	L

Example:

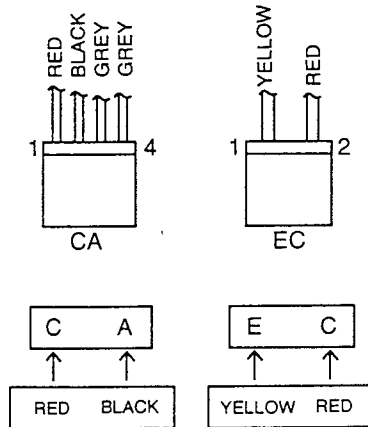

WHEN SERVICING PCB USE THE EXTENSION CORD

PRINTED CIRCUIT BOARD	CONNECTOR	PARTS NO.
AV NICAM TEXT LED/PRE	CB (15pin) DA (9pin), DB (12pin) HB (8pin) HC (5pin)	859C431O40
PCC-CONT (only 25")	LA (6pin)	859C431O60
AV	CA (11pin)	859C432O40
TEXT	HA (10pin)	859C432O80

ELECTRICAL ADJUSTMENT

Perform only the alignments required.
If proper equipment is not available, do not attempt an alignment.

■ Measuring equipment and Jigs

- Oscilloscope (Unless otherwise specified in particular, use 10:1 probes.)
- Signal generator
- Direct current milliammeter
- Direct current voltmeter.
- Electrical tools

■ Test Signal

- 1) Monoscope signal
When you have no monoscope signal source for adjustment, connect the unit to a VCR and play an alignment tape (Monoscope).
- 2) Colour bar signal
In this manual, unless otherwise specified in particular, use colour bar signal in specifications below.

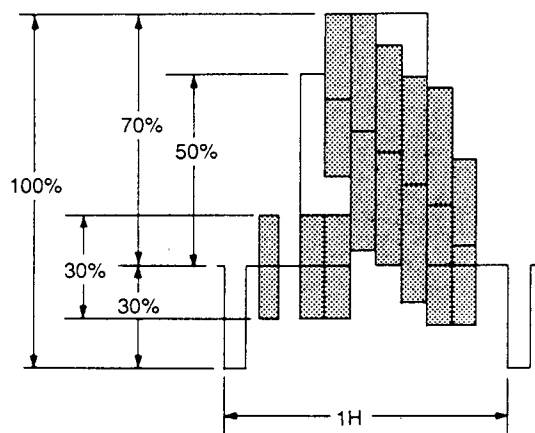

PAL

Split-Field Colour Bars (with 100% window)

LOCATION OF TESTPOINTS AND ADJUSTMENTS

PCB-MAIN (COMPONENT SIDE)

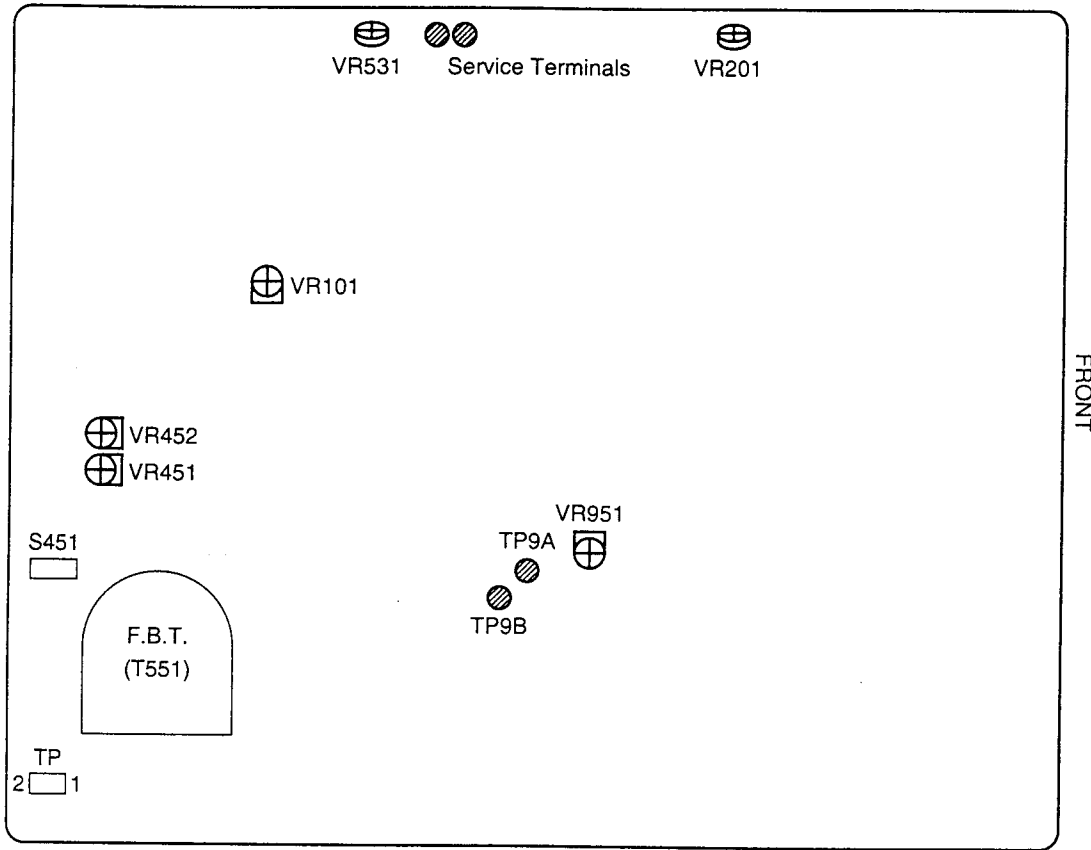

PCB-CRT (SOLDER SIDE)

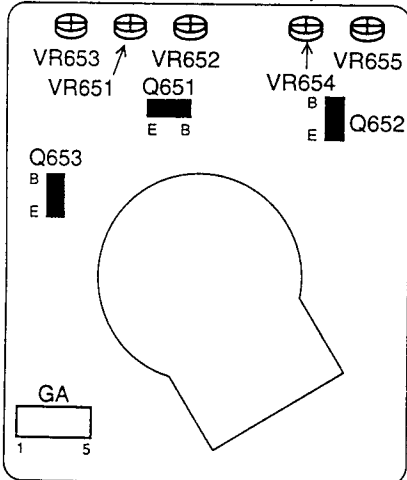

PCB-PCC CONT (COMPONENT SIDE)

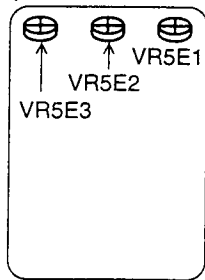

PCB-NICAM (COMPONENT SIDE)

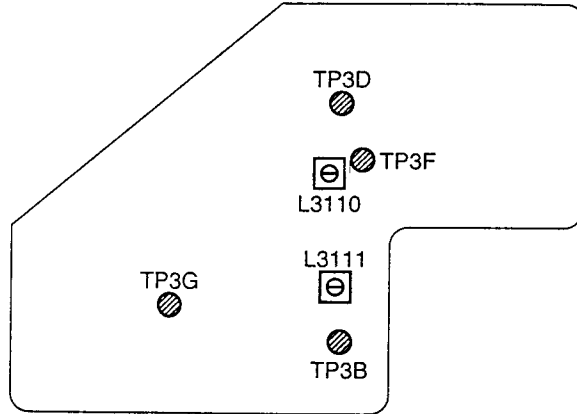

[Audio Detection Circuit] 1. VCO Coil	Adjustment purpose Setting VCO free run frequency.
	Symptom when incorrectly adjusted NICAM and normal audio poor also S/N ratio poor.

Measuring instrument	DC Voltmeter
Test point	TP3D
EXT trigger	---
Measurement range	---
Input signal	Sinewave signal (39.5MHz, 90±2dBμ)
Input terminal	TP3B

1. Remove the ANTENNA cable from RF IN terminal.
 2. Short-circuit TP3F and ground.
 3. Observe the DC voltage at TP3D.
 4. Measure the DC voltage on TP3D.
 5. Open the short circuit of TP3F and ground.
 6. Supply a sinewave signal (39.5MHz, 90±2dBμ) to TP3B using the circuit, as shown in figure.
 7. Adjust L3110 so that the voltage reading on TP3D is same value the reading measured in step 4.
- Note:** There are three adjustment points of L3110.
After adjustment, make sure that the set movements is normal.
If necessary, set L3110 to the other adjustment points so that the set movements is normal.

PCB-NICAM (COMPONENT SIDE)

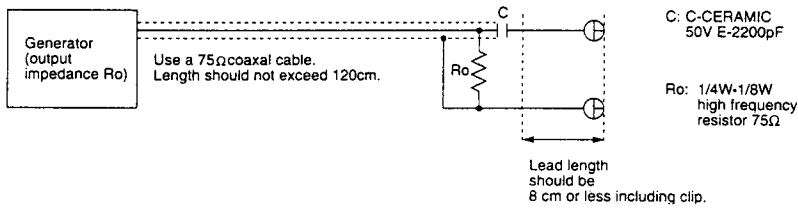
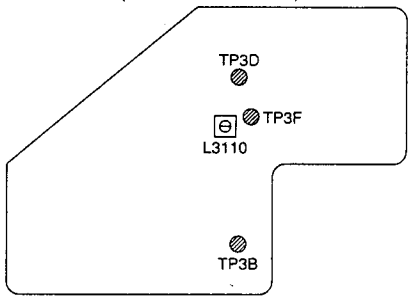

2. Audio Detection Coil	Adjustment purpose Detect audio signal to optimum.
	Symptom when incorrectly adjusted Normal audio poor or distorted.

Measuring instrument	Oscilloscope
Test point	TP3G
EXT trigger	---
Measurement range	DIV 50mV TIM 1ms
Input signal	RF signal (Normal audio)
Input terminal	RF IN terminal

1. Supply an RF signal of normal audio (400Hz, 30% MOD).
2. Observe the waveform at TP3G.
3. Adjust L3111 so that the centre level of the amplitude is DC5V.

PCB-NICAM (COMPONENT SIDE)

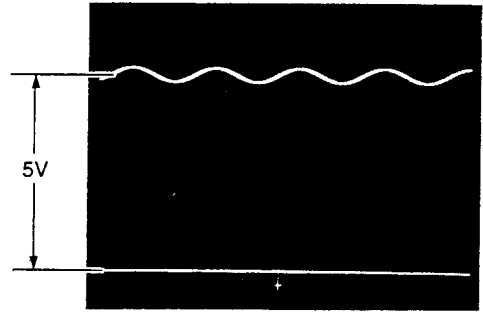
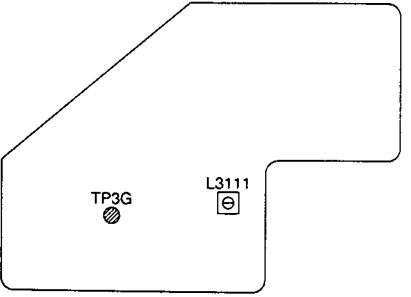

[VIF circuit] 3. RF AGC	Adjustment purpose The best receiving condition of RF signal. Symptom when incorrectly adjusted Poor S/N ratio or cross modulation.
Measuring instrument	---
Test point	---
EXT trigger	---
Measurement range	---
Input signal	RF signal (Programme)
Input terminal	RF IN terminal

1. Supply an RF signal(Programme).
2. Turn on AFT.
3. Adjust VR101 so that the picture and sound have no beat, noise and inter-modulation distortion.

PCB-MAIN (COMPONENT SIDE)

VR101

FRONT

[Power circuit] 4. B4 Voltage	Adjustment purpose The best value of power supply voltage for horizontal deflection circuit. Symptom when incorrectly adjusted Too bright or too dark picture. Too compressed or too expanded horizontal width of picture.
Measuring instrument	DC Voltmeter
Test point	+ lead : TP9A - lead : TP9B
EXT trigger	---
Measurement range	---
Input signal	RF signal (Programme)
Input terminal	RF IN terminal

1. Supply an RF signal (Programme).
2. Observe the voltage at TP9A and TP9B (Plus lead to TP9A).
3. Adjust VR951 so that the voltage is a value listed in the table below.

	21 inch	25 inch
Voltage Value	122 ± 3V	145 ± 1V

PCB-MAIN (COMPONENT SIDE)

VR951
 TP9A
 TP9B

FRONT

[CRT circuit] 5. Cut Off, White		Adjustment purpose Rate of electron beam shot from each electron gun of R, G and B.
		Symptom when incorrectly adjusted Too dark or too bright picture.

Measuring instrument	Oscilloscope
Test point	collector of Q651
EXT trigger	---
Measurement range	DIV 5V TIM 20 μ s
Input signal	---
Input terminal	---

- * This adjustment must follow the Purity and Convergence adjustments.
 - * Preheat the set for twenty minutes or more.
 - * Adjustment Item 12 (Sub Cont) must be performed immediately after this one.
1. Set the no signal condition in AV mode.
 2. Set VR651, VR652 and VR653 to the mechanical centre position.
 3. Set VR654, VR655 and VR201 to the mechanical centre position.
 4. Observe the waveform at the collector of Q651. (Use GA connector pin ② for ground.)
 5. Adjust VR651 so that the pedestal level is 150V.

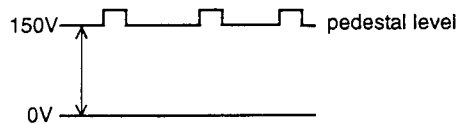

PCB-MAIN (COMPONENT SIDE)

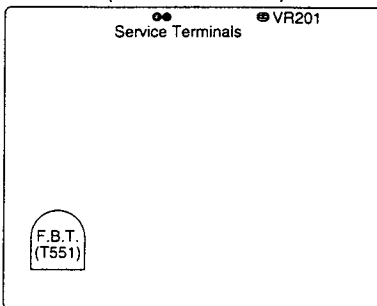

6. Observe the waveform at the collector of Q652. (Use GA connector pin ② for ground.)
7. Adjust VR652 so that the pedestal level is 150V.
8. Observe the waveform at the collector of Q653. (Use GA connector pin ② for ground.)
9. Adjust VR653 so that the pedestal level is 150V.

PCB-CRT (SOLDER SIDE)

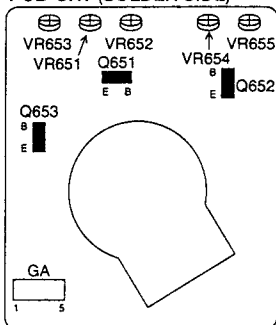

10. Short - circuit the service terminals.
11. Adjust SCREEN control on F.B.T. to the point where one red, green or blue line becomes just visible.
12. Adjust two of VR651, VR652 and VR653 so that the horizontal line is white.
13. Open the service terminals.
14. Supply a video signal (White raster).
15. Adjust VR654 and VR 655 so that the entire screen is pure white.

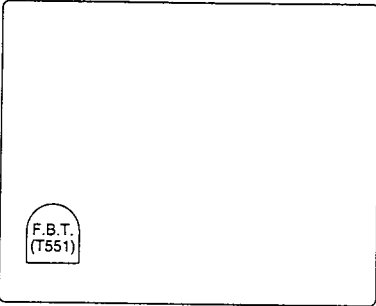
6. Focus		Adjustment purpose Sharpness of picture. Symptom when incorrectly adjusted Poor sharpness of picture.
Measuring instrument	---	<ol style="list-style-type: none"> 1. Supply an RF signal(Programme). 2. Adjust FOCUS volume on F.B.T. to the best overall focus.
Test point	---	
EXT trigger	---	
Measurement range	---	
Input signal	RF signal (Programme)	
Input terminal	RF IN terminal	
<p>PCB-MAIN (COMPONENT SIDE)</p> 		

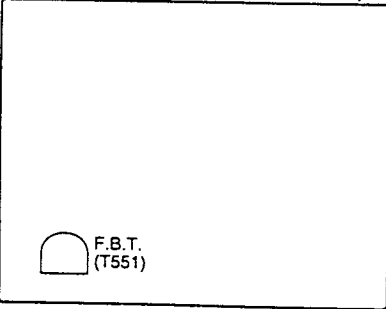
7. Black Level		Adjustment purpose Black level of video signal. Symptom when incorrectly adjusted Too bright or too dark picture.
Measuring instrument	---	<ol style="list-style-type: none"> 1. Supply a video signal (Colour bar). 2. Set COLOUR control to minimum. 3. Make sure that the blue bar area does not brighten. If necessary, adjust SCREEN control on FBT so that the blue bar area does not brighten. 4. Make sure that the red bar area is slightly bright. If necessary, adjust SCREEN control on FBT so that the red bar area is slightly bright.
Test point	---	
EXT trigger	---	
Measurement range	---	
Input signal	Video signal (Colour bar)	
Input terminal	VIDEO IN terminal	
<p>PCB-MAIN (COMPONENT SIDE)</p> 		

[Deflection circuit] 8. Horizontal Centre	Adjustment purpose	Horizontal position of picture.
	Symptom when incorrectly adjusted	Picture too shifted to the left, or the right.

Measuring instrument	---
Test point	---
EXT trigger	---
Measurement range	---
Input signal	Video signal (Monoscope)
Input terminal	VIDEO IN terminal

1. Supply a video signal (Monoscope).
2. Adjust VR531 so that readings of left and right markers are the same.

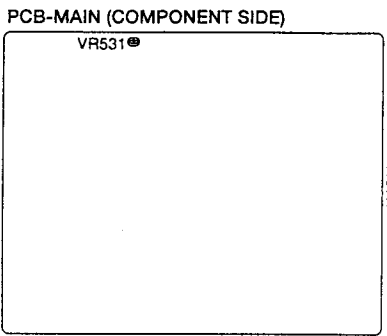
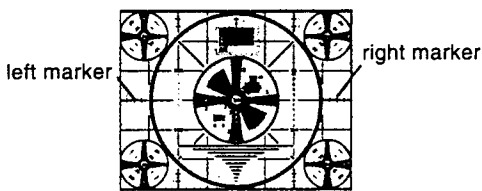

9. East West PCC (25" model only)	Adjustment purpose	Horizontal linearity of picture.
	Symptom when incorrectly adjusted	Horizontal distortion of picture.

Measuring instrument	---
Test point	---
EXT trigger	---
Measurement range	---
Input signal	Video signal (Crosshatch)
Input terminal	VIDEO IN terminal

1. Supply a video signal (Crosshatch).
2. Press OPTIMUM button on the remote hand unit.
3. Observing the second line from both ends on the screen. Adjust VR5E1 so that the upper and lower distortions are symmetrical.
4. Adjust VR5E2 so that the both vertical lines are straight. Repeat step 3 to 4 above, if necessarily.

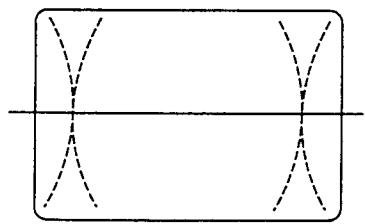
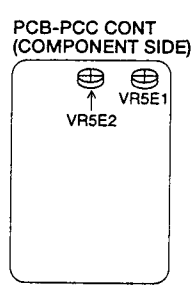

VR5E1

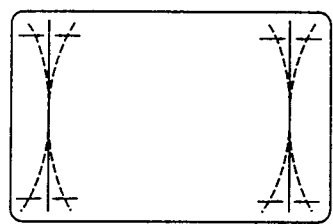

VR5E2

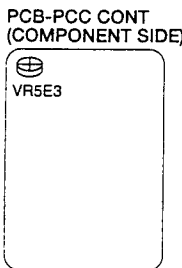
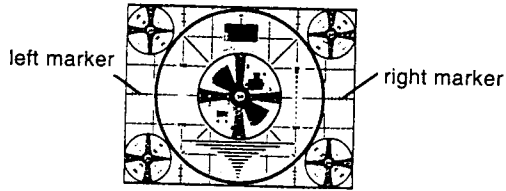
10. Horizontal Width (25" model only)		Adjustment purpose Horizontal width of picture.
		Symptom when incorrectly adjusted Too compressed or too expanded horizontal width of picture.
Measuring instrument	---	<ol style="list-style-type: none"> 1. Supply a video signal (Monoscope). 2. Press OPTIMUM button on the remote hand unit. 3. Adjust VR5E3 so that the sum of left and right markers is 4.5 ~ 5.8 (equivalent to 7 ~ 9% overscan).
Test point	---	
EXT trigger	---	
Measurement range	---	
Input signal	Video signal (Monoscope)	
Input terminal	VIDEO IN terminal	
		

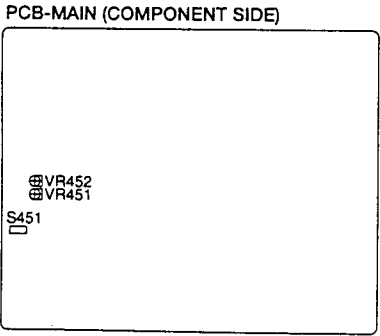
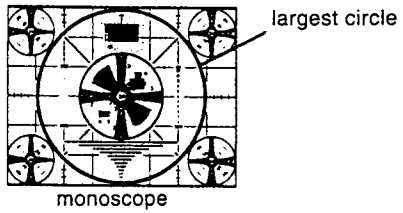
11. Vertical Height, Vertical Linearity, Vertical Centre		Adjustment purpose Vertical and linearity of picture.
		Symptom when incorrectly adjusted Too compressed or too expanded vertical height of picture. Vertical linearity of picture.
Measuring instrument	---	<ol style="list-style-type: none"> 1. Supply a video signal (Monoscope). 2. Press OPTIMUM button on the remote hand unit. 3. Adjust VR452 for approx. 90% vertical size of raster. 4. Adjust VR451 for symmetry of vertical linearity. 5. Adjust VR452 so that the largest circle is a complete round. 6. Adjust S451 so that the largest circle is vertical centre position.
Test point	---	
EXT trigger	---	
Measurement range	---	
Input signal	Video signal (Monoscope)	
Input terminal	VIDEO IN terminal	
		

[Video circuit] 12. Sub Cont		Adjustment purpose The best value of beam current.						
		Symptom when incorrectly adjusted Too bright or too dark picture.						
Measuring instrument	DC milliammeter	* Preheat the set for twenty minutes or more. 1. Supply a video signal (Colour bar). 2. Press OPTIMUM button on the remote hand unit. 3. Observe the beam current values at TP connector pin ① and pin ②. (Plus lead to pin ①) 4. Adjust VR201 so that the beam current is a value listed in the table below.						
Test point	+lead : TPconnector pin① -lead : TPconnector pin②							
EXT trigger	---							
Measurement range	---							
Input signal	Video signal (Colour bar)							
Input terminal	VIDEO IN terminal							
		<table border="1" style="margin-left: auto; margin-right: auto;"> <tr> <td></td> <td style="text-align: center;">21 inch</td> <td style="text-align: center;">25 inch</td> </tr> <tr> <td style="text-align: center;">Beam Current</td> <td style="text-align: center;">875±20µA</td> <td style="text-align: center;">1030±20µA</td> </tr> </table>		21 inch	25 inch	Beam Current	875±20µA	1030±20µA
	21 inch	25 inch						
Beam Current	875±20µA	1030±20µA						
<div style="border: 1px solid black; padding: 5px; margin-top: 10px;"> PCB-MAIN (COMPONENT SIDE) <div style="text-align: right; margin-right: 10px;">● VR201</div> <div style="text-align: right; margin-right: 10px; font-size: small;">FRONT</div> <div style="margin-top: 20px;"> TP 251 </div> </div>								

PARTS LIST

MODEL : CT-21A5LST/CT-21A5STX/CT-25A5STX

In order to expedite delivery of replacement part orders.

- Specify : 1.Model number/Serial number
- 2.Part number and Description
- 3.Quantity

Unless full information is supplied, delay in execution of orders will result.

⚠ : Critical components

MARK	B	C	D	F	G	J	K
TOLERANCE (%)	±0.1	±0.25	±0.5	±1	±2	±5	±10

MARK	M	N	V	X	Z	P	Q
TOLERANCE (%)	±20	±30	+10 -10	+40 -20	+80 -20	+100 -0	+30 -10

MARK	B	C	D	F	G
TOLERANCE (pF)	±0.1	±0.25	±0.5	±1	±2

ABBREVIATION

[21LST]:CT-21A5LST

[21STX]:CT-21A5STX

[25STX]:CT-25A5STX

SYMBOL No.	PARTS No.	PARTS NAME	DESCRIPTION	SYMBOL No.	PARTS No.	PARTS NAME	DESCRIPTION
TUBES							
△ V 271	255P801O10	CRT ASSY	A51EAL55X01[21LST,21STX]	Q 5E2	260P543O30	TRANSISTOR	JC501-R[25STX]
△ V 271	255P930O10	CRT ASSY	A59ECY13X01[25STX]	Q 651	260P571O10	TRANSISTOR	2SC3789-D,E
INTEGRATED CIRCUITS							
IC101	272P847O20	IC	TDA8361	Q 652	260P571O10	TRANSISTOR	2SC3789-D,E
IC2J1	272P575O10	IC	CXA1114P	Q 653	260P571O10	TRANSISTOR	2SC3789-D,E
IC361	272P459O20	IC	TA8200AH	Q 654	260P544O40	TRANSISTOR	JA101-R
IC3J1	272P942O10	IC	TA8776N	Q 702	260P544O40	TRANSISTOR	JA101-R
IC3101	270P068O10	IC	LA7555	Q 703	260P544O40	TRANSISTOR	JA101-R
IC3102	274P340O10	IC	TDA8205	Q 704	260P544O40	TRANSISTOR	JA101-R
IC3103	274P339O10	IC	TDA8204	Q 705	260P543O30	TRANSISTOR	JC501-R
IC3105	272P785O10	IC	μPC78M09AHF	Q 706	260P543O30	TRANSISTOR	JC501-R
IC3106	266P922O20	IC	μPC78M05H	Q 707	260P543O30	TRANSISTOR	JC501-R
IC3107	266P982O10	IC	AN608P	Q 7701	260P543O30	TRANSISTOR	JC501-R
IC451	266P405O10	IC	AN5521	Q 7702	260P543O30	TRANSISTOR	JC501-R
IC5E1	272P406O10	IC	TEA2031A[25STX]	Q 7703	260P543O30	TRANSISTOR	JC501-R
IC601	272P848O10	IC	TDA4661	Q 7707	260P543O30	TRANSISTOR	JC501-R
IC701	274P336O10	IC	P83CL168	Q 901	260P572O10	TRANSISTOR	2SD1556
IC702	263P434O20	IC	X24C04P	Q 902	260P543O30	TRANSISTOR	JC501-R
IC703	266P010O20	IC	μPC574J-K	Q 953	260P543O30	TRANSISTOR	JC501-R
IC7701	263P622O20	IC	HM6264ALSP10/12	Q 954	260P668O10	TRANSISTOR	2SB1135-R,S
IC7702	274P050O20	IC	SAA5246AP	Q 955	260P325O30	TRANSISTOR	2SC2655-Y
IC7703	272P027O10	IC	AN5862K	Q 975	260P544O40	TRANSISTOR	JA101-R
IC7704	272P400O10	IC	NJM2233BL	DIODES			
IC901	272P514O10	IC	TEA2261	D 102	264P370O10	DIODE	1N4148
IC951	267P076O10	IC	SI-3120C	D 231	264P483O80	DIODE	RD5.1FB2
IC952	266P922O10	IC	μPC78M05H	D 232	264P483O80	DIODE	RD5.1FB2
IC954	272P856O10	IC	μPC78M08AHF	D 233	264P483O80	DIODE	RD5.1FB2
IC955	272P502O10	IC	μPC2412HF	D 234	264P483O80	DIODE	RD5.1FB2
TRANSISTORS				D 235	264P483O80	DIODE	RD5.1FB2
Q 111	260P543O30	TRANSISTOR	JC501-R	D 251	264P483O80	DIODE	RD5.1FB2
Q 112	260P543O30	TRANSISTOR	JC501-R	D 252	264P483O80	DIODE	RD5.1FB2
Q 201	260P543O30	TRANSISTOR	JC501-R	D 253	264P483O80	DIODE	RD5.1FB2
Q 202	260P543O30	TRANSISTOR	JC501-R	D 280	264P462O90	DIODE	RD7.5EB3
Q 203	260P544O40	TRANSISTOR	JA101-R	D 281	264P462O90	DIODE	RD7.5EB3
Q 261	260P544O40	TRANSISTOR	JA101-R	D 282	264P462O90	DIODE	RD7.5EB3
Q 2J1	260P543O30	TRANSISTOR	JC501-R	D 2J1	264P464O30	DIODE	RD10EB2
Q 2J2	260P543O30	TRANSISTOR	JC501-R	D 361	264P370O10	DIODE	1N4148
Q 2J3	260P543O30	TRANSISTOR	JC501-R	D 362	264P370O10	DIODE	1N4148
Q 2J4	260P543O30	TRANSISTOR	JC501-R	D 363	264P370O10	DIODE	1N4148
Q 2J5	260P387O30	TRANSISTOR	2SC2236-Y	D 364	264P370O10	DIODE	1N4148
Q 361	260P544O40	TRANSISTOR	JA101-R	D 365	264P463O20	DIODE	RD8.2EB2
Q 3101	260P356O10	TRANSISTOR	2SC1906	D 451	264P371O10	DIODE	BYD33G
Q 3102	260P544O40	TRANSISTOR	JA101-R	D 452	264P371O10	DIODE	BYD33G
Q 3104	260P543O30	TRANSISTOR	JC501-R	D 453	264P371O10	DIODE	BYD33G
Q 3105	260P543O30	TRANSISTOR	JC501-R	D 531	264P370O10	DIODE	1N4148
Q 3106	260P543O30	TRANSISTOR	JC501-R	D 551	264P533O30	DIODE	RS 4FS[25STX]
Q 401	260P543O30	TRANSISTOR	JC501-R	D 552	264P358O70	DIODE	RU 4AM[25STX]
Q 402	260P543O30	TRANSISTOR	JC501-R	D 553	264P371O10	DIODE	BYD33G
Q 431	260P349O20	TRANSISTOR	2SC1472K-B[25STX]	D 554	264P463O20	DIODE	RD8.2EB2
Q 551	260P576O10	TRANSISTOR	2SD1554[21LST,21STX]	D 555	264P371O10	DIODE	BYD33G
Q 551	260P557O10	TRANSISTOR	2SD1555[25STX]	D 556	264P371O10	DIODE	BYD33G
Q 552	260P422O10	TRANSISTOR	2SC2482	D 557	264P456O60	DIODE	RD2.2EB2[21LST,25STX]
Q 5E1	260P543O30	TRANSISTOR	JC501-R[25STX]	D 557	264P465O10	DIODE	RD12EB1[21STX]
				D 558	264P371O10	DIODE	BYD33G
				D 559	264P463O60	DIODE	RD9.1EB1
				D 563	264P370O10	DIODE	1N4148
				D 5E1	264P370O10	DIODE	1N4148[25STX]

YMBOL No.	PARTS No.	PARTS NAME	DESCRIPTION	SYMBOL No.	PARTS No.	PARTS NAME	DESCRIPTION
D 5E2	264P467080	DIODE	RD20EB3[25STX]	L 114	325C162000	PEAKING COIL	39μH-K
D 601	264P483080	DIODE	RD5.1FB2	L 151	325C121030	PEAKING COIL	10μH-K
D 651	264P370010	DIODE	1N4148	L 152	325C121030	PEAKING COIL	10μH-K
D 653	264P371010	DIODE	BYD33G	L 201	325C122050	PEAKING COIL	100μH-K
D 701	264P370010	DIODE	1N4148[21LST]	L 2J1	325C110010	PEAKING COIL	1.0μH-K
D 702	264P370010	DIODE	1N4148[21LST]	L 2J2	325C110010	PEAKING COIL	1.0μH-K
D 710	264P370010	DIODE	1N4148	L 3K1	325C110010	PEAKING COIL	1.0μH-K
D 711	264P370010	DIODE	1N4148	L 3101	325C122030	PEAKING COIL	68μH-K
D 712	264P370010	DIODE	1N4148	L 3102	325C120040	PEAKING COIL	1.8μH-M/K
D 713	264P370010	DIODE	1N4148	L 3103	325C122030	PEAKING COIL	68μH-K
D 714	264P370010	DIODE	1N4148	L 3104	325C122030	PEAKING COIL	68μH-K
D 7E1	264P584020	LIGHT EMITTING DIODE	SML1216W-C,D	L 3105	325C121030	PEAKING COIL	10μH-K
D 7701	264P370010	DIODE	1N4148	L 3106	325C121030	PEAKING COIL	10μH-K
D 7702	264P370010	DIODE	1N4148	L 3107	325C121030	PEAKING COIL	10μH-K
D 7703	264P370010	DIODE	1N4148	L 3108	325C113020	PEAKING COIL	390μH-K
D 7704	264P370010	DIODE	1N4148	L 3109	325C113020	PEAKING COIL	390μH-K
D 901	264P376010	DIODE	BYW56	L 3110	323P184010	VIF COIL	
D 902	264P376010	DIODE	BYW56	L 3111	327P074010	SIF COIL	5.5/6.0MHz
D 903	264P376010	DIODE	BYW56	L 531	325C120010	PEAKING COIL	1.0μH-M
D 904	264P376010	DIODE	BYW56	L 532	325C120010	PEAKING COIL	1.0μH-M
D 905	264P371010	DIODE	BYD33G	L 551	321C030010	RF COIL	1.0μH-K
D 906	264P372010	DIODE	BYV96E	L 552	411D009020	FERRITE CORE FILTER	
D 907	264P481060	DIODE	RD3.0FB2	L 553	333P012030	H-LIN. COIL	[21LST,21STX]
D 908	264P370010	DIODE	1N4148	L 553	333P012010	H-LIN. COIL	[25STX]
D 909	264P481060	DIODE	RD3.0FB2	L 554	409P748010	PCC COIL	1MHz[25STX]
D 951	264P358070	DIODE	RU 4AM	L 555	409P749010	CHOKE COIL	15MHz[25STX]
D 952	264P377010	DIODE	BYW95B	L 5E1	325C302000	PEAKING COIL	39μH-K[25STX]
D 953	264P377010	DIODE	BYW95B	L 701	325C121030	PEAKING COIL	10μH-K
D 954	264P377010	DIODE	BYW95B	L 702	325C121030	PEAKING COIL	10μH-K
D 955	264P461080	DIODE	RD6.2EB3	L 703	325C121030	PEAKING COIL	10μH-K
D 956	264P370010	DIODE	1N4148	L 704	325C121030	PEAKING COIL	10μH-K
D 960	264P377010	DIODE	BYW95B	L 705	325C120010	PEAKING COIL	1.0μH-M
D 961	264P370010	DIODE	1N4148	L 706	325C120010	PEAKING COIL	1.0μH-M
OTHER SEMICONDUCTORS				L 707	325C120010	PEAKING COIL	1.0μH-M
RP991	265P071050	POSITIVE THERMISTOR	<180Ω>	L 7701	325C121030	PEAKING COIL	10μH-K
TH531	269P020010	THYRISTOR	N13T1	L 7702	325C110090	PEAKING COIL	4.7μH-K
FILTERS				L 7703	325C121030	PEAKING COIL	10μH-K
CF111	296P024040	CERAMIC TRAP	TPS6.0MB	L 7704	321C031040	RF COIL	10μH-K
CF3101	296P014030	CERAMIC FILTER	SFE-6.0MHz	L 7705	325C121030	PEAKING COIL	10μH-K
CF3103	296P014030	CERAMIC FILTER	SFE-6.0MHz	L 901	325C121010	PEAKING COIL	6.8μH-K
LC3101	409P453010	BAND PASS FILTER		L 902	321C030050	RF COIL	2.2μH-K
SF101	296P088050	SAW FILTER	KAF-39.5MR-MJ	L 903	411P001070	FERRITE LEAD	BF60T
SF3101	296P112020	SAW FILTER	SAF32.9MDE70Z	L 905	411P001070	FERRITE LEAD	BF60T
COILS				L 951	325D059060	PEAKING COIL	390μH-K
Δ	409B099010	DEGAUSSING COIL	[21LST,21STX]	L 952	409P674010	FILTER COIL	
Δ	409B041080	DEGAUSSING COIL	[25STX]	L 953	409P674010	FILTER COIL	
L 101	325C114030	PEAKING COIL	LAL03NAR22M	L 992	351P044010	LINE FILTER	AT4043/90
L 104	323P175020	VIF COIL	38.9 39.5MHz	L 997	351P011020	LINE FILTER	700MHz
L 105	321C041050	RF COIL	JISC-3212-0.4	TRANSFORMERS			
L 111	325C120010	PEAKING COIL	1.0μH-M	Δ T 551	334P220020	FLYBACK	[21LST,21STX]
L 112	325C161030	PEAKING COIL	10μH-K	T 552	336P017010	H.DRIVE	
L 113	325C160050	PEAKING COIL	2.2μH-K[21LST,25STX]	Δ T 901	350P597010	POWER	[21LST,21STX]
L 113	325C110050	PEAKING COIL	2.2μH-K[21STX]	Δ T 901	350P597020	POWER	[25STX]

SYMBOL No.	PARTS No.	PARTS NAME	DESCRIPTION	SYMBOL No.	PARTS No.	PARTS NAME	DESCRIPTION
VARIABLE RESISTORS							
VR101	127C380O80	VR-SEMI-FIXED	1/5W B10KΩ-M	SP392	480P025O10	SPEAKER	WITH BACK COVER
VR201	127C181O20	VR-SEMI-FIXED	1/5W B100KΩ-M	SP393	480P026O10	SPEAKER	WITH FRONT
VR451	127C380O70	VR-SEMI-FIXED	1/5W B5KΩ-M[25STX]	SP394	480P026O10	SPEAKER	WITH FRONT
VR452	127C380O10	VR-SEMI-FIXED	1/5W B200Ω-M	TU101	295P400O50	TUNER	ENV59888G3[21LST]
VR531	127C180O80	VR-SEMI-FIXED	1/10W B10KΩ-M	TU101	295P400O10	TUNER	ENV87867G3[21STX,25STX]
VR5E1	127C180O60	VR-SEMI-FIXED	1/5W B3KΩ-M[25STX]	X 3101	285P154O10	CRYSTAL RESONATOR	11.648MHz
VR5E2	127C181O50	VR-SEMI-FIXED	1/5W B500KΩ-M[25STX]	X 601	285P132O20	CRYSTAL RESONATOR	TDA8362
VR5E3	127C190O50	VR-SEMI-FIXED	1/5W B2KΩ-M[25STX]	X 701	285P139O30	CRYSTAL RESONATOR	12MHz
VR651	127C180O10	VR-SEMI-FIXED	1/5W B200Ω-M	X 7701	285P157O10	CRYSTAL RESONATOR	27MHz
VR652	127C180O10	VR-SEMI-FIXED	1/5W B200Ω-M	△ Z 551	299P087O80	SURGE PROTECTOR	PRF 3150[25STX]
VR653	127C180O10	VR-SEMI-FIXED	1/5W B200Ω-M	Z 7E1	939P226O20	PREAMP UNIT	SBX160-45
VR654	127C180O40	VR-SEMI-FIXED	1/5W B1KΩ-M	△ Z 951	299P087O80	SURGE PROTECTOR	PRF 3150
VR655	127C180O40	VR-SEMI-FIXED	1/5W B1KΩ-M	△ Z 953	299P132O10	SURGE PROTECTOR	PRF 5000
VR951	127C380O80	VR-SEMI-FIXED	1/5W B10KΩ-M[21LST,21STX]	PRINTED CIRCUIT BOARD ASSY'S			
VR951	127C380O90	VR-SEMI-FIXED	1/5W B20KΩ-M[25STX]	△	930C758O01	AV PCB ASSY	
RESISTORS				△	930C759O02	CRT PCB ASSY	[21LST,21STX]
△ R 361	103P398O40	FUSE	1/2W 2.2Ω-J	△	930C759O01	CRT PCB ASSY	[25STX]
△ R 362	103P398O40	FUSE	1/2W 2.2Ω-J	△	930C757O01	LED-P PCB ASSY	
△ R 456	103P378O40	FUSE	1/4W 2.2Ω-J	△	920A404O03	MAIN PCB ASSY	[21LST]
R 554	102P243O20	CEMENT METAL	5W 3.9KΩ-K/J	△	920A404O01	MAIN PCB ASSY	[21STX]
R 557	102P220O10	CEMENT WIRE	10W 10Ω-K/J	△	920A404O02	MAIN PCB ASSY	[25STX]
△ R 558	103P442O50	FUSE METAL	1W 1KΩ-K/J	△	930C679O01	NICAM PCB ASSY	
△ R 559	103P397O90	FUSE	1/2W 0.82Ω-J[21LST,21STX]	△	930C760O01	PCC PCB ASSY	[25STX]
△ R 561	103P397O90	FUSE	1/2W 0.82Ω-J	△	930C756O01	POWER SUB PCB ASSY	
△ R 566	103P378O00	FUSE	1/4W 1.0Ω-J	△	930C678O01	TEXT PCB ASSY	
△ R 671	103P437O80	FUSE METAL	2W 0.68Ω-K/J[25STX]	MECHANICAL PARTS			
△ R 681	103P448O40	FUSE METAL	1W 2.2Ω-K/J[21LST,21STX]	669D220O30	SCREW	3X10 46LA005	
R 7B5	109D021O20	COMPOSITION	1/2W 6.8MΩ-K	669D221O60	SCREW	4X16 46LA005	
R 921	109D074O10	CEMENT METAL	5W 1.8KΩ-K/J	COSMETIC PARTS			
△ R 981	109D021O20	COMPOSITION	1/2W 6.8MΩ-K	△	246C162O10	AC POWER CORD	
△ R 982	109D021O20	COMPOSITION	1/2W 6.8MΩ-K	△	700C161O90	BACK COVER	[21LST]
R 993	102P081O40	CEMENT WIRE	7W 4.7Ω-K	△	700C159O10	BACK COVER	[21STX]
CAPACITORS AND TRIMMERS				△	700C161O80	BACK COVER	[25STX]
C 556	172P171O60	C-M-PP	1600V 0.018μF-J[25STX]	△	704C904O10	BUTTON POWER	[21LST,25STX]
C 904	185D064O30	ELECTROLYTIC-C	H450V 150μF-M	702C938O90	DOOR	[21LST,25STX]	
△ C 981	189P091O10	CERAMIC CAPACITOR	AC400V E4700pF-M	761C437O10	DOOR CATCH		
△ C 991	189P117O30	C-M-P-AC	AC250V 0.22μF-M	700A693O10	FRONT CABINET	[21LST,21STX]	
SWITCHES				750A017O10	FRONT CABINET	[25STX]	
S 451	434C021O10	LEVER SWITCH	1-3	PACKING PARTS AND ACCESSORY			
S 701	432P066O30	KEY BOARD SWITCH	1-1 L=8.35 S	803A342O10	PACKING CUSHION	[21LST,21STX]	
S 702	432P066O30	KEY BOARD SWITCH	1-1 L=8.35 S	803A354O10	PACKING CUSHION	[25STX]	
S 703	432P066O30	KEY BOARD SWITCH	1-1 L=8.35 S	△	872C084O90	INSTRUCTION BOOK	[21LST]
S 706	432P066O30	KEY BOARD SWITCH	1-1 L=8.35 S	△	872C084O70	INSTRUCTION BOOK	[21STX,25STX]
△ S 991	432C048O10	PUSH SWITCH	AC250V 5A/80A	831D283O10	PACKING BAG		
MISCELLANEOUS				831D287O10	PACKING BAG	[21LST,21STX]	
△	449C081O10	CRT SOCKET		831D287O20	PACKING BAG	[25STX]	
△ F 991	283D091O40	FUSE	T2A H250V	801C227O10	PACKING CASE	[21LST,21STX]	
J 361	451C174O10	MICROPHONE JACK		801C238O10	PACKING CASE	[25STX]	
△ PC951	268P068O10	PHOTO COUPLER	TCDT1124G	△	290P023O10	REMOTE HAND UNIT	
SP391	480P025O10	SPEAKER	WITH BACK COVER				

[MEMO]



[MEMO]

[MEMO]



SCHEMA

E14SF CHASSI

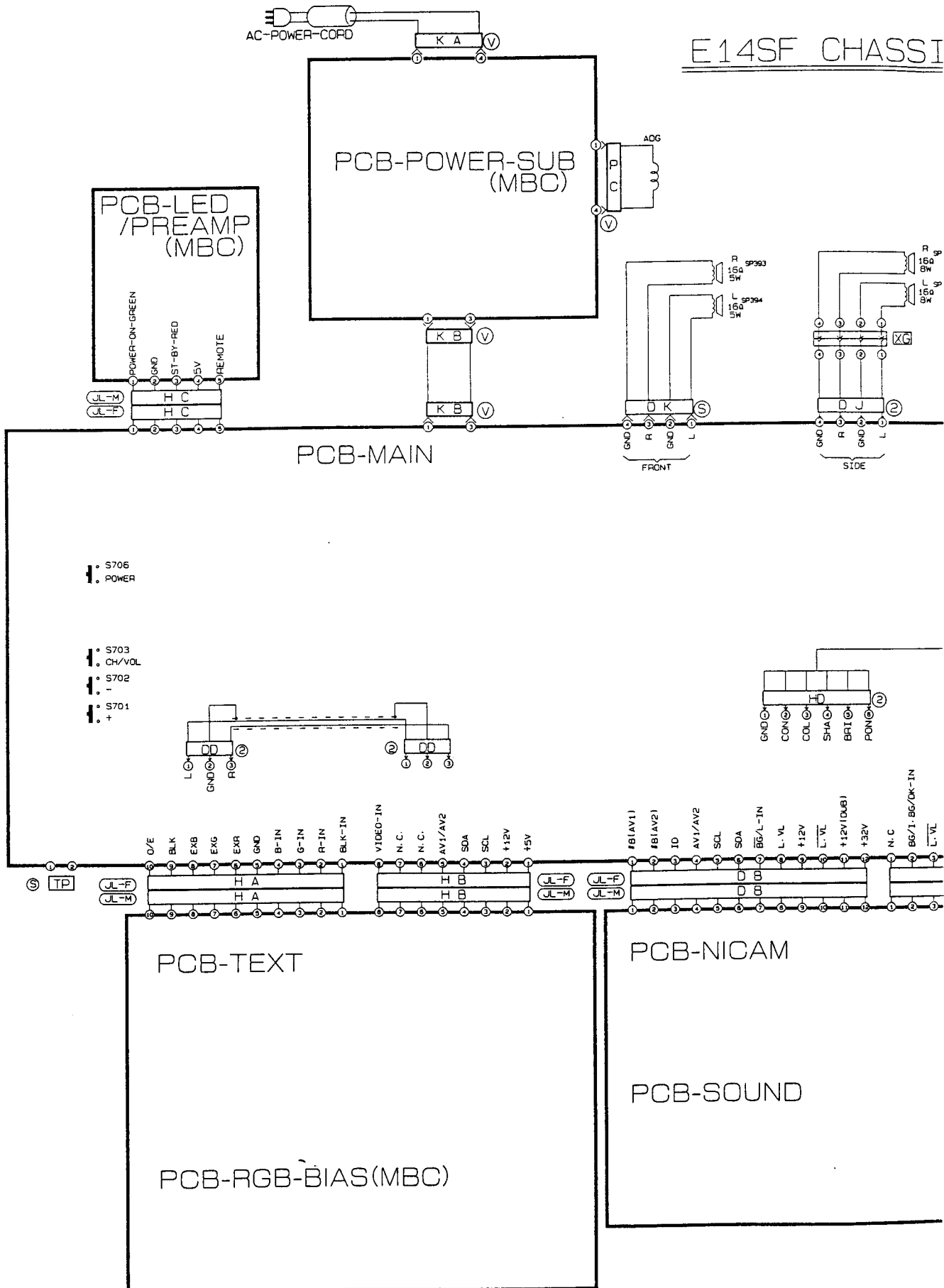

SCHEMATIC DIAGRAM MOU

E14SF CHASSIS BLOCK DIAGRAM

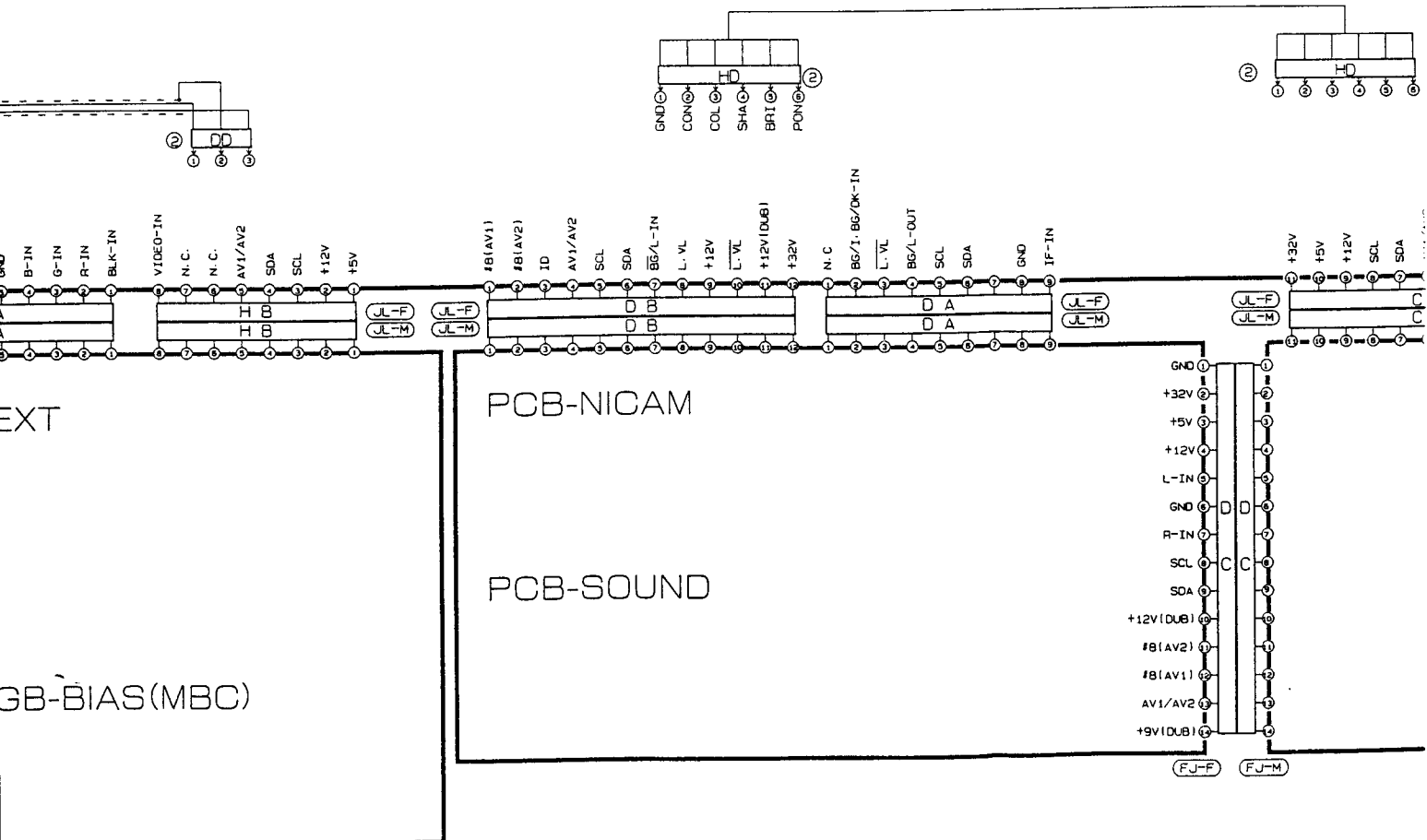
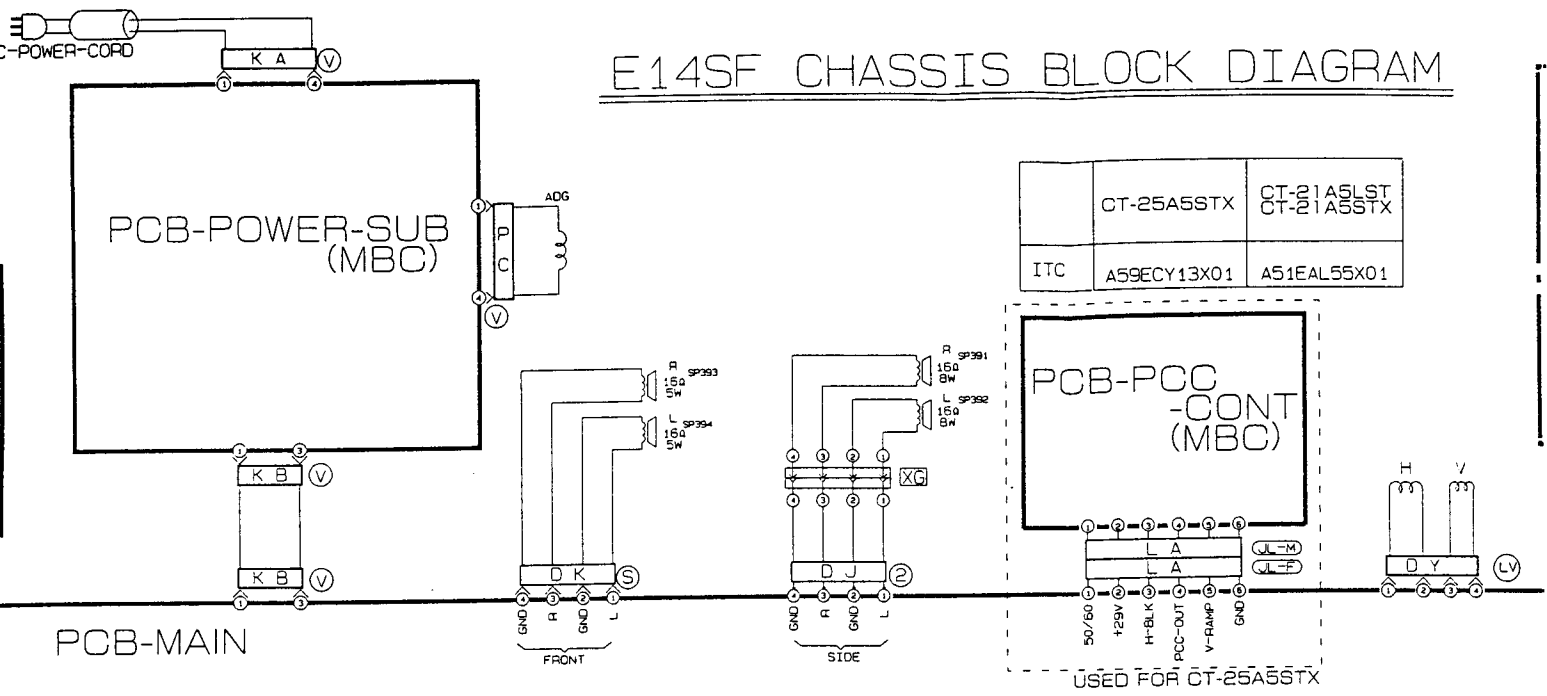

ATIC DIAGRAM MODELS : CT-21A5LST CT-21A5STX CT-25A5STX

IS BLOCK DIAGRAM

	CT-25A5STX	CT-21A5LST CT-21A5STX
ITC	A59ECY13X01	A51EAL55X01

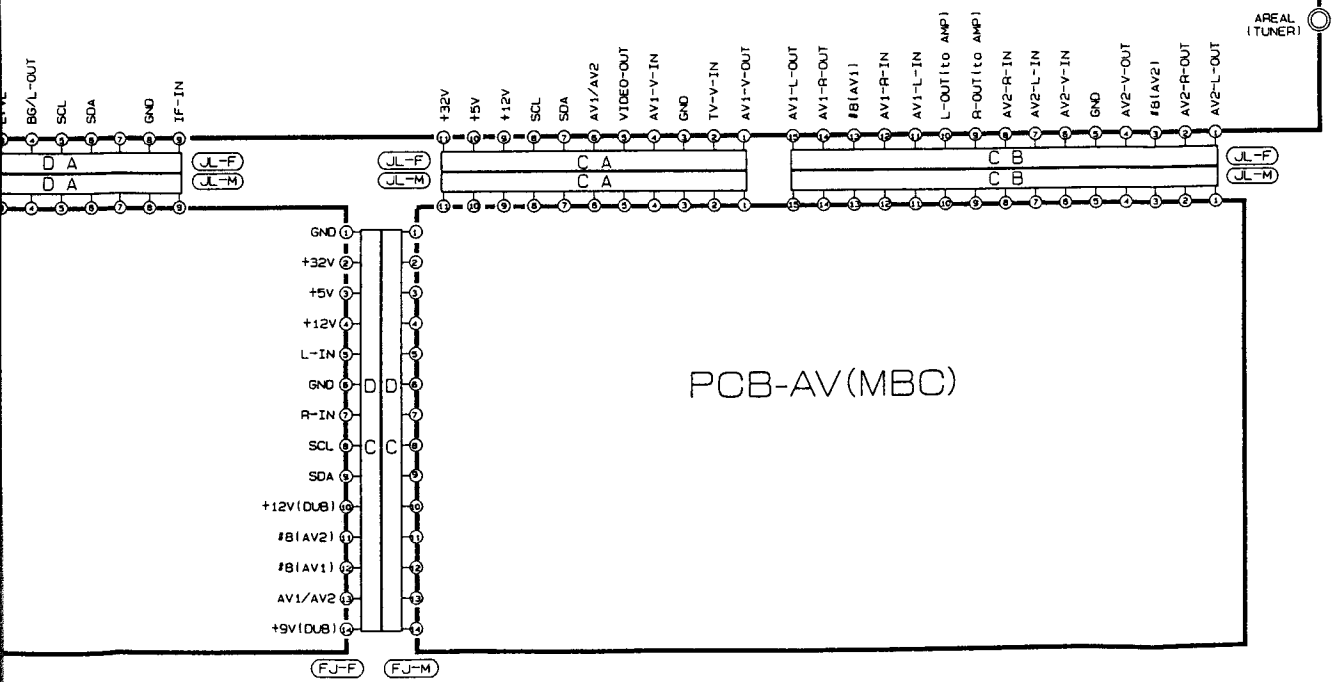
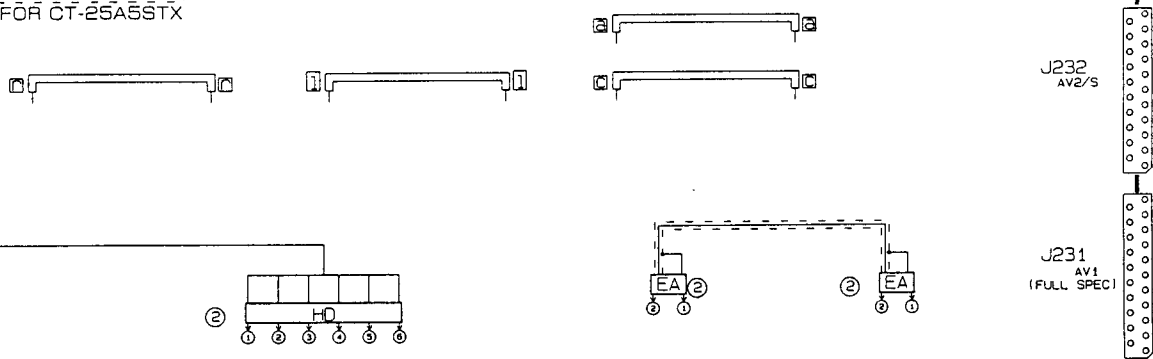
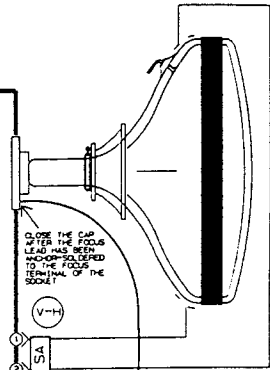
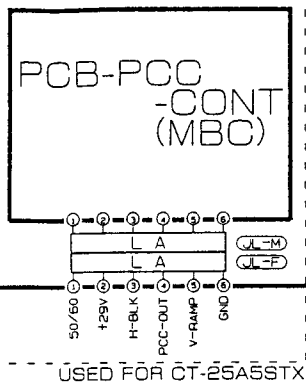

AREAL (TUNER)

SCHEMATIC DIAGRAM MODE

E14SF CHASSIS BLOCK DIAGRAM

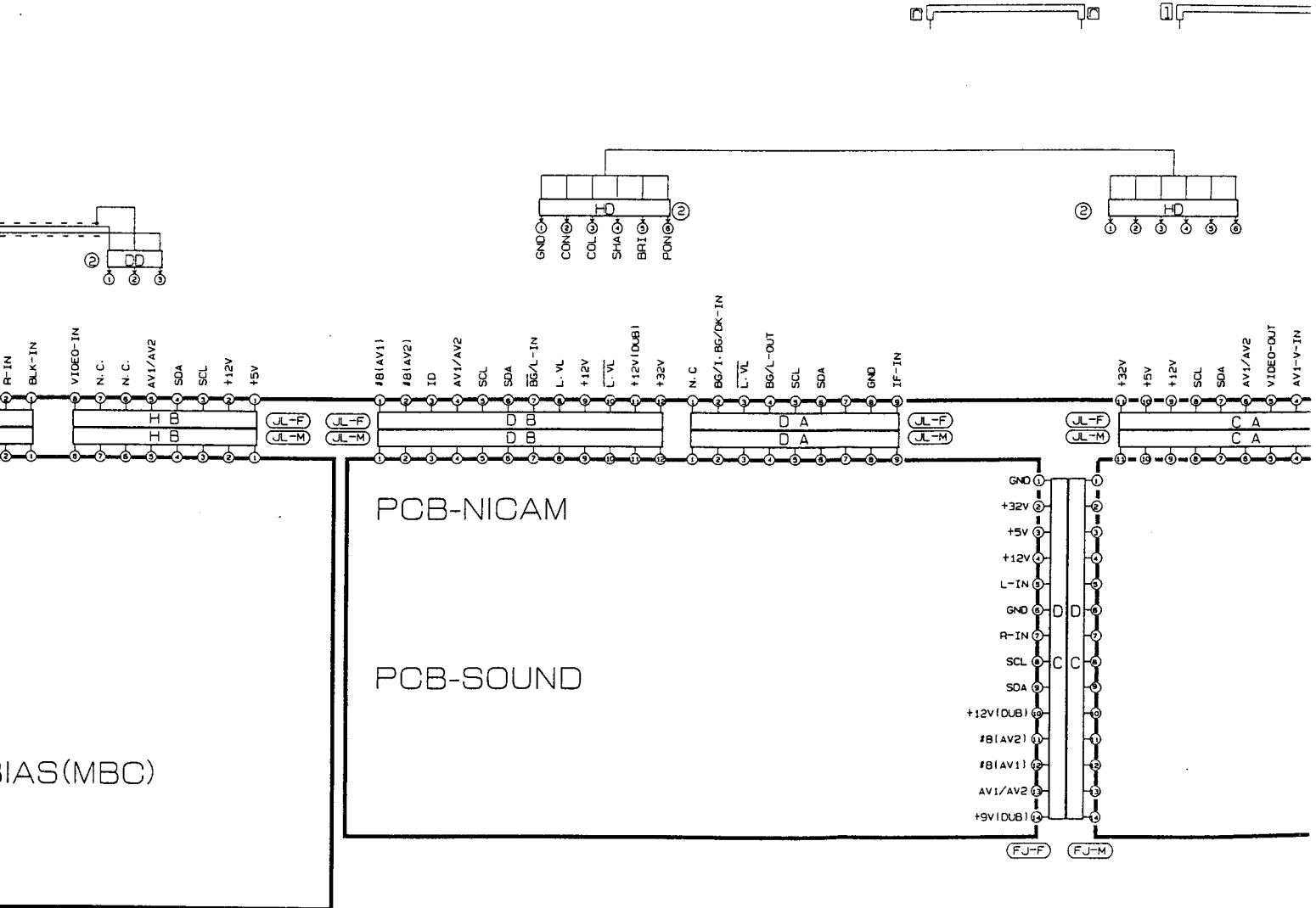
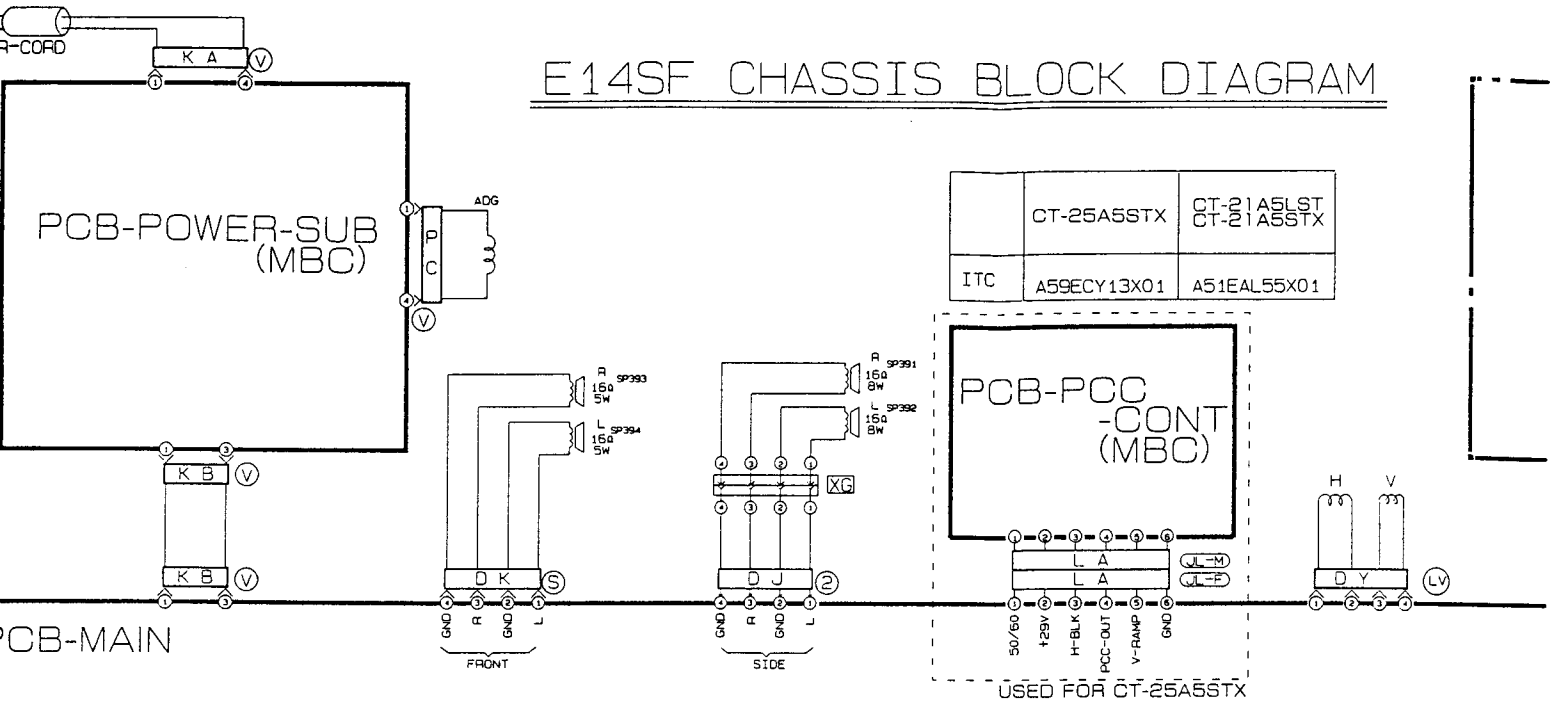

SCHEMATIC DIAGRAM MODELS : CT-21A5L CT-21A5S CT-25A5S

E14SF CHASSIS BLOCK DIAGRAM

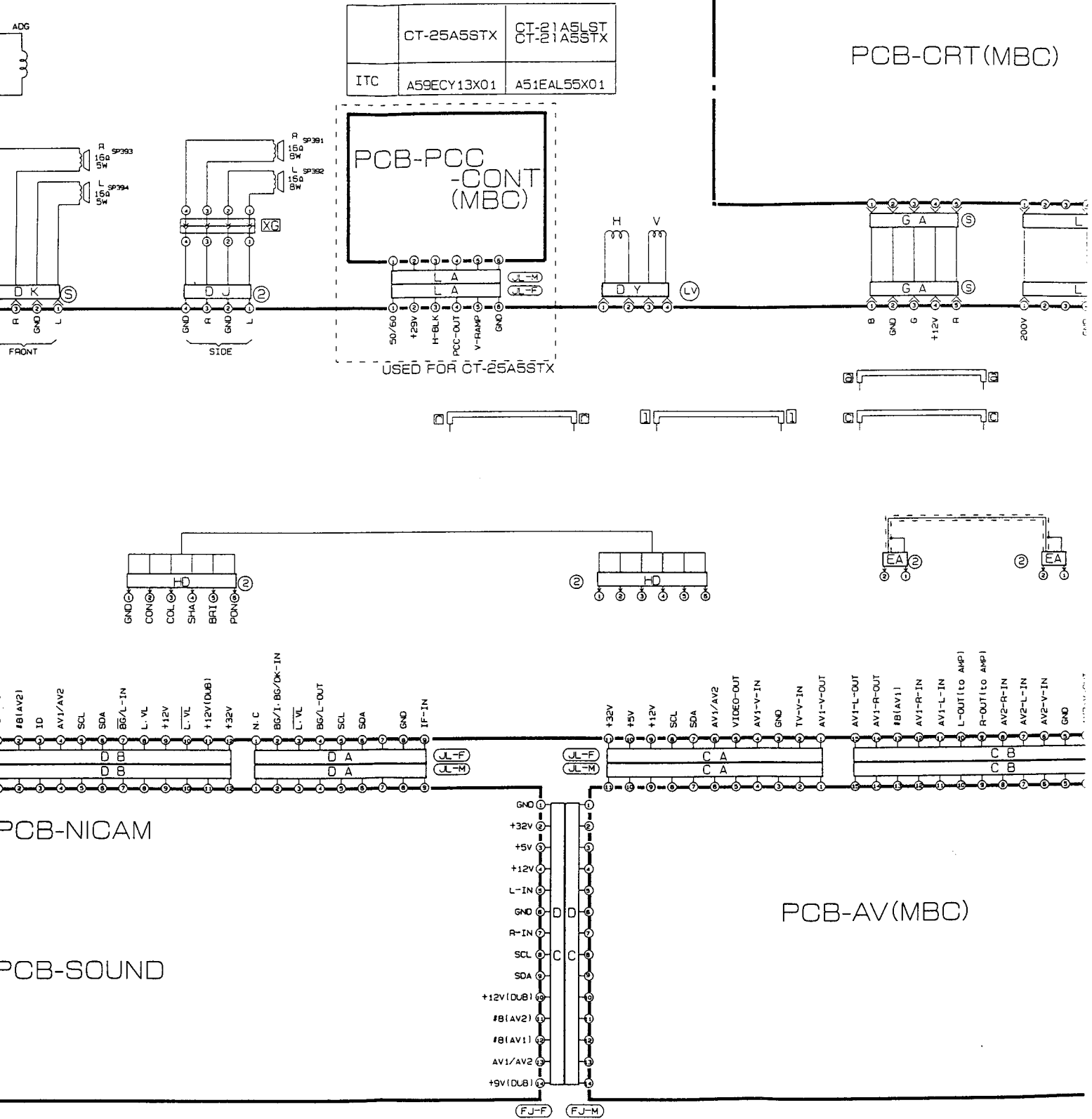

ELS : CT-21A5LST
 CT-21A5STX
 CT-25A5STX

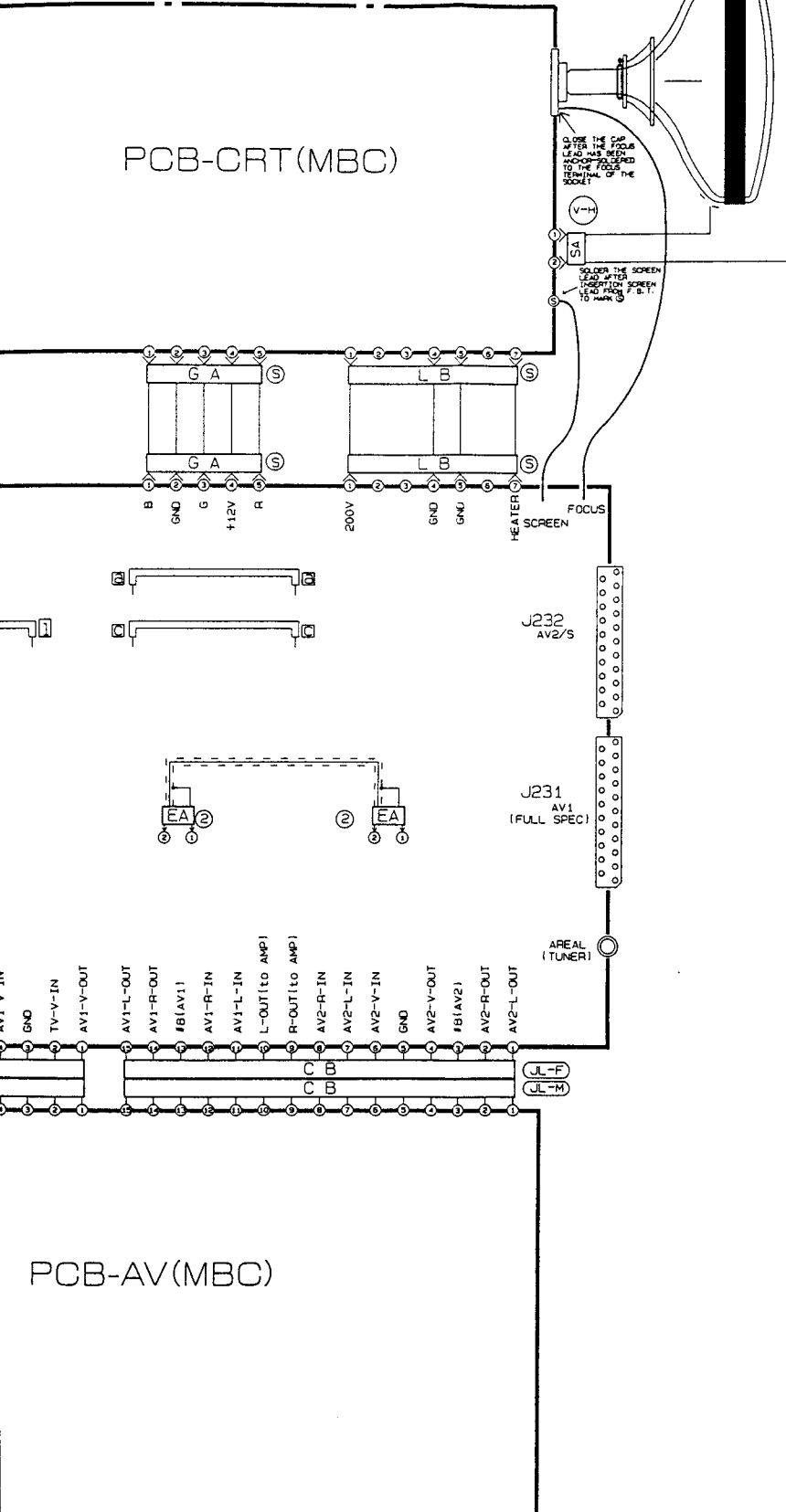

SERVICING PRECAUTION

SYMBOLS INDICATE COMPONENTS HAVING SPECIAL CHARACTERISTICS IMPORTANT TO SAFETY AND PERFORMANCE. THEREFORE REPLACEMENT OF ANY SAFETY PARTS SHOULD BE IDENTICAL IN VALUE AND CHARACTERISTICS. FOR ACCURACY OF THE REPLACEMENT REFER TO THE PARTS LIST OF SERVICE MANUAL.
 DON'T DEGRADE THE SAFETY OF THE RECEIVERS THROUGH IMPROPER SERVICING.

NOTE

- DC voltages were measured from points indicated to the circuit ground with a high-Z voltmeter.
- Waveforms were taken with standard colour bar signal.
- TP6A, etc. show Test Points.
- CAPACITORS

Value	Not indicated	PF, for numbers more than 1 μF, for numbers less than 1
Dielectric Strength	Not indicated :50V	
Tolerance	Not indicated =±10% No Tolerance is indicated for electrolytic capacitors and ±20%	
	G=±2% J=±5% K=±10% M=±20%	P=+100% -0% Z=+80% -20% Q=+30% -10% T=+200% -0% C=±0.25PF D=±0.5PF F=±1PF G=±2PF
Sort	Not indicated : Ceramic capacitor (MP) : Polyester capacitor (PP) : Polypropylene film capacitor (ALM) : Aluminum electrolytic capacitor (TF) : Twin film capacitor (SC) : Semiconductor ceramic capacitor (MP) : Metalized paper (MPP) : Metalized plastic film capacitor (MMP) : Metalized polyester capacitor (MFPP) : Polyester polypropylene film capacitor (PS) : Styrol capacitor (TAN) or (TANT) : Tantalum capacitor (E) : Electrolytic capacitor (BP) or (NP) : Non polarized electrolytic capacitor	
	Not indicated : Ceramic capacitor chip (E) : Electrolytic capacitor chip (BP) or (NP) : Non polarized electrolytic capacitor chip	
Characteristic (only ceramic capacitor)	Not indicated : F or B (high dielectric percentage) CH, SL, etc. : Temperature compensating types	

5. Resistors

Value	Not indicated = Ω K = kΩ(1000Ω) M = MΩ(1000kΩ)	
Wattage	Parts except for chips	Not indicated = 1/4W or 1/8W
	Chips	Not indicated = 1/10W
Tolerance	Not indicated = ±5% D = ±0.5% F = ±1%	
	J = ±5% K = ±10%	
Short	Not indicated : Carbon resistor (S) : Fixed composition resistor (MB) : Metal oxide film resistor (type B) (CE) : Cemented resistor (W) : Wire wound resistor (M) : Metal film resistor (MPC) : Metal plate cement resistor (ML) : Metal liner resistor	
	II Chip	Not indicated : Chip resistor

6. This is a basic schematic diagram. Some sets may be subject to modification according to engineering improvement.

SPECIFIC SYMBOL

	Zener Diode		Crystal unit
	Varicap		Air Gap
	Posistor		Part(resistor) attached on the copper-foil side of PCB
	Thermistor		Ceramic filter
	Fusible Resistor		

CT-21A5LST
 CT-21A5STX
 CT-25A5STX

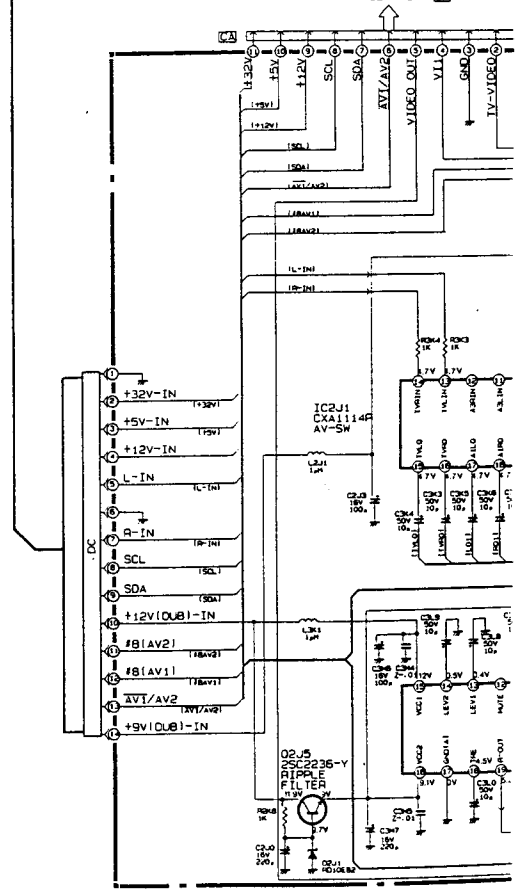
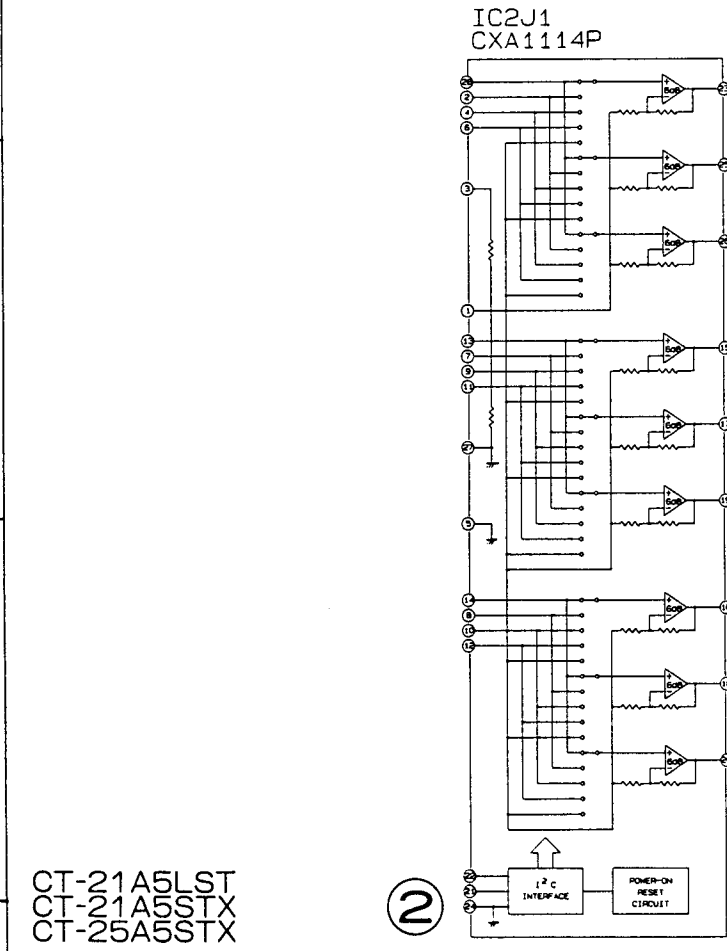
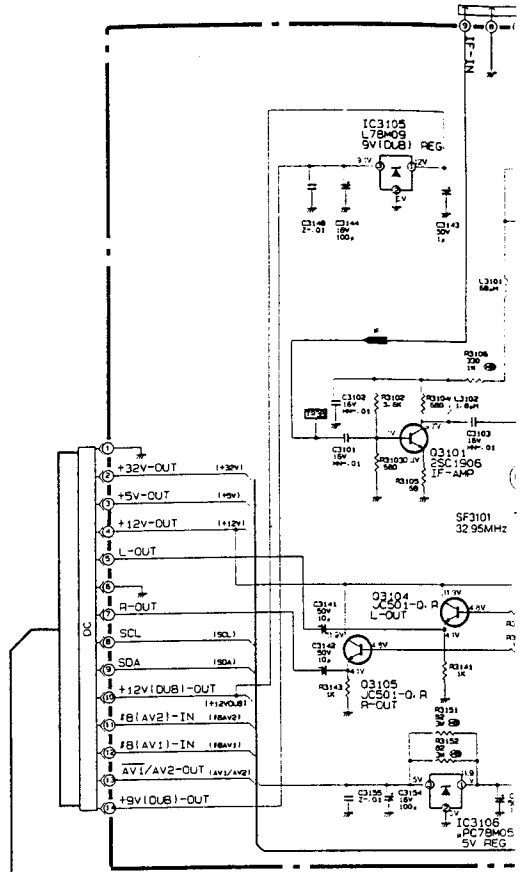
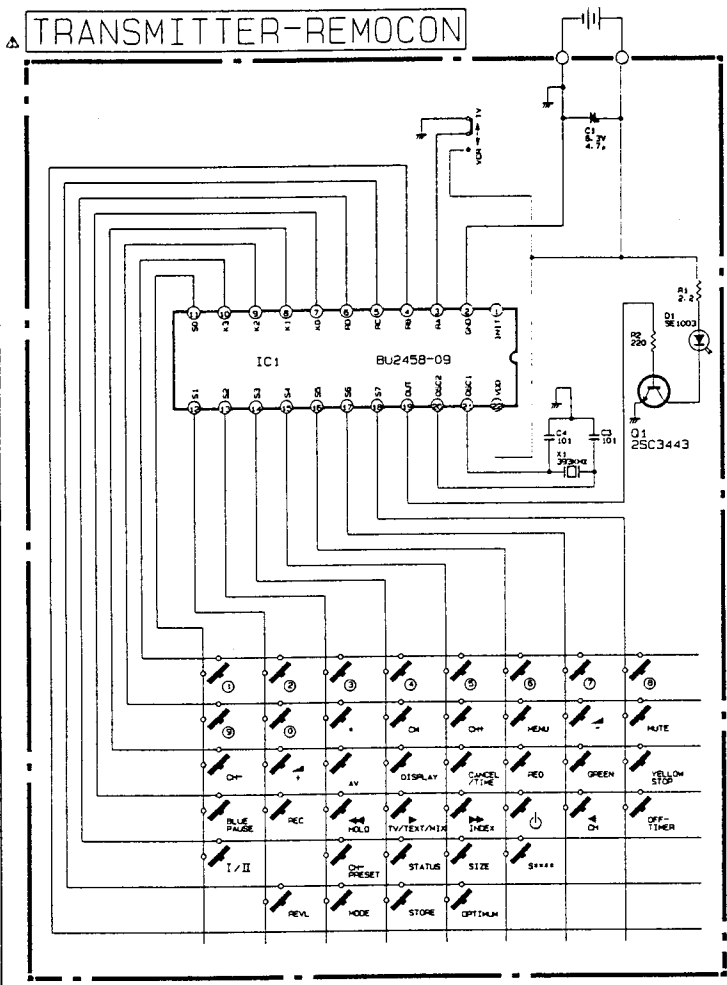

CT-21A5LST
 CT-21A5STX
 CT-25A5STX

2

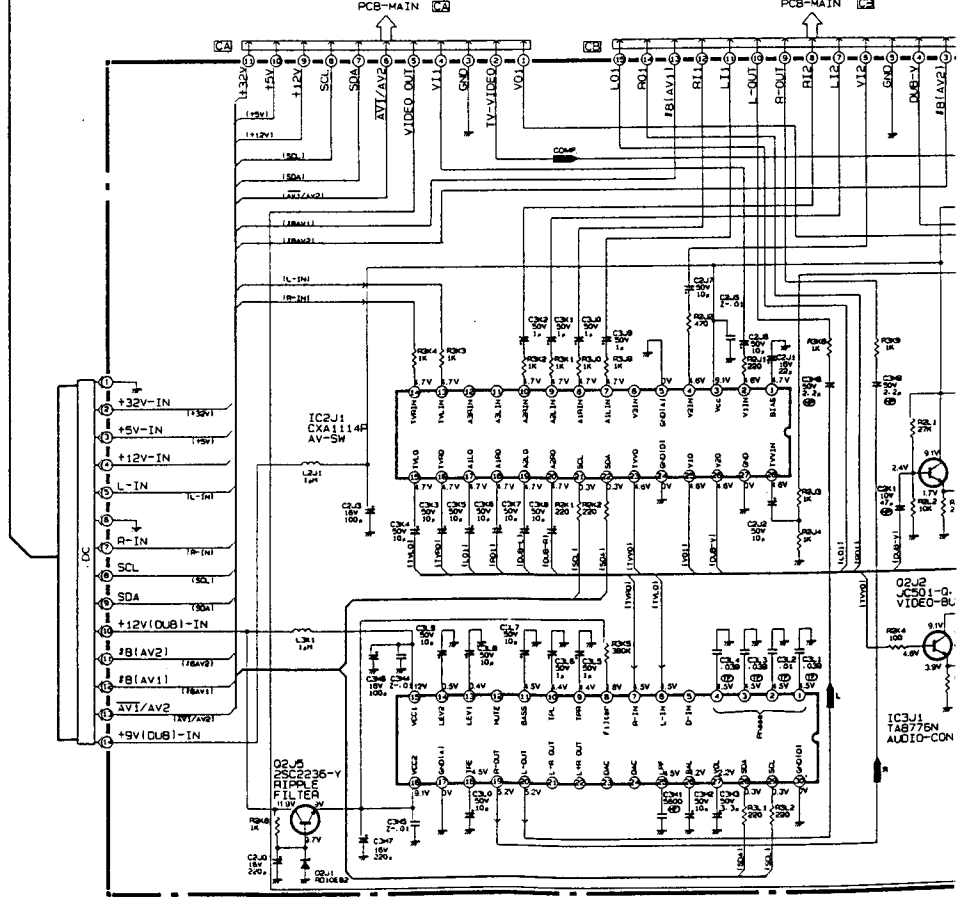
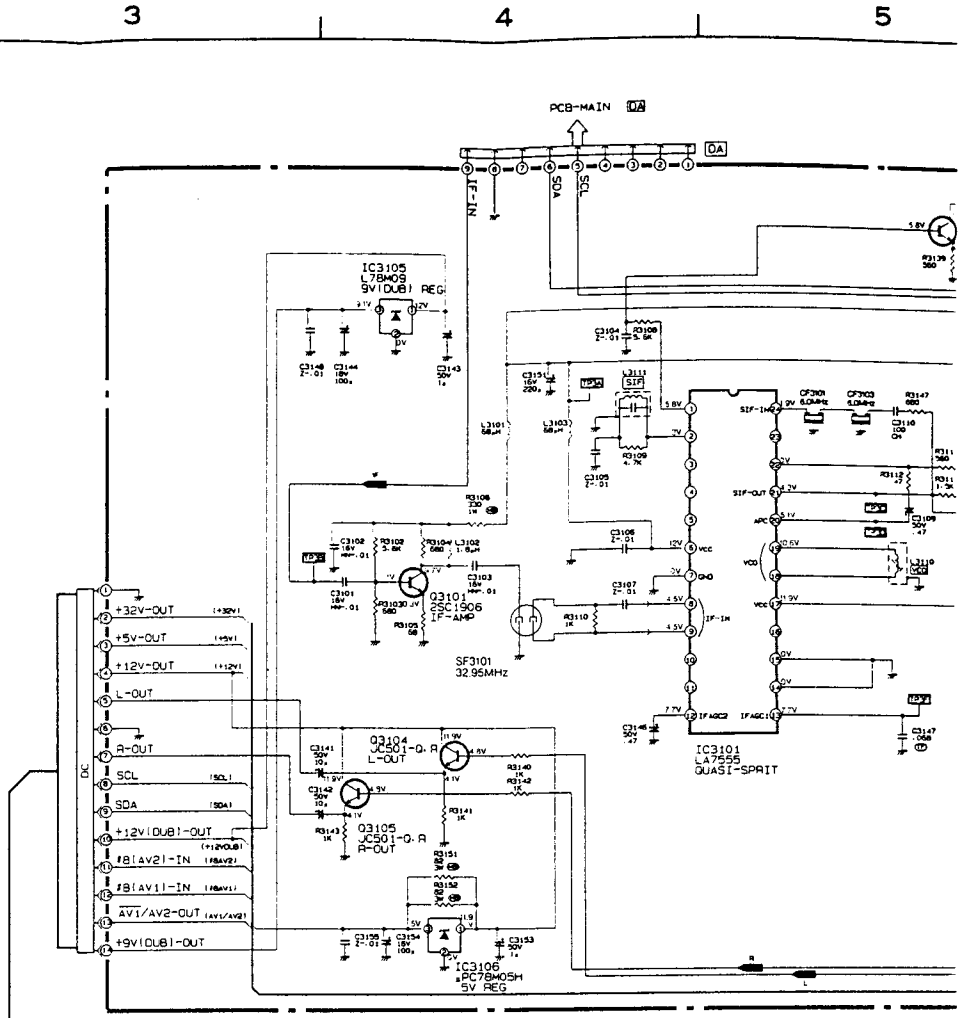
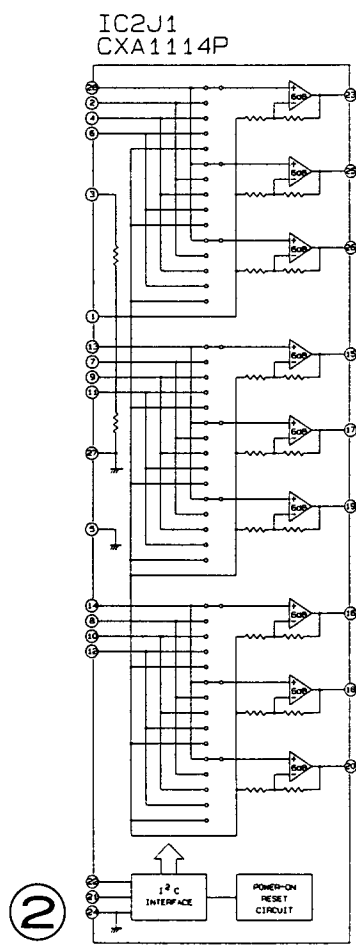
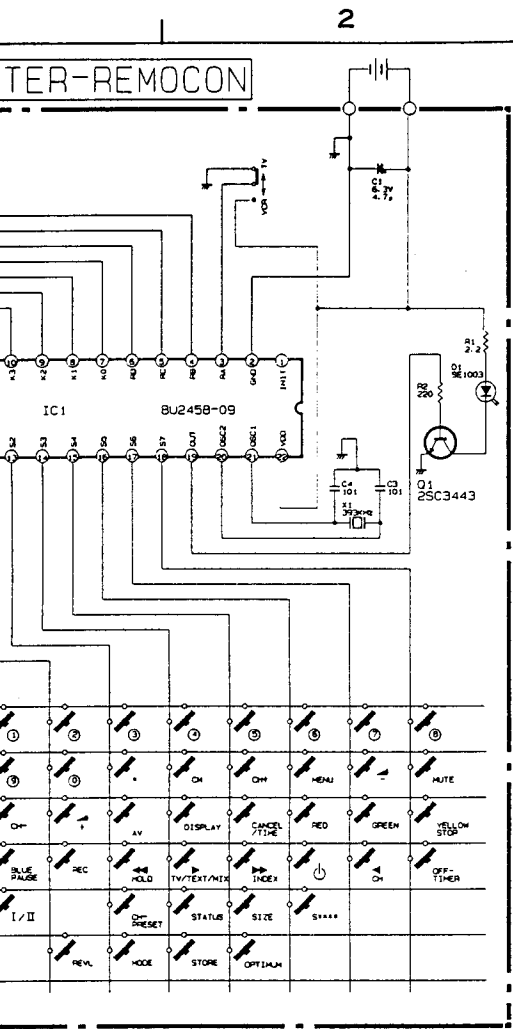

IC3J1
LA7575N
AUDIO-CON

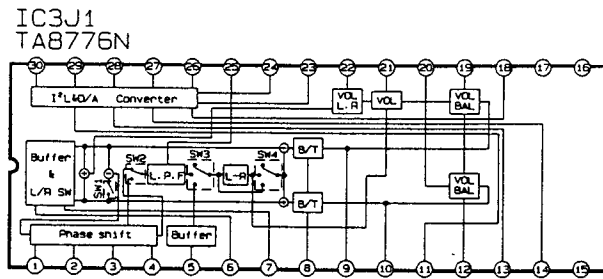
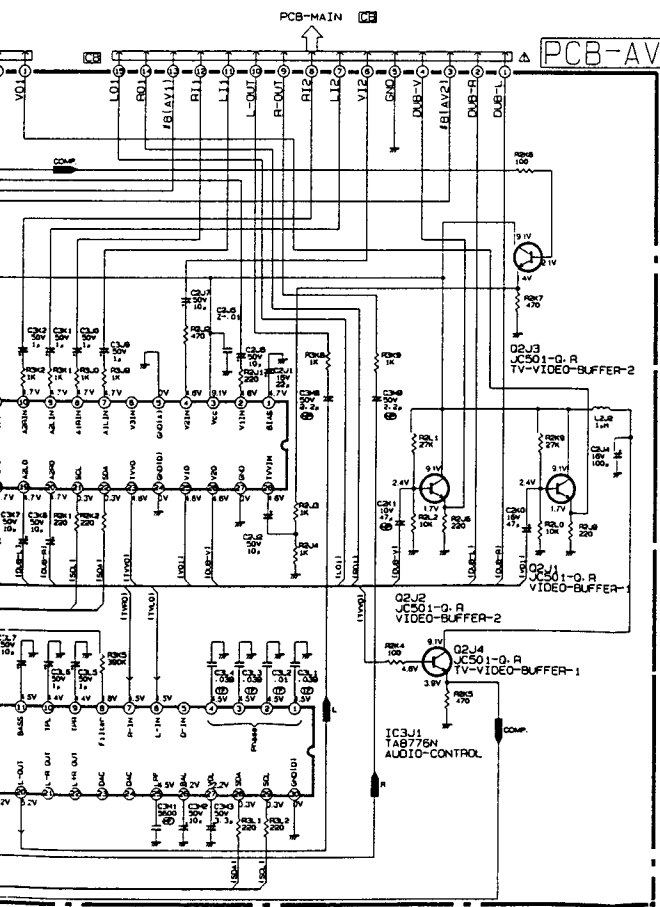
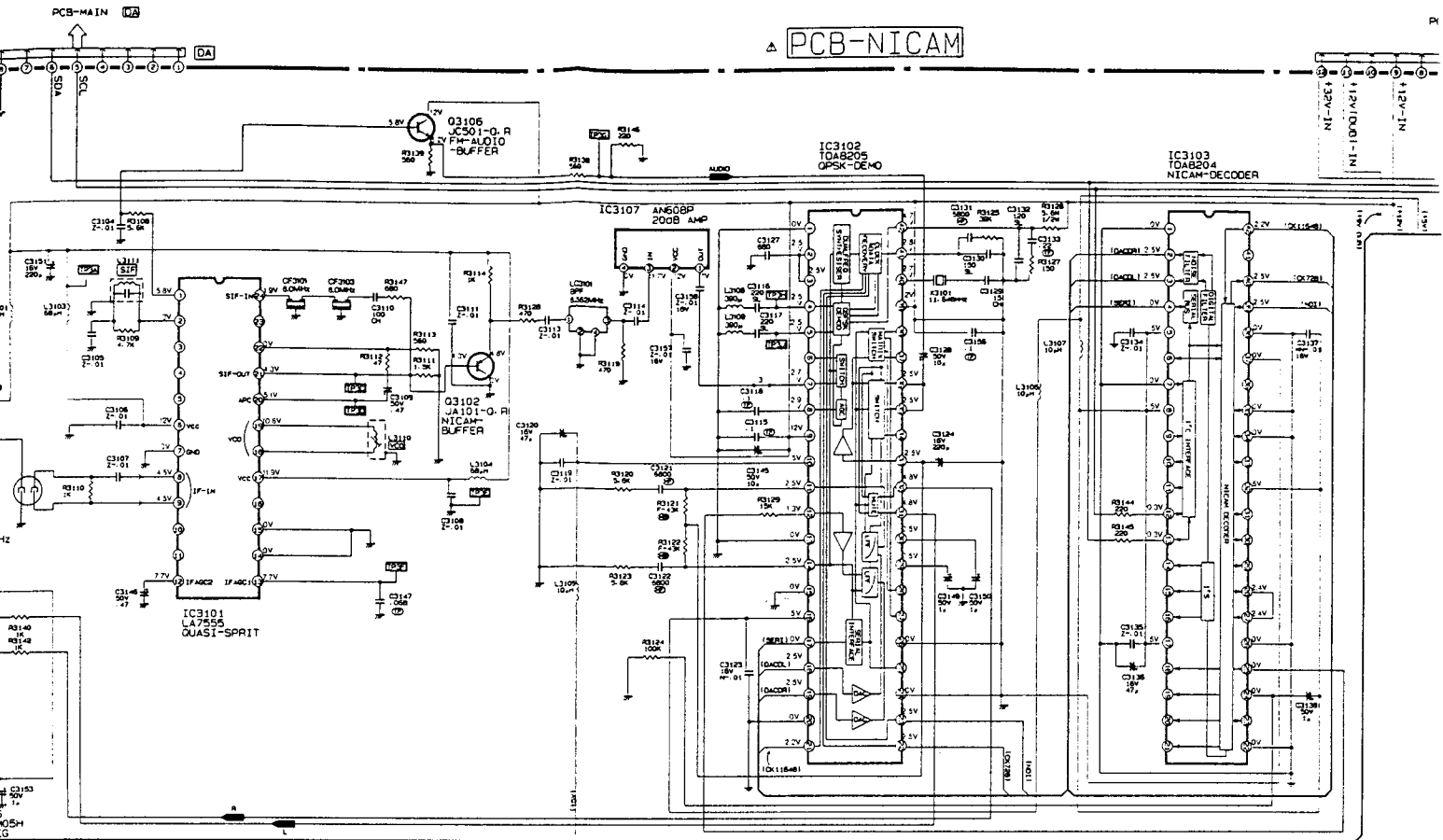

IC3101 LA7555

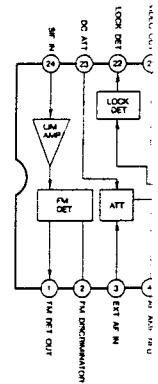

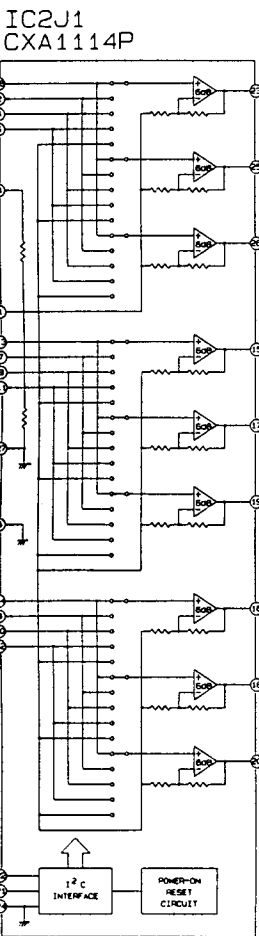
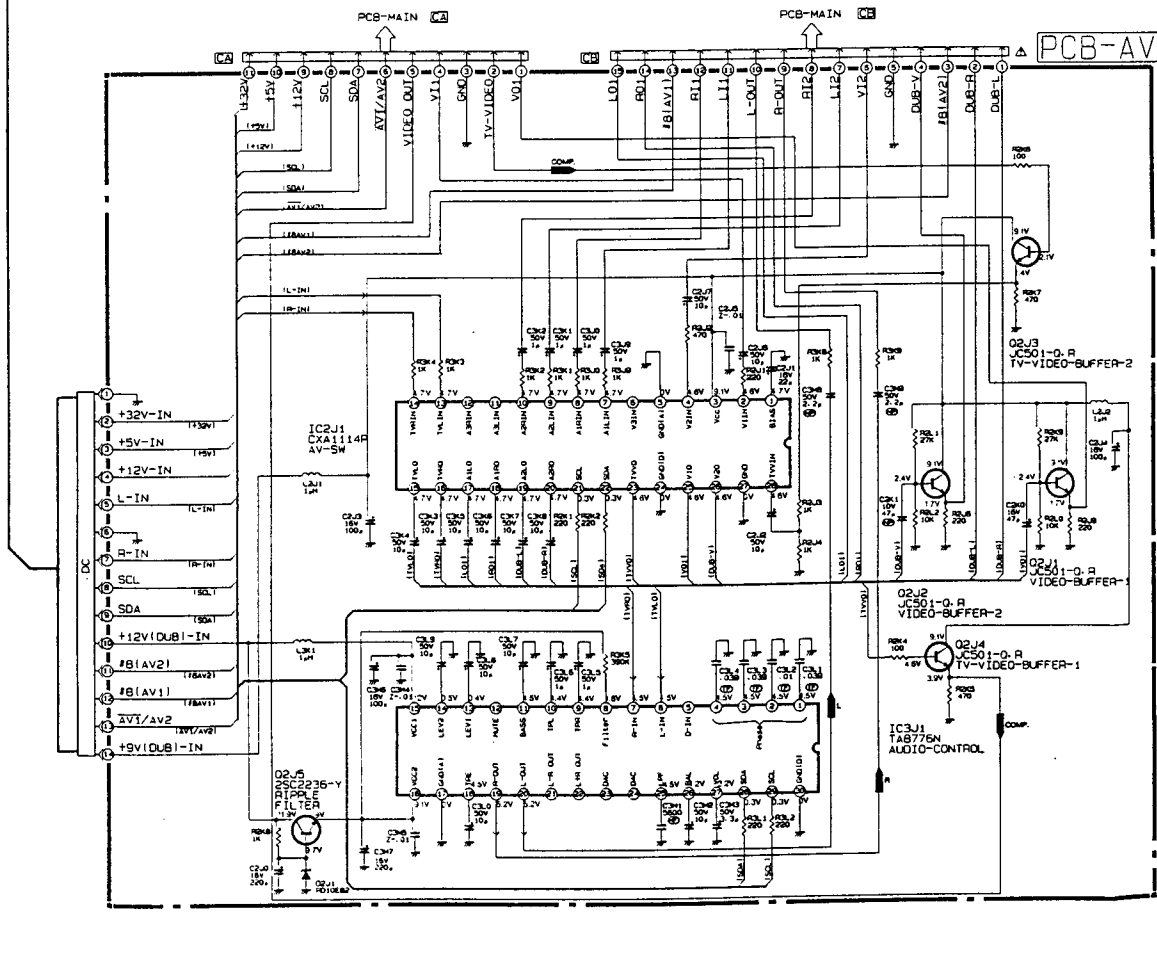
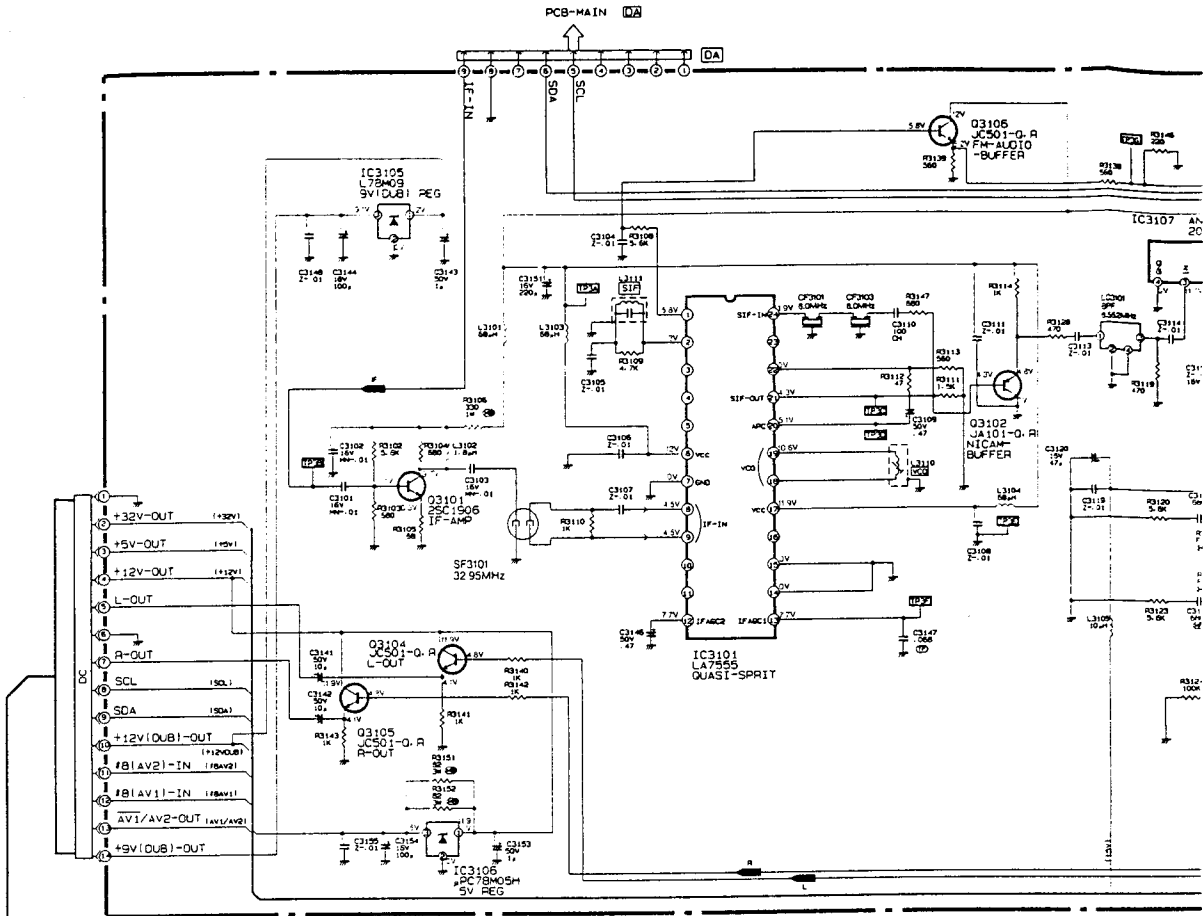
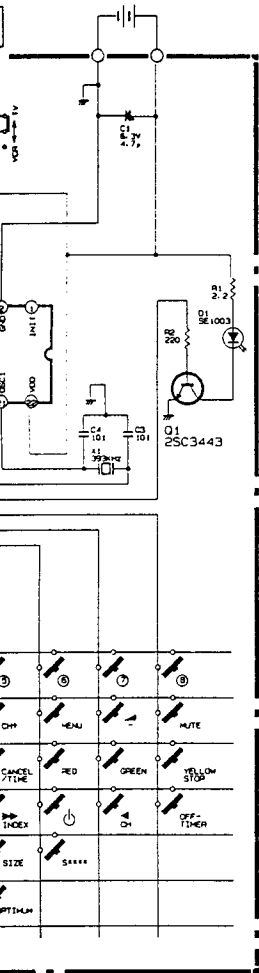

PCB-NICAM

PCB-MAIN

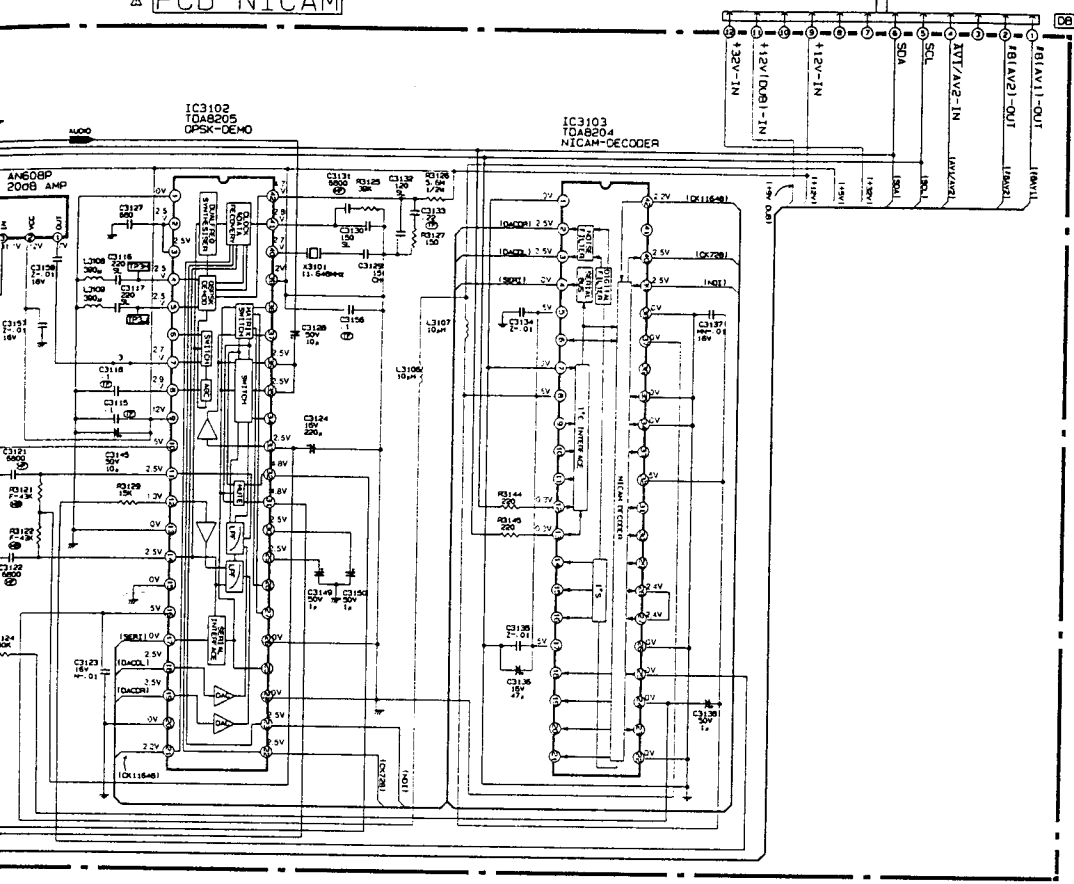

IC3101 LA7555

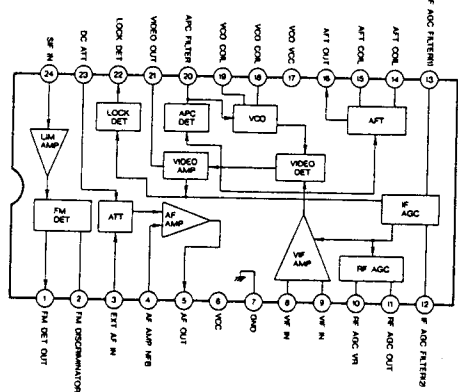

IC3J1 TA8776N

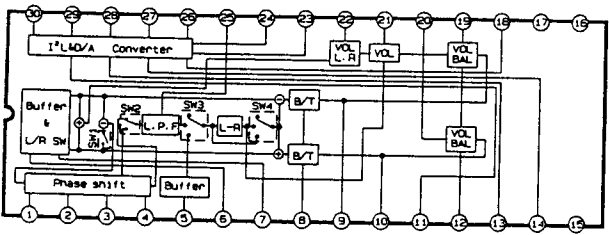

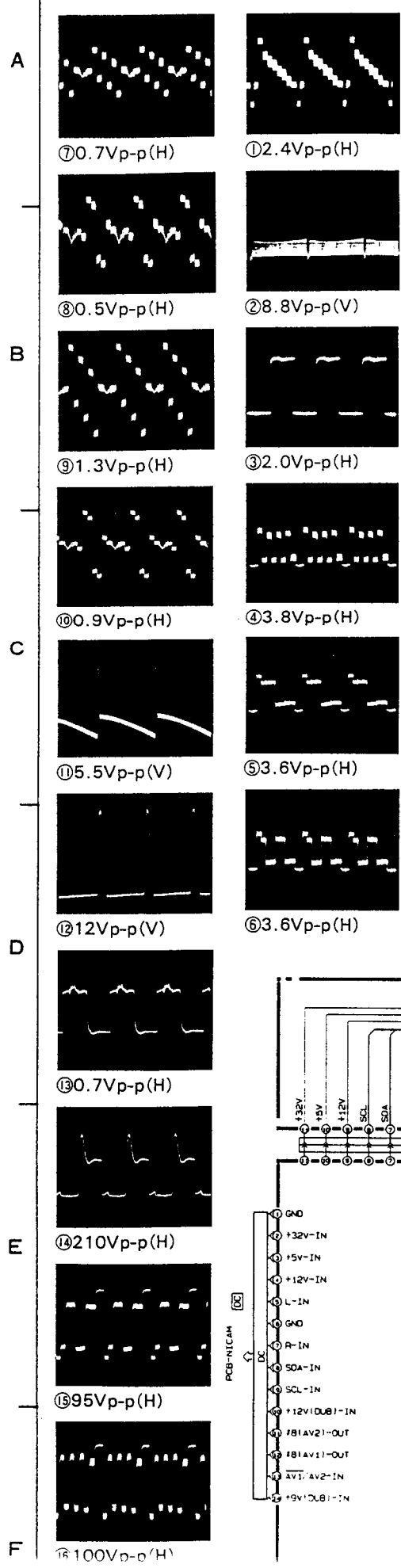

PCB-NICAM

- ① GND
- ② +32V-IN
- ③ +5V-IN
- ④ +12V-IN
- ⑤ L-IN
- ⑥ GND
- ⑦ R-IN
- ⑧ SDA-IN
- ⑨ SCL-IN
- ⑩ +12VIDUB1-IN
- ⑪ #B1AV21-OUT
- ⑫ #B1AV21-OUT
- ⑬ AV1/AV2-IN
- ⑭ +9V'DUB1-IN

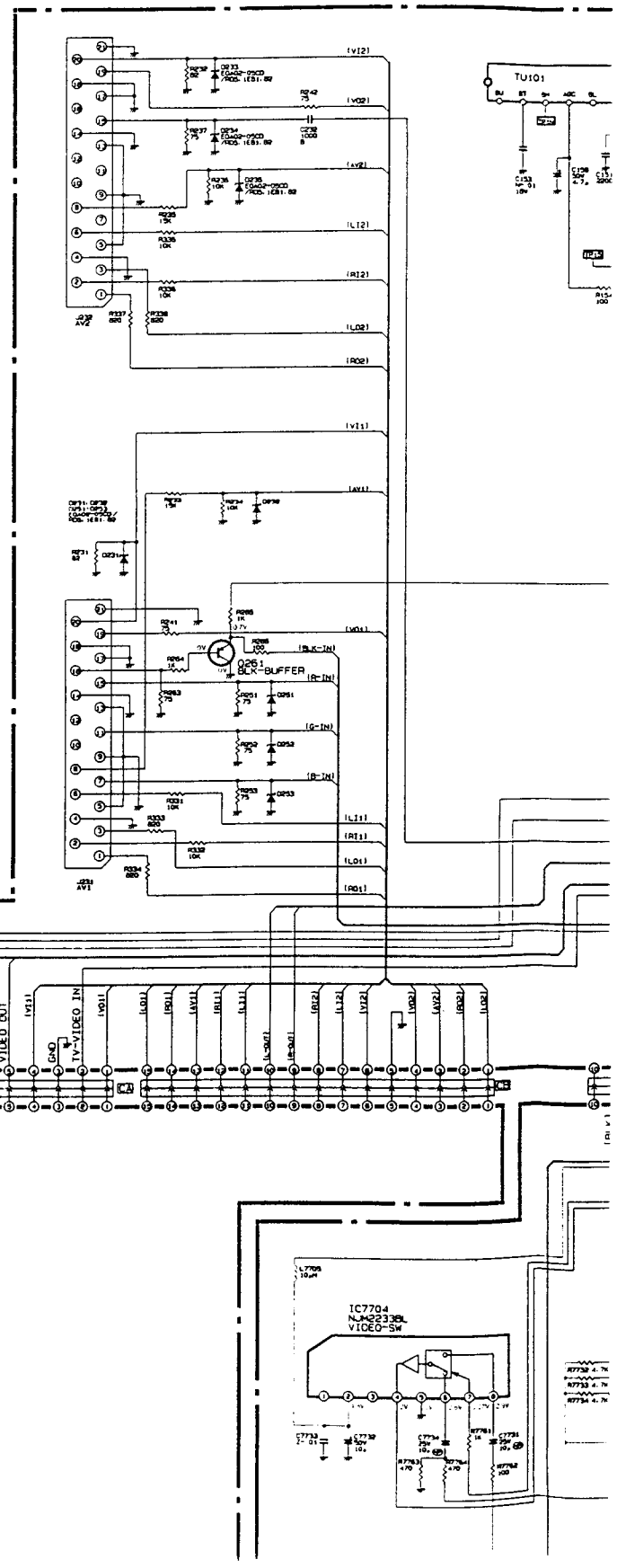

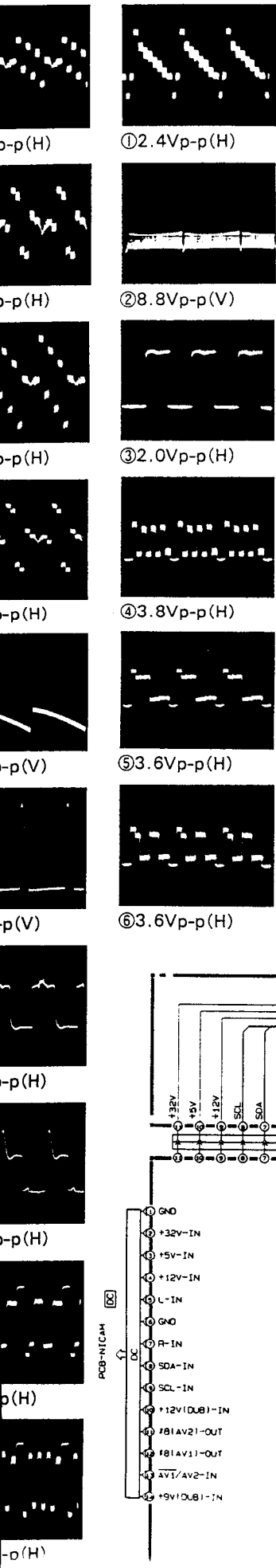

① 2.4Vp-p(H)

② 8.8Vp-p(V)

③ 2.0Vp-p(H)

④ 3.8Vp-p(H)

⑤ 3.6Vp-p(H)

⑥ 3.6Vp-p(H)

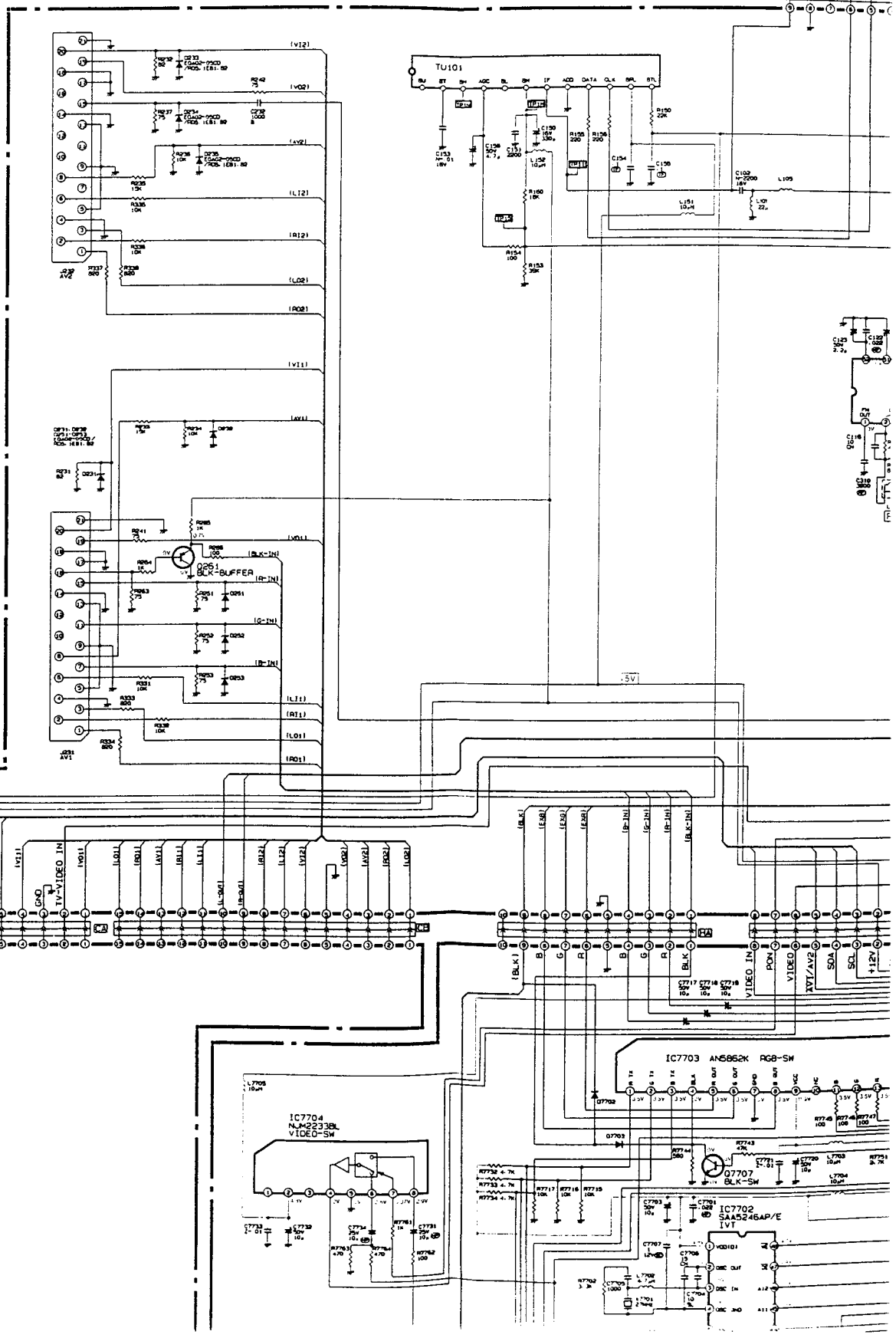

PCB-NICAM

- ① GND
- ② +32V-IN
- ③ +5V-IN
- ④ +12V-IN
- ⑤ L-IN
- ⑥ GND
- ⑦ R-IN
- ⑧ SDA-IN
- ⑨ SCL-IN
- ⑩ +12V(DUB1)-IN
- ⑪ I81(AV2)-OUT
- ⑫ I81(AV1)-OUT
- ⑬ AV1(AV2)-IN
- ⑭ +9V(DUB1)-IN

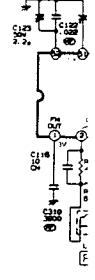

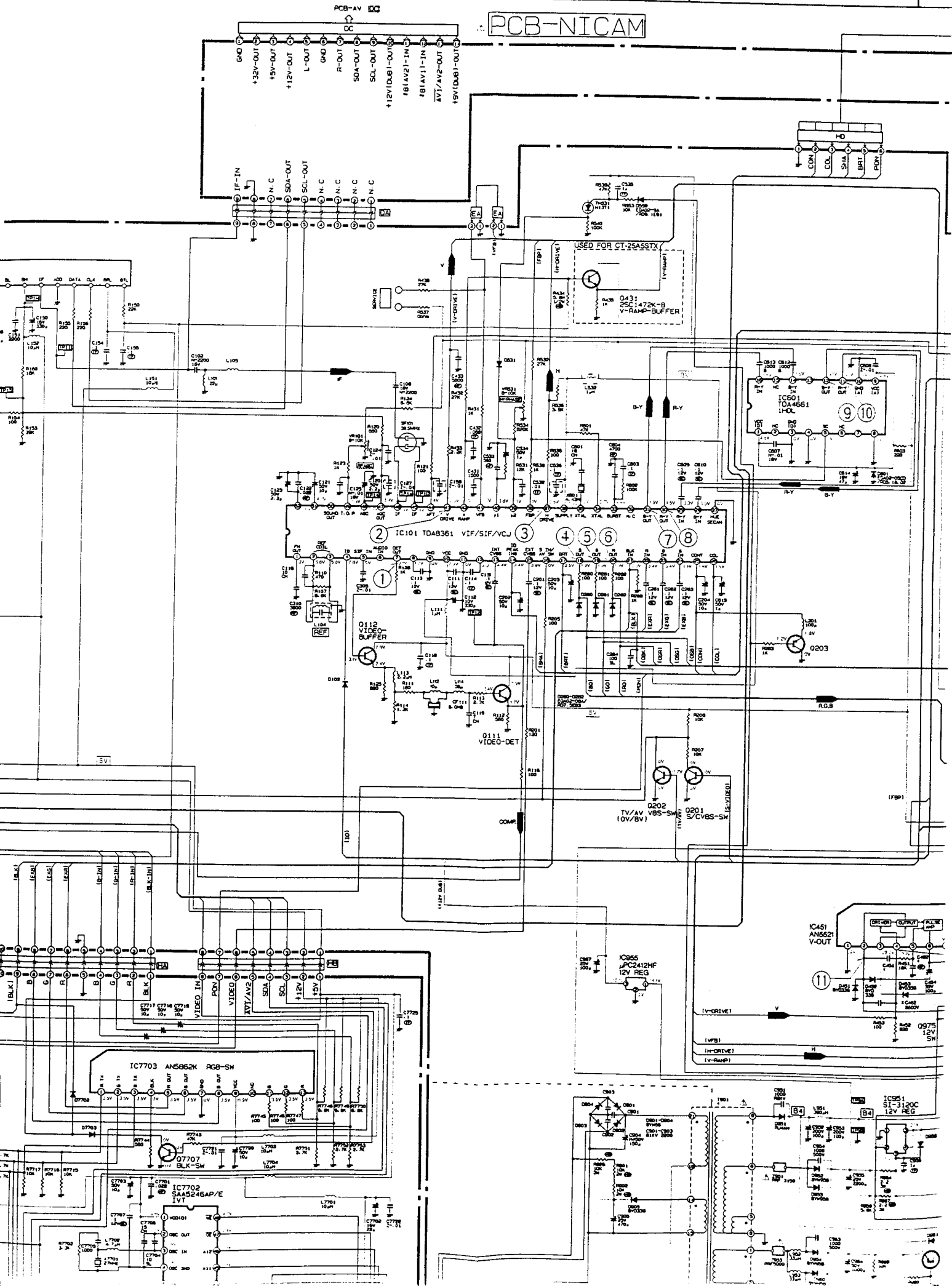

PCB-NICAM

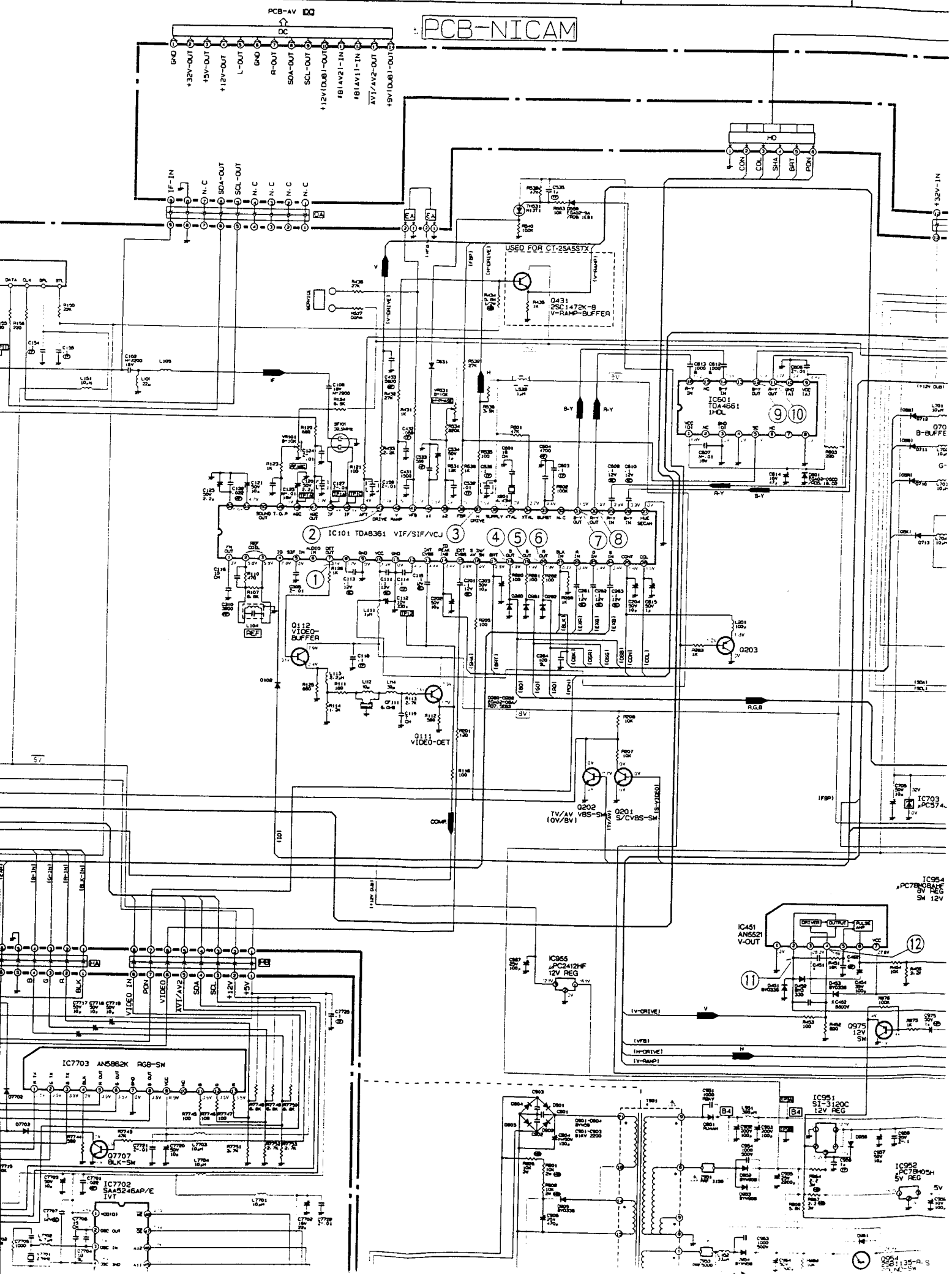

PCB-NICAM

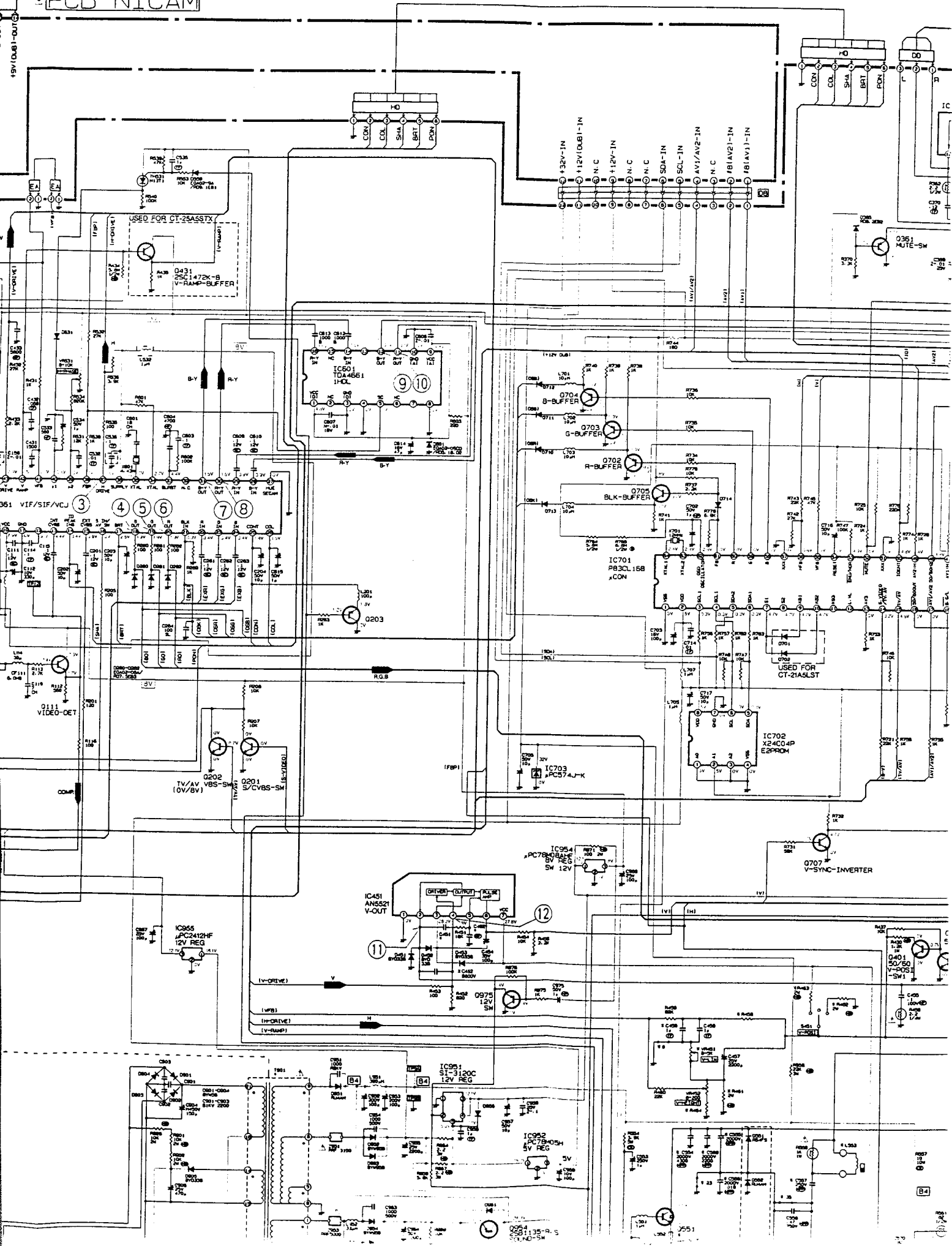

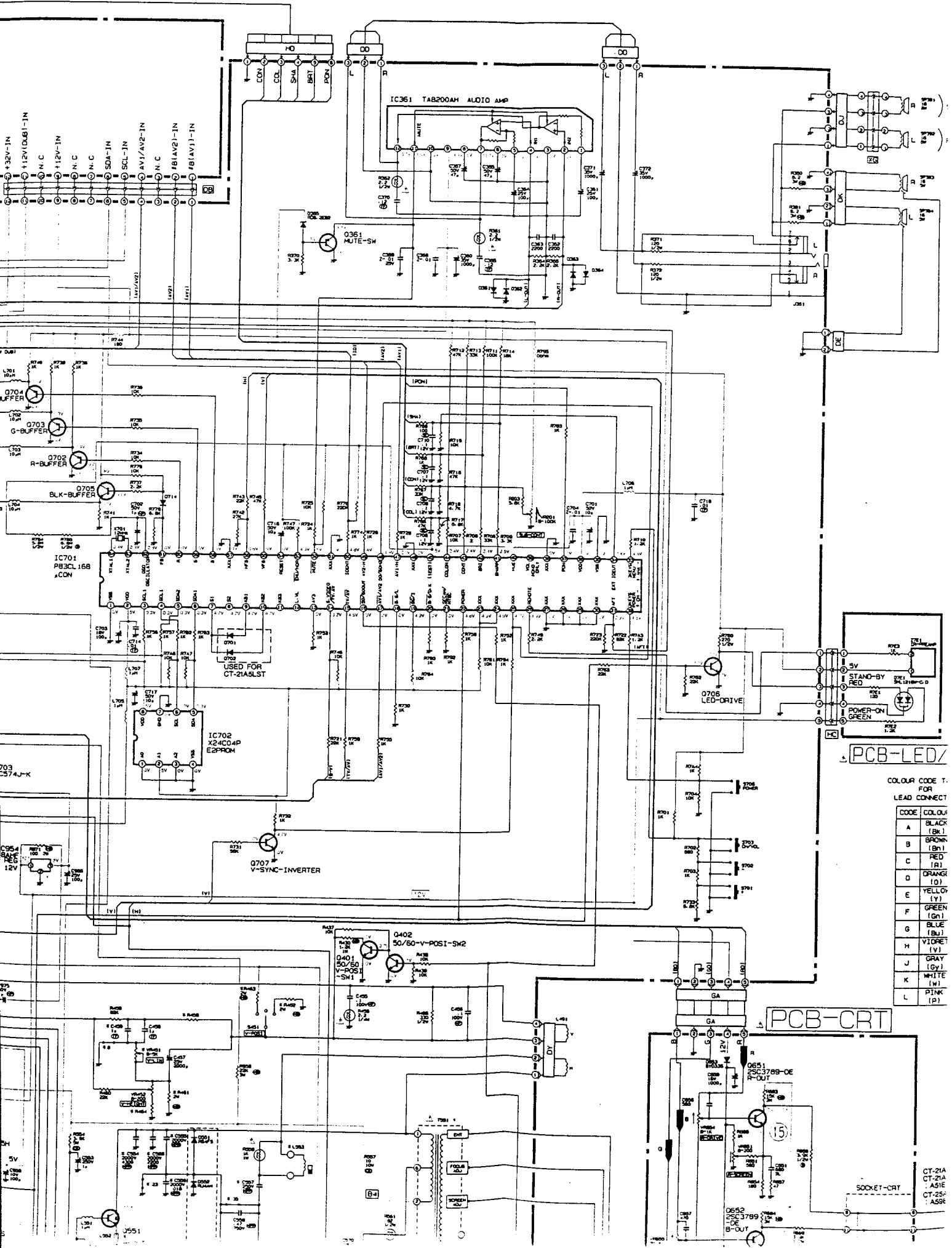

PCB-LED

COLOUR CODE T.
FOR
LEAD CONNECT

CODE	COLOUR
A	BLACK (Bk)
B	BROWN (Bn)
C	RED (R)
D	ORANGE (O)
E	YELLOW (Y)
F	GREEN (Gn)
G	BLUE (Bl)
H	VIOLET (V)
J	GRAY (Gy)
K	WHITE (W)
L	PINK (P)

PCB-CRT

CT-21A
CT-21E
AS1E
CT-25F
AS5E

SOCKET-CRT

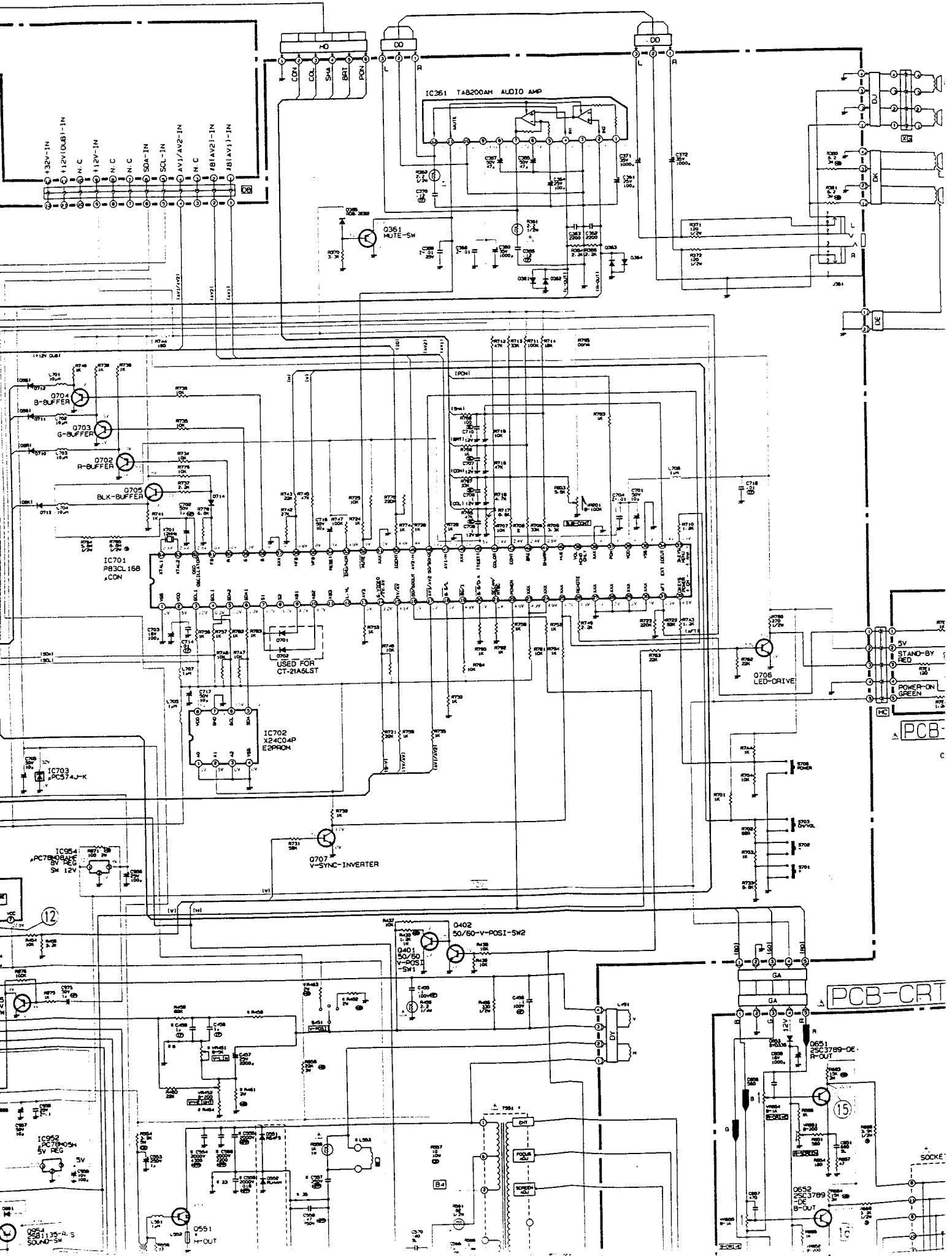

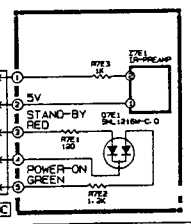
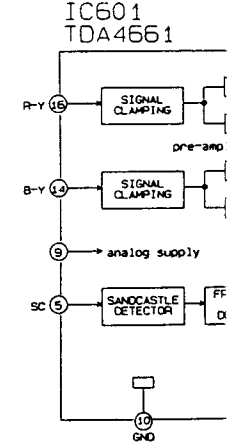
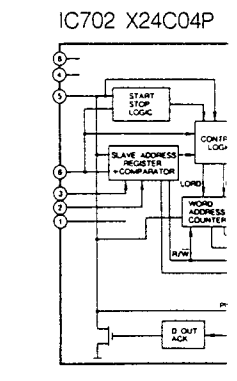
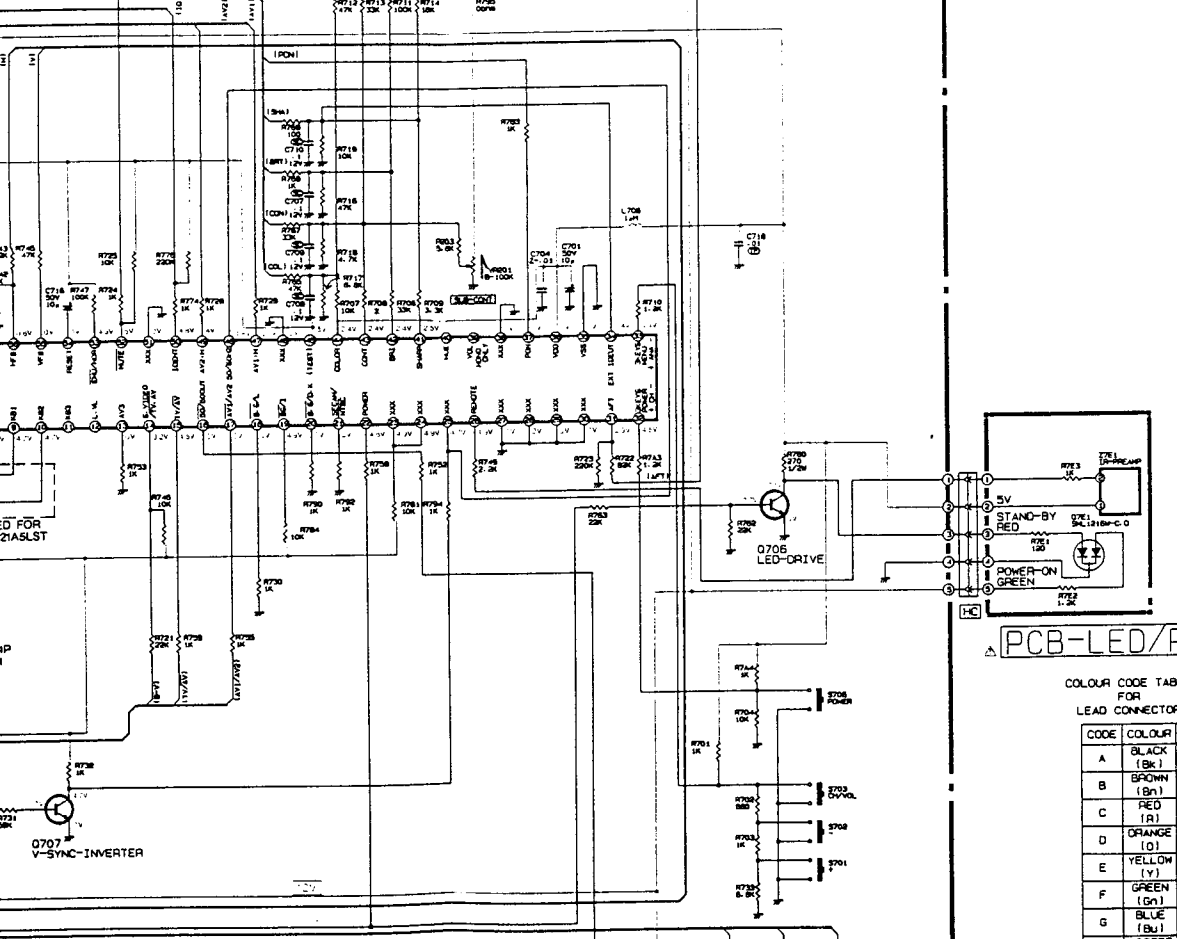
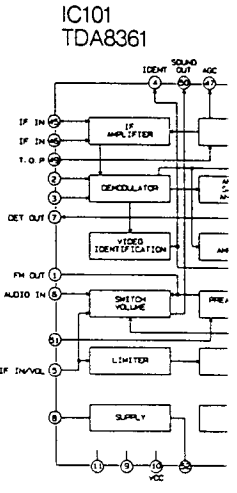
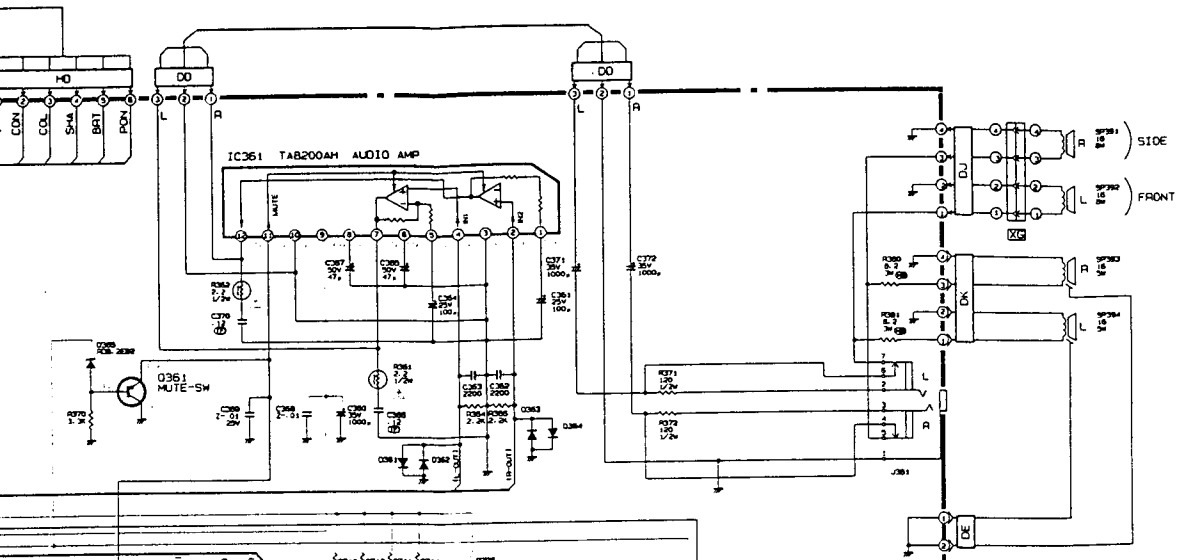

COLOUR CODE TABLE FOR LEAD CONNECTOR

CODE	COLOUR	CIRCUIT
A	BLACK (Bk)	⊗
B	BROWN (Br)	VIF
C	RED (R)	VIDED
D	ORANGE (O)	SOUND-AUDIO
E	YELLOW (Y)	VERT.
F	GREEN (Gr)	HORI.
G	BLUE (Bl)	CHROMA
H	VIOLET (V)	-COM
J	GRAY (Gy)	
K	WHITE (W)	POWER
L	PINK (P)	

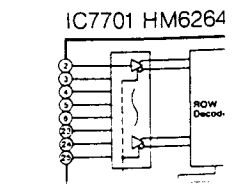
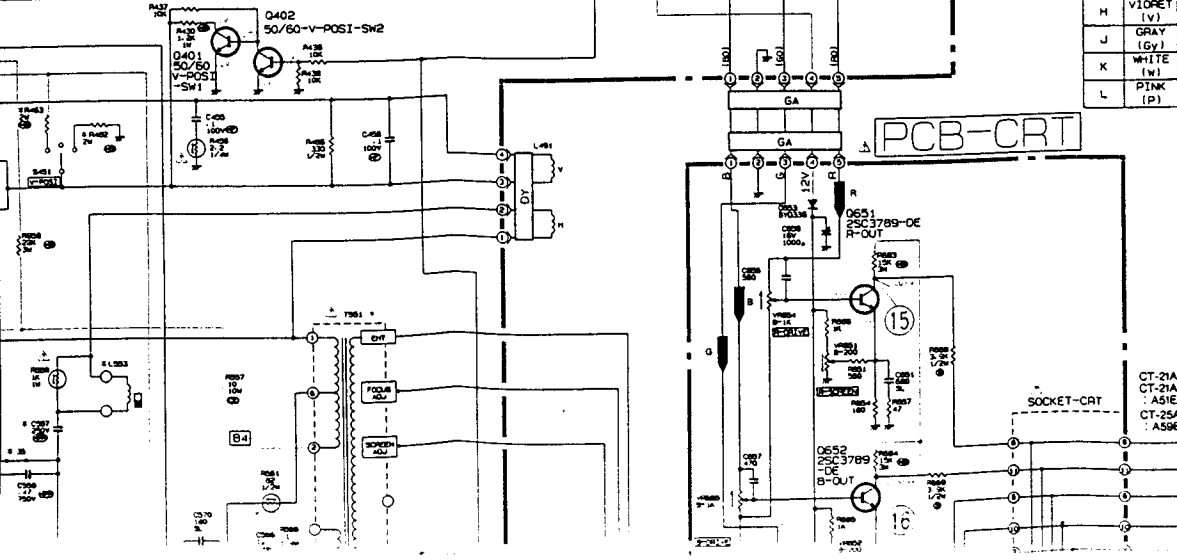
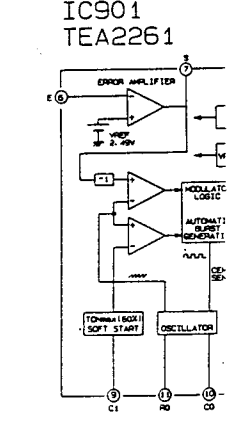

CT-21ASLST
CT-21ASSTX
AS1EALSX01
CT-25ASSTX
AS5ECY13X01

IC101
TDA8361

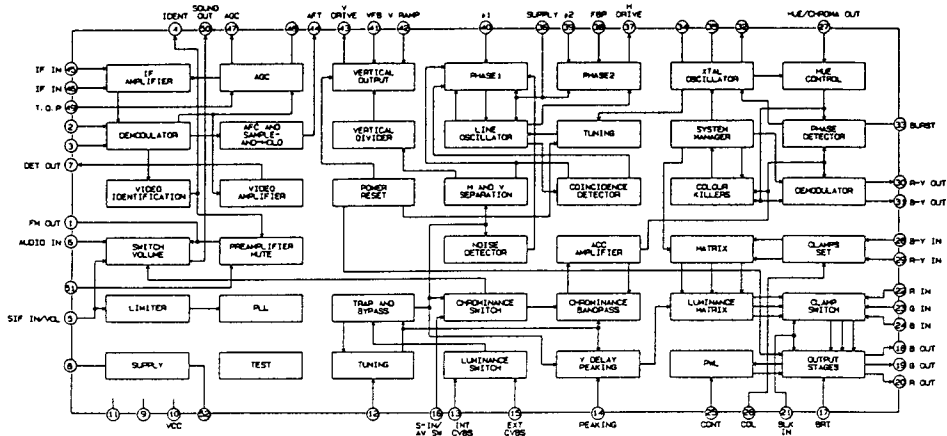

IC702 X24C04P

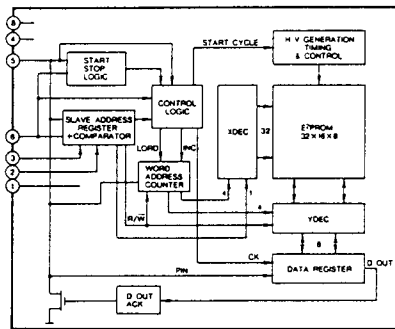

IC601
TDA4661

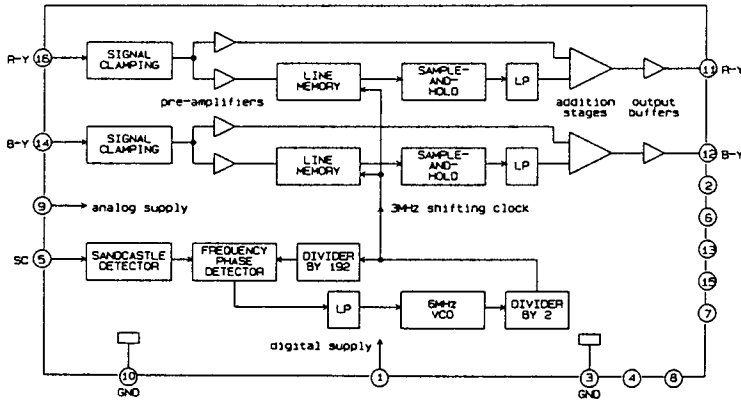

IC901
TEA2261

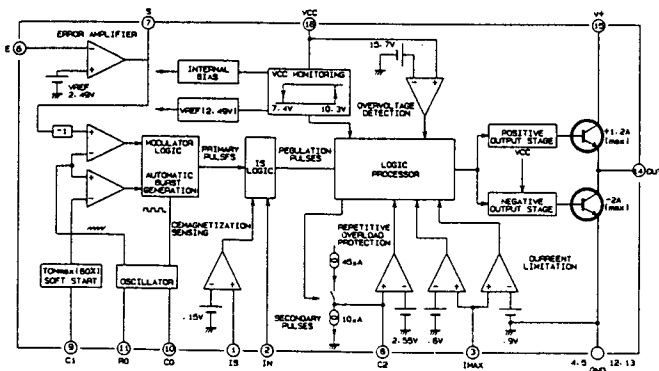

IC7701 HM6264ALSP

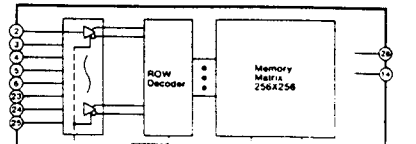

IC7703
AN5862K

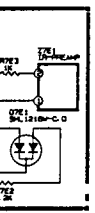
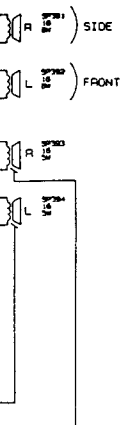
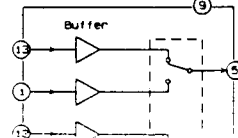

COLOUR CODE TABLE FOR LEAD CONNECTOR

CODE	COLOUR	CIRCUIT
A	BLACK (Blk)	X
B	BROWN (Brn)	VIF
C	RED (R)	VIDEO
D	ORANGE (O)	SOUND-AUDIO
E	YELLOW (Y)	VERT.
F	GREEN (Gr)	HORI.
G	BLUE (Blu)	CHROMA
H	VIOLET (V)	COM
J	GRAY (Gr)	
K	WHITE (W)	POWER
L	PINK (P)	

CT-21ASLT
CT-21ASSTX
: A51EALSX01
CT-25ASSTX
: AS8ECY13X01

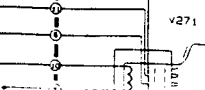

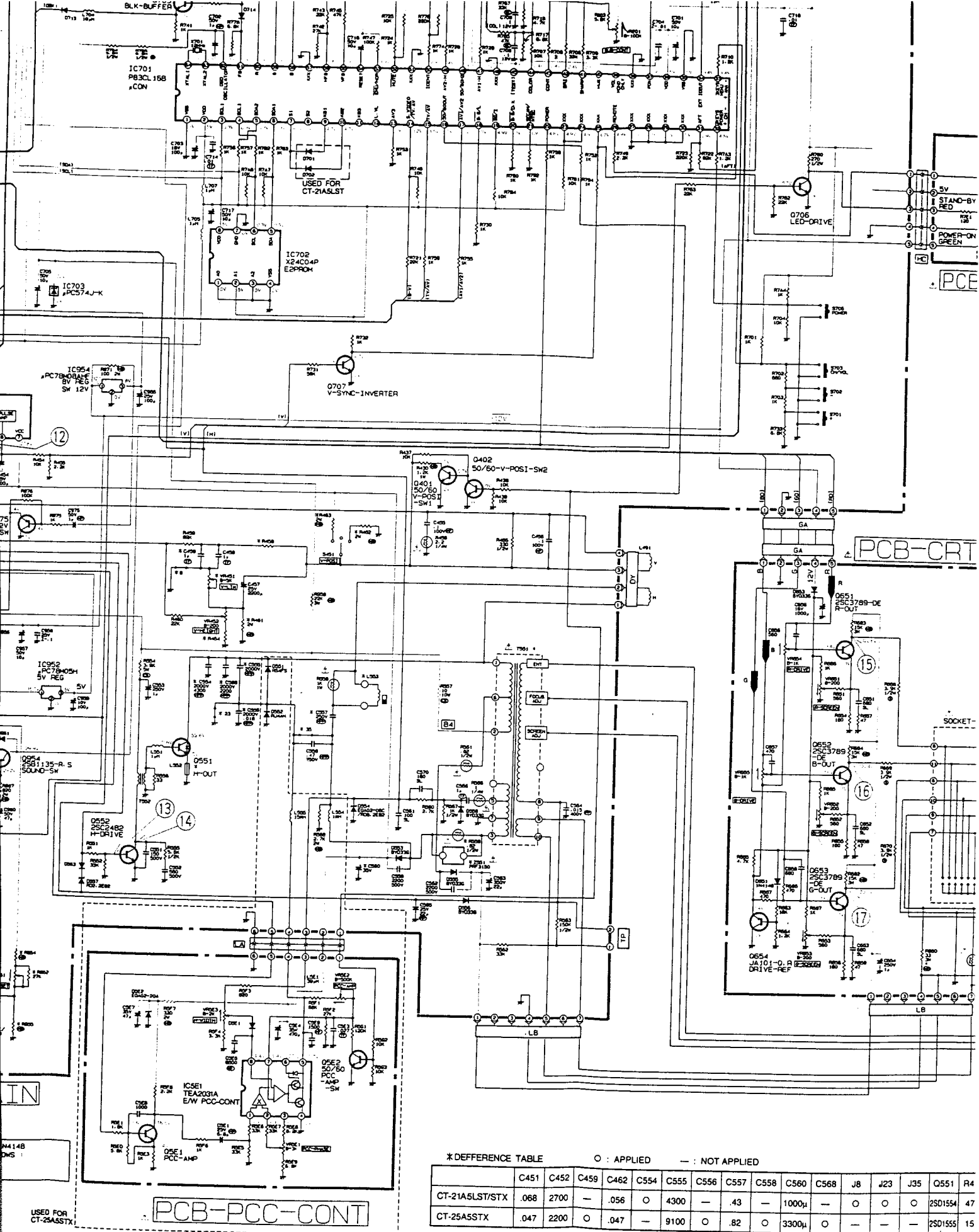

* DIFFERENCE TABLE ○ : APPLIED — : NOT APPLIED

	C451	C452	C459	C462	C554	C555	C556	C557	C558	C560	C568	J8	J23	J35	Q551	R4
CT-21A5LST/STX	.068	2700	—	.056	○	4300	—	.43	—	1000μ	—	○	○	○	2SD1554	47
CT-25A5STX	.047	2200	○	.047	—	9100	○	.82	○	3300μ	○	—	—	—	2SD1555	15

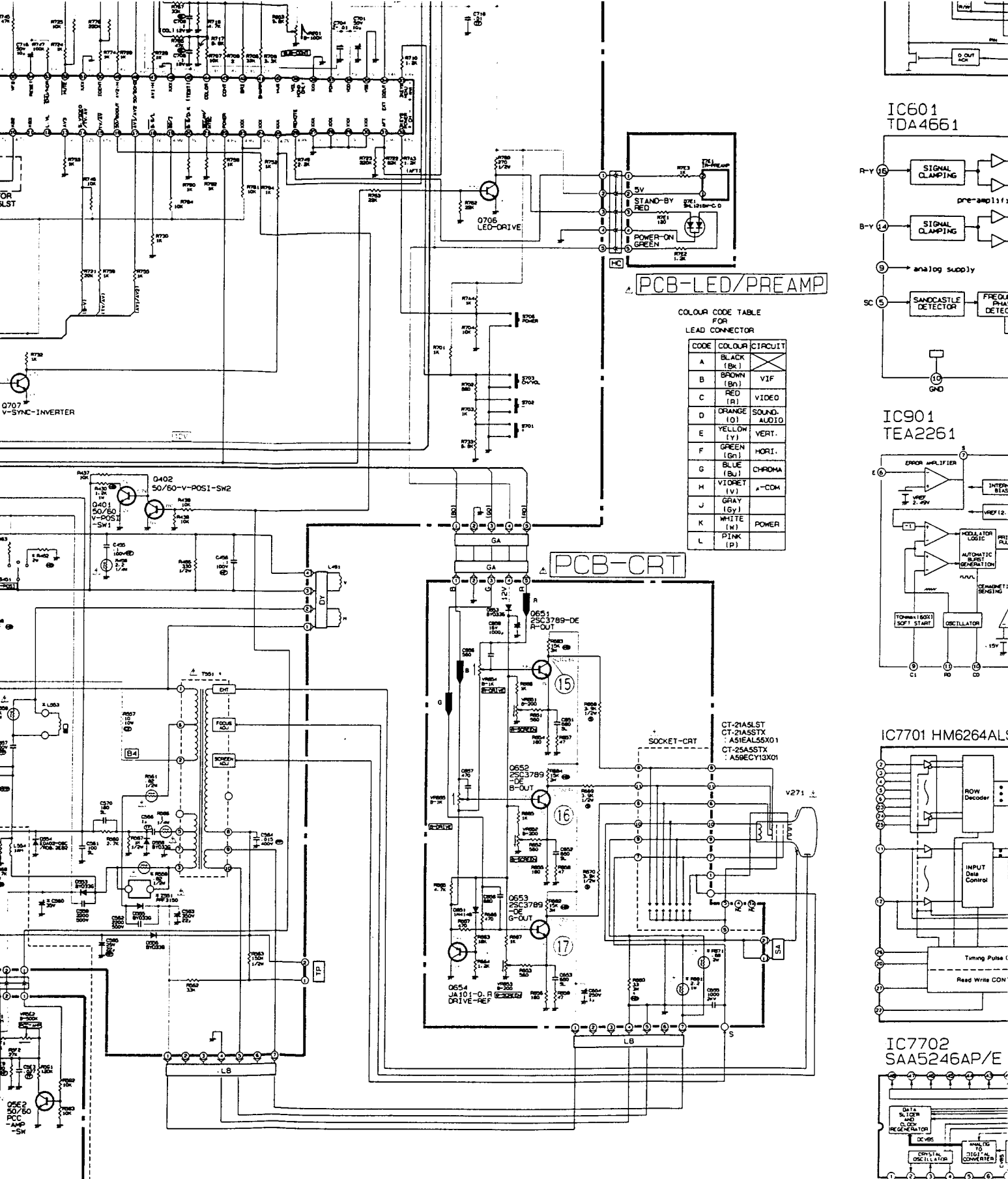

PCB-LED/PREAMP

COLOUR CODE TABLE FOR LEAD CONNECTOR

CODE	COLOUR	CIRCUIT
A	BLACK (BK)	⊗
B	BROWN (BN)	VIF
C	RED (R)	VIDEO
D	ORANGE (O)	SOUND-AUDIO
E	YELLOW (Y)	VERT.
F	GREEN (GN)	HORI.
G	BLUE (BU)	CHROMA
H	VIDRET (V)	A-COM
J	GRAY (G)	
K	WHITE (W)	POWER
L	PINK (P)	

PCB-CRT

IC601
TDA4661

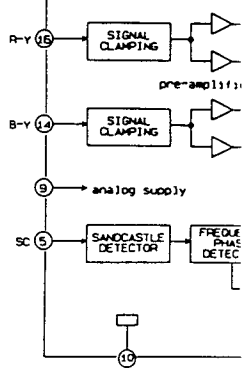

IC901
TEA2261

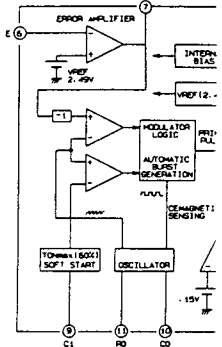

IC7701 HM6264ALS

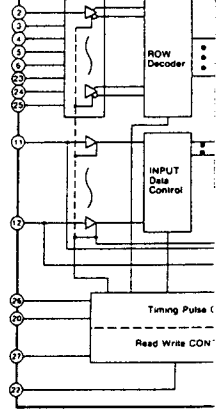

IC7702
SAA5246AP/E

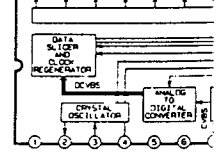

* DIFFERENCE TABLE ○ : APPLIED — : NOT APPLIED

	C451	C452	C459	C462	C554	C555	C556	C557	C558	C560	C568	J8	J23	J35	Q551	R458	R461	R462	R463	R464	R559	R671	R68Q	R681	R708	R954
CT-21A5LST/STX	.068	2700	—	.056	○	4300	—	.43	—	1000μ	—	○	○	○	2SD1554	47K	1.8	1.2K	1.2K	0	○	—	○	○	5.6K	120K
CT-25A5STX	.047	2200	○	.047	—	9100	○	.82	○	3300μ	○	—	—	—	2SD1555	15K	.82	820	820	330	—	○	—	—	10K	160K

ONT

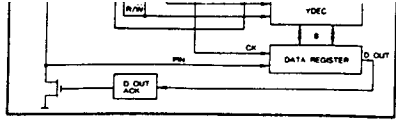

IC601
TDA4661

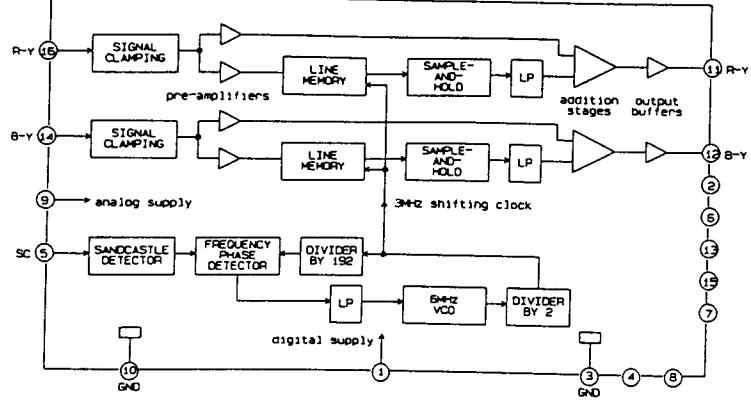

CB-LED/PREAMP

COLOUR CODE TABLE FOR LEAD CONNECTOR

CODE	COLOUR	CIRCUIT
A	BLACK (Bk)	X
B	BROWN (Bn)	VIF
C	RED (R)	VIDEO
D	ORANGE (O)	SOUND. AUDIO
E	YELLOW (Y)	VERT.
F	GREEN (Gn)	HORI.
G	BLUE (Bl)	CHROMA
H	VIOLET (V)	A-COM
J	GRAY (Gy)	
K	WHITE (W)	POWER
L	PINK (P)	

IC901
TEA2261

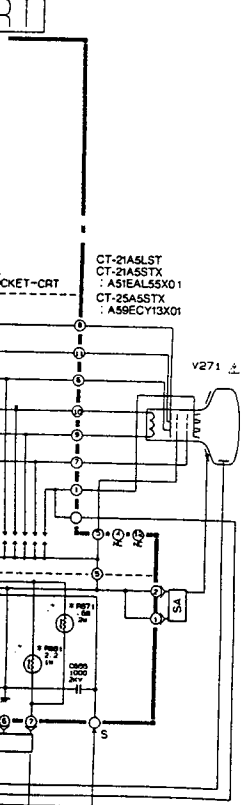
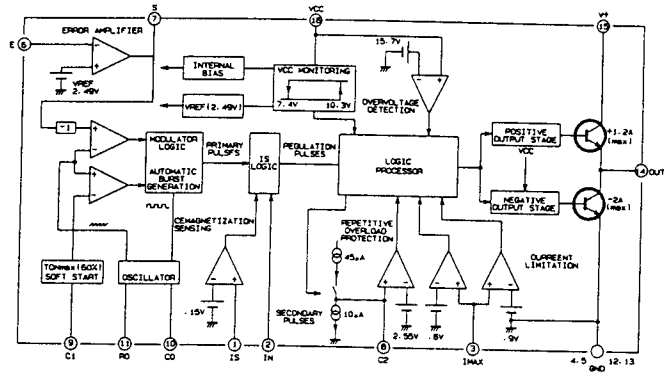

IC7701 HM6264ALSP

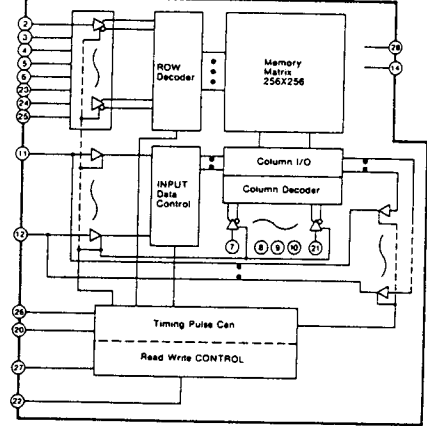

IC7703
AN5862K

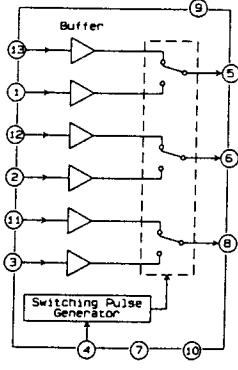

IC7702
SAA5246AP/E

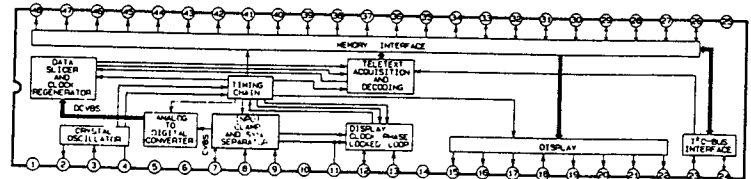

1	R458	R461	R462	R463	R464	R559	R671	R680	R681	R708	R954	R955	R962	VR451	VR951	Z551
4	47K	1.8	1.2K	1.2K	0	0	—	0	0	5.6K	120K	7.5K	—	—	B10K	—
5	15K	.82	820	820	330	—	0	—	—	10K	160K	8.2K	0	0	B20K	0

CT-21A5LST
CT-21A5STX
CT-25A5STX

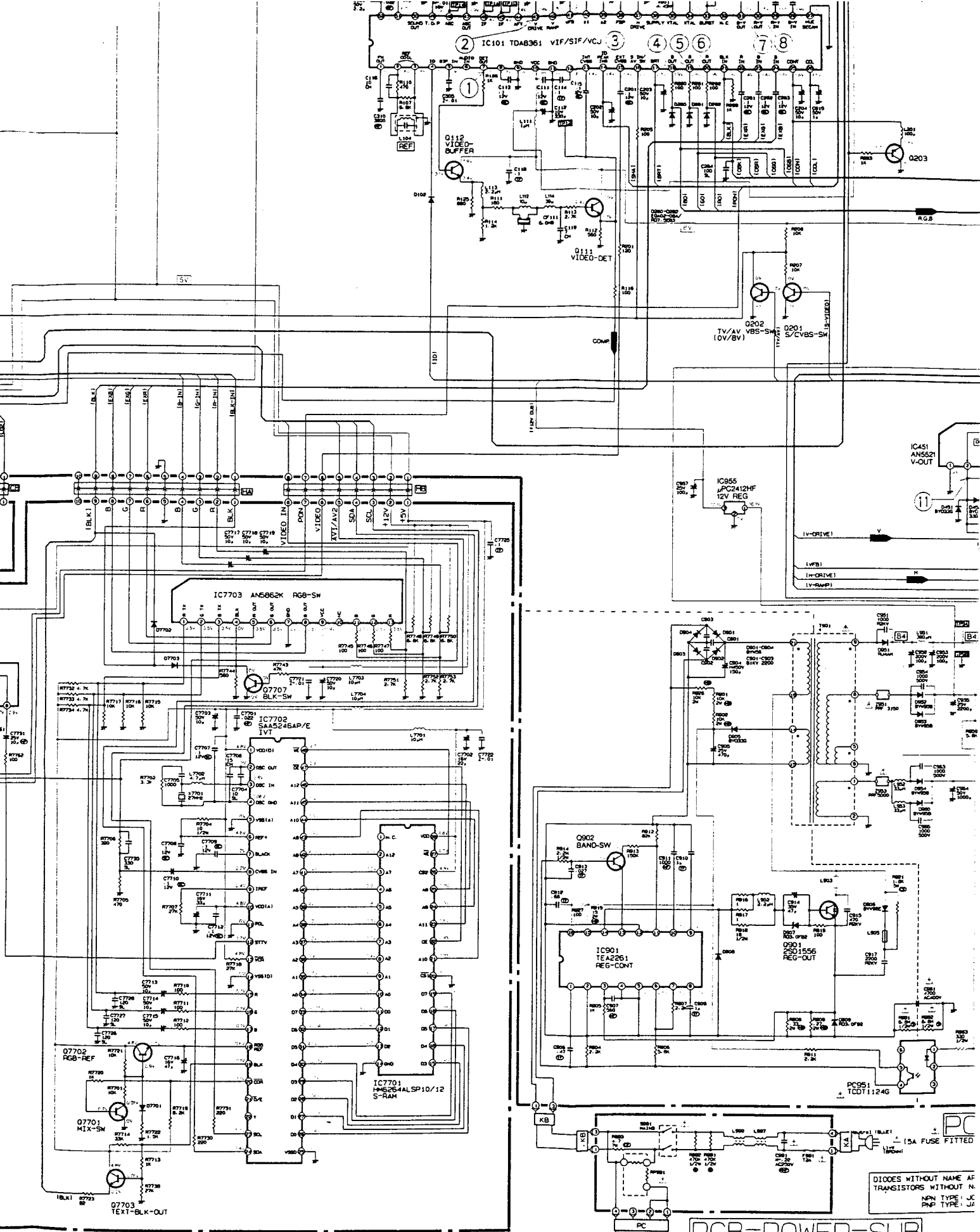

PCB-TEXT

PCB-POWER-SUB

DIODES WITHOUT NAME AF
 TRANSISTORS WITHOUT N.
 NPN TYPE: JC
 PNP TYPE: JZ

PC95 TCD1124G (15A FUSE FITTED)

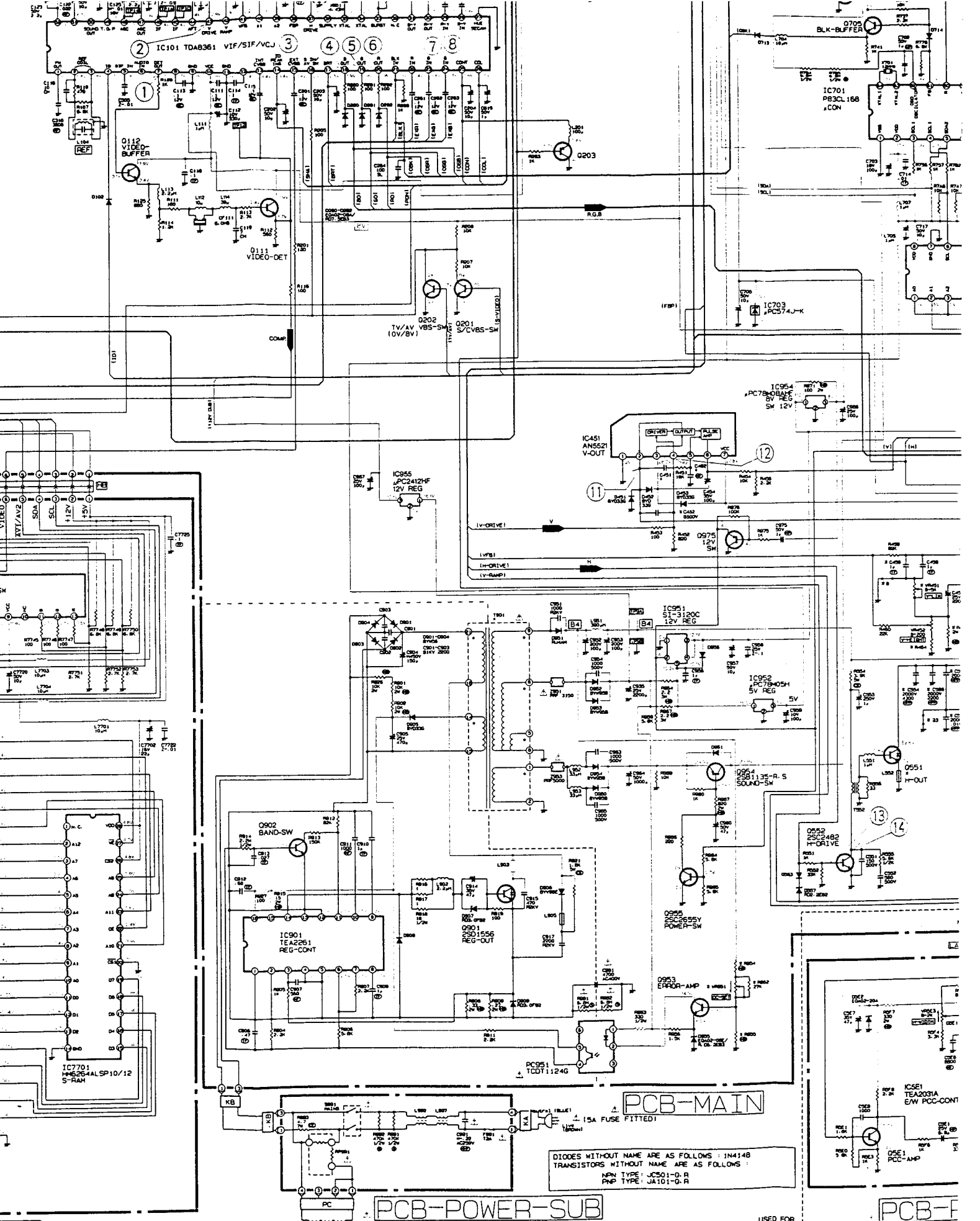

DIODES WITHOUT NAME ARE AS FOLLOWS : 1N4148
 TRANSISTORS WITHOUT NAME ARE AS FOLLOWS :
 NPN TYPE : JC501-D-R
 PNP TYPE : JA101-D-R

PCB-POWER-SUB

PCB-MAIN

PCB-F

USED FOR
 CT-25AS5TX

EXT

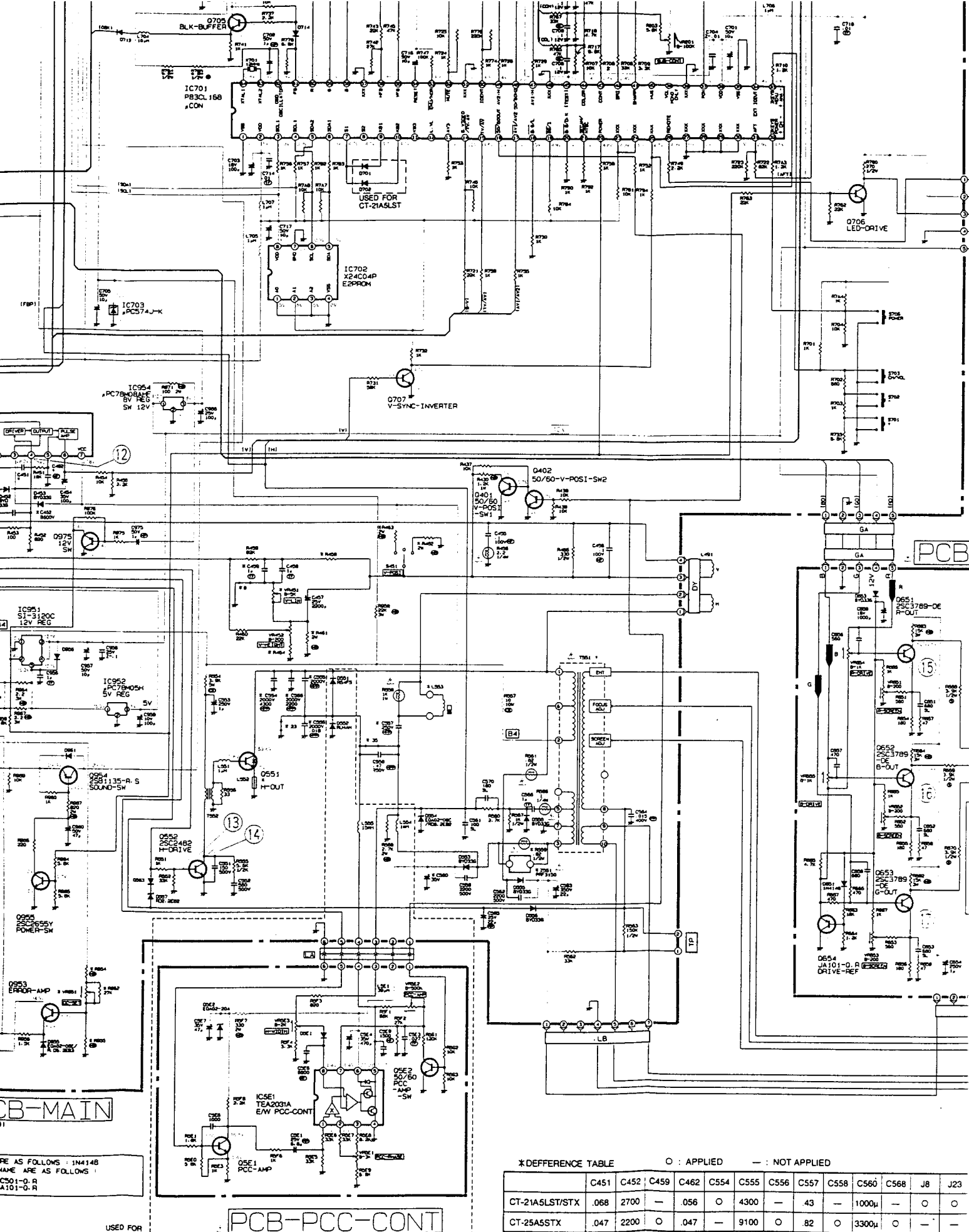

PARTS LIST AS FOLLOWS : IN4148
 PARTS LIST AS FOLLOWS :
 IC951-SI-3120C
 IC952-CT7905
 IC953-P83C47

USED FOR CT-25ASSTX

*DIFFERENCE TABLE ○ : APPLIED — : NOT APPLIED

	C451	C452	C459	C462	C554	C555	C556	C557	C558	C560	C568	J8	J23
CT-21A5LST/STX	.068	2700	—	.056	○	4300	—	.43	—	1000μ	—	○	○
CT-25A5STX	.047	2200	○	.047	—	9100	○	.82	○	3300μ	○	—	—

C
D
E
F
G
H



⑩0.9Vp-p(H)



④3.8Vp-p(H)



⑪5.5Vp-p(V)

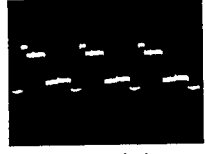

⑤3.6Vp-p(H)

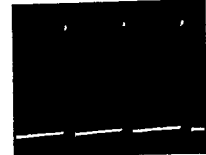

⑫12Vp-p(V)

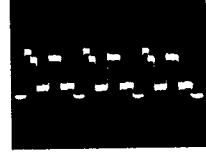

⑥3.6Vp-p(H)

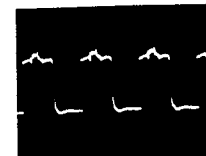

⑬0.7Vp-p(H)

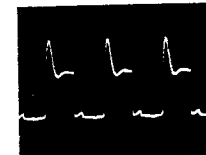

⑭210Vp-p(H)

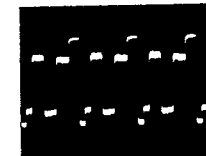

⑮95Vp-p(H)

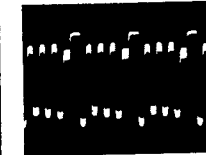

⑯100Vp-p(H)

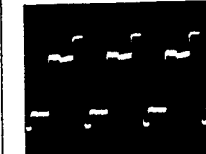

⑰98Vp-p(H)

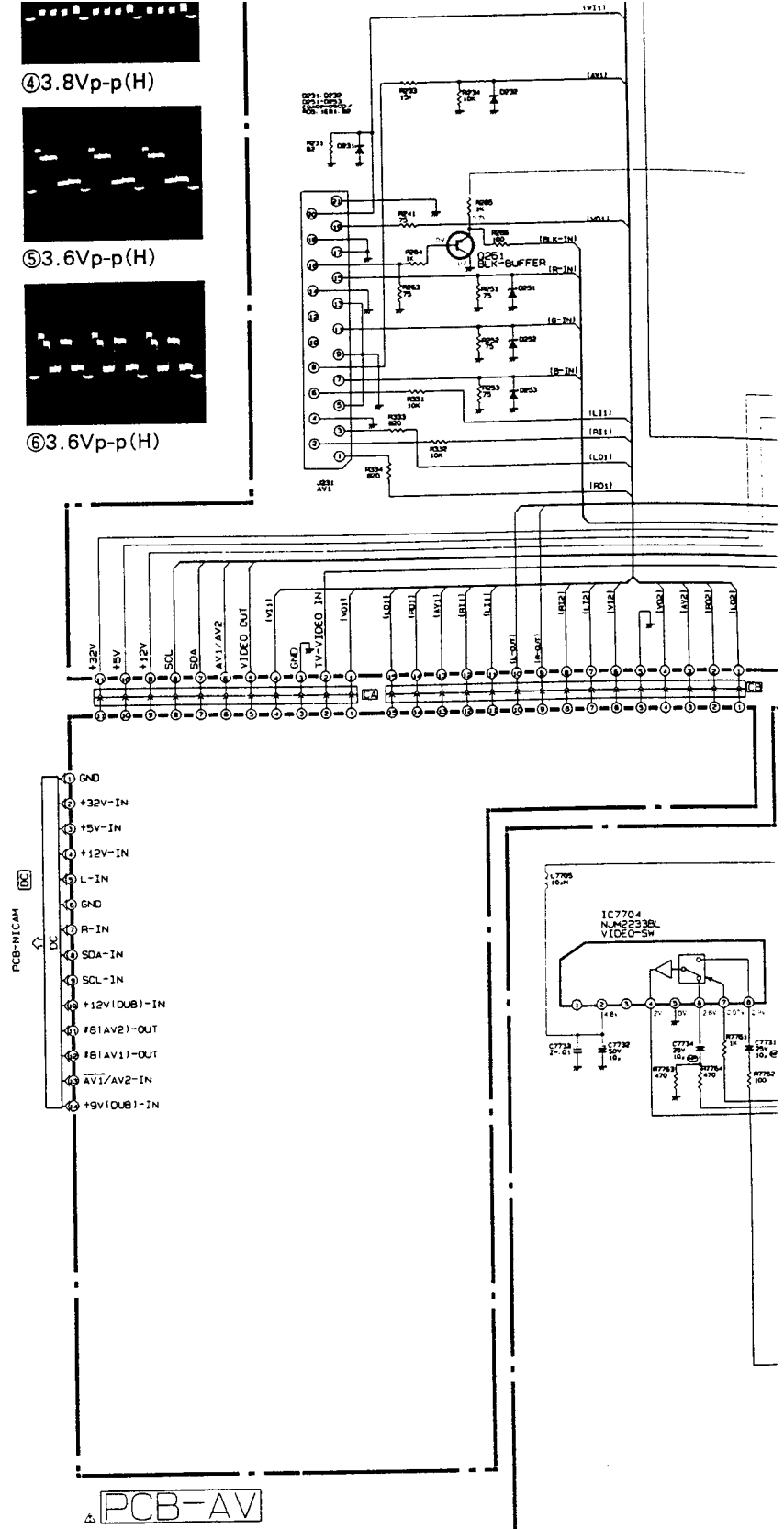

①0.9Vp-p(H)



④3.8Vp-p(H)

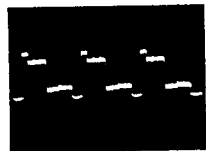

②5.5Vp-p(V)



⑤3.6Vp-p(H)

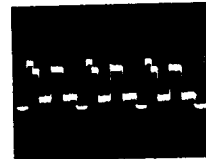

③12Vp-p(V)

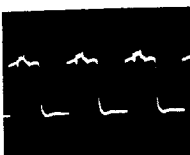

⑥3.6Vp-p(H)

⑩0.7Vp-p(H)

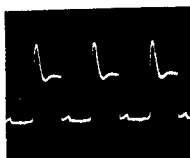

⑪210Vp-p(H)

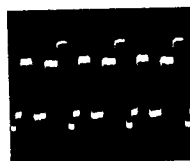

⑨95Vp-p(H)

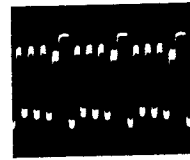

⑥100Vp-p(H)

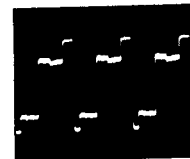

⑦98Vp-p(H)

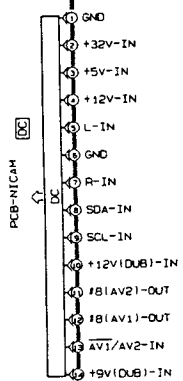

PCB-AV

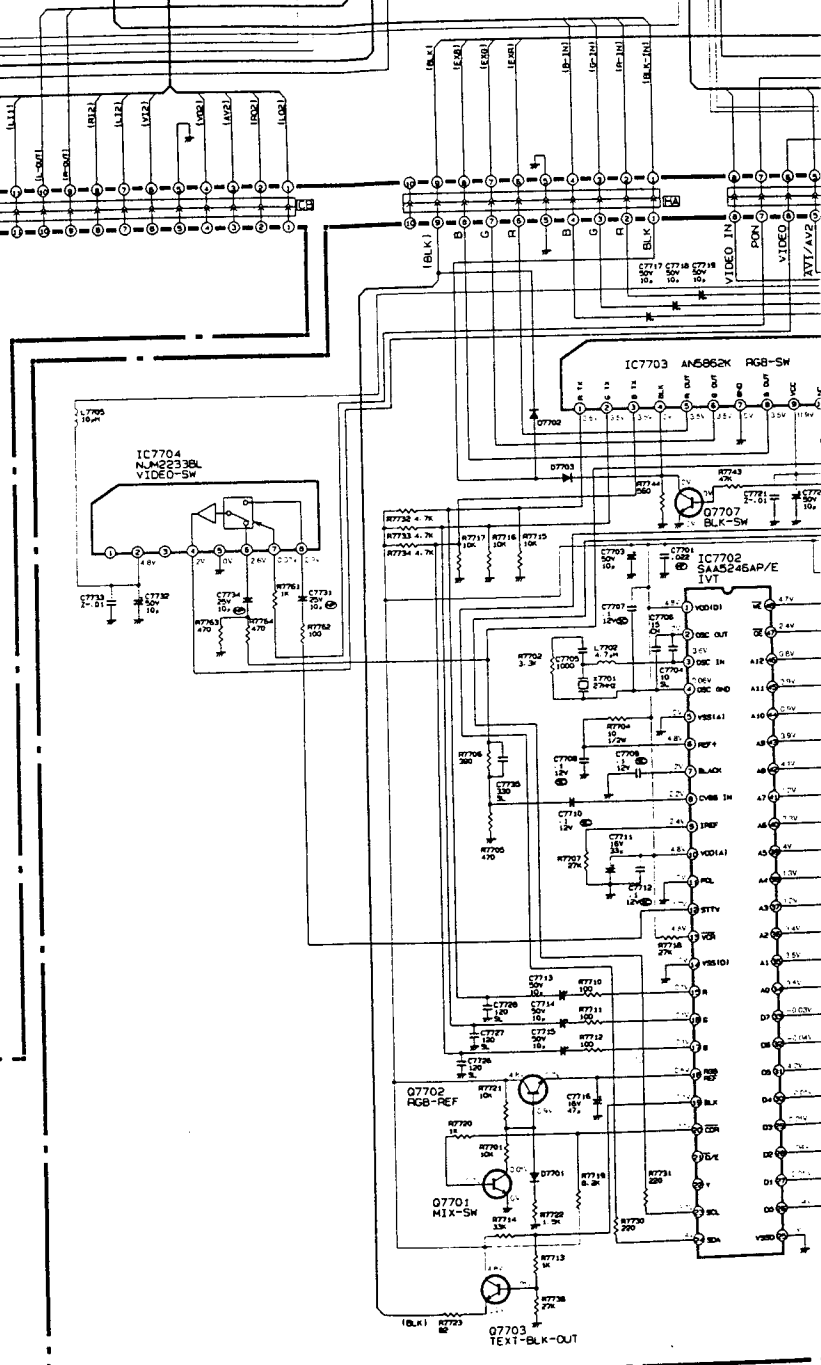
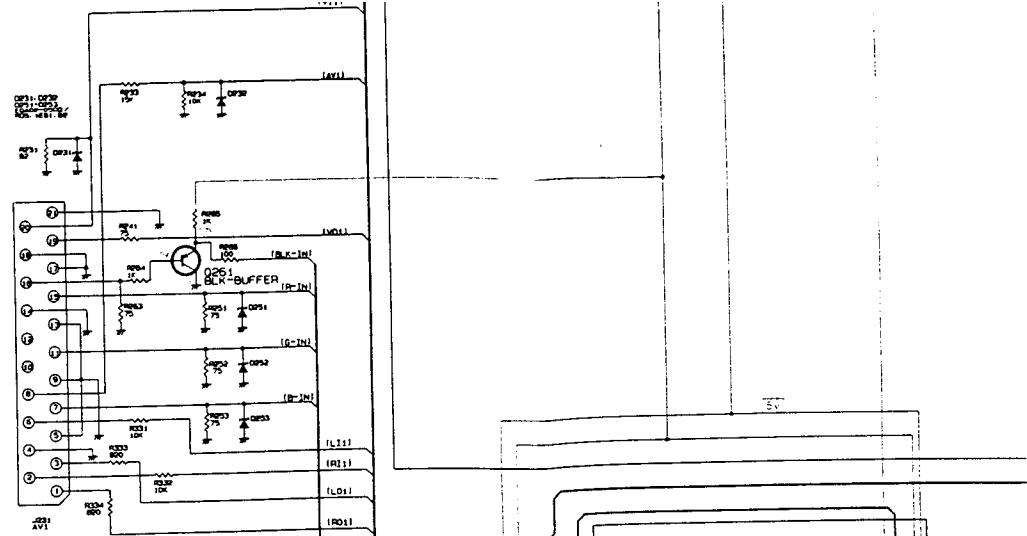

PCB-TEX

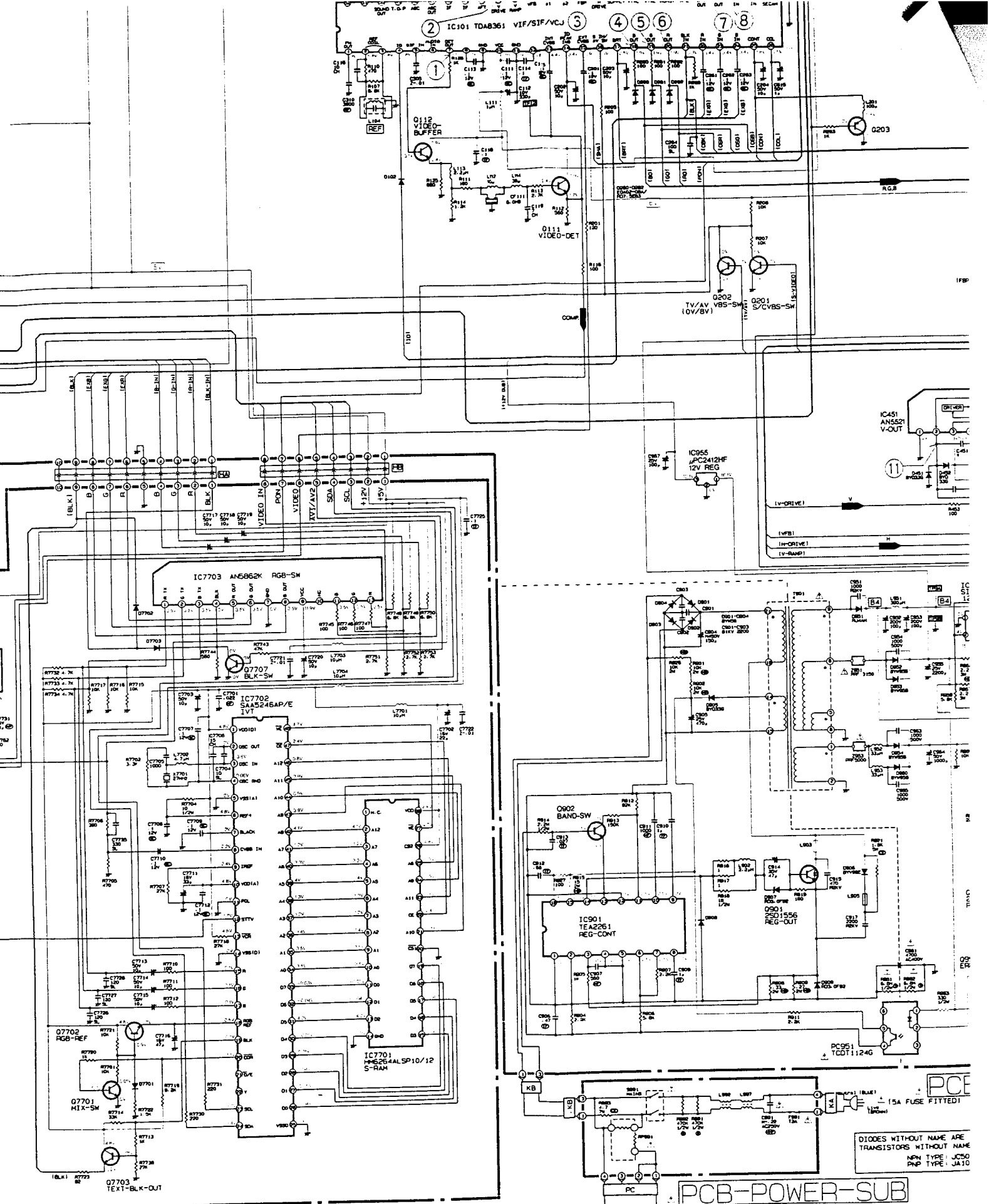

PCB-TEXT

PCB-POWER-SUB

Q261	A-6	
Q361	A-3	
Q401	D-7	
Q402	D-7	
Q431	A-5	
Q551	E-5	
Q552	C-5	
Q553	C-4	
Q702	A-3	
Q703	A-3	
Q704	A-3	
Q705	A-3	
Q706	E-1	
Q707	B-2	
Q901	E-3	
Q902	E-4	
Q953	D-4	
Q954	B-1	
Q955	B-2	
S451	D-7	
S701	D-1	
S702	D-1	
S703	D-1	
S706	D-1	
SF101	A-5	
SF102	A-5	
T551	E-6	
T552	C-4	
T901	D-3	
TH531	A-4	
TU101	A-6	

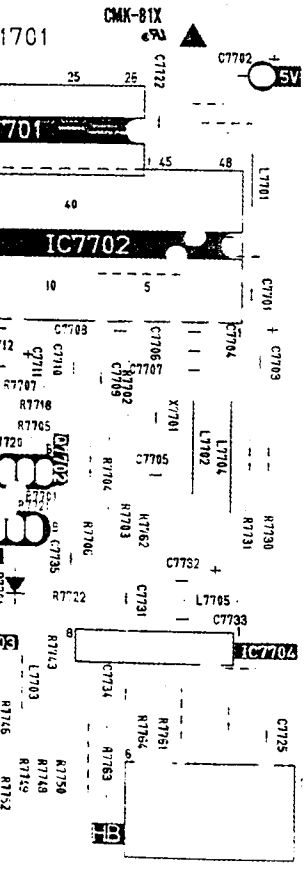
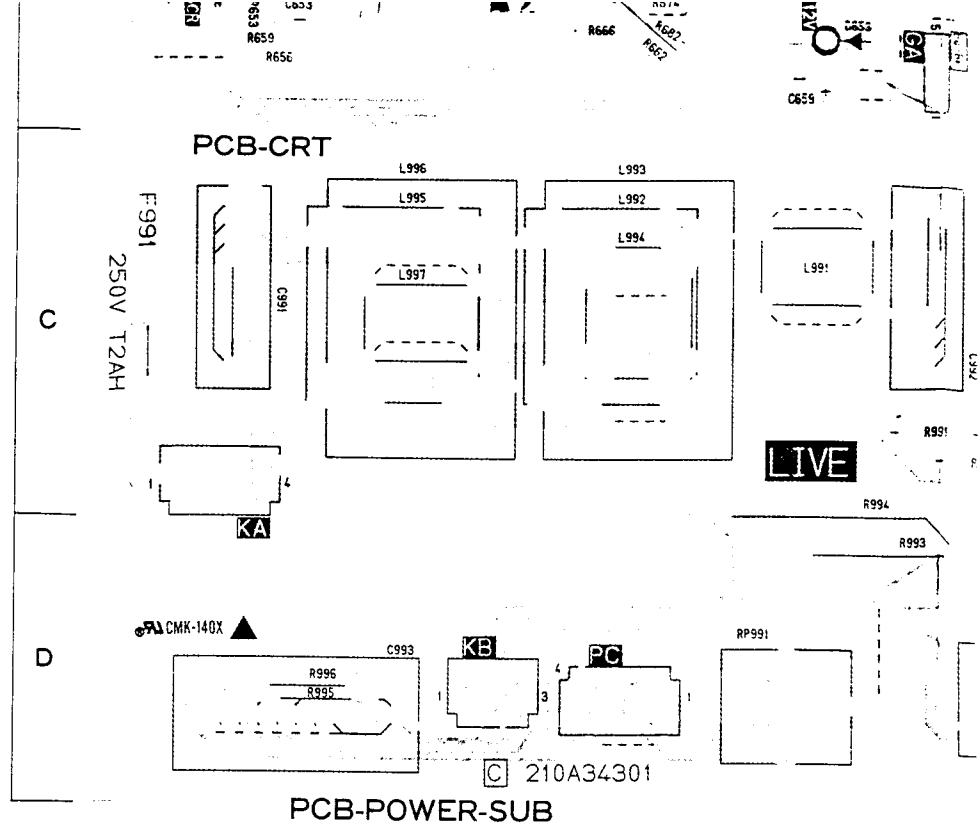

PCB-NICAM

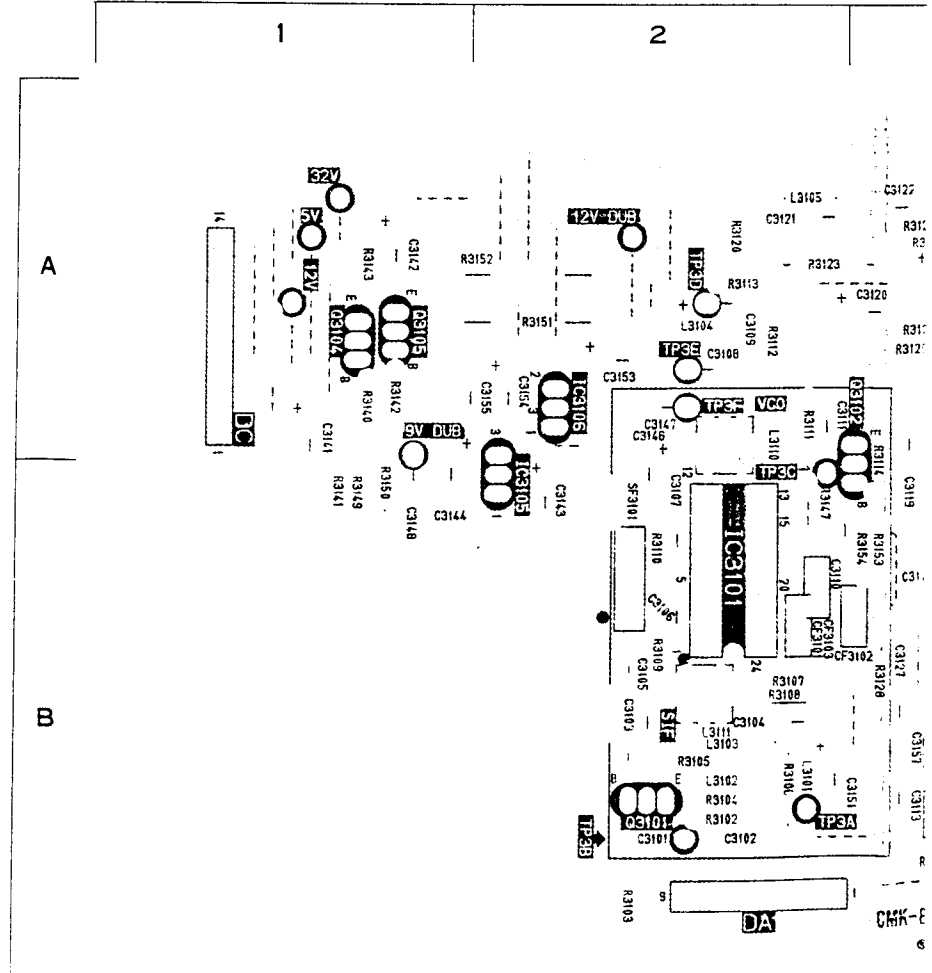

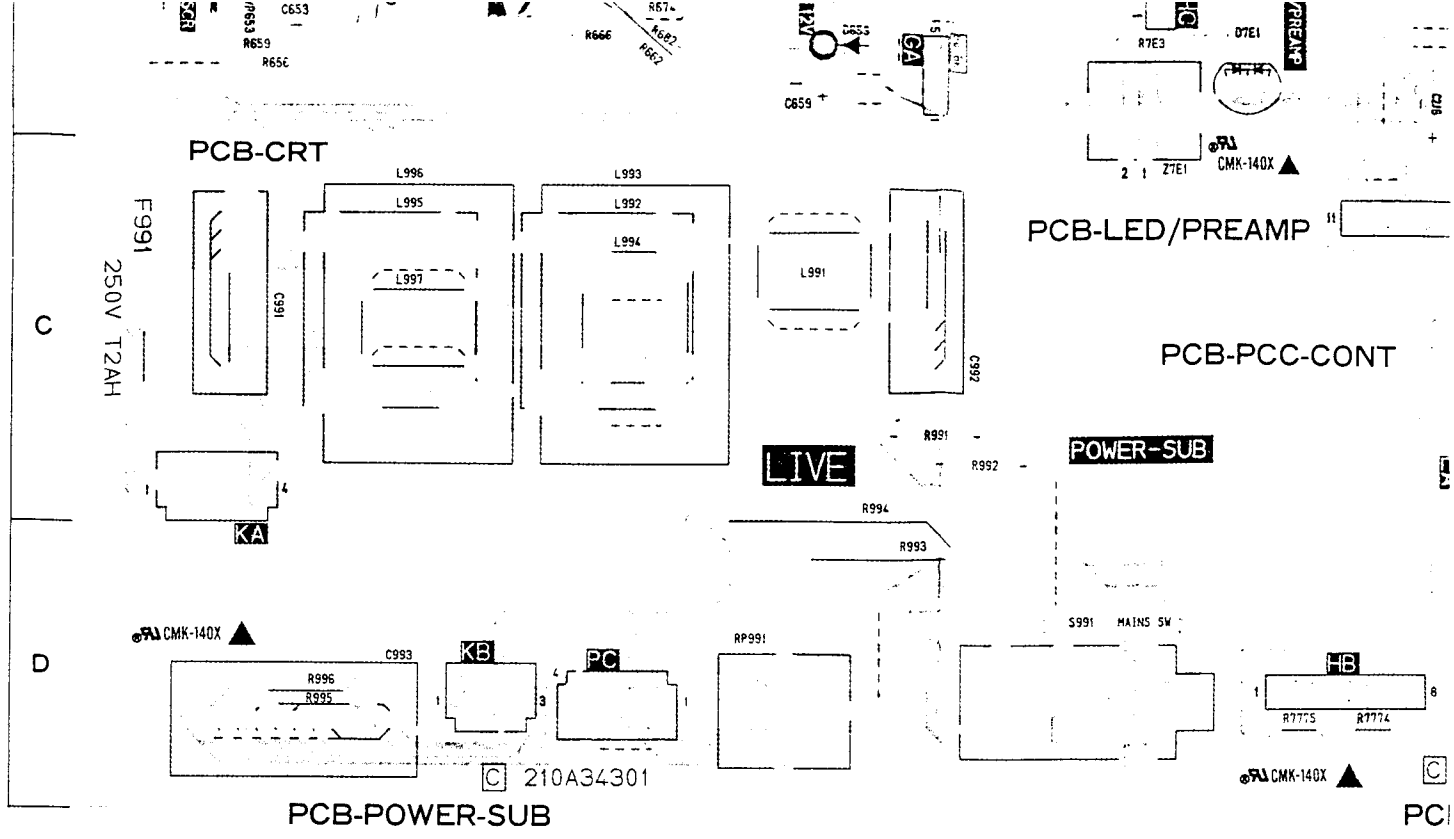

PCB-NICAM

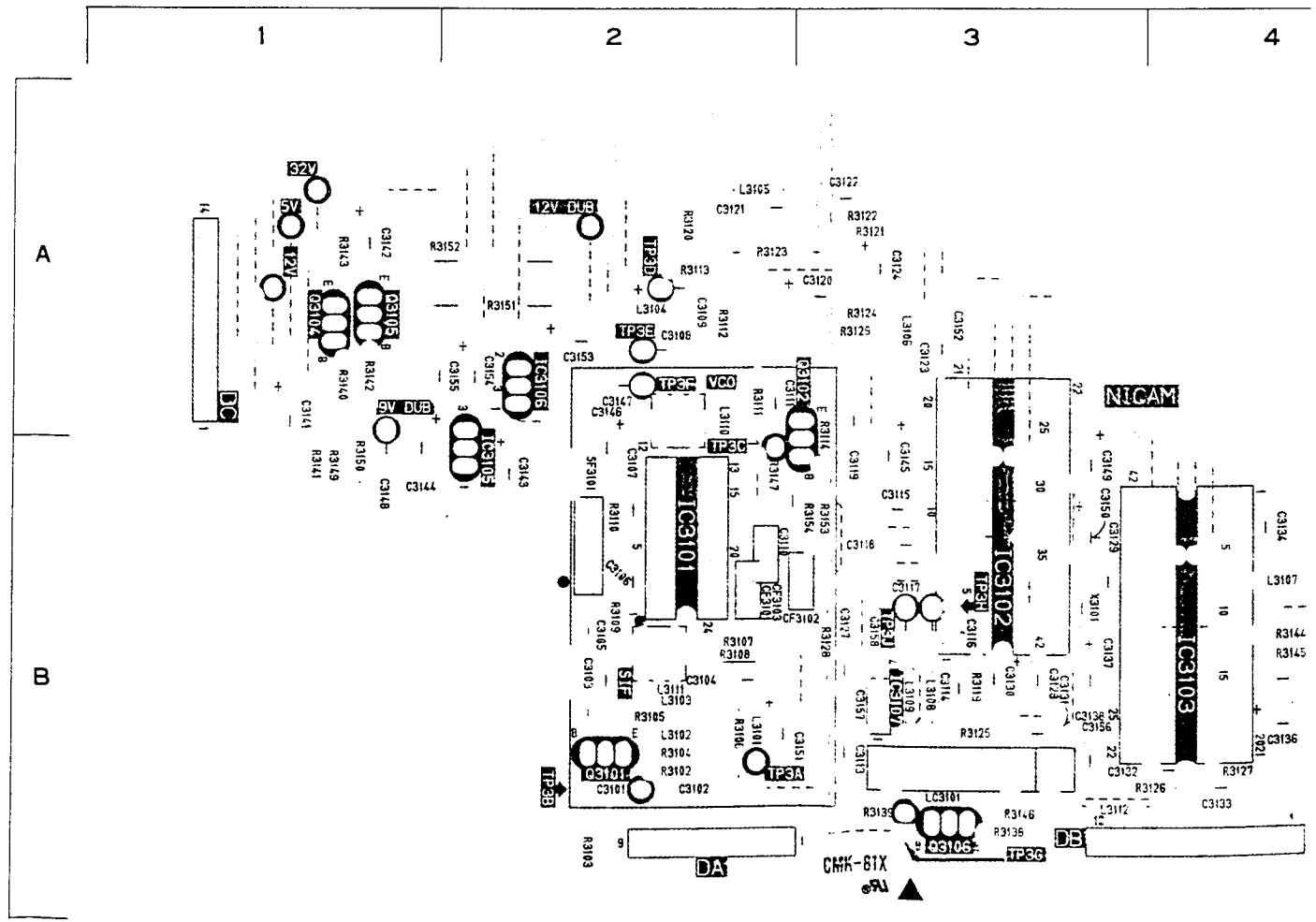

PCB-LED/PREAMP

PCB-PCC-CONT

POWER-SUB

RGB-BIAS

PCB-RGB-BIAS

L996	C-1
L997	C-1
Q2J1	B-5
Q2J2	B-5
Q2J3	A-5
Q2J4	A-4
Q2J5	A-4
Q5E1	C-5
Q5E2	D-4
Q651	B-1
Q652	A-1
Q653	B-2
Q654	A-1
RP991	D-2
S991	D-3
VR5E1	C-5
VR5E2	C-5
VR5E3	D-5
VR651	B-1
VR652	B-1
VR653	B-1
VR654	A-1
VR655	A-1
Z7E1	C-3

PCB-NICAM

SYMBOL NO.	ADDRESS
CF3101	B-2
CF3103	B-2
IC3101	B-2
IC3102	B-3
IC3103	B-4
IC3105	B-2
IC3106	A-2
IC3107	B-3
L3101	A-2
L3101	B-2
L3102	B-2
L3103	B-2
L3104	A-2
L3106	A-3
L3107	B-4
L3108	B-3
L3109	B-3
L3110	A-2
L3111	B-2
L3112	B-3
LC3101	B-3
Q3101	B-2
Q3102	A-3
Q3104	A-1
Q3105	A-1
Q3106	B-3
SF3101	B-2

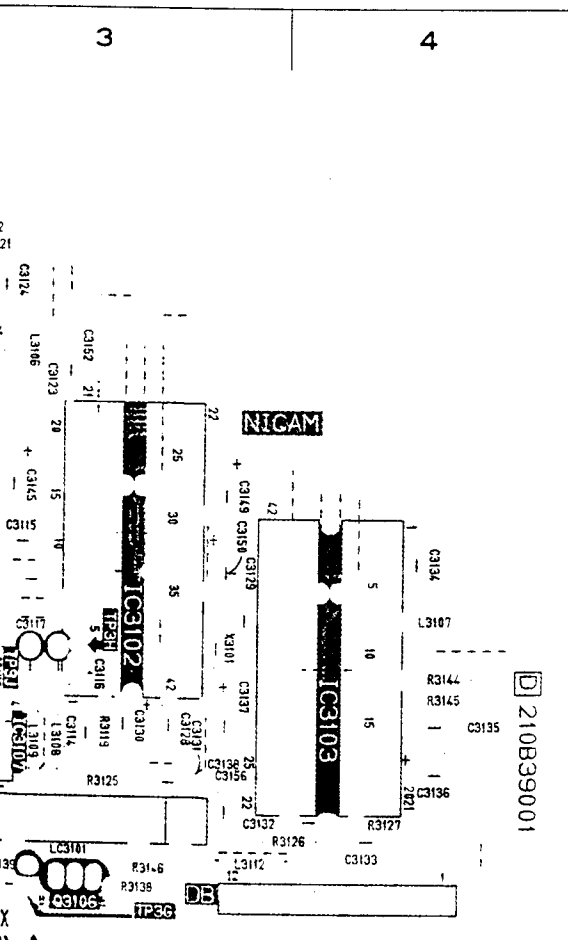

D 210B39001

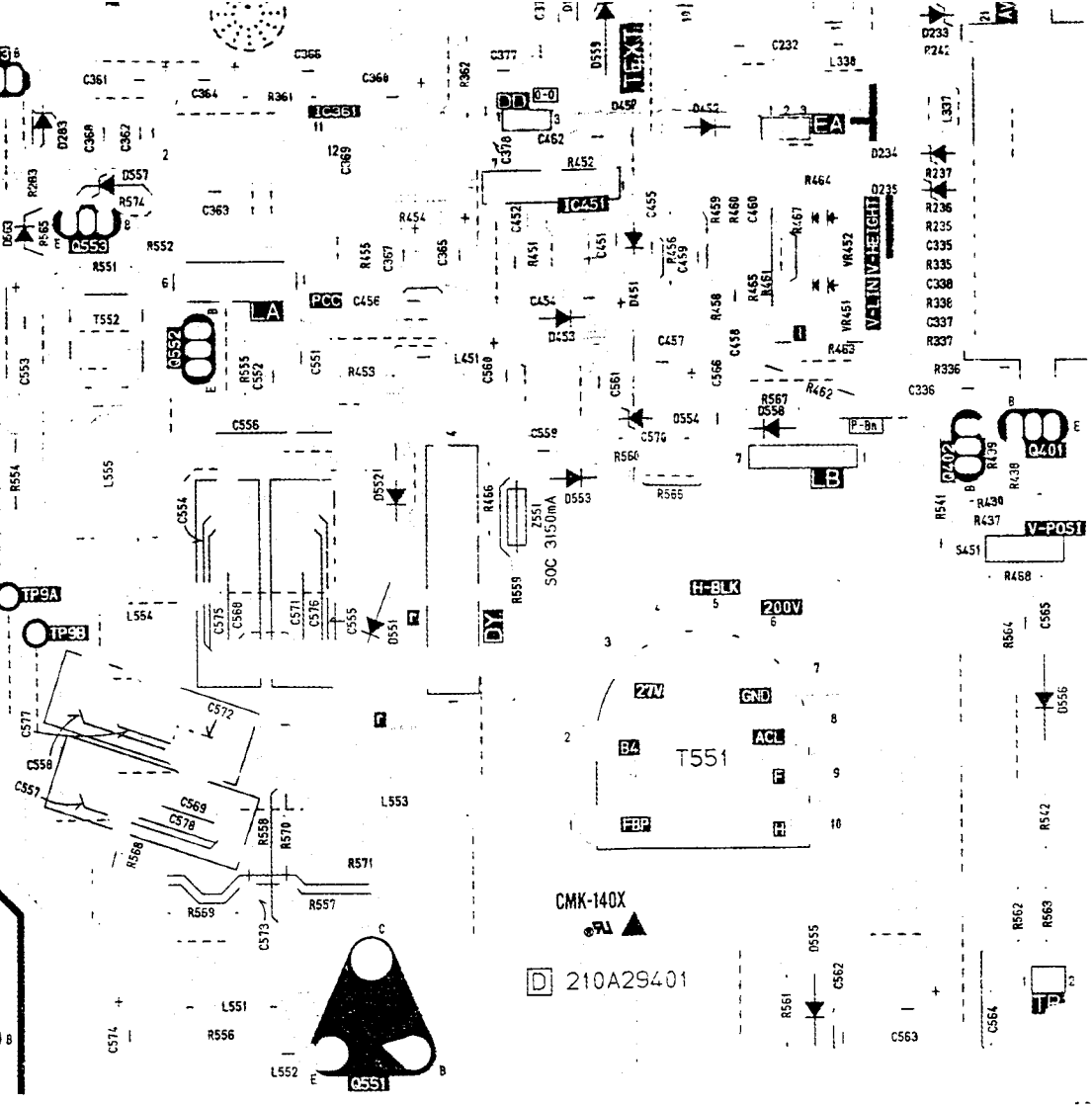

D365	A-3	IC955	
D451	C-6	L101	
D452	C-6	L104	
D452	C-6	L105	
D453	C-6	L111	
D531	A-4	L112	
D551	D-5	L113	
D552	D-5	L114	
D553	D-6	L151	
D554	D-6	L152	
D555	E-6	L201	
D556	D-7	L331	
D557	C-4	L332	
D558	D-6	L333	
D559	C-6	L333	
D563	C-4	L334	
D601	B-4	L335	
D701	B-2	L335	
D702	B-2	L336	
D703	B-2	L337	
D704	B-2	L338	
D705	B-2	L351	
D706	B-2	L352	
D710	B-3	L361	
D711	B-3	L362	
D712	B-3	L363	
D713	B-4	L451	
D714	A-2	L531	
D901	E-2	L551	
D902	E-2	L552	
D903	E-2	L553	
D904	E-2	L554	
D905	D-4	L555	
D906	D-3	L701	
D907	E-4	L702	
D908	E-4	L703	

PCB-TEXT

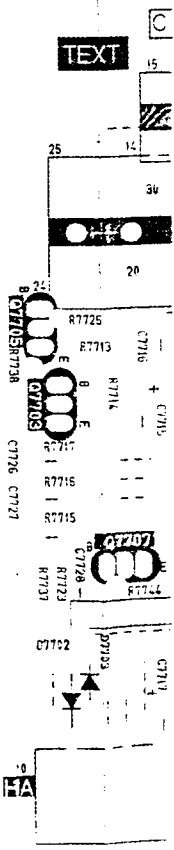

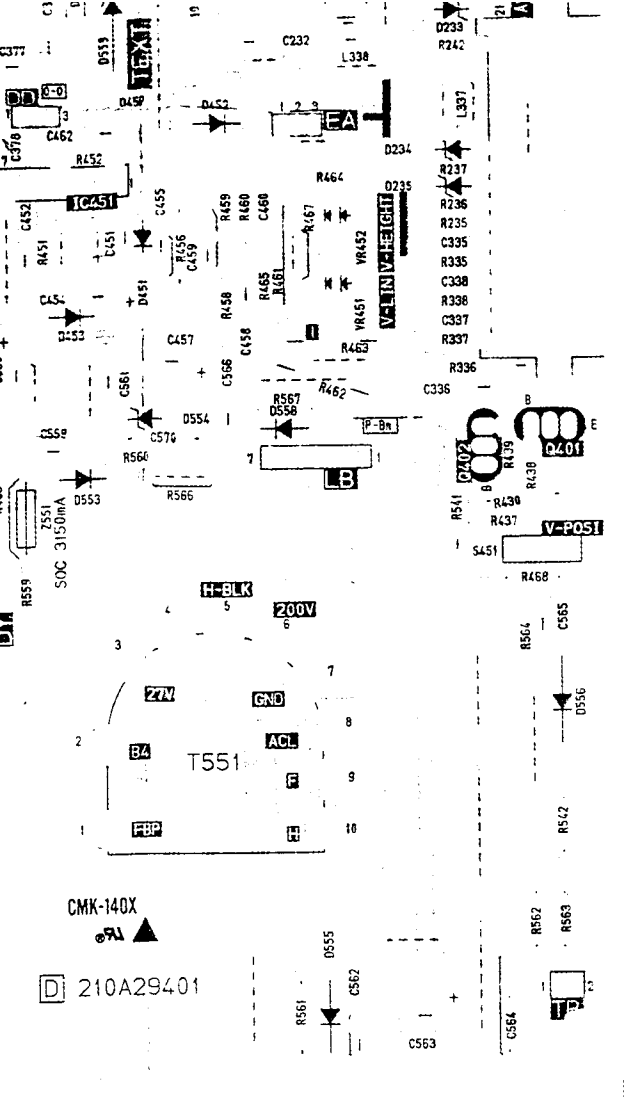

D365	A-3
D451	C-6
D452	C-6
D452	C-6
D453	C-6
D531	A-4
D551	D-5
D552	D-5
D553	D-6
D554	D-6
D555	E-6
D556	D-7
D557	C-4
D558	D-6
D559	C-6
D563	C-4
D601	B-4
D701	B-2
D702	B-2
D703	B-2
D704	B-2
D705	B-2
D706	B-2
D710	B-3
D711	B-3
D712	B-3
D713	B-4
D714	A-2
D901	E-2
D902	E-2
D903	E-2
D904	E-2
D905	D-4
D906	D-3
D907	E-4
D908	E-4

IC955	C-2
L101	A-5
L104	B-5
L105	A-5
L111	B-5
L112	B-5
L113	B-5
L114	B-5
L151	A-6
L152	A-6
L201	C-4
L331	B-7
L332	B-7
L333	B-6
L334	B-6
L335	B-6
L335	B-6
L336	B-6
L337	C-7
L338	C-6
L351	C-1
L352	C-1
L361	B-1
L362	B-1
L363	B-1
L451	C-5
L531	A-4
L551	E-5
L552	E-5
L553	E-5
L554	D-5
L555	D-4
L701	B-3
L702	B-3
L703	B-3

Q361	A-3
Q401	D-7
Q402	D-7
Q431	A-5
Q551	E-5
Q552	C-5
Q553	C-4
Q702	A-3
Q703	A-3
Q704	A-3
Q705	A-3
Q706	E-1
Q707	B-2
Q901	E-3
Q902	E-4
Q953	D-4
Q954	B-1
Q955	B-2
S451	D-7
S701	D-1
S702	D-1
S703	D-1
S706	D-1
SF101	A-5
SF102	A-5
T551	E-6
T552	C-4
T901	D-3
TH531	A-4
TU101	A-6

PCB-TEXT

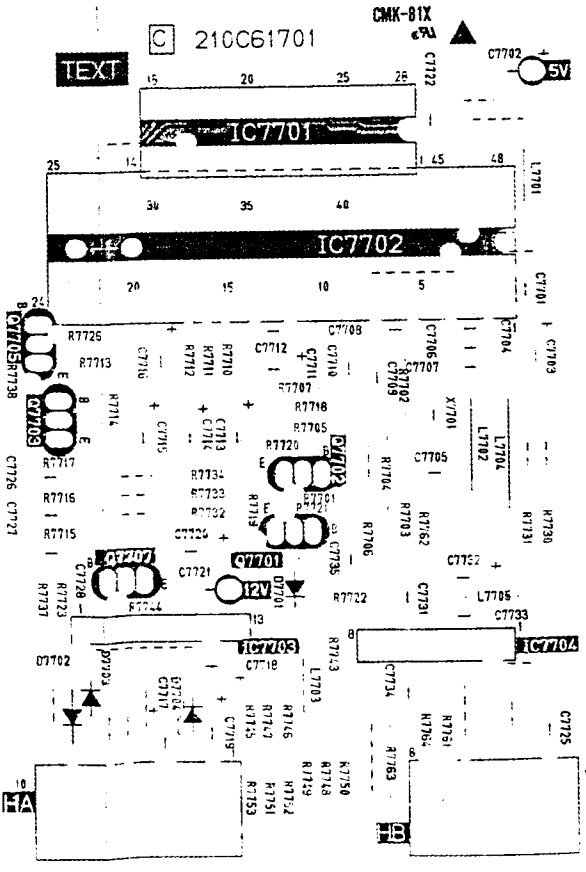

C-2	Q261	A-6	
A-5	Q401	D-7	
B-5	Q402	D-7	
A-5	Q431	A-5	
B-5	Q551	E-5	
B-5	Q552	C-5	
B-5	Q553	C-4	
B-5	Q702	A-3	
A-6	Q703	A-3	
A-6	Q704	A-3	
C-4	Q705	A-3	
B-7	Q706	E-1	
B-7	Q707	B-2	
B-6	Q901	E-3	
B-6	Q902	E-4	
B-6	Q953	D-4	
B-6	Q954	B-1	
B-6	Q955	B-2	
C-7			
C-6	S451	D-7	
C-1	S701	D-1	
C-1	S702	D-1	
B-1	S703	D-1	
B-1	S706	D-1	
B-1			
C-5	SF101	A-5	
A-4	SF102	A-5	
E-5			
E-5	T551	E-6	
E-5	T552	C-4	
D-5	T901	D-3	
D-4			
B-3	TH531	A-4	
B-3			
B-3	TU101	A-6	

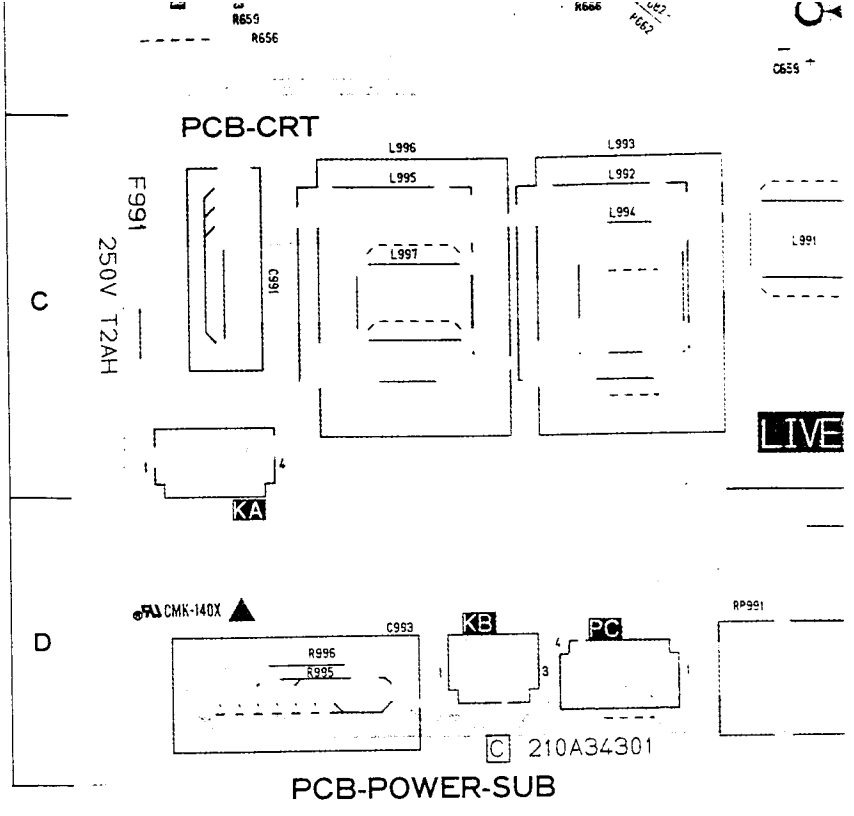

KT

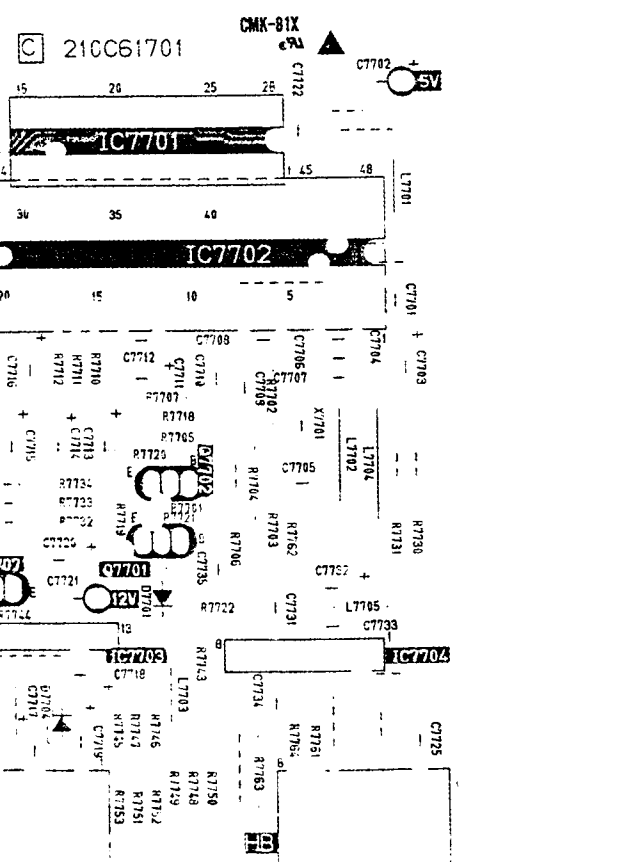

PCB-NICAM

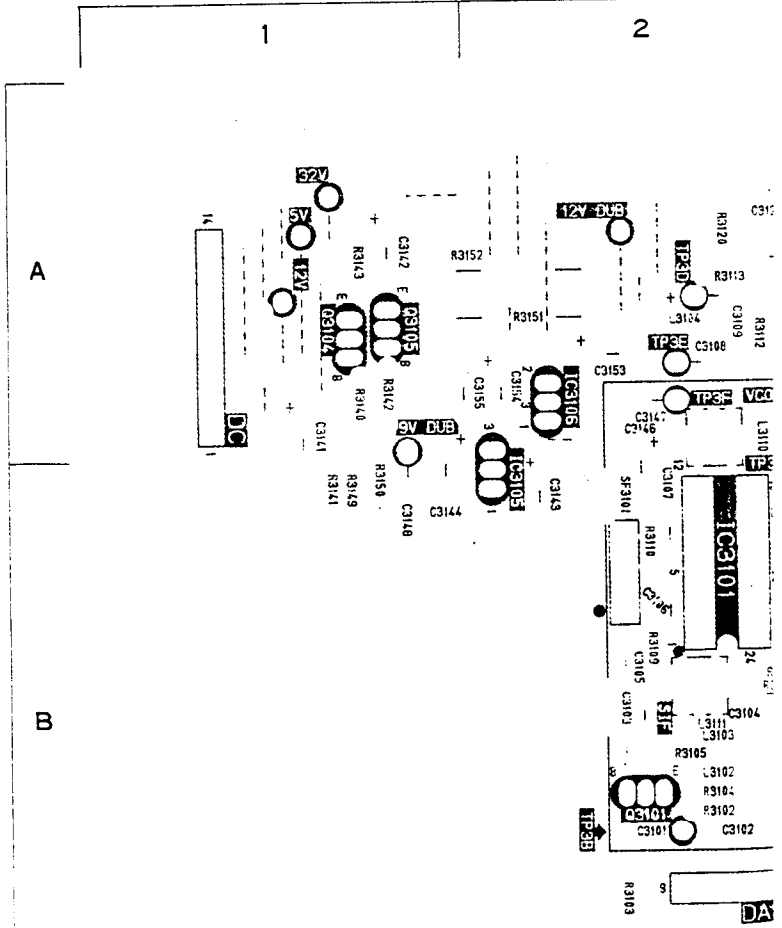

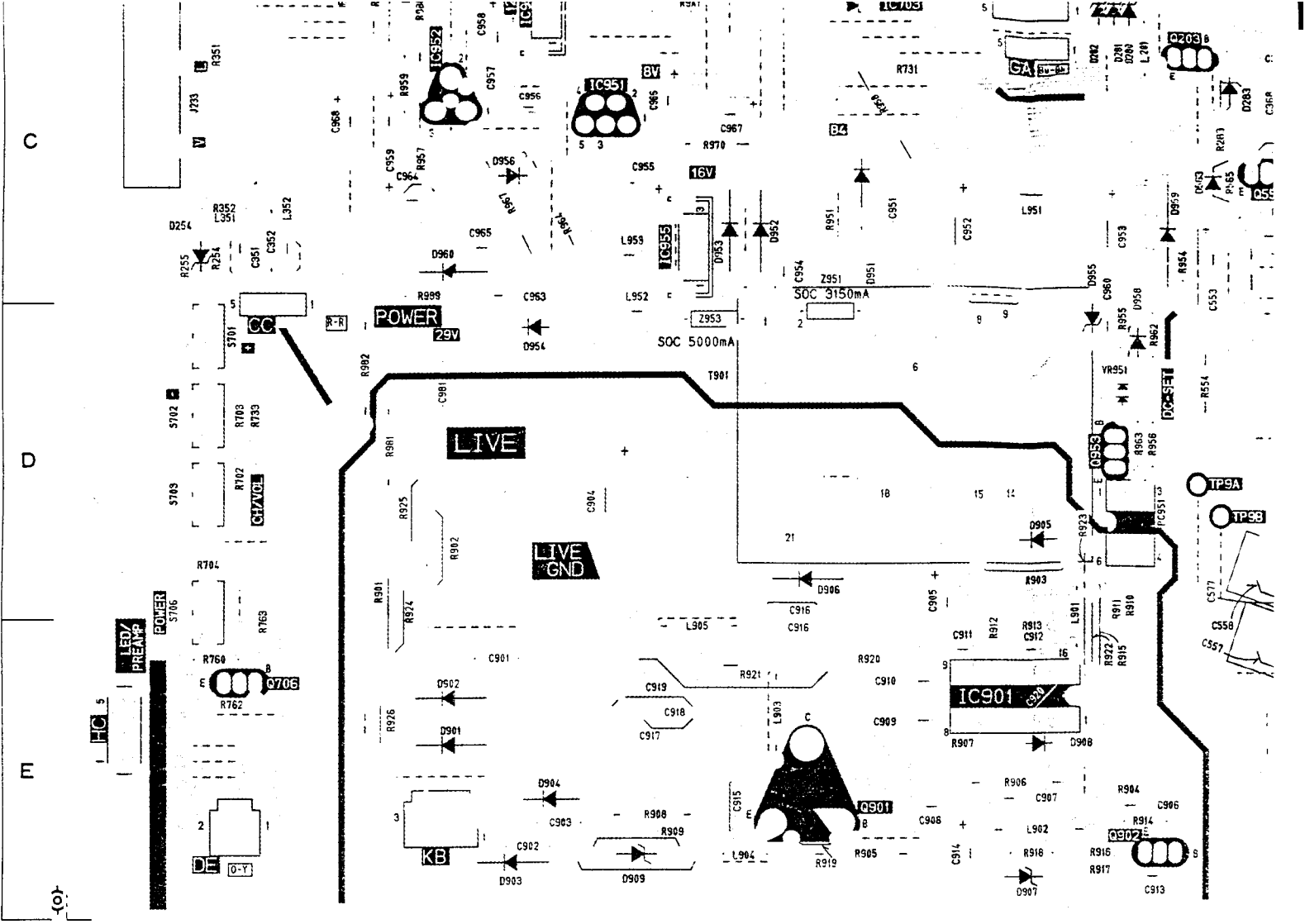

CT-21A5LST
 CT-21A5STX
 CT-25A5STX

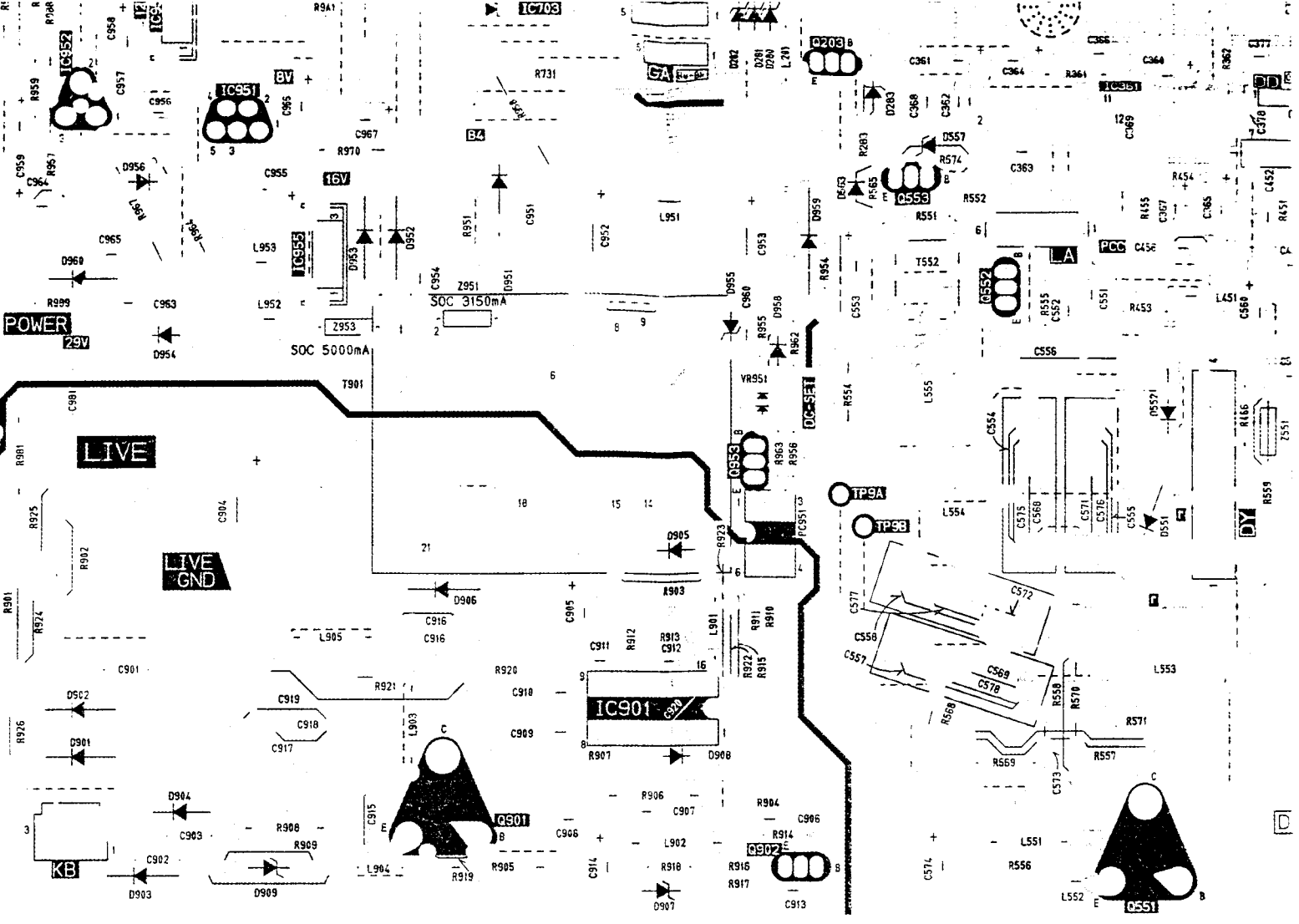

PCB-MAIN

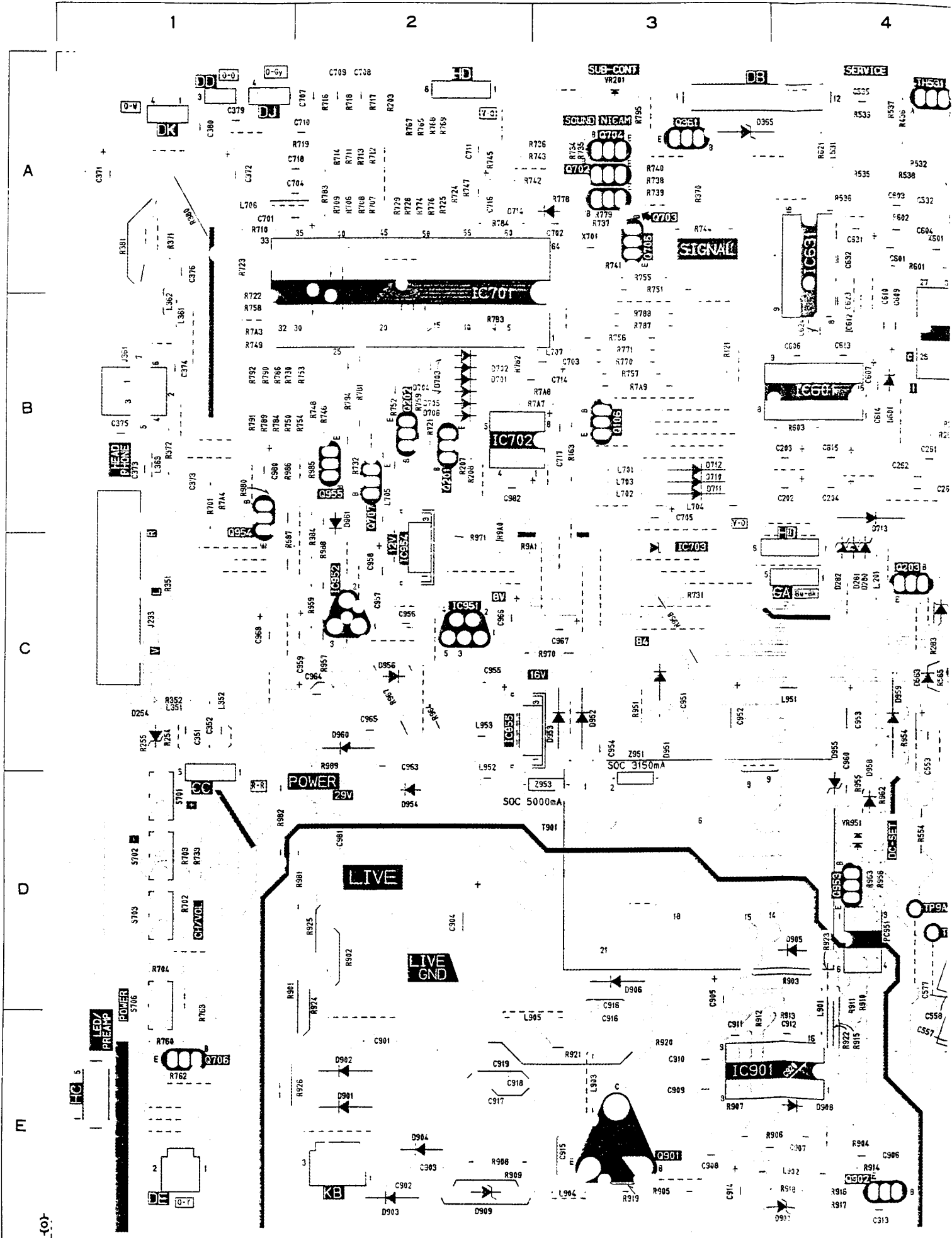

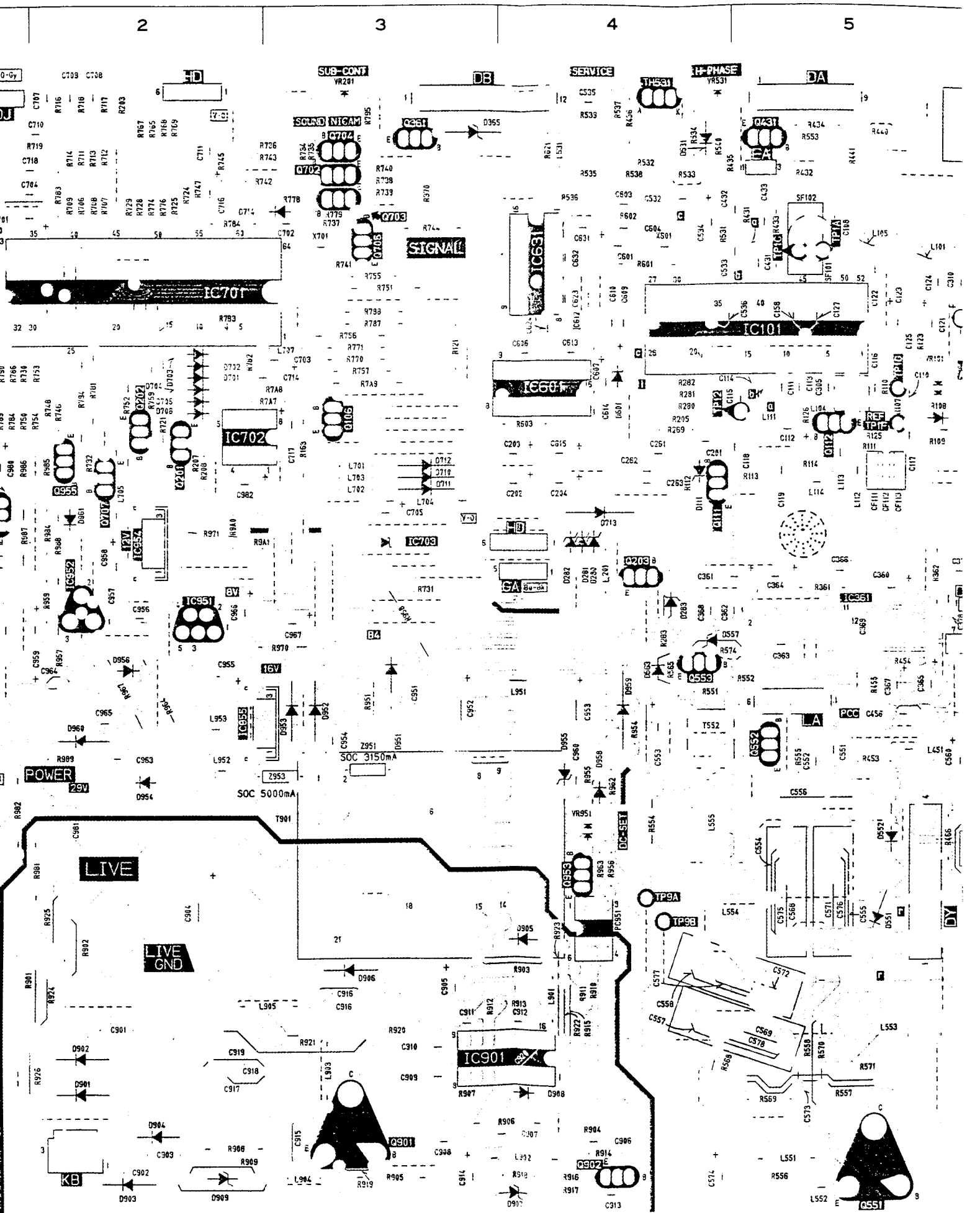

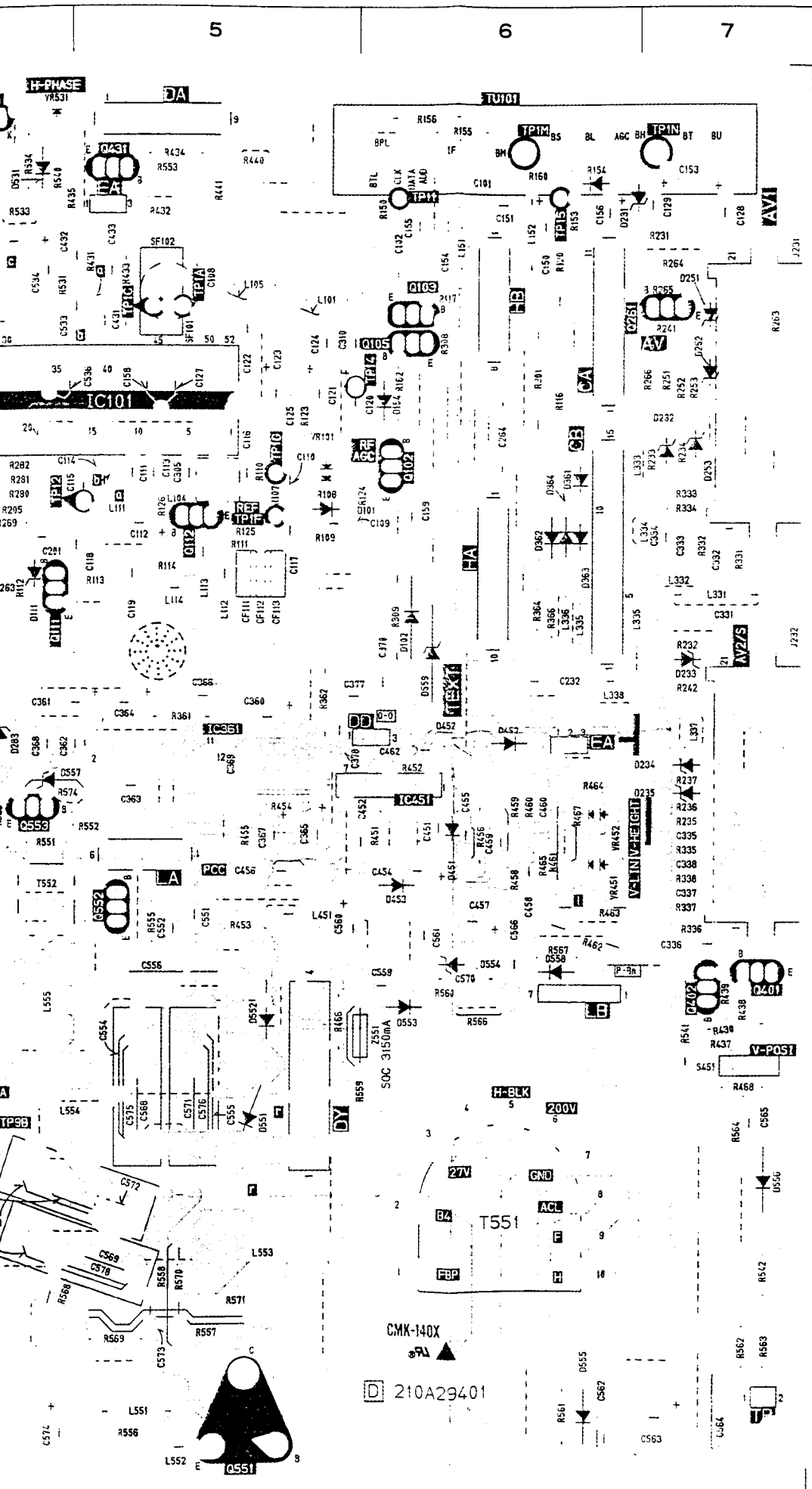

PCB-MAIN

SYMBOL NO.	ADDRESS
CF111	B-5
CF112	B-5
CF113	B-5
D101	B-6
D102	B-6
D111	B-4
D154	B-6
D231	A-6
D232	B-7
D233	C-7
D234	C-7
D235	C-7
D251	A-7
D252	A-7
D253	B-7
D254	C-1
D280	C-4
D281	C-4
D282	C-4
D283	C-4
D361	B-6
D362	B-6
D364	B-6
D365	A-3
D451	C-6
D452	C-6
D452	C-6
D453	C-6
D531	A-4
D551	D-5
D552	D-5
D553	D-6
D554	D-6
D555	E-6
D556	D-7
D557	C-4
D558	D-6
D559	C-6
D563	C-4
D601	B-4
D701	B-2
D702	B-2
D703	B-2
D704	B-2
D705	B-2
D706	B-2
D710	B-3
D711	B-3
D712	B-3
D713	B-4
D714	A-2
D901	E-2
D902	E-2
D903	E-2
D904	E-2
D905	D-4
D906	D-3
D907	E-4
D908	E-4

SYMBOL NO.	ADDR
D909	E-2
D951	C-3
D952	C-3
D953	C-3
D954	D-2
D955	C-4
D955	C-4
D956	C-2
D958	D-4
D960	C-2
D961	B-2
IC101	B-5
IC361	C-5
IC451	C-6
IC601	B-4
IC631	A-4
IC701	A-2
IC702	B-2
IC703	C-3
IC901	E-3
IC951	C-2
IC952	C-2
IC954	C-2
IC955	C-2
L101	A-5
L104	B-5
L105	A-5
L111	B-5
L112	B-5
L113	B-5
L114	B-5
L151	A-6
L152	A-6
L201	C-4
L331	B-7
L332	B-7
L333	B-6
L334	B-6
L335	B-6
L335	B-6
L335	B-6
L336	B-6
L337	C-7
L338	C-6
L351	C-1
L352	C-1
L361	B-1
L362	B-1
L363	B-1
L451	C-5
L531	A-4
L551	E-5
L552	E-5
L553	E-5
L554	D-5
L555	D-4
L701	B-3
L702	B-3
L703	B-3

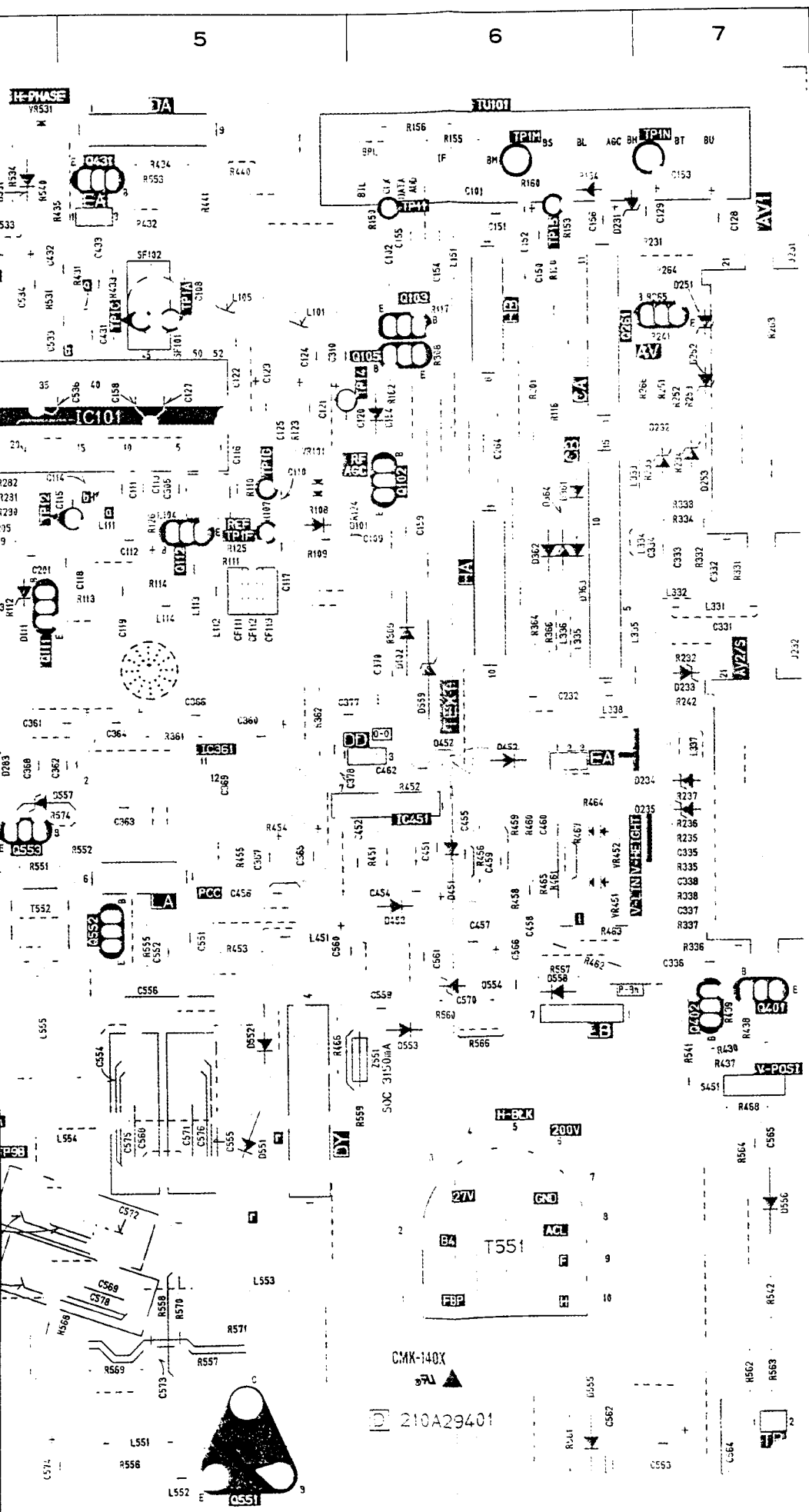

PCB-MAIN

SYMBOL NO.	ADDRESS
CF111	B-5
CF112	B-5
CF113	B-5
D101	B-6
D102	B-6
D111	B-4
D154	B-6
D231	A-6
D232	B-7
D233	C-7
D234	C-7
D235	C-7
D251	A-7
D252	A-7
D253	B-7
D254	C-1
D280	C-4
D281	C-4
D282	C-4
D283	C-4
D361	B-6
D362	B-6
D364	B-6
D365	A-3
D451	C-6
D452	C-6
D452	C-6
D453	C-6
D531	A-4
D551	D-5
D552	D-5
D553	D-6
D554	D-6
D555	E-6
D556	D-7
D557	C-4
D558	D-6
D559	C-6
D563	C-4
D601	B-4
D701	B-2
D702	B-2
D703	B-2
D704	B-2
D705	B-2
D706	B-2
D710	B-3
D711	B-3
D712	B-3
D713	B-4
D714	A-2
D901	E-2
D902	E-2
D903	E-2
D904	E-2
D905	D-4
D906	D-3
D907	E-4
D908	E-4

SYMBOL NO.	ADDRESS
D909	E-2
D951	C-3
D952	C-3
D953	C-3
D954	D-2
D955	C-4
D955	C-4
D956	C-2
D958	D-4
D960	C-2
D961	B-2
IC101	B-5
IC361	C-5
IC451	C-6
IC601	B-4
IC631	A-4
IC701	A-2
IC702	B-2
IC703	C-3
IC901	E-3
IC951	C-2
IC952	C-2
IC954	C-2
IC955	C-2
L101	A-5
L104	B-5
L105	A-5
L111	B-5
L112	B-5
L113	B-5
L114	B-5
L151	A-6
L152	A-6
L201	C-4
L331	B-7
L332	B-7
L333	B-6
L334	B-6
L335	B-6
L335	B-6
L336	B-6
L336	B-6
L337	C-7
L338	C-6
L351	C-1
L352	C-1
L361	B-1
L362	B-1
L363	B-1
L451	C-5
L531	A-4
L551	E-5
L552	E-5
L553	E-5
L554	D-5
L555	D-4
L701	B-3
L702	B-3
L703	B-3

ESS

SYMBOL NO.	ADDRESS
L704	B-3
L705	B-2
L706	A-1
L707	B-3
L901	E-4
L902	E-4
L903	E-3
L904	E-3
L905	E-3
L951	C-4
L952	C-2
L953	C-2
PC951	D-4
Q102	B-6
Q103	A-6
Q105	A-6
Q106	B-3
Q111	B-4
Q112	B-5
Q201	B-2
Q202	B-2
Q203	C-4
Q261	A-6
Q361	A-3
Q401	D-7
Q402	D-7
Q431	A-5
Q551	E-5
Q552	C-5
Q553	C-4
Q702	A-3
Q703	A-3
Q704	A-3
Q705	A-3
Q706	E-1
Q707	B-2
Q901	E-3
Q902	E-4
Q953	D-4
Q954	B-1
Q955	B-2
S451	D-7
S701	D-1
S702	D-1
S703	D-1
S706	D-1
SF101	A-5
SF102	A-5
T551	E-6
T552	C-4
T901	D-3
TH531	A-4
TU101	A-6

SYMBOL NO.	ADDRESS
VR101	B-5
VR201	A-3
VR451	C-6
VR452	C-6
VR531	A-4
VR951	D-4
X601	A-4
X701	A-3
Z551	D-6
Z951	C-3
Z953	D-3

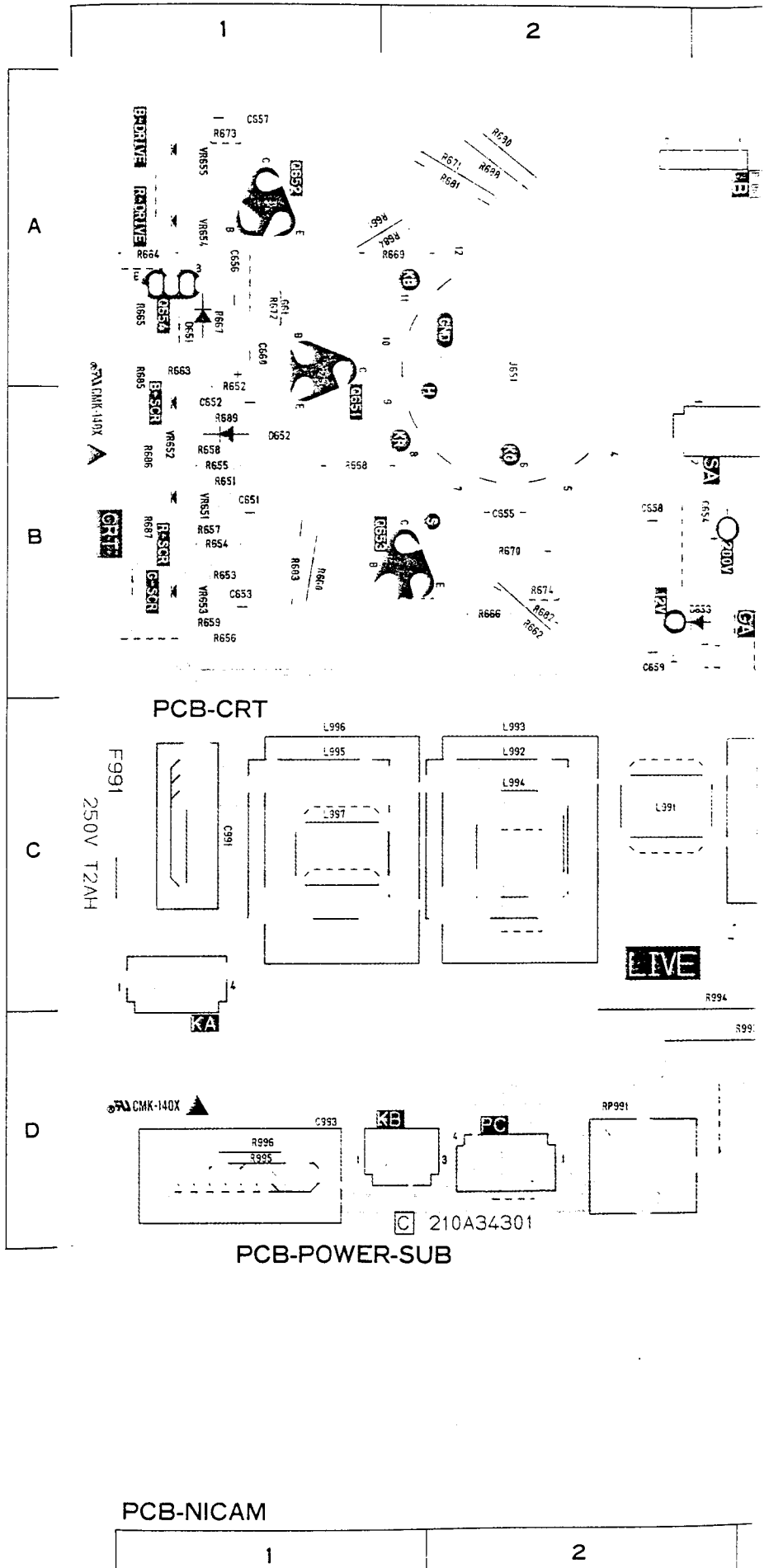

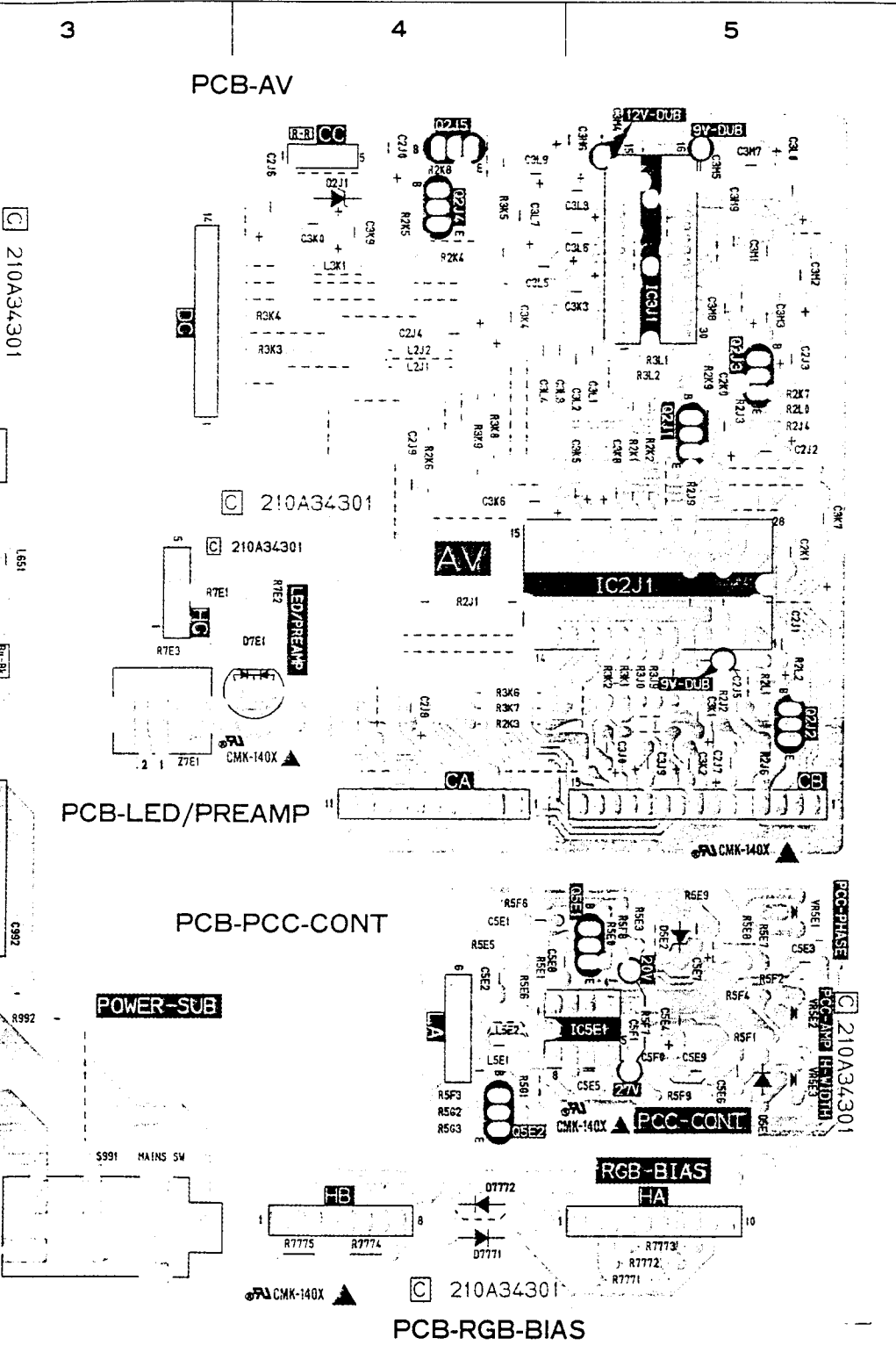

SYMBOL NO.	ADDRESS
D2J1	A-4
D5E1	D-5
D5E2	C-5
D651	A-1
D652	B-1
D653	B-3
D7771	D-4
D7772	D-4
D7E1	B-4
F991	C-1
IC2J1	B-5
IC3J1	A-5
IC5E1	C-5
L2J1	A-4
L2J2	A-4
L3K1	A-4
L5E1	C-4
L5E2	C-4
L651	B-3
L991	C-2
L992	C-2
L993	C-2
L994	C-2
L995	C-1
L996	C-1
L997	C-1
Q2J1	B-5
Q2J2	B-5
Q2J3	A-5
Q2J4	A-4
Q2J5	A-4
Q5E1	C-5
Q5E2	D-4
Q651	B-1
Q652	A-1
Q653	B-2
Q654	A-1
RP991	D-2
S991	D-3
VR5E1	C-5
VR5E2	C-5
VR5E3	D-5
VR651	B-1
VR652	B-1
VR653	B-1
VR654	A-1
VR655	A-1
Z7E1	C-3

PCB-NICAM

SYMBOL NO.	ADDRESS
CF3101	B-2
CF3103	B-2
IC3101	B-2

3 4