

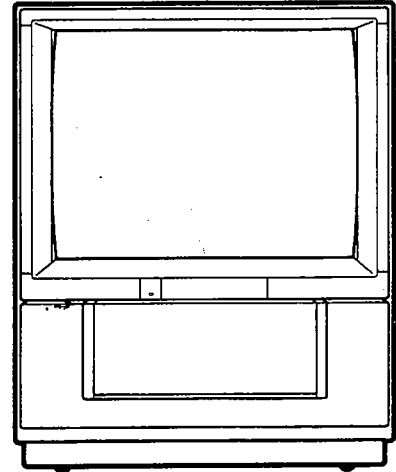

# Service Manual

COLOR TV  
JU-0 CHASSIS

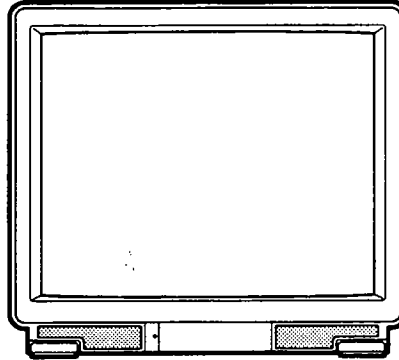
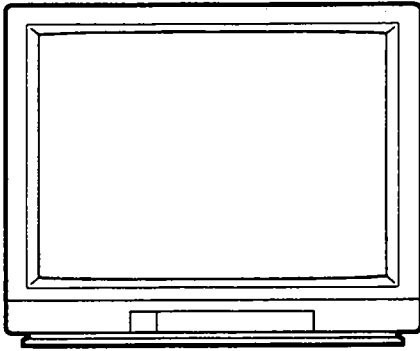

MODEL  
**CS-31203, CS-31203C**  
**CS-31303, CS-31303C**

MODEL  
**CS-35303**

MODEL  
**CK-35304**

## CAUTION

Before servicing this chassis, it is important that the serviceman reads the "SAFETY PRECAUTIONS" and "PRODUCT SAFETY NOTICE" in this service manual.

## SPECIFICATIONS

- |                              |   |                               |   |
|------------------------------|---|-------------------------------|---|
| • <b>Power Input</b>         | : AC 120V ; 60Hz  | • <b>Picture high voltage</b> | : 30.0kv (at 1mA) [CS-31203, CS-31203C]   |
| • <b>Power Consumption</b>   | : 175W [CS-31203, CS-31203C]<br>180W [CS-31303, CS-31303C]<br>195W [CS-35303, CK-35304]   |                               | : 29.0kv (at 1mA) [CS-35303]<br>32.0kv (at 1mA) [CK-35304]  |
| • <b>Reception Frequency</b> | : VHF 54~470MHz<br>UHF 470~806MHz   | • <b>Cabinet Dimensions</b>   | : 30.7" (W)×26.4" (H)×21.8" (D)<br>[CS-31203, CS-31203C]<br>[CS-31303, CS-31303C]<br>29.4" (W)×34.5" (H)×24.0" (D)<br>[CS-35303]<br>36.5" (W)×44.1" (H)×24.2" (D)<br>[CK-35304] |
| • <b>Speaker</b>             | : 2"×3.5", 2pcs. [CS-31203, CS-31203C]<br>[CS-31303, CS-31303C]<br>3.9" Round type, 2pcs.<br>1.6"×3.1" Oval type, 2pcs. [CS-35303]<br>3.9" Round type, 2pcs. [CK-35304] | • <b>Weight</b>               | : 129.8lbs [CS-31203, CS-31203C]<br>[CS-31303, CS-31303C]<br>168.2lbs [CS-35303]<br>243.7lbs [CK-35304]   |
| • <b>Picture tube</b>        | : M78JUA060×11 110° Deflection [CS-31203, CS-31203C]<br>[CS-31303, CS-31303C]<br>A89KPP50×03 110° Deflection [CS-35303]<br>M89KZP411×110° Deflection [CK-35304]         |                               |   |

•Weight and dimensions shown are approximate.  
•Design and specifications are subject to change without notice.

**MITSUBISHI ELECTRONICS AMERICA, INC.**

5665 Plaza Drive P.O. Box 6007 Cypress, California 90630-0007  
Copyright © 1994 Mitsubishi Electronics America, Inc. All Rights Reserved.

**MITSUBISHI ELECTRIC SALES CANADA INC.**

4229-14th Avenue, Markham Ontario, L3R 0J2  
Copyright © 1994 Mitsubishi Electric Canada Inc. All Rights Reserved.

# CONTENTS

<b>SAFETY PRECAUTIONS .....</b>	<b>1</b>
<b>PRODUCT SAFETY NOTICE .....</b>	<b>2</b>
<b>DISASSEMBLY .....</b>	<b>2</b>
Removal of Back Cover.....	2
Removal of PCB'S.....	2
Main chassis servicing position.....	3
<b>LEAD DRESS.....</b>	<b>4</b>
<b>CRT REPLACEMENT .....</b>	<b>7</b>
<b>ITC ADJUSTMENT .....</b>	<b>9</b>
1. Purity Adjustment .....	9
2. Static Convergence Adjustment .....	10
3. Screen corner landing compensation Adjustment.....	10
4. Yh correct Adjustment .....	11
5. Yv correct Adjustment .....	12
6. Xv correct Adjustment .....	13
7. Xh correct Adjustment.....	13
8. Convergence of screen corner Adjustment .....	14
9. Wedges position Adjustment.....	14
<b>ELECTRICAL ADJUSTMENTS.....</b>	<b>15</b>
Location of Tset Points and Adjustments .....	16
Initial Setup.....	17
Circuit Adjustment Mode .....	18
List of Adjustment Functions and Adjustment Items .....	19
Multi Channel Sound Circuit Adjustment .....	
1. SAP VCO Adjustment.....	22
2. Stereo VCO Adjustment .....	22
3. Input level Adjustment .....	23
4. Filter Adjustment.....	23
5. Separation Adjustment .....	24
Chroma Circuit Adjustment .....	
6. White Level Adjustment.....	24
7. Vector Adjustment .....	25
8. Color output Adjustment .....	25
Deflection Circuit Adjustment .....	
9. Horizontal Width Adjustment .....	26
10. Vertical linearity and height Adjustment .....	26
11. Side PCC Adjustment.....	27
12. Vertical S correction Adjustment .....	27
13. Horizontal position Adjustment .....	28
14. Vertical position Adjustment .....	28
CRT Circuit Adjustment .....	
15. CRT bias, Cut off Adjustment.....	29
16. White balance Adjustment.....	30
17. Black level Adjustment .....	30
Video Circuit Adjustment .....	
18. Sub cont Adjustment .....	31
Focus Circuit Adjustment .....	
19. Focus Adjustment (CS-35303, CK-35403 only) .....	31
20. Focus Adjustment (CS-31303, CS-31303C, CS-31203, CS-31203C only).....	32
Screen Character Circuit Adjustment .....	
21. Character Position Adjustment.....	32
PIP Circuit Adjustment .....	
22. PIP fsc Adjustment (CS-35303, CK-35304, CS-31303, CS-31303C only) .....	33
23. PIP chroma gain Adjustment (CS-35303, CK-35304, CS-31303, CS-31303C only) .....	33
24. PIP Sub TINT Adjustment (CS-35303, CK-35304, CS-31303, CS-31303C only) .....	34
<b>PARTS LIST.....</b>	<b>35</b>
<b>COSMETIC PARTS REFERENCE</b>	
<b>ELECTRICAL PARTS AND OTHERS</b>	
<b>CIRCUIT DIAGRAM</b>	

# SAFETY PRECAUTIONS

**NOTICE :** Observe all cautions and safety related notes located inside the receiver cabinet and on the receiver chassis.

## WARNING

1. Operation of this receiver outside the cabinet or with the cover removed presents a shock hazard from the receiver power supplies. Work on the receiver should not be attempted by anyone who is not thoroughly familiar with the precautions necessary when working on high-voltage equipment.
2. Do not install, remove or handle the picture tube in any manner unless shatter-proof goggles are worn. People not so equipped should be kept away while the picture tube is being handled. Keep the picture tube away from the body while handling.
3. When service is required, observe the original lear dress. Extra precaution should be given to assure correct lead dress in the high voltage area. Where a short-circuit has occurred, replace those components that indicate evidence of overheating.

## X-RADIATION WARNING

The surface of the cathode ray tube may generate X-Radiation. Take precautions when servicing and, if possible, the use of a lead apron is recommended for shielding while handling.

When replacing the cathode ray tube, use only the designated replacement part since it is a critical component with regard to X-Radiation as noted on page 2. (No high-voltage adjustments are provided.) The high-voltage specification is described on the cover page.

## LEAKAGE CURRENT CHECK

Before returning the receiver to the customer, it is recommended that leakage current be measured according to the following methods.

### 1. Cold Check

With the AC plug removed from the AC source, place a jumper across the two AC plug prongs. Turn the receiver AC switch on. Using an ohm-meter, connect one lead to the AC plug and touch the other lead to each exposed metal part (antennas, handle bracket, metal cabinet, screwheads, metal overlays, control shafts, etc.), particularly any exposed metal part having a return path to the chassis. Exposed metal parts having a return path to the chassis should have a minimum resistance reading of 1 meg ohm. Any resistance below this value indicates an abnormality which requires corrective action. Exposed metal parts not having a return path to the chassis will indicate an open circuit.

### 2. Hot Check

Use the circuit in Fig. 1 to perform this test.

- (1) With switch S1 open, connect the receiver to the measuring circuit. Immediately after connection, measure the leakage current using both positions of switch S2, and with the switching devices in the receiver in all of their operating positions.
- (2) Switch S1 is then closed, energizing the receiver. Immediately after closing the switch, measure the leakage current using both positions of switch S2, and with the switching devices in the receiver in all of their operating positions. Current measurements of items (1) and (2) are to be repeated after the receiver has reached thermal stabilization. The leakage current shall not be more than 0.5 miliampere.

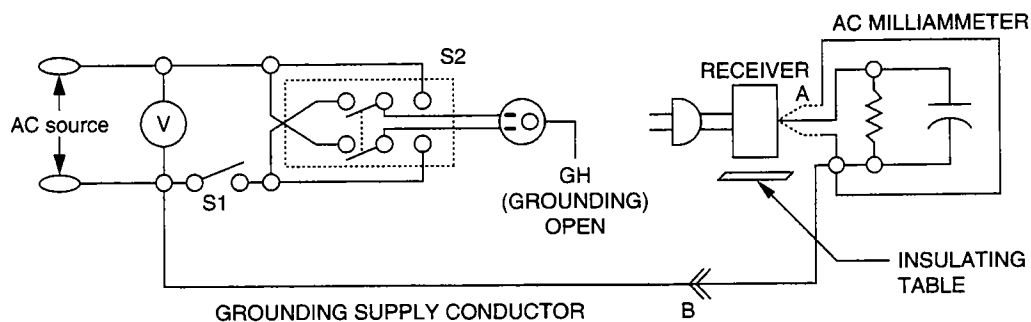

Fig. 1

# PRODUCT SAFETY NOTICE

Many electrical and mechanical parts in television receivers have special safety related characteristics. These characteristics are often not evident from visual inspection nor can the protection afforded by them necessarily be obtained by using replacement components rated for higher voltage, wattage, etc. Replacement parts which have special safety characteristics are identified in this service manual. Electrical components having such features are identified by shading on the schematic diagram and the parts list of this service manual, and by marking on the supplementary sheet for this chassis to be issued sub sequently. Therefore replacements for any safety party parts should be identical in value and characteristics.

## DISASSEMBLY

### Removal of Back Cover or Back Board

1. Remove 4 screws retaining the rear terminal panel to the back cover.
2. Remove 11 screws retaining the back cover to the front cabinet. (for CS-31203, CS-31203C, CS-31303, CS-31303C, CS-35303). Remove 9 screws retaining the back board to the cabinet. (for CK-35304)

### Removal of PCB'S

1. Pull out the chassis assembly while lifting the rear of the chassis slightly and release the holders.  
(for CS-31203, CS-31203C, CS-31303, CS-31303C, refer to Fig. 2-1)  
(for CS-35303 refer to Fig. 2-2) (for CK-35304 refer to Fig. 2-3)

**Note :** When servicing PCB-PIP and PCB-AV, use extension cords for easier access. (Part No. 859C431O20)  
(for CS-31303, CS-31303C, CS-35303, CK-35304)

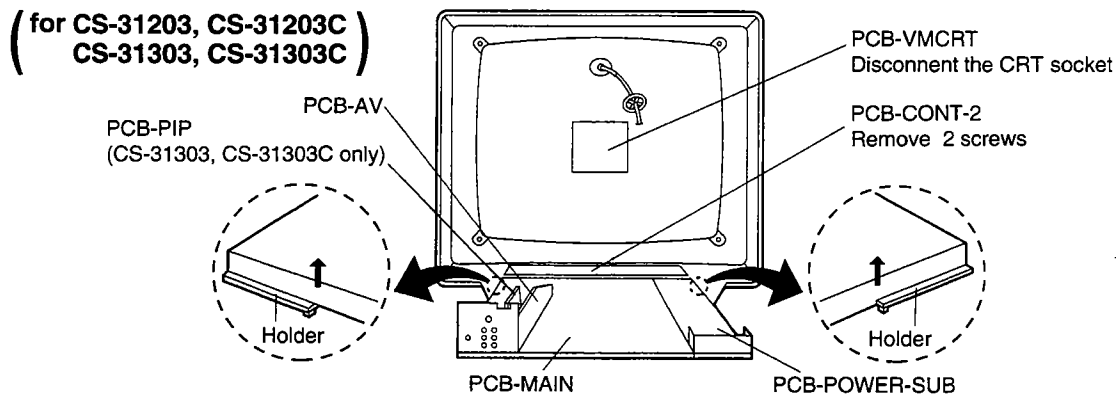

Chassis assembly including PCB-MAIN, PCB-AV, PCB-CONT-2, PCB-POWER-SUB and PCB-PIP (CS-31303, CS-31303C only)

Fig. 2-1

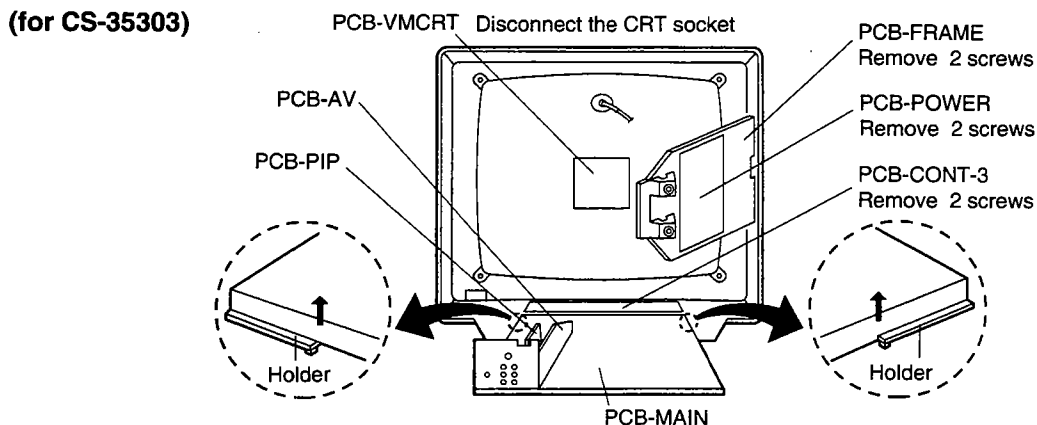

Chassis assembly including PCB-MAIN, PCB-AV and PCB-CONT-3, and PCB-PIP

Fig. 2-2

(CK-35304)

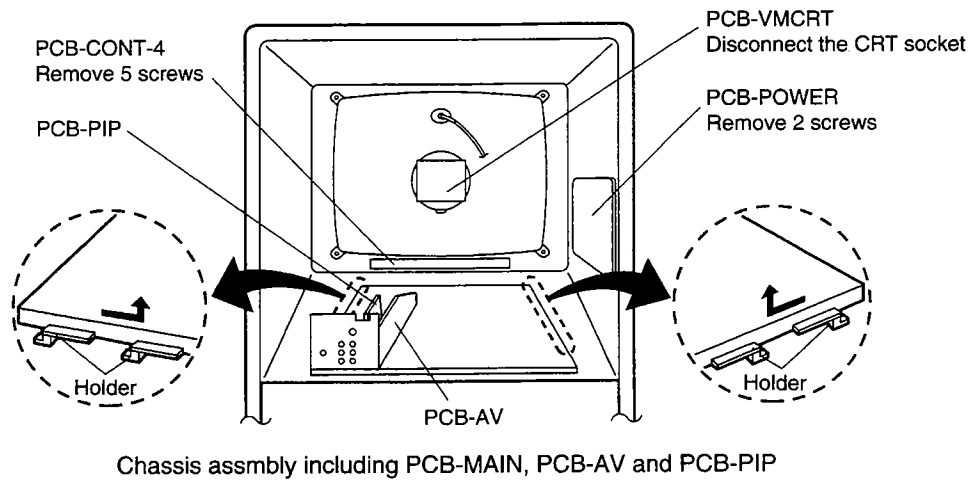

Fig. 2-3

### Main chassis servicing position

To service the bottom of a main chassis, refer to Fig. 3-1.

1. Cut stays off on the bottom of the main chassis, refer to Fig. 3-1
2. Insert the stays into the mounting positions as shown in the Fig. 3-2.

**[Caution]** To prevent mechanical vibration, DO NOT leave the stays in the cabinet.

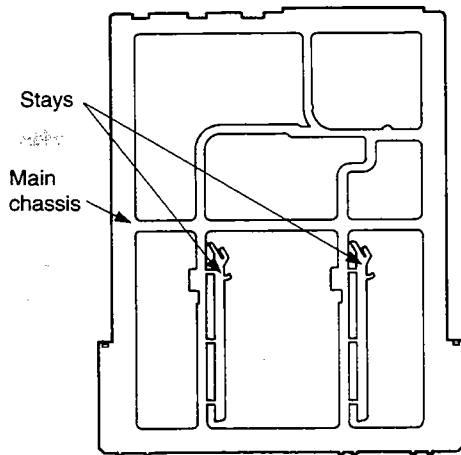

Fig. 3-1

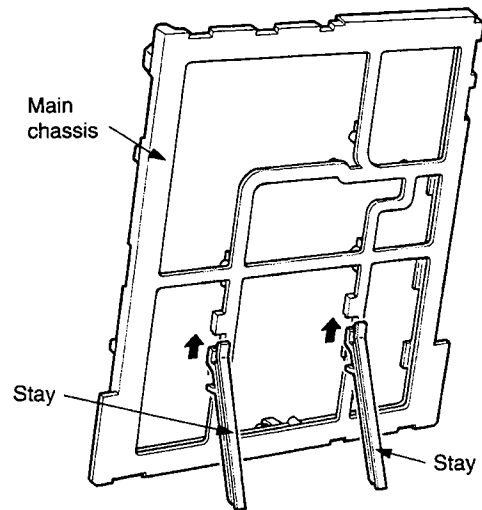

Fig. 3-2

# LEAD DRESS

The lead wires to be clamped are listed in the table below.

**NOTE :** The inner wires are clamped so that they do not come close to heat generating or high voltage parts. After servicing route all wires in their original position.

\* The anode lead wire is routed so that no tensile strength is applied to the cap. If the route of the anode lead wire is changed, return it to the initial route shown below.

[for CS-31303, CS-31303C, CS-31203, CS-31203C]

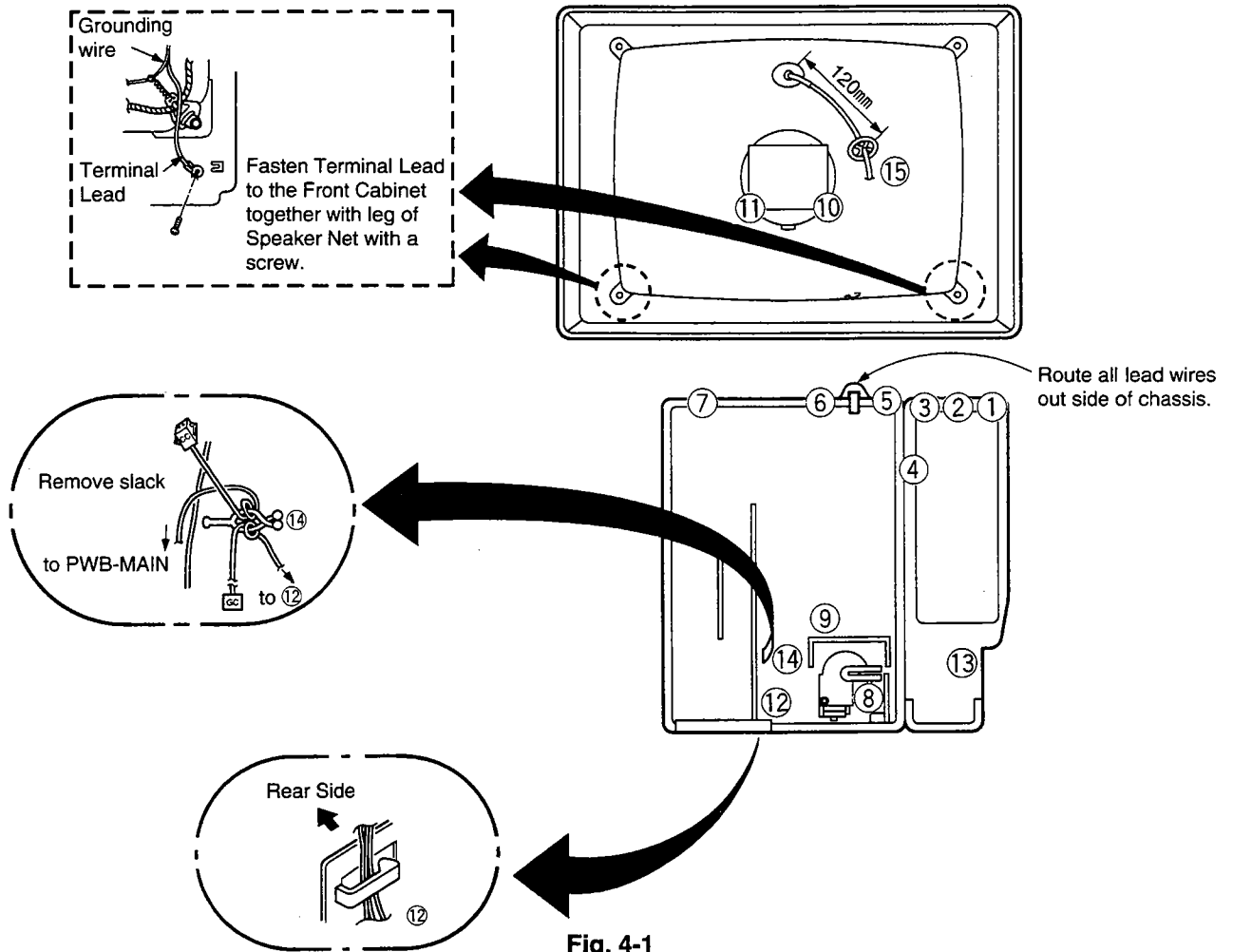

Fig. 4-1

LEAD WIRE	CLAMP
ANODE LEAD WIRE	15
DY-LEAD WIRE	9
FOCUS LEAD WIRE	8
SCREEN LEAD WIRE	8
SP391	7-6-5-3-2-1
SP392	6
CC	14(1 LOOP)
DP	13
GA	12-14(1 LOOP)-11

LEAD WIRE	CLAMP
GC	12-14-11
GD	12-14-11
GP	12-10
KB	4
MY	10
PC	1
SK	10
SP	7

Table 1-1

The lead wires to be clamped are listed in the table below.

**NOTE :** The inner wires are clamped so that they do not come close to heat generating or high voltage parts. After servicing route all wires in their original position.

- \* The anode lead wire is routed so that no tensile strength is applied to the cap. If the route of the anode lead wire is changed, return it to the initial route shown below.
- \* Reverse printed characters indicates aerial clamp.
- \* Fix the lead wires to the clamps 27 and 28 with silicone gum.

[for CS-35303]

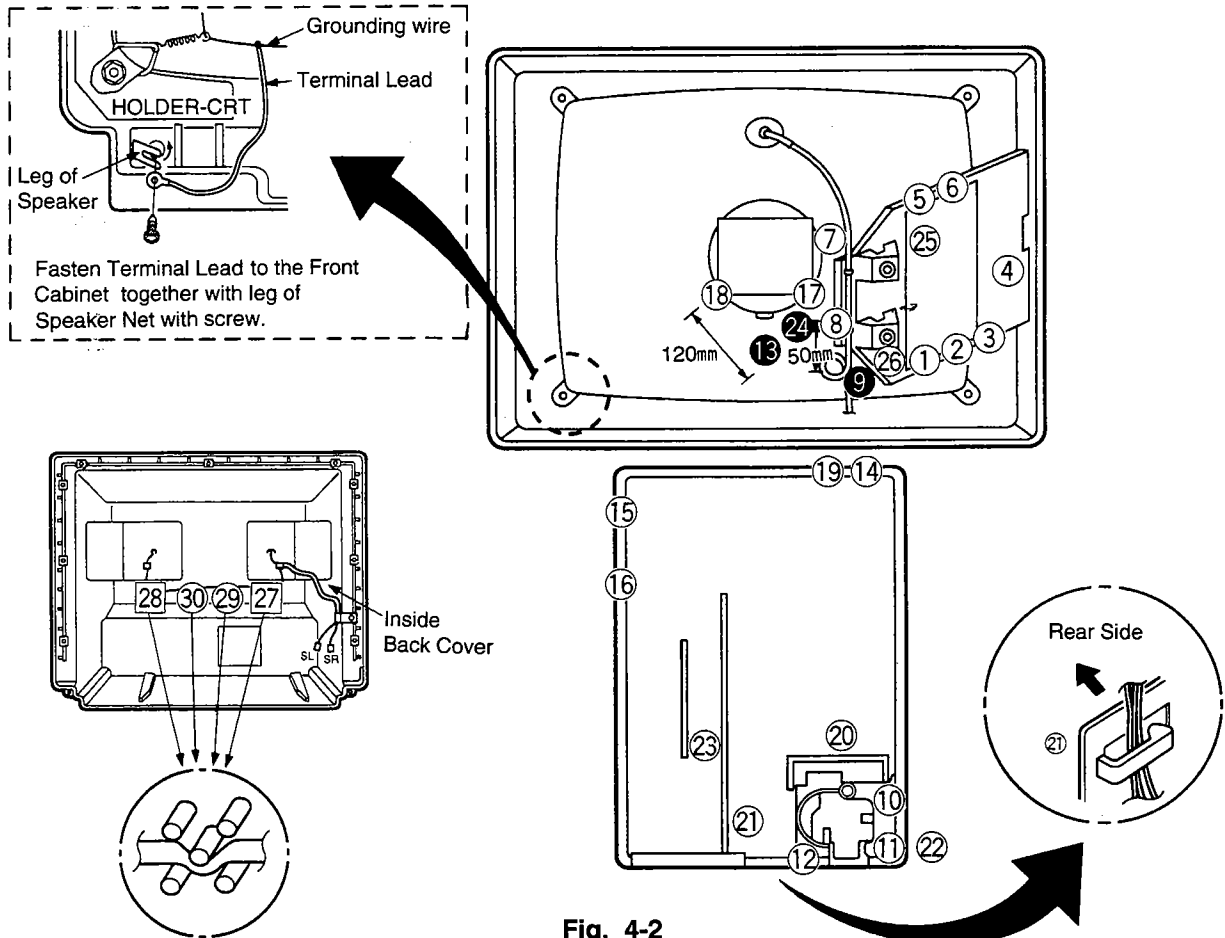

Fig. 4-2

LEAD WIRE	CLAMP
ANODE LEAD WIRE	9(1 LOOP)8-7
DG-COIL	24
DY-LEAD WIRE	24
FOCUS LEAD WIRE	12-13-17
SCREEN LEAD WIRE	12-13-17
SP391	15-19-14
SP392	15-16
CC	23(2 LOOP)
DC	5-6-25
DF	11-10-26
DP	3-2
DV	20-10-26
DY	20(2 LOOP)
GA	21-12-13-18
GC	4-3-2-1-10-11-12-13-18

LEAD WIRE	CLAMP
GD	21-12-13-18
GG	11-12-13-17
GP	21-12-13-17
HP	26-10-11-12-13-17
KA	14-1-2-3-4
KC	15-16
KD	21-12-11-10-1-2-3-4
KE	16-15-19-14-1-2-3-4
KG	20-10-26
MY	17
SK	17
SL	14-19-15-27-29-30-28
SP	15
SR	15

Table 1-2

The lead wires to be clamped are listed in the table below.

**NOTE :** The inner wires are clamped so that they do not come close to heat generating or high voltage parts. After servicing route all wires in their original position.

- \* The anode lead wire is routed so that no tensile strength is applied to the cap. If the route of the anode lead wire is changed, return it to the initial route shown below.
- \* Reverse printed characters indicates aerial clamp.

[for CK-35304]

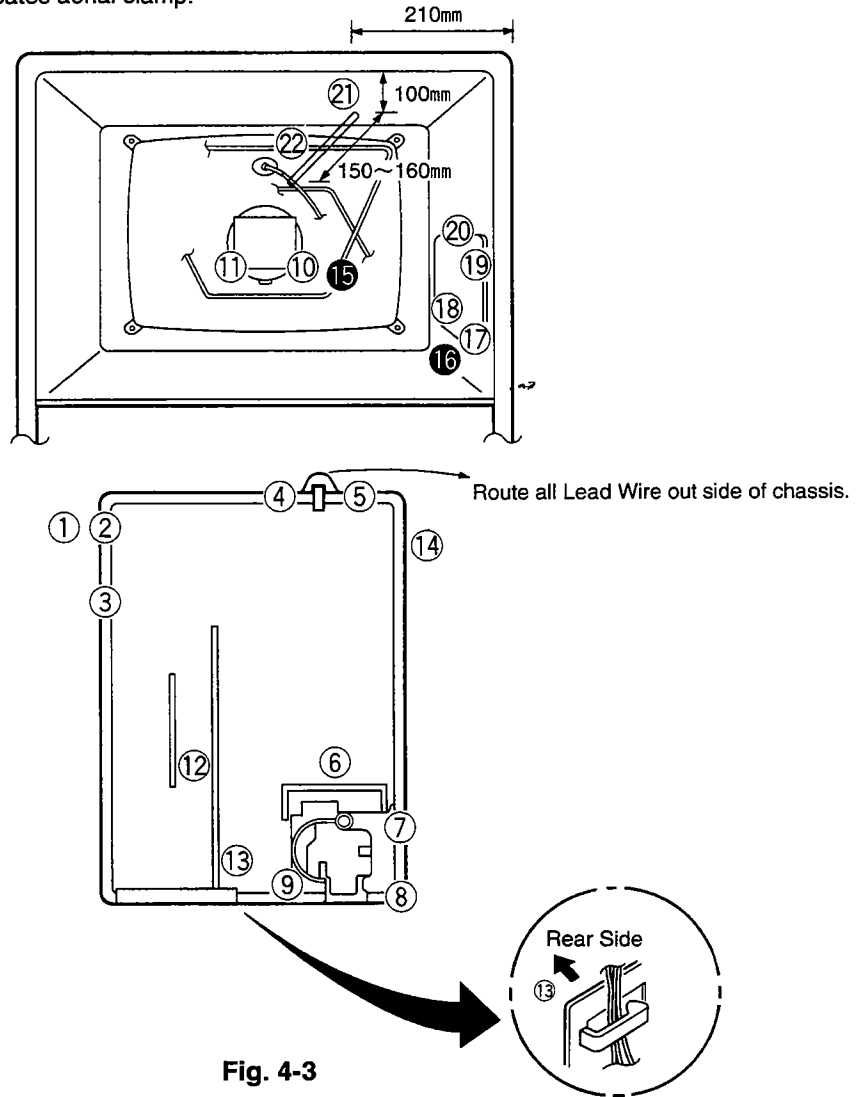

Fig. 4-3

LEAD WIRE	CLAMP	LEAD WIRE	CLAMP
ANODE LEAD WIRE	⑳	GC	⑲-⑰-⑯-⑧-⑨-⑪
DG-COIL	㉑	GD	⑬-⑪
SCREEN LEAD WIRE	⑧-⑨-⑩	GP	⑬-⑨-⑩
SP391	②-④-⑤	HP	⑱-⑭-⑦-⑧-⑨-⑩
SP392	②-①(1 LOOP)	KA	⑲-⑰-⑯-⑭-⑤
CC	⑫(1 LOOP)	KC	①
DC	㉒-⑤	KD	⑬-⑨-⑧-⑯-⑰
DF	⑦-⑧	KE	③-②-④-⑤-⑭-⑯-⑰
DV	⑥-⑤-⑭-⑱	KG	⑤-⑭-⑱
DY	⑥(1 LOOP)	LA	②-①(1 LOOP)
F1	⑧-⑨-⑩	MY	⑩
F2	⑧-⑨-⑩	SK	⑩
GA	⑬-⑪		

Table 1-3



# CRT REPLACEMENT

## GENERAL

In some instances, after CRT replacement, Purity and Convergence may require adjustment. If it is required, follow the procedure described in the alignment section of this manual.

**CAUTION :** Safety goggles must be worn at all times when handling the CRT.

**CAUTION :** The CRT is extremely sensitive to mechanical shock, therefore care must be taken at all times when handling the CRT.

## SUGGESTED TOOLS

The following tool is useful for replacement and final adjustment of the CRT, and are available through the National Parts Department.

1. T-TYPE BOX DRIVER # 859C358020 (Fig. 5)

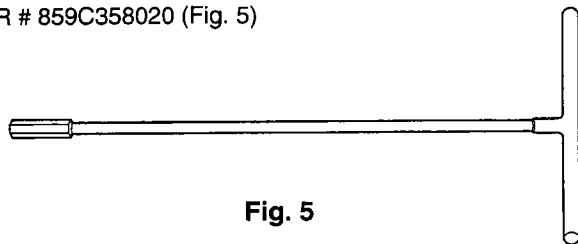

Fig. 5

## CRT REPLACEMENT PROCEDURE [for CS-31203, CS-31203C, CS-31303, CS-31303C, CS-35303]

1. Remove the back cover as described under Removal of Back.
2. Carefully discharge the CRT to the ground on PCB-VMCRT.
3. Disconnect the anode connector from the CRT.
4. Remove the PCB-VMCRT and chassis Assembly (PCB-MAIN, PCB-AV, PCB-CONT-2, PCB-POWER-SUB and PCB-PIP) as described in the Removal of PCB's for CS-31203, CS-31203C, CS-31303, CS-31303C.
5. Remove the PCB-VMCRT, Power Frame and chassis Assembly (PCB-MAIN, PCB-AV, PCB-CONT-3 and PCB-PIP) as described in the Removal of PCB's. [for CS-35303]
6. Remove the screw retaining the terminal lead to the front cabinet as described in the LEAD DRESS.
7. Remove the degaussing coil. [for CS-35303 only].
8. Place a thick cushion or slab of foam rubber on the BASE and carefully lie the TV set on its face, taking care not to strike or scratch the face of the CRT. (Fig.6-1)
9. Remove 4 CRT mounting Hex nuts and washers. (Fig. 6-1)
10. Remove the CRT from the cabinet carefully. (Fig. 6-2, Fig. 6-3)
11. Remove the degaussing coil. [for CS-31203, CS-31203C, CS-31303, CS-31303C].
12. Remove the grounding wire.
13. To install the new CRT, reverse the above procedure.

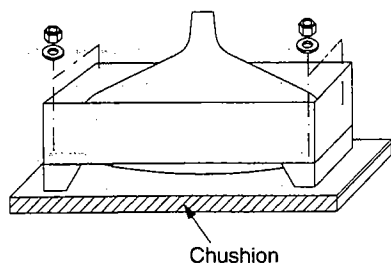

Fig. 6-1

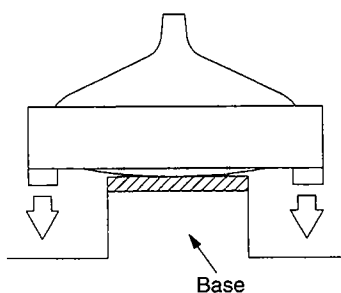

Fig. 6-2

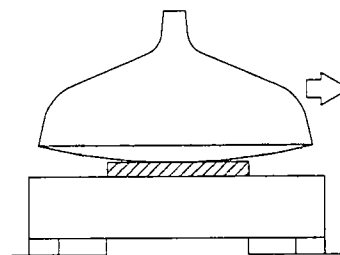

Fig. 6-3

### CRT REPLACEMENT PROCEDURE [for CK-35304]

1. Remove the back cover as described under Removal of Back cover.
2. Carefully discharge the CRT to the ground on PCB-VMCRT.
3. Disconnect the anode connector from the CRT.
4. Remove the PCB-VMCRT, PCB-POWER and chassis assembly (PCB-MAIN, PCB-PIP, PCB-AV) as described in the Removal of PCB'S.
5. Remove the degaussing coil.
6. Place a thick cushion or slab of foam rubber on the BASE and carefully lie the TV set on its face, taking care not to strike or scratch the face of the CRT. (Fig. 7-1)
7. Remove 4 CRT mounting Hexnuts and washers (Fig. 7-1)
8. Remove the CRT from the cabinet carefully. (Fig. 7-2, Fig. 7-3)
9. Remove the grounding wire.
10. To install the new CRT, reverse the above procedure.

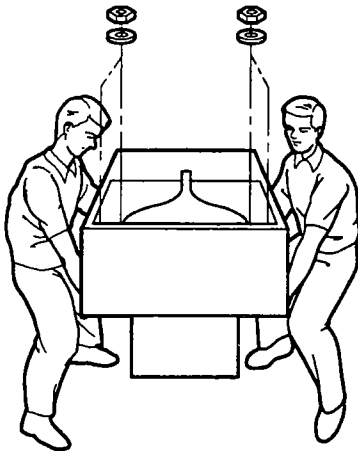

Fig. 7-1

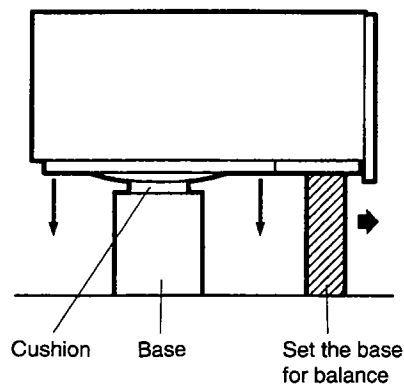

Fig. 7-2

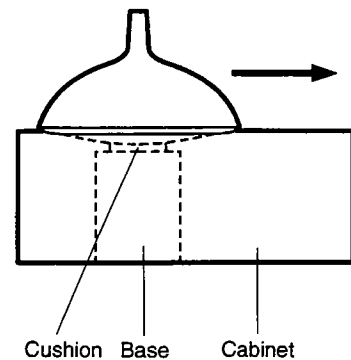

Fig. 7-3

# ITC ADJUSTMENT

Perform ITC ADJUSTMENT only for the model CK-35304.

Before adjusting the INTEGRATED TUBE COMPONENT, run the CRT for more than an hour with a monochrome signal applied, to provide normal beam current.

- ITC adjustments should be performed in the following sequence after replacing either the CRT, deflection yoke or purity and convergence magnetic assembly.

When not replacing parts, perform only the necessary adjustments.

- Installation

- Install the deflection yoke on the neck of the CRT, fully forward against cone.
- Place the purity and convergence assembly on the neck of the CRT so that the distance between the 6-pole magnet and the base of the tube is as indicated in Table. 1, then tighten the screw by hand.

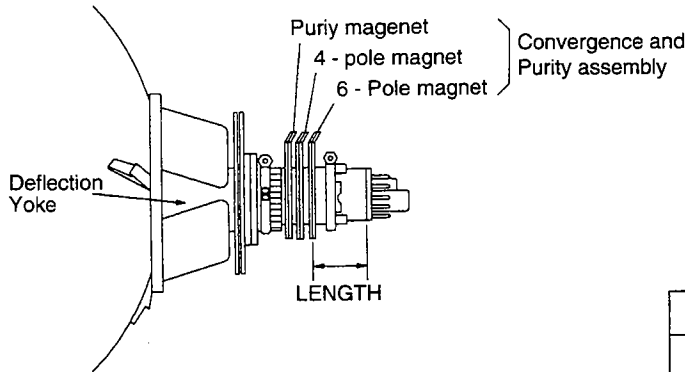

MODEL	LENGTH
CK-35304	1.93±0.08 inches

Table. 1

## Preliminary Adjustment

- Degauss the front and rear of the CRT, CRT holder, and the front and sides of the cabinet. Don't allow the degaussing coil near to the deflection yoke, purity and convergence magnetic assembly. (Insufficient degaussing can prevent suitable color purity adjustment.)
- Run the CRT for more than an hour with a white raster signal, to provide normal beam current.
- Make sure that all electrical adjustments have been performed.
- Align the 4-pole, 6-pole and purity magnets to minimum magnetic strength (tabs together).

1. Purity	<b>Adjustment purpose</b>	Insure the R, G and B beam hit the correct fluorescent materials.
	<b>Symptom when incorrectly adjusted</b>	Incorrect color in areas of the picture.

<b>Input signal</b>	VIDEO signal (yellow raster)
<b>Input terminal</b>	VIDEO IN terminal

- Supply a VIDEO signal (yellow raster).
- With the deflection yoke positioned fully forward, adjust the purity magnet so that the yellow bar is at the center of the screen with normal vertical centering.
- Slide the deflection yoke slowly backwards to produce a uniform yellow raster.
- Tighten the deflection yoke in the position.
- Switch the input signal from red to green to blue. Confirm no discoloration appears in each of the colors. If discoloration is present, re-adjust steps 1 through 4.

2. Static Convergence	<b>Adjustment purpose</b>	To correct any misconvergence in the center of the picture.
	<b>Symptom when incorrectly adjusted</b>	Color edging of objects in the main picture area.

<b>Input signal</b>	VIDEO signal (crosshatch)
<b>Input terminal</b>	VIDEO IN terminal

1. Supply a VIDEO signal (crosshatch).
2. Set the BRIGHTNESS and CONTRAST controls to center position.
3. Adjust the angle between the tabs of the 4-pole magnet and the angular position to converge the "B" and "R" beams on the screen.
4. Adjust the angle between the tabs of the 6-pole magnet and the angular position to converge the "B" and "R" beams on the "G" beam at the center of the screen.
5. Make sure that purity in each color "R", "G" and "B" is maintained. If necessary, repeat item 1 (Purity) to item 2 (Static Convergence).

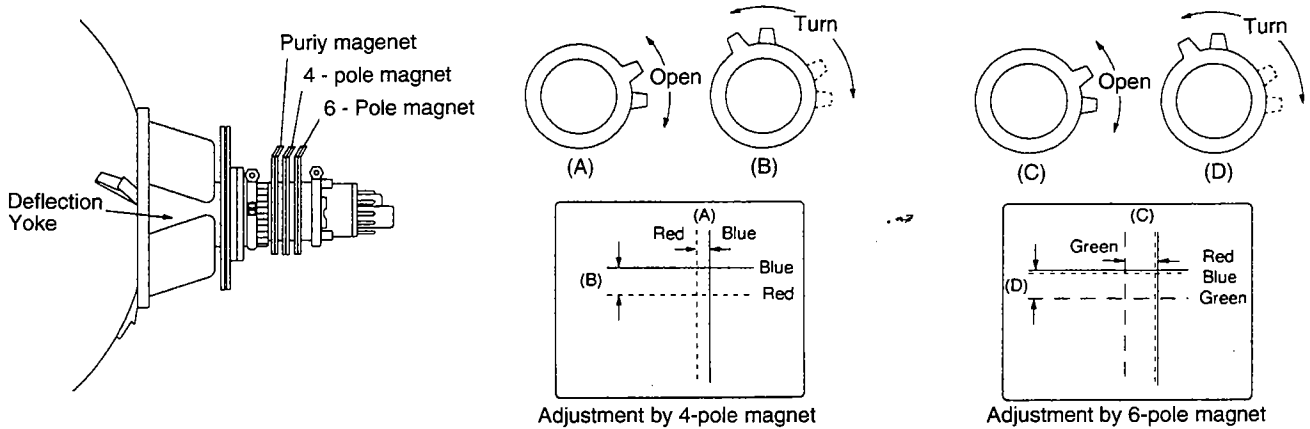

**Note:** With both 4-pole and 6-pole magnets, converge the vertical line with the angle between tabs and the horizontal line with angular rotation of both tabs together.

3. Screen corner landing compensation	<b>Adjustment purpose</b>	To correct divergence in the corners of the screen.
	<b>Symptom when incorrectly adjusted</b>	Color edging appears at the corners of a screen.

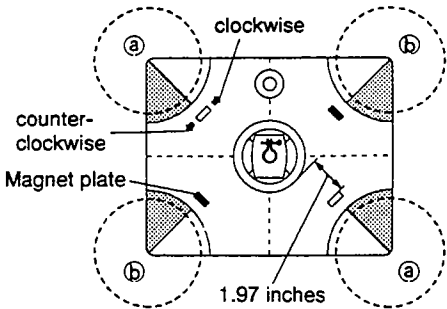

<b>Input signal</b>	VIDEO signal (red raster)
<b>Input terminal</b>	VIDEO IN terminal

- \* The adjustments described below are for correcting inward color beam divergence at the corners of the screen. Reverse placement of the magnet for correcting outward divergence.
1. Degauss the unit with its own degauss system. Do not use any degaussing coil other than the built-in degaussing.
  2. Supply a VIDEO signal (red raster).
  3. Make sure that only red appears at the corners of the screen. If other color appears, attach a magnet (Up to 3 pieces at a position) on the funnel of the CRT so that the undesirable color disappears (Part No. of magnet: 461D033020).



- A). When an undesirable color appears in the area (a), shown in the figure, set the face of magnet plate to white marker side and attach the magnet plate on the funnel of the CRT.
- B). When an undesirable color appears in the area (b), shown in the figure, set the magnet plate to the opposite side of white marker, and attach the magnet plate on the funnel of the CRT.

**Note:** The magnet plate will distort raster and disturb the convergence system. Do not place a magnet plate closer than 1.97 inches to the bobbin of the deflection yoke.

4. If an undesirable color appears in the area indicated by , move the magnet plate counter-clockwise until the color disappears. If an undesirable color appears in the area indicated by , move the magnet plate clockwise until the color disappears.

To be continued the next page.

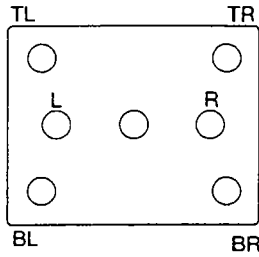

Check point for beam landing

Check Point	Best landing	Outward divergence	Inward divergence
R.TR.BR			
L.TL.BL			

5. After correction, degauss the set and then check corners of the screen. If discoloration exists, fine adjust the magnet for that corner.

4. Yh correct	<b>Adjustment purpose</b> To correct the color divergence of R, G and B vertical lines at the top and bottom of the picture. <b>Symptom when incorrectly adjusted</b> Color edging of vertical lines at the top and bottom of the picture.
---------------	---

<b>Input signal</b>	VIDEO signal (crosshatch)
<b>Input terminal</b>	VIDEO IN terminal

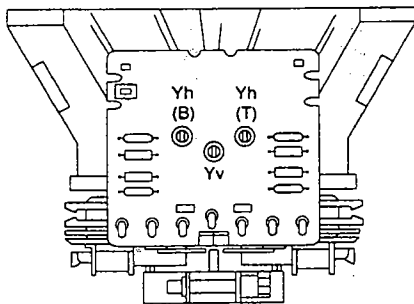

- \* Before adjusting, be sure to tighten the deflection yoke in position.
- 1. Supply a VIDEO signal (crosshatch).
- 2. When color beams do not converge along the Y axis as shown in the figure below, turn adjustment Yh (T), on the top of the deflection yoke counter-clockwise, and turn Yh (B) clockwise until the beams converge at the top and bottom.
- \* Note that the potentiometer Yh (T) affects the beams at top of the screen while the Yh (B) at the bottom.  
[Displacement amount: +1.8mm to -1.2mm]
- \* Reverse counter-clockwise and clockwise when the beam divergence is opposite to the example as shown below.

	Direction of divergence	Adjusting potentiometers, Yh (T) and Yh (B)
Yh		

To be continued the next page.

- \* At their full travel, the Yh potentiometers can move the beams approx. 4.0mm.  
Do not turn them more than 1.5 graduation.

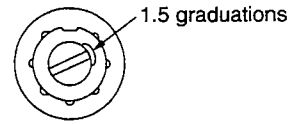

5. Yv correct

**Adjustment purpose**

To correct color divergence of R, G and B horizontal lines at the top and bottom of the picture.

**Symptom when incorrectly adjusted**

Color edging around horizontal line at the top and bottom of the picture.

<b>Input signal</b>	VIDEO signal (crosshatch)
<b>Input terminal</b>	VIDEO IN terminal

- \* Before adjusting, be sure to tighten the deflection yoke in position.
- 1. Supply a VIDEO signal (crosshatch).
- 2. When horizontal lines do not converge at the top and bottom of the screen, turn the adjusting potentiometer, Yv, on the top of the deflection yoke, clockwise.  
[Displacement amount:  $\pm 1.0\text{mm}$ ]  
Reverse clockwise as counter-clockwise when the beam divergence is opposite to the example as shown below.

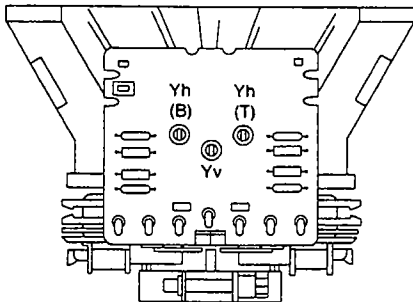

	Direction of divergence	Adjusting potentiometers
Yv	<p>A diagram showing a rectangular screen with horizontal lines. The lines are closer together at the top and bottom, indicating divergence. Labels R, B, B, R are on the right side.</p>	<p>A diagram of the Yv potentiometer with arrows indicating clockwise and counter-clockwise rotation. Text labels: "Red beam moves inward" and "Red beam moves outward".</p>

6. Xv correct      **Adjustment purpose**      To correct color divergence of R, G and B horizontal lines at the sides of the picture.  
**Symptom when incorrectly adjusted**      Color edging around horizontal lines at the sides of the picture.

<b>Input signal</b>	VIDEO signal (crosshatch)
<b>Input terminal</b>	VIDEO IN terminal

- \* Before adjusting, be sure to tighten the deflection yoke in position.
- 1. Supply a VIDEO signal (crosshatch).
- 2. When horizontal lines do not converge at left and right sides of the screen, adjust vertical cross (Xv) with the horizontal differential coil as shown below.

Type of Misconvergence	Core position
	<p>Counter-clockwise</p>
	<p>clockwise</p>

7. Xh correct      **Adjustment purpose**      To correct color divergence of R, G and B vertical lines at the sides of the picture.  
**Symptom when incorrectly adjusted**      Color edging at the sides of the picture.

<b>Input signal</b>	VIDEO signal (crosshatch)
<b>Input terminal</b>	VIDEO IN terminal

- \* Before adjusting, be sure to tighten the deflection yoke in position.
- 1. Supply a VIDEO signal (crosshatch).
- 2. When beam lines do not converge at left and right sides of the screen, adjust horizontal cross (Xh) with a magnet plate as shown below (Part No. of magnet: 412D064O10 ).

Type of Misconvergence	Stick a magnet to the position illustrated below
	<p>Magnet</p>
	<p>Magnet</p>

8. Convergence at screen corners	<b>Adjustment purpose</b>	To correct convergence at the corners of the picture.
	<b>Symptom when incorrectly adjusted</b>	Color edging in the corners.

<b>Input signal</b>	VIDEO signal (crosshatch)
<b>Input terminal</b>	VIDEO IN terminal

1. Supply a VIDEO signal (crosshatch).
2. If convergence is poor at corners, place a magnet at the aperture of the deflection yoke bobbin.  
The magnet mounting position corresponds with each respective corner as shown below (Part No. 461D017010).
3. Position the magnet with adhesive so the PQH and PQV components are minimized.

Magnet mounting position for section B

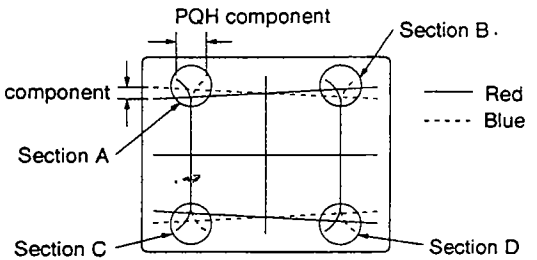
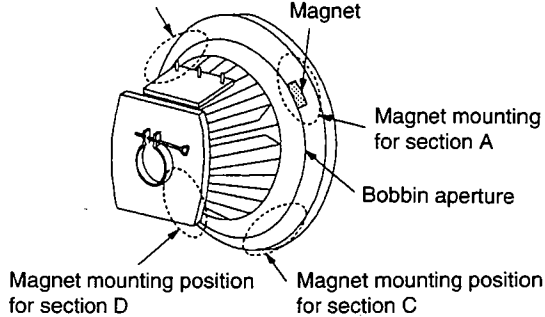

Pattern seen from face side of CRT

9. Wedge position	<b>Adjustment purpose</b>	Secure deflection yoke to the funnel of the CRT.
	<b>Symptom when incorrectly adjusted</b>	Convergence may vary.

<b>Input signal</b>	—
<b>Input terminal</b>	—

1. Insert 3 wedges so there is no yoke movement, as shown below.
2. After positioning the wedges, gently turn up the end of the wedge and strip the tape from the rear to expose the adhesive material, then adhere to the funnel of the CRT.
3. Apply silicone gum (Part No. 859D106O20) between wedges and the funnel of the CRT.

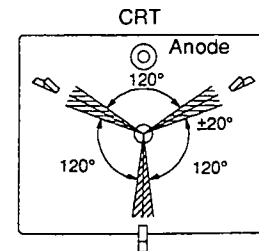
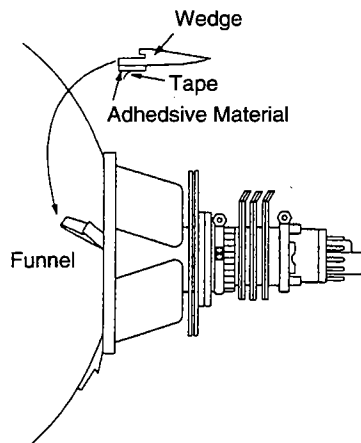

**Note:** Do not use a wedge that has already been used.



# ELECTRICAL ADJUSTMENTS

Perform only the adjustments required.

If proper equipment is not available, do not attempt an alignment.

## ■ Measuring equipment and Jigs

- Oscilloscope (Unless otherwise specified, use 10:1 probes)
- Signal generator
- Frequency counter
- Multiplex audio signal generator
- Direct current milliammeter
- Electrical tools
- Cable extension kit (Part No. 859C431O20)

## ■ TEST signal

### 1) Monoscope signal

When you have no monoscope signal source for adjustment, connect the unit to a VCR and play an alignment tape (Monoscope).

### 2) Color bar signal

In this manual, unless otherwise specified, use the color bar signal specified, below.

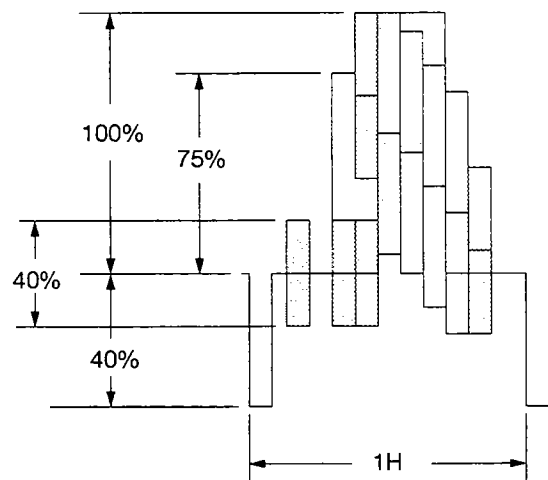

NTSC  
Split-Field Color Bars (with 100% window)

# Location of Test Points and Adjustments

## PCB-MAIN (COMPONENT SIDE)

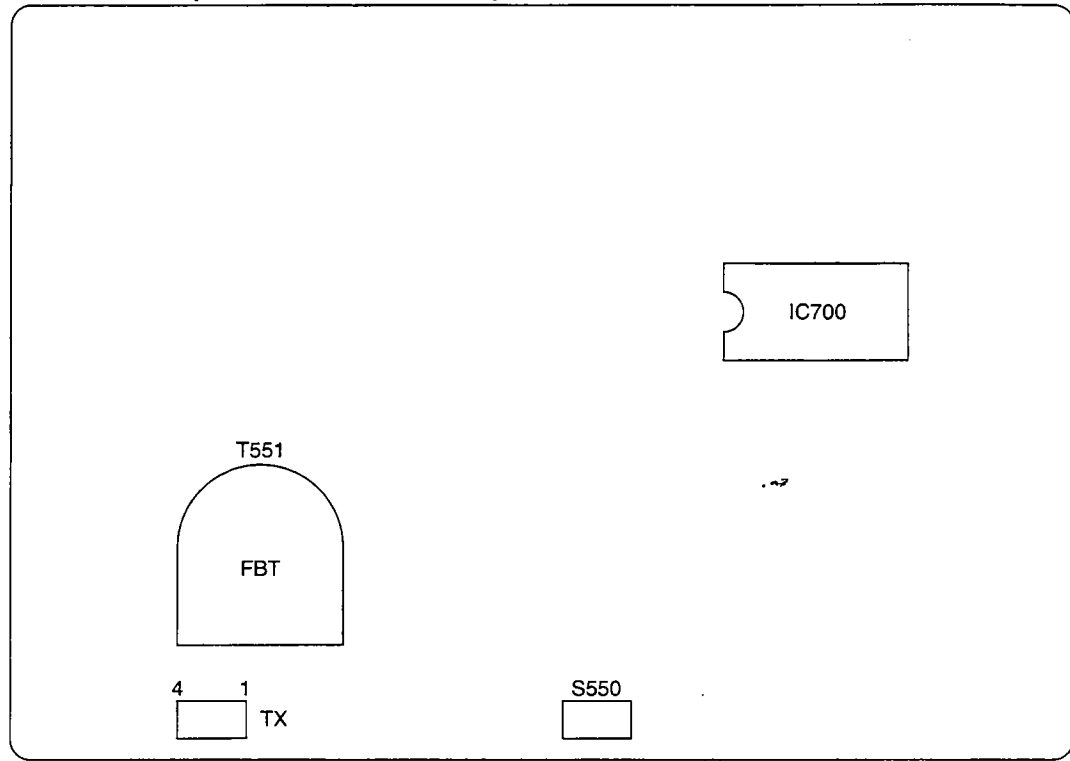

FRONT

## PCB-VMCRT (COMPONENT SIDE)

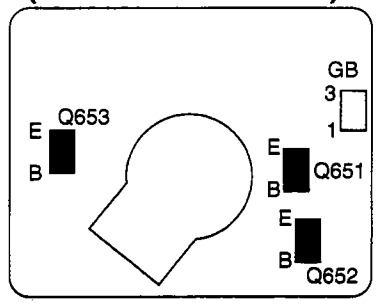

## PCB-PIP (COMPONENT SIDE)

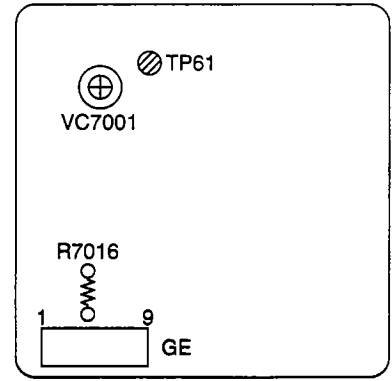

## PCB-AV (COMPONENT SIDE)

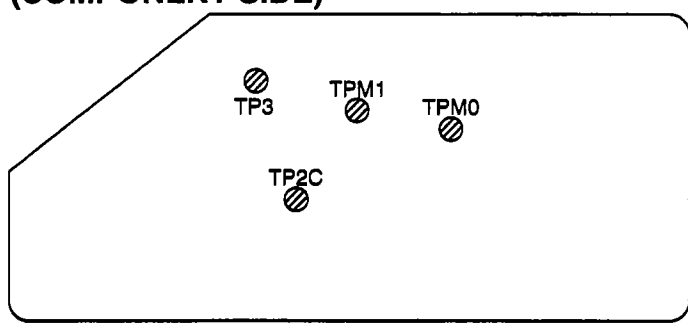

# Initial Set up

Follow the steps below for the initial set up.

1. Set the receiver to "TV mode".
2. Press the "MENU" button on a remote hand unit one time to select the "MENU" display.
3. Press the buttons "2", "3", "5", and "8" successively to select the "OPTION MENU" display.
4. Press the "ADJUST" button to select "Initial".
5. Press the "ENTER" button.

**Note :** At this time, channel 3 is selected.

6. Perform steps 2 and 3 above to display "OPTION MENU" screen.
7. Use the "ADJUST" button and "ENTER" button to set "OPTION MENU" as shown in the table below.
8. Press the "MENU" button twice to return to normal viewing.

## OPTION MENU

Initial	System 1A : On
E <sup>2</sup> RESET	CCD : On
Hotel : Off	Auto clock: On
	Call letr : On
PIP : <u>On</u>	Net name : On
	Prog name : On
Montr. fix : On	Prog descr : On
Auto turn : Off	
Antenna : 2	
Input : 2	

※ Set this condition to "OFF" for models CS-31203 and CS-31203C.

**CAUTION :** DO NOT select "E<sup>2</sup>RESET" and press "ENTER" button.

If pressed, all the data of E<sup>2</sup>PROM is changed to the initial data value, then readjustment of all the data relating to the E<sup>2</sup>PROM must be performed.

## Initial Setting Condition

Initial Setting Item	Initial Setting Condition	Initial Setting Item	Initial Setting Condition
INPUT	TV	PIP SOURCE	TV
RECEIVE CHANNEL	003 CH	PIP POSITION	—
TV/CATV	CATV	VIDEO MUTE	OFF
Q. V.	003 CH	RENAME THE INPUTS	ALL LABEL CLEAR
CHANNEL MEMORY	ALL CH (0.0)	POWER RESTORE	OFF
Lock the TV	OFF	AUTO CLOCK	OFF
LOCK CODE	FFFF <sub>H</sub>	A / V NETWORK	OFF
VOLUME	21 <sub>H</sub> Step / 64	SELECT LANGUAGE	English
AUDIO FUNCTIONS		ADVANCED PIP	TV Still
TV Listen to	STEREO	OPTION MENU	
TV Bass	50%	Initial	—
TV Treble	50%	E <sup>2</sup> reset	—
TV Balance	50%	Hotel	OFF
TV Surround	OFF	PIP	ON
TV Speaker	ON	Montr. fix	OFF
VIDEO FUNCTIONS		Auto turn	OFF
TV Tint	50%	Antenna	1
TV color	50%	Input	1
TV Contrast	50%	System 1A	OFF
TV Brightness	50%	CCD	ON
TV Sharpness	50%	Auto clock	ON
TV Color temp	High	Call letr	ON
TV CC	When muting	Net name	ON
		Prog name	ON
		Prog descr	ON

# Circuit Adjustment Mode

On this model, the following adjustment items may only be performed using the remote hand unit.

item 1 (SAP VCO) ~ item 18 (Sub cont), item 21 (Character position), item 23 (PIP chroma gain), item 24 (PIP Sub TINT)

To perform these adjustments, use the following procedure to activate the circuit adjustment mode.

## 1. Activating the circuit adjustment mode

1. Press the "MENU" button on a remote hand unit. (The "MENU" display will appear.)
2. Press the buttons "2", "3", "5", and "7" in that order. (The screen will change to the circuit adjustment mode.)  
If not changed to the circuit adjustment mode, repeat the steps 1 and 2 again.

## 2. Selection of adjustment functions and adjustment items

To select an adjustment item in the circuit adjustment mode, select first the adjustment function, that includes the specific adjustment item to be selected, and next select the adjustment item.

Refer to the following pages for the listing of adjustment functions and adjustment items.

1. Press the "AUDIO" button on a remote hand unit to select an adjustment function. Each time the button is pressed, the adjustment function changes in the following sequence.

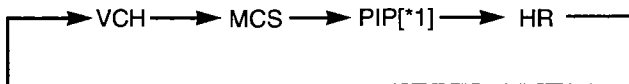

\*1 : "PIP" is not displayed for CS-31203 and CS-31203C.

2. Press the "VIDEO" button to select a specific adjustment item. The adjustment item number increases, each time the "VIDEO" button is pressed.

## 3. Changing data

After selecting an adjustment item, use the "ADJUST UP/DOWN" button to change adjustment data.

- If "ADJUST DOWN" button is pressed, the adjustment data decreases.
- If "ADJUST UP" button is pressed, the adjustment data increases.

## 4. Saving of adjustment data

Press the "ENTER" button to save the adjustment data in memory. The display of characters goes red for approx. two seconds in this step.

**Note :** If the circuit adjustment mode is terminated without pressing the "ENTER" button, changes in adjustment data are not saved.

## 5. Terminating the circuit adjustment mode

Press the "MENU" button on the remote hand unit twice to terminate the circuit adjustment mode.

**Note :** The circuit adjustment mode can be also terminated by turning the power OFF.

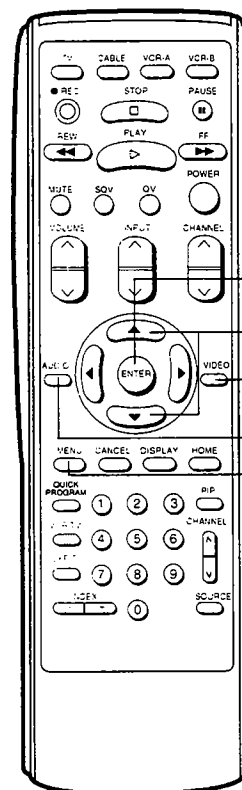
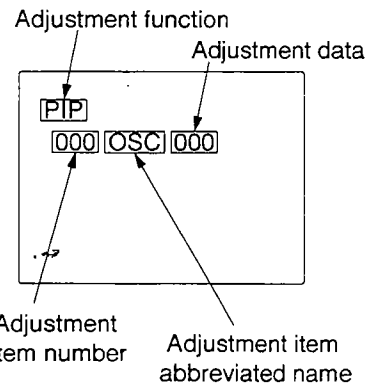

- ENTER button
- ADJUST UP/DOWN button
- VIDEO button
- AUDIO button
- MENU button

**Note :** Remote hand units for CS-31203 and CS-31203C do not have the following buttons.

- ADJUST RIGHT / LEFT button
- PIP CHANNEL button
- PIP SOURCE button
- INDEX button

## List of Adjustment Functions and Adjustment Items

**Note** : The values with the description of "Fixed Value" in the NOTE column should not be changed.

**Note** : The "initial data" is the initial value of that adjustment. The initial data may not be correct for the normal performance of your specific TV set.

**Note** : The E<sup>2</sup>PROM stores the adjustment data, when replaced the micro computer will automatically write the initial data values in the new E<sup>2</sup>PROM. Initial data with an ★mark will differ from that given in the table.

After replacing E<sup>2</sup>PROM, or when selecting E<sup>2</sup>RESET in OPTION MENU, readjust the data with ★marks to the value listed below.

**Note** : When ICs for specific adjustment functions are replaced, the micro computers automatically writes the data value is stored in the E<sup>2</sup>PROM.

Function Display		VCH	IC201		
Adjustment Item Number	Adjustment Abbreviated Name	Adjustment Name	Adjustment Range	Initial Data	Note
0	COL	Color Control	0~127	80	
1	TNT	TINT Control	0~127	50	
2	BRT	Brightness Control	0~255	135	
3	CNT	Contrast Control	0~127	70	
4	SHP	Sharpness Control	0~127	21	
5	CTR	R-CUT OFF	0~255	255	
6	CTG	G-CUT OFF	0~255	255	
7	CTB	B-CUT OFF	0~255	255	
8	DHR	R-Drive	0~127	63	
9	DHB	B-Drive	0~127	63	
10	VHT	Vertical Height	0~127	63	
11	PAM	E-W Parabora(PCC-Amp)	0~63	32	
12	HWD	Horizontal Width	0~63	32	
13	YDL	Y-Delay Line Selection	0~1	0	Fixed value
14	DL2	Aperture Control Delay Volume Selection	0~1	1	Fixed value
15	DCT	DC Transmission Volume Selection	0~1	1	Fixed value
17	AFC	AFC1 Gain Selection	0~3	★ 3	Fixed value
19	SVS	Service Switch	0~1	1	Fixed value
26	CRS	R-Cut Off Switch	0~3	1	Fixed value
28	DRR	R-Drive Switch	0~1	1	Fixed value
29	DRB	B-Drive Switch	0~1	1	Fixed value
30	CBS	B-Cut Off Switch	0~3	1	Fixed value
33	DL1	Preshoot/Overshoot	0~7	★ 0	Fixed value
34	PED	Black Expansion Gain	0~15	7	Fixed value
35	GMA	White $\gamma$ Level	0~15	★15	Fixed value
36	GMG	White $\gamma$ Gain	0~15	★15	Fixed value
37	BES	Black Expansion Slice Position	0~7	4	Fixed value
38	R-Y	Demodulation Axis R-Y	0~31	★16	Fixed value
39	B-Y	Demodulation Axis B-Y	0~63	★18	Fixed value
40	G-Y	G-Y Ratio Selection	0~3	1	Fixed value
41	WHC	White Character Correction	0~15	8	Fixed value
42	WHV	White Character Slice Position	0~15	8	Fixed value

Function Display		VCH				IC201
Adjustment Item Number	Adjustment Abbreviated Name	Adjustment Name	Adjustment Range	Initial Data	Note	
43	HPH	H-Center Position	0~31	16		
44	VSC	Vertical S	0~63	32		
45	VLR	Vertical Lineality	0~63	32		
46	VSF	Vertical Position	0~2	1		
47	PPH	PCC Phase	0~63	32		
48	PC1	PCC Corner 1	0~7	4		
49	PC2	PCC Corner 2	0~7	4		
50	VCM	Vertical EHT	0~15	8		
51	HCM	Horizontal EHT	0~15	7		

Function Display		MCS				IC3A0
Adjustment Item Number	Adjustment Abbreviated Name	Adjustment Name	Adjustment Range	Initial Data	Note	
0	PVC	SAP VCO	0~63	32		
1	TVC	Stereo VCO	0~63	32		
2	INP	Input Level	0~63	32		
3	FIL	Filter	0~63	63		
4	LSP	Low Sound Separation	0~63	32		
5	HSP	High Sound Separation	0~63	32		

Function Display		PIP				IC7002
Adjustment Item Number	Adjustment Abbreviated Name	Adjustment Name	Adjustment Range	Initial Data	Note	
0	TINT	Tint	0~63	32		
1	COLR	Color Saturation	0~63	32		
2	DECD	Color Reset	0~1	0	Fixed value	
3	SYNC	Sub Picture Sync Separation Threshold	0~7	★ 1	Fixed value	
4	RVS	RVS	0~1	0	Fixed value	
5	BG-Y	Back Ground Luminance Level	0~15	★10	Fixed value	
6	BSTB	Burst with Background displayed	0~63	★10	Fixed value	
7	MVW	Sub Picture Macro Vision	0~3	0	Fixed value	
8	CRTN	Sub Picture Tint Offset	0~3	1	Fixed value	
9	VXA	Sub Picture Vertical Position	91~255	110	Fixed value	
10	HXAO	Sub Picture Horizontal Position	17~139	126	Fixed value	
11	ADJ9	Delay Volume between Sub Picture and Frame (1/9)	0~15	7	Fixed value	
12	YDL9	Sub Picture Y Delay Volume (1/9)	8~29	★14	Fixed value	
13	HPX9	Writing System Horizontal Position (1/9)	0~255	54	Fixed value	
14	VYA9	Sub Picture Height (1/9)	0~255	188	Fixed value	
15	HYA9	Sub Picture Width (1/9)	6~255	60	Fixed value	
16	ADJ6	Delay Volume between Sub Picture and Frame (1/16)	0~15	7	Fixed value	
17	YDL6	Sub Picture Y Delay Volume (1/16)	8~29	14	Fixed value	
18	HPX6	Writing System Horizontal Position (1/16)	0~255	104	Fixed value	
19	VYA6	Sub Picture Height (1/16)	0~255	206	Fixed value	
20	HYA6	Sub Picture Width (1/16)	6~255	46	Fixed value	
21	VXAM	Sub Picture Vertical Position (Multi)	207~255	229	Fixed value	
22	HXAM	Sub Picture Horizontal Position (Multi)	15~150	32	Fixed value	
23	VXBM	Sub Picture Vertical Position (Multi)	200~239	238	Fixed value	

<b>[Multi Channel Sound circuit]</b> 1. SAP VCO		<b>Adjustment purpose</b> Set the reference frequency for the SAP detection circuit.	
		<b>Symptom when incorrectly adjusted</b>	No reception of SAP broadcasting.
<b>Measuring instrument</b>	Frequency counter	<ol style="list-style-type: none"> <li>1. Supply an RF signal (monoral sound 400Hz 100%MOD).</li> <li>2. Connect TPM0 to ground through an electrolytic capacitor (10uF, 50V or more), as shown below.</li> <li>3. Connect TPM1 to ground through a resistor (1/4W 820KΩ).</li> <li>4. Observe the frequency at TP3.</li> <li>5. Activate the circuit adjustment mode. (refer to page 18)</li> <li>6. Set the adjustment function to "MCS". ("AUDIO" button)</li> <li>7. Set the adjustment items shown in the list below to the initial data value. ("VIDEO" and "ADJUST" buttons)</li> <li>8. Select adjustment item "0 PVC". ("VIDEO" button)</li> <li>9. Set the adjustment data so that the frequency is <math>78.67 \pm 0.40</math> kHz. ("ADJUST" button)</li> <li>10. Write the adjustment data into memory. (Press "ENTER")</li> <li>11. Terminate the circuit adjustment mode. (press "MENU" twice)</li> </ol> <p><b>Note :</b> Adjustment item 2 (Stereo VCO) must be performed immediately after this adjustment.</p>	
<b>Test point</b>	TP3		
<b>EXT trigger</b>	---		
<b>Measurement range</b>	---		
<b>Input signal</b>	RF signal (monoral sound)		
<b>Input terminal</b>	RF IN terminal		

**PCB-AV (COMPONENT SIDE)**

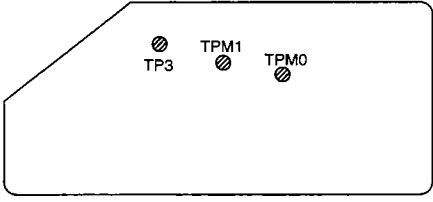

Adjustment item number	Adjustment item	Initial Data
0	PVC	32
1	TVC	32
2	INP	32
3	FIL	63
4	LSP	32
5	HSP	32

<b>[Multi Channel Sound circuit]</b> 2. Stereo VCO		<b>Adjustment purpose</b> Set the reference frequency for the multiplex IC oscillator.	
		<b>Symptom when incorrectly adjusted</b>	No STEREO reception.
<b>Measuring instrument</b>	Frequency counter	<p>* This adjustment must follow item 1 (SAP VCO).</p> <ol style="list-style-type: none"> <li>1. Refer to the steps 1 through 6 in the item 1 (SAP VCO) for the connection and setting of measuring instruments, etc.</li> <li>2. Select adjustment item "1 TVC". ("VIDEO" button)</li> <li>3. Set the adjustment data so the frequency is <math>15.73 \pm 0.08</math> kHz. ("ADJUST" button)</li> <li>4. Write the adjustment data into memory. (Press "ENTER")</li> <li>5. Terminate the circuit adjustment mode. (Press "MENU" twice)</li> <li>6. Remove the resistor from TPM1 and the electrolytic capacitor from TPM0.</li> </ol> <p><b>Note :</b> Adjustment item 3 (Input level) must be performed immediately after this adjustment.</p>	
<b>Test point</b>	TP3		
<b>EXT trigger</b>	---		
<b>Measurement range</b>	---		
<b>Input signal</b>	RF signal (monoral sound)		
<b>Input terminal</b>	RF IN terminal		

**PCB-AV (COMPONENT SIDE)**

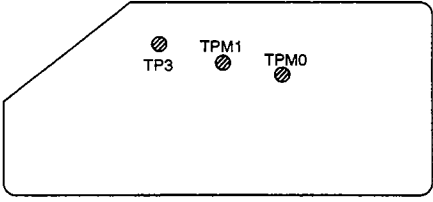

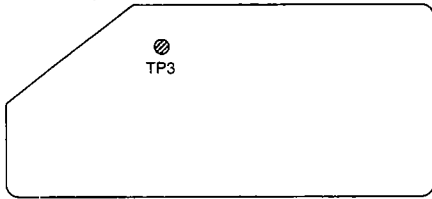

[Multi Channel Sound circuit] 3. Input level		<b>Adjustment purpose</b> Set the level of the input signal for the multi channel sound circuit.	<b>Symptom when incorrectly adjusted</b> Distorted sound during an MCS broadcast.
<b>Measuring instrument</b>	Oscilloscope	<p>* This adjustment must follow item 2(Stereo VCO).</p> <ol style="list-style-type: none"> <li>1. Supply an RF signal (monoral sound 400Hz 100%MOD).</li> <li>2. Observe the waveform at TP3.</li> <li>3. Activate the circuit adjustment mode. (refer to page 18)</li> <li>4. Set the adjustment function to "MCS". ("AUDIO" button)</li> <li>5. Select adjustment item "2 INP". ("VIDEO" button)</li> <li>6. Set the adjustment data so that the amplitude of the waveform is <math>1.41 \pm 0.03</math> Vp-p. ("ADJUST" button)</li> <li>7. Write the adjustment data into memory. (Press "ENTER")</li> <li>8. Terminate the circuit adjustment mode. (Press "MENU" twice)</li> </ol> <p><b>Note</b> : Adjustment item 4 (Filter) must be performed immediately after this adjustment.</p>	
<b>Test point</b>	TP3		
<b>EXT trigger</b>	---		
<b>Measurement range</b>	DIV 50mV TIM 2ms		
<b>Input signal</b>	RF signal (monoral sound)		
<b>Input terminal</b>	RF IN terminal		
<p>PCB-AV (COMPONENT SIDE)</p> 			

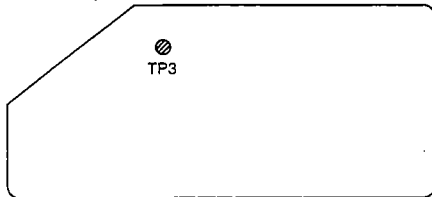
[Multi Channel Sound circuit] 4. Filter		<b>Adjustment purpose</b> Filter for pilot signal.	<b>Symptom when incorrectly adjusted</b> Poor S/N ratio of signal in STEREO and SAP modes.
<b>Measuring instrument</b>	Oscilloscope	<p>* This adjustment must follow item 3(Input level).</p> <ol style="list-style-type: none"> <li>1. Supply an RF signal. (Stereo Pilot signal but sound signal).</li> <li>2. Observe the waveform at TP3.</li> <li>3. Activate the circuit adjustment mode. (refer to page 18)</li> <li>4. Set the adjustment function to "MCS". ("AUDIO" button)</li> <li>5. Select adjustment item "3 FIL". ("VIDEO" button)</li> <li>6. Set the adjustment data for minimum amplitude of the waveform. ("ADJUST" button)</li> </ol> <p>Decrease the data from 63, and set the data to the value where the first minimum amplitude is obtained.</p> <ol style="list-style-type: none"> <li>7. Write the adjustment data into memory. (Press "ENTER")</li> <li>8. Terminate the circuit adjustment mode. (Press "MENU" twice)</li> </ol> <p><b>Note</b> : Adjustment item 5 (separation) must be performed immediately after this adjustment.</p>	
<b>Test point</b>	TP3		
<b>EXT trigger</b>	---		
<b>Measurement range</b>	DIV 10mV TIM 2ms		
<b>Input signal</b>	RF signal (stereo sound)		
<b>Input terminal</b>	RF IN terminal		
<p>PCB-AV (COMPONENT SIDE)</p> 			

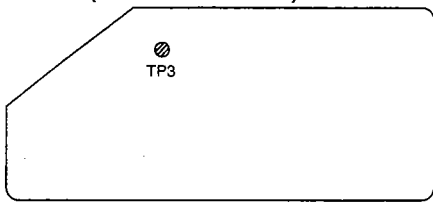
[Multi Channel Sound circuit] 5. Separation	<b>Adjustment purpose</b> Adjust right and left separation.  <b>Symptom when incorrectly adjusted</b> Poor or no stereo separation.													
<table border="1" style="width:100%; border-collapse: collapse;"> <tr> <td style="width:15%;"><b>Measuring instrument</b></td> <td>Oscilloscope</td> </tr> <tr> <td><b>Test point</b></td> <td>TP3</td> </tr> <tr> <td><b>EXT trigger</b></td> <td>---</td> </tr> <tr> <td><b>Measurement range</b></td> <td>DIV 10mV TIM 2ms</td> </tr> <tr> <td><b>Input signal</b></td> <td>RF signal (stereo sound)</td> </tr> <tr> <td><b>Input terminal</b></td> <td>RF IN terminal</td> </tr> </table>	<b>Measuring instrument</b>	Oscilloscope	<b>Test point</b>	TP3	<b>EXT trigger</b>	---	<b>Measurement range</b>	DIV 10mV TIM 2ms	<b>Input signal</b>	RF signal (stereo sound)	<b>Input terminal</b>	RF IN terminal	<p>* This adjustment must follow item 4 (Filter).</p> <ol style="list-style-type: none"> <li>1. Supply an RF signal (L-CH only stereo sound 300Hz 30%MOD).</li> <li>2. Observe the waveform at TP3.</li> <li>3. Activate the circuit adjustment mode. (refer to page 18)</li> <li>4. Set the adjustment function to "MCS". ("AUDIO" button)</li> <li>5. Make sure that the data of "5 HSP" is "32".</li> <li>6. Select adjustment item "4 LSP". ("VIDEO" button)</li> <li>7. Set the adjustment data so the amplitude of the waveform (300Hz) is minimum. ("ADJUST" button)</li> <li>8. Change the modulating signal to 3KHz.</li> <li>9. Select adjustment item "5 HSP". ("VIDEO" button)</li> <li>10. Set the adjustment data so that amplitude of the waveform (3kHz) is minimum. ("ADJUST" button)</li> <li>11. Repeat the steps 6 to 7.</li> <li>12. Write the adjustment data into memory. (Press "ENTER")</li> <li>13. Terminate the circuit adjustment mode. (Press "MENU" twice)</li> </ol>	
<b>Measuring instrument</b>	Oscilloscope													
<b>Test point</b>	TP3													
<b>EXT trigger</b>	---													
<b>Measurement range</b>	DIV 10mV TIM 2ms													
<b>Input signal</b>	RF signal (stereo sound)													
<b>Input terminal</b>	RF IN terminal													
<p><b>PCB-AV (COMPONENT SIDE)</b></p> 														

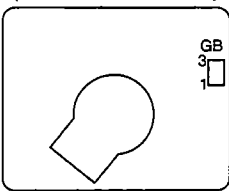
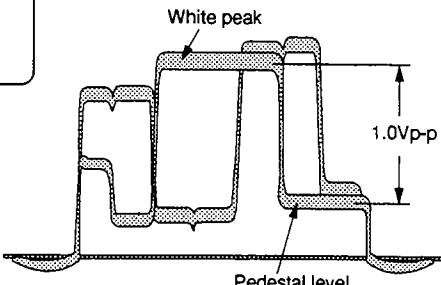
[Chroma circuit] 6. White level	<b>Adjustment purpose</b> To set the maximum white level.  <b>Symptom when incorrectly adjusted</b> Too bright or too dark white areas of the picture.																																																																
<table border="1" style="width:100%; border-collapse: collapse;"> <tr> <td style="width:15%;"><b>Measuring instrument</b></td> <td>Oscilloscope</td> </tr> <tr> <td><b>Test point</b></td> <td>pin 1 of connector GB</td> </tr> <tr> <td><b>EXT trigger</b></td> <td>---</td> </tr> <tr> <td><b>Measurement range</b></td> <td>DIV 50mV TIM 10µs</td> </tr> <tr> <td><b>Input signal</b></td> <td>VIDEO signal (color bar)</td> </tr> <tr> <td><b>Input terminal</b></td> <td>VIDEO IN terminal</td> </tr> </table>	<b>Measuring instrument</b>	Oscilloscope	<b>Test point</b>	pin 1 of connector GB	<b>EXT trigger</b>	---	<b>Measurement range</b>	DIV 50mV TIM 10µs	<b>Input signal</b>	VIDEO signal (color bar)	<b>Input terminal</b>	VIDEO IN terminal	<ol style="list-style-type: none"> <li>1. Supply a VIDEO signal (color bar).</li> <li>2. Activate the circuit adjustment mode. (refer to page 18)</li> <li>3. Set the adjustment function to "VCH". ("AUDIO" button)</li> <li>4. Set the adjustment items shown in the list below to the initial data value.</li> <li>5. Set the adjustment data of the adjustment item "35 GMA" to "0". ("VIDEO" and "ADJUST" buttons)</li> <li>6. Set the adjustment data of the adjustment item "36 GMG" to "0". ("VIDEO" and "ADJUST" buttons)</li> <li>7. Set the adjustment data of the adjustment item "02 BRT" to "150". ("VIDEO" and "ADJUST" buttons)</li> <li>8. Select adjustment item "03 CNT". ("VIDEO" button)</li> <li>9. Observe the waveform at Pin 1 of connector GB.</li> <li>10. Set the adjustment data so the waveform on the oscilloscope matches waveform below. ("ADJUST" button)</li> <li>11. Write the adjustment data into memory. (Press "ENTER")</li> </ol> <p><b>Note :</b> Adjustment item 7 (Vector) must be performed immediately after this adjustment.</p>																																																				
<b>Measuring instrument</b>	Oscilloscope																																																																
<b>Test point</b>	pin 1 of connector GB																																																																
<b>EXT trigger</b>	---																																																																
<b>Measurement range</b>	DIV 50mV TIM 10µs																																																																
<b>Input signal</b>	VIDEO signal (color bar)																																																																
<b>Input terminal</b>	VIDEO IN terminal																																																																
<p><b>PCB-VMCRT (COMPONENT SIDE)</b></p> 																																																																	
																																																																	
<table border="1" style="border-collapse: collapse;"> <thead> <tr> <th>No.</th> <th>Adjustment item</th> <th>Initial data</th> <th>No.</th> <th>Adjustment item</th> <th>Initial data</th> <th>No.</th> <th>Adjustment item</th> <th>Initial data</th> </tr> </thead> <tbody> <tr> <td>00</td> <td>COL</td> <td>80</td> <td>17</td> <td>AFC</td> <td>3</td> <td>38</td> <td>R-Y</td> <td>16</td> </tr> <tr> <td>05</td> <td>CTR</td> <td>255</td> <td>26</td> <td>CRS</td> <td>1</td> <td>39</td> <td>B-Y</td> <td>21</td> </tr> <tr> <td>06</td> <td>CTG</td> <td>255</td> <td>28</td> <td>DRR</td> <td>1</td> <td>40</td> <td>G-Y</td> <td>1</td> </tr> <tr> <td>07</td> <td>CTB</td> <td>255</td> <td>29</td> <td>DRB</td> <td>1</td> <td></td> <td></td> <td></td> </tr> <tr> <td>08</td> <td>DHR</td> <td>63</td> <td>30</td> <td>CRS</td> <td>1</td> <td></td> <td></td> <td></td> </tr> <tr> <td>09</td> <td>DHB</td> <td>63</td> <td>33</td> <td>DL1</td> <td>0</td> <td></td> <td></td> <td></td> </tr> </tbody> </table>			No.	Adjustment item	Initial data	No.	Adjustment item	Initial data	No.	Adjustment item	Initial data	00	COL	80	17	AFC	3	38	R-Y	16	05	CTR	255	26	CRS	1	39	B-Y	21	06	CTG	255	28	DRR	1	40	G-Y	1	07	CTB	255	29	DRB	1				08	DHR	63	30	CRS	1				09	DHB	63	33	DL1	0			
No.	Adjustment item	Initial data	No.	Adjustment item	Initial data	No.	Adjustment item	Initial data																																																									
00	COL	80	17	AFC	3	38	R-Y	16																																																									
05	CTR	255	26	CRS	1	39	B-Y	21																																																									
06	CTG	255	28	DRR	1	40	G-Y	1																																																									
07	CTB	255	29	DRB	1																																																												
08	DHR	63	30	CRS	1																																																												
09	DHB	63	33	DL1	0																																																												

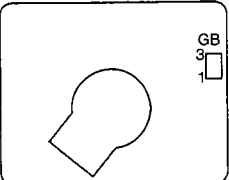
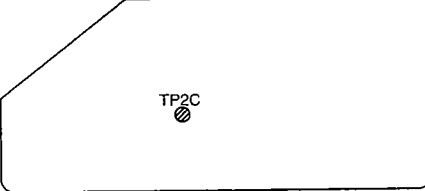
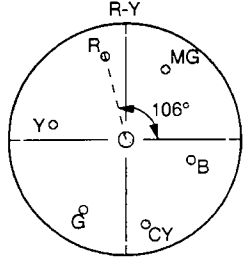
[Chroma circuit] 7. Vector		<b>Adjustment purpose</b> To produce correct hues.	
		<b>Symptom when incorrectly adjusted</b>	Different hues between the main and sub pictures.
<b>Measuring instrument</b>	Oscilloscope	<p>* This adjustment must follow item 6 (White level).</p> <ol style="list-style-type: none"> <li>1. Supply a VIDEO signal (color bar).</li> <li>2. Activate the circuit adjustment mode. (refer to page 18)</li> <li>3. Connect TP2C to the ground through an electrolytic capacitor (330<math>\mu</math>F, 16V or more).</li> <li>4. Set the adjustment function to "VCH". ("AUDIO" button)</li> <li>5. Select adjustment item "01 TNT". ("VIDEO" button)</li> <li>6. Observe the waveform at pin 1 and pin 2 of connector GB.</li> <li>7. Set the adjustment data so that the red point in the vector waveform, is at 106 degrees. ("ADJUST" button)</li> <li>8. Write the adjustment data into memory. (Press "ENTER")</li> </ol> <p><b>Note :</b> Adjustment item 8 (Color output) must be performed immediately after this adjustment.</p>	
<b>Test point</b>	X-CH:pin 2 of connector GB Y-CH:pin 1 of connector GB		
<b>EXT trigger</b>	---		
<b>Measurement range</b>	DIV 50mV X-Y mode		
<b>Input signal</b>	VIDEO signal (color bar)		
<b>Input terminal</b>	VIDEO IN terminal		
<div style="display: flex; justify-content: space-around; align-items: flex-start;"> <div style="text-align: center;"> <p><b>PCB-VMCRT (COMPONENT SIDE)</b></p>  </div> <div style="text-align: center;"> <p><b>PCB-AV (COMPONENT SIDE)</b></p>  </div> <div style="text-align: center;">  <p><b>Vector waveform</b></p> </div> </div>			

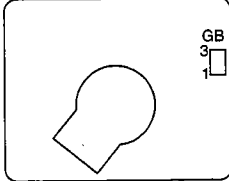
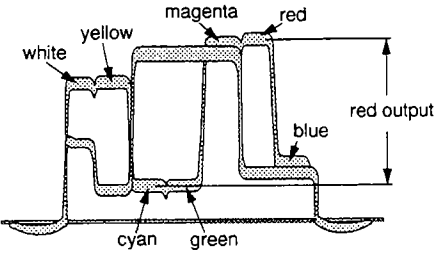
[Chroma circuit] 8. Color output		<b>Adjustment purpose</b> To set the color level of picture.	
		<b>Symptom when incorrectly adjusted</b>	Excess or insufficient color.
<b>Measuring instrument</b>	Oscilloscope	<p>* This adjustment must follow item 7 (Vector).</p> <ol style="list-style-type: none"> <li>1. Supply a VIDEO signal (color bar).</li> <li>2. Activate the circuit adjustment mode. (refer to page 18)</li> <li>3. Set the adjustment function to "VCH". ("AUDIO" button)</li> <li>4. Select adjustment item "00 COL". ("VIDEO" button)</li> <li>5. Observe the waveform at pin 1 of connector GB.</li> <li>6. Set the adjustment data so the amplitude of the red output voltage waveform is 1.80<math>\pm</math>0.05Vp-p. ("ADJUST" button)</li> <li>7. Set the adjustment data of the adjustment item "35 GMA" to "15". ("VIDEO" and "ADJUST" buttons)</li> <li>8. Set the adjustment data of the adjustment item "36 GMG" to "15". ("VIDEO" and "ADJUST" buttons)</li> <li>9. Write the adjustment data into memory. (Press "ENTER")</li> <li>10. Terminate the circuit adjustment mode. (Press "MENU" twice)</li> <li>11. Remove the electrolytic capacitor from TP2C and the ground.</li> </ol>	
<b>Test point</b>	pin1 of connector GB		
<b>EXT trigger</b>	---		
<b>Measurement range</b>	DIV 50mV TIM 10 $\mu$ s		
<b>Input signal</b>	VIDEO signal (color bar)		
<b>Input terminal</b>	VIDEO IN terminal		
<div style="display: flex; justify-content: space-around; align-items: flex-start;"> <div style="text-align: center;"> <p><b>PCB-VMCRT (COMPONENT SIDE)</b></p>  </div> <div style="text-align: center;">  </div> </div>			

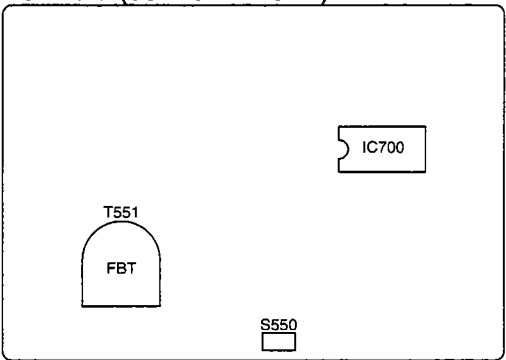
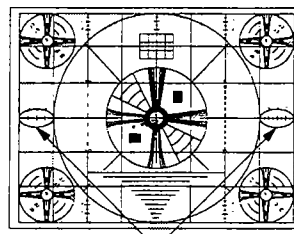
[Deflection circuit] 9. Horizontal width	<b>Adjustment purpose</b> To set the width of picture.  <b>Symptom when incorrectly adjusted</b> Picture compressed or expanded horizontally.													
<table border="1" style="width:100%; border-collapse: collapse;"> <tr> <td style="width:15%;"><b>Measuring instrument</b></td> <td style="width:15%;">---</td> </tr> <tr> <td><b>Test point</b></td> <td>---</td> </tr> <tr> <td><b>EXT trigger</b></td> <td>---</td> </tr> <tr> <td><b>Measurement range</b></td> <td>---</td> </tr> <tr> <td><b>Input signal</b></td> <td>VIDEO signal (monoscope)</td> </tr> <tr> <td><b>Input terminal</b></td> <td>VIDEO IN terminal</td> </tr> </table>	<b>Measuring instrument</b>	---	<b>Test point</b>	---	<b>EXT trigger</b>	---	<b>Measurement range</b>	---	<b>Input signal</b>	VIDEO signal (monoscope)	<b>Input terminal</b>	VIDEO IN terminal	<ol style="list-style-type: none"> <li>1. Supply a VIDEO signal (monoscope).</li> <li>2. Set S550 to the mechanical center position. (CS-35303 only) Set S550 so that the picture is nearly centered. (CS-31203, CS-31203C, CS-31303, CS-31303C, CK-35403 only)</li> <li>3. Activate the circuit adjustment mode. (refer to page 18)</li> <li>4. Set the adjustment function to "VCH". ("AUDIO UP/Down button)</li> <li>5. Set the adjustment data of the adjustment item "51 HCM" to the data shown in the list below. ("VIDEO" and "ADJUST" buttons)</li> <li>6. Select adjustment item "12 HWD". ("VIDEO" button)</li> <li>7. Set the adjustment data so that the sum of markers for the horizontal width is 6.5. ("ADJUST" button)</li> <li>8. Write the adjustment data into memory. (Press "ENTER")</li> <li>9. Terminate the circuit adjustment mode. (Press "MENU" twice)</li> </ol>	
<b>Measuring instrument</b>	---													
<b>Test point</b>	---													
<b>EXT trigger</b>	---													
<b>Measurement range</b>	---													
<b>Input signal</b>	VIDEO signal (monoscope)													
<b>Input terminal</b>	VIDEO IN terminal													
<p><b>PCB-MAIN (COMPONENT SIDE)</b></p> 	 Horizontal markers	<table border="1" style="width:100%; border-collapse: collapse;"> <tr> <td style="width:15%;"></td> <td style="width:15%;">CS-31303 CS-31303C</td> <td style="width:15%;">CS-31203 CS-31203C</td> <td style="width:15%;">CS-35303</td> <td style="width:15%;">CK-35304</td> </tr> <tr> <td>51 HCM</td> <td>9</td> <td>8</td> <td>8</td> <td>7</td> </tr> </table>		CS-31303 CS-31303C	CS-31203 CS-31203C	CS-35303	CK-35304	51 HCM	9	8	8	7		
	CS-31303 CS-31303C	CS-31203 CS-31203C	CS-35303	CK-35304										
51 HCM	9	8	8	7										

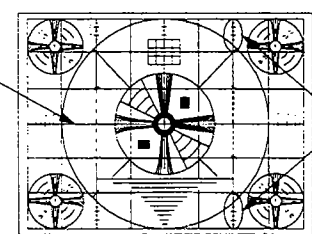
[Deflection circuit] 10. Vertical linearity and height	<b>Adjustment purpose</b> To set vertical height and linearity.  <b>Symptom when incorrectly adjusted</b> Incorrect vertical height or linearity.													
<table border="1" style="width:100%; border-collapse: collapse;"> <tr> <td style="width:15%;"><b>Measuring instrument</b></td> <td style="width:15%;">---</td> </tr> <tr> <td><b>Test point</b></td> <td>---</td> </tr> <tr> <td><b>EXT trigger</b></td> <td>---</td> </tr> <tr> <td><b>Measurement range</b></td> <td>---</td> </tr> <tr> <td><b>Input signal</b></td> <td>VIDEO signal (monoscope)</td> </tr> <tr> <td><b>Input terminal</b></td> <td>VIDEO IN terminal</td> </tr> </table>	<b>Measuring instrument</b>	---	<b>Test point</b>	---	<b>EXT trigger</b>	---	<b>Measurement range</b>	---	<b>Input signal</b>	VIDEO signal (monoscope)	<b>Input terminal</b>	VIDEO IN terminal	<ol style="list-style-type: none"> <li>1. Supply a VIDEO signal (monoscope).</li> <li>2. Activate the circuit adjustment mode. (refer to page 18)</li> <li>3. Set the adjustment function to "VCH". ("AUDIO button)</li> <li>4. Set the adjustment data of the adjustment item "50 VCM" to the value shown in the list below. ("VIDEO" and "ADJUST" buttons)</li> <li>5. Select adjustment item "45 VLR" (vertical linearity). ("VIDEO" button)</li> <li>6. Set the adjustment data so that the distances from the top and bottom of the largest circle, to the center horizontal line are equal. ("ADJUST" button)</li> <li>7. Select adjustment item "10 VHT" ("Vertical height). ("VIDEO" button)</li> <li>8. Set the adjustment data so that the sum of markers for the vertical height is 4.2. ("ADJUST" button)</li> <li>9. Write the adjustment data into memory. (Press "ENTER")</li> <li>10. Terminate the circuit adjustment mode. (Press "MENU" twice)</li> </ol>	
<b>Measuring instrument</b>	---													
<b>Test point</b>	---													
<b>EXT trigger</b>	---													
<b>Measurement range</b>	---													
<b>Input signal</b>	VIDEO signal (monoscope)													
<b>Input terminal</b>	VIDEO IN terminal													
<p><b>50 VCM</b></p> <table border="1" style="width:100%; border-collapse: collapse;"> <tr> <td style="width:15%;"></td> <td style="width:15%;">CS-31303 CS-31303C</td> <td style="width:15%;">CS-31203 CS-31203C</td> <td style="width:15%;">CS-35303 CK-35304</td> </tr> <tr> <td>50 VCM</td> <td>9</td> <td>8</td> <td>8</td> </tr> </table>		CS-31303 CS-31303C	CS-31203 CS-31203C	CS-35303 CK-35304	50 VCM	9	8	8	 Horizontal center line Vertical markers					
	CS-31303 CS-31303C	CS-31203 CS-31203C	CS-35303 CK-35304											
50 VCM	9	8	8											

[Deflection circuit] 11.Side PCC		<b>Adjustment purpose</b> Minimize side pincushion distortion.
		<b>Symptom when incorrectly adjusted</b> Horizontal distortion in the picture.
<b>Measuring instrument</b>	----	<p>* This adjustment must follow item 10(Vertical linearity and height).</p> <ol style="list-style-type: none"> <li>1. Supply a VIDEO signal (crosshatch).</li> <li>2. Activate the circuit adjustment mode. (refer to page 18)</li> <li>3. Set the adjustment function to "VCH". ("AUDIO" button)</li> <li>4. Select adjustment item "11 PAM" (PCC-AMP). ("VIDEO" button)</li> <li>5. Note the second vertical lines from both right and left sides. Set the adjustment data so that the second line is almost straight. ("ADJUST" button)</li> <li>6. Select adjustment item "47 PPH". (PCC-Phase). ("VIDEO" button)</li> <li>7. Note the second lines from both right and left sides of the cross hatch. Set the adjustment data so that the distortion is symmetrical at the top and bottom of the vertical lines. ("ADJUST" button)</li> <li>8. Alternately repeat steps 4 and 7 to minimize side raster distortion.</li> <li>9. Write the adjustment data into memory. (Press "ENTER")</li> <li>10. Terminate the circuit adjustment mode. (Press "MENU" twice)</li> </ol> <p><b>Note</b> : If the side raster is significantly distorted in the middle, set the adjustment data of items "48 PC1" (bottom PCC corner AMP), "49PC2" (top PCC corner AMP) and "11 PAM" (PCC-AMP), for minimum distortion.</p>
<b>Test point</b>	----	
<b>EXT trigger</b>	----	
<b>Measurement range</b>	----	
<b>Input signal</b>	VIDEO signal (cross hatch)	
<b>Input terminal</b>	VIDEO IN terminal	

[Deflection circuit] 12.Vertical S Correction		<b>Adjustment purpose</b> Set the Vertical compression/expansion at the top and bottom.
		<b>Symptom when incorrectly adjusted</b> Vertically compressed or expanded at the top and bottom of the picture.
<b>Measuring instrument</b>	----	<ol style="list-style-type: none"> <li>1. Supply a VIDEO signal (crosshatch).</li> <li>2. Activate the circuit adjustment mode. (refer to page 18)</li> <li>3. Set the adjustment function to "VCH". ("AUDIO" button)</li> <li>4. Select adjustment item "44 VSC". ("VIDEO" button)</li> <li>5. Set the adjustment data so that the height of the squares in the cross hatch are equal at the top, bottom, and middle of the pattern. ("ADJUST" button)</li> <li>6. Write the adjustment data into memory. (Press "ENTER")</li> <li>7. Terminate the circuit adjustment mode. (Press "MENU" twice)</li> </ol> <p><b>Note</b> : Adjustment item 10(Vertical linearity, Vertical Height) must be performed immediately after this adjustment.</p>
<b>Test point</b>	----	
<b>EXT trigger</b>	----	
<b>Measurement range</b>	----	
<b>Input signal</b>	VIDEO signal (cross hatch)	
<b>Input terminal</b>	VIDEO IN terminal	

Top side

Bottom side

Wider on top and bottom      Narrower on top and bottom

[Deflection circuit] 13. Horizontal position		<b>Adjustment purpose</b> To set the horizontal position of the picture on screen.
		<b>Symptom when incorrectly adjusted</b> Picture shifted to the left or the right.
<b>Measuring instrument</b>	---	<p>*This adjustment must follow item 9 (Horizontal width).</p> <ol style="list-style-type: none"> <li>1. Supply a VIDEO signal (monoscope).</li> <li>2. Activate the circuit adjustment mode. (refer to page 18)</li> <li>3. Set the adjustment function to "VCH". ("AUDIO" button)</li> <li>4. Select adjustment item "43 HPH". ("VIDEO" button)</li> <li>5. Set the adjustment data so the left and right markers are the same. ("ADJUST" button)</li> <li>6. Write the adjustment data into memory. (Press "ENTER")</li> <li>7. Terminate the circuit adjustment mode. (Press "MENU" twice)</li> </ol>
<b>Test point</b>	---	
<b>EXT trigger</b>	---	
<b>Measurement range</b>	---	
<b>Input signal</b>	VIDEO signal (monoscope)	
<b>Input terminal</b>	VIDEO IN terminal	

[Deflection circuit] 14. Vertical position		<b>Adjustment purpose</b> To set the vertical position of the picture.
		<b>Symptom when incorrectly adjusted</b> The picture will be too high or too low, on the screen.
<b>Measuring instrument</b>	---	<ol style="list-style-type: none"> <li>1. Supply a VIDEO signal (monoscope).</li> <li>2. Activate the circuit adjustment mode. (refer to page 18)</li> <li>3. Set the adjustment function to "VCH". ("AUDIO" button)</li> <li>4. Select adjustment item "46 VSF". ("VIDEO" button)</li> <li>5. Set the adjustment data so the upper and lower markers are the same. ("ADJUST" button)</li> <li>6. Write the adjustment data into memory. (Press "ENTER")</li> <li>7. Terminate the circuit adjustment mode. (Press "MENU" twice)</li> </ol>
<b>Test point</b>	---	
<b>EXT trigger</b>	---	
<b>Measurement range</b>	---	
<b>Input signal</b>	VIDEO signal (monoscope)	
<b>Input terminal</b>	VIDEO IN terminal	

[CRT circuit] 15. CRT bias, Cut off		<b>Adjustment purpose</b> Setting the cut off level of the three electron beams.
		<b>Symptom when incorrectly adjusted</b> Monochrome has a color tint.
<b>Measuring instrument</b>	---	<ol style="list-style-type: none"> <li>1. Supply a VIDEO signal (monoscope).</li> <li>2. Activate the circuit adjustment mode. (refer to page 18)</li> <li>3. Set the adjustment function to "VCH" ("AUDIO" button) and set the adjustment items shown in the Table 1 and Table 2 to the initial data value.</li> <li>4. Set the data of item "35 GMA" to "00". ("VIDEO" and "ADJUST" buttons)</li> <li>5. Select adjustment item. "19 SVS". ("VIDEO" button)</li> <li>6. Set the adjustment data to "00" (The screen will change to display a single horizontal line). ("ADJUST" button)</li> <li>7. Set the SCREEN VR on FBT(T551) to the point where a red, green, or blue line just becomes visible.</li> <li>8. Set the adjustment data to "01". (The screen will return to the normal display.) ("ADJUST" button)</li> <li>9. Referring to adjustment items "05 CTR", "06 CTG" and "07 CTB", adjust the data of the items for to the two colors not visible in the step 7. Adjust data so the horizontal line is white. ("VIDEO" and "ADJUST" buttons)</li> </ol> <p><b>Note</b> : The screen displays the single white line for a certain amount of time after the adjustment data is modified. (While adjusting, the screen goes to a single horizontal line.)</p> <p><b>Note</b> : CUT OFF data for the color visible on the screen displaying the single line in step 7 must not be changed.</p> <ol style="list-style-type: none"> <li>10. Write the adjustment data into memory. (Press "ENTER")</li> <li>11. Terminate the circuit adjustment mode. (Press "MENU" twice)</li> </ol> <p><b>Note</b> : Adjustment item 16 (while balance) must be performed immediately after this adjustment.</p>
<b>Test point</b>	---	
<b>EXT trigger</b>	---	
<b>Measurement range</b>	---	
<b>Input signal</b>	VIDEO signal (monoscope)	
<b>Input terminal</b>	VIDEO IN terminal	

No.	Adjustment Item	Initial Data	No.	Adjustment Item	Initial Data
02	BRT	135	28	DRR	01
03	CNT	70	29	DRB	01
08	DHR	63	30	CBS	01
09	DHB	63	36	GMG	15
26	CRS	01			

**Table. 1**

The color of light to be adjusted	Adjustment Item	Initial Data
Red	05 CTR	255
Green	06 CTG	255
Blue	07 CTB	255

**Table. 2**

[CRT circuit] 16. White balance		<b>Adjustment purpose</b> The best white balance of picture.
		<b>Symptom when incorrectly adjusted</b> Colored monochrome.
<b>Measuring instrument</b>	---	<p>* This adjustment must follow item 15(CRT bias Cut, off).</p> <ol style="list-style-type: none"> <li>1. Supply a VIDEO signal (white raster).</li> <li>2. Activate the circuit adjustment mode. (refer to page 18)</li> <li>3. Set the adjustment function to "VCH". ("AUDIO" button)</li> <li>4. Select adjustment items "8 DHR" (R-DRIVE) and "9 DHB" (B-DRIVE). ("VIDEO" button)</li> <li>5. Set the adjustment data for a white raster. ("ADJUST" button)</li> </ol> <p><b>Note</b> : If the adjustment data in "8 DMR" and "9 DMB" needs to be decreased below the adjustable range, change the data in "28 DRR" from "01" to "00", for adjustment item "8 DMB", and in "29 DRB" for "9DMB".</p> <ol style="list-style-type: none"> <li>6. Select adjustment item "19SVS" (Single Horizontal Line Switchover). ("VIDEO" button)</li> <li>7. Set the adjustment data to "00". (The screen will be changed to display a single horizontal line.) ("ADJUST" button)</li> <li>8. Make sure that the color of the horizontal line is white. If not white, repeat the adjustment in item 15(CRT bias, Cut off).</li> <li>9. Write the adjustment data into memory. (Press "ENTER")</li> <li>10. Terminate the circuit adjustment mode. (Press "MENU" twice)</li> </ol> <p><b>Note</b> : Adjustment item 17 (Black level) must be performed immediately after this adjustment.</p>
<b>Test point</b>	---	
<b>EXT trigger</b>	---	
<b>Measurement range</b>	---	
<b>Input signal</b>	VIDEO signal (white raster)	
<b>Input terminal</b>	VIDEO IN terminal	

[Video circuit] 17. Black level		<b>Adjustment purpose</b> Picture luminance.												
		<b>Symptom when incorrectly adjusted</b> Excessive or insufficient brightness.												
<b>Measuring instrument</b>	---	<p>* This adjustment must follow item 16(White balance).</p> <ol style="list-style-type: none"> <li>1. Supply a VIDEO signal (monoscope).</li> <li>2. Activate the circuit adjustment mode. (refer to page 18)</li> <li>3. Set the adjustment function to "VCH". ("AUDIO" button)</li> <li>4. Select adjustment item "2 BRT" (BRIGHT CONT). ("VIDEO" button)</li> <li>5. Observe a gradation signal inside a monoscope signal, and set the adjustment data so that the levels of 10% and 0% areas of the gradation are the same (Black level 10%). ("ADJUST" button)</li> <li>6. Write the adjustment data into memory. (Press "ENTER")</li> <li>7. Terminate the circuit adjustment mode. (Press "MENU" twice)</li> </ol> <p><b>Note</b> : Adjustment item 18 (Sub cont) must be performed immediately after this adjustment.</p>												
<b>Test point</b>	---													
<b>EXT trigger</b>	---													
<b>Measurement range</b>	---													
<b>Input signal</b>	VIDEO signal (monoscope)													
<b>Input terminal</b>	VIDEO IN terminal													
			<p>gradation signal</p> <table border="1" style="display: inline-table; margin-right: 20px;"> <tr><td>40%</td><td>30%</td><td>20%</td><td>10%</td></tr> <tr><td>50%</td><td>0%</td><td>0%</td><td>0%</td></tr> <tr><td>60%</td><td>70%</td><td>80%</td><td>90%</td></tr> </table>  <p>Monoscope signal</p>	40%	30%	20%	10%	50%	0%	0%	0%	60%	70%	80%
40%	30%	20%	10%											
50%	0%	0%	0%											
60%	70%	80%	90%											

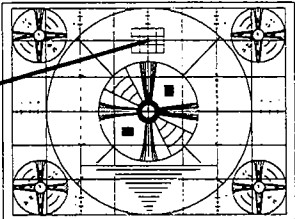

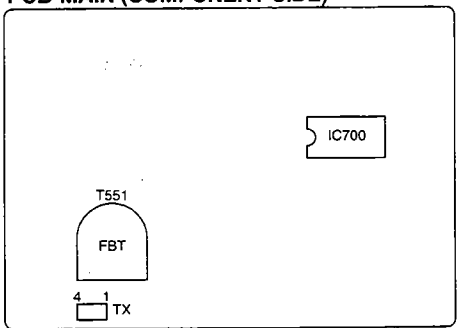
[Videe circuit] 18. Sub cont	<b>Adjustment purpose</b> To set beam current to its optimum value.  <b>Symptom when incorrectly adjusted</b> Excessive or insufficient contrast.													
<table border="1" style="width:100%; border-collapse: collapse;"> <tr> <td style="width:15%;"><b>Measuring instrument</b></td> <td>DC miliammeter</td> </tr> <tr> <td><b>Test point</b></td> <td>+ lead : pin 4 of connector TX - lead : pin 1 of connector TX</td> </tr> <tr> <td><b>EXT trigger</b></td> <td>---</td> </tr> <tr> <td><b>Measurement range</b></td> <td>---</td> </tr> <tr> <td><b>Input signal</b></td> <td>RF signal (gray scale 87.5%MOD)</td> </tr> <tr> <td><b>Input terminal</b></td> <td>RF IN terminal</td> </tr> </table>	<b>Measuring instrument</b>	DC miliammeter	<b>Test point</b>	+ lead : pin 4 of connector TX - lead : pin 1 of connector TX	<b>EXT trigger</b>	---	<b>Measurement range</b>	---	<b>Input signal</b>	RF signal (gray scale 87.5%MOD)	<b>Input terminal</b>	RF IN terminal	<ul style="list-style-type: none"> <li>* This adjustment must follow item 17(Black levēl).</li> <li>* Preheat the set for two minutes or more.</li> <li>1. Supply an RF signal (gray scale 87.5% MOD).</li> <li>2. Activate the circuit adjustment mode. (refer to page 18)</li> <li>3. Set the adjustment function to "VCH". ("AUDIO" button)</li> <li>4. Select adjustment item "35 GMA". ("VIDEO" button)</li> <li>5. Set the adjustment data to "00". ("ADJUST" button)</li> <li>6. Measure the current at pins 1 and 4 of connector TX (Plus lead to pin 4 of connector TX).</li> <li>7. Select adjustment item "3 CNT" (CONTRAST). ("VIDEO" button)</li> <li>8. Set the adjustment data so that the DC miliammeter reads the value shown below. ("ADJUST" bntton)</li> <li>9. Select adjustment item "35 GMA". ("VIDEO" bntton)</li> <li>10. Set the adjustment data to "15". ("ADJUST" button)</li> <li>11. Write the adjustment data into memory. (Press "ENTER")</li> <li>12. Terminate the circuit adjustment mode. (Press "MENU" twice)</li> </ul>	
<b>Measuring instrument</b>	DC miliammeter													
<b>Test point</b>	+ lead : pin 4 of connector TX - lead : pin 1 of connector TX													
<b>EXT trigger</b>	---													
<b>Measurement range</b>	---													
<b>Input signal</b>	RF signal (gray scale 87.5%MOD)													
<b>Input terminal</b>	RF IN terminal													
<div style="display: flex; justify-content: space-between;"> <div style="width: 45%;"> <p><b>PCB-MAIN (COMPONENT SIDE)</b></p>  </div> <div style="width: 50%;"> <table border="1" style="width:100%; border-collapse: collapse; text-align: center;"> <tr> <td style="width:15%;"></td> <td style="width:15%;">CS-31203 CS-31203C</td> <td style="width:15%;">CS-31303 CS-31303C</td> <td style="width:15%;">CK-35304</td> <td style="width:15%;">CS-35303</td> </tr> <tr> <td>Beam current</td> <td colspan="3">2600±100μA</td> <td>3400±100μA</td> </tr> </table> </div> </div>				CS-31203 CS-31203C	CS-31303 CS-31303C	CK-35304	CS-35303	Beam current	2600±100μA			3400±100μA		
	CS-31203 CS-31203C	CS-31303 CS-31303C	CK-35304	CS-35303										
Beam current	2600±100μA			3400±100μA										

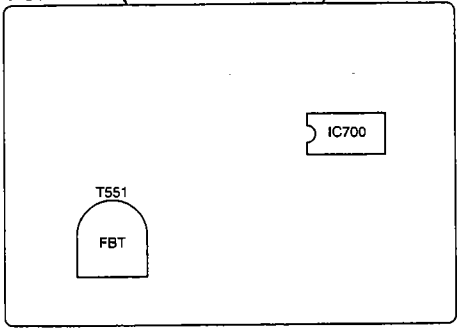
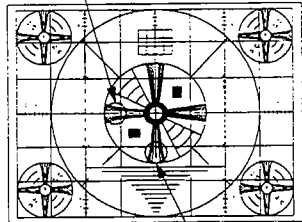
[Focus circuit] 19. Focus (CS-35303, CK-35304 only)	<b>Adjustment purpose</b> Sharpness of picture.  <b>Symptom when incorrectly adjusted</b> Poor focus.													
<table border="1" style="width:100%; border-collapse: collapse;"> <tr> <td style="width:15%;"><b>Measuring instrument</b></td> <td>---</td> </tr> <tr> <td><b>Test point</b></td> <td>---</td> </tr> <tr> <td><b>EXT trigger</b></td> <td>---</td> </tr> <tr> <td><b>Measurement range</b></td> <td>---</td> </tr> <tr> <td><b>Input signal</b></td> <td>VIDEO signal (monoscope)</td> </tr> <tr> <td><b>Input terminal</b></td> <td>VIDEO IN terminal</td> </tr> </table>	<b>Measuring instrument</b>	---	<b>Test point</b>	---	<b>EXT trigger</b>	---	<b>Measurement range</b>	---	<b>Input signal</b>	VIDEO signal (monoscope)	<b>Input terminal</b>	VIDEO IN terminal	<ol style="list-style-type: none"> <li>1. Supply a VIDEO signal (monoscope).</li> <li>2. Observe the vertical lines and adjust FOCUS control on the FOCUS PACK for best focus. (CS-35303 only) Observe the vertical lines and adjust FOCUS-2 control on the FBT for best focus. (CK-35304 only)</li> <li>3. Observe the horizontal lines, and adjust FOCUS-2 control on the FBT for best focus. (CS-35303 only) Observe the horizontal lines, and adjust FOCUS-1 control on the FBT for best focus. (CK-35304 only)</li> <li>4. Repeat steps 2 and 3, two or more times until no further improvement is seen.</li> </ol>	
<b>Measuring instrument</b>	---													
<b>Test point</b>	---													
<b>EXT trigger</b>	---													
<b>Measurement range</b>	---													
<b>Input signal</b>	VIDEO signal (monoscope)													
<b>Input terminal</b>	VIDEO IN terminal													
<div style="display: flex; justify-content: space-between;"> <div style="width: 45%;"> <p><b>PCB-MAIN (COMPONENT SIDE)</b></p>  </div> <div style="width: 50%; text-align: center;"> <p>Check point for horizontal line</p>  <p>Check point for vertical line <b>Monoscope signal</b></p> </div> </div>														

[Focus circuit] 20. Focus (CS-31303, CS-31303C (CS-31203, CS-31203C only)		<b>Adjustment purpose</b> Sharpness of picture.
		<b>Symptom when incorrectly adjusted</b> Poor focus.
<b>Measuring instrument</b>	----	1. Supply an RF signal (standard broadcast). 2. Adjust FOCUS control on FBT (T551) for best overall focus.
<b>Test point</b>	----	
<b>EXT trigger</b>	----	
<b>Measurement range</b>	----	
<b>Input signal</b>	RF signal (standard broadcast)	
<b>Input terminal</b>	RF IN terminal	
<p><b>PCB-MAIN (COMPONENT SIDE)</b></p> <p>The diagram shows a rectangular PCB layout. In the lower-left quadrant, there is a semi-circular component labeled 'T551' with 'FBT' written below it. In the upper-right quadrant, there is a rectangular component labeled 'IC700'.</p>		

[Screen character circuit] 21. Character position		<b>Adjustment purpose</b> To position the character display.
		<b>Symptom when incorrectly adjusted</b> Incorrect character position.
<b>Measuring instrument</b>	----	1. Supply an RF signal (standard broadcast). 2. Activate the circuit adjustment mode. (refer to page 18) 3. Set the adjustment function to "HR". ("AUDIO" button) 4. Adjust the adjustment data so that spaces A and B are the same width. ("ADJUST" button) 5. Write the adjustment data into memory. (Press "ENTER") 6. Terminate the circuit adjustment mode. (Press "MENU" twice)
<b>Test point</b>	----	
<b>EXT trigger</b>	----	
<b>Measurement range</b>	----	
<b>Input signal</b>	RF signal (standard broadcast)	
<b>Input terminal</b>	RF IN terminal	
<p>The diagram shows a rectangular display area. At the bottom center, the text 'HR 02' is displayed. Two vertical dashed lines extend upwards from the 'H' and '2' characters. At the top of each dashed line, there is a horizontal double-headed arrow. The left arrow is labeled 'A' and the right arrow is labeled 'B', indicating the width of the characters.</p>		

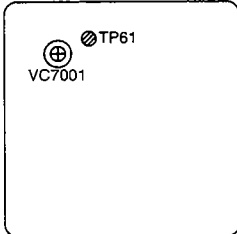
[PIP circuit] 22. PIP fsc (CS-35303, CK-35304 CS-31303, CS-31303C only)		<b>Adjustment purpose</b> Set the clock frequency for PIP.  <b>Symptom when incorrectly adjusted</b> Disturbance or no color in the sub picture.
<b>Measuring instrument</b>	Frequency counter	<ol style="list-style-type: none"> <li>1. Supply an RF signal (standard broadcast).</li> <li>2. Display standard contrast on the sub picture screen.     Supply no signal for the main screen.</li> <li>3. Observe the frequency at TP61.</li> <li>4. Adjust VC7001 so that the frequency is <math>3.579545 \pm 0.000030</math> MHz.</li> </ol>
<b>Test point</b>	TP61	
<b>EXT trigger</b>	---	
<b>Measurement range</b>	---	
<b>Input signal</b>	RF signal (standard broadcast)	
<b>Input terminal</b>	RF IN terminal	
<div style="display: flex; align-items: flex-start;"> <div style="margin-right: 20px;"> <p><b>PCB-PIP (COMPONENT SIDE)</b></p>  </div> </div>		

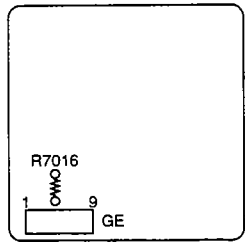
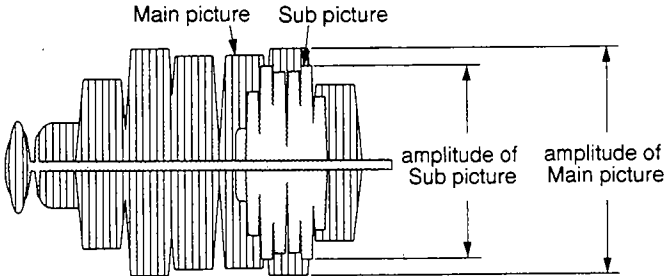
[PIP circuit] 23. PIP chroma gain (CS-35303, CK-35304 CS-31303, CS-31303C only)		<b>Adjustment purpose</b> To set the color level between main and sub picture.  <b>Symptom when incorrectly adjusted</b> Different color level between main and sub picture.
<b>Measuring instrument</b>	Oscilloscope	<p>* Preheat the set for one minutes or more.</p> <ol style="list-style-type: none"> <li>1. Supply a VIDEO signal (color bar).</li> <li>2. Activate the circuit adjustmant mode. (refer to page 18)</li> <li>3. Set the adjustmant function to "PIP". ("AUDIO" button)</li> <li>4. Set all the items in adjustment function "PIP" to the initial data value (refer to page 21). ("VIDEO" and "ADJUST" buttons)</li> <li>5. Observe the waveform at pin 7 of connector GE (GE side of R7016).</li> <li>6. Select adjustmant item "1 COLR". ("VIDEO" button)</li> <li>7. Set the adjustmant data so that the amplitude of the waveforms of the main and sub pictures are equal. ("ADJUST" button)</li> <li>8. Write the adjustmet data into memory. (Press "ENTER")</li> <li>9. Terminate the circuit adjustment mode. (Press "MENU" twice)</li> </ol> <p>Note : Adjustment item 24 (PIP Sub TINT) must be performed immediately after this adjustment.</p>
<b>Test point</b>	pin 7 of connector GE	
<b>EXT trigger</b>	---	
<b>Measurement range</b>	DIV 20mV TIM 10μs	
<b>Input signal</b>	VIDEO signal (color bar)	
<b>Input terminal</b>	VIDEO IN terminal	
<div style="display: flex; align-items: flex-start;"> <div style="margin-right: 40px;"> <p><b>PCB-PIP (COMPONENT SIDE)</b></p>  </div> <div>  </div> </div>		

[PIP circuit] 24. PIP Sub TINT (CS-35303, CK-35304 CS-31303, CS-31303C only)		<b>Adjustment purpose</b> To obtain the same hue in main and sub pictures.
		<b>Symptom when incorrectly adjusted</b> Different hue between main and sub picture, and color smear.
<b>Measuring instrument</b>	---	<p>*Preheat the set for one minutes or more. *This adjustment must follow item 23 (PIP chroma gain).</p> <ol style="list-style-type: none"> <li>1. Supply a VIDEO signal (color bar).</li> <li>2. Activate PIP and display the same picture on main picture screen and sub picture screen.</li> <li>3. Activate the circuit adjustment mode. (refer to page 18)</li> <li>4. Set the adjustment function to "PIP". ("AUDIO" button)</li> <li>5. Select adjustment item "0 TINT". ("VIDEO" button)</li> <li>6. Set the adjustment data so that the hue in the sub picture corresponds to the hue in the main picture.</li> <li>7. Write the adjustment data into memory. (Press "ENTER")</li> <li>8. Terminal the circuit adjustment mode. (Press "MENU" twice)</li> </ol>
<b>Test point</b>	---	
<b>EXT trigger</b>	---	
<b>Measurement range</b>	---	
<b>Input signal</b>	VIDEO signal (color bar)	
<b>Input terminal</b>	VIDEO IN terminal	

# PARTS LIST COSMENTIC PARTS REFERENCE

[for CS-31203, CS-31203C, CS-31303, CS-31303C]

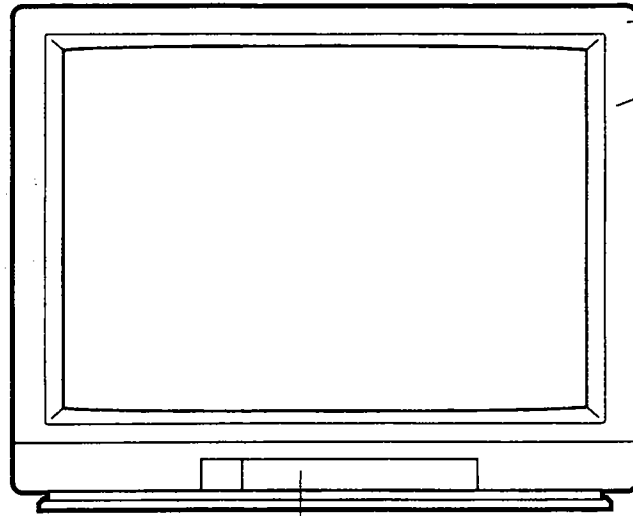

Front cabinet Assy  
701A457O90  
[CS-31203, CS-31303]  
701A100O90  
[CS-31203C, CS-31303C]

Door  
752C075O30

Door Catch  
761C352O10

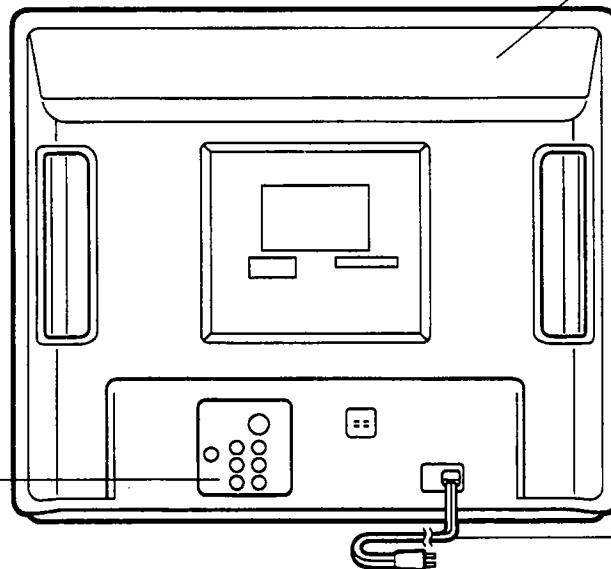

Back cover  
700C180O20(CS-31203)  
700C180O30(CS-31203C)  
700C179O90(CS-31303)  
700C180O10(CS-31303C)

Terminal Board  
761A111O10

AC Power Cord  
242C957O40

[for CS-35303]

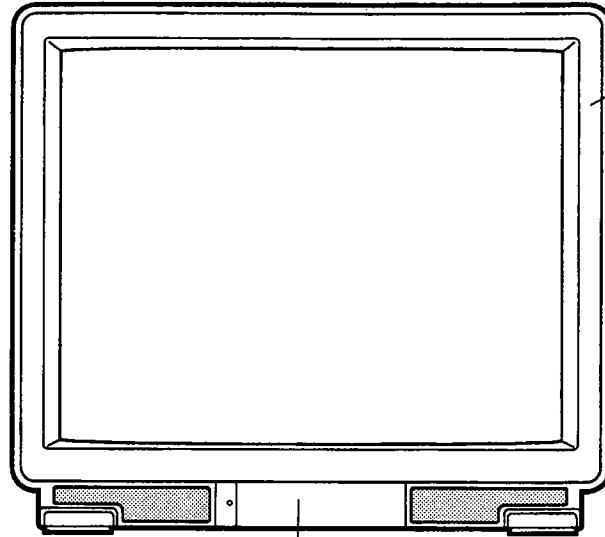

Front cabinet Assy  
701A492O80

Door  
752C075O10

Door Catch  
761C352O10



Back cover  
700C179O50

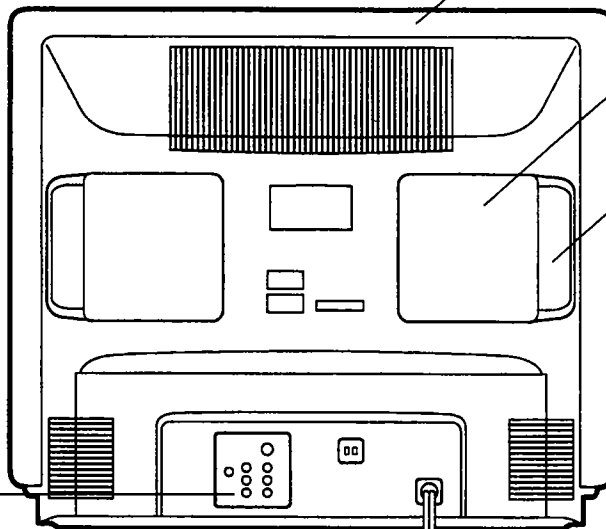

Cover Assy  
752C045O40

Baffle Board assy  
752C045O30

Terminal Board  
761A111O10

AC Power Cord  
242C957O40

[for CK-35304]

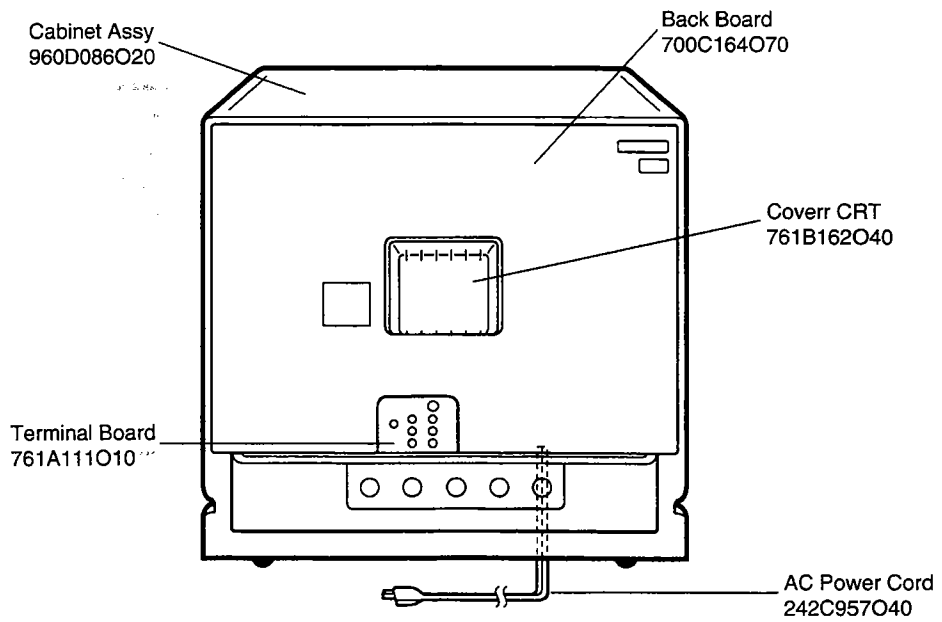
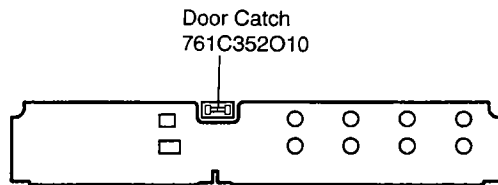
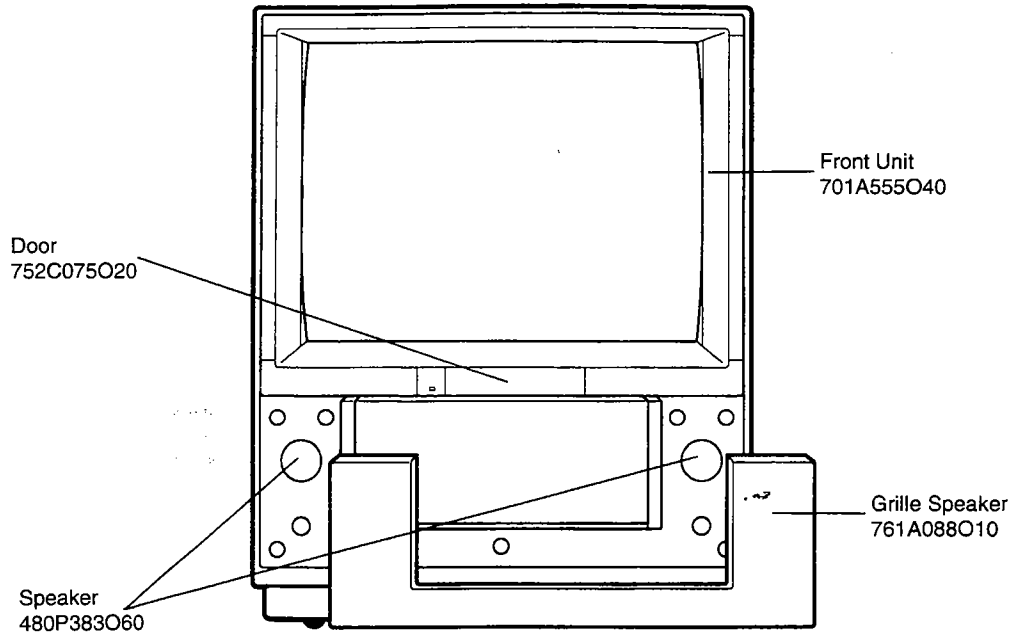

# PARTS LIST

MODEL : CS-31203/CS-31203C/CS-31303/CS-31303C/CS-35303/CK-35304

In order to expedite delivery of replacement part orders.

- Specify : 1.Model number/Serial number
- 2.Part number and Description
- 3.Quantity

Unless full information is supplied,delay in execution of orders will result.

\* : Warranty return items

☆ : Critical components

MARK	B	C	D	F	G	J	K
TOLERANCE (%)	±0.1	±0.25	±0.5	±1	±2	±5	±10

MARK	M	N	V	X	Z	P	Q
TOLERANCE (%)	±20	±30	+10 -10	+40 -20	+80 -20	+100 -0	+30 -10

MARK	B	C	D	F	G
TOLERANCE (pF)	±0.1	±0.25	±0.5	±1	±2

## ABBREVIATION

- [31203] : CS-31203
- [31203C] : CS-31203C
- [31303] : CS-31303
- [31303C] : CS-31303C
- [35303] : CS-35303
- [35304] : CK-35304



SYMBOL PARTS				SYMBOL PARTS			
No.	No.	PARTS NAME	DESCRIPTION	No.	No.	PARTS NAME	DESCRIPTION
TUBES							
V 271	255P952O10	CRT ASSY	M78JUA060X11 [31203,31203C,31303,31303C]	Q 303	260P559O30	TRANSISTOR	2SC1740S-S
V 271	255P949O10	CRT ASSY	A89KPP50X03[35303]	Q 304	260P559O30	TRANSISTOR	2SC1740S-S
V 271	251P754O10	CRT ASSY	M89KZP411X[35304]	Q 306	260P560O40	TRANSISTOR	2SA933S-S
V 271	255B835O04	CRT ASSY	[35304]	Q 311	260P817O30	CHIP TRANSISTOR	2SA1037K-S
INTEGRATED CIRCUITS							
IC201	270P190O10	IC	AN5306NFBS	Q 312	260P818O30	CHIP TRANSISTOR	2SC2412KS
IC202	272P937O20	IC	CXA1545AS	Q 313	260P818O30	CHIP TRANSISTOR	2SC2412KS
IC301	272P140O10	IC	LA4270	Q 3A0	260P818O30	CHIP TRANSISTOR	2SC2412KS
IC302	272P942O10	IC	TA8776N	Q 3A1	260P818O30	CHIP TRANSISTOR	2SC2412KS
IC3A0	270P188O10	IC	μPC1852ACT	Q 502	260P420O20	TRANSISTOR	2SC2073-B,C
IC401	272P949O10	IC	TA8427K	Q 503	260P560O40	TRANSISTOR	2SA933S-S
IC501	272P486O10	IC	μPC78M09H	Q 505	260P559O10	TRANSISTOR	2SC1740S-Q
IC502	266P922O10	IC	μPC78M05H	Q 506	260P325O30	TRANSISTOR	2SC2655-Y
IC503	272P786O10	IC	μPC24M12HF	Q 510	260P560O40	TRANSISTOR	2SA933S-S
IC700	274P557O10	IC	M37266ME-A60SP [except 31303C]	Q 520	260P560O40	TRANSISTOR	2SA933S-S
IC700	274P557O30	IC	M37266ME-A62SP[31303C]	Q 521	260P559O30	TRANSISTOR	2SC1740S-S
IC701	263D002O10	IC	24C02A	Q 522	260P559O30	TRANSISTOR	2SC1740S-S
IC702	266P130O30	IC	PST520E	Q 531	260P325O30	TRANSISTOR	2SC2655-Y
IC7001	270P187O10	IC	M52694P [31303,31303C,35303,35304]	Q 532	260P797O20	TRANSISTOR	2SD2349
IC7002	274P553O10	IC	M65607SP [31303,31303C,35303,35304]	Q 540	260P469O20	TRANSISTOR	2SA1320
IC7003	263P548O10	IC	HM53461ZP-12 [31303,31303C,35303,35304]	Q 560	260P559O50	TRANSISTOR	2SC1740S-E
IC951	267P104O20	IC	STR-D4512 [31203,31203C,31303,31303C]	Q 5A1	260P817O30	CHIP TRANSISTOR	2SA1037K-S
IC952	272P603O10	IC	NUM78L05A	Q 5300	260P664O30	TRANSISTOR	2SC4636[35303,35304]
IC953	266P931O10	IC	L78M09	Q 5301	260P664O30	TRANSISTOR	2SC4636[35303,35304]
IC954	272P601O10	IC	LM78M05CT [31303,31303C,35303,35304]	Q 5302	260P338O50	TRANSISTOR	2SC2603-G[35303,35304]
IC9A1	266P934O20	IC	μPC7812H [31203,31203C,31303,31303C]	Q 5303	260P254O10	TRANSISTOR	2SA1175-E[35303,35304]
IC9010	267P112O10	IC	STR-M6511[35303,35304]	Q 5304	260P338O60	TRANSISTOR	2SC2603-F,G[35303,35304]
IC9500	267P062O10	IC	SE130N[35303,35304]	Q 601	260P818O30	CHIP TRANSISTOR	2SC2412KS
IC9510	266P934O20	IC	μPC7812H[35303,35304]	Q 602	260P818O30	CHIP TRANSISTOR	2SC2412KS
TRANSISTORS							
Q 101	260P560O40	TRANSISTOR	2SA933S-S	Q 611	260P817O30	CHIP TRANSISTOR	2SA1037K-S
Q 102	260P560O40	TRANSISTOR	2SA933S-S	Q 651	260P571O10	TRANSISTOR	2SC3789-D,E
Q 103	260P559O30	TRANSISTOR	2SC1740S-S	Q 652	260P571O10	TRANSISTOR	2SC3789-D,E
Q 104	260P560O40	TRANSISTOR	2SA933S-S	Q 653	260P571O10	TRANSISTOR	2SC3789-D,E
Q 201	260P818O30	CHIP TRANSISTOR	2SC2412KS	Q 654	260P559O30	TRANSISTOR	2SC1740S-S
Q 202	260P818O30	CHIP TRANSISTOR	2SC2412KS	Q 655	260P559O30	TRANSISTOR	2SC1740S-S
Q 203	260P818O30	CHIP TRANSISTOR	2SC2412KS	Q 656	260P559O30	TRANSISTOR	2SC1740S-S
Q 204	260P582O10	TRANSISTOR	2SK656	Q 703	260P521O10	TRANSISTOR	2SC2878-B
Q 206	260P818O30	CHIP TRANSISTOR	2SC2412KS	Q 704	260P559O30	TRANSISTOR	2SC1740S-S
Q 207	260P818O30	CHIP TRANSISTOR	2SC2412KS	Q 707	260P559O30	TRANSISTOR	2SC1740S-S
Q 208	260P817O30	CHIP TRANSISTOR	2SA1037K-S	Q 7A0	260P559O30	TRANSISTOR	2SC1740S-S
Q 211	260P416O30	TRANSISTOR	2SC2274-F	Q 7A5	260P559O30	TRANSISTOR	2SC1740S-S
Q 212	260P818O30	CHIP TRANSISTOR	2SC2412KS	Q 7A6	260P559O30	TRANSISTOR	2SC1740S-S
Q 213	260P817O30	CHIP TRANSISTOR	2SA1037K-S	Q 7001	260P560O40	TRANSISTOR	2SA933S-S
Q 301	260P632O10	TRANSISTOR	DTC124ES	Q 7002	260P560O40	TRANSISTOR	2SA933S-S
Q 302	260P559O30	TRANSISTOR	2SC1740S-S	Q 7003	260P560O40	TRANSISTOR	2SA933S-S
				Q 7004	260P560O40	TRANSISTOR	2SA933S-S
				Q 7007	260P559O30	TRANSISTOR	2SC1740S-S
				Q 8001	260P573O20	TRANSISTOR	2SB940A-P
				Q 8002	260P574O20	TRANSISTOR	2SD1264A-P
				Q 8003	260P559O50	TRANSISTOR	2SC1740S-E
				Q 8004	260P560O40	TRANSISTOR	2SA933S-S
				Q 8005	260P559O50	TRANSISTOR	2SC1740S-E
				Q 8006	260P560O40	TRANSISTOR	2SA933S-S
				Q 8007	260P560O40	TRANSISTOR	2SA933S-S

SYMBOL No.	PARTS No.	PARTS NAME	DESCRIPTION	SYMBOL No.	PARTS No.	PARTS NAME	DESCRIPTION
Q 8011	260P559030	TRANSISTOR	2SC1740S-S	D 5301	264P045040	DIODE	1S2471OM[35303,35304]
Q 951	260P325030	TRANSISTOR	2SC2655-Y [31203,31203C,31303,31303C]	D 5302	264P488020	DIODE	RD13FB1[35303,35304]
Q 952	260P560040	TRANSISTOR	2SA933S-S	D 5305	264P045040	DIODE	1S2471OM[35303,35304]
Q 953	260P416030	TRANSISTOR	2SC2274-F	D 5306	264P528030	DIODE	RP 1H[35303,35304]
Q 954	260P560040	TRANSISTOR	2SA933S-S[35303,35304]	D 5307	264P528030	DIODE	RP 1H[35303,35304]
Q 9010	260P422010	TRANSISTOR	2SC2482[35303,35304]	D 5310	264P543010	DIODE	EG01[35303,35304]
Q 9020	260P560040	TRANSISTOR	2SA933S-S[35303,35304]	D 5311	264P045040	DIODE	1S2471OM[35303,35304]
Q 9030	260P560040	TRANSISTOR	2SA933S-S[35303,35304]	D 5312	264P045040	DIODE	1S2471OM[35303,35304]
Q 9040	260P422010	TRANSISTOR	2SC2482[35303,35304]	D 601	264P485060	DIODE	RD7.5FB2
Q 9500	260P559050	TRANSISTOR	2SC1740S-E[35303,35304]	D 606	264P045040	DIODE	1S2471OM
Q 9510	260P560040	TRANSISTOR	2SA933S-S[35303,35304]	D 607	264P045040	DIODE	1S2471OM
DIODES				D 608	264P045040	DIODE	1S2471OM
D 101	264P470040	DIODE	RD33EB1	D 609	264P825010	DIODE	ERA15-02
D 201	264P485060	DIODE	RD7.5FB2	D 612	264P045040	DIODE	1S2471OM
D 202	264P485060	DIODE	RD7.5FB2	D 700	264P485060	DIODE	RD7.5FB2
D 207	264P485060	DIODE	RD7.5FB2	D 701	264P485060	DIODE	RD7.5FB2
D 211	264P045040	DIODE	1S2471OM	D 702	264P485060	DIODE	RD7.5FB2
D 301	264P045040	DIODE	1S2471OM	D 703	264P485060	DIODE	RD7.5FB2
D 302	264P045040	DIODE	1S2471OM	D 704	264P485060	DIODE	RD7.5FB2
D 303	264P045040	DIODE	1S2471OM	D 705	264P485060	DIODE	RD7.5FB2
D 304	264P045040	DIODE	1S2471OM	D 706	264P485060	DIODE	RD7.5FB2
D 305	264P045040	DIODE	1S2471OM	D 707	264P485060	DIODE	RD7.5FB2
D 312	264P045040	DIODE	1S2471OM	D 708	264P485060	DIODE	RD7.5FB2
D 313	264P825010	DIODE	ERA15-02	D 709	264P484020	DIODE	RD5.6FB1
D 420	264P045040	DIODE	1S2471OM	D 710	264P484020	DIODE	RD5.6FB1
D 443	264D056020	DIODE	ERB12-02RK	D 711	264P485060	DIODE	RD7.5FB2
D 457	264D056020	DIODE	ERB12-02RK	D 717	264P485060	DIODE	RD7.5FB2
D 466	264P825010	DIODE	ERA15-02	D 718	264P485060	DIODE	RD7.5FB2
D 503	264P825010	DIODE	ERA15-02	D 719	264P485060	DIODE	RD7.5FB2
D 525	264P488040	DIODE	RD13FB3 [31203,31203C,31303,31303C]	D 720	264P485060	DIODE	RD7.5FB2
D 525	264P486060	DIODE	RD9.1FB3[35303,35304]	D 721	264P485060	DIODE	RD7.5FB2
D 526	264P045040	DIODE	1S2471OM	D 722	264P485060	DIODE	RD7.5FB2
D 531	264P295020	DIODE	ES 1C	D 724	264P045040	DIODE	1S2471OM
D 532	264P358040	DIODE	RU 4A [31203,31203C,31303,31303C]	D 725	264P045040	DIODE	1S2471OM
D 537	264P533030	DIODE	RS 4FS	D 726	264P825010	DIODE	ERA15-02
D 538	264P358070	DIODE	RU 4AM	D 727	264P825010	DIODE	ERA15-02
D 540	264P295020	DIODE	ES 1C [31203,31203C,31303,31303C]	D 728	264P825010	DIODE	ERA15-02
D 541	264D056020	DIODE	ERB12-02RK	D 729	264P825010	DIODE	ERA15-02
D 545	264P045040	DIODE	1S2471OM	D 730	264P825010	DIODE	ERA15-02
D 550	264P295020	DIODE	ES 1C	D 738	264P825010	DIODE	ERA15-02
D 551	264D056020	DIODE	ERB12-02RK	D 744	264P485060	DIODE	RD7.5FB2
D 554	264P295020	DIODE	ES 1C	D 745	264P485060	DIODE	RD7.5FB2
D 560	264P492040	DIODE	RD33FB3	D 746	264P485060	DIODE	RD7.5FB2
D 563	264P102020	DIODE	RU 3B [31203,31203C,31303,31303C]	D 747	264P485060	DIODE	RD7.5FB2
D 580	264P244020	DIODE	HZT33-10	D 748	264P485060	DIODE	RD7.5FB2
D 5A1	264P484070	DIODE	RD6.2FB2	D 750	264P485060	DIODE	RD7.5FB2
D 5A2	264P502020	DIODE	HZ5BLL	D 751	264P485060	DIODE	RD7.5FB2
D 5A3	264P502020	DIODE	HZ5BLL	D 7A0	264P485060	DIODE	RD7.5FB2
D 5A4	264P425010	DIODE	ISS88	D 7A1	264P485060	DIODE	RD7.5FB2
D 5A5	264P825010	DIODE	ERA15-02	D 7A2	264P045040	DIODE	1S2471OM
D 5A6	264P045040	DIODE	1S2471OM	D 7A3	264P045040	DIODE	1S2471OM
D 5300	264P045040	DIODE	1S2471OM[35303,35304]	D 7A4	264P485060	DIODE	RD7.5FB2
				D 7001	264P045040	DIODE	1S2471OM [31303,31303C,35303,35304]
				D 7002	264P045040	DIODE	1S2471OM [31303,31303C,35303,35304]

SYMBOL No.	PARTS No.	PARTS NAME	DESCRIPTION	SYMBOL No.	PARTS No.	PARTS NAME	DESCRIPTION
D 7600	264P225O20	LIGHT EMITTING DIODE	LN35GP[except 35304]	D 9620	264P045O40	DIODE	1S2471OM[35303,35304]
D 7600	264P203O20	LIGHT EMITTING DIODE	TLG124A-E[35304]	OTHER SEMICONDUCTORS			
D 7601	264P488O20	DIODE	RD13FB1[35303,35304]	RP9A1	265P071O40	POSITIVE THERMISTOR	<C5ROM> [31203,31203C,31303,31303C]
D 8001	264P045O40	DIODE	1S2471OM	RP9010	265P071O40	POSITIVE THERMISTOR	<C5ROM>[35303,35304]
D 8002	264P045O40	DIODE	1S2471OM	FILTERS			
D 8003	264D056O20	DIODE	ERB12-02RK	CF5A1	299P154O20	CERAMIC RESONATOR	CSB503F38
D 8004	264D056O20	DIODE	ERB12-02RK	DELAY LINES			
D 8005	264P045O40	DIODE	1S2471OM	DL201	337P142O50	DELAY LINE	
D 8006	264P045O40	DIODE	1S2471OM	DL202	337P096O70	DELAY LINE	
D 8007	264P045O40	DIODE	1S2471OM	COILS			
D 8011	264P295O20	DIODE	ES 1C [31203,31203C,31303,31303C]	L 101	325C120O90	PEAKING COIL	4.7μH-K
D 951	264P147O10	DIODE	RM 2C [31203,31203C,31303,31303C]	L 102	325C112O50	PEAKING COIL	100μH-K
D 952	264P147O10	DIODE	RM 2C [31203,31203C,31303,31303C]	L 103	321C010O80	RF COIL	2200μH-J
D 953	264P295O20	DIODE	ES 1C [31203,31203C,31303,31303C]	L 105	321C031O40	RF COIL	10μH-K
D 954	264P295O20	DIODE	ES 1C [31203,31203C,31303,31303C]	L 201	325C261O30	PEAKING COIL	10μH-K
D 955	264P295O40	DIODE	ES 1A [31203,31203C,31303,31303C]	L 202	325C261O30	PEAKING COIL	10μH-K
D 956	264P358O70	DIODE	RU 4AM [31203,31203C,31303,31303C]	L 203	325C261O50	PEAKING COIL	15μH-K SO
D 959	264P102O40	DIODE	RU 3M [31203,31203C,31303,31303C]	L 204	321C011O40	RF COIL	6800μH-J
D 960	264P102O20	DIODE	RU 3B [31203,31203C,31303,31303C]	L 451	321C130O10	RF COIL	2.0MH +15%
D 967	264P825O10	DIODE	ERA15-02	L 510	409P006O80	FILTER COIL	6800μH-J
D 968	264P825O10	DIODE	ERA15-02	L 512	333P028O10	H-LIN.COIL	[except 35303]
D 970	264P045O40	DIODE	1S2471OM	L 512	333P028O40	H-LIN.COIL	[35303]
D 971	264P825O10	DIODE	ERA15-02[35303,35304]	L 530	335P012O10	CHOKE COIL	250MHz
D 972	264D056O20	DIODE	ERB12-02RK [31203,31203C,31303,31303C]	L 553	411D009O20	FERRITE CORE FILTER	180μH-K
D 974	264P045O40	DIODE	1S2471OM	L 570	409P509O10	FILTER COIL	[31203,31203C,31303,31303C]
D 978	264P825O10	DIODE	ERA15-02	L 5300	409P006O80	FILTER COIL	6800μH-J[35303,35304]
D 9A1	264P508O10	DIODE	S1WB(A)10 [31203,31203C,31303,31303C]	L 601	325C101O30	PEAKING COIL	10μH-K
D 9A3	264D056O20	DIODE	ERB12-02RK [31203,31203C,31303,31303C]	L 651	325C302O30	PEAKING COIL	68μH-K
D 9A4	264D056O20	DIODE	ERB12-02RK [31203,31203C,31303,31303C]	L 652	325C302O30	PEAKING COIL	68μH-K
D 9010	264P535O10	DIODE	RBV-608[35303,35304]	L 653	325C302O30	PEAKING COIL	68μH-K
D 9020	264P622O10	DIODE	AL01Z[35303,35304]	L 654	325C301O80	PEAKING COIL	27μH-K
D 9030	264P101O50	DIODE	RM 1B[35303,35304]	L 655	325C301O80	PEAKING COIL	27μH-K
D 9040	264P622O10	DIODE	AL01Z[35303,35304]	L 656	325C301O80	PEAKING COIL	27μH-K
D 9050	264P622O10	DIODE	AL01Z[35303,35304]	L 657	325C111O50	PEAKING COIL	15μH-K
D 9060	264P488O20	DIODE	RD13FB1[35303,35304]	L 700	325C121O30	PEAKING COIL	10μH-K
D 9070	264P102O20	DIODE	RU 3B[35303,35304]	L 7A0	325C121O30	PEAKING COIL	10μH-K
D 9080	264P457O50	DIODE	RD3.0EB1[35303,35304]	L 7A1	325C121O30	PEAKING COIL	10μH-K
D 9090	264P622O10	DIODE	AL01Z[35303,35304]	L 7A2	325C120O70	PEAKING COIL	3.3μH-K[35303,35304]
D 9500	264P508O10	DIODE	S1WB(A)10[35303,35304]	L 7F1	325C121O30	PEAKING COIL	10μH-K
D 9540	264P825O10	DIODE	ERA15-02[35303,35304]	L 7001	325C121O30	PEAKING COIL	10μH-K
D 9550	264P588O10	DIODE	FML-G16S[35303,35304]	L 7002	325C121O30	PEAKING COIL	[31303,31303C,35303,35304]
D 9560	264P578O10	DIODE	RG 2A[35303,35304]	L 7003	325C121O30	PEAKING COIL	[31303,31303C,35303,35304]
D 9570	264P566O10	DIODE	FMP-G12S[35303,35304]	L 7004	325C121O30	PEAKING COIL	10μH-K
D 9580	264P566O10	DIODE	FMP-G12S[35303,35304]				[31303,31303C,35303,35304]
D 9600	264P045O40	DIODE	1S2471OM[35303,35304]				
D 9610	264P045O40	DIODE	1S2471OM[35303,35304]				

[31203] : CS-31203 [31203C] : CS-31203C [31303] : CS-31303 [31303C] : CS-31303C [35303] : CS-35303 [35304] : CK-35304							
SYMBOL No.	PARTS No.	PARTS NAME	DESCRIPTION	SYMBOL No.	PARTS No.	PARTS NAME	DESCRIPTION
L 7006	325C121030	PEAKING COIL	10μH-K [31303,31303C,35303,35304]	R 207	103P403060	CHIP RESISTOR	1/10W 8.2KΩ-J
L 7600	325C121030	PEAKING COIL	10μH-K	R 208	103P404030	CHIP RESISTOR	1/10W 33KΩ-J
L 7601	325C121030	PEAKING COIL	10μH-K	R 209	103P401030	CHIP RESISTOR	1/10W 100Ω-J
L 7602	325C121030	PEAKING COIL	10μH-K[35303,35304]	R 210	103P402060	CHIP RESISTOR	1/10W 1.2KΩ-J
L 7603	325C121030	PEAKING COIL	10μH-K [31203,31203C,31303,31303C]	R 212	103P402050	CHIP RESISTOR	1/10W 1KΩ-J
L 8001	411D009020	FERRITE CORE FILTER		R 213	103P401070	CHIP RESISTOR	1/10W 220Ω-J
L 8002	325C121090	PEAKING COIL	33μH-K	R 214	103P405020	CHIP RESISTOR	1/10W 180KΩ-J
L 951	351P069010	FILTER COIL	SBC-9-680-152 [31203,31203C,31303,31303C]	R 215	103P406010	CHIP RESISTOR	1/10W 1MΩ-J
L 9A1	351P090010	LINE FILTER	[31203,31203C,31303,31303C]	R 216	103P404060	CHIP RESISTOR	1/10W 56KΩ-J
L 9A2	351P090010	LINE FILTER	[31203,31203C,31303,31303C]	R 217	103P403000	CHIP RESISTOR	1/10W 2.7KΩ-J
L 9010	351P090010	LINE FILTER	[35303,35304]	R 218	103P403060	CHIP RESISTOR	1/10W 8.2KΩ-J
L 9020	351P090010	LINE FILTER	[35303,35304]	R 221	103P402010	CHIP RESISTOR	1/10W 470Ω-J
L 9030	411P012030	BEAD FERRITE	[35303,35304]	R 223	103P401030	CHIP RESISTOR	1/10W 100Ω-J
L 9040	411P011010	BEAD FERRITE	ZBF503S-P[35303,35304]	R 231	103P409090	CHIP RESISTOR	1/10W 75Ω-J
L 9050	411D009020	FERRITE CORE FILTER	[35303,35304]	R 232	103P409090	CHIP RESISTOR	1/10W 75Ω-J
L 9500	321D019010	RF COIL	0.47μH-K[35303,35304]	R 234	103P403070	CHIP RESISTOR	1/10W 10KΩ-J
L 9510	409P674020	FILTER COIL	[35303,35304]	R 241	103P401030	CHIP RESISTOR	1/10W 100Ω-J
L 9520	321C131060	RF COIL	33MH +7.5%[35303,35304]	R 242	103P401030	CHIP RESISTOR	1/10W 100Ω-J
L 9530	409P794010	FILTER COIL	33MH +20%[35303,35304]	R 243	103P401030	CHIP RESISTOR	1/10W 100Ω-J [31303,31303C,35303,35304]
L 9540	409P674020	FILTER COIL	[35303,35304]	R 245	103P401070	CHIP RESISTOR	1/10W 220Ω-J
L 9550	411P001040	LEAD FERRITE	[35303,35304]	R 247	103P409090	CHIP RESISTOR	1/10W 75Ω-J
LC7001	409P402030	EMI FILTER	FZ103N100 [31303,31303C,35303,35304]	R 254	103P401030	CHIP RESISTOR	1/10W 100Ω-J[35303,35304]
LC7002	409P402010	EMI FILTER	B101M100 [31303,31303C,35303,35304]	R 255	103P401030	CHIP RESISTOR	1/10W 100Ω-J
LC7003	409P402010	EMI FILTER	B101M100 [31303,31303C,35303,35304]	R 256	103P401030	CHIP RESISTOR	1/10W 100Ω-J
LC7004	409P402010	EMI FILTER	B101M100 [31303,31303C,35303,35304]	R 263	103P404060	CHIP RESISTOR	1/10W 56KΩ-J
LC7005	409P402010	EMI FILTER	B101M100 [31303,31303C,35303,35304]	R 264	103P404020	CHIP RESISTOR	1/10W 27KΩ-J
LC7006	409P402010	EMI FILTER	B101M100 [31303,31303C,35303,35304]	R 265	103P401030	CHIP RESISTOR	1/10W 100Ω-J
TRANSFORMERS				R 266	103P403010	CHIP RESISTOR	1/10W 3.3KΩ-J
BF601	349P159070	CHROMA-BP		R 267	103P401080	CHIP RESISTOR	1/10W 270Ω-J
T 531	336P012040	H.DRIVE	TH7131T	R 268	103P401090	CHIP RESISTOR	1/10W 330Ω-J
T 551	334D100005	FLYBACK	(334P231010+) [31203,31203C,31303,31303C]	R 269	103P400090	CHIP RESISTOR	1/10W 47Ω-J
T 551	334P214090	FLYBACK	[35303]	R 270	103P405040	CHIP RESISTOR	1/10W 270KΩ-J
T 551	334P214010	FLYBACK	[35304]	R 271	103P403070	CHIP RESISTOR	1/10W 10KΩ-J
T 552	349P122050	SIDE PCC	[35303,35304]	R 272	103P401030	CHIP RESISTOR	1/10W 100Ω-J
T 951	350P608020	POWER	[31203,31203C,31303,31303C]	R 273	103P402090	CHIP RESISTOR	1/10W 2.2KΩ-J
T 9A1	350P417060	POWER	[31203,31203C,31303,31303C]	R 274	103P404020	CHIP RESISTOR	1/10W 27KΩ-J
T 9010	350P504060	POWER	[35303,35304]	R 275	103P405060	CHIP RESISTOR	1/10W 390KΩ-J
T 9020	350P417060	POWER	[35303,35304]	R 276	103P401070	CHIP RESISTOR	1/10W 220Ω-J
VARIABLE RESISTORS				R 277	103P402010	CHIP RESISTOR	1/10W 470Ω-J
VR	129P064010	VR-FOCUS	MHF111-09[35303]	R 278	103P401030	CHIP RESISTOR	1/10W 100Ω-J
RESISTORS				R 279	103P403030	CHIP RESISTOR	1/10W 4.7KΩ-J
R 201	103P401030	CHIP RESISTOR	1/10W 100Ω-J	R 280	103P405070	CHIP RESISTOR	1/10W 470KΩ-J
R 202	103P402050	CHIP RESISTOR	1/10W 1KΩ-J	R 281	103P404020	CHIP RESISTOR	1/10W 27KΩ-J
R 203	103P402050	CHIP RESISTOR	1/10W 1KΩ-J	R 322	103P404050	CHIP RESISTOR	1/10W 47KΩ-J
R 204	103P402050	CHIP RESISTOR	1/10W 1KΩ-J	R 323	103P404010	CHIP RESISTOR	1/10W 22KΩ-J
R 206	103P402050	CHIP RESISTOR	1/10W 1KΩ-J	R 324	103P403070	CHIP RESISTOR	1/10W 10KΩ-J
R 207	103P403060	CHIP RESISTOR	1/10W 8.2KΩ-J	R 325	103P404090	CHIP RESISTOR	1/10W 100KΩ-J
R 208	103P404030	CHIP RESISTOR	1/10W 33KΩ-J	R 326	103P403070	CHIP RESISTOR	1/10W 10KΩ-J
R 209	103P401030	CHIP RESISTOR	1/10W 100Ω-J	R 327	103P404090	CHIP RESISTOR	1/10W 100KΩ-J
R 210	103P402060	CHIP RESISTOR	1/10W 1.2KΩ-J	R 331	103P409050	CHIP RESISTOR	1/10W 0Ω
R 212	103P402050	CHIP RESISTOR	1/10W 1KΩ-J	R 332	103P409050	CHIP RESISTOR	1/10W 0Ω
R 213	103P401070	CHIP RESISTOR	1/10W 220Ω-J	R 333	103P405060	CHIP RESISTOR	1/10W 390KΩ-J
R 214	103P405020	CHIP RESISTOR	1/10W 180KΩ-J	R 334	103P402050	CHIP RESISTOR	1/10W 1KΩ-J
R 215	103P406010	CHIP RESISTOR	1/10W 1MΩ-J	R 337	103P409050	CHIP RESISTOR	1/10W 0Ω[35303,35304]
R 216	103P404060	CHIP RESISTOR	1/10W 56KΩ-J	R 338	103P402050	CHIP RESISTOR	1/10W 1KΩ-J
R 217	103P403000	CHIP RESISTOR	1/10W 2.7KΩ-J				

SYMBOL No.	PARTS No.	PARTS NAME	DESCRIPTION	SYMBOL No.	PARTS No.	PARTS NAME	DESCRIPTION
R 351	103P402090	CHIP RESISTOR	1/10W 2.2KΩ-J	R 5B5	103P404000	CHIP RESISTOR	1/10W 18KΩ-J
R 352	103P402080	CHIP RESISTOR	1/10W 1.8KΩ-J	R 5B6	103P403010	CHIP RESISTOR	1/10W 3.3KΩ-J
R 353	103P401030	CHIP RESISTOR	1/10W 100Ω-J	R 5B7	103P401030	CHIP RESISTOR	1/10W 100Ω-J
R 354	103P401030	CHIP RESISTOR	1/10W 100Ω-J	R 5B8	103P401030	CHIP RESISTOR	1/10W 100Ω-J
R 355	103P409050	CHIP RESISTOR	1/10W 0Ω	R 5B9	103P406010	CHIP RESISTOR	1/10W 1MΩ-J
R 361	103P402050	CHIP RESISTOR	1/10W 1KΩ-J	R 5C1	103P403070	CHIP RESISTOR	1/10W 10KΩ-J
R 362	103P402050	CHIP RESISTOR	1/10W 1KΩ-J	R 5C3	103P403060	CHIP RESISTOR	1/10W 8.2KΩ-J
R 367	103P402050	CHIP RESISTOR	1/10W 1KΩ-J	R 5C4	103P402090	CHIP RESISTOR	1/10W 2.2KΩ-J
R 368	103P402050	CHIP RESISTOR	1/10W 1KΩ-J	R 5C7	103P405010	CHIP RESISTOR	1/10W 150KΩ-J
R 369	103P402050	CHIP RESISTOR	1/10W 1KΩ-J	R 5338	103P371000	FUSE	1/4W 56Ω-J[35303,35304]
R 370	103P402050	CHIP RESISTOR	1/10W 1KΩ-J	R 5352	103P398080	FUSE	1/2W 4.7Ω-J[35303,35304]
R 371	103P401030	CHIP RESISTOR	1/10W 100Ω-J[35303,35304]	R 5355	103P392050	FUSE	1/2W 1KΩ-J[35303,35304]
R 372	103P401030	CHIP RESISTOR	1/10W 100Ω-J[35303,35304]	R 5356	103P392020	FUSE	1/2W 56Ω-J[35303,35304]
R 373	103P405040	CHIP RESISTOR	1/10W 270KΩ-J	R 601	103P401090	CHIP RESISTOR	1/10W 330Ω-J
R 374	103P405040	CHIP RESISTOR	1/10W 270KΩ-J	R 602	103P401090	CHIP RESISTOR	1/10W 330Ω-J
R 377	103P404090	CHIP RESISTOR	1/10W 100KΩ-J	R 603	103P401090	CHIP RESISTOR	1/10W 330Ω-J
R 378	103P404090	CHIP RESISTOR	1/10W 100KΩ-J	R 604	103P402080	CHIP RESISTOR	1/10W 1.8KΩ-J
R 3A0	103P402050	CHIP RESISTOR	1/10W 1KΩ-J	R 605	103P402080	CHIP RESISTOR	1/10W 1.8KΩ-J
R 3A1	103P404070	CHIP RESISTOR	1/10W 68KΩ-J	R 606	103P402080	CHIP RESISTOR	1/10W 1.8KΩ-J
R 3A2	103P401030	CHIP RESISTOR	1/10W 100Ω-J	R 607	103P402070	CHIP RESISTOR	1/10W 1.5KΩ-J
R 3A3	103P401030	CHIP RESISTOR	1/10W 100Ω-J	R 608	103P402050	CHIP RESISTOR	1/10W 1KΩ-J
R 3A4	103P473060	CHIP RESISTOR	1/10W 3K-F	R 609	103P401090	CHIP RESISTOR	1/10W 330Ω-J
R 3A5	103P474020	CHIP RESISTOR	1/10W 5.1K-F	R 610	103P401090	CHIP RESISTOR	1/10W 330Ω-J
R 3A6	103P475030	CHIP RESISTOR	1/10W 15K-F	R 611	103P401090	CHIP RESISTOR	1/10W 330Ω-J
R 3A7	103P402050	CHIP RESISTOR	1/10W 1KΩ-J	R 612	103P402090	CHIP RESISTOR	1/10W 2.2KΩ-J
R 3A8	103P402050	CHIP RESISTOR	1/10W 1KΩ-J	R 613	103P402090	CHIP RESISTOR	1/10W 2.2KΩ-J
R 3A9	103P402050	CHIP RESISTOR	1/10W 1KΩ-J	R 614	103P402090	CHIP RESISTOR	1/10W 2.2KΩ-J
R 3B0	103P402050	CHIP RESISTOR	1/10W 1KΩ-J[except 31303]	R 615	103P403010	CHIP RESISTOR	1/10W 3.3KΩ-J
R 3B1	103P473000	CHIP RESISTOR	1/10W 1.6K-F	R 616	103P403010	CHIP RESISTOR	1/10W 3.3KΩ-J
R 3B2	103P403070	CHIP RESISTOR	1/10W 10KΩ-J	R 617	103P404010	CHIP RESISTOR	1/10W 22KΩ-J
R 3B3	103P403070	CHIP RESISTOR	1/10W 10KΩ-J	R 618	103P404010	CHIP RESISTOR	1/10W 22KΩ-J
R 4A1	103P401030	CHIP RESISTOR	1/10W 100Ω-J	R 621	103P401070	CHIP RESISTOR	1/10W 220Ω-J
R 4A2	103P405050	CHIP RESISTOR	1/10W 330KΩ-J	R 623	103P402070	CHIP RESISTOR	1/10W 1.5KΩ-J
R 4A3	103P401070	CHIP RESISTOR	1/10W 220Ω-J	R 624	103P409050	CHIP RESISTOR	1/10W 0Ω
R 4A4	103P401070	CHIP RESISTOR	1/10W 220Ω-J	R 631	103P409090	CHIP RESISTOR	1/10W 75Ω-J
R 4A5	103P401070	CHIP RESISTOR	1/10W 220Ω-J	R 634	103P401030	CHIP RESISTOR	1/10W 100Ω-J
R 500	103P398060	FUSE	1/2W 3.3Ω-J	R 635	103P402050	CHIP RESISTOR	1/10W 1KΩ-J
R 536	103P338010	R-CARBON	1/4W 1.2Ω-J	R 636	103P403070	CHIP RESISTOR	1/10W 10KΩ-J
R 538	103P338010	R-CARBON	1/4W 1.2Ω-J	R 640	103P404060	CHIP RESISTOR	1/10W 56KΩ-J
R 540	103P377070	FUSE	1/4W 0.56Ω-K [31203,31203C,31303,31303C]	R 641	103P404020	CHIP RESISTOR	1/10W 27KΩ-J
R 542	103P377070	FUSE	1/4W 0.56Ω-K [31203,31203C,31303,31303C]	R 642	103P402050	CHIP RESISTOR	1/10W 1KΩ-J
R 544	109D067070	CEMENT WIRE	10W 2.7Ω-K	R 643	103P402010	CHIP RESISTOR	1/10W 470Ω-J
R 561	103P451080	FUSE	2W 270Ω-K/J	R 644	103P402090	CHIP RESISTOR	1/10W 2.2KΩ-J
R 570	103P397090	FUSE	1/2W 0.82Ω-J [31203,31203C,31303,31303C]	R 648	103P404010	CHIP RESISTOR	1/10W 22KΩ-J
R 5A2	103P409050	CHIP RESISTOR	1/10W 0Ω	R 649	103P404030	CHIP RESISTOR	1/10W 33KΩ-J
R 5A3	103P401070	CHIP RESISTOR	1/10W 220Ω-J	R 660	103P437060	FUSE METAL	2W 0.47Ω-K/J [31203,31203C,31303,31303C]
R 5A4	103P409050	CHIP RESISTOR	1/10W 0Ω	R 660	103P438020	FUSE METAL	2W 1.5Ω-J[35303]
R 5A5	103P403070	CHIP RESISTOR	1/10W 10KΩ-J	R 660	103P438050	FUSE METAL	2W 2.7Ω-K/J[35304]
R 5A7	103P401030	CHIP RESISTOR	1/10W 100Ω-J	R 661	103P438010	FUSE METAL	2W 1.2Ω-K/J[35303]
R 5A8	103P401030	CHIP RESISTOR	1/10W 100Ω-J	R 712	103P744010	NETWORK	1/8W 22KΩ-JX4
R 5A9	103P403030	CHIP RESISTOR	1/10W 4.7KΩ-J	R 720	103P743050	NETWORK	1/8W 6.8KΩ-JX4 [31203,31203C,31303,31303C]
R 5B1	103P403030	CHIP RESISTOR	1/10W 4.7KΩ-J	R 720	103P744010	NETWORK	1/8W 22KΩ-JX4[35303,35304]
R 5B2	103P401070	CHIP RESISTOR	1/10W 220Ω-J	R 755	103P744010	NETWORK	1/8W 22KΩ-JX4
R 5B3	103P401070	CHIP RESISTOR	1/10W 220Ω-J	R 7024	103P544010	NETWORK	1/8W 22KΩ-JX4 [31303,31303C,35303,35304]
R 5B4	103P404090	CHIP RESISTOR	1/10W 100KΩ-J				

SYMBOL No.	PARTS No.	PARTS NAME	DESCRIPTION	SYMBOL No.	PARTS No.	PARTS NAME	DESCRIPTION
R 8014	103P370010	FUSE	1/4W 10Ω-J	C 640	141P132010	CHIP CAPACITOR	B50V 0.01μF-K
R 8015	103P370050	FUSE	1/4W 22Ω-J	C 950	189P060060	CERAMIC CAPACITOR	E AC250V 2200pF-Z [31203,31203C,31303,31303C]
R 8016	103P370010	FUSE	1/4W 10Ω-J	C 951	189P060060	CERAMIC CAPACITOR	E AC250V 2200pF-Z [31203,31203C,31303,31303C]
R 8045	103P378000	FUSE	1/4W 1.0Ω-J	C 952	185D057060	ELECTROLYTIC-C	180V 820μF-Q [31203,31203C,31303,31303C]
R 975	103P391040	FUSE	1/2W 120Ω-J[35303,35304]	C 953	185D057060	ELECTROLYTIC-C	180V 820μF-Q [31203,31203C,31303,31303C]
R 9A2	109D132050	CEMENT WIRE	20W 2.2Ω-K [31203,31203C,31303,31303C]	C 961	185D058040	ELECTROLYTIC-C	H160V 220μF-M [31203,31203C,31303,31303C]
R 9030	102P107030	WIRE	2W 0.27Ω-K[35303,35304]	C 980	189P033060	C-PP-AC	AC125V 0.01μF-M [31203,31203C,31303,31303C]
R 9040	102P107040	WIRE	2W 0.33Ω-K[35303,35304]	C 981	189P033080	C-PP-AC	AC125 0.022μF-M [31203,31203C,31303,31303C]
R 9050	102P107030	WIRE	2W 0.27Ω-K[35303,35304]	C 9A1	189P033050	C-PP-AC	AC125V 0.1μF-M [31203,31203C,31303,31303C]
R 9060	109D132050	CEMENT WIRE	20W 2.2Ω-K[35303,35304]	C 9A2	189P033050	C-PP-AC	AC125V 0.1μF-M [31203,31203C,31303,31303C]
R 9590	103P397090	FUSE	1/2W 0.82Ω-J[35303,35304]	C 9010	189P033050	C-PP-AC	AC125V 0.1μF-M[35303,35304]
RJ 01	103P409050	CHIP RESISTOR	1/10W 0Ω	C 9020	189P033050	C-PP-AC	AC125V 0.1μF-M[35303,35304]
RJ 03	103P409050	CHIP RESISTOR	1/10W 0Ω[31203,31203C]	C 9030	189P033050	C-PP-AC	AC125V 0.1μF-M[35303,35304]
RJ 04	103P409050	CHIP RESISTOR	1/10W 0Ω	C 9050	189P060060	CERAMIC CAPACITOR	E AC250V 2200pF-Z [35303,35304]
RJ 05	103P409050	CHIP RESISTOR	1/10W 0Ω	C 9060	189P060060	CERAMIC CAPACITOR	E AC250V 2200pF-Z [35303,35304]
RJ 08	103P409050	CHIP RESISTOR	1/10W 0Ω	C 9070	185D057060	ELECTROLYTIC-C	180V 820μF-Q[35303,35304]
RJ 11	103P409050	CHIP RESISTOR	1/10W 0Ω[31203,31203C]	C 9130	189P033060	C-PP-AC	AC125V 0.01μF-M[35303,35304]
RJ 12	103P409050	CHIP RESISTOR	1/10W 0Ω[31203,31203C]	C 9140	189P033080	C-PP-AC	AC125 0.022μF-M[35303,35304]
CAPACITORS AND TRIMMERS				SWITCHES			
C 205	141P132010	CHIP CAPACITOR	B50V 0.01μF-K	S 550	431C059020	SLIDE SWITCH	2-3
C 222	141P132010	CHIP CAPACITOR	B50V 0.01μF-K	S 7600	432P066070	KEY BOARD SWITCH	1-1 L=8.35 T[except 35304]
C 332	141P132010	CHIP CAPACITOR	B50V 0.01μF-K	S 7600	432P100010	KEY BOARD SWITCH	1-1 H=4.3[35304]
C 3A8	141P137080	CHIP CAPACITOR	B25V 0.047M	S 7601	432P066070	KEY BOARD SWITCH	1-1 L=8.35 T[except 35304]
C 3B4	189D058030	C-TANT	16V 3.3μF-K	S 7601	432P100010	KEY BOARD SWITCH	1-1 H=4.3[35304]
C 3B5	189D028010	C-TANT	16V 10μF-K	S 7602	432P066070	KEY BOARD SWITCH	1-1 L=8.35 T[except 35304]
C 453	189D028060	C-TANT	35V 2.2μF-K	S 7602	432P100010	KEY BOARD SWITCH	1-1 H=4.3[35304]
C 544	172P171030	C-M-PP	1600V 0.01μF-J	S 7603	432P066070	KEY BOARD SWITCH	1-1 L=8.35 T[except 35304]
C 545	172P171030	C-M-PP	1600V 0.01μF-J	S 7603	432P100010	KEY BOARD SWITCH	1-1 H=4.3[35304]
C 570	189P077090	C-M-PP	400V 0.18μF-J [31203,31203C,31303,31303C]	S 7604	432P066070	KEY BOARD SWITCH	1-1 L=8.35 T[except 35304]
C 570	189P077020	C-M-PP	400V 0.27μF-J[35303,35304]	S 7604	432P100010	KEY BOARD SWITCH	1-1 H=4.3[35304]
C 571	189P077020	C-M-PP	400V 0.27μF-J[except 35303]	S 7605	432P066070	KEY BOARD SWITCH	1-1 L=8.35 T[except 35304]
C 571	189P077030	C-M-PP	400V 0.33μF-J[35303]	S 7605	432P100010	KEY BOARD SWITCH	1-1 H=4.3[35304]
C 5A1	154P334030	CHIP CAPACITOR	CH50V220pF-J	S 7606	432P066070	KEY BOARD SWITCH	1-1 L=8.35 T[except 35304]
C 5B3	141P131030	CHIP CAPACITOR	B50V 2200pF-K [31203,31203C,31303,31303C]	S 7606	432P100010	KEY BOARD SWITCH	1-1 H=4.3[35304]
C 5B3	141P131060	CHIP CAPACITOR	B50V 3900pF-K[35303,35304]	S 7608	432P066070	KEY BOARD SWITCH	1-1 L=8.35 T[except 35304]
C 5B4	141P131050	CHIP CAPACITOR	B50V 3300pF-K [31203,31203C,31303,31303C]	S 7608	432P100010	KEY BOARD SWITCH	1-1 H=4.3[35304]
C 5B4	141P131080	CHIP CAPACITOR	B50V 5600pF-K[35303,35304]	S 7609	431C092010	SLIDE SWITCH	[35303]
C 5311	172P170050	C-M-PP	1600V 2200pF-J[35303,35304]	S 7609	431C068030	SLIDE SWITCH	2-3 NON-SHORT[35304]
C 601	141P132010	CHIP CAPACITOR	B50V 0.01μF-K	S 7610	431C091010	SLIDE SWITCH	[35303]
C 608	154P322000	CHIP CAPACITOR	SL50V 22pF-J				
C 612	154P331050	CHIP CAPACITOR	CH50V 15pF-J				
C 614	141P132010	CHIP CAPACITOR	B50V 0.01μF-K				
C 616	154P321080	CHIP CAPACITOR	SL50V 18pF-J				
C 617	141P132010	CHIP CAPACITOR	B50V 0.01μF-K				
C 618	141P131030	CHIP CAPACITOR	B50V 2200P-K				
C 620	141P132010	CHIP CAPACITOR	B50V 0.01μF-K				
C 621	154P323080	CHIP CAPACITOR	SL50V 120pF-J				
C 622	141P132010	CHIP CAPACITOR	B50V 0.01μF-K				
C 623	154P323060	CHIP CAPACITOR	SL50V 100pF-J				
C 624	141P132010	CHIP CAPACITOR	B50V 0.01μF-K [31303,31303C,35303,35304]				
C 630	141P132010	CHIP CAPACITOR	B50V 0.01μF-K				

SYMBOL PARTS				SYMBOL PARTS			
No.	No.	PARTS NAME	DESCRIPTION	No.	No.	PARTS NAME	DESCRIPTION
S 7610	431C067010	SLIDE SWITCH	2-2 NON SHORT[35304]	*	920A412011	MAIN PCB ASSY	[35304]
MISCELLANEOUS				*	930C812001	PIP PCB ASSY	[31303,31303C,35303,35304]
	338P030030	CPM ASSY	[35304]	*	930C805015	POWER-SUB PCB ASSY	[31203,31203C]
	641D758010	WEDGE	ELASLEN NF-01[35304]	*	930C805014	POWER-SUB PCB ASSY	[31303,31303C]
AG5000	224D019040	AIR GAP	2KV[35303,35304]	*	930B667012	POWER PCB ASSY	[35303]
F 501	283D035070	FUSE	S2A	*	930B667011	POWER PCB ASSY	[35304]
F 9A1	283D060030	FUSE	S6.3A	*	930C810015	VMCRT PCB ASSY	[31203,31203C]
			[31203,31203C,31303,31303C]	*	930C810014	VMCRT PCB ASSY	[31303,31303C]
				*	930C810012	VMCRT PCB ASSY	[35303]
F 9010	283D060030	FUSE	S6.3A[35303,35304]	*	930C810011	VMCRT PCB ASSY	[35304]
J 201	440C272020	PIN JACK BOARD	6P	MECHANICAL PARTS			
J 202	449C121020	SOCKET DIN MINI	YKF515503	669D220040	SCREW	3X12 46LA005	
J 601	449C081070	SOCKET CRT	[31203,31203C,31303,31303C]	669D221040	SCREW	4X12 46LA005[except 35303]	
J 601	449C123020	SOCKET CRT	[35303]	669D221060	SCREW	4X16 46LA005[except 35304]	
J 601	449C113010	SOCKET CRT	[35304]	669D221030	SCREW	4X10 46LA005[35303]	
K 9A1	287P049010	RELAY POWER	DG12D1-0(M)	669D212010	SCREW	3X12	
			[31203,31203C,31303,31303C]	IC501	669D220030	SCREW	3X10 46LA005
K 9A2	287P049010	RELAY POWER	DG12D1-0(M)	IC502	669D220030	SCREW	3X10 46LA005[35303,35304]
			[31203,31203C,31303,31303C]	IC503	669D220030	SCREW	3X10 46LA005[35303,35304]
K 9010	287P049030	RELAY POWER	DJ12D-0(M)-L[35303,35304]	IC953	669D220030	SCREW	3X10 46LA005
PC552	268P058010	PHOTO COUPLER	ON3131-R	IC954	669D220030	SCREW	3X10 46LA005
PC9010	268P058010	PHOTO COUPLER	ON3131-R[35303,35304]	IC9010	669D171030	SCREW	M3X12[35303,35304]
PC9020	268P058010	PHOTO COUPLER	ON3131-R[35303,35304]	T 551	669D220030	SCREW	3X10 46LA005
RV9A1	265P100010	VARISTOR	ERZV10D271	COSMETIC PARTS			
			[31203,31203C,31303,31303C]	242C957040	AC POWER CORD		
RV9010	265P100010	VARISTOR	ERZV10D271[35303,35304]	960D086020	CABINET ASSY	[35304]	
SP391	480P646050	SPEAKER	5W 8Ω	752C045040	COVER ASSY	[35303]	
			[31203,31203C,31303,31303C]	752C045030	BAFFLE BOARD ASSY	[35303]	
SP391	480P646060	SPEAKER	5W 16Ω[35303]	700C180020	BACK COVER	[31203]	
SP391	480P383060	SPEAKER	15W 8Ω[35304]	700C180030	BACK COVER	[31203C]	
SP392	480P646050	SPEAKER	5W 8Ω	700C179090	BACK COVER	[31303]	
			[31203,31203C,31303,31303C]	700C180010	BACK COVER	[31303C]	
SP392	480P646060	SPEAKER	5W 16Ω[35303]	700C179050	BACK COVER	[35303]	
SP392	480P383060	SPEAKER	15W 8Ω[35304]	700C164070	BACK BOARD	[35304]	
SP393	480P400020	SPEAKER	[35303]	701A457090	FRONT CABINET ASSY	[31203,31303]	
SP394	480P400020	SPEAKER	[35303]	701D100090	FRONT CABINET ASSY	[31203C,31303C]	
TU101	295P420020	TUNER	ENG26102G	701A492080	FRONT CABINET ASSY	[35303]	
X 601	285P029010	CRYSTAL RESONATOR	3.5795MHz[except 31303C]	701A555040	FRONT UNIT	[35304]	
X 601	285P029050	CRYSTAL RESONATOR	3.5795MHz[31303C]	641D173010	CLIP	AC-POWER-CORD[35304]	
X 7A0	285P039020	CRYSTAL RESONATOR	8.00MHz	761B162040	COVER CRT	[35304]	
X 7001	285P069020	CRYSTAL RESONATOR	HC-49/U	752C075030	DOOR	701A457-90(15)	
			[31303,31303C,35303,35304]			[31203,31203C,31303,31303C]	
Z 7600	939P296060	PREAMP UNIT	HC-437ME[except 35304]	752C075010	DOOR	701A492-80(16)[35303]	
Z 7600	939P481030	PREAMP UNIT	HC-477M[35304]	752C075020	DOOR	701A555-40(13)[35304]	
Z 9510	283P039030	FUSE	SSFR 8A[35303,35304]	761C352010	DOOR CATCH		
PRINTED CIRCUIT BOARD ASSYS				761A088010	SPEAKER GRILLE	[35304]	
*	930C822015	AV PCB ASSY	[31203,31203C]	704B058030	KNOB CONTROL	[35303]	
*	930C822014	AV PCB ASSY	[31303,31303C]	704C849010	KNOB KEY BOARD	[35304]	
*	930C822012	AV PCB ASSY	[35303]	704B050040	KNOB PUSH	[31203,31203C,31303,31303C]	
*	930C822011	AV PCB ASSY	[35304]	734D531010	KNOB SLIDE	[35303]	
*	930C589015	CONTROL-2 PCB ASSY	[31203,31203C]	734D459010	KNOB SLIDE	[35304]	
*	930C589014	CONTROL-2 PCB ASSY	[31303,31303C]	761A111010	TERMINAL BOARD		
*	930C590012	CONTROL-3 PCB ASSY	[35303]				
*	930C591011	CONTROL-4 PCB ASSY	[35304]				
*	920D596008	MAIN PCB ASSY	920A412-15+[31203,31203C]				
*	920D596007	MAIN PCB ASSY	920A412-14+[31303,31303C]				
*	920A412012	MAIN PCB ASSY	[35303]				

SYMBOL PARTS				SYMBOL PARTS			
No.	No.	PARTS NAME	DESCRIPTION	No.	No.	PARTS NAME	DESCRIPTION
PACKING PARTS AND ACCESSORY							
803B650010		PACKING CUSHION	[31203,31303]				
803A256010		PACKING CUSHION	[35303]				
871C905090		INSTRUCTION BOOK	[31203]				
871C932030		INSTRUCTION BOOK	ENGLISH/FRENCH[31203C]				
871C906000		INSTRUCTION BOOK	[31303,35303]				
871C932040		INSTRUCTION BOOK	ENGLISH/FRENCH[31303C]				
871C906020		INSTRUCTION BOOK	[35304]				
831C060080		PACKING BAG	[35304]				
802B454010		PACKING CASE	BOTTOM[35304]				
802B454060		PACKING CASE	SLEEVE[35304]				
802A112030		PACKING CASE	[31203]				
802A112040		PACKING CASE	[31303]				
802A112050		PACKING CASE	[35303]				
802B454070		PACKING CASE	[35304]				
802B454040		PACKING CASE	BACK[35304]				
831D191030		PACKING BAG	266.7X381 [31203,31303,35303,35304]				
831D226020		PACKING BAG	1500X1200[31203,31303]				
831D226030		PACKING BAG	[35303]				
829D149010		PACKING SHEET	1423X1016X3[35304]				
829D149020		PACKING SHEET	1423X1016X.[35304]				
290P035030		REMOTE HAND UNIT	[31203,31203C]				
290P035050		REMOTE HAND UNIT	[31303,31303C,35303,35304]				
871B061010		SAFETY TIP CARD	[31203C,31303C]				
OTHER CRITICAL COMPONENTS							
R 305	103P338040	R-CARBON-25	1/4W 2.20-J				
R 306	103P338040	R-CARBON-25	1/4W 2.20-J				
R 5300	109D031010	R-COMPOSITION	1/2W 22K-M[35303,35304]				
R 984	103P338070	R-CARBON-25	1/4W 3.90-J				



[MEMO]

[MEMO]

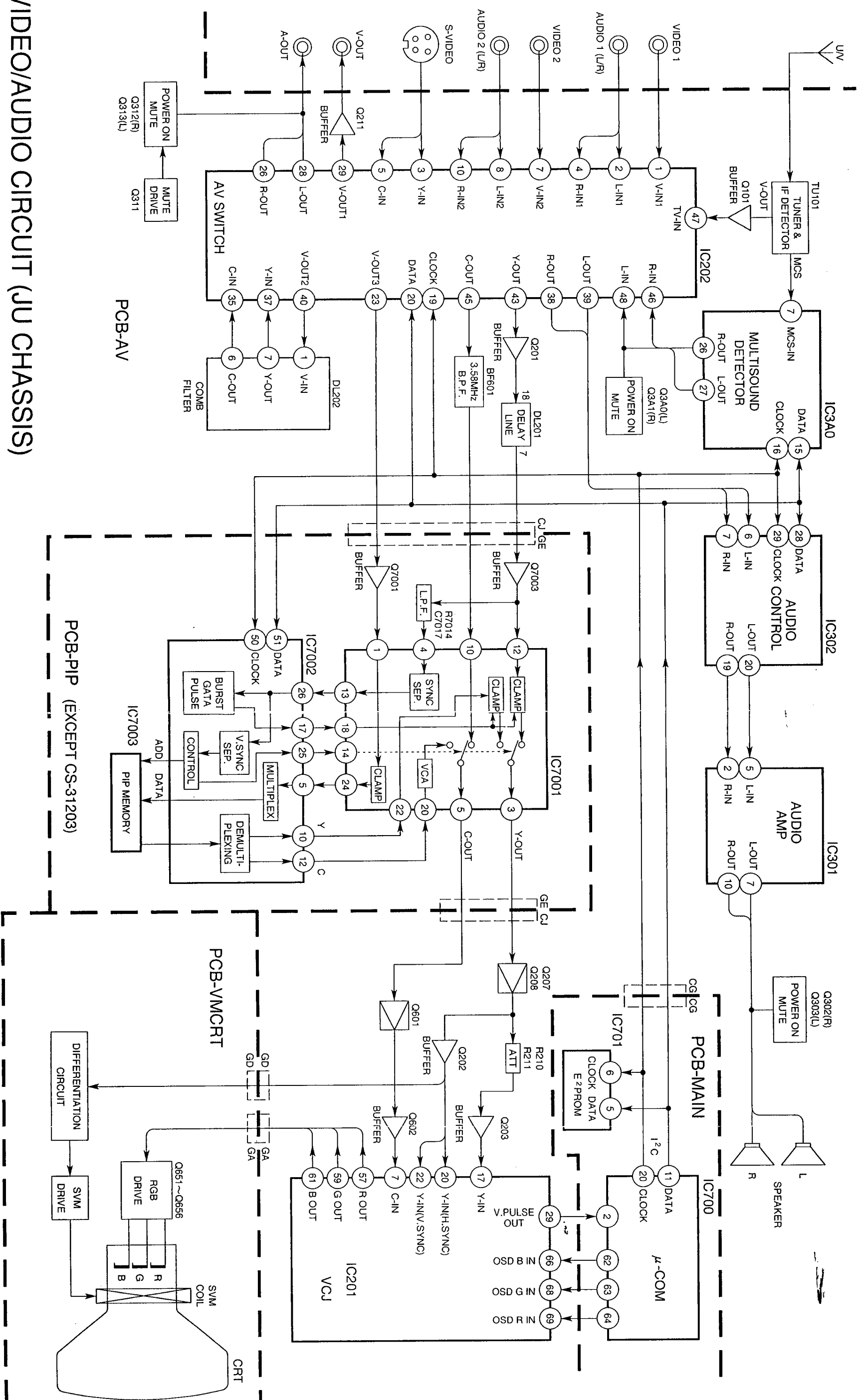

**VIDEO/AUDIO CIRCUIT (JU CHASSIS)**

- CS-27405/CS-27405C/CS-31203/CS-31203C
- CS-31303/CS-31303C/CS-35403/CS-35403C
- CS-35303/CK-35304

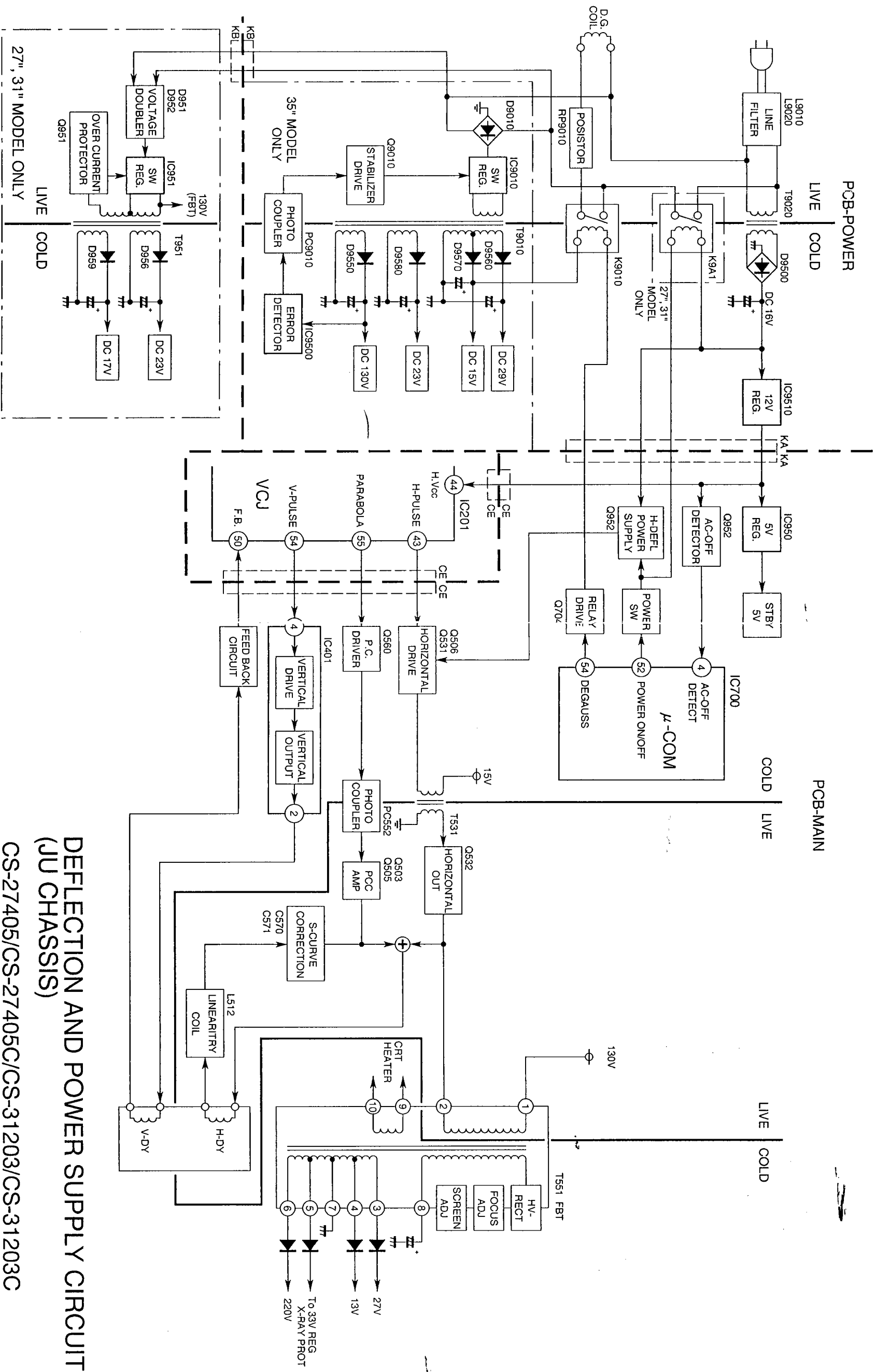

**DEFLECTION AND POWER SUPPLY CIRCUIT**  
(JU CHASSIS)

CS-27405/CS-27405C/CS-31203/CS-31203C  
 CS-31303/CS-31303C/CS-35403/CS-35403C  
 CS-35303/CK-35304