

DENON

Hi-Fi AV Surround Receiver

SERVICE MANUAL

MODEL AVR-800

AV SURROUND RECEIVER



CONTENTS

OPERATING INSTRUCTIONS (U.S.A. & CANADA MODELS)	2-15
OPERATING INSTRUCTIONS (EUROPE MODEL)	16-30
WIRE ARRANGEMENT	32
DISASSEMBLY	33
ADJUSTMENT	34-37
SEMICONDUCTORS	38-45
PRINTED WIRING BOARD	46-48
PRINTED WIRING BOARD PARTS LIST	49-58
BLOCK DIAGRAM	59
WIRING DIAGRAM	60
SCHEMATIC DIAGRAM	61-63
EXPLODED VIEW OF CHASSIS AND CABINET	64
PARTS LIST OF EXPLODED VIEW	64
REMOTE CONTROL UNIT	65
PARTS LIST	65
SCHEMATIC DIAGRAM	65
CORDS TABLE	66

NIPPON COLUMBIA CO., LTD.

**(U.S.A. AND CANADA MODELS.)
SPECIFICATIONS**

- Audio Section** **for North America model**
(Power amplifier) Front (main 2ch driven)
Rated output: 60 W + 60 W (8 ohms, 20 Hz – 20 kHz with 0.08% THD)
 (All properties shown are only for the power amplifier stage.) CENTER (center 1ch driven)
 60 W (8 ohms, 20 Hz – 20 kHz with 0.08% THD)
 REAR (rear 2ch driven)
 15 W + 15 W (8 ohms, 1 kHz with 0.3% THD)

Output terminals: Front: 6 to 16 ohms
 Center: 8 to 16 ohms
 Rear: 8 to 16 ohms

Line input (Each line input – FRONT SP OUT)
Input sensitivity / impedance: 150 mV / 47 k ohms PHONO (MM): 2.5 mV / 47 kohms
Frequency response: 10 Hz to 50 kHz: ±3 dB
Tone control range: BASS: ±10 dB at 100 Hz
 TREBLE: ±10 dB at 10 kHz

Signal-to-noise ratio 92 dB (BYPASS)
Phono equalizer (PHONO input – REC OUT)
RIAA deviation: ±1 dB (20 Hz to 20 kHz)
Signal-to-noise ratio: 74 dB (A weighting, with 5 mV input)
Rated output / Maximum output: 150 mV / 8 V
Distortion factor: 0.03% (1 kHz, 1 V)
- Tuner Section**
[FM] (note: μV at 75 ohms, 0 dBf = 1×10^{-15} W)
Receiving Range: 87.5 MHz ~ 108.0 MHz (for North America model)
 87.50 MHz ~ 108.00 MHz (for multi-voltage model)
Usable Sensitivity: 1.0 μV (11.2 dBf)
50 dB Quieting Sensitivity: MONO 1.6 μV (15.3 dBf)
 STEREO 23 μV (38.5 dBf)
Signal to Noise Ratio (IHF-A): MONO 80 dB
 STEREO 75 dB
Total Harmonic Distortion (at 1 kHz): MONO 0.15%
 STEREO 0.3%

[AM]
Receiving Range: 520 kHz ~ 1710 kHz (for North America model)
 522 kHz ~ 1611 kHz (for multi-voltage model)
Usable Sensitivity: 18 μV
Signal to Noise Ratio: 50 dB
- Video Section**
Standard video jacks
Input and output level / impedance: 1 Vp-p / 75 ohms
Frequency response: 2 Hz to 8 MHz +0, -3 dB
- General**
Power supply: AC 120 V, 60 Hz (for North America model)
 AC 110/220 V, 50/60 Hz (for multi-voltage model)
Power consumption: 4.0 A (for North America model)
 W (for multi-voltage model)
Maximum external dimensions: 434 (W) x 142 (H) x 325 (D) mm (17-3/32" x 5-19/32" x 12-51/64")
Weight: 9.1 kg (20 lbs 1 oz)
- Remote control unit**
System remote control
RC-169: Total buttons: 36
 DENON system code
 CD player: 6 buttons
 Cassette deck: 6 buttons
 AVR-800 fixed codes: 24 buttons
 Batteries: R6P/AA Type (two batteries)
 External dimensions: 55 (W) x 18 (H) x 180 (D) mm (2-11/64" x 7-3/32")
 Weight: 110 g (Approx. 4 oz) (including batteries)

* For purposes of improvement, specifications and design are subject to change without notice.

2 NAMES OF PARTS
(Front Panel)

BEZEICHNUNG DER TEILE
(Frontplatte)

NOMENCLATURE
(Panneau avant)
OMENCLATURA
(Pannello anteriore)

NOMBRE DE LAS PARTES
(Panel delantero)
NAMEN VAN ONDERDELEN
(Voorpaneel)
DE OLIKA DELARNAS NAMN
(Frontpanel)

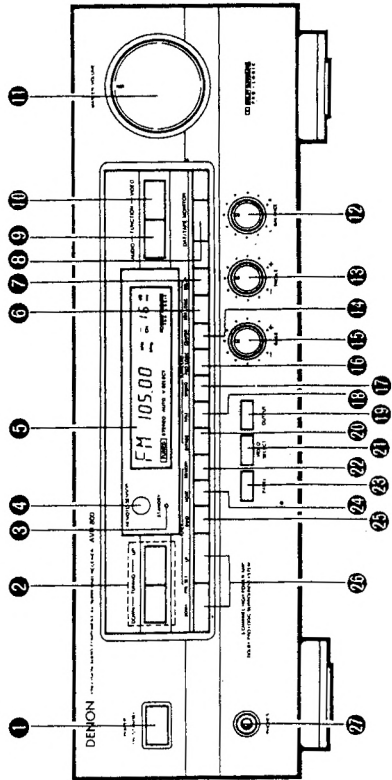

FÜR ENGLISH READERS

- 1 POWER BUTTON
- 2 TUNING BANDS
- 3 STANDBY LED
- 4 REMOTE CONTROL SENSOR
- 5 MFD
- 6 3CH LOGIC MODE BUTTON
- 7 DELAY TIME BUTTON
- 8 DAT/TAPE MONITOR BUTTON
- 9 VIDEO FUNCTION BUTTON
- 10 MASTER VOLUME
- 11 BALANCE CONTROL
- 12 TREBLE CONTROL
- 13 CENTER MODE BUTTON
- 14 DOLBY PRO LOGIC MODE BUTTON
- 15 STUDIO MODE BUTTON
- 16 HALL MODE BUTTON
- 17 OUTPUT BUTTON
- 18 BYPASS BUTTON
- 19 VIDEO SELECT BUTTON
- 20 MEMORY BUTTON
- 21 PANEL BUTTON
- 22 TUNING MODE BUTTON
- 23 Tuning Mode Selector Switch
- 24 TUNING BAND BUTTON
- 25 Tuning Band Selector Switch
- 26 TUNER PRESET BUTTONS
- 27 PHONES JACK

FÜR DEUTSCHE LESER

- 1 Netztaсте (POWER)
- 2 Abstimmstasten (TUNING)
- 3 Standby-Anzeige (STANDBY LED)
- 4 Sensor für Fernbedienung
- 5 MFD (Multi-funktion fluorescenz display)
- 6 3-Kanal Logik Modus Taste (3CH LOGIC MODE)
- 7 Zeitverzögerungstaste (DELAY TIME)
- 8 DAT-/Kassettendeck-Überwachungstaste (DAT/TAPE MONITOR)
- 9 Audio-Funktionstaste (AUDIO FUNCTION)
- 10 Hauptlautstärke (MASTER VOLUME)
- 11 Höhen-/Steuerung (BALANCE)
- 12 Höhen-/Steuerung (TREBLE)
- 13 Mittel-/Modus Taste (CENTER MODE)
- 14 Bass-/Steuerung (BASS)
- 15 Dolby-Pro Logik-Modus Taste (DOLBY PRO LOGIC MODE)
- 16 Taste für Studio-Modus (STUDIO MODE)
- 17 Taste für Saal-Modus (HALL MODE)
- 18 Ausgangstaste (OUTPUT)
- 19 Bypass-Taste (BYPASS)
- 20 Videoauswahl-Taste (VIDEO SELECT)
- 21 Speicher-Taste (MEMORY)
- 22 Konsolentaste (PANEL)
- 23 Abstimmungsmodus-Taste (TUNING MODE)
- 24 Tuning-Modus-Wahlschalter (Abstimmungsmodus-Wahlschalter)
- 25 Abstimmungsband-Tasten (TUNING BAND)
- 26 Tuner-Voreinstellungstasten (TUNER PRESET)
- 27 Kopfhörerbuchsen (PHONES JACK)

- POUR LES LECTEURS FRANCAIS**
- 1 TOUCHE D'ALIMENTATION (POWER)
 - 2 TOUCHES DE SYNTONISATION (TUNING)
 - 3 TEMOIN DE VEILLE (STANDBY LED)
 - 4 DETECTEUR DE TELECOMMANDE MFD (Africhage fluorescent multi-fonction)
 - 5 TOUCHE DE MODE LOGIQUE 3 CANAUX (3CH LOGIC MODE)
 - 6 TOUCHE DE RETARD (DELAY TIME)
 - 7 TOUCHE DAT/CONTROLE DE BANDE (DAT/TAPE MONITOR)
 - 8 TOUCHE DE FONCTION AUDIO (AUDIO FUNCTION)
 - 9 TOUCHE DE FONCTION VIDEO (VIDEO FUNCTION)
 - 10 Commande de VOLUME GLOBAL (MASTER VOLUME)
 - 11 Commande d'équilibre (BALANCE)
 - 12 Commande des aigues (TREBLE)
 - 13 TOUCHE DE MODE CENTRAL (CENTER MODE)

PER IL LETTORE ITALIANO

- 1 TASTO DI ACCENSIONE
- 2 TASTI DI SINTONIZZAZIONE
- 3 LED DI ATTESA
- 4 SENSORE A DISTANZA
- 5 Display MFD (display fluorescente multifunzione)
- 6 TASTO DEL MODO 3CH LOGIC
- 7 TASTO DELLA DURATA DEL RITARDO cassette (DAT/TAPE MONITOR)
- 8 TASTO DI FUNZIONE AUDIO
- 9 TASTO DI FUNZIONE VIDEO
- 10 VOLUME PRINCIPALE
- 11 CONTROLLO DEL BILANCIAMENTO
- 12 CONTROLLO DEGLI ACUTI

PARA LECTORES DE ESPAÑOL

- 1 INTERRUPTOR DE ALIMENTACION
- 2 BOTONES DE SINTONIZACION
- 3 LED DE MODO DE ESPERA
- 4 SENSOR DE CONTROL REMOTO
- 5 MFD (visualizador fluorescente multifunción)
- 6 BOTON SELECTOR DE MODO 3CH LOGIC
- 7 BOTON DAT/TAPE MONITOR (DAT/TAPE MONITOR)
- 8 BOTON SELECTOR DE ENTRADA DE AUDIO
- 9 BOTON SELECTOR DE ENTRADA DE VIDEO
- 10 CONTROL PRINCIPAL DE VOLUMEN
- 11 Control de tonos agudos (TREBLE)
- 12 BOTON SELECTOR DE MODO CENTRAL

VOOR NEDERLANDSTALIGE LEZERS

- 1 SPANNINGSTOETS (POWER)
- 2 AFSTEMTOETS (TUNING)
- 3 STANDBY-AANDEIJING (STANDBY LED)
- 4 AFSTANDBEDIENINGSENSOR (REMOTE CONTROL SENSOR)
- 5 MFD (Multifunctionele lichtgevende display)
- 6 3 KANAALS LOGIC-STANDTOETS (3 CH LOGIC MODE)
- 7 VERTRAGINGSTUURTOETS (DELAY TIME)
- 8 DAT/BANDSELUITOETS (DAT/TAPE MONITOR)
- 9 AUDIOFUNKTIEOETS (AUDIO FUNCTION)
- 10 VIDEOFUNKTIEOETS (VIDEO FUNCTION)
- 11 HOOPVOLUME (MASTER VOLUME)
- 12 Balansregelaar (BALANCE)
- 13 Hoogfrequentie regelaar (TREBLE)
- 14 MIDNENSTANDTOETS (CENTER MODE)
- 15 Lage-tonenregelaar (BASS)

FÖR SVENSKA LÄSARE

- 1 Strömbytare (POWER)
- 2 Avstämningstänger (TUNING)
- 3 Beredskapsindikator (STANDBY)
- 4 Fjärrkontrollsensor (REMOTE CONTROL SENSOR)
- 5 MFD-display
- 6 Tangent för 3-kanalogik (3CH LOGIC MODE)
- 7 Tangent för reglering av tidsfördröjningen (DELAY TIME)
- 8 DAT-/DACKVÄLLARE (DAT/TAPE MONITOR)
- 9 Audiofunktionstanger (AUDIO FUNCTION)
- 10 Videofunktionstanger (VIDEO FUNCTION)
- 11 Ljudstyrkontroll (MASTER VOLUME)
- 12 Balanskontroll (BALANCE)
- 13 Diskantkontroll (TREBLE)

- 15 Commande de graves (BASS)
- 16 TOUCHE DOLBY PRO LOGIC MODE
- 17 TOUCHE DE MODE SAALIE (HALL)
- 18 TOUCHE DE MODE SORTIE (OUTPUT)
- 19 TOUCHE DE DERIVATION (BYPASS)
- 20 TOUCHE DE SELECTION VIDEO (VIDEO SELECT)
- 21 TOUCHE DE MEMOIRE (MEMORY)
- 22 TOUCHE DE PANNEAU (PANEL)
- 23 TOUCHE DE MODE DE SYNTONISATION (TUNING MODE)
- 24 TOUCHE DE GAMME DE SYNTONISATION (TUNING BAND)
- 25 (Sélecteur de gamme de syntonisation)
- 26 TOUCHES DE PREREGLAGAGE DE TUNER (TUNER PRESET)
- 27 PRISE CASQUE (PHONES)

- 28 TASTO DEL MODO CENTRALE
- 29 CONTROLLO DEI BASSI
- 30 TASTO DEL MODO DOLBY PRO LOGIC
- 31 TASTO DEL MODO STUDIO
- 32 TASTO DEL MODO HALL
- 33 TASTO USCITA
- 34 TASTO BYPASS
- 35 TASTO DI SELEZIONE VIDEO
- 36 TASTO DI MEMORIZZAZIONE
- 37 TASTO DEL DISPLAY
- 38 TASTO DEL MODO DI SINTONIZZAZIONE
- 39 TASTO DELLA BANDA DI SINTONIZZAZIONE
- 40 TASTI DI PRESELEZIONE DEL SINTONIZZATORE
- 41 PRESA DELLE CUFFIE

- 42 Control de tonos bajos (BASS)
- 43 BOTON SELECTOR DE MODO DOLBY PRO LOGIC
- 44 BOTON SELECTOR DE MODO "STUDIO"
- 45 BOTON SELECTOR DE MODO "HALL"
- 46 BOTON DE SALIDA
- 47 BOTON DE OMISION
- 48 BOTON VIDEO SELECT
- 49 BOTON DE MEMORIA
- 50 BOTON DE INDICACION EN VISUALIZADOR (Interruptor selector de modo de sintonización (TUNING MODE))
- 51 Interruptor selector de banda de sintonización (TUNING BAND)
- 52 BOTONES DE PRESINTONIZACION
- 53 CONECTOR PARA AURICULARES

- 54 DOLBY PRO LOGIC-STANDTOETS
- 55 DOLBY PRO LOGIC MODE
- 56 STUDIOSTANDTOETS (STUDIO MODE)
- 57 CONCERTZAAL-STANDTOETS (HALL MODE)
- 58 UITVOERTOETS (OUTPUT)
- 59 NEGERTOETS (BYPASS)
- 60 VIDEOKEUZETOETS (VIDEO SELECT)
- 61 GEHEUGENTOETS (MEMORY)
- 62 PANELETOETS (PANEL)
- 63 AFSTEMSTANDTOETS (TUNING MODE)
- 64 GOLFBAANDSELUITTOETS (TUNING BAND)
- 65 (Golflandafstemkeuzeschakelaar)
- 66 TUNER-VOORKEUZETOETS (TUNER PRESET)
- 67 HOOFDTELEFOONAANSLUITING (PHONES)

- 68 Mittkänalsväljare (CENTER MODE)
- 69 Baskontroll (BASS)
- 70 DOLBY PRO LOGIC-tangent
- 71 STUDIO-tangent
- 72 HALL-tangent
- 73 Höglåtkontroll (OUTPUT)
- 74 Förkopplings tangent (BYPASS)
- 75 Videoväljare (VIDEO SELECT)
- 76 Minneslagring (MEMORY)
- 77 PANEL-tangent
- 78 Avstämningsskivplåre (TUNING MODE)
- 79 Frekvensbandväljare (TUNING BAND)
- 80 Snabbvalstänger (TUNER PRESET)
- 81 Hörlursuttag (PHONES)

**1 INTRODUCTION / EINFÜHRUNG / INTRODUCTION
INTRODUZIONE / INTRODUCCIÓN / INLEIDING / INLEDNING**





**NOTE ON USE / HINWEISE ZUM GEBRAUCH / OBSERVATIONS RELATIVES A L'UTILISATION
NOTE SULL'USO / NOTAS SOBRE EL USO / ALVORENS TE GEBRUIKEN / OBSERVERA**

• NUR FÜR EUROPÄISCHE MODELLE

Konformitätserklärung

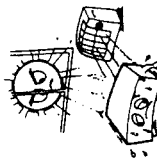
Die DENON Electronic GmbH
Halbste Straße, 32
4030 Ratingen 1

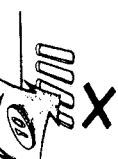
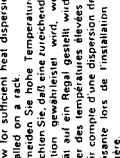
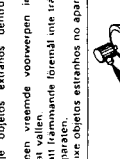
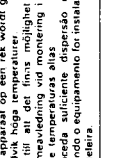
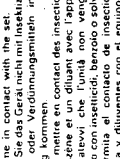
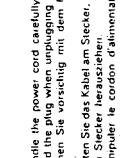
Erklärt als Hersteller/Importeur, daß das in dieser Bedienungsanleitung beschriebene Gerät den Technischen Vorschriften für Ton- und Fernseh-Rundfunkempfänger nach der Amtsblattverfügung 868/1989 (Amtsblatt des Bundesministers für Post und Telekommunikation vom 31. 8. 1989) entspricht.

 <ul style="list-style-type: none"> • Avoid high temperatures. Allow for sufficient heat dispersion when installed on a rack. • Vermeiden Sie hohe Temperaturen. Beachten Sie, daß eine zureichende Luftzirkulation sichergestellt ist, wenn das Gerät auf ein Regal gestellt wird. • Evitez des températures élevées. Tenir compte d'une dispersion de chaleur suffisante lors de l'installation sur une étagère. • Evitate di espore l'unità a temperatura alta. • Assicurarsi che ci sia un adeguata dispersione di calore quando l'unità è installata su un mobile per componenti audio. • Evite altas temperaturas. Permita la suficiente dispersión del calor cuando sea instalado en la consola. • Zorg voor een dekklijk hitte/voort, indien het apparaat op een rek wordt geplaatst. • Ünikit, hoga temperaturer. Se till att följande värmeledning till god värmeledning vid montering i ett rack. • Evite temperaturas altas. Conceda suficiente dispersión de calor cuando o equipamento for instalado numa prateleira. 	 <ul style="list-style-type: none"> • Keep the set free from moisture, water, and dust. • Halten Sie das Gerät von Feuchtigkeit, Wasser und Staub fern. • Protège l'appareil contre l'humidité, l'eau et la poussière. • Ferme l'unità lontana dall'umidità, dall'acqua e dalla polvere. • Laat geen vresende voorswerpen in dit apparaat binnenvallen, water of stof in het apparaat binnendringen. • Não deixe o aparelho for, fuma, vapor ou poeira. 	 <ul style="list-style-type: none"> • Do not let foreign objects in the set. Foreign objects in the set may come in contact with the set. • Ne pas laisser des objets étrangers dans l'appareil. • Non lasciare che nessun oggetto estraneo entri nell'appareil. • No dreje objekts ekstraos dentro del equipo. • Laat geen vreemde voorwerpen in dit apparaat vallen. • Não deixe objetos estranhos no aparelho. 	 <ul style="list-style-type: none"> • Unplug the power cord when not using the set for long periods of time. • Wenn das Gerät eine längere Zeit nicht verwendet werden soll, trennen Sie das Netzstecker aus der Steckdose. • Débrancher le cordon d'alimentation lorsque l'appareil n'est pas utilisé pendant de longues périodes. • Scollegare il filo di alimentazione quando non si userà l'appareil per un lungo periodo di tempo. • Desconecte el cordón de energía cuando no se usará el aparato por un largo periodo. • Neem altijd het netkabel uit het stopcontact wanneer het apparaat gedurende een lange periode niet wordt gebruikt. • Koppals ur nettakabeln om apparaten inte brukas under en lång tidsperiod. • Desligue o fio condutor de força quando o aparelho não liver que ser usado por um longo período. 	 <ul style="list-style-type: none"> • Do not let insecticides, benzene, and thinners come in contact with the set. • Benzin, oder Verdünnungsmitteln in Berührung mit dem Gerät zu vermeiden. • Ne pas mettre en contact des insecticides, du benzène et un diluant avec l'appareil. • Assicurarsi che l'unità non venga in contatto con insetticidi, benzolo o solventi. • Laat geen insectenverdelgende middelen, benzine of verwerdinner met dit apparaat in contact komen. • Não deixe inseticidas, benzina e thinner em contato com o aparelho. 	 <ul style="list-style-type: none"> • Handle the power cord carefully. Do not pull on the cord. • Gehen Sie vorsichtig mit dem Netzkabel um. • Halten Sie das Kabel am Stecker, wenn Sie den Stecker herausziehen. • Tenir la prise lors du débranchement du cordon. • Maneggiare il filo di alimentazione con cura. • Agite per la spina quando scollegate il cavo dalla presa. • Manège el cordón de energía con cuidado. No tire del cable cuando desconecte el cordón de energía. • Handleer het netkabel voorzichtig. Houd het snoer bij de stecker vast wanneer deze moet worden aan- of losgekoppeld. • Håll i kablarn när den tappas. Fån ei utdrag. • Manuseie com cuidado o fio condutor de energia. • Segure a tomada ao desconectar o fio 	 <ul style="list-style-type: none"> • Never disassemble or modify the set in any way. • Versuchen Sie niemals das Gerät auseinanderzunehmen oder auf jegliche Art zu verändern. • Ne jamais démonter ou modifier l'appareil d'une manière ou d'une autre. • Non smontare mai, né modificare l'unità in nessuna maniera. • Moort ni apparat demonteren of op andere wijze modifieren. • Não desmonte o aparelho ou modifique o aparelho de alguma forma. 	 <ul style="list-style-type: none"> • *If not fitted with ventilation holes. • Do not obstruct the ventilation holes. • Die Belüftungöffnungen dürfen nicht verdeckt werden. • Ne pas obstruer les trous d'aération. • Non coprire i fori di ventilazione. • Do ventilationsopeningen mogen niet worden blokkeerd. • Tapp inte till ventilationsöppningarna. • Não obstrua os orifícios de ventilação 	
---	--	--	--	---	---	--	--	---

**"SERIAL NO.
PLEASE RECORD UNIT SERIAL NUMBER ATTACHED TO THE
REAR OF THE CABINET FOR FUTURE REFERENCE"**

**(EUROPE MODEL)
SPECIFICATIONS**

- **Audio Section**
 - (Power amplifier)** Front (main 2ch driven)
60 W + 60 W (8 ohms, 20 Hz – 20 kHz with 0.1% THD)
 - Rated output:** CENTER (center 1ch driven)
60 W (8 ohms, 20 Hz – 20 kHz with 0.1% THD)
 - (All properties shown are only for the power amplifier stage.) REAR (rear 2ch driven)
15 W + 15 W (8 ohms, 1 kHz with 0.5% THD)
 - Output terminals:** Front: 6 to 16 ohms
Center: 8 to 16 ohms
Rear: 8 to 16 ohms
 - Line input (Each line input – FRONT SP OUT)**
 - Input sensitivity/impedance:** 150 mV/47 k ohms PHONO (MM): 2.5 mV/47 kohms
 - Frequency response:** 10 Hz to 50 kHz: ±3 dB
 - Tone control range:** BASS: ±10 dB at 100 Hz
TREBLE: ±10 dB at 10 kHz
 - Signal-to-noise ratio** 92 dB (BYPASS)
 - Phono equalizer (PHONO input – REC OUT)**
 - RIAA deviation:** ±1 dB (20 Hz to 20 kHz)
 - Signal-to-noise ratio:** 74 dB (A weighting, with 5 mV input)
 - Rated output/Maximum output:** 150 mV/8 V
 - Distortion factor:** 0.03% (1 kHz, 1 V)
- **Tuner Section**
 - [FM] (note: μV at 75 ohms, 0 dBf = 1×10^{-15} W)**
 - Receiving Range: 87.50 MHz ~ 108.00 MHz
 - Usable Sensitivity: 1.0 μV (11.2 dBf)
 - 50 dB Quieting Sensitivity: MONO 1.6 μV (15.3 dBf)
STEREO 23 μV (38.5 dBf)
 - Signal to Noise Ratio (IHF-A): MONO 80 dB
STEREO 75 dB
 - Total Harmonic Distortion (at 1 kHz): MONO 0.4%
STEREO 0.5%
 - [AM]**
 - Receiving Range: 522 kHz ~ 1611 kHz
 - Usable Sensitivity: 18 μV
 - Signal to Noise Ratio: 50 dB
- **Video Section**
 - Standard video jacks**
 - Input and output level/impedance:** 1 Vp-p/75 ohms
 - Frequency response:** 2 Hz to 8 MHz +0, -3 dB
- **General**
 - Power supply:** AC 230 V, 50 Hz (for Europe model)
AC 240 V, 50 Hz (for U.K. model)
 - Power consumption:** 200 W
 - Maximum external dimensions:** 434 (W) × 142 (H) × 325 (D) mm (17-3/32" × 5-19/32" × 12-51/64")
 - Weight:** 9.1 kg (20 lbs 1 oz)
- **Remote control unit**
 - System remote control**
 - RC-169:** Total buttons: 36
 - DENON system code
 - CD player: 6 buttons
 - Cassette deck: 6 buttons
 - AVR-800 fixed codes: 24 buttons
 - Batteries: R6P/AA Type (two batteries)
 - External dimensions: 55 (W) × 18 (H) × 180 (D) mm (2-11/64" × 45/64" × 7-3/32")
 - Weight: 110 g (Approx. 4 oz) (including batteries)

* For purposes of improvement, specifications and design are subject to change without notice.

14 TROUBLESHOOTING

If a problem should arise, first check the following:

1. Are the connections correct?
2. Have you operated the amplifier according to the Operating Instructions?
3. Are the speakers, turntable, and other components operating properly?

If the receiver is not operating properly, check the items listed in the table below. Should the problem persist, there may be a malfunction. Disconnect the power immediately and contact your store of purchase.

Symptom	Cause	Measures	Page
MFD not lit and sound not produced when power switch set to on.	• Power cord not plugged in securely	• Check the insertion of the power cord plug.	8
MFD lit but sound not produced.	• Speaker cords not securely connected • OUTPUT button is off. • Improper position of the audio function buttons. • Remote control set to minimum. • MUTING is on.	• Connect securely. • Press the OUTPUT button. • Set to a suitable position. • Turn volume up to suitable level. • Switch off MUTING.	14 17 15 15 16
-PROTECT- display appears multi-function display.	• Speaker terminals are short-circuited • Block the ventilation holes of the set. • The unit is operating at continuous high power conditions and/or inadequate ventilation.	• Switch power off, connect speakers properly, then switch power back on. • Turn volume up to suitable level, then ventilate it well to cool the power, then ventilate it once the set is cooled down, turn the power back on.	14
Sound produced only from one channel.	• Incomplete connection of speaker cords. • Left/right balance is off.	• Connect securely. • Connect securely. • Adjust balance knob properly.	14-13
Positions of instruments reversed during stereo playback.	• Reverse connections of left and right speakers or left and right input/output cords.	• Check left and right connections.	12-14
Sound seems distorted.	• Rear level is too high.	• Set the rear level to lower level.	23, 25
Personal memory function does not work.	• DAT/TAPE monitor mode set.	• Press the DAT/TAPE button to set the source.	17
Humming noise produced when record is playing.	• Ground wire of turntable not connected properly. • Incomplete PHONO jack connection. • TV or radio transmission antenna nearby.	• Connect securely. • Contact your store of purchase. • Separate as much as possible.	12
Howling noise produced when volume is high.	• Turntable and speaker systems too close together. • Floor is unstable and vibrates easily.	• Use cushions to absorb speaker vibrations. • Turntable and speaker systems are not equipped with insulators, use audio insulators (commonly available).	-
Sound is distorted.	• Stylus pressure too weak. • Dust or dirt on stylus. • Cartridge defective	• Check stylus pressure. • Clean stylus. • Replace cartridge.	-
Volume is weak.	• MC cartridge being used.	• Replace with MM cartridge or use a fixed amplifier or stepping transformer.	12
Receiver does not operate properly when remote control unit is used.	• Batteries dead. • Remote control unit too far from receiver. • Obstacle between receiver and remote control unit. • Different button is being pressed. • + and - ends of battery inserted in reverse.	• Replace with new batteries. • Move closer. • Remove obstacle. • Press the proper button. • Insert batteries properly.	10 10

15 LAST FUNCTION MEMORY

- This receiver is equipped with a last function memory which stores the input and output setting conditions as they were immediately before the power is switched off.
- This function eliminates the need to perform complicated resettings when the power is switched on.
- This receiver is also equipped with a back-up memory. This function provides approximately one week of memory storage with the power cord disconnected.

16 SPECIFICATIONS

- **Audio Section**
 (Power amplifier)
 Rated output: 60 W + 60 W (8 ohms, 20 Hz ~ 20 kHz with 0.08% THD)
 CENTER (center 1 ch driven) (8 ohms, 20 Hz ~ 20 kHz with 0.08% THD)
 REAR (rear 2 ch driven) (6 ohms, 20 Hz ~ 20 kHz with 0.3% THD)
 15 W + 15 W (6 ohms, 1 kHz with 0.3% THD)
 Output terminals:
 Front: 8 to 16 ohms
 Center: 8 to 16 ohms
 Rear: 8 to 16 ohms
 Line input (Each line input - FRONT SP-OUT)
 Input sensitivity/impedance: PHONO (MM): 2.5 mV / 47 kohms
 10 Hz to 50 kHz: ±3 dB
 Tone control range: ±10 dB at 100 kHz
 BASS: +10 dB at 10 kHz
 TREBLE: -10 dB at 10 kHz
 Signal-to-noise ratio 92 dB (BYPASS)
 Phono equalizer (PHONO input - REC OUT)
 RIAA deviation: ±1 dB (20 Hz to 20 kHz)
 Signal-to-noise ratio: 74 dB (A-weighting, with 5 mV input)
 Rated output/Maximum output: 150 mV/8 V
 Distortion factor: 0.03% (1 kHz, 1 V)
- **Tuner Section**
 [FM] (note: μV at 75 ohms, 0 dBf = 1×10^{-15} W)
 Receiving Range: 87.5 MHz ~ 108.0 MHz (for North America model)
 87.50 MHz ~ 108.00 MHz (for multi-voltage model)
 Usable Sensitivity: 1.0 μV (11.2 dBf)
 50 dB Quieting Sensitivity: MONO 1.6 μV (15.3 dBf)
 Signal to Noise Ratio (HF-A): STEREO 23 μV (38.5 dBf)
 MONO 80 dB
 Total Harmonic Distortion STEREO 0.15%
 MONO 0.3%
 [AM]
 Receiving Range: 520 kHz ~ 1710 kHz (for North America model)
 522 kHz ~ 1611 kHz (for multi-voltage model)
 Usable Sensitivity: 18 μV
 Signal to Noise Ratio: 50 dB
- **Video Section**
 Standard video jacks Input and output level/impedance: 1 Vp-p/75 ohms
 Frequency response: 2 Hz to 9 MHz ± 0 , -3 dB
- **General**
 Power supply: AC 120 V, 60 Hz (for North America model)
 AC 110/220 V, 50/60 Hz (for multi-voltage model)
 Power consumption: 4.0 A (for North America model)
 W (for multi-voltage model)
 Maximum external dimensions: 434 (W) x 142 (H) x 325 (D) mm (17.3/32" x 5.19/32" x 12.51/64")
 Weight: 9.1 kg (20 lbs 1 oz)
- **Remote control unit**
 System remote control RC-169:
 Total buttons: 36
 DENON system code: 6 buttons
 CD player: 6 buttons
 Cassette deck: 24 buttons
 AVR-800 fixed codes: 6 buttons
 Batteries: R6P/AA Type (two batteries)
 External dimensions: 56 (W) x 18 (H) x 180 (D) mm (2.11/64" x 45/64" x 7.3/32")
 Weight: 110 g (Approx. 4 oz) (including batteries)

* For purposes of improvement, specifications and design are subject to change without notice.

Using the Personal Memory

Surround mode settings and the input function can be stored at personal memory buttons "1" and "2", then recalled directly from any surround mode simply by pressing button "1" or "2".

1] Storing the setting in the personal memory

1. Set the desired surround mode and input function.

2. Press the personal memory button.



Remote control unit

(The memory setting mode is set and the indicator on the MFD flashes.)

3. Press the desired personal memory button ("1" or "2").

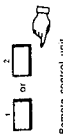

Remote control unit

4. "M 1 (2) SET" appears on the MFD indicating that the setting has been stored.

NOTE:

- The memory setting mode is set for 6 seconds. If any button other than personal memory button "1" or "2" is pressed, the memory setting mode is cancelled.

2] Recalling the personal memory

5. Press the personal memory button ("1" or "2") at which the desired setting was stored.



Remote control unit

6. The surround mode and input function switch automatically.

NOTES:

- Personal memory buttons "1" and "2" will not function during the lapse monitor mode.
- The surround mode recalled with the PERSONAL MEMORY "1" or "2" button is the same as the mode selected with the surround mode selected with the surround mode which was stored in the memory are cleared, when the mode is recalled it is set to the initial values.
- Upon shipment from the factory, the "DOLBY PRO LOGIC" mode is stored at personal memory "1", the "HALL" mode at personal memory "2". The input function is set to VDP/DBS for both "1" and "2".
- Do not press personal memory buttons "1" or "2" buttons during recording on the cassette deck.

Operations Possible in the Various Surround Modes

The following is a list of the buttons and functions which can be operated during the different surround modes. Figures in parentheses indicate adjustment ranges.

	OUTPUT	CENTER LEVEL	REAR LEVEL	CENTER MODE	3CH LOGIC	TEST TONE	DELAY TIME
BYPASS	○	X	X	△ ¹	X	X	X
DOLBY PRO LOGIC	○	○ (0--24dB)	○ (0--24dB)	○	○	○	○ (15--30ms)
	○	○ (0--24dB)	○ (0--24dB)	○	X	○	○ (15--30ms)
DOLBY 3CH LOGIC	○	○ (0--24dB)	X	○	○	○	X
	○	○ (0--24dB)	○	○	○	○	X
HALL	○	X	○ (0--24dB)	△ ¹	X	X	○ (0--32ms)
STUDIO	○	X	○ (0--24dB)	△ ¹	X	X	○ (0--32ms)

○: Operation possible X: Operation not possible

¹ Switches to the Dolby Pro (3CH) Logic for any mode other than Dolby Pro (3CH) Logic. The delay time for the rear channels can be adjusted by 2 dB step. The delay time can be set by 1.5 ms step.

- The sound may be distorted for some sources if the rear level is raised during surround playback. If this happens, lower the rear level.

13] INITIALIZATION OF THE MICROPROCESSOR

When the indication of the MFD display is not normal or when the operation of the unit does not show the reasonable result, the initialization of the microprocessor is required by the following procedure.

1. Switch off the unit and remove the AC power cord from the wall outlet.
2. Hold the following 2 buttons of the main unit at the same time (as illustrated in the diagram below, ① AUDIO FUNCTION button, ② VIDEO FUNCTION button) and plug the power cord into the outlet.

3. Check that the entire MFD display is flashing with an interval of about 1 second, and release your fingers from the 2 buttons.
4. Switch on the unit and the microprocessor will be initialized. The input function is set to tuner with the bypass mode automatically.

NOTE:

- When the unit does not show the result of above 3 and 4, repeat the procedure from 1 again.
- When the microprocessor is initialized, all settings you have made are reset to the factory presettings.

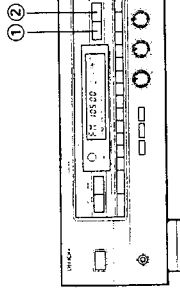

Initial parameter values for the different modes

	OUTPUT	CENTER LEVEL	REAR LEVEL	CENTER MODE	3CH LOGIC	DELAY TIME
BYPASS	DN	-	-	-	-	-
DOLBY PRO LOGIC	ON	-12dB	-	NORMAL	OFF	21msc
HALL	ON	-	-12dB	-	-	21msc
STUDIO	ON	-	-12dB	-	-	21msc

- INPUT FUNCTION : TUNER
- Reception band : FM
- Reception mode : AUTO
- Reception frequency : 87.5MHz (for North American models) 87.50MHz (for multi-voltage models)
- PERSONAL MEMORY 1 : VDP/DBS
- INPUT SURROUND MODE : DOLBY PRO LOGIC
- PERSONAL MEMORY 2 : VDP/DBS
- INPUT SURROUND MODE : HALL

• **Setting the delay time**

The optimum delay time will differ depending on the listening position. Referring to the chart at right, set the optimum delay time for your room's space and seating position. For example, when the distance from the front speakers to the listening position is 6 m and that from the rear speakers to the listening position is 4 m, the optimum delay time will be 21 ms. The variable range of the delay time differs depending on the mode. For details about the variable range, see Page 25.

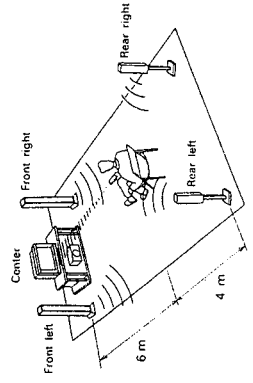

Listening position and optimum delay time for playback with Dolby Pro Logic surround

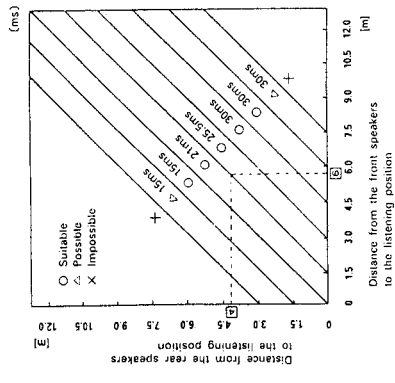

→ Continued

• **Speaker volume adjustment and Dolby Pro Logic mode**

To obtain the maximum surround effect, use the test tones to adjust the volume and balance of the speakers for the best balance for the listening position and so that the sound from all the speakers is heard at the same level. Set the master volume control to a suitable level, then adjust using the following procedure.

- Press the **T.TONE** button.

 Remote control unit
 Test tones are produced from the speakers in the order shown below, at 4 second intervals for the first two cycles, 2 second intervals after that.
 For the Dolby 3CH Logic mode:
 [FL] → [C] → [FR] → [LS] → [RS]
 [FL] → [C] → [FR] → [FR] → [FR]
 To increase the level of the center speakers.

 Remote control unit
- To decrease the level of the center speakers.

 Remote control unit
- To increase the level of the rear speakers.

 Remote control unit
- To decrease the level of the rear speakers.

 Remote control unit
- Press the **T.TONE** button again.

 Remote control unit

NOTES:

- The test tone will not move on to the next channel when it is being emitted from the center channel and the level of speakers is being adjusted, or when it is being emitted from the rear channel and the level of the rear speakers is being adjusted. In either case, the next channel approximately two seconds after the level key has been released.

• **Other Surround Modes**

- HALL mode / STUDIO mode**

- Set the **HALL mode / STUDIO mode**.

 Main unit

 Remote control unit
 DOLBY PRO LOGIC
- Play the desired software.
- Adjust the volume.

 Main unit

 Remote control unit
- Adjust the level of the center and rear channels. Adjust the levels according to the source, using the Dolby Pro Logic settings as reference.
- Adjust the delay time as desired.

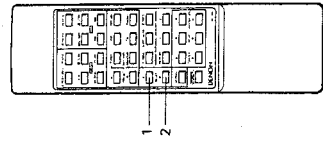
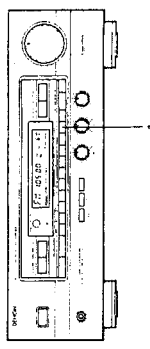

- To increase the delay time.

 Main unit

 Remote control unit
- To decrease the delay time.

 Remote control unit

- Once the delay time is set, there is no need to readjust it, unless you change the speaker system or the listening position.
- It is available to memorize the adjusted values of delay time and rear (center) level for each surround mode.

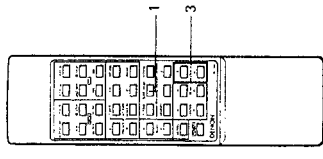
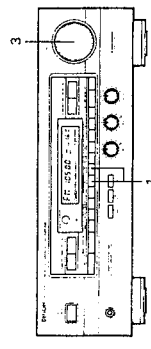

→ Continued

NORMAL mode
This mode is suited for an arrangement in which the center channel speaker is smaller than the left and right speakers. Signals below 100 Hz, which have almost no effect on directional orientation, are distributed to the left and right channels, whereas the center channel output signals greater than 100 Hz. As a result, the bass of the left and right channels increases the apparent depth of the sound.

PHANTOM mode
Use this mode when center channel speaker is not used. A directional emphasis circuit provides signal reproduction which is electrically oriented to the center and this provides an exciting sound field for your enjoyment.

WIDE mode
This mode is suited for an arrangement in which the center channel speaker is of the same grade as the left and right speakers. The entire sound band from low region to high is output to the center channel to provide an exciting sound field for your enjoyment.

Center Mode

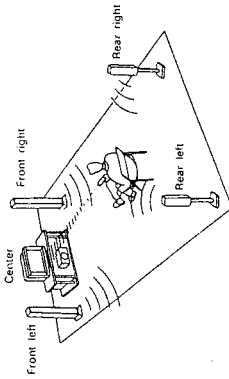

• Dolby 3CH. Logic (three-channel logic mode)

Select this mode when not using rear speakers.

<p>1. Set the Dolby Pro Logic mode.</p>	<p>2. Press the 3CH. LOGIC button.</p>
<p>3CH. LOGIC PRO LOGIC</p> <p>The mode changes as shown at the left.</p>	
<p>3. Select the center mode according to your speaker system.</p> <p>NORMAL ← WIDE</p> <p>The mode changes as shown above.</p>	

3CH. LOGIC MODE

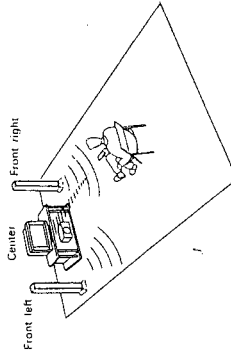

3CH. LOGIC mode
Use this mode when rear channel speakers are not used. The rear channel information is reproduced by the front speakers.

12 SURROUND PLAYBACK

■ SURROUND modes

The surround modes are as follows:

1	DOLBY Pro Logic	Use this when playing program sources recorded in Dolby Surround or Dolby Stereo.
2	HALL	Use this setting to create the atmosphere of a concert hall. There will be no output from the center speaker.
3	STUDIO	Use this setting to create the atmosphere of watching a live program in a studio. There will be no output from the center speaker.

- These effects may not be very pronounced for some sources.
- To adjust the speaker balance for the different surround modes, first adjust for the Dolby Pro Logic Surround mode as explained on page 23, then use the position of the center level and rear level controls at this time as a guide to adjust the balance for that surround mode.

Manufactured under license from Dolby Laboratories Licensing Corporation. Additionally licensed under one or more of the following patents: U.S. number 3,959,590; Canadian numbers 1,004,603 and 1,037,877. "Dolby," "Pro Logic," and the double-D symbol are trademarks of Dolby Laboratories Licensing Corporation.

■ Using Dolby Pro Logic Surround

- **Speaker disposition and the Dolby Pro Logic Center mode**
Ideally, center speakers should be used when playing sources in Dolby Pro Logic Surround. Select the center mode according to your speaker system.

<p>1. Set the Dolby Pro Logic mode.</p>	<p>2. Select the center mode.</p> <p>NORMAL → PHANTOM</p> <p>The mode changes as shown above.</p>
---	---

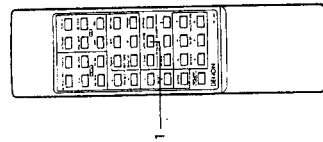
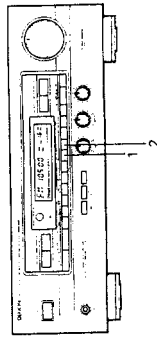

11 LISTENING TO THE RADIO

Tuning

1. Set the input function to "TUNER".

2. Select the reception band.

There is a change as mentioned at the left and indication ① inside the MFD changes.

3. Select the tuning mode.

The mode switches as shown at the left. When the auto mode is set, "AUTO" lights on the MFD ②.

MANUAL

Set the auto mode for automatic tuning, the manual mode for manual tuning.

4. Tune in the station.

In the manual tuning mode: Press the UP button once to increase the frequency by one step, the DOWN button once to decrease the frequency by one step. The frequency changes continuously when the button is held. The "TUNED" indicator ③ lights on the MFD when a station is tuned in. In the auto tuning mode: When the UP or DOWN button is pressed, automatic searching begins, and searching stops when a station is tuned in.

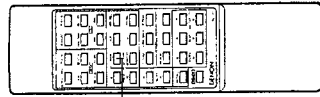
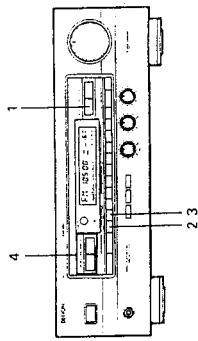

MFD display

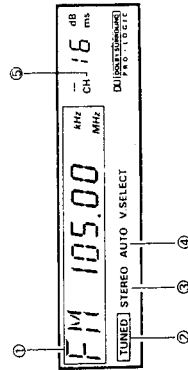

- NOTES:**
- When in the auto tuning mode on the FM band, the "STEREO" indicator ③ lights on the MFD when a stereo broadcast is tuned in. At open frequencies, the noise is muted and the "TUNED" ② and "STEREO" ③ indicators turn off.
 - When the manual tuning mode is set, FM stereo broadcasts are received in monaural and the "STEREO" indicator ③ turns off.

Storing stations at the preset buttons

1. Follow steps 1 to 4 under "Tuning" to tune in a station.

2. Press the MEMORY button.

The "CH" ④ indicator on the MFD flashes.

3. Select the preset channels.

4. Press the MEMORY button that you want to store to memory.

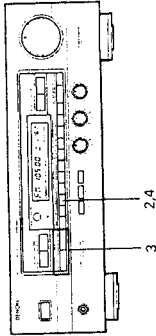

NOTES:

- The preset memory standby mode is set for 10 seconds when the MEMORY button is pressed.
- The preset memory standby mode is cancelled if any button other than preset buttons, the MEMORY button is pressed.

Recalling stations with the preset buttons

First store stations at the preset buttons using the above procedure.

3. Select the preset channels.

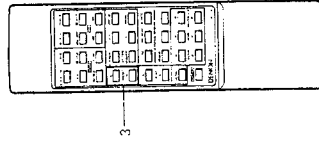

■ Simulcast playback (playing different video and audio sources simultaneously)

1. Follow steps 1 to 3 under "Playing the program source".

2. Press the VIDEO SELECT button until the desired video source is displayed on the MFD.

The source switches as shown above.

3. Follow steps 4 to 8 under "Playing the program source".

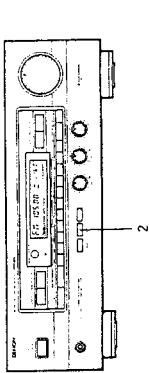

—Cancelling simulcast playback—

- Press the VIDEO SELECT button again.
- Press the video function button on the main unit or remote control unit.

■ Using the muting function
Use this to turn off the audio output temporarily.

1. Press the MUTING button.

This function can only be set from the remote control unit.

The STANDBY LED flashes when the muting function is set.

2. Press the MUTING button again.
The muting function is cancelled.

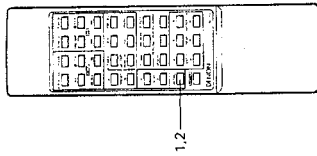

9 TAPE MONITOR FUNCTION

■ When playing a DAT or tape deck
Use this function to switch between the DAT or tape deck and the input (source) selected with the audio or video function buttons.

1. Follow steps 1 and 2 under "Playing the program source".

2. Select the deck to be played.

The source switches as shown at the left.

3. Follow steps 5 to 8 under "Playing the program source".

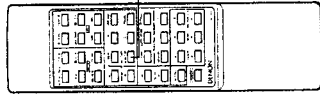
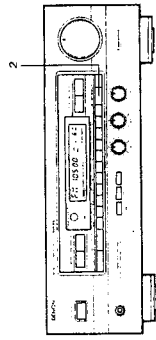

■ Monitoring the recording on a three-headed tape deck

The sound actually being recorded can be monitored during recording when a three-headed tape deck is used.

1. Select the deck to be monitored.

The source switches as shown at the left.

2. Follow steps 1 to 3 under "Playing the program source".

3. Start recording on the tape deck. For instructions, refer to the component's operating instructions.

4. Press the three-headed tape deck's source/tape button to monitor the recording.

NOTE:

- Also refer to the three-headed tape deck's operating instructions.

8 RECORDING

■ Recording the program source
(recording the source currently being monitored)

1. Follow steps 1 to 3 under "Playing the program source".

2. Start recording on the tape or video deck.
For instructions, refer to the component's operating instructions.

NOTE:

The recording source switches if the audio function, video function, personal memory "1" or "2" or tuner preset buttons are pressed during recording. Do not press these buttons during recording.

Simultaneous recording

The signals of the source selected with the function selector button are output simultaneously to the DAT/TAPE and VCR REC OUT jacks. If a total of two tape and/or video decks are connected and set to the recording mode, the same source can be recorded simultaneously on both decks.
In addition, if the TAPE MONITOR (DAT/TAPE) button is pressed, the audio signals from the tape deck are output to the VCR AUDIO REC OUT jacks.

10 USING HEADPHONES

The sound from the speakers can be turned off using the OUTPUT button to listen to the sound over the headphones only, for example at night.

1. Press the OUTPUT button.

"H/P ONLY" appears on the MFD.

2. Insert the headphones' plug into the headphones' jack.

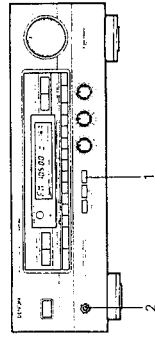

—Cancelling—
Either press the OUTPUT button again or press the POWER button to turn off the power.

Continued

7 PLAYBACK

Preparations for Playback

- Check the connections
- Check that all connections are proper, referring to the connections diagrams (pages 10 to 14).

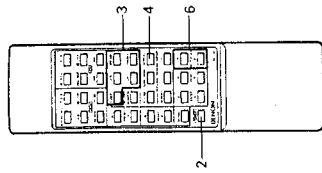
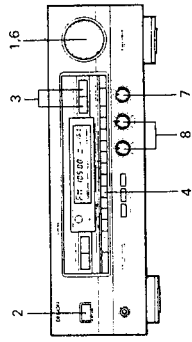

Playing the program source (normal stereo playback)

<p>1. Set the MASTER VOLUME control to the minimum.</p> <p>Main unit</p>	<p>4. Press the BYPASS button.</p> <p>Remote control unit</p>
<p>2. Press the POWER button to turn the power on. The muting mode is set for several seconds, after which the STANDBY LED flashes for several seconds.</p> <p>Main unit</p>	<p>5. Start playback the source. For instructions, refer to the source's operating instructions.</p> <p>Remote control unit</p>
<p>3. Select the source to be played. Audio function button Example: PHONO, CD or TUNER can be selected directly.</p> <p>Main unit</p>	<p>6. Adjust the volume. Turn the control clockwise to increase the volume, counterclockwise to decrease it.</p> <p>Main unit</p>
<p>7. Adjust the left/right balance. Turn the control counterclockwise to reduce the volume of the right channel, clockwise to reduce the volume of the left channel.</p> <p>Main unit</p>	<p>8. Adjust the tone. Turn the control clockwise to increase the bass, counterclockwise to decrease it.</p> <p>Main unit</p>

NOTE: The sound may be interrupted if switches are operated during playback. This is because the muting circuit is activated to prevent switching noise.

Speaker System Connections

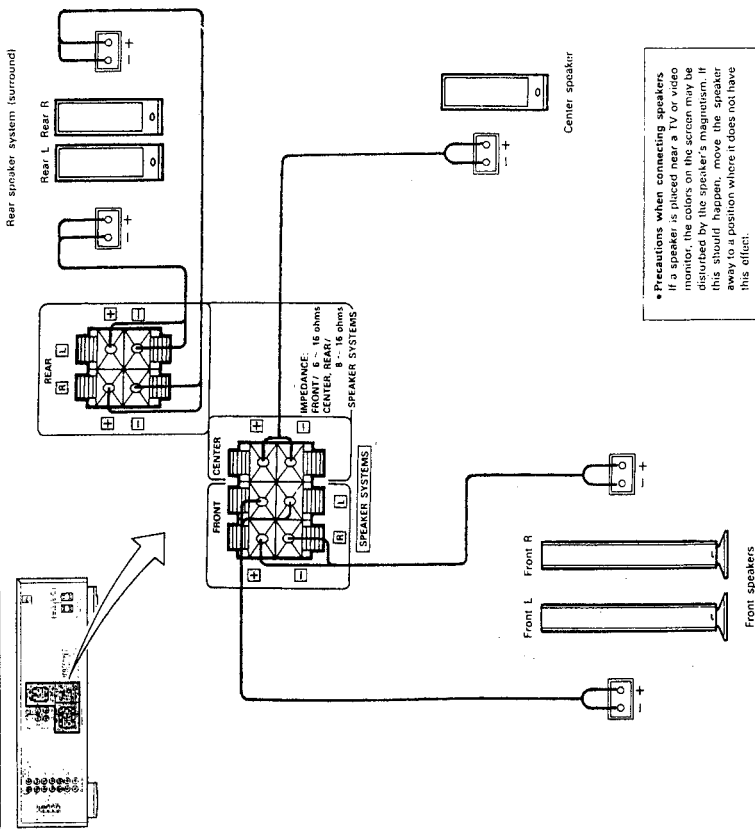

Precautions when connecting speakers
If a speaker is placed near a TV or video monitor, the colors on the screen may be disturbed by the magnetic field. To avoid this, move the speaker away to a position where it does not have this effect.

<p>Preparing the cord</p> <ol style="list-style-type: none"> Peel off the sheath. Twist the wires. 	<p>Connecting the center and rear speaker terminals.</p> <ol style="list-style-type: none"> Press the lever. Insert the cord and release the lever.
---	--

- This receiver can accommodate connections of a total of five speakers including one set of front speakers, one set of rear speakers, and one center speaker.
- Connect the speaker terminals with the speakers making sure that like polarities are matched (⊕ with ⊕, ⊖ with ⊖). Mismatching of polarities will result in weak central sound, unclear orientation of the various instruments, and the sense of direction of the stereo being impaired.
- When making connections, take care that none of the individual conductors of the speaker cord come in contact with adjacent terminals, with other speaker cord conductors, or with the rear panel.
- Speaker impedance**
 - Speakers with an impedance of 6 to 16 ohms can be connected for use as front speakers & to 16 ohms can be connected for use as center and rear speakers.
 - Using speakers with an impedance other than the specified one may result in damage. Be sure to use speakers of the specified impedance.

Video Section

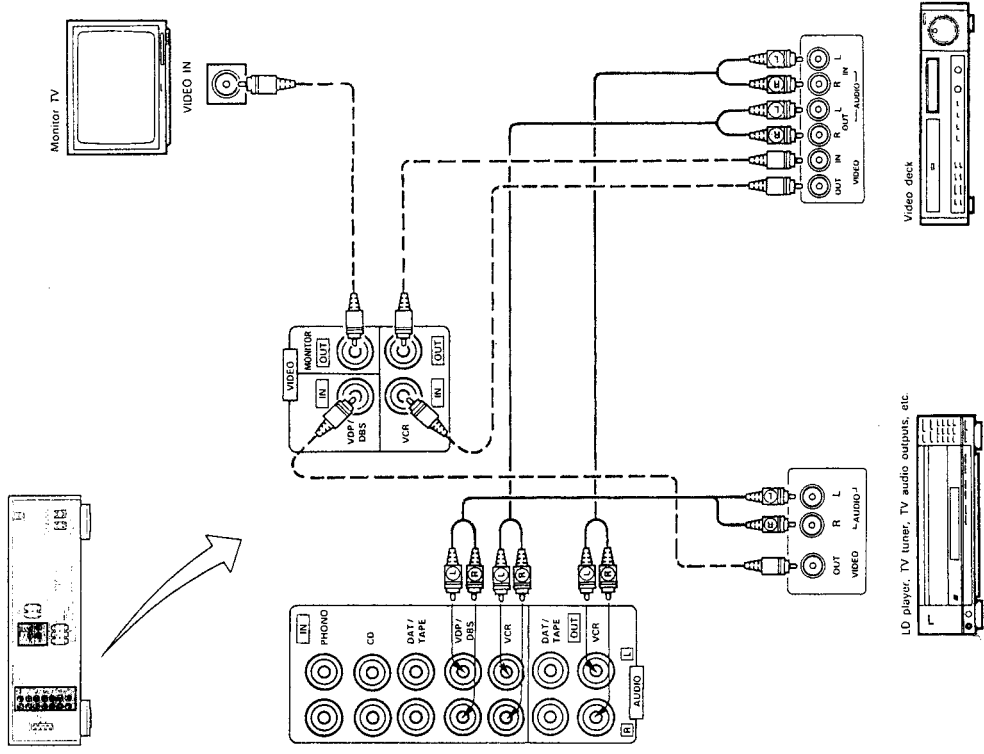

Audio Section

- Do not plug in the power cord until all connections have been completed.
- Be sure to connect the left and right channels properly (left with left, right with right).
- Insert the plugs securely. Incomplete connections will result in the generation of noise.
- Note that binding pin plug cords together with power cords or placing them near a power transformer will result in the introduction of hum or other noise.
- If hum or other noise is produced when the ground wire is connected, disconnect it.
- Noise or humming may be generated if a connected component is used independently without turning the power of the AVR-800 on. If this happens, turn on the power of the AVR-800.

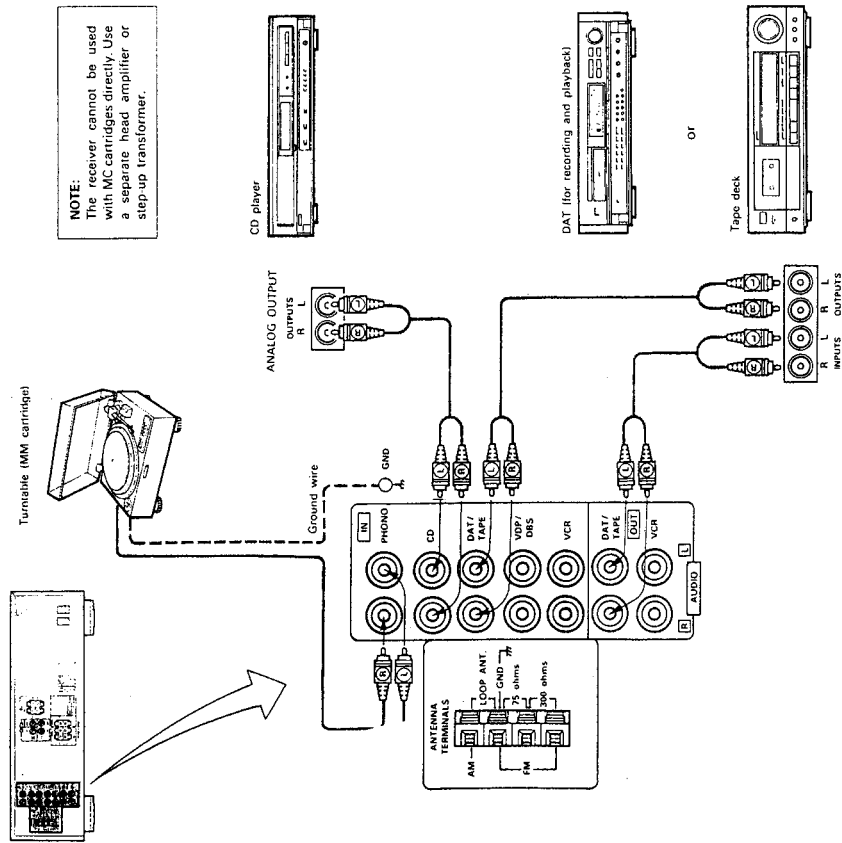

5 REMOTE CONTROL UNIT

Following the procedure outlined below, insert the batteries before using the remote control unit.

Range of operation of the remote control unit

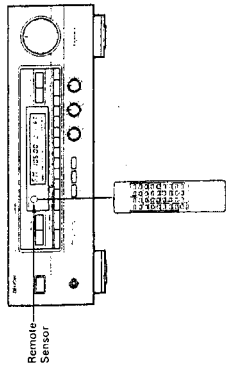

Inserting the batteries

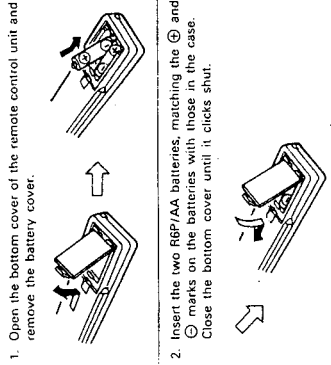

System codes

The system codes for Denon tape decks and CD players are set in this remote control unit.

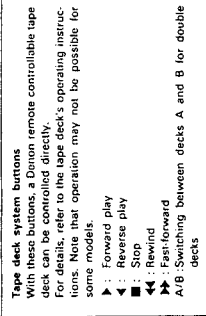

6 CONNECTIONS

Connecting the antenna terminals

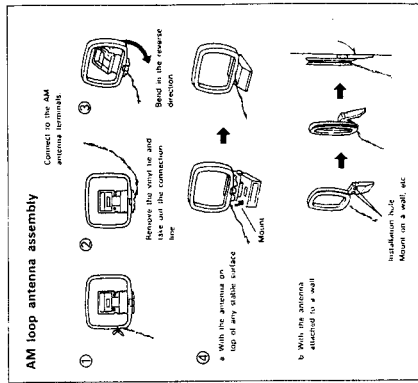

ANTENNA INSTALLATION

FM ANTENNA

The supplied T-type indoor FM antenna (300 ohms) can be used inside wooden houses for receiving local FM stations and other strong FM signals. Stretch out the ends of the antenna and mount the antenna on the wall. The antenna terminals may not consistently receive FM signals. Antennas may not consistently ensure stable reception, due to environmental changes. In such cases, the FM T-type antenna should only be used temporarily until an outdoor FM antenna has been installed. When connecting an outdoor FM antenna, the use of 75 ohm coaxial cable (3C-2V, 5C-2V) is strongly recommended. Using a 300-ohm feeder cable will cause noise and you will not be able to achieve the high sound quality the built-in tuner is capable of delivering.

AM ANTENNA

Assemble the included AM loop antenna as shown in the diagram, then place it in a position where reception is good. In some cases reception is better if the polarities are inverted. AM broadcasts will not be received well if the loop antenna is not connected or if it is connected but not a metal part. Attach the loop antenna even when using an outdoor AM antenna. Adjust the loop antenna to obtain optimum reception. Where broadcast stations are absent and only weak signals are received, the antenna should be moved. It is best to install an outdoor AM antenna.

NOTES

- This receiver has a full backup system. When the power is turned on, the INPUT SELECTOR buttons are set to the last mode set before the power was turned off.
- When using this receiver in close proximity to video equipment (TV, VCR, VDP, etc.), noise may be generated in AM broadcasts. To avoid this, keep the receiver as far away from other video components as possible. If the noise is not reduced, turn off the video components when listening to AM broadcasts.

Note to CATV system installer:
This reminder is provided to call the CATV system installer's attention to Article 820-40 of the NEC, which provides guidelines for proper grounding and, in particular, states that the grounding conductor shall be connected to the metal sheath of the coaxial cable as close to the point of cable entry as practical.

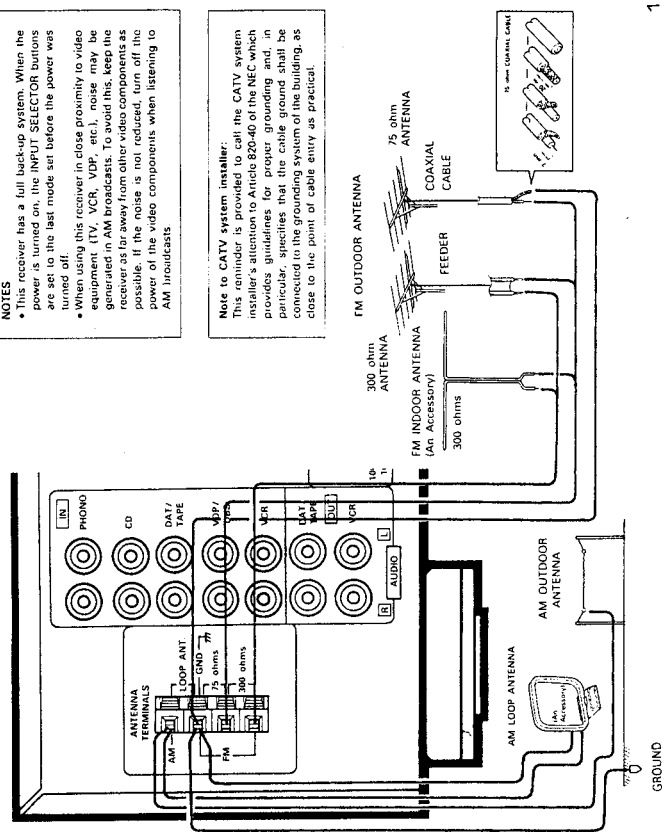

4 NAMES OF PARTS - 2 (Rear Panel)

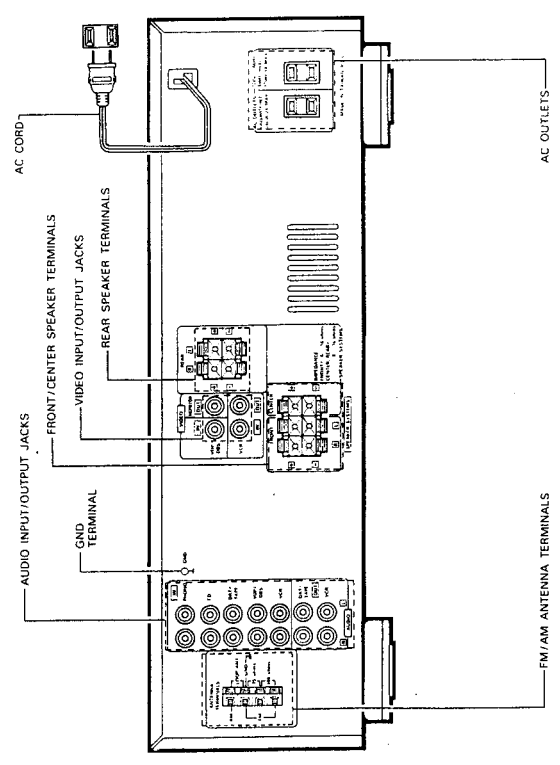

- Always turn off the power of the various components when making connections. Also refer to the operating instructions for the other components.
- Do not plug in the power cord until all connections are completed.

MULTI-VOLTAGE MODEL ONLY
Make the following settings before connecting the components.

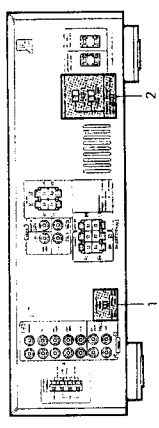

1. Setting the frequency step

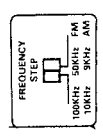

Set the FREQUENCY STEP switch as described below.

- In the U.S.A. and Canada - set the switch to 100 kHz / 10 kHz side.

With this setting, the frequency varies in 100 kHz steps in the range of 87.5 to 108.0 MHz (FM) and in 10 kHz steps in 520 to 1710 kHz (AM).

- Elsewhere - set the switch to 50 kHz / 9 kHz side.

With this setting, the frequency varies in 50 kHz steps in the range of 87.50 to 108.0 MHz (FM) and in 9 kHz steps in 522 to 1611 kHz (AM).

Only switch the frequency when the power cord is unplugged. Plug in the power cord securely after switching the frequency.

2. Setting the line voltage

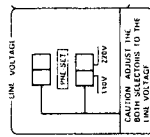

- The customer can set the VOLTAGE SELECTORS on the back panel for appropriate line voltage by using a screwdriver.
- Do not use excessive force in setting the VOLTAGE SELECTOR KNOB - you may damage it.
- If the VOLTAGE SELECTOR KNOB does not turn smoothly, contact your store of purchase.
- Be sure to set both voltage selectors to same position.

AC OUTLETS

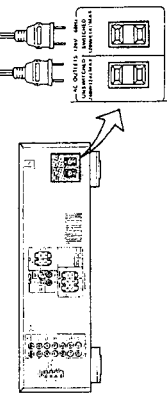

Connecting the AC Outlets

AC Outlets

- SWITCHED total capacity - 120W (1A)

The power to this outlet is turned on and off in conjunction with the POWER switch on the AVR-800. When the remote control unit is switched on, power is supplied from these outlets when the AVR-800's power is at standby. Never connect equipment whose total capacity is above 120W (1A).

- UNSWITCHED total capacity - 240W (2A)

Power is supplied from this outlet constantly, regardless of whether or not the AVR-800's power is on. Never connect equipment whose total capacity is above 240W (2A).

NOTE:
Only use the AC outlets for audio equipment. Never use them for hair driers, TVs or other electrical appliances.

2 NAMES OF PARTS - 1
(Front Panel and Remote Control Unit)

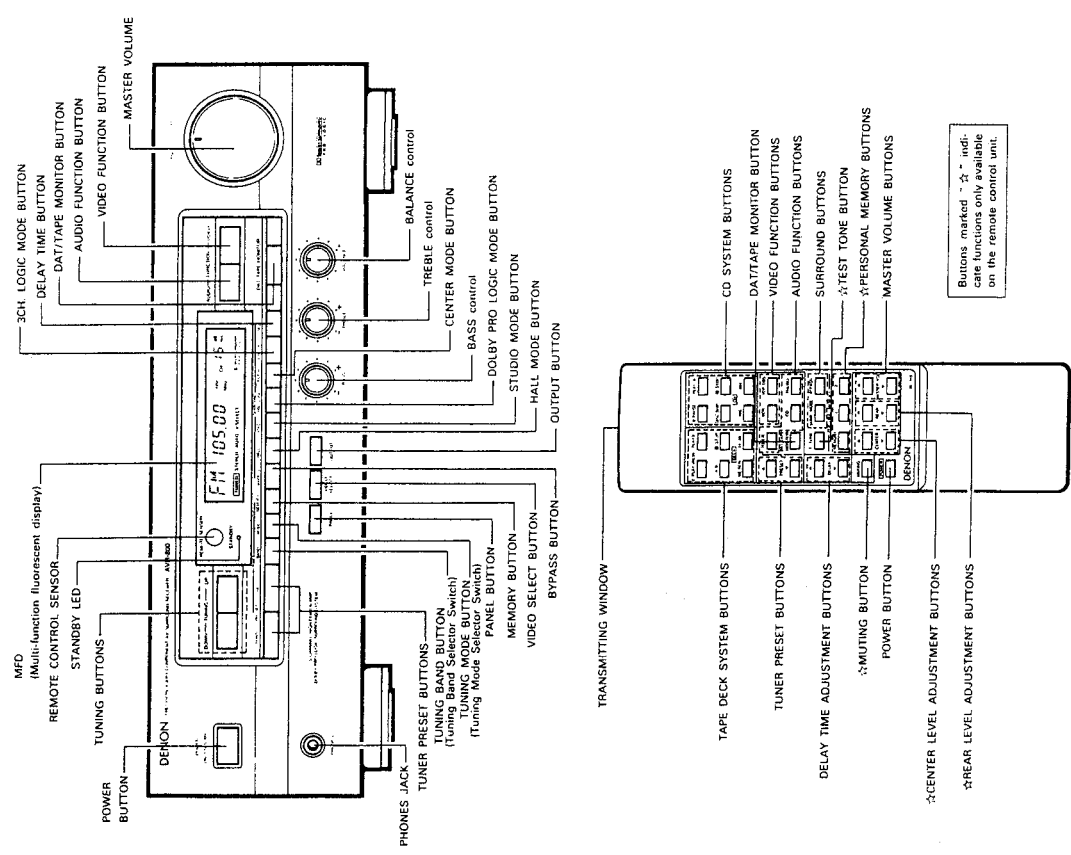

3 MULTI FUNCTION DISPLAY (MFD)

The MFD indicates the operating modes when operations are performed and when PANEL button is pressed.

■ FLD (Fluorescent Light Display)

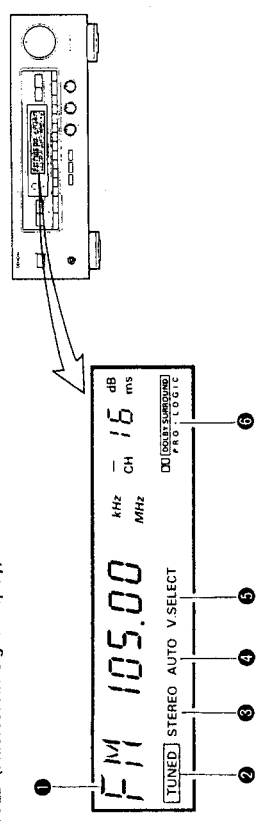

1 MULTI FUNCTION DISPLAY

Normally, the reception frequency is displayed when the function is set to tuner, and the surround mode is displayed when the function is set to other positions. The display also indicates various other information according to the buttons pressed.

2 TUNED (TUNED indicator)

This indicator lights when broadcast signals are received.

3 STEREO (Stereo Indicator)

The STEREO indicator will automatically light up when a stereo broadcast is received.

4 AUTO TUNING (AUTO TUNING Indicator)

This indicator lights when the auto tuning mode is selected by pressing the TUNING MODE button.

5 V-SELECT (VIDEO SELECT Indicator)

This indicator lights when the video monitor output is fixed in the video select mode.

6 DOLBY SURROUND Indicator

This indicator lights when DOLBY PRO LOGIC, 3CH LOGIC are selected.

■ To check the settings of the different modes

1. Press the PANEL button.

Main unit

Either hold the PANEL button in or press it repeatedly to display the settings for the different modes.

■ FLD OFF

Turning the FLD off.

1. Press and hold in the PANEL button.

{ The FLD display changes continuously and finally turns off. Now when a button is pressed, the related display appears for a few seconds then turns off automatically. }

2. Turning the FLD back on.

Press the PANEL button once again.

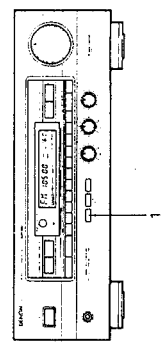

NOTE ON USE

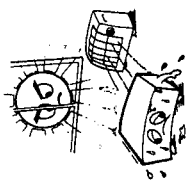

- Be careful of high temperatures**
- Do not place the set in a location where it will be exposed to direct sunlight or near a heating appliance.
- Caution on rack/cabinet installation**
- Avoid installing the set in a closed-type rack.
 - When installing in a rack or cabinet, provide a sufficiently large ventilation opening to promote heat radiation.



- Caution on humidity, water, and dust**
- Do not place the set in a location where there is high humidity or a lot of dust.
 - Flower vases or other items containing water should not be placed on top of the set.

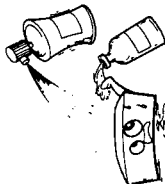

- Care of the case**
- Avoid the use of pesticides near the set as well as wiping the case with benzine, thinner or other solvents since they may cause a change in quality or color. Use a soft cloth when wiping away dirt and follow the instructions carefully when using chemically treated cloths.



- Do not open the case**
- Opening the top cover or the bottom plate of the case and inserting your hand is dangerous. Do not open the case.
 - If some trouble arises with the performance of the set, remove the power plug soon and contact the store where the set was purchased or a nearby dealer.

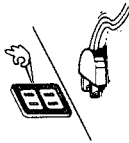

- During your absence**
- When not using the set for an extended period such as when taking a trip, be sure to disconnect the plug from the receptacle.

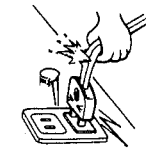

- Care with the power cord**
- When removing the plug from the receptacle, do not pull the power cord, be sure to hold the plug when removing it.

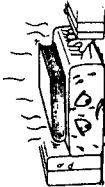

- Do not block the ventilation holes of the set**
- Blocking of the ventilation holes will lead to damage of the set.
 - The ventilation holes are very important for heat radiation from within the set. Care must be taken since placing an object against the holes will result in an extreme rise of temperature within the set.

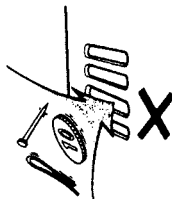

- Do not allow foreign matter into the equipment**
- Be especially careful of needles, hair pins, and coins getting into the set.

■ We greatly appreciate your purchase of the AVR-800.
 ■ To be sure you take maximum advantage of all the features the AVR-800 has to offer, read these instructions carefully and use the set properly. Be sure to keep this manual for future reference should any questions or problems arise.

ACCESSORIES

Check that the following parts are included in addition to the main unit:

- ① Operating instructions 1
- ② Warranty (for North American model only) 1
- ③ Remote control unit (RC-169) 1
- ④ R6P/AA batteries 2
- ⑤ AM loop antenna 1
- ⑥ FM indoor antenna 1

INSTALLATION PRECAUTIONS

- Using this receiver or other electronic equipment containing microprocessors simultaneously with a tuner or TV may result in noise in the sound or picture.
- If this should happen, take the following steps:
- Install the receiver as far as possible from the tuner or TV set.
 - Keep the antenna lines of the tuner or TV as far as possible from the receiver's power cord and connection cables.
 - This problem is especially frequent when using indoor antennas or 300 ohm feeder lines. We recommend using outdoor antennas and 75 ohm coaxial cables.

A note on stacking

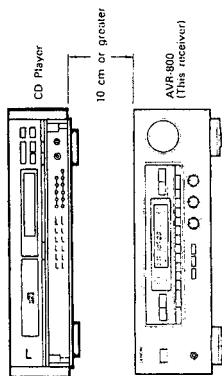

For cooling purposes, do not place another AV component directly on top of the receiver. Be sure to leave a space of at least 10 cm.

TABLE OF CONTENTS

1	Introduction	2-4
	• Safety Precautions	2
	• Safety Instructions	3
	• Note on Use	4
2	Names of Parts - 1 (Front Panel and Remote Control Unit)	6
	Multi Function Display (MFD)	7
3	Names of Parts - 2 (Rear Panel)	8, 9
4	Remote Control Unit	10
5	Connections	11-14
6	Playback	15, 16
7	Recording	16
8	Tape Monitor Function	17
9	Using Headphones	17
10	Listening to the Radio	18, 19
11	Surround Playback	20-25
12	Surround Modes	20-23
	• Using Dolby Pro Logic Surround	20-23
	• Other Surround Modes	23
	• Using the Personal Memory	24
	• Operations Possible in the Various Surround Modes	25
13	Initialization of the Microprocessor	25
14	Troubleshooting	26
15	Last Function Memory	26
16	Specifications	27
17	DENON SERVICE NETWORK	Bottom

1 INTRODUCTION

SAFETY PRECAUTIONS



CAUTION
RISK OF ELECTRIC SHOCK
DO NOT OPEN



CAUTION: TO REDUCE THE RISK OF ELECTRIC SHOCK, DO NOT REMOVE COVER (OR BACK). NO USER SERVICE-ABLE PARTS INSIDE. REFER SERVICING TO QUALIFIED SERVICE PERSONNEL.

The lightning flash with arrowhead symbol, within an equilateral triangle, is intended to alert the user to the presence of uninsulated "dangerous voltage" within the product's enclosure that may be of sufficient magnitude to constitute a risk of electric shock to persons.

The exclamation point within an equilateral triangle is intended to alert the user to the presence of important operating and maintenance (servicing) instructions in the literature accompanying the appliance.

WARNING: TO REDUCE THE RISK OF FIRE OR ELECTRIC SHOCK, DO NOT EXPOSE THIS APPLIANCE TO RAIN OR MOISTURE.

SAFETY INSTRUCTIONS

1. Read Instructions – All the safety and operating instructions should be read before the appliance is operated.
2. Retain Instructions – The safety and operating instructions should be retained for future reference.
3. Heed Warnings – All warnings on the appliance and in the operating instructions should be adhered to.
4. Follow Instructions – All operating and use instructions should be followed.
5. Water and Moisture – The appliance should not be used near water – for example, near a bathtub, washbowl, kitchen sink, laundry tub, in a wet basement, or near a swimming pool, and the like.
6. Carts and Stands – The appliance should be used only with a cart or stand that is recommended by the manufacturer.
- 6A. An appliance and cart combination should be moved with care. Quick stops, excessive force, and uneven surfaces may cause the appliance and cart combination to overturn.
7. Wall or Ceiling Mounting – The appliance should be mounted to a wall or ceiling only as recommended by the manufacturer.
8. Ventilation – The appliance should be situated so that its location or position does not interfere with its proper ventilation. For example, the appliance should not be situated on a bed, sofa, rug, or similar surface that may block the ventilation openings; or placed in a built-in installation, such as a bookcase or cabinet that may impede the flow of air through the ventilation openings.
9. Heat – The appliance should be situated away from heat sources such as radiators, heat registers, stoves, or other appliances (including amplifiers) that produce heat.
10. Power Sources – The appliance should be connected to a power supply only of the type described in the operating instructions or as marked on the appliance.
11. Grounding or Polarization – Precautions should be taken so that the grounding or polarization means of an appliance is not defeated.
12. Power-Cord Protection – Power-supply cords should be routed so that they are not likely to be walked on, or pinched by items placed upon or against them, paying particular attention to cords at plugs, convenience receptacles, and the point where they exit from the appliance.
13. Cleaning – The appliance should be cleaned only as recommended by the manufacturer.
14. Power Lines – An outdoor antenna should be located away from power lines.
15. Outdoor Antenna Grounding – If an outside antenna is connected to the receiver, be sure the antenna system is grounded so as to provide some protection against voltage surges and built-up static charges. Article 810 of the National Electrical Code, ANSI/NFPA 70, provides information with regard to proper grounding of the mast and supporting structure, grounding of the lead-in wire to an antenna-discharge unit, size of grounding conductors, location of antenna-discharge unit, connection to grounding electrodes, and requirements for the grounding electrode. See Figure A.
17. Nonuse Periods – The power cord of the appliance should be unplugged from the outlet when left unused for a long period of time.
18. Object and Liquid Entry – Care should be taken so that objects do not fall and liquids are not spilled into the enclosure through openings.
19. Damage Requiring Service – The appliance should be serviced by qualified service personnel when:
 - A. The power-supply cord or the plug has been damaged; or
 - B. Objects have fallen, or liquid has been spilled into the appliance; or
 - C. The appliance has been exposed to rain; or
 - D. The appliance does not appear to operate normally or exhibits a marked change in performance; or
 - E. The appliance has been dropped, or the enclosure damaged.
20. Servicing – The user should not attempt to service the appliance beyond that described in the operating instructions. All other servicing should be referred to qualified service personnel.

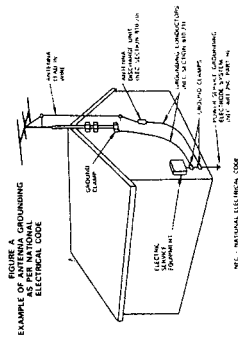

(Rear Panel)
(Rückseite)
(Panneau arrière)
(Pannello posteriore)

(Panel trasero)
(Achterpaneel)
(Bakpanelen)

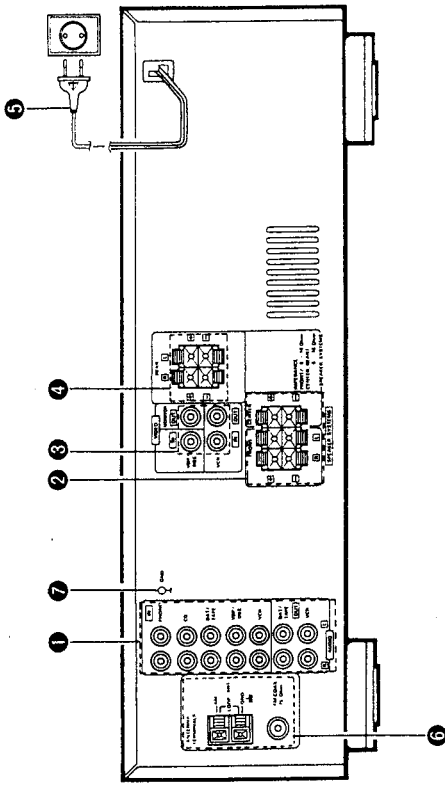

FOR ENGLISH READERS

- 1 AUDIO INPUT/OUTPUT JACKS
- 2 FRONT/CENTER SPEAKER TERMINALS
- 3 VIDEO INPUT/OUTPUT JACKS
- 4 REAR SPEAKER TERMINALS
- 5 AC CORD
- 6 FM/AM ANTENNA TERMINALS
- 7 GND (Grounding terminal)

FÜR DEUTSCHE LESER

- 1 Audio Eingangs-/Ausgangs-Buchsen
- 2 (AUDIO INPUT/OUTPUT)
- 3 Lautsprecheranschlüsse (für Vorne und Mitte)
- 4 (FRONT/CENTER SPEAKER)
- 5 Video-Eingangs-/Ausgangs-Buchsen
- 6 (VIDEO INPUT/OUTPUT)
- 7 Anschlüsse für Hecklautsprecher
- 8 (REAR SPEAKER)
- 9 Netzkabel
- 10 UKW/MW-Antennenanschlüsse
- 11 (FM/AM ANTENNA)
- 12 GND (Masseanschluss)

- POUR LES LECTEURS FRANÇAIS**
- 1 PRISES D'ENTRÉE/SORTIE AUDIO (AUDIO INPUT/OUTPUT)
 - 2 BORNES D'ENCEINTE AVANT/CENTRALE (FRONT/CENTER SPEAKER)
 - 3 PRISES D'ENTRÉE/SORTIE VIDEO (VIDEO INPUT/OUTPUT)
- PER IL LETTORE ITALIANO**
- 1 PRESE DI INGRESSO/USCITA AUDIO CENTRALI (ANTERIORI/POSTERIORI)
 - 2 TERMINALI DEGLI ALTOPARLANTI CENTRALI (ANTERIORI/POSTERIORI)
 - 3 PRESE DI INGRESSO/USCITA VIDEO
- PARA LECTORES DE ESPAÑOL**
- 1 CONECTORES DE ENTRADA/SALIDA DE AUDIO CENTRAL (DELANTEROS/DETRASEROS)
 - 2 TERMINALES DE ALTAVOCES CENTRAL (DELANTEROS/DETRASEROS)
 - 3 CONECTORES DE ENTRADA/SALIDA DE VIDEO
- VOOR NEDERLANDSTALIGE LEZERS**
- 1 AUDIO-INGOER-/UITVOERAANSLUITINGEN (AUDIO INPUT/OUTPUT)
 - 2 AANSLUITPUNTEN VOORSTEL/ MIDDENLUIDSPREKERS (FRONT/CENTER SPEAKER)
 - 3 VIDEO-INGOER-/UITVOERAANSLUITINGEN (VIDEO INPUT/OUTPUT)
- FÖR SVENSKA LÄSARE**
- 1 Audioingångar och -utgångar (AUDIO INPUT/OUTPUT)
 - 2 Anslutningar för framre/mitthögtalare (FRONT/CENTER SPEAKER)
 - 3 Videoingångar och -utgångar (VIDEO INPUT/OUTPUT)
- POUR LES LECTEURS FRANÇAIS**
- 4 BORNES D'ENCEINTE ARRIERE (REAR SPEAKER)
 - 5 CORDON SECTEUR (BORNES D'ENTRÉE)
 - 6 BORNES D'ANTENNE FM/AM (FM/AM ANTENNA)
 - 7 GND (Borne de mise à la masse)
- TERMINALI DEGLI ALTOPARLANTI POSTERIORI**
- 4 CAVO CA
 - 5 TERMINALI DELL'ANTENNA FM/AM
 - 7 GND (Terminale di massa)
- TERMINALES DE ALTAVOCES TRASEROS**
- 4 CABLE DE ALIMENTACION DE CA
 - 5 TERMINALES DE ANTENA DE FM/AM
 - 7 GND (Terminal de conexión a tierra)
- AANSLUITPUNTEN ACHTERSTE LUIDSPREKERS**
- 4 NETKABEL
 - 5 AANSLUITPUNTEN FM/AM-ANTENNE
 - 7 GND (Aardingsaansluitpunt)
- Anslutningar för bakre högtalare (REAR SPEAKER)**
- 4 Naiståed
 - 5 Anslutningar för FM-/AM-antenn (FM/AM ANTENNA)
 - 7 GND (Jordpunkt)

- Always turn off the power of the various components when making connections. Also refer to the operating instructions for the other components.
- Do not plug in the power cord until all connections are completed.
- Schalten Sie beim Vornehmen von Anschlüssen immer den Strom zu den verschiedenen Komponenten aus. Beziehen Sie sich darüberhinaus auf die Bedienungsanleitungen für die anderen Komponenten.
- Schließen Sie das Netzkabel nicht an, bevor alle anderen Anschlüsse komplett ausgeführt worden sind.
- Mettre toujours les divers appareils hors circuit lors de la réalisation des connexions. Se reporter également aux modes d'emploi des autres appareils.
- Ne pas brancher le cordon d'alimentation avant d'avoir terminé toutes les connexions.
- Spagnete sempre la corrente dei vari componenti prima di fare i collegamenti. Inoltre, fate riferimento al manuale di ciascun componente.
- Non inserite il filo di alimentazione finché tutti i collegamenti non saranno stati fatti.
- Antes de hacer las conexiones, desconecte la alimentación a los distintos componentes. Consulte también los manuales de instrucciones de los componentes en uso.
- No conecte el cable de alimentación hasta haber finalizado todas las conexiones.
- Schakel altijd de spanning van de verschillende componenten uit wanneer u aansluitingen maakt. Raadpleeg ook de gebruiksaanwijzing van de andere componenten.
- Steek het netsnoer pas in als alle aansluitingen tot stand zijn gebracht.
- Kom alltid ihåg att stänga av alla apparater innan du ändrar några anslutningar. Läs respektive bruksanvisningar för närmare upplysningar.
- Nätkabeln skall inte sättas i vägguttaget förrän alla andra anslutningar är klara.

(Remote Control Unit)
(Fernbedienungsgerät)
(Télécommande)
(Telecomando)

(Unidad de Control Remoto)
(Afstandsbediening)
(Fjärrkontroll)

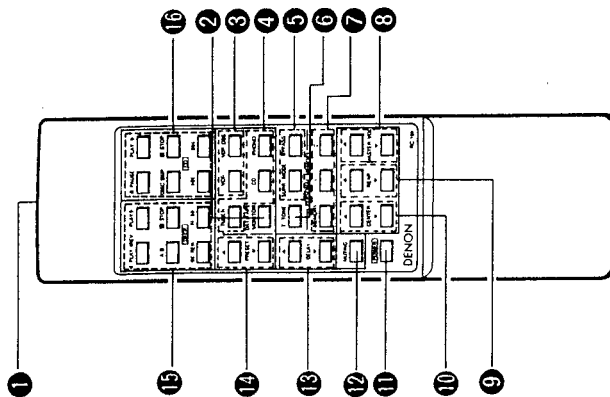

- FOR ENGLISH READERS**
- 1 TRANSMITTING WINDOW
 - 2 DAT/TAPE MONITOR BUTTON
 - 3 VIDEO FUNCTION BUTTONS
 - 4 AUDIO FUNCTION BUTTONS
 - 5 SURROUND BUTTONS
 - 6 TEST TONE BUTTON
 - 7 PERSONAL MEMORY BUTTONS
 - 8 MASTER VOLUME BUTTONS
 - 9 REAR LEVEL ADJUSTMENT BUTTONS
 - 10 CENTER LEVEL ADJUSTMENT BUTTONS
 - 11 POWER BUTTON
 - 12 MUTING BUTTON
 - 13 DELAY TIME ADJUSTMENT BUTTONS
 - 14 TUNER PRESET BUTTONS
 - 15 TAPE DECK SYSTEM BUTTONS
 - 16 CD SYSTEM BUTTONS

Buttons marked "☆" indicate functions only available on the remote control unit.

- FÜR DEUTSCHE LESER**
- 1 Übertragungsfenster (TRANSMITTING WINDOW)
 - 2 Datum/Band Überwachungsstaste (DAT/TAPE MONITOR)
 - 3 Video-Funktionstasten (VIDEO FUNCTION)
 - 4 Audio-Funktionstasten (AUDIO FUNCTION)
 - 5 Klangumgebungs-Tasten (SURROUND)
 - 6 Testton Taste (TEST TONE)
 - 7 Persönliche Speichertasten (PERSONAL MEMORY)
 - 8 Hauptlautstärke-Tasten (MASTER VOLUME)
 - 9 Einstellungsstasten für hintere Stufe (REAR LEVEL ADJUSTMENT)
 - 10 Einstellungsstasten für Mittelstufe (CENTER LEVEL ADJUSTMENT)
 - 11 Netzstaste (POWER)
 - 12 Stummumschaltungs-Taste (MUTING)
 - 13 Einstellungsstasten für Zeitverzögerung (DELAY TIME ADJUSTMENT)
 - 14 Tuner-Voreinstellungs-Tasten (TUNER PRESET)
 - 15 Systemtasten für Tape Deck (TAPE DECK SYSTEM)
 - 16 CD-Systemtasten (CD SYSTEM)

Die mit "☆" markierten Tasten zeigen Funktionen an, die nur mit Hilfe des Fernbedienungsgerätes aktiviert werden können.

POUR LES LECTEURS FRANCAIS

- 1 FENÊTRE D'ÉMISSION
- 2 TOUCHÉ DAT/CONTROLE DE BANDE (DAT/MONITOR)
- 3 TOUCHES DE FONCTION VIDEO (VIDEO FUNCTION)
- 4 TOUCHES DE FONCTION AUDIO (AUDIO FUNCTION)
- 5 TOUCHES D'AMBIANCE (SURROUND)
- 6 TOUCHÉ DE TONALITÉ TEST (TONE TEST)
- 7 TOUCHES DE MÉMOIRE PERSONNALISÉE (PERSONAL MEMORY)
- 8 TOUCHES DE VOLUME GLOBAL (MASTER VOLUME)
- 9 TOUCHES DE RÉGLAGE DE NIVEAU ARRIÈRE (REAR LEVEL)
- 10 TOUCHES DE RÉGLAGE DE NIVEAU CENTRAL (CENTER LEVEL)

PER IL LETTORE ITALIANO

- 1 FINESTRELLA DI TRASMISSIONE
- 2 TASTO DELLA PIASTRA DAT/MONITORAGGIO DEL NASTRO
- 3 TASTI DELLA FUNZIONE VIDEO
- 4 TASTI DELLA FUNZIONE AUDIO
- 5 TASTI SURROUND
- 6 TASTO DEL TONO DI PROVA
- 7 TASTI DELLA MEMORIA PERSONALE
- 8 TASTI DEL VOLUME PRINCIPALE
- 9 TASTI DI REGOLAZIONE DEL LIVELLO POSTERIORE
- 10 TASTI DI REGOLAZIONE DEL LIVELLO CENTRALE

PARA LECTORES DE ESPAÑOL

- 1 VENTANILLA TRANSMISORA
- 2 BOTÓN DAT/TAPE MONITOR
- 3 BOTONES SELECTORES DE ENTRADA DE VIDEO
- 4 BOTONES DE SONIDO ENVOLVENTE
- 5 BOTÓN DE TONO DE PRUEBA (TEST TONE)
- 6 BOTONES DE MEMORIA PERSONAL
- 7 BOTONES DE VOLUMEN PRINCIPAL
- 8 BOTONES DE AJUSTE DE NIVEL TRASERO (REAR LEVEL)
- 9 BOTONES DE AJUSTE DE NIVEL CENTRAL (CENTER LEVEL)

VOOR NEDERLANDSTALIGE LEZERS

- 1 ZENDEVENSTERJE
- 2 DAT/TAPE-MEELUISTERTOETS
- 3 VIDEOFUNKTIEOETSEN (VIDEO FUNCTION)
- 4 AUDIOFUNKTIEOETSEN (AUDIO FUNCTION)
- 5 SURROUND-TOETSEN
- 6 TESTTOONTOETS (TEST TONE)
- 7 PERSOONLIJK GEHEUGENTOETSEN (PERSONAL MEMORY)
- 8 HOOFDVOLUME TOETSEN (MASTER VOLUME)
- 9 ACHTERNIVEAU-INSTELTOETSEN (REAR LEVEL ADJUSTMENT)
- 10 MIDDENNIVEAU-INSTELTOETSEN (CENTER LEVEL ADJUSTMENT)

FÖR SVENSKA LÄSARE

- 1 Sändarfönster
- 2 DAT-/däckomkopplare (DAT/TAPE MONITOR)
- 3 Videotangenter (VIDEO FUNCTION)
- 4 Audiotangenter (AUDIO FUNCTION)
- 5 SURROUND-tangenter
- 6 Testton tangent (TEST TONE)
- 7 Tangenter för användarminne (PERSONAL MEMORY)
- 8 Ljudstyrketangenter (MASTER VOLUME)
- 9 Tangenter för justering av den bakre nivån (REAR LEVEL ADJUSTMENT)
- 10 Tangenter för justering av mittkanalnivån (CENTER LEVEL ADJUSTMENT)

- 11 TOUCHE D'ALIMENTATION (POWER)
- 12 TOUCHÉ DE SOURDINE (MUTING)
- 13 TOUCHÉ DE RÉGLAGE DE RETARD (DELAY TIME ADJUSTMENT)
- 14 TOUCHES PRÉREGLAGE DE TUNER (TUNER PRESET)
- 15 TOUCHES DE SYSTÈME DE PLATINE CASSETTE (TAPE DECK SYSTEM)
- 16 TOUCHES DE SYSTÈME CD (CD SYSTEM)

Les touches marquées "☆" indiquent des fonctions disponibles seulement sur la télécommande.

- 11 TASTO DI ACCENSIONE
- 12 TASTO DI SILENCIAMENTO (MUTING)
- 13 TASTI DI REGOLAZIONE DELLA DURATA DEL RITARDO
- 14 TASTI DI PRESELEZIONE DEL SINTONIZZATORE
- 15 TASTI DELLA PIASTRA A CASSETTE
- 16 TASTI DEL SISTEMA CD

I tasti che recano il marchio "☆" indicano funzioni che sono disponibili solo usando il telecomando.

- 11 INTERRUPTOR DE ALIMENTACION
- 12 BOTÓN DE SILENCIAMIENTO (MUTING)
- 13 BOTONES DE AJUSTE DE TIEMPO DE RETARDO
- 14 BOTONES DE PRESINTONIZACION
- 15 BOTONES DE MAGNETOFONO DE CASSETTES
- 16 BOTONES DE REPRODUCTOR CD

Los botones marcados "☆" indican funciones sólo disponibles en la unidad de control remoto.

- 11 SPANNINGSTOETS (POWER)
- 12 DEMPINGSTOETS (MUTING)
- 13 VERTRAGINGSTIJD-INSTELTOETSEN (DELAY TIME ADJUSTMENT)
- 14 TUNER-VOORKEUZE TOETSEN (TUNER PRESET)
- 15 TAPEDECK-SYSTEEMTOETSEN (TAPE DECK SYSTEM)
- 16 CD-SYSTEEMTOETSEN (CD SYSTEM)

De met "☆" gemerkte toetsen duiden functies aan die enkel met de afstandsbediening kunnen worden gebruikt.

- 11 Strömbrytare (POWER)
- 12 Dämpplangent (MUTING)
- 13 Tangenter för justering av tidsfördröjningen (DELAY TIME ADJUSTMENT)
- 14 Snabbvalstangenter (TUNER PRESET)
- 15 Systemtangenter för kassettdäcket (TAPE DECK SYSTEM)
- 16 CD-tangenter (CD SYSTEM)

Tangenter märkta "☆" motsvarar funktioner som bara kan utnyttjas via fjärrkontrollen.

3 REMOTE CONTROL UNIT

Following the procedure outlined below, insert the batteries before using the remote control unit.

Range of operation of the remote control unit

Point the remote control unit at the remote control sensor as shown on the diagram at the left.

NOTES:

- The remote control unit can be used from a straight distance of approximately 7 meters, but this distance will shorten or operation will become difficult if there are obstacles between the remote control unit and the remote control sensor, if the remote control sensor is exposed to direct sunlight or other strong light, or if operated from an angle.
- Neon signs or other devices emitting pulse-type noise nearby may result in malfunction, so keep the set as far away from such devices as possible.

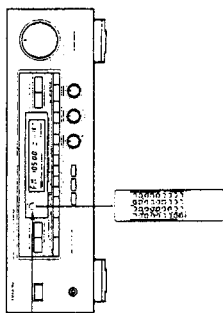

Inserting the batteries

1. Open the bottom cover of the remote control unit and remove the battery cover.

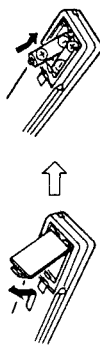

2. Insert the two R6P/AA batteries, matching the (+) and (-) marks on the batteries with those in the case. Close the bottom cover until it clicks shut.



- #### NOTES
- Use only R6P, AA, UM3 batteries for replacement.
 - Be sure the polarities are correct. (See the illustration inside the battery compartment.)
 - Remove the batteries if the remote control transmitter will not be used for an extended period of time.
 - If batteries leak, dispose of them immediately. Avoid touching the leaked material or letting it come in contact with clothing, etc. Clean the battery compartment thoroughly before installing new batteries.
 - When replacing the batteries, always replace both batteries with new ones.

We greatly appreciate your purchase of the AVR-800. To be sure you take maximum advantage of all the features the AVR-800 has to offer, read these instructions carefully and use the set properly. Be sure to keep this manual for future reference should any questions or problems arise.

ACCESSORIES

Check that the following parts are included in addition to the main unit:

- Operating instructions 1
- Warranty (for North American model only) 1
- Remote control unit 2
- AM loop antenna 1
- R6P/AA batteries 2
- FM indoor antenna 1
- RC-168 1

INSTALLATION PRECAUTIONS

Using this receiver or other electronic equipment containing microprocessors simultaneously with a tuner or TV may result in noise in the sound or picture. If this should happen, take the following steps:

- Install the receiver as far as possible from the tuner or TV set.
- Keep the antenna lines of the tuner or TV as far as possible from the receiver's power cord and connection cables.
- This problem is especially frequent when using indoor antennas or 300 ohm leader lines. We recommend using outdoor antennas and 75 ohm coaxial cables.

A note on stacking

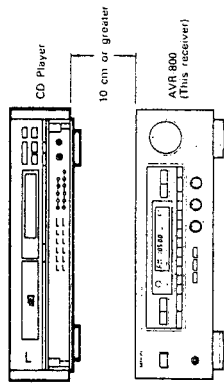

For cooling purposes, do not place another AV component directly on top of the receiver. Be sure to leave a space of at least 10 cm.

TABLE OF CONTENTS

1 Introduction	2
• Note on Use	2
2 Names of Parts	3-5
• Front Panel	3
• Remote Control Unit	4
• Rear Panel	5
3 Remote Control Unit	6
4 Multi Function Display (MFD)	7
5 Connections	7-9
6 Playback	9, 10
7 Recording	10
8 Tape Monitor Function	10
9 Using Headphones	10
10 Listening to the Radio	11
11 Surround Playback	12-14
• Surround Modes	12, 13
• Using Dolby Pro Logic Surround	13
• Other Surround Modes	13
• Using the Personal Memory	14
• Operations Possible in the Various Surround Modes	14
12 Initialization of the Microprocessor	14
13 Troubleshooting	15
14 Last Function Memory	15
15 Specifications	15
16 DENON SERVICE NETWORK	15
	76, 77

System codes

The system codes for Denon tape decks and CD players are set in this remote control unit.

Tape deck system buttons
With these buttons, a Denon remote controllable tape deck can be controlled directly.
For details, refer to the tape deck's operating instructions. Note that operation may not be possible for some models.

- ▶ : Forward play
- ◀ : Reverse play
- : Stop
- ◀▶ : Rewind
- ▶◀ : Fast-forward
- A/B : Switching between decks A and B for double decks

CD system buttons
Denon remote controllable CD with these buttons, select and play CD.
For details, refer to the CD player's operating instructions. Note that operation may not be possible for some models.

- ▶ : Play
- : Pause
- : Stop
- ◀▶ and ▶◀ : Auto search (reverse and forward)
- ▶◀▶ : CD changer, disc skip

4 MULTI FUNCTION DISPLAY (MFD)

The MFD indicates the operating modes when operations are performed and when PANEL button is pressed.

■ FLD (Fluorescent Light Display)

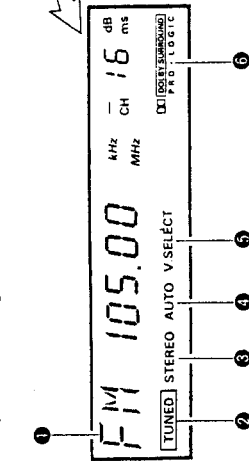

- 1 **MULTI FUNCTION DISPLAY**
Normally, the reception frequency is displayed when the function is set to tuner, and the surround mode is displayed when the function is set to other positions. The display also indicates various other information according to the buttons pressed.
- 2 **TUNED (TUNED indicator)**
This indicator lights when broadcast signals are received.
- 3 **STEREO (Stereo Indicator)**
The STEREO indicator will automatically light up when a stereo broadcast is received.
- 4 **AUTO TUNING (AUTO TUNING Indicator)**
This indicator lights when the auto tuning mode is selected by pressing the TUNING MODE button.
- 5 **V SELECT (VIDEO SELECT Indicator)**
This indicator lights when the video monitor output is fixed in the video select mode.
- 6 **DOLBY SURROUND Indicator**
This indicator lights when DOLBY PRO LOGIC, 3CH, LOGIC are selected.

■ To check the settings of the different modes

1. Press the **PANEL** button.

Main unit

■ **FLD OFF**

- Turning the FLD off.
1. Press and hold in the **PANEL** button.
(The FLD display changes continuously and finally turns off. Now when a button is pressed, the related display appears for a few seconds then turns off automatically.)
 2. Turning the FLD back on.
Press the **PANEL** button once again.

5 CONNECTIONS

Connecting the antenna terminals

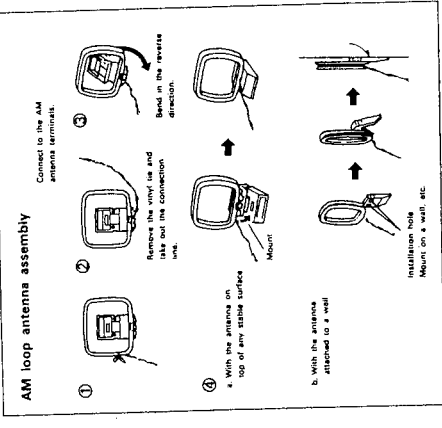

ANTENNA INSTALLATION

• **FM ANTENNA**
The supplied T-type indoor FM antenna (300 ohms) can be used inside wooden houses for receiving local FM stations and other strong FM signals. Stretch out the ends of the antenna and mount the antenna on the wall or ceiling where optimum reception is achieved. FM T-type antennas may be environmentally changed. In such cases, the FM T-type antenna should be used temporarily until an outdoor FM antenna has been installed.
When connecting an outdoor FM antenna, the use of 75 ohm coaxial cable (3C-2V, 5C-2V) is strongly recommended. Using a 300-ohm leader cable will cause noise and you will not be able to achieve the high sound quality the built-in tuner is capable of delivering.

• **AM ANTENNA**
Assemble the included AM loop antenna as shown in the diagram. Then, place the antenna where reception is good. The antenna's reception is better if you point it toward AM broadcasts. It will not be used until the loop antenna is not connected or if it is connected but near a metal part.
Attach the loop antenna even when using an outdoor AM antenna.
Adjust the loop antenna to obtain optimum reception. Where broadcast stations are distant and only weak signals are received, or where signals are blocked, it is best to install an outdoor AM antenna.

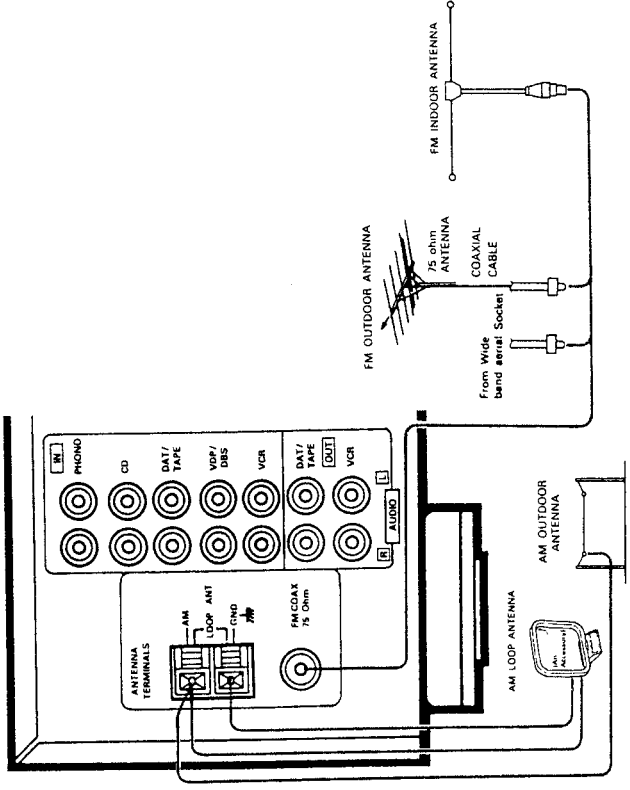

Audio Section

- Do not plug in the power cord until all connections have been completed.
- Be sure to connect the left and right channels properly (left with left, right with right).
- Insert the plugs securely. Incomplete connections will result in the generation of noise.

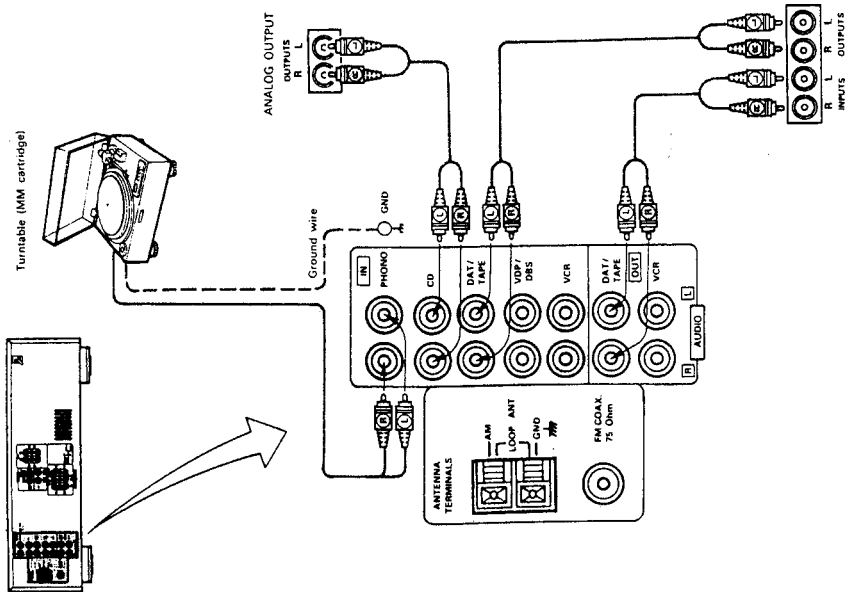

NOTE:
The receiver cannot be used with MC cartridges directly. Use a separate head amplifier or step-up transformer.

Video Section

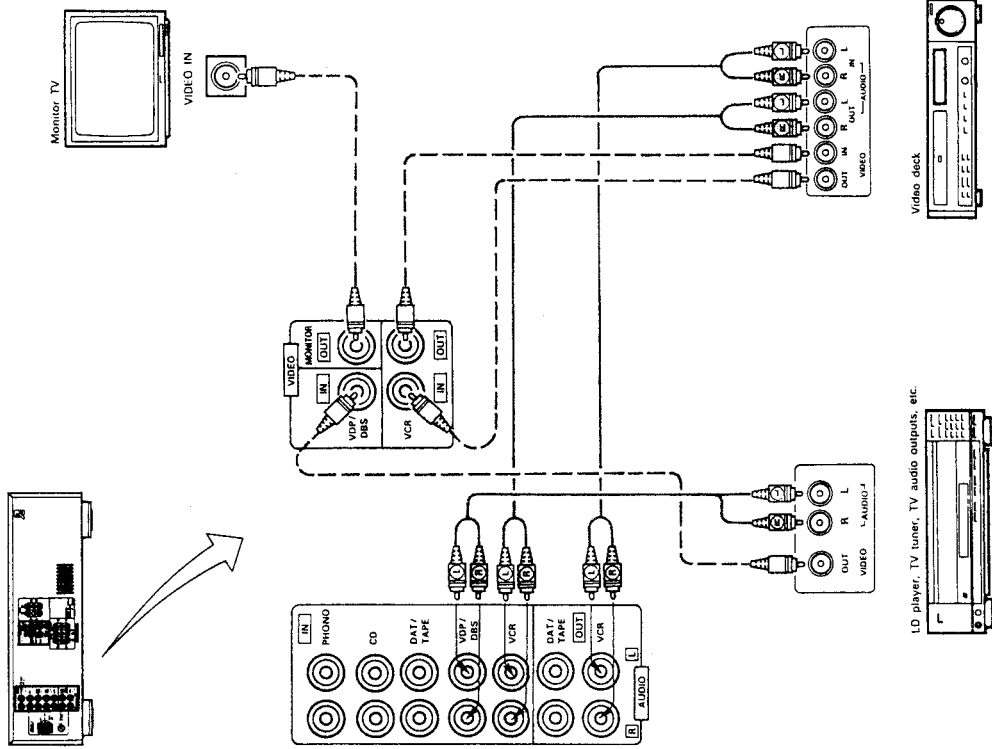

6 PLAYBACK

Preparations for Playback

- Check the connections
- Check that all connections are proper, referring to the connections diagrams (pages 7 to 9).

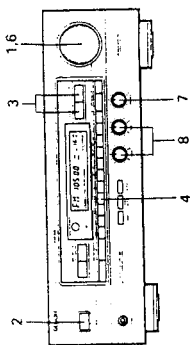

Playing the program source (normal stereo playback)

<p>1. Set the MASTER VOLUME control to the minimum.</p>	<p>4. Press the BYPASS button.</p>
<p>2. Press the POWER button to turn the power on. The muting mode is set for several seconds, after which the STANDBY LED flashes for several seconds.</p>	<p>5. Start playback the source. For instructions, refer to the source's operating instructions.</p>
<p>3. Select the source to be played. Audio function button Example: PHONO, CD or TUNER can be selected directly.</p>	<p>6. Adjust the volume. Turn the control clockwise to increase the volume, counterclockwise to decrease it.</p>
<p>Video function button Example: VDP/DBS and VCR can be selected directly. The source switches as shown above MFD.</p>	<p>7. Adjust the left/right balance. Turn the control counterclockwise to reduce the volume of the right channel, clockwise to reduce the volume of the left channel.</p>
<p>Adjust the tone. Turn the control clockwise to increase the bass, counterclockwise to decrease it.</p>	<p>8. Adjust the tone. Turn the control clockwise to increase the treble, counterclockwise to decrease it.</p>

NOTE:
The sound may be interrupted if switches are operated during playback. This is because the muting circuit is activated to prevent switching noise.

Speaker System Connections

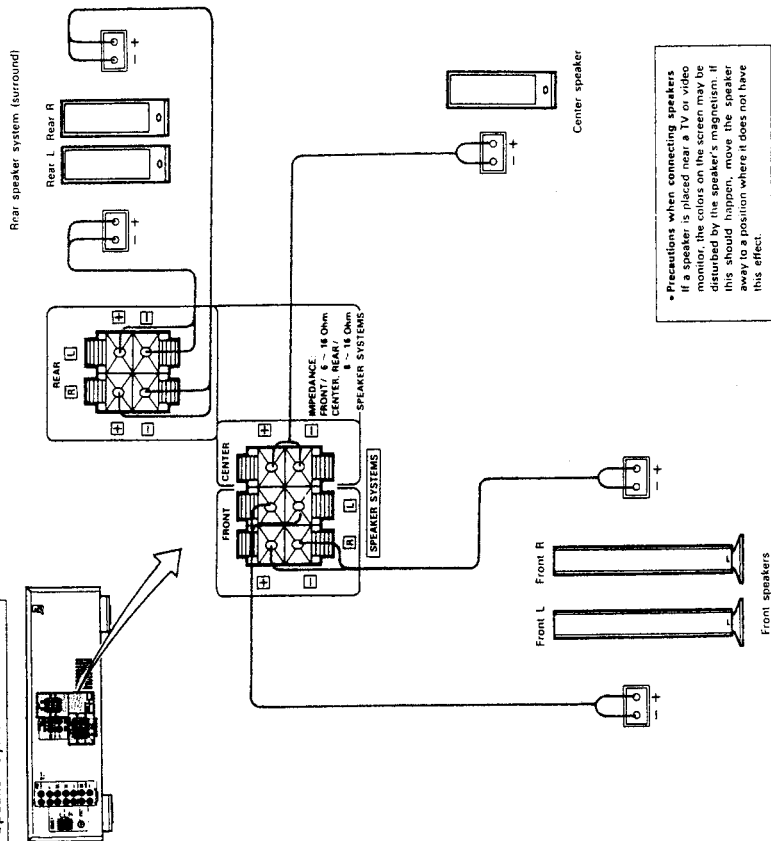

<p>Preparing the cord</p> <p>1. Peel off the sheath.</p>	<p>Connecting the center and rear speaker terminals.</p> <p>1. Press the lever.</p>
<p>2. Twist the wires.</p>	<p>2. Insert the cord and release the lever.</p>

- This receiver can accommodate connections of a total of five speakers including one set of front speakers, one set of rear speakers, and one center speaker.
- Connect the speaker terminals with the speakers making sure that like polarities are matched (⊕ with ⊕, ⊖ with ⊖). Mismatching of polarities will result in weak central sound, unclear orientation of the various instruments, and the sense of direction of the stereo being impaired.
- When making connections, take care that none of the individual conductors of the speaker cord come in contact with adjacent terminals, with other speaker cord conductors, or with the rear panel.
- Speaker impedance**
 - Speakers with an impedance of 6 to 16 ohms can be connected for use as front speakers 8 to 16 ohms can be connected for use as center and rear speakers.
 - Using speakers with an impedance other than the specified one may result in damage. Be sure to use speakers of the specified impedance.

8 Simulcast playback (playing different video and audio sources simultaneously)

1. Follow steps 1 to 3 under "Playing the program source".

2. Press the VIDEO SELECT button until the desired video source is displayed on the MFD.

The source switches as shown above.

3. Follow steps 4 to 8 under "Playing the program source".

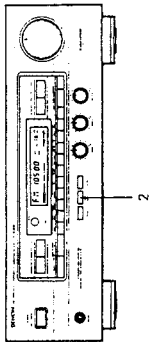

Cancelling simulcast playback

- Press the VIDEO SELECT button again.
- Press the video function button on the main unit or remote control unit.

9 Using the muting function
Use this to turn off the audio output temporarily.

1. Press the MUTING button.

This function can only be set from the remote control unit. The STANDBY LED flashes when the muting function is set.

2. Press the MUTING button again. The muting function is cancelled.

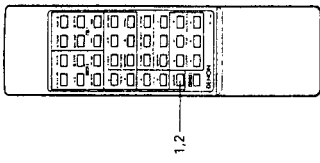

8 TAPE MONITOR FUNCTION

When playing a DAT or tape deck
Use this function to switch between the DAT or tape deck and the input (source) selected with the audio or video function buttons.

1. Follow steps 1 and 2 under "Playing the program source".

2. Select the deck to be played.

The source switches as shown at the left.

3. Follow steps 5 to 8 under "Playing the program source".

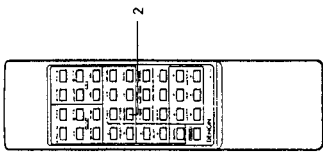
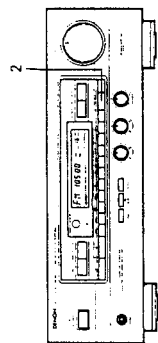

9 Monitoring the recording on a three-headed tape deck

The sound actually being recorded can be monitored during recording when a three-headed tape deck is used.

1. Select the deck to be monitored.

The source switches as shown at the left.

2. Follow steps 1 to 3 under "Playing the program source".

3. Start recording on the tape deck. For instructions, refer to the component's operating instructions.

4. Press the three-headed tape deck's source/tape button to monitor the recording.

NOTE:

- Also refer to the three-headed tape deck's operating instructions.

7 RECORDING

Recording the program source
(recording the source currently being monitored)

1. Follow steps 1 to 3 under "Playing the program source".

2. Start recording on the tape or video deck. For instructions, refer to the component's operating instructions.

NOTE:

The recording source switches if the audio function, video function, personal memory "1" or "2" or tuner preset buttons are pressed during recording. Do not press these buttons during recording.

Simultaneous recording

The signals of the source selected with the function selector button are output simultaneously to the DAT/TAPE and VCR REC OUT jacks. If a total of two tape and/or video decks are connected and set to the recording mode, the same source can be recorded simultaneously on both decks. In addition, if the TAPE MONITOR (DAT/TAPE) button is pressed, the audio signals from the tape deck are output to the VCR AUDIO REC OUT jacks.

9 USING HEADPHONES

The sound from the speakers can be turned off using the OUTPUT button to listen to the sound over the headphones only, for example at night.

1. Press the OUTPUT button.

"H/P ONLY" appears on the MFD.

2. Insert the headphones' plug into the headphones' jack.

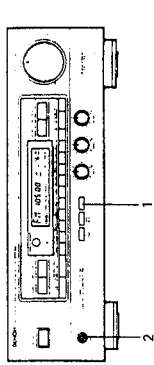

Cancelling
Either press the OUTPUT button again or press the POWER button to turn off the power.

10 LISTENING TO THE RADIO

Tuning

- Set the input function to "TUNER".
- Select the reception band.

There is a change as mentioned at the left, and indication ① inside the MFD changes.

FM

AM
- Select the tuning mode.

The mode switches as shown at the left. When the auto mode is set, "AUTO" lights on the MFD ②.

MANUAL

Set the auto mode for automatic tuning, the manual mode for manual tuning.
- Tune in the station.

In the manual tuning mode:
Press the UP button once to increase the frequency by one step, the DOWN button once to decrease the frequency by one step.
The frequency changes continuously when the buttons are held in.
The "TUNED" indicator ③ lights on the MFD when a station is tuned in.
In the auto tuning mode:
When the UP or DOWN button is pressed, automatic searching begins, and searching stops when a station is tuned in.

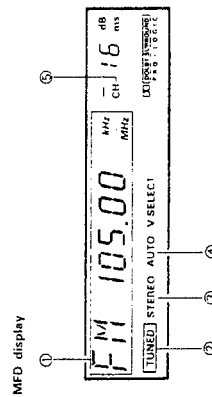

Storing stations at the preset buttons

- Follow steps 1 to 4 under "Tuning" to tune in a station.
- Press the MEMORY button.

The "CH" indicator on the MFD flashes.
- Select the preset channels.

Main unit: 1 → 4 → 8 → 12 → 16

Remote control unit: 1 → 4 → 8 → 12 → 16
- Press the MEMORY button that you want to store to memory.

Recalling stations with the preset buttons

First store stations at the preset buttons using the above procedure.

- Select the preset channels.

Main unit: 1 → 4 → 8 → 12 → 16

Remote control unit: 1 → 4 → 8 → 12 → 16

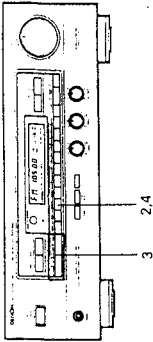

NOTES:

- The preset memory standby mode is set for 10 seconds when the MEMORY button is pressed.
- The preset memory standby mode is cancelled if any button other than preset buttons, the MEMORY button is pressed.

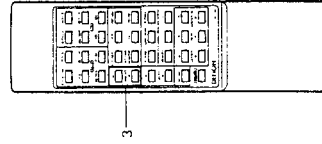

- ### NOTES:
- When in the auto tuning mode on the FM band, the "STEREO" indicator ③ lights on the MFD when a stereo broadcast is tuned in. At open frequencies, the noise is muted and the "TUNED" ② and "STEREO" ③ indicators turn off.
 - When the manual tuning mode is set, FM stereo broadcasts are received in monaural and the "STEREO" indicator ③ turns off.

11 SURROUND PLAYBACK

■ SURROUND modes

The surround modes are as follows:

1	Dolby Pro Logic	Use this when playing program sources recorded in Dolby Surround or Dolby stereo.
2	HALL	Use this setting to create the atmosphere of a concert hall. There will be no output from the center speaker.
3	STUDIO	Use this setting to create the atmosphere of watching a live program in a studio. There will be no output from the center speaker.

- These effects may not be very pronounced for some sources.
- To adjust the speaker balance for the different surround modes, first adjust for the Dolby Pro Logic Surround mode as explained on page 13, then use the position of the center level and rear level controls at this time as a guide to adjust the balance for that surround mode.

Manufactured under license from Dolby Laboratories Licensing Corporation. "Dolby" and the double D symbol  are trademarks of Dolby Laboratories Licensing Corporation.

■ Using Dolby Pro Logic Surround

• Speaker disposition and the Dolby Pro Logic Center mode

Ideally, center speakers should be used when playing sources in Dolby Pro Logic Surround. Select the center mode according to your speaker system.

1. Set the Dolby Pro Logic mode.

Main unit



Remote control unit

2. Select the center mode.

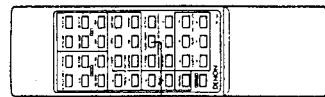
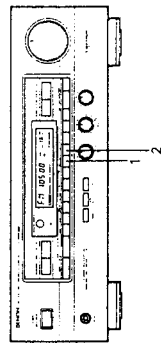

Main unit

← NORMAL → PHANTOM
← WIDE →

The mode changes as shown above.

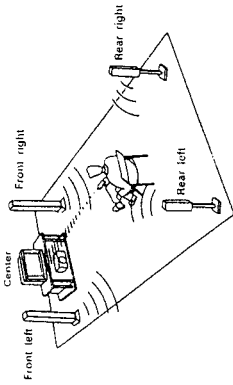

Center Mode



NORMAL mode

This mode is suited for an arrangement in which the center channel speaker is not used. Signals below 100 Hz, which have almost no effect on directional orientation, are distributed to the left and right channels, whereas the center channel output signals greater than 100 Hz. As a result, the bass of the left and right channels increases the apparent depth of the sound.

PHANTOM mode

Use this mode when center channel speaker is not used. A directional emphasis circuit provides signal reproduction which is electrically oriented to the center and this provides an exciting sound field for your enjoyment.

WIDE mode

This mode is suited for an arrangement in which the center channel speaker is of the same grade as the left and right speakers. The entire sound band from low region to high is output to the center channel to provide an exciting sound field for your enjoyment.

• Dolby 3CH Logic (three-channel logic mode)

Select this mode when not using rear speakers.

1. Set the Dolby Pro Logic mode.

Main unit



Remote control unit

2. Press the 3CH LOGIC button.

Main unit

3CH LOGIC
PRO LOGIC

The mode changes as shown at the left



Main unit

← NORMAL → WIDE

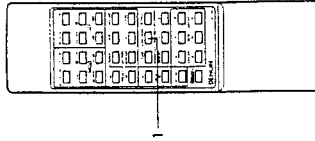
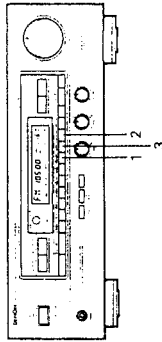
The mode changes as shown above.

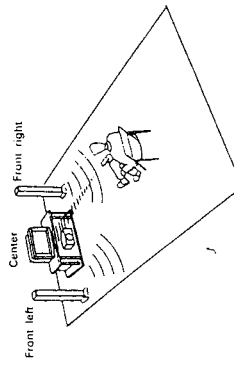

3CH LOGIC MODE



3CH LOGIC mode

Use this mode when rear channel speakers are not used. The rear channel information is reproduced by the front speakers.

→ Continued

• **Speaker volume adjustment and Dolby Pro Logic mode**

To obtain the maximum surround effect, use the test tones to adjust the volume and balance of the speakers for the best balance for the listening position and so that the sound from all the speakers is heard at the same level. Set the master volume control to a suitable level, then adjust using the following procedure.

- 

1. Press the T.TONE button.

Test tones are produced from the speakers in the order shown below, at 4 second intervals for the first two cycles, 2 second intervals after that.

For the Dolby 3CH Logic mode:

FRONT → [FL] → [C] → [FR] → [S] → [R] → [L] → [R] → [C] → [FR] → [L] → [R]
- 

2. To increase the level of the center speakers.
- 

3. To decrease the level of the center speakers.
- 

4. To increase the level of the rear speakers.
- 

5. To decrease the level of the rear speakers.
- 

6. Press the T.TONE button again.

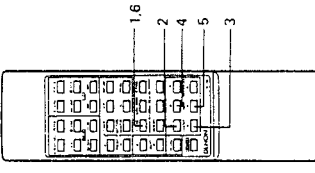



NOTES:

- The test tone will not move on to the next channel when it is being emitted from the center channel and the level of the center speakers is being adjusted, or when it is being emitted from the rear channel and the level of the rear speakers is being adjusted. It only moves on to the next channel approximately two seconds after the level key has been released.

■ **Other Surround Modes**

- HALL mode / STUDIO mode**
 - 

1. Set the HALL mode/STUDIO mode.
 - 

2. Play the desired software.
 - 

3. Adjust the volume.
 - 

4. Adjust the level of the center and rear channels. Adjust the levels according to the source, using the Dolby Pro Logic settings as reference.
 - 

5. Adjust the delay time as desired.

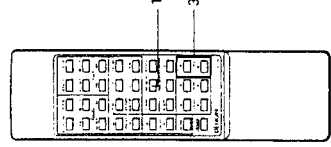
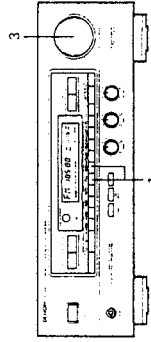

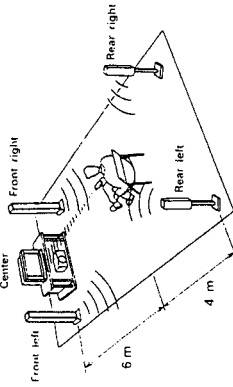

• **Setting the delay time**

The optimum delay time will differ depending on the listening position. Referring to the chart at right, set the optimum delay time for your room's space and seating position. For example, when the distance from the front speakers to the listening position is 6 m and that from the rear speakers to the listening position is 4 m, the optimum delay time will be 21 ms. The variable range of the delay time differs depending on the mode. For details about the variable range, see Page 14.

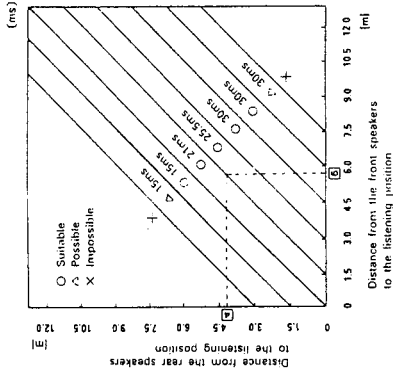

Listening position and optimum delay time for playback with Dolby Pro Logic surround



- 

1. To increase the delay time.
- 

2. To decrease the delay time.

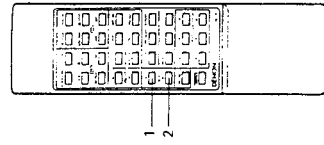
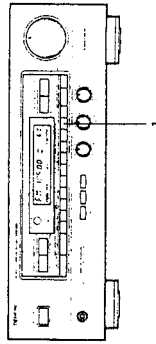

- Once the delay time is set, there is no need to readjust it, unless you change the speaker system or the listening position.
- It is available to memorize the adjusted values of delay time and rear (center) level for each surround mode.

■ Operations Possible in the Various Surround Modes

The following is a list of the buttons and functions which can be operated during the different surround modes. Figures in parentheses indicate adjustment ranges.

	OUTPUT	CENTER LEVEL	REAR LEVEL	CENTER MODE	3CH LOGIC	TEST TONE	DELAY TIME
BYPASS	O	X	X	"2"	X	X	X
DOLBY PRO LOGIC	NORMAL	O (0~-24dB)	O (0~-24dB)	O	O	O	O (15~-30ms)
	PHANTOM	X	O (0~-24dB)	O	X	O	O (15~-30ms)
	WIDE	O (0~-24dB)	O (0~-24dB)	O	O	O	O (15~-30ms)
DOLBY 3CH LOGIC	NORMAL	O (0~-24dB)	X	O	O	O	X
	HALL	O (0~-24dB)	X	O	O	O	X
	STUDIO	O	X	O (0~-24dB)	X	X	O (0~-33ms)

O: Operation possible X: Operation not possible

* Switches to the Dolby Pro (3CH) Logic for any modes other than Dolby Pro (3CH) Logic. The level of the center and rear channels can be adjusted by 2 dB step. The delay time can be set by 1.5 ms step.

- The sound may be distorted for some sources if the rear level is raised during surround playback. If this happens, lower the rear level.

12 INITIALIZATION OF THE MICROPROCESSOR

When the indication of the MFD display is not normal or when the operation of the unit does not show the reasonable result, the initialization of the microprocessor is required by the following procedure:

1. Switch off the unit and remove the AC power cord from the wall outlet.
2. Hold the following 2 buttons of the main unit at the same time (as illustrated in the diagram below, (1) AUDIO FUNCTION button, (2) VIDEO FUNCTION button) and plug the power cord into the outlet.

NOTE:

- When the unit does not show the result of above 3 and 4, repeat the procedure from step 1 again.
- When the microprocessor is initialized, all settings you have made are reset to the factory presettings.

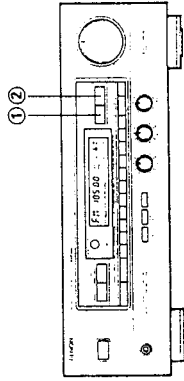

Initial parameter values for the different modes

	OUTPUT	CENTER LEVEL	REAR LEVEL	CENTER MODE	3CH LOGIC	DELAY TIME
BYPASS	ON	---	---	---	---	---
DOLBY PRO LOGIC	ON	-12dB	-12dB	NORMAL	OFF	21msec
HALL	ON	---	-12dB	---	---	21msec
STUDIO	ON	---	-12dB	---	---	21msec

- INPUT FUNCTION : TUNER
- Reception band : FM
- Reception mode : AUTO
- Reception frequency : 87.5MHz (for North American models)
- PERSONAL MEMORY 1 : VDP/DBS INPUT
- SURROUND MODE : DOLBY PROLOGIC
- PERSONAL MEMORY 2 : VDP/DBS INPUT
- SURROUND MODE : HALL

■ Using the Personal Memory

Surround mode settings and the input function can be stored at personal memory buttons "1" and "2". Then recalled directly from any surround mode simply by pressing button "1" or "2".

1 Storing the setting in the personal memory

1. Set the desired surround mode and input function.
 2. Press the personal memory button. Remote control unit
- (The memory setting mode is set and the indicator on the MFD flashes.)
3. Press the desired personal memory button ("1" or "2"). Remote control unit
4. "M 1 (2) SET" appears on the MFD indicating that the setting has been stored.

NOTE:

- The memory setting mode is set for 6 seconds. If any button other than personal memory button "1" or "2" is pressed, the memory setting mode is cancelled.

2 Recalling the personal memory

5. Press the personal memory button ("1" or "2") at which the desired setting was stored. Remote control unit
6. The surround mode and input function switch automatically.

NOTES:

- Personal memory buttons "1" and "2" will not function during the tape monitor mode.
- The surround mode recalled with the PERSONAL MEMORY "1" or "2" button is the same as the mode selected with the surround mode button. Thus, if the parameters of the surround mode which was stored in the memory are cleared, when the mode is recalled it is set to the initial values.
- Upon shipment from the factory, the "DOLBY PRO LOGIC" mode is stored at personal memory "1", the "HALL" mode at personal memory "2". The input function is set to VDP/DBS for both "1" and "2".
- Do not press personal memory buttons "1" or "2" buttons during recording on the cassette deck.

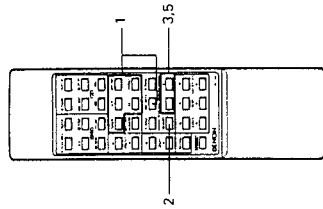
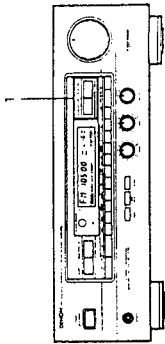

13 TROUBLESHOOTING

If a problem should arise, first check the following:

1. Are the connections correct?
 2. Have you operated the amplifier according to the Operating Instructions?
 3. Are the speakers, turntable, and other components operating properly?
- If the receiver is not operating properly, check the items listed in the table below. Should the problem persist, there may be a malfunction. Disconnect the power immediately and contact your store of purchase.

Symptom	Cause	Measures	Page
MFD not lit and sound not produced when power switch set to on.	<ul style="list-style-type: none"> Power cord not plugged in securely. 	<ul style="list-style-type: none"> Check the insertion of the power cord plug. 	5
MFD lit but sound not produced	<ul style="list-style-type: none"> Speaker cords not securely connected. Improper position of the audio function button. Volume control set to minimum. MUTING is on. 	<ul style="list-style-type: none"> Connect securely to the speaker terminals. Set to a suitable position. Turn volume up to suitable level. Switch off MUTING. 	9, 10, 9, 9
-PROTECT- display appears multi-function display	<ul style="list-style-type: none"> Speaker terminals are short-circuited. Block the ventilation holes of the set. Turn off the set's power, then ventilate it for 10 minutes under good cooling conditions and/or inadequate ventilation. 	<ul style="list-style-type: none"> Switch power off, connect speakers properly, then switch power back on. Turn off the set's power, then ventilate it for 10 minutes under good cooling conditions and/or inadequate ventilation. Once the set is cooled down, turn the power back on. 	9
Sound produced only from one channel	<ul style="list-style-type: none"> Incomplete connection of speaker cords. Incomplete connection of input/output cords. Left/right balance is off. 	<ul style="list-style-type: none"> Connect securely. Connect securely. Adjust balance knob properly. 	5, 7, 8
Positions of instruments reversed during stereo playback	<ul style="list-style-type: none"> Reverse connections of left and right speakers on left and right input/output cords. 	<ul style="list-style-type: none"> Check left and right connections. 	8, 9
Sound seems distorted	<ul style="list-style-type: none"> Rear level is too high. 	<ul style="list-style-type: none"> Set the rear level to lower level. 	13, 14
Personal memory function does not work	<ul style="list-style-type: none"> DAT/Tape monitor mode set. 	<ul style="list-style-type: none"> Press the DAT/TAPE button to set the source. 	10
Humming noise produced when record is playing	<ul style="list-style-type: none"> Ground wire of turntable not connected to the receiver. Incomplete PHONO jack connection. TV or radio transmission antenna nearby. 	<ul style="list-style-type: none"> Connect securely. Connect securely. Contact your store of purchase. 	8
Howling noise produced when volume is high	<ul style="list-style-type: none"> Turntable and speaker systems too close together. Floor is unstable and vibrates easily. 	<ul style="list-style-type: none"> Separate as much as possible. Use cushions to absorb speaker vibrations transmitted by floor. If turntable is not equipped with insulators, use audio insulators (commonly available). 	-
Sound is distorted	<ul style="list-style-type: none"> Stylus pressure too weak. Dust or dirt on stylus. Cartridge defective. 	<ul style="list-style-type: none"> Replace cartridge. Check stylus. 	-
Volume is weak	<ul style="list-style-type: none"> MC cartridge being used. 	<ul style="list-style-type: none"> Replace with MM cartridge or use a head amplifier or step-up transformer. 	8
Receiver does not operate properly when remote control unit is used.	<ul style="list-style-type: none"> Batteries dead. Remote control unit too far from receiver. Obstacle between receiver and remote control unit. Different button is being pressed. Receiver is in sleep mode - ends of battery inserted in reverse. 	<ul style="list-style-type: none"> Replace with new batteries. Move remote control unit closer to receiver. Remove obstacle. Press the proper button. Insert batteries properly. 	5, 6

14 LAST FUNCTION MEMORY

- This receiver is equipped with a last function memory which stores the input and output setting conditions as they were immediately before the power is switched off.
- This function eliminates the need to perform complicated resettings when the power is switched on.
- This receiver is also equipped with a back-up memory. This function provides approximately one week of memory storage with the power cord disconnected.

15 SPECIFICATIONS

- Audio Section**
 - (Power amplifier)
 - Front (main 2ch driven) 60 W + 60 W (8 ohms, 20 Hz ~ 20 kHz with 0.1% THD)
 - Center (center 1ch driven) 60 W (8 ohms, 20 Hz ~ 20 kHz with 0.1% THD)
 - REAR (rear 2ch driven) 15 W + 15 W (8 ohms, 1 kHz with 0.5% THD)
 - Output terminals:
 - Front: 6 to 16 ohms
 - Center: 8 to 16 ohms
 - Rear: 8 to 16 ohms
 - Line input (Each line input - FRONT SP OUT)
 - PHONO (MM): 2.5 mV / 47 kohms
 - Input sensitivity / impedance:
 - 150 mV / 47 kohms ±3 dB
 - 10 Hz to 50 kHz: ±10 dB at 100 Hz
 - Frequency response:
 - TREBLE: ±10 dB at 10 kHz
 - BASE: ±10 dB at 10 kHz
 - Tone control range:
 - TREBLE: ±10 dB (BYPASS)
 - BASE: ±10 dB (BYPASS)
 - Signal-to-noise ratio
 - PHONO input - REC OUT: ±1 dB (20 Hz to 20 kHz)
 - RIAA deviation: 74 dB (A weighting, with 5 mV input)
 - Rated output / Maximum output:
 - 150 mV / 78 V
 - Distortion factor: 0.03% (1 kHz, 1 V)
- Tuner Section**
 - [FM] (note: μV at 75 ohms, 0 dBf - 1×10^{-16} W)
 - Receiving Range: 87.50 MHz ~ 108.00 MHz
 - Usable Sensitivity: 1.0 μV (11.2 dBf)
 - 50 dB Quieting Sensitivity: MONO 1.6 μV (15.3 dBf) STEREO 23 μV (36.5 dBf)
 - Signal to Noise Ratio (HF-A): MONO 80 dB STEREO 75 dB
 - Total Harmonic Distortion (at 1 kHz): MONO 0.4% STEREO 0.5%
- Video Section**
 - Standard video jacks
 - Input and output level / impedance: 1 Vp-p / 75 ohms
 - Frequency response: 2 Hz to 8 MHz ±0, -3 dB
- General**
 - Power supply: AC 230 V, 50 Hz (for Europe model) AC 240 V, 50 Hz (for U.K. model)
 - Power consumption: 200 W
 - Maximum external dimensions: 434 (W) x 142 (H) x 325 (D) mm (17-3/32" x 5-19/32" x 12-51/64")
 - Weight: 9.1 kg (20 lbs 1 oz)
- Remote control Unit**
 - System remote control RC-168:
 - Total buttons: 36
 - DENON system code: 6 buttons
 - CD player: 6 buttons
 - Cassette deck: 24 buttons
 - AVR 800 fixed codes: 66P/AA Type (two batteries) 55 (W) x 18 (H) x 180 (D) mm (2-11/64" x 45/64" x 7-3/32")
 - Batteries: 110 g (Approx. 4 oz) (including batteries)
 - Weight: 110 g (Approx. 4 oz) (including batteries)

* For purposes of improvement, specifications and design are subject to change without notice.

MEMO:

WIRE ARRANGEMENT

In case of wires require unclaspung or loosening to move the location to perform adjustment or part replacement, be sure to rearrange them neatly to restore properly in the same location as they were originally placed, or causing to produce a noise may occasionally occur.

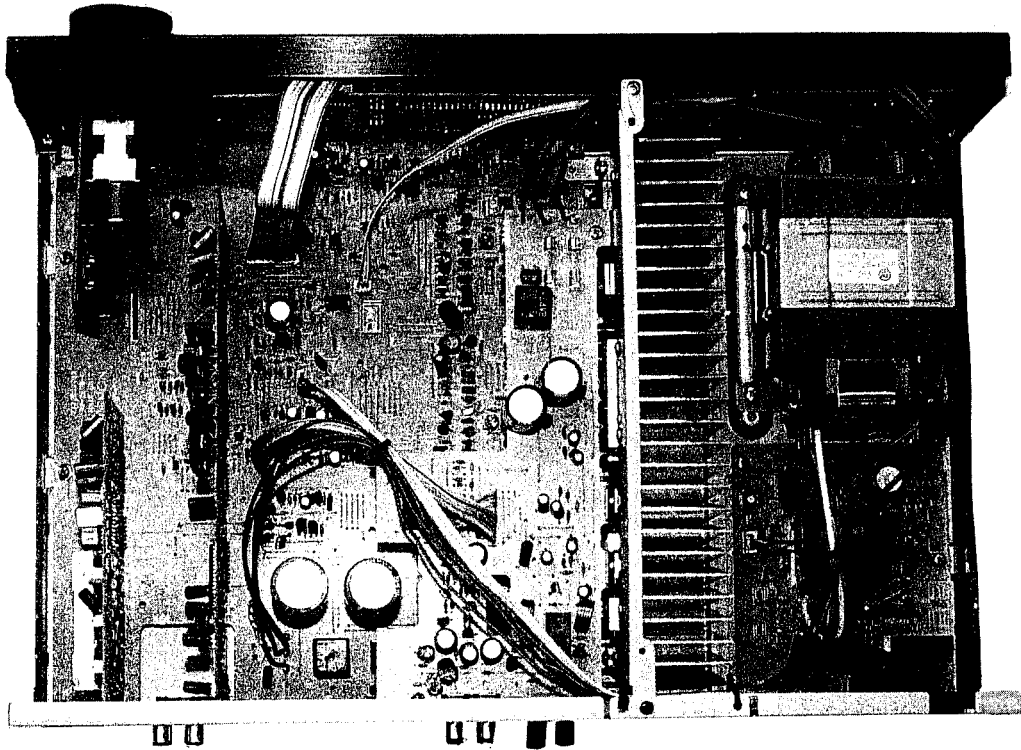

DISASSEMBLY

(To reassemble reverse disassembly)

1. Top Cover

Remove 4 screws ① and 2 screws ② .

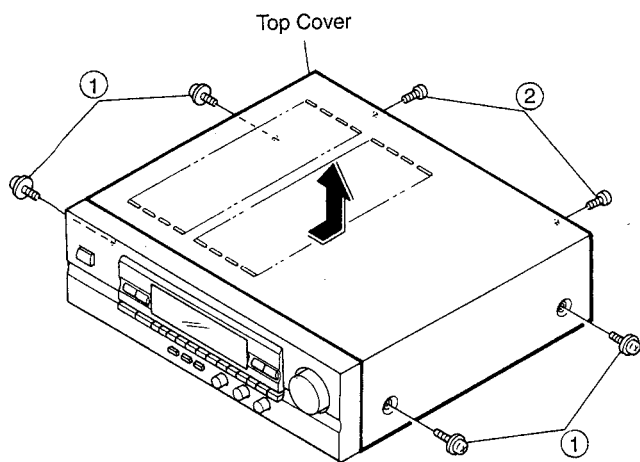

3. Front Mold Panel

- (1) Pull out Volume knob ④ and 3 round knobs ⑤ .
- (2) Remove 4 nuts ⑥ and nut ⑦ .
- (3) Remove 3 screws ⑨ .

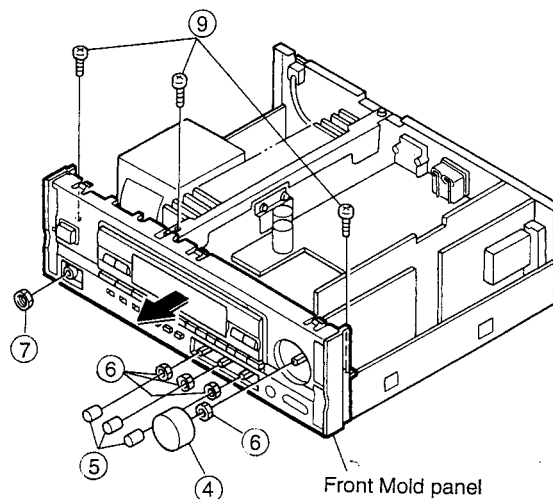

2. Front Aluminium Panel

Remove 3 screws ③ and undo hooks at 3 places.

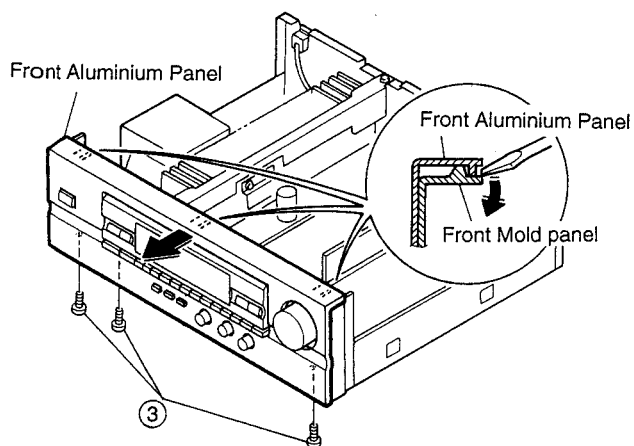

4. Rear Panel

- (1) Disconnect cord bush ⑩ .
- (2) Remove 5 screws ⑪ , and 10 screws ⑫ , and a screw ⑬ .

* Screws ⑫ is tighten.

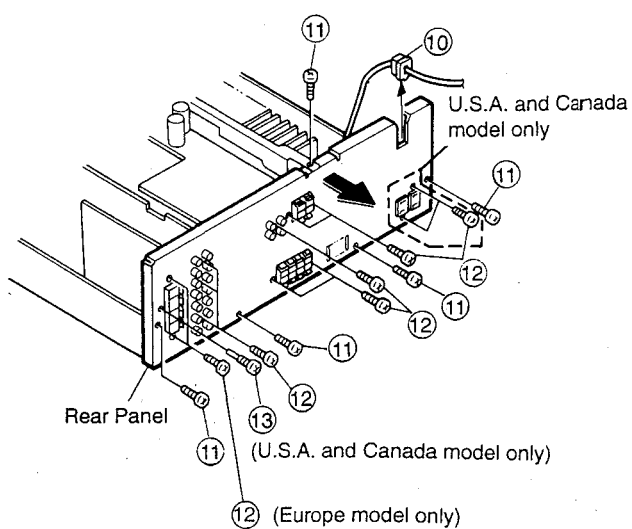

ADJUSTMENT

● TUNER SECTION
CONNECTION DIAGRAM OF MEASURING INSTRUMENTS

● FM

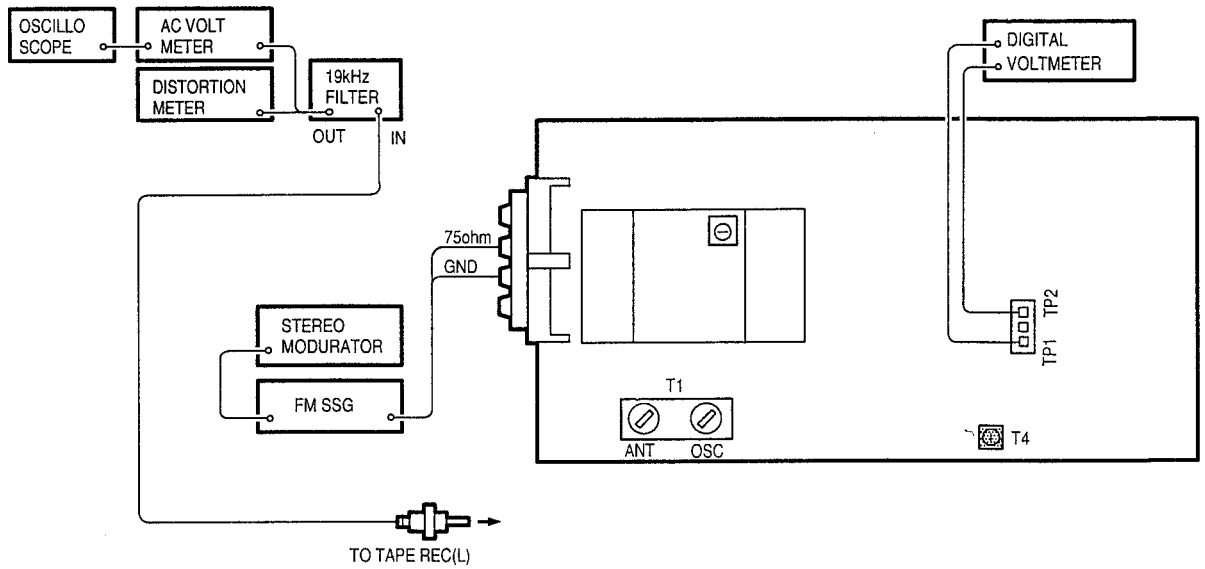

● AM

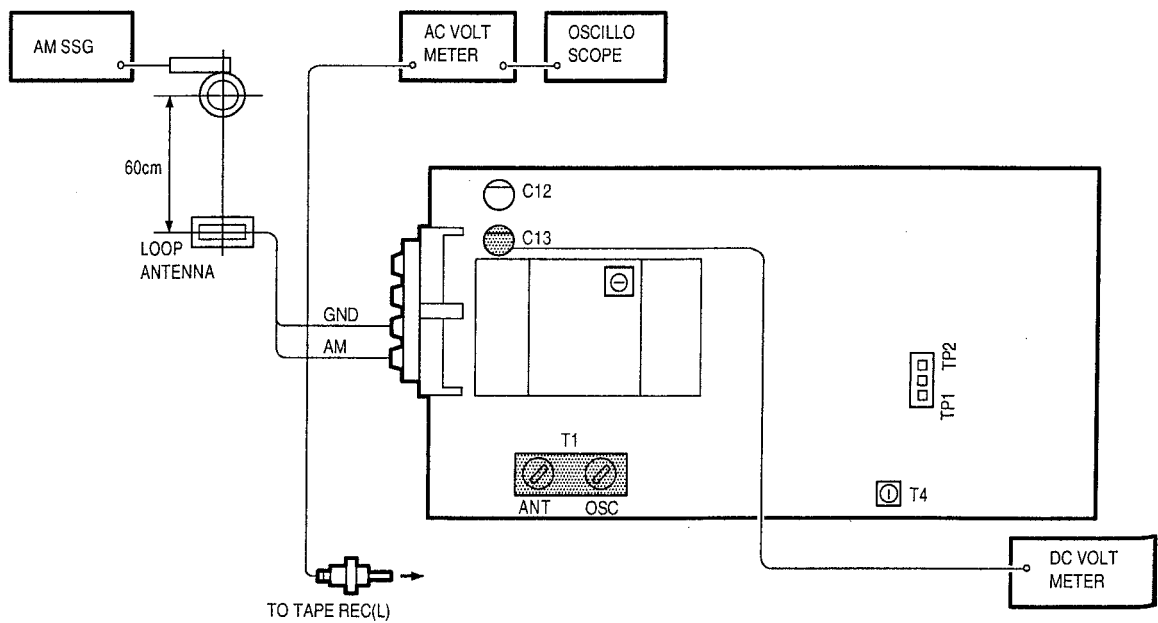

FM/MPX ALIGNMENT

Step	Alignment Item	Tuning Frequency Setting	Input			Output			Adjust		Remarks	
			Type	Frequency	Input Level	Modulation	Coupling	Type	Connect to	Points		Adjust to
1	Tuning Center	98.0MHz (98.00)	FM SSG	98.0 MHz (98.00)	60 dBµ	None	Antenna Terminal	Digital Voltmeter	T.P. 1,2	T4	± 50mV	Function : FM Mode : Auto

() are Europe model.

AM ALIGNMENT

Step	Alignment Item	Tuning Frequency Setting	Input			Output			Adjust		Remarks	
			Type	Frequency	Input Level	Modulation	Coupling	Type	Connect to	Points		Adjust to
1	Receiving Band Alignment	520 KHz (522 KHz)	AM SSG	520 KHz (522 KHz)	Input Level is not over to work A.G.C.	400 Hz 30%	Loop Antenna	Electric DC Voltmeter	C13 (+ Side) GND	T1 (OSC)	1.0 V ± 100mV	Function : AM
		1710 KHz (1611 KHz)	AM SSG	1710 KHz (1611 KHz)	Input Level is not over to work A.G.C.	400 Hz 30%	Loop Antenna	Electric DC Voltmeter	C13 (+ Side) GND			less than 9.0V (check the voltage)
2	Tracking Alignment	600 KHz (603 KHz)	AM SSG	600 KHz (603 KHz)	Input Level is not over to work A.G.C.	400 Hz 30%	Loop Antenna	Audio V.M.	TAPE REC (L) -1	T1 (ANT)	Maximum Output	Function : AM
		1400 KHz (1404 KHz)	AM SSG	1400 KHz (1404 KHz)	Input Level is not over to work A.G.C.	400 Hz 30%	Loop Antenna	Audio V.M.	TAPE REC (C) -1			Maximum Output (check)

() are Europe model.

● **Initiating (Memory clearing) Method**

To clear memory contents of microcomputer and restore to the initial state, take the following steps;

1. Press power switch, turn off power of the unit, and set to standby mode.
2. Pull out power cord from wall outlet temporarily.
3. Insert power cord into outlet while simultaneously pressing two keys of AUDIO and VIDEO.
4. Press power switch to confirm that memory contents are cleared.

By completion of the above, the initial state is restored. In case the memory can not be cleared due to some reasons, repeat steps 1 through 3.

● AUDIO SECTION

Idling Current (1U-2650-1)

Required measurement equipment: DC Voltmeter

Arrangement

(1) Avoid direct blow from an air conditioner or an electric fan, and adjust the unit at normal room temperature 15°C ~ 30°C. (59°F ~ 86°F).

(2) Presetting

- POWER (Power source switch) → OFF
- MODE (Mode button) → BY PASS
- FUNCTION (Function button) → CD
- VOLUME (Volume control) → 0: fully counterclockwise (⤴ min.)
- BASS, TREBLE (Tone control) → 0: (Controls to center)
- SPEAKERS (Speaker terminal) → No load (Do not connect speaker, dummy resistor, etc.)

Adjustment

- (1) Remove top cover and set VR401, VR301 and VR302 of 1U-2650-1 or 1U-2650B-1 (Main Unit) at counterclockwise fully.
- (2) Connect DC Voltmeter to test points (Lch T.P.302, Rch T.P.301, CENTER ch T.P.401).
- (3) Connect power cord to AC Line, and turn power switch "ON".
- (4) Allow 15 minutes, and turn VR301, VR302 and VR401 clockwise (⤵) and adjust the TEST POINTS voltage to 1.5 mV ± 0.5 mV DC.
- (5) After 2 minutes from preset, turn VR301, VR302 and VR401 to set the voltage to 3 mV ± 0.5mV DC.

1U-2650-1 Main Unit (Component Side)

	UNIT No.
U.S.A. and CANADA	1U-2650
EUROPE	1U-2650B

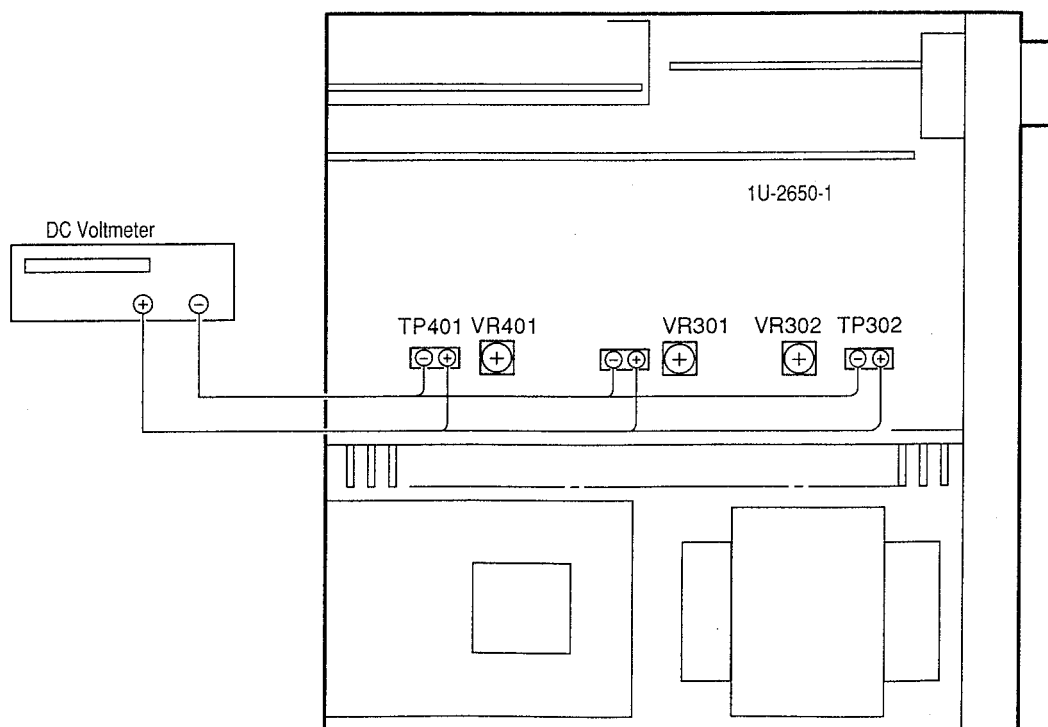

SEMICONDUCTORS

IC's

Note)
 Indications before IC numbers denote P.W.B. Name.
 MA : Main Amp P.W.B. Unit
 RE : Rear Amp P.W.B. Unit
 SU : Surround P.W.B. Unit

LA3401
 (SU: IC002)

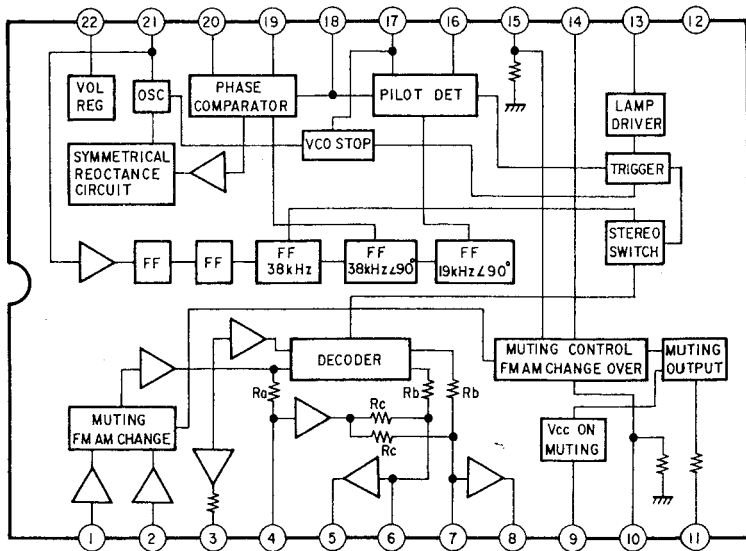
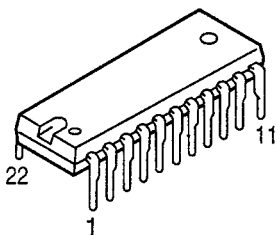

LA1265 (S)
 (SU: IC001)

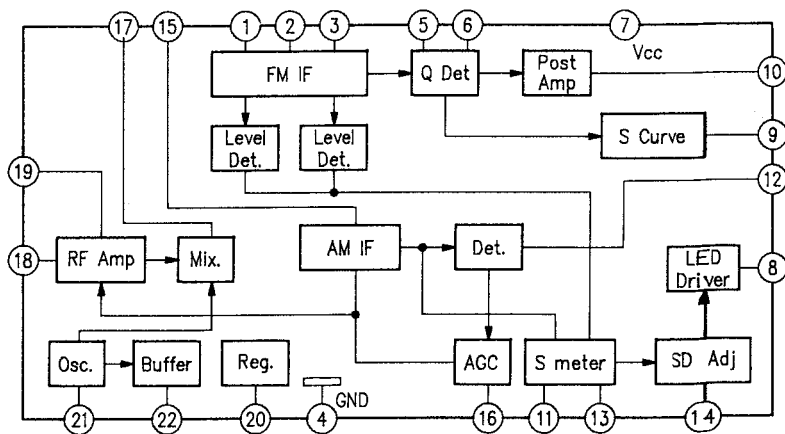
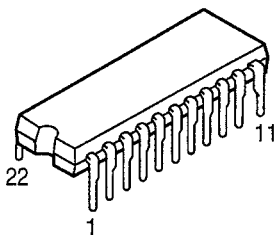

● IC PROTECTORS

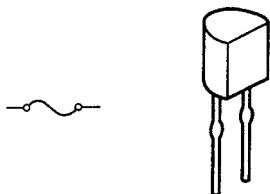

ICP-N15 (RE: IC552)
 ICP-N20 (RE: IC505, 506)

NJM2177AF
(SU: IC201)

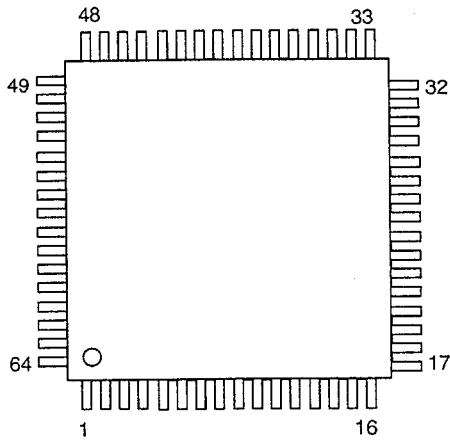

Pin No.	Pin Name	Pin No.	Pin Name	Pin No.	Pin Name
1	NC	23	NOISE-HPF	45	LPF-INV-IN
2	L-RECT-IC	24	NOISE-LPF	46	LPF-NINV-IN
3	R-BPF-OUT	25	S-OUT	47	NR-TC
4	R-BPF-IN	26	CENTER-CNT	48	NC
5	R-RECT-TC	27	MODE-CNT	49	NC
6	GND	28	L-OUT	50	VLR-TC3
7	AB-GATE	29	R-OUT	51	VCS-TC3
8	AB-HOLD-TC	30	L+R-OUT	52	VCS-TC2
9	L-AB-IN	31	L-R-OUT	53	VCS-TC1
10	L-AB-OUT	32	NC	54	VLR-TC1
11	L-IN	33	NC	55	VLR-TC2
12	L-INBUF-OUT	34	CENTER-MODE	56	S-RECT-OUT
13	R-INBUF-OUT	35	Vcc	57	C-RECT-OUT
14	R-IN	36	C-OUT	58	R-RECT-OUT
15	R-AB-OUT	37	S'-OUT	59	L-RECT-OUT
16	NC	38	IREF	60	S-RECT-TC
17	NC	39	NR-VCF	61	C-RECT-TC
18	R-AB-IN	40	NR-IN	62	L-BPF-OUT
19	NOISE-CNT-E	41	VREF	63	L-BPF-IN
20	NOISE-CNT-A	42	VREF	64	NC
21	NOISE-CNT-B	43	NR-WT		
22	NOISE-REF	44	LPF-OUT		

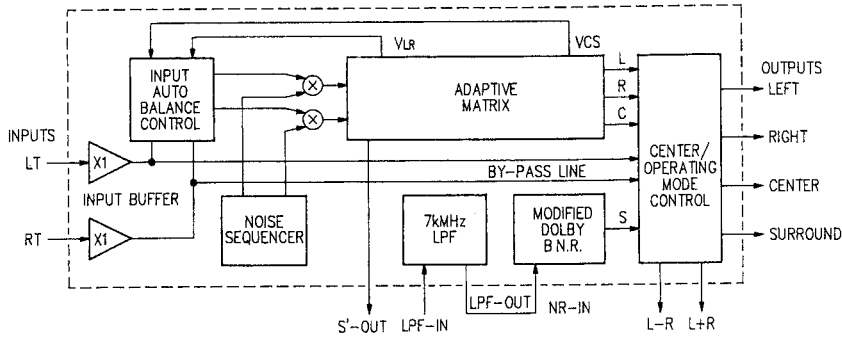

NJU9701G
(SU: IC202)

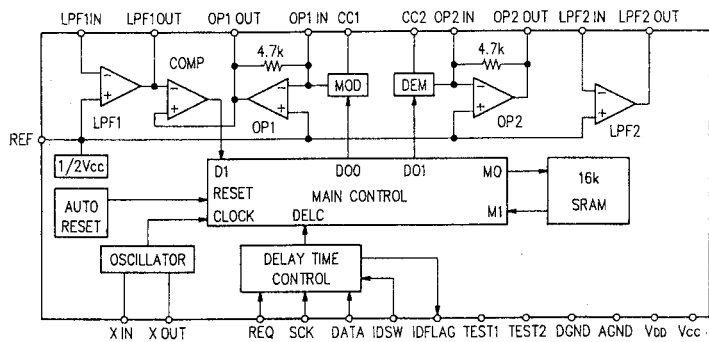
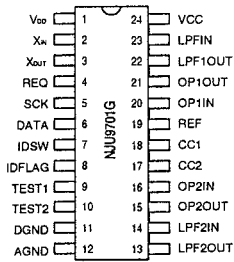

MSC1937-01 (RE: IC702)

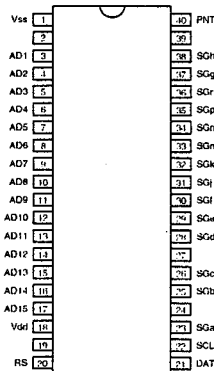
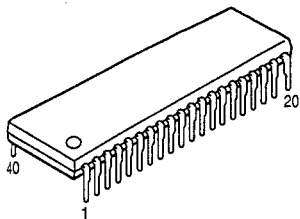

Pin No.	Terminal Function
1	Power Supply (+5V)
3	Digit 1 Output
i	i
17	Digit 17 Output
18	GND
19	---
20	POWER-ON-RESET
21	Data Input
22	Shift Clock Input
23	Segment a Output
i	i
38	Segment h Output
39	---
40	POINT Output

TMP87CH40AF
(MA: IC801)

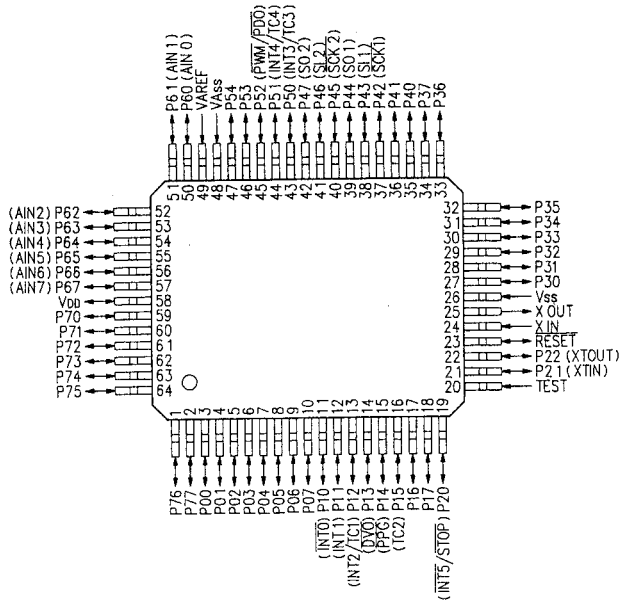
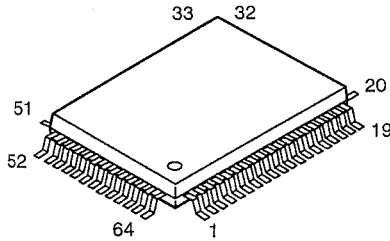

TMP87CH40AF Terminal Function

Pin No.	SYMBOL	Name	I/O	Det	Res	Ext	Ini	Function
1	P76	ST/MONO	O	-	Z	-	H	STEREO/MONO control signal ("L" at STEREO mode)
2	P77	No connection	I	-	Z	GND	-	No connection
3	P00	Video Control A	O	-	Z	-	H	Video input/output control ("L" at selection)
4	P01	Video Control B	O	-	Z	-	H	Video input/output control ("L" at selection)
5	P02	No connection	I	-	Z	GND	-	No connection
6	P03	No connection	I	-	Z	GND	-	No connection
7	P04	CK	O	-	Z	-	H	Serial delay time control output (NJU9701)
8	P05	REQ	O	-	Z	-	H	Delay time control output
9	P06	DATA	O	-	Z	-	L	Serial delay time control output
10	P07	SURR.	O	-	Z	-	H	Rear signal control
11	P10/INT0	Stop Power	I	Lv	Z	Pu	-	Stop power detect ("L" at stop power)
12	P11/INT1	PROTECTION	I	E&L	Z	Pu	-	Protective input ("H" at protection)
13	P12/INT2	L+R	O	-	Z	-	H	Rear signal control
14	P13/DV0	L-R	O	-	Z	-	H	Rear signal control
15	P14/PPG	CNT-E	O	-	Z	-	H	Test tone control
16	P15/TC2	CNT-A	O	-	Z	-	L	Test tone control
17	P16	CNT-B	O	-	Z	-	L	Test tone control
18	P17	NORMAL	O	-	Z	-	L	Center mode control
19	P20/INT5	WIDE	O	-	Z	Pu	H	Center mode control
20	TEST		I	-	-	-	-	Connect to GND
21	P21/XT1	BYPASS	O	-	Z	Pu	L	PRO LOGIC Change signal
22	P22/XT0	PRO LOGIC	O	-	Z	-	H	PRO LOGIC Change signal
23	RESET		I	-	-	-	-	Reset input
24	XIN		-	-	-	-	-	Oscillate circuit (4MHz)
25	XOUT		-	-	-	-	-	Oscillate circuit (4MHz)
26	Vss	GND	-	-	-	-	-	
27	P30	SP-FRONT	O	-	Z	Pu	H	Speaker relay control output
28	P31	SP-REAR	O	-	Z	Pu	L	Speaker relay control output
29	P32	SP-CENTER	O	-	Z	Pu	L	Speaker relay control output
30	P33	H/P	O	-	Z	Pu	H	Headphone relay control output
31	P34	POWER	O	-	Z	Pu	L	Power relay control output ("L" at ON)
32	P35	STANDBY-LED	O	-	Z	Pu	L	LED drive output for STANDBY indication ("L" at display lights)
33	P36	BYPASS	O	-	Z	Pu	L	PRO LOGIC change signal
34	P37	No connection	I	-	Z	GND	-	No connection
35	P40	VOL. UP	O	-	Z	Pu	L	Electrical volume control output (LB1639)

Pin No.	Symbol	Name	I/O	Det	Res	Ext	Ini	Function
36	P41	VOL. DOWN	O	-	Z	Pu	L	Electrical volume control output (LB1639)
37	P42/SCK1	CK	O	-	Z	Pu	L	Serial electrical volume control output (TC9176)
38	P43/SI1	ST	O	-	Z	Pu	L	Electrical volume control output
39	P44/SO1	DATA	O	-	Z	Pu	H	Serial electrical volume control output
40	P45/SCK2	FL-CK	O	-	Z	Pu	H	Serial Liquid Crystal Display control output (MSC1937)
41	P46/SI2	FL-RS	O	-	Z	Pu	L	Liquid Crystal Display control output
42	P47/SO2	FL-DATA	O	-	Z	Pu	H	Serial Liquid Crystal Display control output.
43	P50/INT3	REMOTE	I	E&L	Z	Pu	-	Remote control signal input
44	P51/INT4	CK	O	-	Z	Pu	L	Serial surround control signal output (LC7822)
45	P52/PWM	CE	O	-	Z	Pu	L	Surround control output
46	P53	DATA	O	-	Z	Pu	L	Serial surround control output
47	P54	No connection	I	-	Z	GND	-	No connection
48	VASS	GND	-	-	-	-	-	Analog reference GND for A/D conversion
49	VAREF	+5V	-	-	-	-	-	Analog reference voltage for A/D conversion. Connect to 5V
50	P60/AIN0	KEY1	I	Lv	Z	Pu	-	Button input
51	P61/AIN1	KEY2	I	Lv	Z	Pu	-	Button input
52	P62/AIN2	KEY3	I	Lv	Z	Pu	-	Button input
53	P63/AIN3	MODE	I	Lv	Z	Pu	-	AVC/AVR change signal
54	P64/AIN4	No connection	I	-	Z	GND	-	No connection
55	P65/AIN5	No connection	I	-	Z	GND	-	No connection
56	P66/AIN6	No connection	I	-	Z	GND	-	No connection
57	P67/AIN7	No connection	I	-	Z	GND	-	No connection
58	VDD	+5V	-	-	-	-	-	Connect to 5V
59	P70	CK	O	-	Z	-	L	Serial control output (LM7001)
60	P71	DATA	O	-	Z	-	L	Serial control output (LM7001)
61	P72	ST	O	-	Z	-	L	latch control
62	P73	TUNER MUTE	O	-	Z	-	H	Mute output ("H" at muting)
63	P74	TUNED SIGNAL	I	Lv	Z	Pu	-	Synchronous detect ("L" at synchronous)
64	P75	STEREO SIGNAL	I	Lv	Z	Pu	-	"L" at stereo receive mode

TC9176P (SU: IC262)

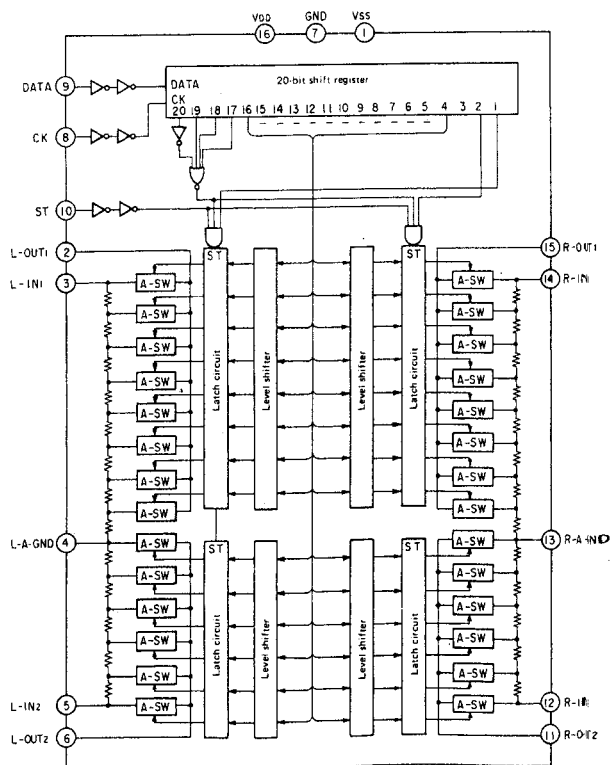
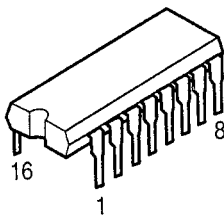

LM7001M
(SU: IC003)

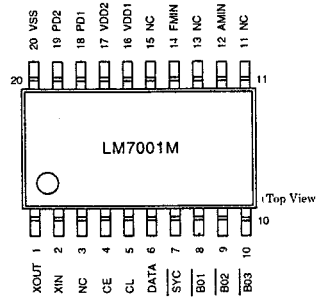
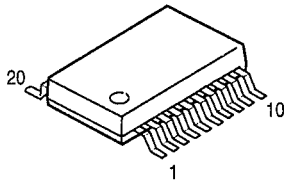

* (NC) pin : Use at opened.

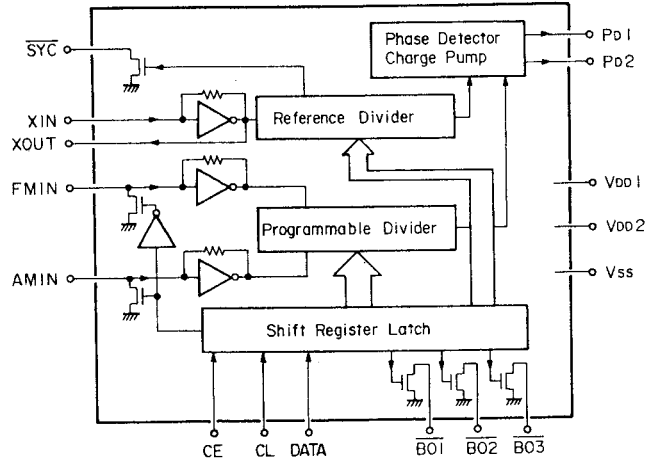

Terminal Description

- $\overline{\text{SYNC}}$: Clock for controller (400 kHz)
- XIN, XOUT : X'tal OSC (7.2MHz)
- FMIN, AMIN : Station oscillation signal input.
- CE, CL, DATA : Data input.
- BO1, BO2, BO3: Band data output. BO1 is feasible for time base output (8Hz).
- VDD1, VDD2, VSS: Power supply. (VDD2 is for back-up)
- PD1, PD2 : Charge pump output.

Data input

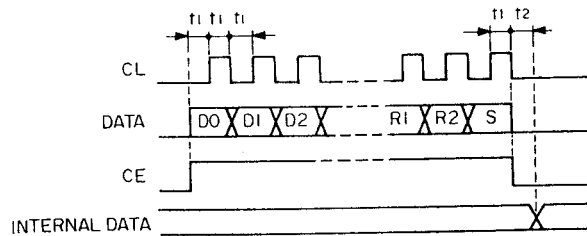

$t_1 > 1.5 \mu\text{s}$ (X'tal at 7.2MHz)
 $t_2 < 1.5 \mu\text{s}$

Input from D0.

D0	D1	D2	D3	D4	D5	D6	D7	D8	D9	D10	D11	D12	D13	T0	T1	B0	B1	B2	TB	R0	R1	R2	S
----	----	----	----	----	----	----	----	----	----	-----	-----	-----	-----	----	----	----	----	----	----	----	----	----	---

- (1) D0 (LSB)~D13 (MSB) :Frequency dividend data
For FMIN, use D0~D13; for AMIN, use D4~D13.

D0	D1	D2	D3	D4	D5	D6	D7	D8	D9	D10	D11	D12	D13
1	0	1	0	0	0	0	0	0	1	0	1	1	1
LSB													MSB
x	x	x	x	0	0	0	0	1	0	1	1	1	1
				LSB									MSB

→ FMIN Frequency dividend number = 14853

→ AMIN Frequency dividend number = 928

- (2) T0, T1 : For test of LSI(0,0)

BU4066BC
(RE: IC601)

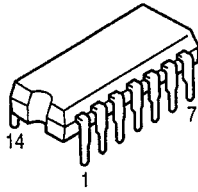

BU4066BCF
(SU: IC203, 205)

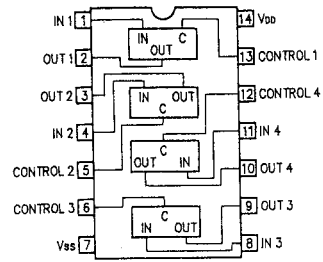
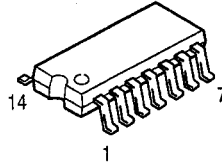

BA4558
(MA: IC451)

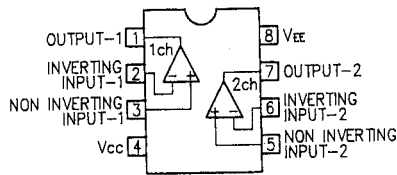
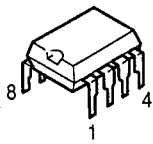

BA4558F (SU: IC101, 103, 261, 263)
NJM2068MD (SU: IC101): Europe model only

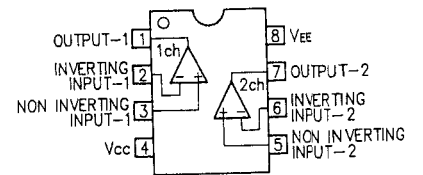
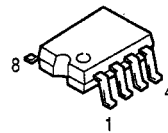

BA6208F (SU: IC264)

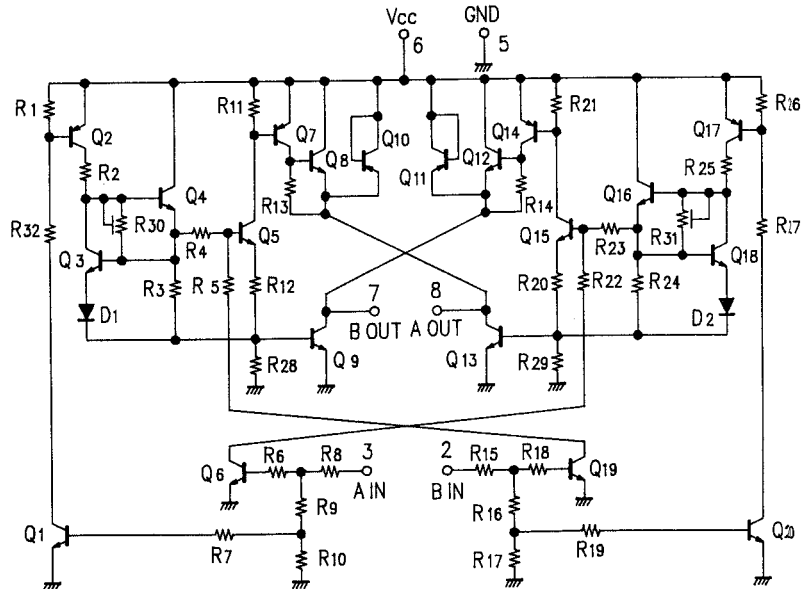
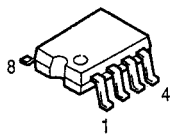

SI-18752 (RE: IC501, 502)

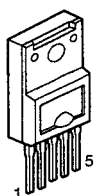

- 1. +IN
- 2. -IN
- 3. -VEE
- 4. Output
- 5. +Vcc

NJM7806FA(S) (RE: IC551)
NJM7812FA(S) (RE: IC503)

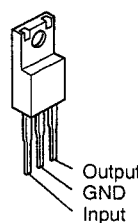

- Output
- GND
- Input

NJM7912FA
(RE: IC504)

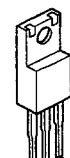

- Output
- Input
- GND

LC7822 (SU: IC102)

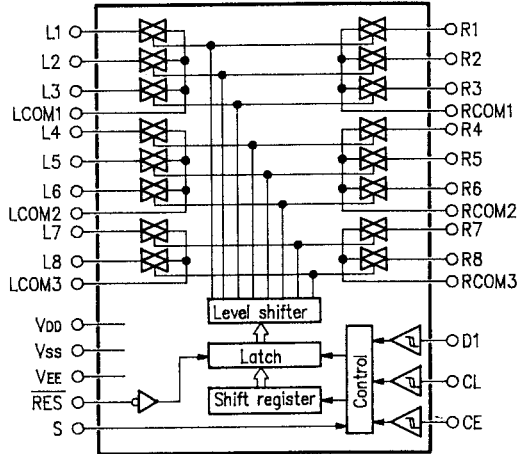
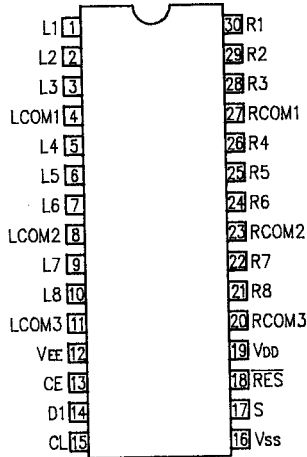
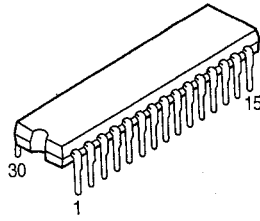
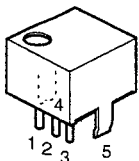

Table of LC7822 Terminal Function

Name of Terminal	I/O	Equivalent Internal Circuit	Function of Terminal																					
VDD, VSS, VEE			Power terminal.																					
L1 - L8, R1 - R8 LCOM1 - LCOM4, BCOM1 - BCOM4		Refer to block diagram	In/Out terminal of analog switch.																					
CL, DI, CE	I		Serial data input terminal (Schmidt buffer). CL = Clock input terminal. DI = Data input terminal. CE = Chip enable terminal.																					
S	I		Selection terminal for using of two. Address will be shifted as per below table when switching S terminal to L or H. <table border="1" style="margin: 10px auto;"> <thead> <tr> <th rowspan="2">Name of Item</th> <th rowspan="2">S Terminal</th> <th colspan="4">Address</th> </tr> <tr> <th>A0</th> <th>A1</th> <th>A2</th> <th>A3</th> </tr> </thead> <tbody> <tr> <td rowspan="2">LC7822</td> <td>L</td> <td>0</td> <td>1</td> <td>0</td> <td>1</td> </tr> <tr> <td>H</td> <td>1</td> <td>1</td> <td>0</td> <td>1</td> </tr> </tbody> </table>	Name of Item	S Terminal	Address				A0	A1	A2	A3	LC7822	L	0	1	0	1	H	1	1	0	1
Name of Item	S Terminal	Address																						
		A0	A1	A2	A3																			
LC7822	L	0	1	0	1																			
	H	1	1	0	1																			
RES	I		Reset terminal. Condition of analog switch is not fixed at the time of turning on the power. When shift this terminal to L, all analog switches become OFF.																					

SBX1610-52 (Remote Control Receiver)
(RE: IC701)



1. Vcc
2. Output
3. GND
4. Case fin
5. Case fin

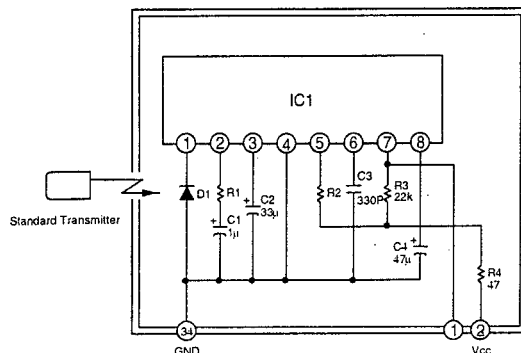

- IC1 : CX20106A chip
- D1 : Pin photodiode chip
- C1, C2, C4 : Aluminum electrolytic capacitor
- C3 : SL characteristic $\pm 5\%$
- R1 : Gain control resistor
- R2 : fo control resistor (using $\pm 1\%$)
- R (Other than above items) : $\pm 5\%$

● TRANSISTORS

2SA970 (BL)
2SA988 (E/F)
2SC1015 (GR)
2SC1815 (Y),(BL)
2SC1841 (E/F)
2SC2878 (A/B)

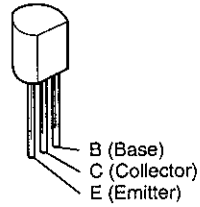

2SB647A (C)
2SB1041 (R)
2SD1292 (R)
2SD667A (C)

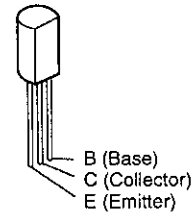

2SA1490 (O/P/Y) (Z)
2SC3854 (O/P/Y) (Z)

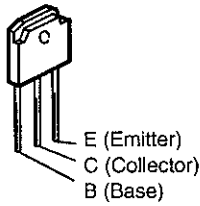

2SA933S (R)
2SC1740S (E)

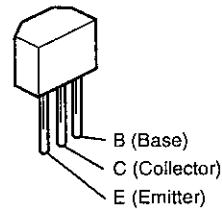

DTA143ES
DTC143ES

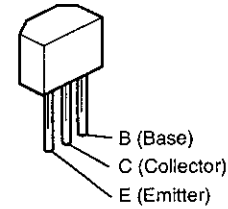

DTC143ES

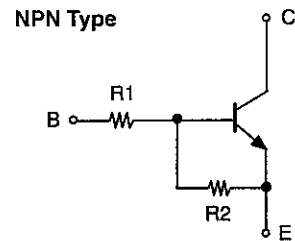

	R1	R2
DTC143ES	4.7 kohm	4.7 kohm

DTA143ES

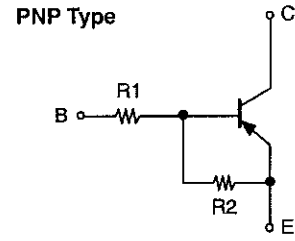

	R1	R2
DTA143ES	4.7 kohm	4.7 kohm

2SK209 (Y/GR)

2SC2412K (S)
2SC2712 (Y/GR)
2SC2996 (Y)

RN2402
DTA114TK
DTA144EK
DTC144EK
DTC144TK
DTC323TK

DTC144EK
DTC144TK
DTC323TK

RN2402
DTA144EK
DTA114TK

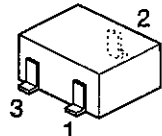
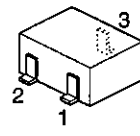
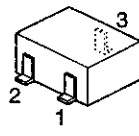

1: Drain
2: Source
3: Gate

1: Emitter
2: Base
3: Collector

1: GND/Emitter
2: Out/Collector
3: In/Base

NPN Type

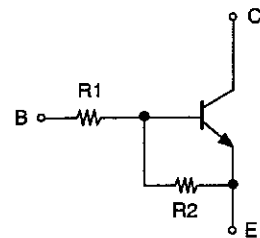

	R1	R2
DTC144EK	47 kohm	47 kohm
DTC144TK	47 kohm	—
DTC323TK	2.2 kohm	—

PNP Type

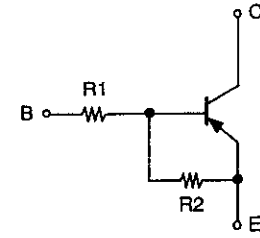

	R1	R2
RN2402	47 kohm	47 kohm
DTA144EK	47 kohm	47 kohm
DTA114TK	10 kohm	—

2SK211 (Y/GR)

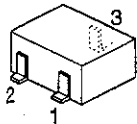

1: Gate
2: Drain
3: Source

● DIODES (included LED)

1SS252
1S2471

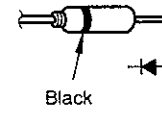

HZS3C-1 HZS9A-1
HZS6B-1 HZS12A-1
HZS7C-1 HZS12B-1
HZS7B-1

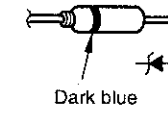

1SR35-200A

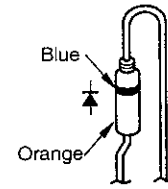

SF0R1A42 (Thyristor)

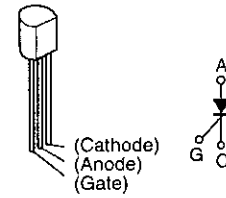

S4VB20F (RE: D502)
(MA: D351)

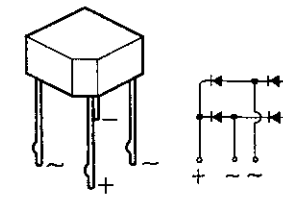

SEL1210S (Red)
(RE: LD701)

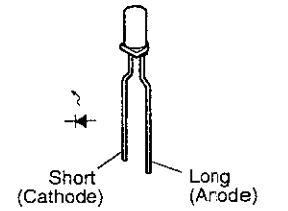

● FL DISPLAY FIP14PM8

(Part No.: 3934131000)(FL701)

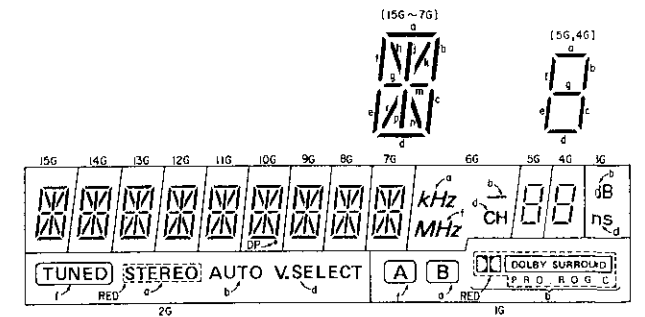
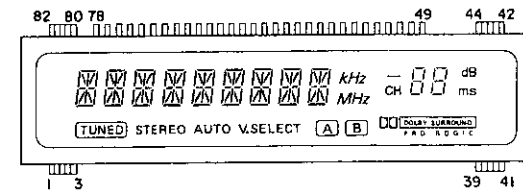

5 x 7 Dot inner connections

11	21	31	41	51
12	22	32	42	52
13	23	33	43	53
14	24	34	44	54
15	25	35	45	55
16	26	36	46	56
17	27	37	47	57

(UPPER)

TERMINAL No. ELECTRODE	82 F1	81 F1	80 F1	79 NP	78 P DP	77 P h	76 P g	75 P r	74 P p	73 P n	72 P m									
TERMINAL No. ELECTRODE	71 P k	70 P j	69 P f	68 P e	67 P d	66 P c	65 P b	64 P a	63 15G	62 14G	61 13G	60 12G	59 11G	58 10G	57 9G	56 8G	55 7G	54 6G	53 5G	52 4G
TERMINAL No. ELECTRODE											51 3G	50 2G	49 1G	48 NP	47 NP	46 NP	45 NP	44 F2	43 F2	42 F2

(LOWER)

TERMINAL No. ELECTRODE																						32 NP	33 NP	34 NP	35 NP	36 NP	37 NP	38 NP	39 F2	40 F2	41 F2
TERMINAL No. ELECTRODE	12 NP	13 NP	14 NP	15 NP	16 NP	17 NP	18 NP	19 NP	20 NP	21 NP	22 NP	23 NP	24 NP	25 NP	26 NP	27 NP	28 NP	29 NP	30 NP	31 NP											
TERMINAL No. ELECTRODE	1 F1	2 F1	3 F1	4 NP	5 NP	6 NP	7 NP	8 NP	9 NP	10 NP	11 NP	12																			

Notes: F: Filament NP: No-Pin
G: Grid
P: Anode

PRINTED WIRING BOARD (Pattern side)

1

2

3

4

5

6

7

8

MAIN AMP. UNIT ASS'Y
 1U-2650 for U.S.A. and Canada
 1U-2650B for Europe

1U-2650, B	
1	Main Amp. Unit
2	Headphone Unit

*

	Multi-Voltage	Europe	U.S.A.	Canada
R816	Used	Used	Not used	Not used
R817	Used	Used	Jump	Jump
C357	Not used	Used	Not used	Not used
C358	Not used	Used	Not used	Not used
C360	Not used	Used	Not used	Not used
D313	Used	Not used	Used	Not used
D314	Used	Condensor	Used	Used
D315	Used	Condensor	Used	Used
D316	Used	Not used	Used	Not used
F.S.SW	Used	Not used	Not used	Not used

Please refer to diagram in difference of fixed value.

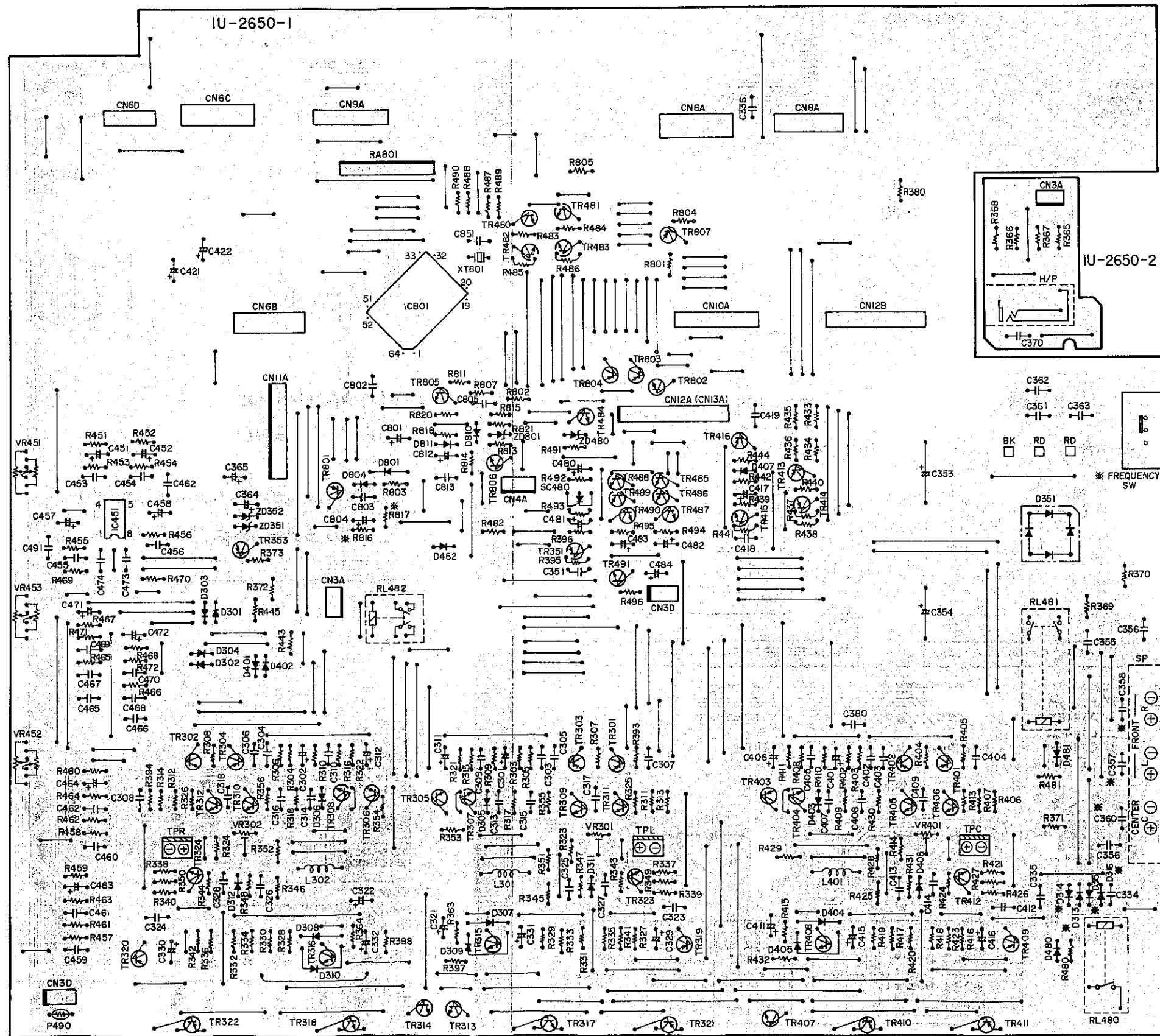

A

B

C

D

E

1 2 3 4 5 6 7 8

REAR AMP. UNIT ASS'Y
 1U-2651 for U.S.A. and Canada
 1U-2651B for Europe

1U-2651, B	
1	Rear Amp. Unit
2	VFD Unit
3	Power Supply Unit

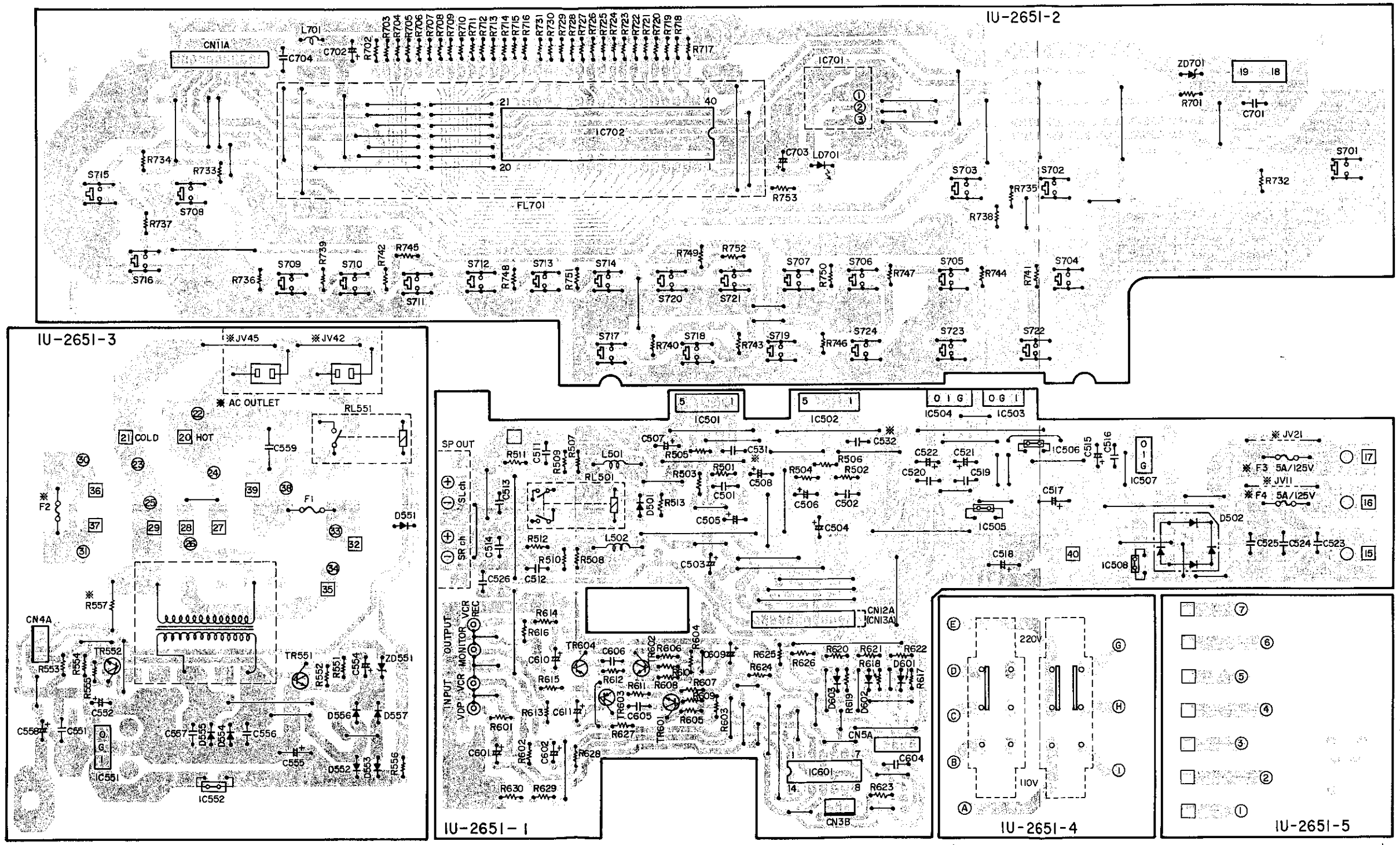

* Multi-Voltage Model Only

	JV11	JV21	JV42	JV45	F2	F3	F4	C531	C532	R557	AC OUTLET
Multi-Voltage	Used	Used	Not used	Not used	Used	Not used	Not used	Not used	Not used	Not used	Not used
Europe	Used	Used	Not used	Not used	Not used	Not used	Not used	Used	Used	Not used	Not used
U.S.A.	Not used	Not used	Used	Used	Not used	Used	Used	Not used	Not used	Used	Used
Canada	Not used	Not used	Used	Used	Not used	Used	Used	Not used	Not used	Used	Used

Please refer to diagram in difference of fixed value.

A
B
C
D
E

1

2

3

4

5

6

7

8

SURROUND UNIT ASS'Y
1U-2652 for U.S.A. and Canada
1U-2652B for Europe

A

1U-2652, B	
1	Surround Unit
2	Volume Unit
3	Tuner Unit

*				
	Multi-Voltage	Europe	U.S.A.	Canada
TR1	Not used	Used	Not used	Not used
J4	Used	Not used	Used	Used
J5	Used	Not used	Used	Used
J6	Used	Not used	Used	Used
J101	Used	4.7k	Used	Used
J102	Used	4.7k	Used	Used
J200	Not used	Used	Not used	Not used
C2	Not used	Used	Not used	Not used
C6	Not used	Used	Not used	Not used
C23	Used	Not used	Used	Used
C26	Not used	Used	Not used	Not used
C121	Not used	Used	Not used	Not used
C122	Not used	Used	Not used	Not used
C123	Not used	Used	Not used	Not used
C124	Not used	Used	Not used	Not used
C125	Not used	Used	Not used	Not used
C126	Not used	Used	Not used	Not used
C127	Not used	Used	Not used	Not used
C128	Not used	Used	Not used	Not used
C147	Not used	Used	Not used	Not used
C148	Not used	Used	Not used	Not used
C281	Not used	Used	Not used	Not used
C282	Not used	Used	Not used	Not used
R2	Not used	Used	Not used	Not used
R4	Not used	Used	Not used	Not used
R6	Not used	Used	Not used	Not used
R50	Used	Not used	Used	Used
R71	Not used	Used	Not used	Not used
R72	Used	Not used	Used	Used
R80	Used	Not used	Used	Used
R81	Not used	Used	Not used	Not used
R82	Used	Not used	Used	Used
R93	Not used	Used	Not used	Not used
LF1	Not used	Used	Not used	Not used
LF2	Not used	Used	Not used	Not used
LF3	Not used	Used	Not used	Not used
LF101	Not used	Used	Not used	Not used
LF102	Not used	Used	Not used	Not used

Please refer to diagram in difference of fixed value.

B

C

D

E

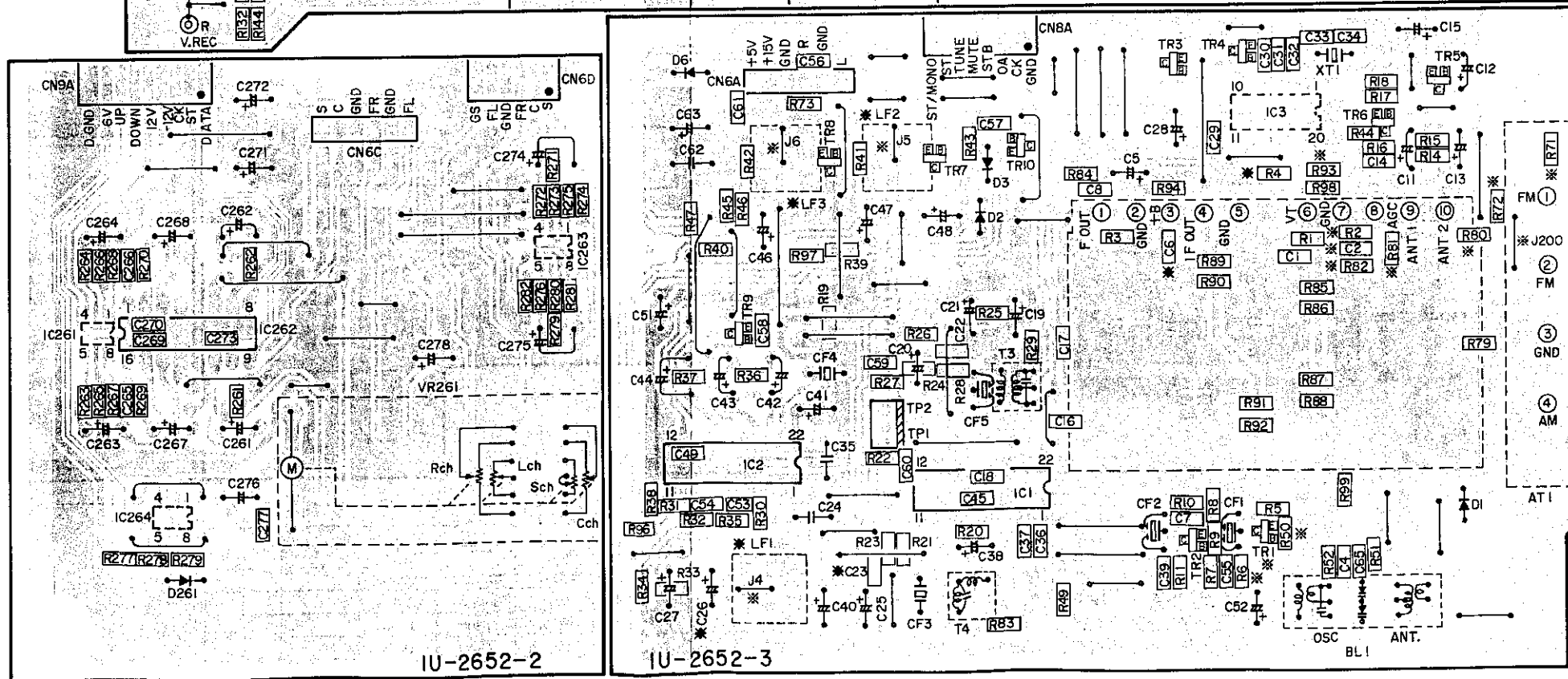
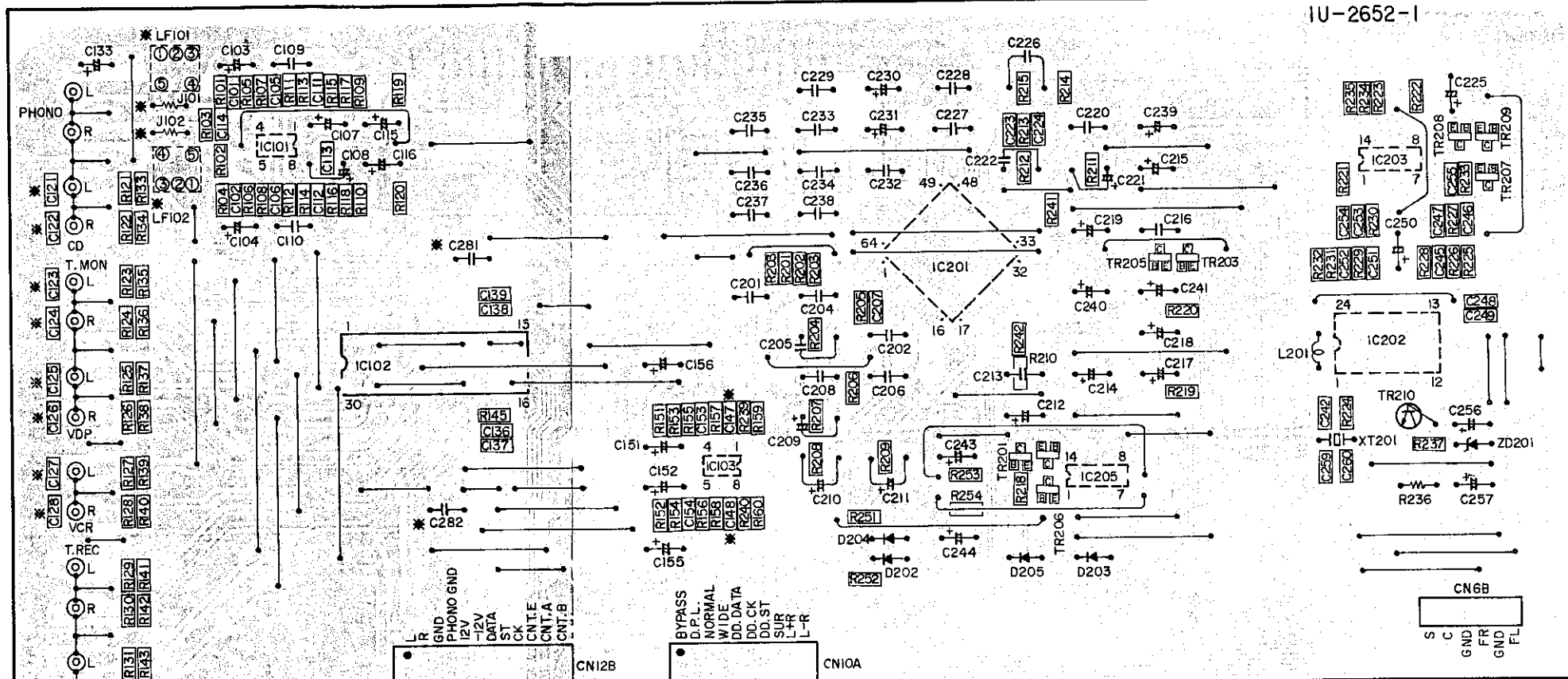

NOTE FOR PARTS LIST

- Part indicated with the mark "⊙" are not always in stock and possibly to take a long period of time for supplying, or in some case supplying of part may be refused.
- When ordering of part, clearly indicate "1" and "f" (f) to avoid mis-supplying.
- Ordering part without stating its part number can not be supplied.
- Part indicated with the mark "★" is not illustrated in the exploded view.
- Not including Carbon Film ±5%, 1/4W Type in the P.W.Board parts list. (Refer to the Schematic Diagram for those parts.)

WARNING:

Parts marked with this symbol  have critical characteristics. Use ONLY replacement parts recommended by the manufacturer.

● **Resistors**

Ex.: RN 14K 2E 182 G FR

Type	Shape and performance	Power	Resistance	Allowable error	Others
RD : Carbon		2B : 1/8W	F : ±1%	P : Pulse-resistant type	
RC : Composition		2E : 1/4W	G : ±2%	NL : Low noise type	
RS : Metal oxide film		2H : 1/2W	J : ±5%	NB : Non-burning type	
RW : Winding		3A : 1W	K : ±10%	FR : Fuse-resistor	
RN : Metal film		3D : 2W	M : ±20%	F : Lead wire forming	
RK : Metal mixture		3H : 5W			

● **Resistance**

$\overline{182} \Rightarrow 1800 \text{ ohm} = 1.8 \text{ kohm}$
 Indicates number of zeros after effective number.
 2-digit effective number.
 • Units: ohm

$\overline{1R2} \Rightarrow 1.2 \text{ ohm}$
 1-digit effective number.
 2-digit effective number, decimal point indicated by R.
 • Units: ohm

● **Capacitors**

Ex.: CE 04W 1H 2R2 M BP

Type	Shape and performance	Dielectric strength	Capacity	Allowable error	Others
CE : Aluminum foil electrolytic		0J : 6.3V	F : ±1%	HS : High stability type	
CA : Aluminum solid electrolytic		1A : 10V	G : ±2%	BP : Non-polar type	
CS : Tantalum electrolytic		1C : 16V	J : ±5%	HR : Ripple-resistant type	
CO : Film		1E : 25V	K : ±10%	DL : For charge and discharge	
CK : Ceramic		1V : 35V	M : ±20%	HF : For assuring high frequency	
CC : Ceramic		1H : 50V	Z : ±80%	U : UL part	
CP : Oil		2A : 100V	-20%	C : CSA part	
CM : Mica		2B : 125V	P : ±100%	W : UL-CSA type	
CF : Metallized		2C : 160V	-0%	F : Lead wire forming	
CH : Metallized		2D : 200V	C : ±0.25pF		
		2E : 250V	D : ±0.5pF		
		2H : 500V	± : Others		
		2J : 630V			

● **Capacity (electrolyte only)**

$\overline{222} \Rightarrow 2200\mu\text{F}$
 Indicates number of zeros after effective number.
 2-digit effective number.
 • Units: μF

$\overline{2R2} \Rightarrow 2.2\mu\text{F}$
 1-digit effective number.
 2-digit effective number, decimal point indicated by R.
 • Units: μF

● **Capacity (except electrolyte)**

$\overline{222} \Rightarrow 2200\text{pF} = 0.0022\mu\text{F}$
 (More than 2) — Indicates number of zeros after effective number.
 2-digit effective number.
 • Units: μF

$\overline{221} \Rightarrow 220\text{pF}$
 (0 or 1) — Indicates number of zeros after effective number.
 2-digit effective number.
 • Units: pF

• When the dielectric strength is indicated in AC, "AC" is included after the dielectric strength value.

P.W.B. ASS'Y PARTS LIST
1U-2650 MAIN UNIT ASS'Y (U.S.A. and Canada models)

Ref. No.	Part No.	Part Name	Remarks	Ref. No.	Part No.	Part Name	Remarks
SEMICONDUCTORS				CAPACITORS GROUP			
IC451	263 0322 004	IC BA4558		△ R372	241 2375 907	Carbon Film 10ohm 1/4W(NB)	RD14B2E100JNBS
IC801	262 1876 006	IC TMP87CH40F-4066	μ-com	△ R406-407	241 2380 963	Carbon Film 2.2kohm 1/4W(NB)	RD14B2E222JNBS
TR301-304	271 0094 919	Transistor 2SA970(BL)		△ R409	241 2377 976	Carbon Film 130ohm 1/4W(NB)	RD14B2E131JNBS
TR305,308	271 0131 924	Transistor 2SA988(E/F)		△ R413	241 2315 967	Fusible 68ohm 1/4W(NB)	RD14B2E680GFRS
TR307-312	273 0235 923	Transistor 2SC1841(E/F)		△ R416	241 2378 920	Carbon Film 220ohm 1/4W(NB)	RD14B2E221JNBS
TR313,314	273 0198 002	Transistor 2SC1815(Y)		△ R417-420	244 2043 982	Metal Oxide 0.22ohm 1W(NB)	RS14B3AR22JNBS(S)
TR315,316	274 0060 900	Transistor 2SD667A(C)		△ R423,424	241 2380 950	Carbon Film 2kohm 1/4W(NB)	RD14B2E202JNBS
TR319,320	272 0053 908	Transistor 2SB647A(C)		△ R425	244 2051 987	Metal Oxide 4.7ohm 1W(NB)	RS14B3A4R7JNBS(S)
TR323,324	273 0235 923	Transistor 2SC1841(E/F)		△ R430	241 2377 976	Carbon Film 130ohm 1/4W(NB)	RD14B2E131JNBS
TR351	271 0131 924	Transistor 2SA988(E/F)		△ R433-436	244 2043 982	Metal Oxide 0.22ohm 1W(NB)	RS14B3AR22JNBS(S)
TR353	272 0131 901	Transistor 2SB1041(R)		△ R480,481	241 2387 908	Carbon Film 1ohm 1/4W(NB)	RD14B2E010JNBS
TR401,402	271 0094 919	Transistor 2SA970(BL)		△ R482	244 2051 974	Metal Oxide 1kohm 1W(NB)	RS14B3A102JNBS(S)
TR403	271 0131 924	Transistor 2SA988(E/F)		△ R491	244 2050 988	Metal Oxide 2kohm 1W(NB)	RS14B3A202JNBS(S)
TR404-406	273 0235 923	Transistor 2SC1841(E/F)		△ R803	241 2387 940	Carbon Film 4.7ohm 1/4W(NB)	RD14B2E4R7JNBS
TR407	273 0198 002	Transistor 2SC1815(Y)		VR301,302	211 6047 023	Semi Fixed Resistor 4.7kohm	V06PB472
TR408	274 0060 900	Transistor 2SD667A(C)		VR401	211 6047 023	Semi Fixed Resistor 4.7kohm	V06PB472
TR409	272 0053 908	Transistor 2SB647A(C)		VR451	211 0798 103	Variable Resistor 100kohm	Balance
TR412	273 0235 923	Transistor 2SC1841(E/F)		VR452	211 0797 117	Variable Resistor 30kohm	Bass
TR413,414	271 0131 924	Transistor 2SA988(E/F)		VR453	211 0797 104	Variable Resistor 5kohm	Treble
TR415	273 0235 923	Transistor 2SC1841(E/F)		RA801	246 2067 003	Resistor Array 4.7kohmx11	RK99==472JP-1
TR416	271 0131 924	Transistor 2SA988(E/F)		RESISTORS GROUP (Not included Carbon Film ±5% 1/4 W Type. Refer to the Schematic Diagram for those Parts.)			
TR480-485	273 0388 906	Transistor 2SC1740S(E)		△ R311-314	241 2380 963	Carbon Film 2.2kohm 1/4W(NB)	RD14B2E222JNBS
TR486	271 0192 905	Transistor 2SA933S(S)		△ R317,318	241 2377 976	Carbon Film 130ohm 1/4W(NB)	RD14B2E131JNBS
TR487	273 0388 906	Transistor 2SC1740S(E)		△ R325,326	241 2315 967	Fusible 68ohm 1/4W(NB)	RD14B2E680GFRS
TR489	271 0192 905	Transistor 2SA933S(S)		△ R327,328	241 2378 920	Carbon Film 220ohm 1/4W(NB)	RD14B2E221JNBS
TR490	273 0388 906	Transistor 2SC1740S(E)		△ R329-336	244 2043 982	Metal Oxide 0.22ohm 1W(NB)	RS14B3AR22JNBS(S)
TR801-803	269 0022 904	Transistor DTA143ES	Built in Resistor	△ R341-344	241 2380 950	Carbon Film 2kohm 1/4W(NB)	RD14B2E202JNBS
TR805	273 0388 906	Transistor 2SC1740S(E)		△ R345,346	244 2051 987	Metal Oxide 4.7ohm 1W(NB)	RS14B3A4R7JNBS(S)
TR806	269 0018 905	Transistor DTC143ES	Built in Resistor	△ R355,356	241 2377 976	Carbon Film 130ohm 1/4W(NB)	RD14B2E131JNBS
TR807	269 0022 904	Transistor DTA143ES	Built in Resistor	△ R365-368	244 2051 958	Metal Oxide 220ohm 1W(NB)	RS14B3A221JNBS(S)
D301-306	276 0616 907	Diode 1SS252		△ R369-371	244 2051 987	Metal Oxide 4.7ohm 1W(NB)	RS14B3A4R7JNBS(S)
D307-310	276 0619 904	Diode 1S2471		D301-306	276 0616 907	Diode 1SS252	Bridge
D311-316	276 0616 907	Diode 1SS252		D401-403	276 0616 907	Diode 1SS252	
△ D351	276 0605 001	Diode 1S4VB20	Bridge	D404,405	276 0619 904	Diode 1S2471	
D401-403	276 0616 907	Diode 1SS252		D406,407	276 0616 907	Diode 1SS252	
D404,405	276 0619 904	Diode 1S2471		D480-482	276 0616 907	Diode 1SS252	
D406,407	276 0616 907	Diode 1SS252		D801	276 0619 904	Diode 1S2471	
D480-482	276 0616 907	Diode 1SS252		D804	276 0616 907	Diode 1SS252	
D801	276 0619 904	Diode 1S2471		D810,811	276 0616 907	Diode 1SS252	
D804	276 0616 907	Diode 1SS252		ZD351,352	276 0473 904	Zener Diode HZS12A-1	12V
D810,811	276 0616 907	Diode 1SS252		ZD480	276 0466 908	Zener Diode HZS7C-1	7V
ZD351,352	276 0473 904	Zener Diode HZS12A-1	12V	ZD801	276 0454 907	Zener Diode HZS3C-1	3V
ZD480	276 0466 908	Zener Diode HZS7C-1	7V	SC480	279 0016 904	Thyrister SF0R1A42	
ZD801	276 0454 907	Zener Diode HZS3C-1	3V				
SC480	279 0016 904	Thyrister SF0R1A42		C301,302	254 4254 909	Electrolytic 10μF/16V	CE04W1C100M
				C303,304	253 1179 903	Ceramic 100pF/50V	CK45B1H101K
				C305,306	253 1179 945	Ceramic 220pF/50V	CK45B1H221K
				C307,308	255 1264 966	Plastic Film 0.0033μF/50V	CQ93M1H332(B)
				C309,310	253 4536 954	Ceramic 16pF/50V	CC45SL1H160J
				C311,312	254 4258 952	Electrolytic 220μF/25V	CE04W1E221M
				C313-316	255 1264 908	Plastic Film 0.001μF/50V	CQ93M1H102(B)
				C317,318	253 4476 904	Ceramic 18pF/500V	CC45SL2H180J
				C321,322	254 4260 948	Electrolytic 1μF/50V	CE04W1H010M
				C323,324	253 1128 909	Ceramic 220pF/500V	CK45B2H221K
				C325,326	256 1034 979	Metalized 0.1μF/50V	CF93A1H104J
				C327,328	255 1265 936	Plastic Film 0.01μF/50V	CQ93M1H103(B)
				C329-332	254 4262 904	Electrolytic 4.7μF/63V	CE04W1J4R7M
				C334,335	253 1146 907	Ceramic 0.01μF/50V	CK45F1H103Z
				C351	255 1265 936	Plastic Film 0.01μF/50V	CQ93M1H103(B)
				C353,C354	254 4349 717	Electrolytic 5600μF/56V	CE04W==562NC(DL)
				C355,356	256 1034 979	Metalized 0.1μF/50V	CF93A1H104J
				C359	256 1034 979	Metalized 0.1μF/50V	CF93A1H104J
				C363	256 1042 903	Metalized 0.1μF/250V	CF93A2E104K
				C364,365	254 4260 948	Electrolytic 1μF/50V	CE04W1H010M
				C370	253 9038 907	BC Ceramic 0.47μF/50V	CK45-1H473Z
				C380	253 1181 904	Ceramic 0.01μF/50V	CK45F1H103Z
				C401	254 4254 909	Electrolytic 10μF/16V	CE04W1C100M
				C402	253 1179 903	Ceramic 100pF/50V	CK45B1H101K
				C403	253 1179 945	Ceramic 220pF/50V	CK45B1H221K
				C404	255 1264 966	Plastic Film 0.0033μF/50V	CQ93M1H332(B)
				C405	253 4536 954	Ceramic 16pF/50V	CC45SL1H160J
				C406	254 4256 952	Electrolytic 220μF/25V	CE04W1E221M
				C407,408	255 1264 908	Plastic Film 0.001μF/50V	CQ93M1H102(B)
				C409	253 4476 904	Ceramic 18pF/500V	CC45SL2H180J
				C411	254 4260 948	Electrolytic 1μF/50V	CE04W1H010M
				C412	253 1128 909	Ceramic 220pF/500V	CK45B2H221K
				C413	256 1034 979	Metalized 0.1μF/50V	CF93A1H104J
				C414	255 1265 936	Plastic Film 0.01μF/50V	CQ93M1H103(B)
				C415,416	254 4262 904	Electrolytic 4.7μF/63V	CE04W1J4R7M
				C417	254 4258 918	Electrolytic 10μF/35V	CE04W1V100M
				C418,419	255 1265 936	Plastic Film 0.01μF/50V	CQ93M1H103(B)
				C421,422	254 4254 909	Electrolytic 10μF/16V	CE04W1C100M
				C451,452	254 4254 909	Electrolytic 10μF/16V	CE04W1C100M
				C453-456	253 1179 903	Ceramic 100pF/50V	CK45B1H101K

1U-2650B MAIN UNIT ASS'Y (Europe model)
 [Same as 1U-2650 (for U.S.A. and Canada models)
 except the followings.]

Ref. No.	Part No.	Part Name	Remarks	
C457,458	254 4254 938	Electrolytic 47μF/16V	CE04W1C470M	
C459,460	255 1264 908	Plastic Film 0.001μF/50V	CQ93M1H102J(B)	
C461,462	256 1034 995	Metalized 0.15μF/50V	CF93A1H154J	
C463,464	254 4260 948	Electrolytic 1μF/50V	CE04W1H010M	
C465,466	255 1264 937	Plastic Film 0.0018μF/50V	CQ93M1H182J(B)	
C467,468	255 1265 949	Plastic Film 0.012μF/50V	CQ93M1H123J(B)	
C469,470	256 1034 953	Metalized 0.068μF/50V	CF93A1H683J	
C471,472	254 4260 935	Electrolytic 0.47μF/50V	CE04W1HR47M	
C473	253 9038 907	BC Ceramic 0.047μF/50V	CK45-1H473Z	
C474	255 1265 978	Plastic Film 0.022μF/50V	CQ93M1H223J(B)	
C480	254 4260 980	Electrolytic 10μF/50V	CE04W1H100M	
C481	254 4260 993	Electrolytic 22μF/50V	CE04W1H220M	
C482	254 4250 945	Electrolytic 330μF/6.3V	CE04W0J331M	
C801	254 4250 783	Electrolytic 3300μF/6.3V	CE04W0J332MC	
C802,803	253 1181 904	Ceramic 0.01μF/50V	CK45F1H103Z	
C804	254 4250 932	Electrolytic 220μF/6.3V	CE04W0J221M	
C805	256 1034 982	Metalized 0.12μF/50V	CF93A1H124J	
C812	254 4258 905	Electrolytic 4.7μF/35V	CE04W1V4R7M	
C813	255 1265 936	Plastic Film 0.01μF/50V	CQ93M1H103J(B)	
OTHER GROUP				
	—	(P.W.Board)	Q'ty	
L301,302	235 0104 007	Inductor 1μH	1	
L401	235 0104 007	Inductor 1μH	2	
RL480	214 0167 005	Relay(G5Z-2A)	1	
RL481	214 9003 005	Relay	1	
RL482	214 0162 000	Relay(A12W-K)	1	
XT801	399 0191 903	Ceramic Resonator	CST4.00MGW19MGW 1	
	204 8354 004	Headphone Jack	Front	
	205 0846 005	6P Push Terminal		1
	205 0255 007	Terminal		3
	415 0309 013	P.V.C. Tube(L=10)	6	
TP	205 0190 036	3P NH Conn. Base	3	
CN3A	205 0343 032	3P Conn. Base(KR-PH)	2	
CN4A	205 0343 045	4P Conn. Base(KR-PH)	1	
CN11A	205 0375 013	11P Conn. Base(KR-PH)	1	
CN6A	205 0696 064	JL Connector(BT-E)	1	
CN6B	205 0696 064	JL Connector(BT-E)	1	
CN6C	205 0696 064	JL Connector(BT-E)	1	
CN6D	205 0330 003	6P MQ-ST Conn. Base	1	
CN8A	205 0330 029	8P MQ-ST Conn. Base	1	
CN9A	205 0330 045	9P MQ-ST Conn. Base	1	
CN10A	205 0330 058	10P MQ-ST Conn. Base	1	
CN12A	205 0375 026	12P Conn. Base(KR-PH)	1	
CN12B	205 0330 016	12P MQ-ST Conn. Base	1	

Ref. No.	Part No.	Part Name	Remarks
SEMICONDUCTORS			
D313-316	276 0616 907	Diode 1SS252	Delete
CAPACITORS GROUP			
C314	253 1146 907	Ceramic 0.01μF/50V	Add
C316	253 1146 907	Ceramic 0.01μF/50V	Add
C357,358	255 1264 982	Plastic Film 0.0047μF/50V	Add
C360	255 1264 982	Plastic Film 0.0047μF/50V	Add

1U-2651 REAR AMP. UNIT ASS'Y
(U.S.A. and Canada models)

Ref. No.	Part No.	Part Name	Remarks
SEMICONDUCTORS			
IC501,502	263 0855 005	IC SI-18752	Regulator +12V Regulator -12V IC Protector 20V Regulator +6V IC Protector 15V
IC503	263 0801 004	IC NJM7812FA(S)	
IC504	263 0641 002	IC NJM7912FA	
IC505,506	268 0074 904	IC ICP-N20	
IC551	263 0793 002	IC NJM7806FA(S)	
IC552	268 0073 905	IC ICP-N15	
IC601	262 1873 009	IC BU4066BC	
IC701	499 0150 008	IC SBX1610-52	
IC702	262 1564 004	IC MSC1937-01	
TR551,552	273 0388 906	Transistor 2SC1740S(E)	
TR601,602	273 0198 918	Transistor 2SC1815(BL)	
TR603,604	271 0102 924	Transistor 2SA1015(GR)	
TR605	269 0018 905	Transistor DTC143ES	
			Built in Resistor
D501	276 0616 907	Diode 1SS252	Bridge
▲ D502	276 0305 001	Diode 54VB20	
D551	276 0616 907	Diode 1SS252	
D552-557	276 0553 905	Diode 1SR35-200A	
D601-603	276 0616 907	Diode 1SS252	
ZD551	276 0465 909	Zener Diode HZS7B-1	7V
ZD701	276 0467 907	Zener Diode HZS9A-1	9V
LD701	393 9434 906	LED SEL1210S	Red
FL701	393 4131 000	FLD Ass'y FIP14PM8	
RESISTORS GROUP (Not included Carbon Film ± 5% 1/4 W Type. Refer to the Schematic Diagram for those Parts.)			
▲ R509,510	244 2051 987	Metal Oxide 4.7ohm 1/4 W(NB)	RS14B3A4R7JNBS(S)
▲ R513	241 2387 908	Carbon Film 1ohm 1/4 W(NB)	RD14B2E010JNBS
▲ R556	241 2375 978	Carbon Film 20ohm 1/4 W(NB)	RD14B2E200JNBS
▲ R557	242 0073 000	Carbon Composit 2.2Mohm 1/2W	RC05GF2H225K
▲ R624	241 2375 907	Carbon Film 10ohm 1/4 W(NB)	RD14B2E100JNBS
▲ R625	241 2387 908	Carbon Film 1ohm 1/4 W(NB)	RD14B2E010JNBS
▲ R626	241 2387 940	Carbon Film 4.7ohm 1/4 W(NB)	RD14B2E4R7JNBS
CAPACITORS GROUP			
C501,502	253 1179 903	Ceramic 100pF/50V	CK45B1H101K
C503,504	254 4260 951	Electrolytic 2.2μF/50V	CE04W1H2R2M
C505,506	254 4254 938	Electrolytic 47μF/16V	CE04W1C470M
C507,508	254 4260 948	Electrolytic 1μF/50V	CE04W1H010M
C511,512	256 1034 979	Metalized 0.1μF/50V	CF93A1H104J
C513,514	253 1146 907	Ceramic 0.01μF/50V	CK45F1H103Z
C517,518	254 4259 713	Electrolytic 3300μF/35V	CE04W1V332MC
C519,520	253 1146 907	Ceramic 0.01μF/50V	CK45F1H103Z
C521,522	254 4258 918	Electrolytic 10μF/35V	CE04W1V100M
C524	256 1042 903	Metalized 0.1μF/250V	CF93A2E104K
C526	253 1146 907	Ceramic 0.01μF/50V	CK45F1H103Z
C551	253 1146 907	Ceramic 0.01μF/50V	CK45F1H103Z
C552	254 4254 909	Electrolytic 10μF/16V	CE04W1C100M
C554	254 4260 948	Electrolytic 1μF/50V	CE04W1H010M
C555	254 4256 790	Electrolytic 2200μF/25V	CE04W1E222MC
C556,557	253 1146 907	Ceramic 0.01μF/50V	CK45F1H103Z
C558	254 4260 948	Electrolytic 1μF/50V	CE04W1H010M
▲ C559	253 8014 702	Ceramic 0.01μF/400V(AC)	CK45F2GAC103MC
C601,602	254 4252 927	Electrolytic 47μF/10V	CE04W1A470M
C603	254 4260 948	Electrolytic 1μF/50V	CE04W1H010M
C604	253 1146 907	Ceramic 0.01μF/50V	CK45F1H103Z
C605,606	253 4535 955	Ceramic 5pF/50V	CC45SL1H050C

Ref. No.	Part No.	Part Name	Remarks	Q'ty
C609	254 4254 776	Electrolytic 470μF/16V	CE04W1C471M	
C610,611	254 4252 079	Electrolytic 1000μF/10V	CE04W1A102M	
C701	256 1034 979	Metalized 0.1μF/50V	CF93A1H104J	
C702	254 4261 921	Electrolytic 100μF/50V	CE04W1H101M	
C703	254 4250 945	Electrolytic 330μF/6.3V	CE04W0J331M	
OTHER GROUP				
		(P.W.Board)		1
L501,502	235 0104 007	Inductor 1μH		2
L701	235 0060 989	Inductor 120μH		1
RL501	214 0167 005	Relay(G5Z-2A)	Rear	1
▲ RL551	214 0170 005	Relay(TV-0)	Rear	1
S701-721	212 5604 910	Tact Switch		21
	202 0040 909	Fuse Clip		6
▲	203 3941 008	AC Outlet(2P)		1
▲	233 6073 000	Power Trans(Min)		1
▲ F001	216 1046 001	Fuse 5.3 A(UL) 20 mm	Fuse Pri.	1
▲ F003,004	216 1046 027	Fuse 5 A	Fuse Sec.	2
	204 8442 000	4P Pin Jack(C-GND)	Video	1
	205 0592 003	4P Push Terminal	Rear	1
CN4A	205 0343 045	4P Conn. Base(KR-PH)		1
CN11A	204 6469 001	11P PH-SAN Conn. Cord		1
CN12A	204 6470 003	12P PH-SAN Conn. Cord		1
	205 0075 025	2P Terminal		1

1U-2651B REAR AMP. UNIT ASS'Y (Europe model)
[Same as 1U-2651 (for U.S.A. and Canada models)
except the followings.]

1U-2652 SURROUND UNIT ASS'Y
(U.S.A. and Canada models)

Ref. No.	Part No.	Part Name	Remarks
RESISTORS GROUP			
R557	242 0073 000	Carbon Composit 2.2Mohm 1/2W	Delete
CAPACITORS GROUP			
C501,502 C531,532	253 1179 903 253 1179 903	Ceramic 100pF/50V Ceramic 100pF/50V	Add Add
OTHER GROUP			
⚠	203 3941 009	AC Outlet (2P)	Delete
⚠	233 6058 012	Power Trans (Mini)	Change
⚠ F001	205 1015 032	Fuse (2.5A)	Change
⚠ F003,004	216 1046 027	Fuse 5A	Delete
	202 0040 909	Fuse Clip (4)	Change
	205 0692 000	2P Wrapping Terminal	Add

Ref. No.	Part No.	Part Name	Remarks
SEMICONDUCTORS			
IC001	263 0891 001	IC LA1265(S)	
IC002	263 0439 007	IC LA3401	
IC003	263 0791 907	IC LM7001M	
IC004	216 0064 007	Front End	
IC101	263 0672 903	IC BA4558F	
IC102	262 1228 007	IC LC7822	
IC103	263 0672 903	IC BA4558F	
IC201	263 0906 006	IC NJM2177AF	
IC202	262 1874 008	IC NJU9701G	
IC203	262 1875 900	IC BU40668CF	
IC205	262 1875 900	IC BU40668CF	
IC261	263 0672 903	IC BA4558F	
IC262	262 0625 009	IC TC9176P	
IC263	263 0672 903	IC BA4558F	
IC264	263 0905 900	IC BA6208F	
TR002	273 0411 909	Transistor 2SC2996-Y	
TR003,004	269 0114 906	Transistor RN2402	Built in Resistor
TR005	273 0403 904	Transistor 2SC2712-Y/GR	
TR006	275 0075 901	FET 2SK209-Y/GR	
TR007,008	269 0066 902	Transistor DTC323TK	Built in Resistor
TR009	269 0085 909	Transistor DTC144TK	Built in Resistor
TR010	269 0086 908	Transistor DTA114TK	Built in Resistor
TR201	269 0055 900	Transistor DTA144EK	Built in Resistor
TR202,203	269 0054 901	Transistor DTC144EK	Built in Resistor
TR205	269 0054 901	Transistor DTC144EK	Built in Resistor
TR206	273 0384 900	Transistor 2SC2412K(S)	
TR207-209	269 0054 901	Transistor DTC144EK	Built in Resistor
TR210	274 0169 908	Transistor 2SD1292(R)	
D001-003	276 0616 907	Diode 1SS252	
D006	276 0616 907	Diode 1SS252	
D202-205	276 0616 907	Diode 1SS252	
D261	276 0616 907	Diode 1SS252	
ZD201	276 0462 902	Zener Diode HZ56B-1	6V

RESISTORS GROUP (Not included Carbon Film ±5% 1/4 W Type.)
Refer to the Schematic Diagram for those Parts.)

R001	247 0007 945	Chip Carbon 1kohm 1/10W	RM73B-102J
R003	247 0004 906	Chip Carbon 39ohm 1/10W	RM73B-390J
R005	247 0007 945	Chip Carbon 1kohm 1/10W	RM73B-102J
R007	247 0009 901	Chip Carbon 4.7kohm 1/10W	RM73B-472J
R008	247 0006 920	Chip Carbon 330ohm 1/10W	RM73B-331J
R009	247 0005 989	Chip Carbon 220ohm 1/10W	RM73B-221J
R010	247 0008 902	Chip Carbon 1.8kohm 1/10W	RM73B-182J
R011	247 0006 920	Chip Carbon 330ohm 1/10W	RM73B-331J
R014	247 0005 905	Chip Carbon 100ohm 1/10W	RM73B-101J
R015	247 0009 969	Chip Carbon 8.2kohm 1/10W	RM73B-822J
R016	247 0008 986	Chip Carbon 3.9kohm 1/10W	RM73B-392J
R017	247 0006 946	Chip Carbon 390ohm 1/10W	RM73B-391J
R018	247 0005 947	Chip Carbon 150ohm 1/10W	RM73B-151J
R019	247 0005 921	Chip Carbon 120ohm 1/10W	RM73B-121J
R020	247 0010 929	Chip Carbon 15kohm 1/10W	RM73B-153J
R021	247 0005 921	Chip Carbon 120ohm 1/10W	RM73B-121J
R022	247 0010 945	Chip Carbon 18kohm 1/10W	RM73B-183J
R023	247 0018 905	Chip Carbon 0ohm 1/10W	RM73B-0R0K
R024	247 0009 943	Chip Carbon 6.8kohm 1/10W	RM73B-682J
R025,026	247 0009 985	Chip Carbon 10kohm 1/10W	RM73B-103J
R027	247 0008 960	Chip Carbon 3.3kohm 1/10W	RM73B-332J
R028	247 0009 972	Chip Carbon 9.1kohm 1/10W	RM73B-912J
R029	247 0011 986	Chip Carbon 68kohm 1/10W	RM73B-683J

Ref. No.	Part No.	Part Name	Remarks	Ref. No.	Part No.	Part Name	Remarks
R030,031	247 0011 973	Chip Carbon 62kohm 1/10W	RM73B-623J	R239,240	247 0005 905	Chip Carbon 100ohm 1/10W	RM73B-101J
R032	247 0012 927	Chip Carbon 100kohm 1/10W	RM73B-104J	R241,242	247 0006 962	Chip Carbon 470ohm 1/10W	RM73B-471J
R033,034	247 0012 949	Chip Carbon 120kohm 1/10W	RM73B-124J	R251,252	247 0008 928	Chip Carbon 2.2kohm 1/10W	RM73B-222J
R035	247 0012 927	Chip Carbon 100kohm 1/10W	RM73B-104J	R253,254	247 0009 901	Chip Carbon 4.7kohm 1/10W	RM73B-472J
R036	247 0008 960	Chip Carbon 3.3kohm 1/10W	RM73B-332J	R261,262	247 0012 927	Chip Carbon 100kohm 1/10W	RM73B-104J
R037,038	247 0012 927	Chip Carbon 100kohm 1/10W	RM73B-104J	R263,264	247 0013 900	Chip Carbon 220kohm 1/10W	RM73B-224J
R039,040	247 0008 960	Chip Carbon 3.3kohm 1/10W	RM73B-332J	R265,266	247 0007 945	Chip Carbon 1kohm 1/10W	RM73B-102J
R041,042	247 0009 949	Chip Carbon 6.8kohm 1/10W	RM73B-682J	R267,268	247 0008 960	Chip Carbon 3.3kohm 1/10W	RM73B-332J
R043	247 0010 961	Chip Carbon 22kohm 1/10W	RM73B-223J	R269,270	247 0005 905	Chip Carbon 100ohm 1/10W	RM73B-101J
R044,045	247 0009 985	Chip Carbon 10kohm 1/10W	RM73B-103J	R271	247 0013 984	Chip Carbon 470kohm 1/10W	RM73B-474J
R046	247 0009 927	Chip Carbon 5.6kohm 1/10W	RM73B-562J	R272	247 0005 905	Chip Carbon 100ohm 1/10W	RM73B-101J
R047	247 0009 985	Chip Carbon 10kohm 1/10W	RM73B-103J	R273	247 0007 945	Chip Carbon 1kohm 1/10W	RM73B-102J
R050	247 0005 905	Chip Carbon 100ohm 1/10W	RM73B-101J	R274	247 0009 927	Chip Carbon 5.6kohm 1/10W	RM73B-562J
R051,052	247 0012 927	Chip Carbon 100kohm 1/10W	RM73B-104J	R275,276	247 0005 905	Chip Carbon 100ohm 1/10W	RM73B-101J
R072	247 1018 904	Chip Carbon 0ohm 1/8W	RM73B2B0R0K	R277,278	247 0009 985	Chip Carbon 10kohm 1/10W	RM73B-103J
R080	247 1018 904	Chip Carbon 0ohm 1/8W	RM73B2B0R0K	R279	247 0013 984	Chip Carbon 470kohm 1/10W	RM73B-474J
R082,083	247 1018 904	Chip Carbon 0ohm 1/8W	RM73B2B0R0K	R280	247 0007 945	Chip Carbon 1kohm 1/10W	RM73B-102J
R084	247 0018 905	Chip Carbon 0ohm 1/10W	RM73B-0R0K	R281	247 0009 927	Chip Carbon 5.6kohm 1/10W	RM73B-562J
R085-082	247 1018 904	Chip Carbon 0ohm 1/8W	RM73B2B0R0K	R282	247 0005 905	Chip Carbon 100ohm 1/10W	RM73B-101J
R094	247 1018 904	Chip Carbon 0ohm 1/8W	RM73B2B0R0K	VR261	211 0802 002	Variable Resistor 100kohm	
R096-098	247 1018 904	Chip Carbon 0ohm 1/8W	RM73B2B0R0K	CAPACITORS GROUP			
R101,102	247 0006 946	Chip Carbon 390ohm 1/10W	RM73B-391J	C001	257 0012 968	Chip Ceramic 0.01µF/50V	CK73F1H103Z
R103,104	247 0011 986	Chip Carbon 68kohm 1/10W	RM73B-683J	C004	257 0002 947	Chip Ceramic 12pF/50V	CC73SL1H120J
R105,106	247 0012 969	Chip Carbon 150kohm 1/10W	RM73B-154J	C005	254 4254 909	Electrolytic 10µF/16V	CE04W1C100W
R107,108	247 0004 922	Chip Carbon 47ohm 1/10W	RM73B-470J	C007,008	257 0012 966	Chip Ceramic 0.01µF/50V	CK73F1H103Z
R109,110	247 0007 945	Chip Carbon 1kohm 1/10W	RM73B-102J	C011	254 3056 917	Electrolytic 1µF/50V (Bipole)	CE04D1H010MBP
R111,112	247 0014 909	Chip Carbon 560kohm 1/10W	RM73B-564J	C012	254 4254 938	Electrolytic 47µF/16V	CE04W1C470W
R113,114	247 0011 944	Chip Carbon 47kohm 1/10W	RM73B-473J	C013	254 4260 906	Electrolytic 0.1µF/50V	CE04W1H0R1M
R115,116	247 0003 949	Chip Carbon 22ohm 1/10W	RM73B-220J	C014	257 0012 982	Chip Ceramic 0.022µF/50V	CK73F1H223Z
R117,118	247 0005 905	Chip Carbon 100ohm 1/10W	RM73B-101J	C016	257 0004 961	Chip Ceramic 100pF/50V	CC73SL1H101J
R119,120	247 0013 984	Chip Carbon 470kohm 1/10W	RM73B-474J	C017,018	257 0012 966	Chip Ceramic 0.01µF/50V	CK73F1H103Z
R121-132	247 0015 966	Chip Carbon 2.7Mohm 1/10W	RM73B-275J	C019	254 4260 935	Electrolytic 0.47µF/50V	CE04W1HR47M
R133-144	247 0006 962	Chip Carbon 470ohm 1/10W	RM73B-471J	C020	254 4260 948	Electrolytic 1µF/50V	CE04W1H010W
R145	247 0014 925	Chip Carbon 680kohm 1/10W	RM73B-684J	C021	254 4260 980	Electrolytic 10µF/50V	CE04W1H100W
R151,152	247 0006 962	Chip Carbon 470ohm 1/10W	RM73B-471J	C022	257 0012 982	Chip Ceramic 0.022µF/50V	CK73F1H223Z
R153,154	247 0011 973	Chip Carbon 62kohm 1/10W	RM73B-623J	C023	257 0004 961	Chip Ceramic 100pF/50V	CC73SL1H101J
R155,156	247 0013 984	Chip Carbon 470kohm 1/10W	RM73B-474J	C024	256 1034 940	Metalized 0.056µF/50V	CF93A1H563J
R157-160	247 0005 905	Chip Carbon 100ohm 1/10W	RM73B-101J	C025	254 4254 912	Electrolytic 22µF/16V	CE04W1C220M
R201	247 0009 956	Chip Carbon 7.5kohm 1/10W	RM73B-752J	C027	254 4254 909	Electrolytic 10µF/16V	CE04W1C100W
R202	247 0011 944	Chip Carbon 47kohm 1/10W	RM73B-473J	C028	254 4260 948	Electrolytic 1µF/50V	CE04W1H010M
R203	247 0010 929	Chip Carbon 15kohm 1/10W	RM73B-153J	C029	257 0012 966	Chip Ceramic 0.01µF/50V	CK73F1H103Z
R204	247 0009 956	Chip Carbon 7.5kohm 1/10W	RM73B-752J	C033,034	257 0002 976	Chip Ceramic 16pF/50V	CC73SL1H16KJ
R205	247 0011 944	Chip Carbon 47kohm 1/10W	RM73B-473J	C035	256 1034 937	Metalized 0.047µF/50V	CF93A1H473J
R206	247 0010 929	Chip Carbon 15kohm 1/10W	RM73B-153J	C036,037	257 0012 966	Chip Ceramic 0.01µF/50V	CK73F1H103Z
R207	247 0016 923	Chip Carbon 4.7Mohm 1/10W	RM73B-475J	C038	254 4254 938	Electrolytic 47µF/16V	CE04W1C470M
R208,209	247 0011 960	Chip Carbon 56kohm 1/10W	RM73B-563J	C039	257 0012 966	Chip Ceramic 0.01µF/50V	CK73F1H103Z
R210	247 0012 927	Chip Carbon 100kohm 1/10W	RM73B-104J	C040	254 4260 948	Electrolytic 1µF/50V	CE04W1H010M
R211	247 0019 988	Chip Carbon 100kohm 1/10W	RM73B-104F(±1%)	C041	254 4254 938	Electrolytic 47µF/16V	CE04W1C470M
R212	247 0010 929	Chip Carbon 15kohm 1/10W	RM73B-153J	C042	254 4260 948	Electrolytic 1µF/50V	CE04W1H010M
R213	247 0009 969	Chip Carbon 8.2kohm 1/10W	RM73B-822J	C043	254 4260 919	Electrolytic 0.22µF/50V	CE04W1HR22M
R214	247 0010 929	Chip Carbon 15kohm 1/10W	RM73B-153J	C044	254 4260 948	Electrolytic 1µF/50V	CE04W1H010M
R215	247 0013 942	Chip Carbon 330kohm 1/10W	RM73B-334J	C045	257 0012 966	Chip Ceramic 0.01µF/50V	CK73F1H103Z
R218-220	247 0011 944	Chip Carbon 47kohm 1/10W	RM73B-473J	C046,047	254 4260 951	Electrolytic 2.2µF/50V	CE04W1H2R2M
R221-223	247 0009 969	Chip Carbon 8.2kohm 1/10W	RM73B-822J	C048	254 4260 948	Electrolytic 1µF/50V	CE04W1H010M
R224	247 0014 967	Chip Carbon 1Mohm 1/10W	RM73B-105J	C049	257 0012 966	Chip Ceramic 0.01µF/50V	CK73F1H103Z
R225	247 0010 929	Chip Carbon 15kohm 1/10W	RM73B-153J	C051	254 4260 951	Electrolytic 2.2µF/50V	CE04W1H2R2M
R226	247 0010 945	Chip Carbon 18kohm 1/10W	RM73B-183J	C052	254 4254 909	Electrolytic 10µF/16V	CE04W1C100W
R227	247 0010 929	Chip Carbon 15kohm 1/10W	RM73B-153J	C053,054	257 0006 972	Chip Ceramic 750pF/50V	CC73SL1H751J
R228,229	247 0003 936	Chip Carbon 20ohm 1/10W	RM73B-200J	C056,057	257 0012 966	Chip Ceramic 0.01µF/50V	CK73F1H103Z
R230	247 0009 956	Chip Carbon 7.5kohm 1/10W	RM73B-752J	C059-061	257 0012 966	Chip Ceramic 0.01µF/50V	CK73F1H103Z
R231	247 0009 927	Chip Carbon 5.6kohm 1/10W	RM73B-562J	C063	254 4254 909	Electrolytic 10µF/16V	CE04W1C100M
R232	247 0010 945	Chip Carbon 18kohm 1/10W	RM73B-183J				
R233-235	247 0011 944	Chip Carbon 47kohm 1/10W	RM73B-473J				
R236	247 0007 945	Chip Carbon 1kohm 1/10W	RM73B-102J				

Ref. No.	Part No.	Part Name	Remarks	Ref. No.	Part No.	Part Name	Remarks	Q'ty	
C065	257 0012 966	Chip Ceramic 0.01µF/50V	CK73F1H103Z	C276	254 3056 917	Electrolytic 1µF/50V (Bipole)	CE04D1H010MBP		
C101,102	257 0005 944	Chip Ceramic 220pF/50V	CC73SL1H221J	C277	257 0012 966	Chip Ceramic 0.01µF/50V	CK73F1H103Z		
C103,104	254 4254 909	Electrolytic 10µF/16V	CE04W1C100M	C278	254 4260 948	Electrolytic 1µF/50V	CE04W1H010M		
C105,106	257 0004 961	Chip Ceramic 100pF/50V	CC73SL1H101J	C279	257 0012 966	Chip Ceramic 0.01µF/50V	CK73F1H103Z		
C107,108	254 4254 925	Electrolytic 33µF/16V	CE04W1C330M	OTHER GROUP					
C109,110	255 1264 995	Plastic Film 0.0056µF/50V	CQ93M1H562J(B)			(P.W.Board)		1	
C111,112	257 0009 908	Chip Ceramic 1500pF/50V	CK73B1H152K	CF001	261 0135 907	Ceramic Filter MA8		1	
C113,114	257 0012 982	Chip Ceramic 0.022µF/50V	CK73F1H223Z	CF002	261 0136 906	Ceramic Filter MS2G		1	
C115,116	254 4260 951	Electrolytic 2.2µF/50V	CE04W1H2R2M	CF003	261 0031 001	Ceramic Filter BFU450C4		1	
C133	254 4260 948	Electrolytic 1µF/50V	CE04W1H010M	CF004	261 0079 005	Ceramic Filter CSB456F11		1	
C136-138	257 0012 982	Chip Ceramic 0.022µF/50V	CK73F1H223Z	CF005	261 0116 007	Ceramic Filter SFU450B3		1	
C139	257 0009 924	Chip Ceramic 2200pF/50V	CK73B1H222K	L201	235 0060 999	Inductor 120µH		1	
C151,152	254 4254 909	Electrolytic 10µF/16V	CE04W1C100M	XT001	399 0075 003	Crystal 7.2 MHz		1	
C153,154	257 0004 961	Chip Ceramic 100pF/50V	CC73SL1H101J	XT201	399 0223 907	Ceramic Resonator	CSA2.00MG-TF01	1	
C155,156	254 4260 948	Electrolytic 1µF/50V	CE04W1H010M	BL001	231 2096 001	MW Ant. Osc.Coil		1	
C201,202	256 1034 979	Metalized 0.1µF/50V	CF93A1H104J	T003	231 1138 009	AM IFT		1	
C203	257 0006 969	Chip Ceramic 680pF/50V	CC73SL1H681J	T004	231 2085 009	FM Det. Trans		1	
C204	256 1034 937	Metalized 0.47µF/50V	CF93A1H474J		205 0505 003	4P Push Terminal		1	
C205,206	256 1034 979	Metalized 0.1µF/50V	CF93A1H104J		204 8313 003	4P Pin Jack(S-GND)		2	
C207	257 0006 969	Chip Ceramic 680pF/50V	CC73SL1H681J		204 8346 009	6P Pin Jack(S-GND)		1	
C208	256 1034 937	Metalized 0.47µF/50V	CF93A1H474J	TP	205 0190 036	3P NH Conn. Base		1	
C209	254 4254 912	Electrolytic 22µF/16V	CE04W1C220M	CN6A	205 0748 064	JL Connector(R)		1	
C210,211	254 4254 909	Electrolytic 10µF/16V	CE04W1C100M	CN6B	205 0748 064	JL Connector(R)		1	
C212	254 4252 930	Electrolytic 100µF/10V	CE04W1A101M	CN6C	205 0748 064	JL Connector(R)		1	
C213	255 1264 982	Plastic Film 0.0047µF/50V	CQ93M1H472J(B)	CN6D	205 0483 060	6P MQ-ST Conn. Base		1	
C214	254 4254 912	Electrolytic 22µF/16V	CE04W1C220M	CN8A	205 0483 086	8P MQ-ST Conn. Base		1	
C215	254 4254 909	Electrolytic 10µF/16V	CE04W1C100M	CN9A	205 0483 099	9P MQ-ST Conn. Base		2	
C216	256 1035 910	Metalized 0.22µF/50V	CF93A1H224J	CN10A	205 0483 002	10P MQ-ST Conn. Base		1	
C217,218	254 4254 909	Electrolytic 10µF/16V	CE04W1C100M	CN12B	205 0483 025	12P MQ-ST Conn. Base		1	
C219	254 4254 941	Electrolytic 100µF/16V	CE04W1C101M						
C220	255 1264 995	Plastic Film 0.0056µF/50V	CQ93M1H562J(B)						
C221	254 4250 958	Electrolytic 470µF/6.3V	CE04W0J471M						
C222	256 1034 937	Metalized 0.47µF/50V	CF93A1H474J						
C223	257 0006 927	Chip Ceramic 470pF/50V	CC73SL1H471J						
C224	257 0009 924	Chip Ceramic 2200pF/50V	CK73B1H222K						
C225	254 4260 948	Electrolytic 1µF/50V	CE04W1H010M						
C226	256 1035 978	Metalized 0.68µF/50V	CF93A1H684J						
C227-229	256 1035 910	Metalized 0.22µF/50V	CF93A1H224J						
C230,231	254 4260 977	Electrolytic 4.7µF/50V	CE04W1H4R7M						
C232	256 1035 910	Metalized 0.22µF/50V	CF93A1H224J						
C233-236	256 1034 979	Metalized 0.1µF/50V	CF93A1H104J						
C237,238	255 1265 978	Plastic Film 0.022µF/50V	CQ93M1H223J(B)						
C239-241	254 4260 948	Electrolytic 1µF/50V	CE04W1H010M						
C242	257 0014 935	Chip Ceramic 0.1µF/25V	CK73F1E104Z						
C243,244	254 4260 948	Electrolytic 1µF/50V	CE04W1H010M						
C245	257 0006 927	Chip Ceramic 470pF/50V	CC73SL1H471J						
C246	257 0009 940	Chip Ceramic 3300pF/50V	CK73B1H332K						
C247	257 0014 935	Chip Ceramic 0.1µF/25V	CK73F1E104Z						
C248,249	257 0013 907	Chip Ceramic 0.047µF/50V	CK73F1H473Z						
C250	254 4254 938	Electrolytic 47µF/16V	CE04W1C470M						
C251	257 0014 935	Chip Ceramic 0.1µF/25V	CK73F1E104Z						
C252	257 0006 927	Chip Ceramic 470pF/50V	CC73SL1H471J						
C253,254	257 0009 979	Chip Ceramic 5600pF/50V	CK73B1H562K						
C255	257 0014 935	Chip Ceramic 0.1µF/25V	CK73F1E104Z						
C256	254 4254 909	Electrolytic 10µF/16V	CE04W1C100M						
C257	254 4252 930	Electrolytic 100µF/10V	CE04W1A101M						
C259,260	257 0005 944	Chip Ceramic 220pF/50V	CC73SL1H221J						
C261-264	254 4254 909	Electrolytic 10µF/16V	CE04W1C100M						
C265	257 0006 927	Chip Ceramic 470pF/50V	CC73SL1H471J						
C266	257 0005 966	Chip Ceramic 330pF/50V	CC73SL1H331J						
C267,268	254 4254 909	Electrolytic 10µF/16V	CE04W1C100M						
C269,270	257 0012 982	Chip Ceramic 0.022µF/50V	CK73F1H223Z						
C271,272	254 4254 909	Electrolytic 10µF/16V	CE04W1C100M						
C273	257 0005 944	Chip Ceramic 220pF/50V	CC73SL1H221J						
C274,275	254 4254 909	Electrolytic 10µF/16V	CE04W1C100M						

1U-2652B SURROUND UNIT ASS'Y (Europe model)

Ref. No.	Part No.	Part Name	Remarks	Ref. No.	Part No.	Part Name	Remarks
SEMICONDUCTORS							
IC001	263 0891 001	IC LA1265(S)		R025,026	247 0009 985	Chip Carbon 10kohm 1/10W	RM73B--103J
IC002	263 0439 007	IC LA3401		R027	247 0008 960	Chip Carbon 3.3kohm 1/10W	RM73B--332J
IC003	263 0791 907	IC LM7001M		R028	247 0009 972	Chip Carbon 9.1kohm 1/10W	RM73B--912J
IC004	216 0065 006	Front End		R029	247 0011 986	Chip Carbon 68kohm 1/10W	RM73B--683J
IC101	263 0896 909	NJM2068MD		R030	247 0011 928	Chip Carbon 39kohm 1/10W	RM73B--393J
IC102	262 1228 007	IC LC7822		R031	247 0011 973	Chip Carbon 62kohm 1/10W	RM73B--623J
IC103	263 0672 903	IC BA4558F		R032	247 0012 969	Chip Carbon 150kohm 1/10W	RM73B--154J
IC201	263 0906 006	IC NJM2177AF		R033,034	247 0012 998	Chip Carbon 200kohm 1/10W	RM73B--204J
IC202	262 1874 008	IC NJU9701G		R035	247 0012 969	Chip Carbon 150kohm 1/10W	RM73B--154J
IC203	262 1875 900	IC BU4066BCF		R036	247 0008 960	Chip Carbon 3.3kohm 1/10W	RM73B--332J
IC205	262 1875 900	IC BU4066BCF		R037,038	247 0012 927	Chip Carbon 100kohm 1/10W	RM73B--104J
IC261	263 0672 903	IC BA4558F		R039--042	247 0008 960	Chip Carbon 3.3kohm 1/10W	RM73B--332J
IC262	262 0625 009	IC TC9176P		R043	247 0010 961	Chip Carbon 22kohm 1/10W	RM73B--223J
IC263	263 0672 903	IC BA4558F		R044,045	247 0009 985	Chip Carbon 10kohm 1/10W	RM73B--103J
IC264	263 0905 900	IC BA6208F		R046	247 0009 927	Chip Carbon 5.6kohm 1/10W	RM73B--562J
TR001	275 0074 902	FFT 2SK211-Y/GR		R047	247 0009 985	Chip Carbon 10kohm 1/10W	RM73B--103J
TR002	273 0411 909	Transistor 2SC2996-Y		R051,052	247 0012 927	Chip Carbon 100kohm 1/10W	RM73B--104J
TR003,004	269 0114 906	Transistor RN2402	Built in Resistor	R071	247 1018 904	Chip Carbon 0ohm 1/8W	RM73B2B0R0K
TR005	273 0403 904	Transistor 2SC2712-Y/GR		R079	247 1018 904	Chip Carbon 0ohm 1/8W	RM73B2B0R0K
TR006	275 0075 901	FET 2SK209-Y/GR		R081	247 1018 904	Chip Carbon 0ohm 1/8W	RM73B2B0R0K
TR007,008	269 0066 902	Transistor DTC323TK	Built in Resistor	R083	247 1018 904	Chip Carbon 0ohm 1/8W	RM73B2B0R0K
TR009	269 0085 909	Transistor DTC144TK	Built in Resistor	R084	247 0018 905	Chip Carbon 0ohm 1/10W	RM73B--0R0K
TR010	269 0086 908	Transistor DTA114TK	Built in Resistor	R085--094	247 1018 904	Chip Carbon 0ohm 1/8W	RM73B2B0R0K
TR201	269 0055 900	Transistor DTA144EK	Built in Resistor	R096--098	247 1018 904	Chip Carbon 0ohm 1/8W	RM73B2B0R0K
TR202,203	269 0054 901	Transistor DTC144EK	Built in Resistor	R101,102	247 0006 946	Chip Carbon 390ohm 1/10W	RM73B--391J
TR205	269 0054 901	Transistor DTC144EK	Built in Resistor	R103,104	247 0011 986	Chip Carbon 68kohm 1/10W	RM73B--683J
TR206	273 0394 900	Transistor 2SC2412K(S)	Built in Resistor	R105,106	247 0012 969	Chip Carbon 150kohm 1/10W	RM73B--154J
TR207--209	269 0054 901	Transistor DTC144EK	Built in Resistor	R107,108	247 0004 922	Chip Carbon 47ohm 1/10W	RM73B--470J
TR210	274 0169 908	Transistor 2SD1292(P)	Built in Resistor	R109,110	247 0007 945	Chip Carbon 1kohm 1/10W	RM73B--102J
D001--003	276 0616 907	Diode 1SS252		R111,112	247 0014 909	Chip Carbon 560kohm 1/10W	RM73B--564J
D006	276 0616 907	Diode 1SS252		R113,114	247 0011 944	Chip Carbon 47kohm 1/10W	RM73B--473J
D202--205	276 0616 907	Diode 1SS252		R115,116	247 0003 949	Chip Carbon 22ohm 1/10W	RM73B--220J
D261	276 0616 907	Diode 1SS252		R117,118	247 0005 905	Chip Carbon 100ohm 1/10W	RM73B--101J
ZD201	276 0462 902	Zener Diode HZS6B-1	6V	R119,120	247 0013 984	Chip Carbon 470kohm 1/10W	RM73B--474J
RESISTORS GROUP (Not included Carbon Film $\pm 5\%$ 1/4 W Type. Refer to the Schematic Diagram for those Parts.)							
R001	247 0007 945	Chip Carbon 1kohm 1/10W	RM73B--102J	R121--132	247 0015 966	Chip Carbon 2.7Mohm 1/10W	RM73B--275J
R002	247 0009 927	Chip Carbon 5.6kohm 1/10W	RM73B--562J	R133--144	247 0006 962	Chip Carbon 470ohm 1/10W	RM73B--471J
R003	247 0004 906	Chip Carbon 39ohm 1/10W	RM73B--390J	R145	247 0014 925	Chip Carbon 680kohm 1/10W	RM73B--684J
R004	247 0009 985	Chip Carbon 10kohm 1/10W	RM73B--103J	R151,152	247 0006 962	Chip Carbon 470ohm 1/10W	RM73B--471J
R005	247 0006 946	Chip Carbon 390ohm 1/10W	RM73B--391J	R153,154	247 0011 973	Chip Carbon 62kohm 1/10W	RM73B--623J
R006	247 0006 920	Chip Carbon 330ohm 1/10W	RM73B--331J	R155,156	247 0013 984	Chip Carbon 470kohm 1/10W	RM73B--474J
R007	247 0009 901	Chip Carbon 4.7kohm 1/10W	RM73B--472J	R157--160	247 0005 905	Chip Carbon 100ohm 1/10W	RM73B--101J
R008	247 0006 920	Chip Carbon 330ohm 1/10W	RM73B--331J	R201	247 0009 956	Chip Carbon 7.5kohm 1/10W	RM73B--752J
R009	247 0005 989	Chip Carbon 220ohm 1/10W	RM73B--221J	R202	247 0011 944	Chip Carbon 47kohm 1/10W	RM73B--473J
R010	247 0008 902	Chip Carbon 1.8kohm 1/10W	RM73B--182J	R203	247 0010 929	Chip Carbon 15kohm 1/10W	RM73B--153J
R011	247 0006 920	Chip Carbon 330ohm 1/10W	RM73B--331J	R204	247 0009 956	Chip Carbon 7.5kohm 1/10W	RM73B--752J
R014	247 0005 905	Chip Carbon 100ohm 1/10W	RM73B--101J	R205	247 0011 944	Chip Carbon 47kohm 1/10W	RM73B--473J
R015	247 0009 969	Chip Carbon 8.2kohm 1/10W	RM73B--822J	R206	247 0010 929	Chip Carbon 15kohm 1/10W	RM73B--153J
R016	247 0008 986	Chip Carbon 3.9kohm 1/10W	RM73B--392J	R207	247 0016 923	Chip Carbon 4.7Mohm 1/10W	RM73B--475J
R017	247 0006 946	Chip Carbon 390ohm 1/10W	RM73B--391J	R208,209	247 0011 960	Chip Carbon 56kohm 1/10W	RM73B--563J
R018	247 0005 947	Chip Carbon 150ohm 1/10W	RM73B--151J	R210	247 0012 927	Chip Carbon 100kohm 1/10W	RM73B--104J
R019	247 0005 921	Chip Carbon 120ohm 1/10W	RM73B--121J	R211	247 0019 988	Chip Carbon 100kohm 1/10W	RM73B--104F($\pm 1\%$)
R020	247 0010 929	Chip Carbon 15kohm 1/10W	RM73B--153J	R212	247 0010 929	Chip Carbon 15kohm 1/10W	RM73B--153J
R021	247 0005 921	Chip Carbon 120ohm 1/10W	RM73B--121J	R213	247 0009 969	Chip Carbon 8.2kohm 1/10W	RM73B--822J
R022	247 0011 928	Chip Carbon 39kohm 1/10W	RM73B--393J	R214	247 0010 929	Chip Carbon 15kohm 1/10W	RM73B--153J
R023	247 0007 961	Chip Carbon 1.2kohm 1/10W	RM73B--122J	R215	247 0013 942	Chip Carbon 330kohm 1/10W	RM73B--334J
R024	247 0009 943	Chip Carbon 6.8kohm 1/10W	RM73B--682J	R218--220	247 0011 944	Chip Carbon 47kohm 1/10W	RM73B--473J
				R221--223	247 0009 969	Chip Carbon 8.2kohm 1/10W	RM73B--822J
				R224	247 0014 967	Chip Carbon 1Mohm 1/10W	RM73B--105J
				R225	247 0010 929	Chip Carbon 15kohm 1/10W	RM73B--153J
				R226	247 0010 945	Chip Carbon 18kohm 1/10W	RM73B--183J
				R227	247 0010 929	Chip Carbon 15kohm 1/10W	RM73B--153J
				R228,229	247 0003 936	Chip Carbon 20ohm 1/10W	RM73B--200J
				R230	247 0009 956	Chip Carbon 7.5kohm 1/10W	RM73B--752J
				R231	247 0009 927	Chip Carbon 5.6kohm 1/10W	RM73B--562J
				R232	247 0010 945	Chip Carbon 18kohm 1/10W	RM73B--183J

Ref. No.	Part No.	Part Name	Remarks	
C269,270	257 0012 982	Chip Ceramic 0.022 μ F/50V	CK73F1H223Z	
C271,272	254 4254 909	Electrolytic 10 μ F/16V	CE04W1C100M	
C273	257 0005 944	Chip Ceramic 220pF/50V	CC73SL1H221J	
C274,275	254 4254 909	Electrolytic 10 μ F/16V	CE04W1C100M	
C276	254 3056 917	Electrolytic 1 μ F/50V (Bipole)	CE04D1H010MBP	
C277	257 0012 986	Chip Ceramic 0.01 μ F/50V	CK73F1H103Z	
C278	254 4260 948	Electrolytic 1 μ F/50V	CE04W1H010M	
C279	257 0012 986	Chip Ceramic 0.01 μ F/50V	CK73F1H103Z	
C281,282	255 1264 908	Plastic Film 0.001 μ F/50V	CQ93M1H102J	
OTHER GROUP				Q'ty
	—	(P.W.Board)		1
CF001,002	261 0064 007	Ceramic Filter SFT10.7MS2		2
CF003	261 0031 001	Ceramic Filter BFU450C4		1
CF004	261 0079 005	Ceramic Filter CSB456F11		1
CF005	261 0116 007	Ceramic Filter SFU450B3		1
L201	235 0060 989	Inductor 120 μ H		1
XT001	399 0075 003	Crystal 7.2 MHz		1
XT201	399 0223 907	Ceramic Resonator	CSA2.00MG-TF01	1
BL001	231 2096 001	MW Ant. Osc.Coil		1
T003	231 1138 009	AM IFT		1
T004	231 2085 009	FM Det. Trans		1
LF001	232 0159 008	Anti Birdie Filter		1
LF002,003	232 0085 004	Low Pass Filter		1
LF:01,102	235 9003 002	FTZ Choke Coil		2
	204 8313 003	4P Pin Jack(S-GND)		2
	204 8346 009	6P Pin Jack(S-GND)		1
	205 0776 007	3P Ant. Terminal(PAL)		1
TP	205 0190 036	3P NH Conn. Base		1
CN6A	205 0748 064	JL Connector(R)		1
CN6B	205 0748 064	JL Connector(R)		1
CN6C	205 0748 064	JL Connector(R)		1
CN6D	205 0483 060	6P MQ-ST Conn. Base		1
CN8A	205 0483 086	8P MQ-ST Conn. Base		1
CN9A	205 0483 099	9P MQ-ST Conn. Base		2
CN10A	205 0483 002	10P MQ-ST Conn. Base		1
CN12B	205 0483 025	12P MQ-ST Conn. Base		1

Ref. No.	Part No.	Part Name	Remarks
R233-235	247 0011 944	Chip Carbon 47kohm 1/10W	RM73B-473J
R235	241 2387 948	Carbon Film 4.7kohm 1/4 W(NE)	RD14D2E4A7J NBS
R237	247 0007 945	Chip Carbon 1kohm 1/10W	RM73B-102J
R239,240	247 0005 905	Chip Carbon 100ohm 1/10W	RM73B-101J
R241,242	247 0006 962	Chip Carbon 470ohm 1/10W	RM73B-471J
R251,252	247 0009 928	Chip Carbon 2.2kohm 1/10W	RM73B-222J
R253,254	247 0009 901	Chip Carbon 4.7kohm 1/10W	RM73B-472J
R261,262	247 0012 927	Chip Carbon 100kohm 1/10W	RM73B-104J
R263,264	247 0013 900	Chip Carbon 220kohm 1/10W	RM73B-224J
R265,266	247 0007 945	Chip Carbon 1kohm 1/10W	RM73B-102J
R267,268	247 0008 960	Chip Carbon 3.3kohm 1/10W	RM73B-332J
R269,270	247 0005 905	Chip Carbon 100ohm 1/10W	RM73B-101J
R271	247 0013 984	Chip Carbon 470kohm 1/10W	RM73B-474J
R272	247 0005 905	Chip Carbon 100ohm 1/10W	RM73B-101J
R273	247 0007 945	Chip Carbon 1kohm 1/10W	RM73B-102J
R274	247 0009 927	Chip Carbon 5.6kohm 1/10W	RM73B-562J
R275,276	247 0005 905	Chip Carbon 100ohm 1/10W	RM73B-101J
R277,278	247 0009 985	Chip Carbon 10kohm 1/10W	RM73B-103J
R279	247 0013 984	Chip Carbon 470kohm 1/10W	RM73B-474J
R280	247 0007 945	Chip Carbon 1kohm 1/10W	RM73B-102J
R281	247 0009 927	Chip Carbon 5.6kohm 1/10W	RM73B-562J
R282	247 0005 905	Chip Carbon 100ohm 1/10W	RM73B-101J
VR261	211 0802 002	Variable Resistor 100kohm	

CAPACITORS GROUP

C001,002	257 0012 966	Chip Ceramic 0.01μF/50V	CK73F1H103Z
C004	257 0002 947	Chip Ceramic 12pF/50V	CC73SL1H120J
C005	254 4254 909	Electrolytic 10μF/16V	CE04W1C100M
C006-008	257 0012 966	Chip Ceramic 0.01μF/50V	CK73F1H103Z
C011	254 3056 917	Electrolytic 1μF/50V (Bipole)	CE04D1H010MBP
C012	254 4254 938	Electrolytic 47μF/16V	CE04W1C470M
C013	254 4260 906	Electrolytic 0.1μF/50V	CE04W1H0R1M
C014	257 0012 982	Chip Ceramic 0.022μF/50V	CK73F1H223Z
C016	257 0004 961	Chip Ceramic 100pF/50V	CC73SL1H101J
C017,018	257 0012 966	Chip Ceramic 0.01μF/50V	CK73F1H103Z
C019	254 4260 935	Electrolytic 0.47μF/50V	CE04W1HR47M
C020	254 4260 948	Electrolytic 1μF/50V	CE04W1H010M
C021	254 4260 980	Electrolytic 10μF/50V	CE04W1H100M
C022	257 0012 982	Chip Ceramic 0.022μF/50V	CK73F1H223Z
C024	256 1034 940	Metalized 0.056μF/50V	CF93A1H562J
C025,026	254 4254 912	Electrolytic 22μF/16V	CE04W1C220M
C027	254 4254 909	Electrolytic 10μF/16V	CE04W1C100M
C028	254 4260 948	Electrolytic 1μF/50V	CE04W1H010M
C029	257 0012 966	Chip Ceramic 0.01μF/50V	CK73F1H103Z
C033,034	257 0002 976	Chip Ceramic 16pF/50V	CC73SL1H160J
C035	256 1034 937	Metalized 0.047μF/50V	CF93A1H473J
C036,037	257 0012 966	Chip Ceramic 0.01μF/50V	CK73F1H103Z
C038	254 4254 938	Electrolytic 47μF/16V	CE04W1C470M
C039	257 0012 966	Chip Ceramic 0.01μF/50V	CK73F1H103Z
C040	254 4260 948	Electrolytic 1μF/50V	CE04W1H010M
C041	254 4254 938	Electrolytic 47μF/16V	CE04W1C470M
C042	254 4260 948	Electrolytic 1μF/50V	CE04W1H010M
C043	254 4260 919	Electrolytic 0.22μF/50V	CE04W1HR22M
C044	254 4260 948	Electrolytic 1μF/50V	CE04W1H010M
C045	257 0012 966	Chip Ceramic 0.01μF/50V	CK73F1H103Z
C046,047	254 4260 951	Electrolytic 2.2μF/50V	CE04W1H2R2M
C048	254 4260 948	Electrolytic 1μF/50V	CE04W1H010M
C049	257 0012 966	Chip Ceramic 0.01μF/50V	CK73F1H103Z
C051	254 4260 951	Electrolytic 2.2μF/50V	CE04W1H2R2M
C052	254 4254 909	Electrolytic 10μF/16V	CE04W1C100M
C053,054	257 0005 986	Chip Ceramic 330pF/50V	CC73SL1H331J
C056,057	257 0012 966	Chip Ceramic 0.01μF/50V	CK73F1H103Z

Ref. No.	Part No.	Part Name	Remarks
C059-061	257 0012 966	Chip Ceramic 0.01μF/50V	CK73F1H103Z
C063	254 4254 909	Electrolytic 10μF/16V	CE04W1C100M
C065	257 0012 966	Chip Ceramic 0.01μF/50V	CK73F1H103Z
C101,102	257 0005 944	Chip Ceramic 220pF/50V	CC73SL1H221J
C103,104	254 4254 909	Electrolytic 10μF/16V	CE04W1C100M
C105,106	257 0004 961	Chip Ceramic 100pF/50V	CC73SL1H101J
C107,108	254 4254 925	Electrolytic 33μF/16V	CE04W1C330M
C109,110	255 1264 995	Plastic Film 0.0056μF/50V	CQ93M1H562J(B)
C111,112	257 0009 908	Chip Ceramic 1500pF/50V	CK73B1H152K
C113,114	257 0012 982	Chip Ceramic 0.022μF/50V	CK73F1H223Z
C115,116	254 4260 951	Electrolytic 2.2μF/50V	CE04W1H2R2M
C121-128	257 0004 903	Chip Ceramic 56pF/50V	CC73SL1H560J
C133	254 4260 948	Electrolytic 1μF/50V	CE04W1H010M
C136-138	257 0012 982	Chip Ceramic 0.022μF/50V	CK73F1H223Z
C139	257 0009 924	Chip Ceramic 2200pF/50V	CK73B1H222K
C147,148	257 0004 961	Chip Ceramic 100pF/50V	CC73SL1H101J
C151,152	254 4254 909	Electrolytic 10μF/16V	CE04W1C100M
C153,154	257 0004 961	Chip Ceramic 100pF/50V	CC73SL1H101J
C155,156	254 4260 948	Electrolytic 1μF/50V	CE04W1H010M
C201,202	256 1034 979	Metalized 0.1μF/50V	CF93A1H104J
C203	257 0006 969	Chip Ceramic 680pF/50V	CC73SL1H681J
C204	256 1034 937	Metalized 0.47μF/50V	CF93A1H474J
C205,206	256 1034 979	Metalized 0.1μF/50V	CF93A1H104J
C207	257 0006 969	Chip Ceramic 680pF/50V	CC73SL1H681J
C208	256 1034 937	Metalized 0.47μF/50V	CF93A1H474J
C209	254 4254 912	Electrolytic 22μF/16V	CE04W1C220M
C210,211	254 4254 909	Electrolytic 10μF/16V	CE04W1C100M
C212	254 4252 930	Electrolytic 100μF/10V	CE04W1A101M
C213	255 1264 982	Plastic Film 0.0047μF/50V	CQ93M1H472J(B)
C214	254 4254 912	Electrolytic 22μF/16V	CE04W1C220M
C215	254 4254 909	Electrolytic 10μF/16V	CE04W1C100M
C216	256 1035 910	Metalized 0.22μF/50V	CF93A1H224J
C217,218	254 4254 909	Electrolytic 10μF/16V	CE04W1C100M
C219	254 4254 941	Electrolytic 100μF/16V	CE04W1C101M
C220	255 1264 995	Plastic Film 0.0056μF/50V	CQ93M1H562J(B)
C221	254 4250 958	Electrolytic 470μF/6.3V	CE04W0471M
C222	256 1034 937	Metalized 0.47μF/50V	CF93A1H474J
C223	257 0006 927	Chip Ceramic 470pF/50V	CK73SL1H471J
C224	257 0009 924	Chip Ceramic 2200pF/50V	CK73B1H222K
C225	254 4260 948	Electrolytic 1μF/50V	CE04W1H010M
C226	256 1035 978	Metalized 0.68μF/50V	CF93A1H684J
C227-229	256 1035 910	Metalized 0.22μF/50V	CF93A1H224J
C230,231	254 4260 977	Electrolytic 4.7μF/50V	CE04W1H4R7M
C232	256 1035 910	Metalized 0.22μF/50V	CF93A1H224J
C233-236	256 1034 979	Metalized 0.1μF/50V	CF93A1H104J
C237,238	255 1265 978	Plastic Film 0.022μF/50V	CQ93M1H223J(B)
C239-241	254 4260 948	Electrolytic 1μF/50V	CE04W1H010M
C242	257 0014 935	Chip Ceramic 0.1μF/25V	CK73F1H104Z
C243,244	254 4260 948	Electrolytic 1μF/50V	CE04W1H010M
C245	257 0006 927	Chip Ceramic 470pF/50V	CK73SL1H471J
C246	257 0009 940	Chip Ceramic 3300pF/50V	CK73B1H332K
C247	257 0014 935	Chip Ceramic 0.1μF/25V	CK73F1H104Z
C248,249	257 0013 907	Chip Ceramic 0.047μF/50V	CK73F1H473Z
C250	254 4254 938	Electrolytic 47μF/16V	CE04W1C470M
C251	257 0014 935	Chip Ceramic 0.1μF/25V	CK73F1H104Z
C252	257 0006 927	Chip Ceramic 470pF/50V	CC73SL1H471J
C253,254	257 0009 979	Chip Ceramic 5600pF/50V	CK73SL1H562K
C255	257 0014 935	Chip Ceramic 0.1μF/25V	CK73F1H104Z
C256	254 4254 909	Electrolytic 10μF/16V	CE04W1C100M
C257	254 4252 930	Electrolytic 100μF/10V	CE04W1A101M
C259,260	257 0005 944	Chip Ceramic 220pF/50V	CC73SL1H221J
C261-264	254 4254 909	Electrolytic 10μF/16V	CE04W1C100M
C265	257 0006 927	Chip Ceramic 470pF/50V	CC73SL1H471J
C266	257 0005 986	Chip Ceramic 330pF/50V	CC73SL1H331J
C267,268	254 4254 909	Electrolytic 10μF/16V	CE04W1C100M

BLOCK DIAGRAM

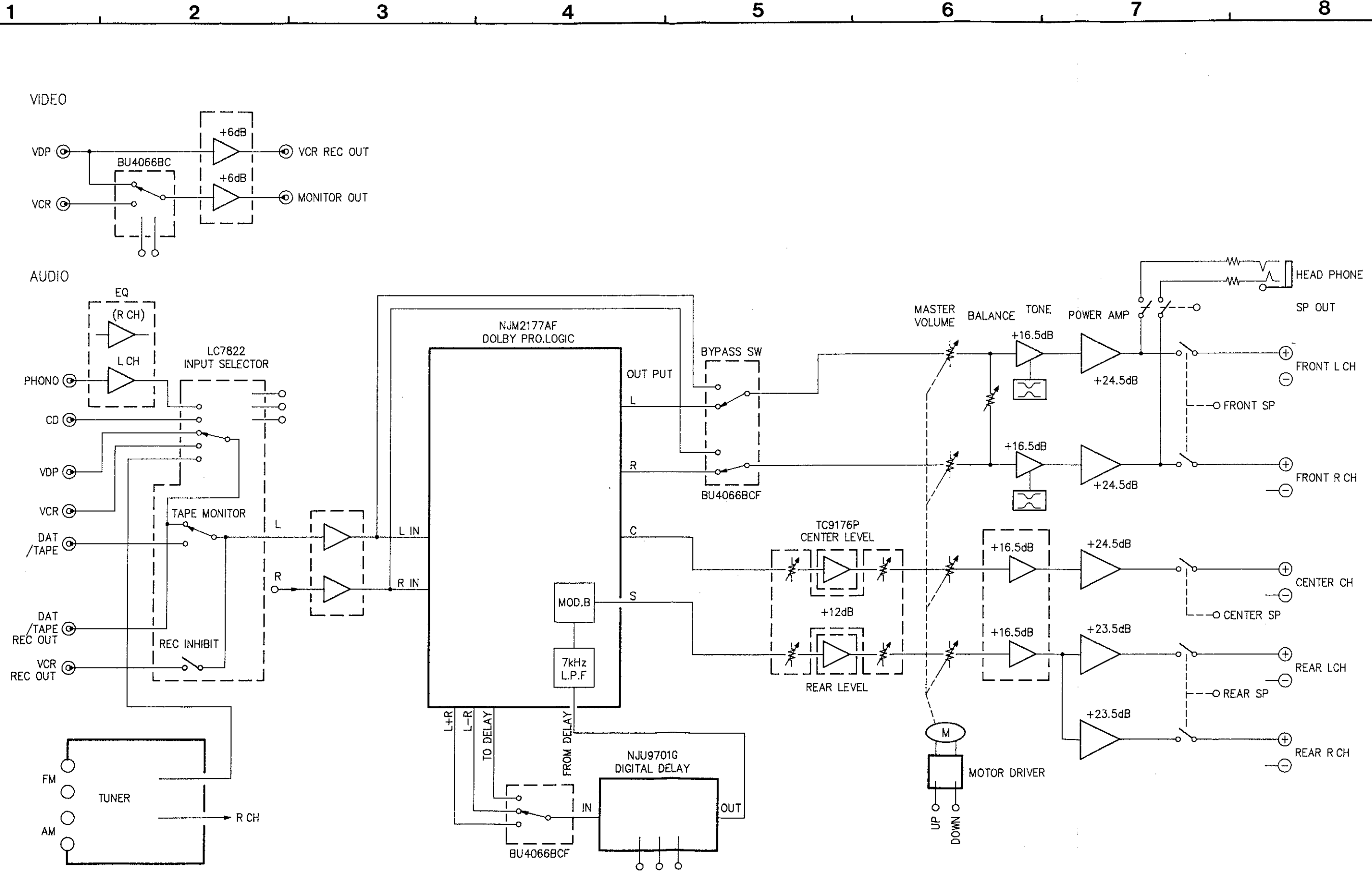

WIRING DIAGRAM

1

2

3

4

5

6

7

8

A

B

C

D

E

	MAIN AMP UNIT	REAR AMP UNIT	SURROUND UNIT
U.S.A. & CANADA	1U-2650	1U-2651	1U-2652
EUROPE	1U-2650B	1U-2651B	1U-2652B

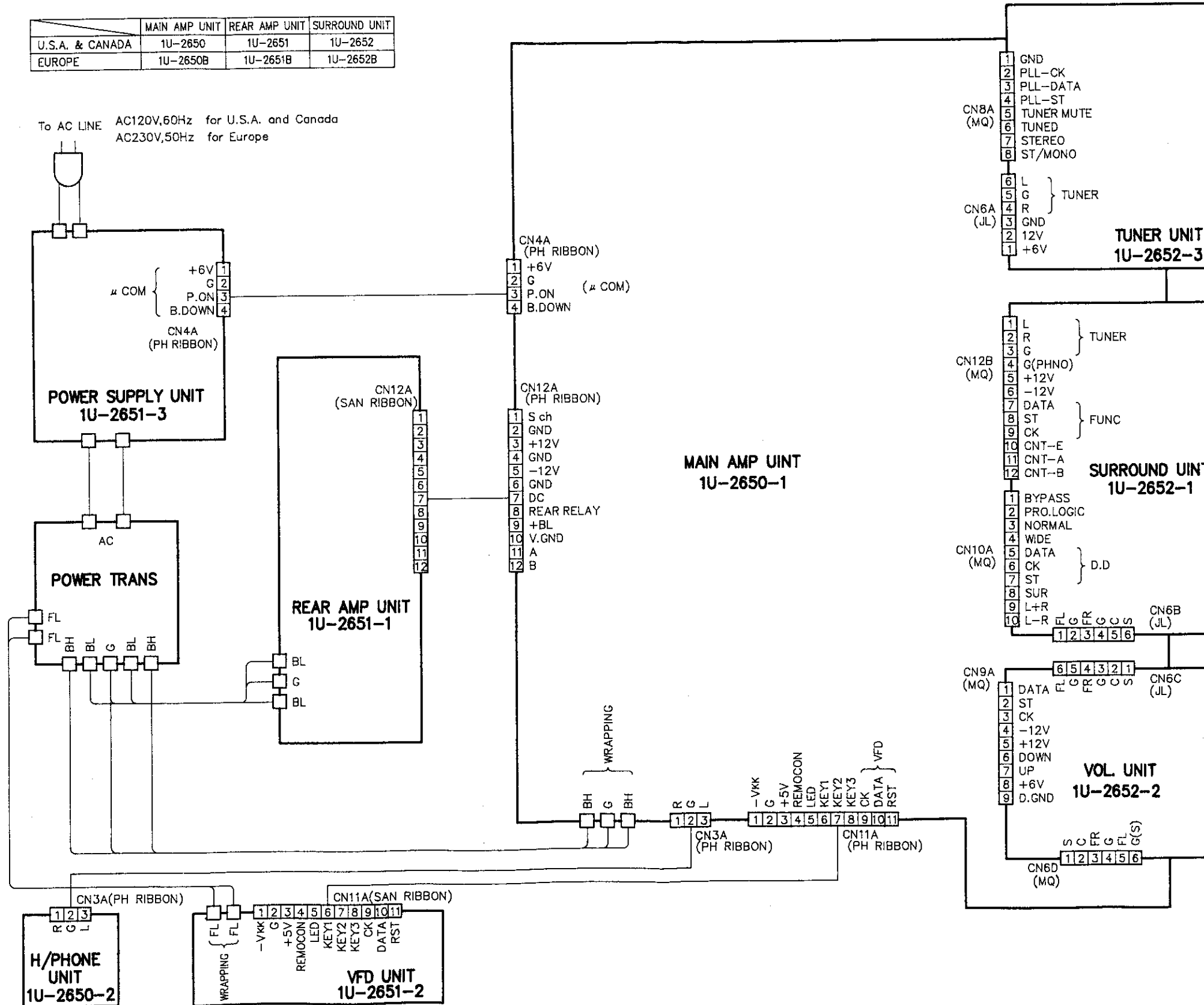

8

9

10

11

12

13

14

15

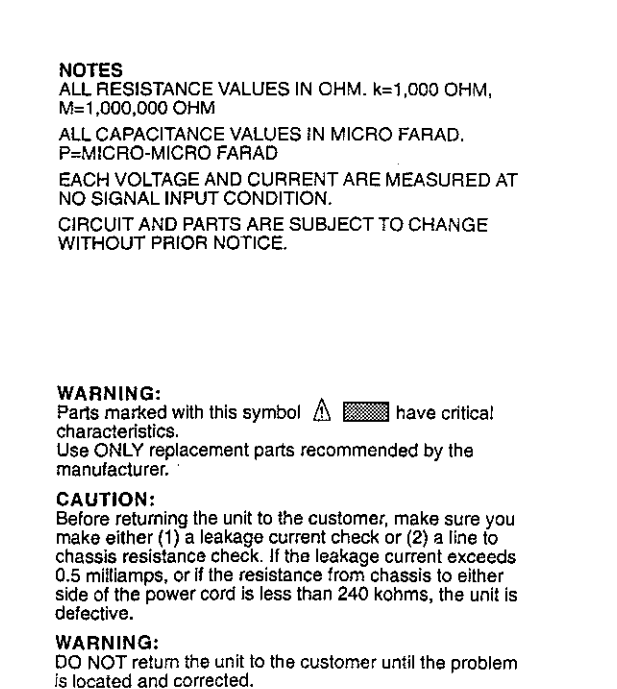
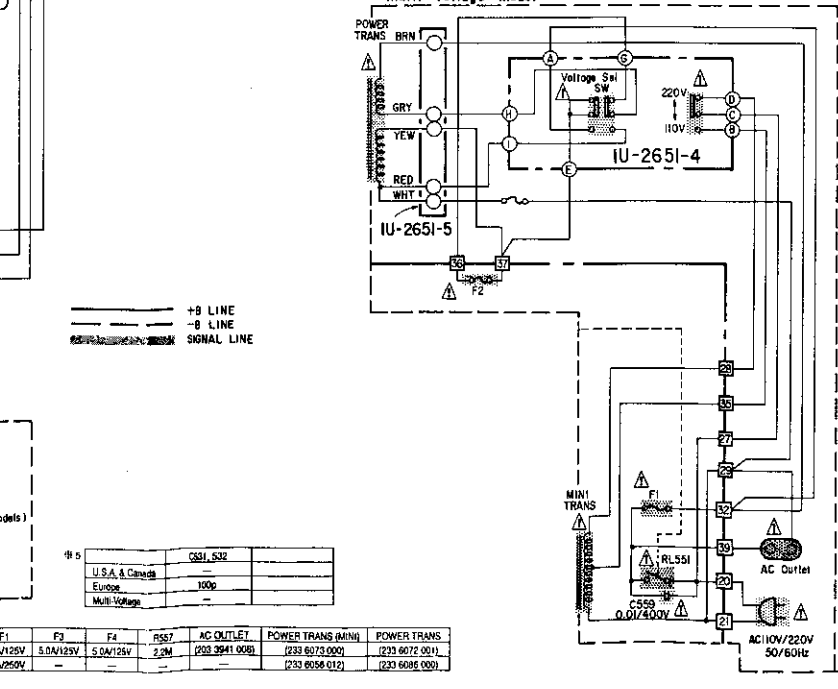
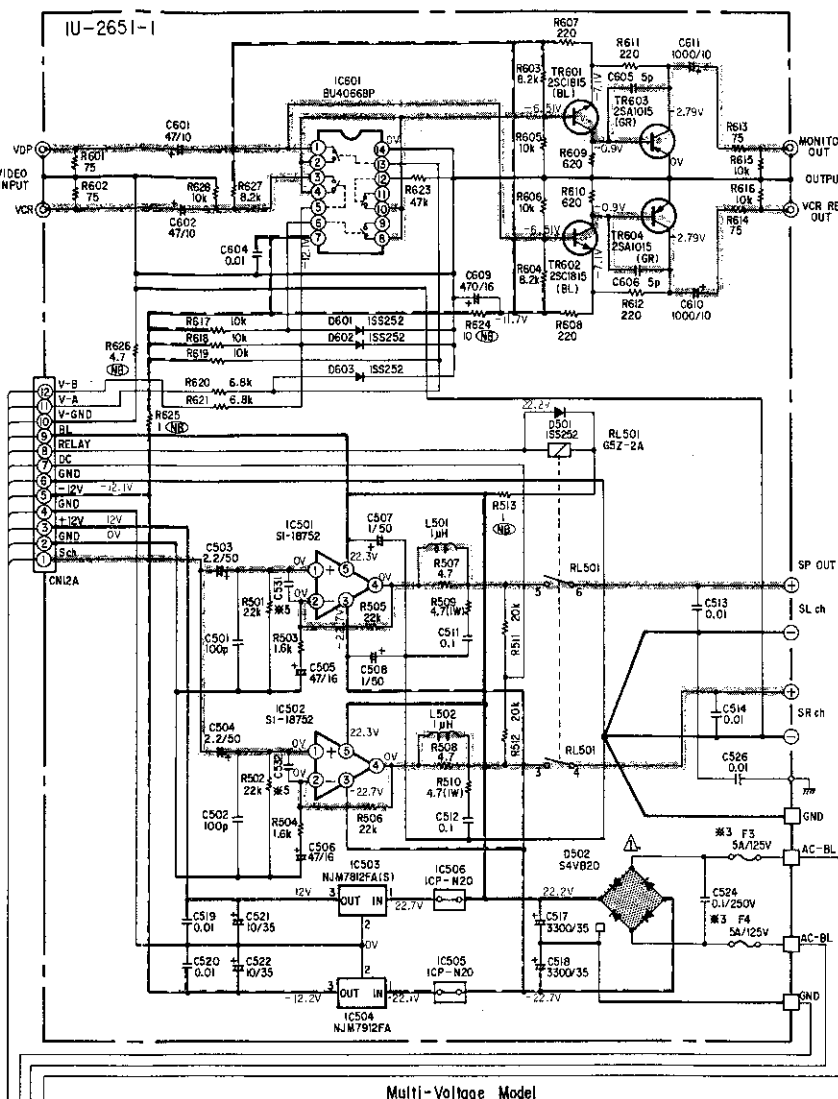
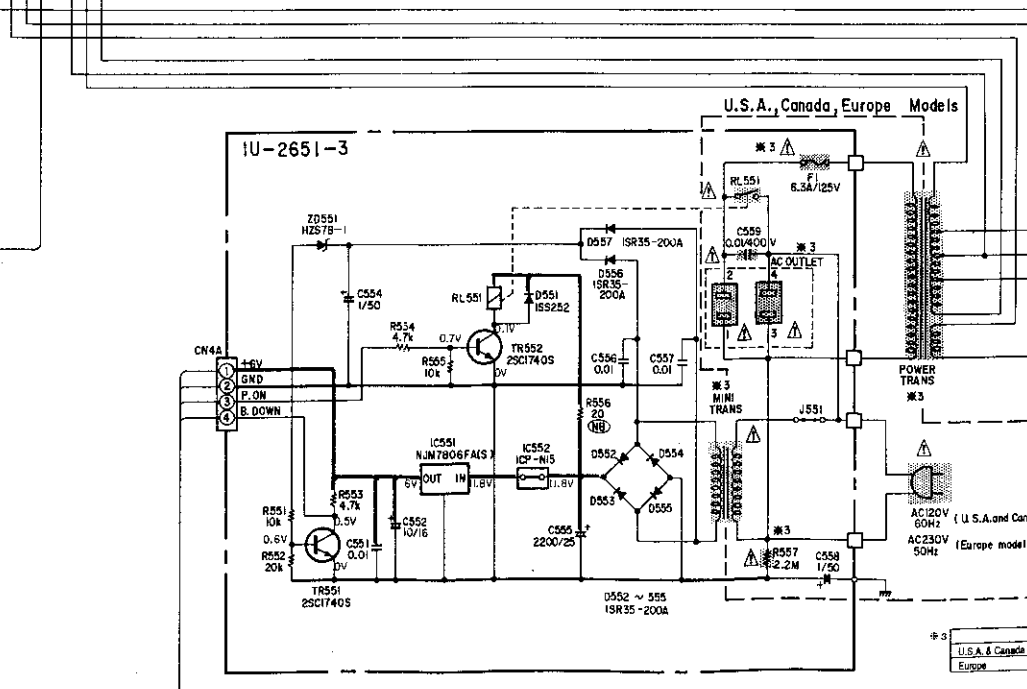
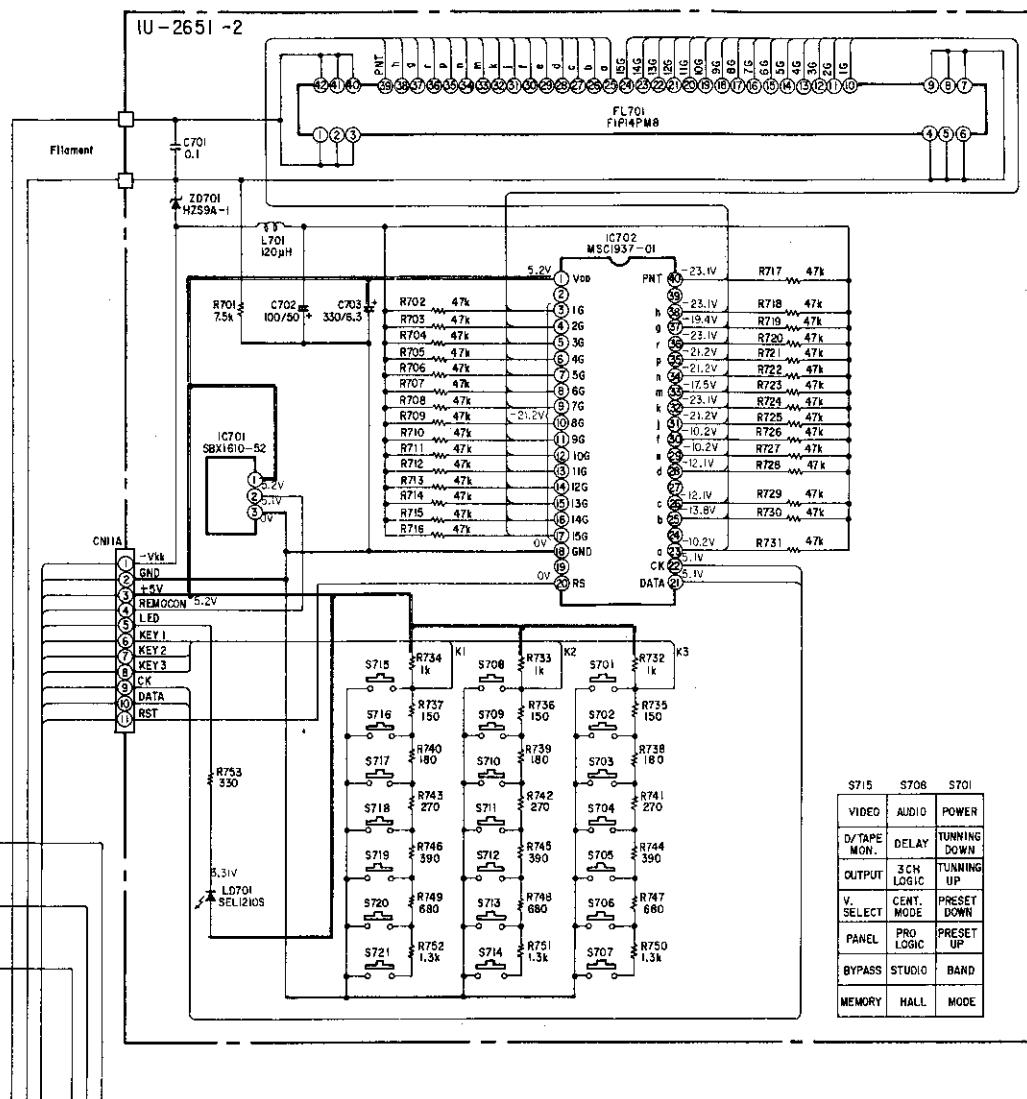
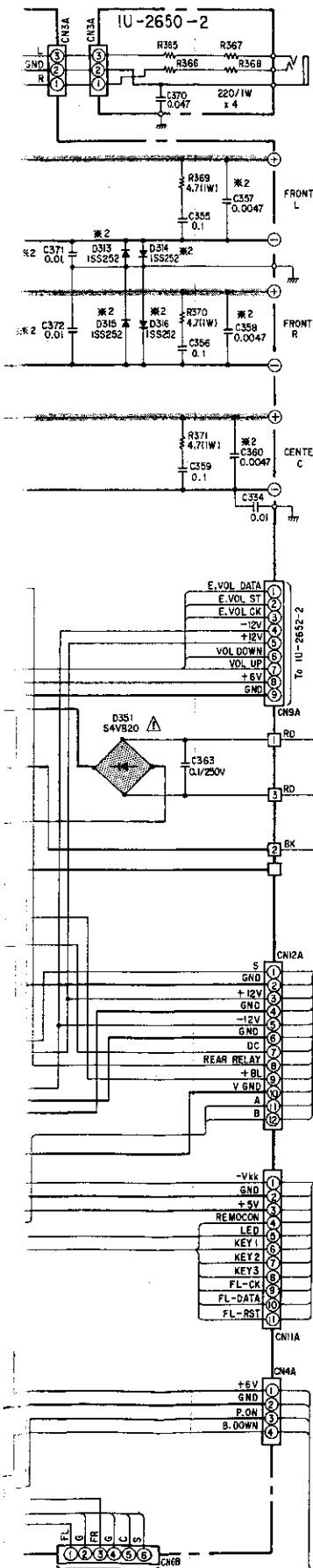

A
B
C
D
E

NOTES
 ALL RESISTANCE VALUES IN OHM. k=1,000 OHM, M=1,000,000 OHM
 ALL CAPACITANCE VALUES IN MICRO FARAD. P=MICRO-MICRO FARAD
 EACH VOLTAGE AND CURRENT ARE MEASURED AT NO SIGNAL INPUT CONDITION.
 CIRCUIT AND PARTS ARE SUBJECT TO CHANGE WITHOUT PRIOR NOTICE.

WARNING:
 Parts marked with this symbol have critical characteristics. Use ONLY replacement parts recommended by the manufacturer.

CAUTION:
 Before returning the unit to the customer, make sure you make either (1) a leakage current check or (2) a line to chassis resistance check. If the leakage current exceeds 0.5 millamps, or if the resistance from chassis to either side of the power cord is less than 240 kohms, the unit is defective.

WARNING:
 DO NOT return the unit to the customer until the problem is located and corrected.

Model	F1	F2	F4	F57	AC OUTLET	POWER TRANS (BRN)	POWER TRANS
U.S.A. & Canada	8.3A/125V	5.0A/125V	5.0A/125V	2.2M	(233 2941 008)	(233 6073 000)	(233 6072 001)
Europe	2.5A/250V	-	-	-	(233 6056 012)	(233 6056 000)	-

SCHEMATIC DIAGRAM-2/3

1 2 3 4 5 6 7 8

1U-2652-1 SURROUND UNIT

1U-265

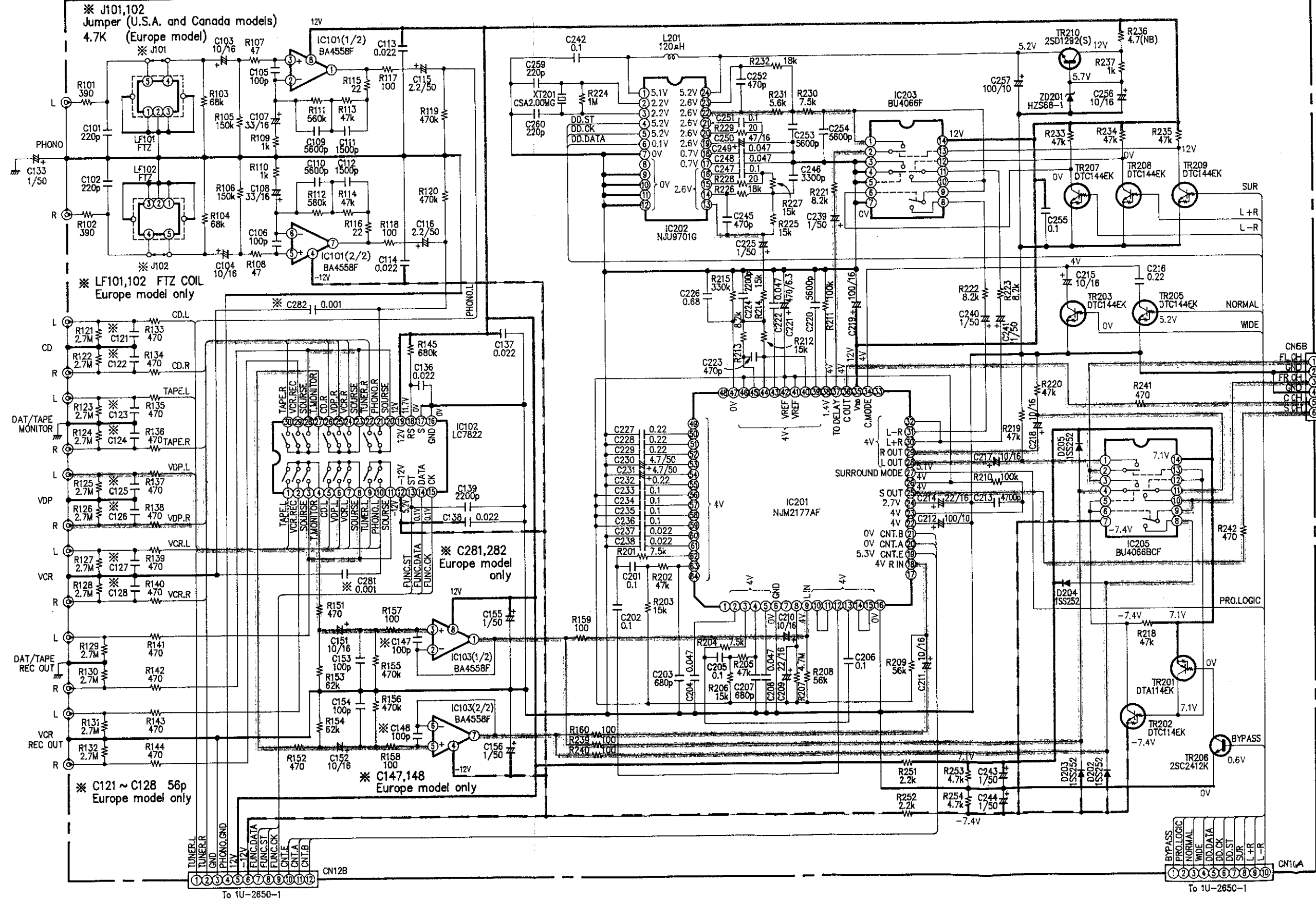

1U-2652-2 VOLUME UNIT

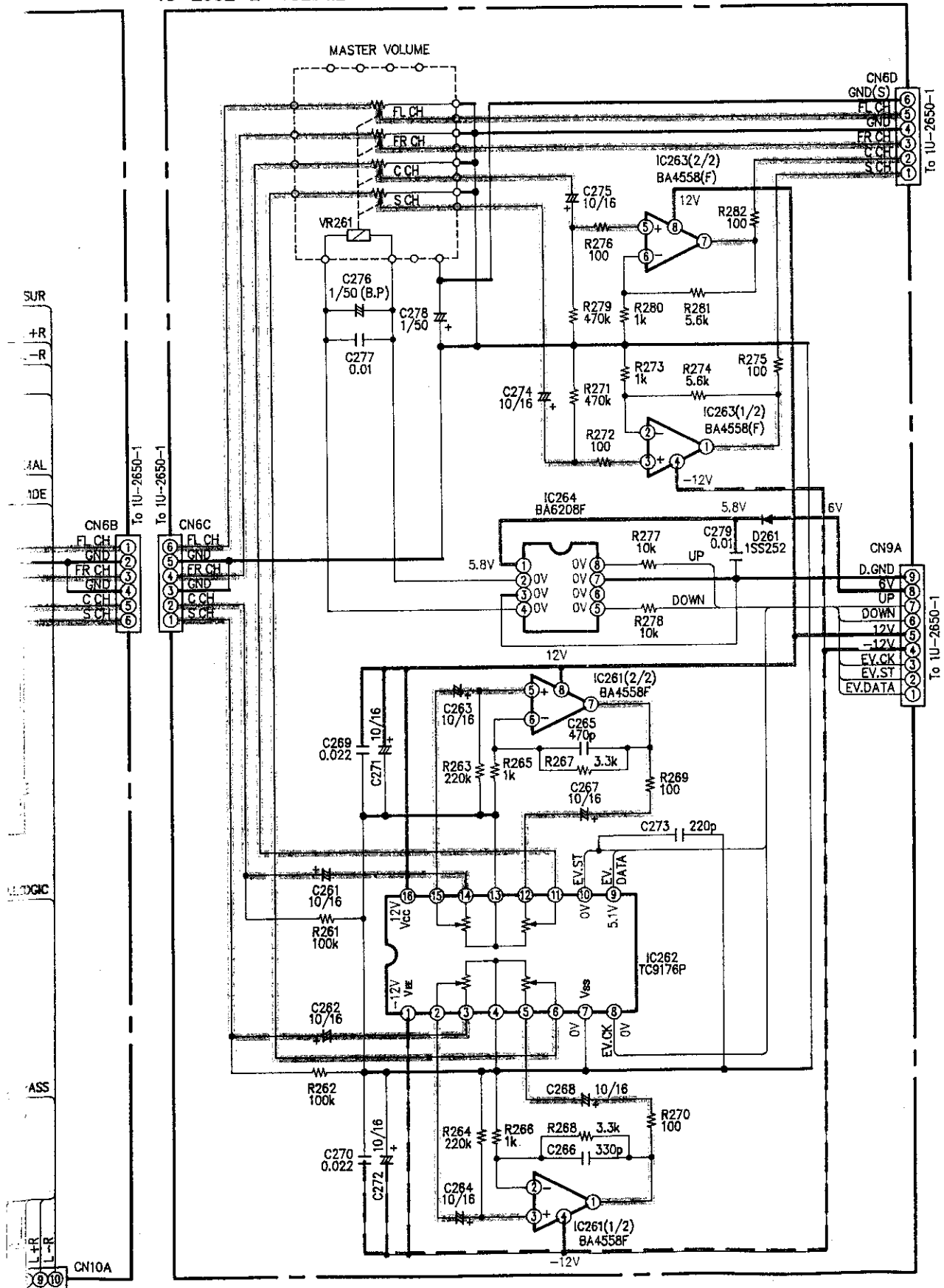

NOTES

ALL RESISTANCE VALUES IN OHM. k=1,000 OHM, M=1,000,000 OHM
 ALL CAPACITANCE VALUES IN MICRO FARAD. P=MICRO-MICRO FARAD
 EACH VOLTAGE AND CURRENT ARE MEASURED AT NO SIGNAL INPUT CONDITION.
 CIRCUIT AND PARTS ARE SUBJECT TO CHANGE WITHOUT PRIOR NOTICE.

WARNING:

Parts marked with this symbol  have critical characteristics. Use ONLY replacement parts recommended by the manufacturer.

CAUTION:

Before returning the unit to the customer, make sure you make either (1) a leakage current check or (2) a line to chassis resistance check. If the leakage current exceeds 0.5 millamps, or if the resistance from chassis to either side of the power cord is less than 240 kohms, the unit is defective.

WARNING:

DO NOT return the unit to the customer until the problem is located and corrected.

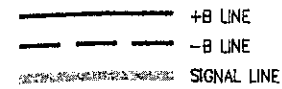

U.S.A and Canada model

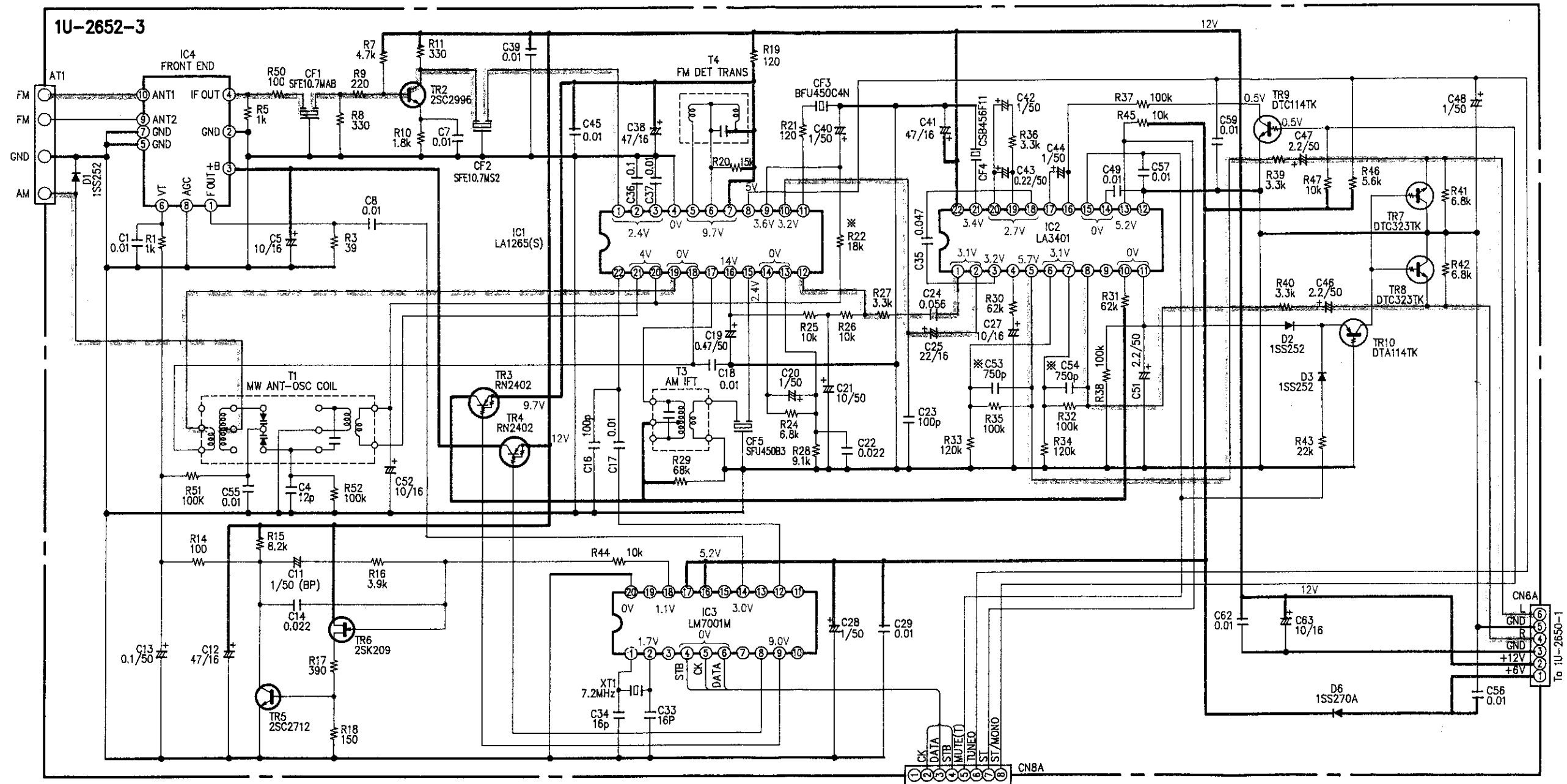

* MULTI-VOLTAGE MODEL
 C53,54 510p
 R22 39k

To 1U-2650-1

— +B LINE
 FM SIGNAL LINE
 AM SIGNAL LINE

WARNING:
 Parts marked with this symbol have critical characteristics. Use ONLY replacement parts recommended by the manufacturer.

CAUTION:
 Before returning the unit to the customer, make sure you make either (1) a leakage current check or (2) a line to chassis resistance check. If the leakage current exceeds 0.5 milliamps, or if the resistance from chassis to either side of the power cord is less than 240 kohms, the unit is defective.

WARNING:
 DO NOT return the unit to the customer until the problem is located and corrected.

9

10

11

12

13

14

15

Europe model

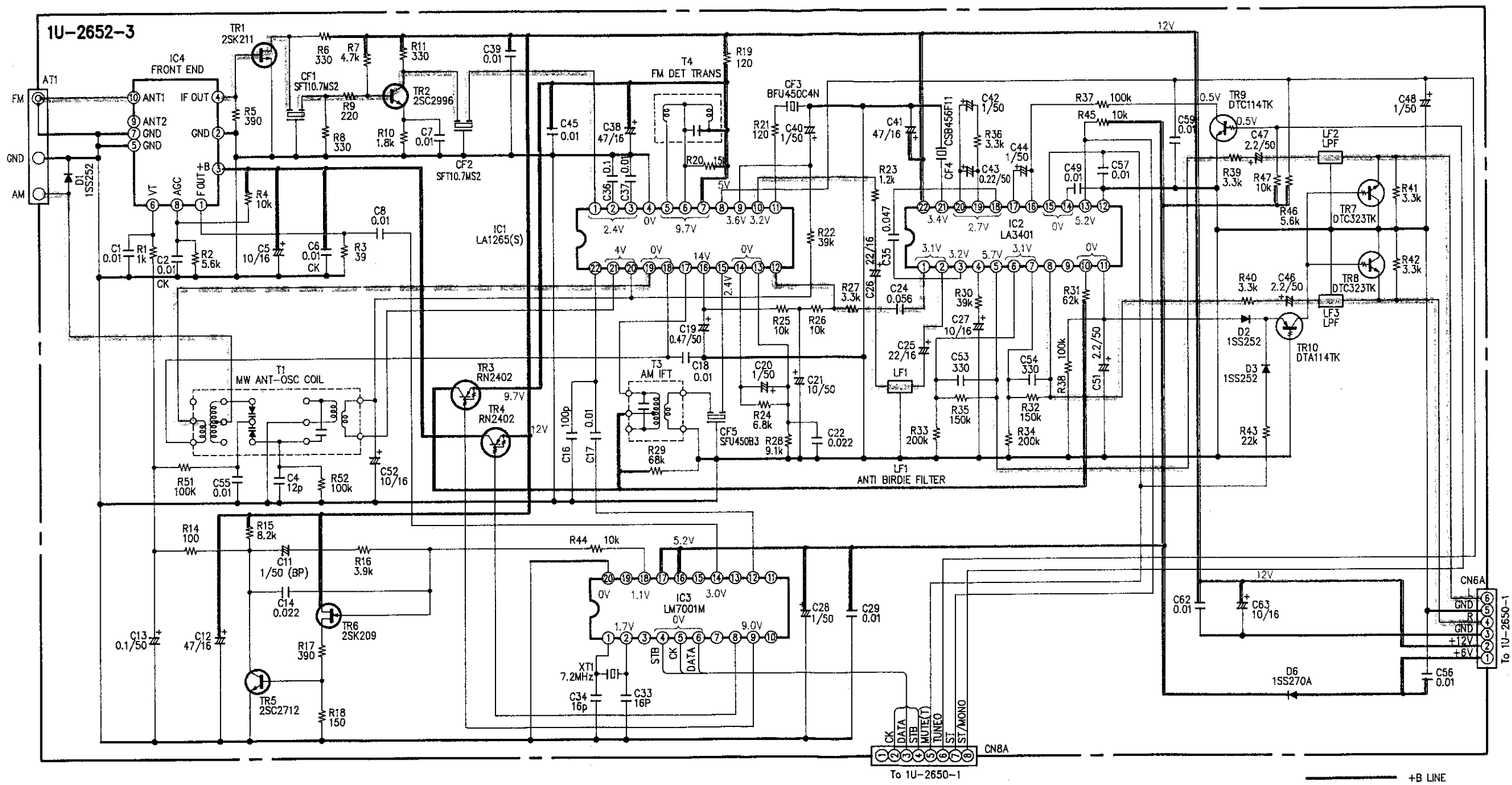

A

B

C

D

E

NOTES
 ALL RESISTANCE VALUES IN OHM. k=1,000 OHM, M=1,000,000 OHM
 ALL CAPACITANCE VALUES IN MICRO FARAD. P=MICRO-MICRO FARAD
 EACH VOLTAGE AND CURRENT ARE MEASURED AT NO SIGNAL INPUT CONDITION.
 CIRCUIT AND PARTS ARE SUBJECT TO CHANGE WITHOUT PRIOR NOTICE.

— +B LINE
 - - - - - FM SIGNAL LINE
 ~ ~ ~ ~ ~ AM SIGNAL LINE

EXPLODED VIEW OF CHASSIS AND CABINET

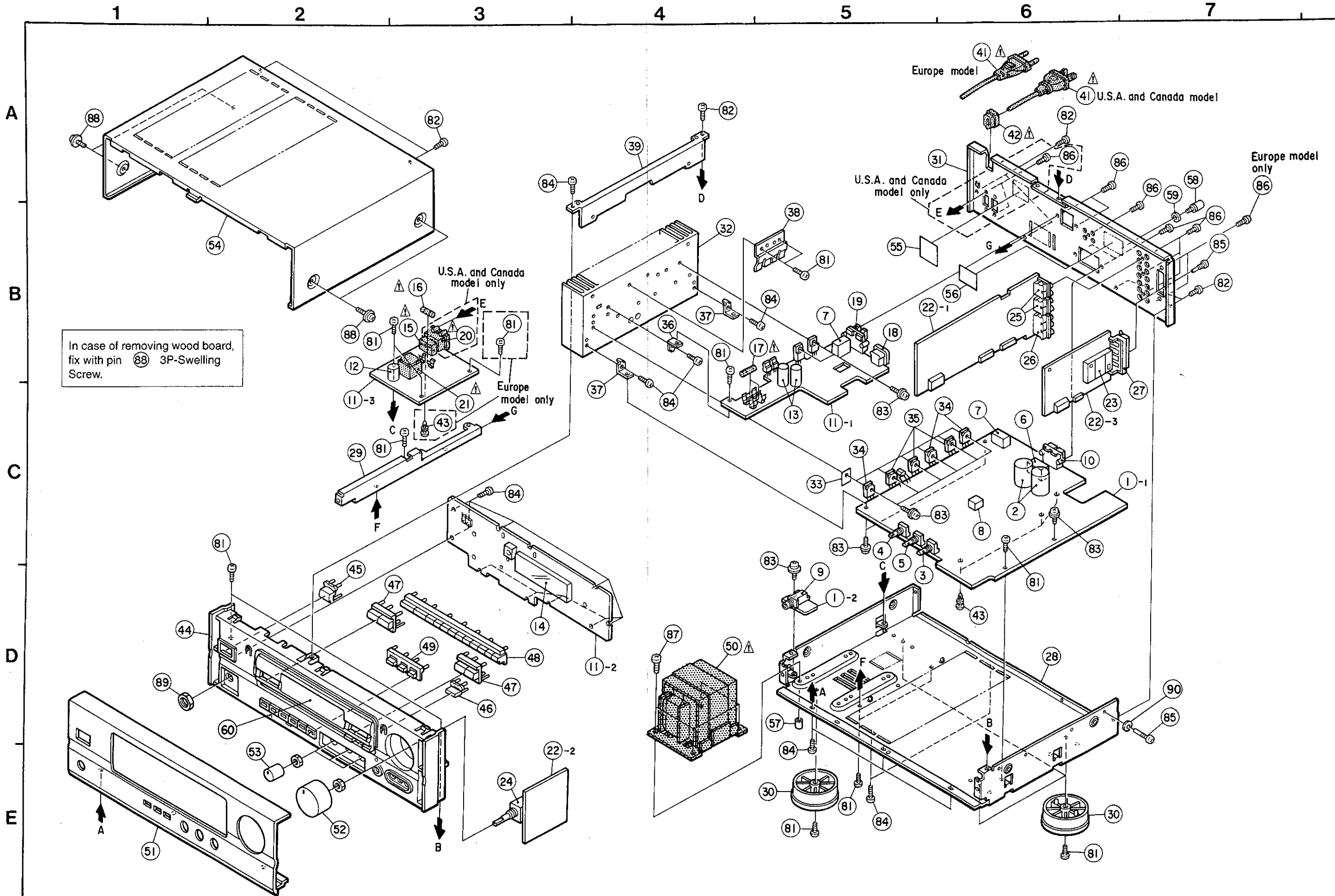

In case of removing wood board, fix with pin 88 3P-Swelling Screw.

EXPLODED VIEW PARTS LIST

Ref. No.	Part No.	Part Name	Remarks	Q'ty
1	Note	Main Amp. Unit Ass'y		1 ^S
1-1	—	Main Amp. Unit		(1)
1-2	—	Headphone Unit		(1)
2	254 4349 717	Chemicon 5600µF/56V	C353,354	2
3	211 0798 103	Variable Resistor 100kohm	Balance(VR451)	1
4	211 0797 117	Variable Resistor 30kohm	Bass (VR452)	1
5	211 0797 104	Variable Resistor 5kohm	Treble (VR453)	1
6	214 9003 005	Relay	RL481	1
7	214 0167 005	Relay(G5Z-2A)	RL480,501	2
8	214 0162 000	Relay(A12W-K)	RL482	1
9	204 8354 004	Headphone Jack		1
10	205 0846 005	6P Push Terminal		1
11	Note	Rear Amp. Unit Ass'y		1 ^S
11-1	—	Rear Amp. Unit		(1)
11-2	—	VFD Unit		(1)
11-3	—	Power Supply Unit		(1)
12	254 4256 790	Chemicon 2200µF/25V	C555	1
13	254 4259 713	Chemicon 3300µF/35V	C517,518	2
14	393 4131 000	FLD(FIP14PM8) Ass'y	FL701	1
15	214 0170 005	Relay(TV-8)	RL551	1
16	Note	Fuse A	F001	1
17	Note	Fuse A	F003,004	2
18	204 8442 000	4P Pin Jack(S-GND)		1
19	205 0592 003	4P Push Terminal		1
20	Note	AC Outlet(2P)		1
21	Note	Power Trans(Mini)		1
22	Note	Surround Unit Ass'y		1 ^S
22-1	—	Surround Unit		(1)
22-2	—	Volume Unit		(1)
22-3	—	Tuner Unit		(1)
23	Note	Front End	IC004	1
24	211 0802 002	Variable Resistor 100kohm	VR261	1
25	204 8313 003	4P Pin Jack(S-GND)		2
26	204 8346 009	6P Pin Jack(S-GND)		1
27	Note	Ant. Terminal		1
28	411 1267 301	Main Chassis		1
29	412 3751 106	Center Bracket		1
30	104 0194 108	Foot Ass'y		4
31	Note	Rear Panel		1
32	417 0492 104	Power Radiator		1
33	415 0234 007	Insulating Sheet		6
34	271 0237 006	Transistor 2SA1490(O/P/Y)(Z)	TR321,322,411	3
35	273 0386 005	Transistor 2SC3854(O/P/Y)(Z)	TR317,318,410	3
36	412 3766 007	L Bracket		1
37	412 3767 006	P.W.B Bracket		2
38	412 3470 102	Spring Plate		1
39	412 3752 008	Radiator Bracket		1
40	—	—		1
41	Note	AC Cord with plug		1
42	445 0056 008	Cord Bush		1
43	Note	Card Spacer(L=12)		4
44	146 1465 649	Inner Panel		1
45	113 1636 106	Push Knob(P)		1
46	113 1637 008	Push Knob		1
47	113 1638 104	Function Knob		2
48	113 1639 006	Pre-set Knob		1
49	113 1640 105	Tact Knob		1
50	Note	Power Trans		1
51	144 2321 139	Front Panel		1
52	112 0737 003	Volume Knob		1
53	112 0739 001	Knob(Round)		3
54	102 0543 009	Top Cover		1
55	Note	Caution Label(A)		1
56	Note	Caution Label(B)		1
57	462 0094 007	Screw Tube		1

Ref. No.	Part No.	Part Name	Remarks	Q'ty
58	205 0071 016	Terminal Ass'y		1
59	477 0018 001	Washer (P-87)		1
60	143 0867 003	Window		1
61	—	—		1
62	—	—		1
63	—	—		1
SCREWS				
81	Note	Tapping Screw(S)3x8	Black	16
82	473 7015 018	Tapping Screw(S)3x8	Black	7
83	473 8007 009	Cup Screw 3x12		12
84	473 7501 001	Tapping Screw(P)3x10		19
85	Note	Earth Screw		2
86	477 0064 107	Fixing Screw		10
87	473 7004 029	Tapping Screw(S)4x10	Black	4
88	477 0263 005	3P Swelling Screw		4
89	475 6124 003	Nut M 12		1
90	475 2003 034	Spring Washer φ3	BKNI	1
PACKING & ACCESSORIES				
101	504 0162 000	Stylen Paper	for AC cord	1
102	504 0162 013	Stylen Paper	for Set	1
103	505 0272 003	Poly Cover		1
104	503 1113 204	Cushion		2
105	GEN 2599	Envelope Sub Ass'y		1 ^S
105-1	505 8006 019	Envelope		(1)
105-2	Note	Inst. Manual		(1)
105-3	399 0221 006	Remote Control	RC-169	(1)
105-4	—	Battery		(1)
105-5	231 0922 009	Loop Antenna		(1)
105-6	Note	FM Ant. Ass'y		(1)
105-7	Note	DAI Warranty Home		(1)
105-7	Note	DCI Warranty Home		(1)
106	501 1738 007	Carton Case		1
107	Note	CSA Label		1
108	—	—		1

ADDENDUM PARTS LIST

Ref. No.	Part Name	Q'ty	Part No.		
			U.S.A. model	CANADA model	EUROPE model
1	Main Unit Ass'y	1 ^S	1U-2650	1U-2650	1U-2650 B
11	Rear Amp. Unit Ass'y	1 ^S	1U-2651	1U-2651	1U-2651 B
16	Fuse A(F001)	1	206 1046 001 6.3A UL20mm	206 1046 001 6.3A UL20mm	206 1015 032 2.5A
17	Fuse A(F003,004)	2	206 1046 027 5A	206 1046 027 5A	—
20	AC Outlet(2P)	1	203 3941 008	203 3941 008	—
21	Power Trans(Mini)	1	233 6073 000	233 6073 000	233 6058 012
22	Surround Unit Ass'y	1 ^S	1U-2652	1U-2652	1U-2652 B
23	Front End(IC104)	1	216 0064 007	216 0064 007	216 0065 006
27	Ant. Terminal	1	205 0505 003 4P Push	205 0505 003 4P Push	205 0776 007 3P Ant.(PAL)
31	Rear Panel	1	105 1100 301	105 1100 301	105 1100 314
41	AC Cord with plug	1	206 2050 009 (3)	206 2050 009 (3)	206 2063 009 (4)
43	Card Spacer(L=12)	1	412 2814 057 (3)	412 2814 057 (3)	412 2814 057 (4)
50	Power Trans	1	233 6072 001	233 6072 001	233 6086 000
55	Caution Label(A)	1	513 2209 004	513 2209 004	—
56	Caution Label(B)	1	513 2210 006	513 2210 006	—
SCREWS					
81	Tapping Screw(S) 3x8		473 7002 018 (15)	473 7002 018 (15)	473 7002 018 (16)
85	Earth Screw		477 0276 018 (2)	477 0276 018 (2)	477 0276 018 (1)
PACKING & ACCESSORIES (Not included EXPLODED VIEW.)					
105-2	Inst. Manual	1	511 2550 003	511 2550 003	511 2589 003
		1	—	511 2577 002	—
105-6	FM Ant. Ass'y	1	395 0019 025	395 0019 025	395 0021 000
105-7	DAI Warranty Home	1	515 0623 109	—	—
	DCI Warranty Home	1	—	515 0627 105	—
106	CSA Label	1	—	LL-6559 2	—

NOTE FOR PARTS LIST

- Part indicated with the mark "●" are not always in stock and possibly to take a long period of time for supplying, or in some case supplying of part may be refused.
- When ordering of part, clearly indicate "1" and "l" (l) to avoid mis-supplying.
- Ordering part without stating its part number can not be supplied.
- Part indicated with the mark "★" is not illustrated in the exploded view.

WARNING:
Parts marked with this symbol  have critical characteristics.
Use ONLY replacement parts recommended by the manufacturer.

REMOTE CONTROL (RC-169)

SCHMATIC DIAGRAM

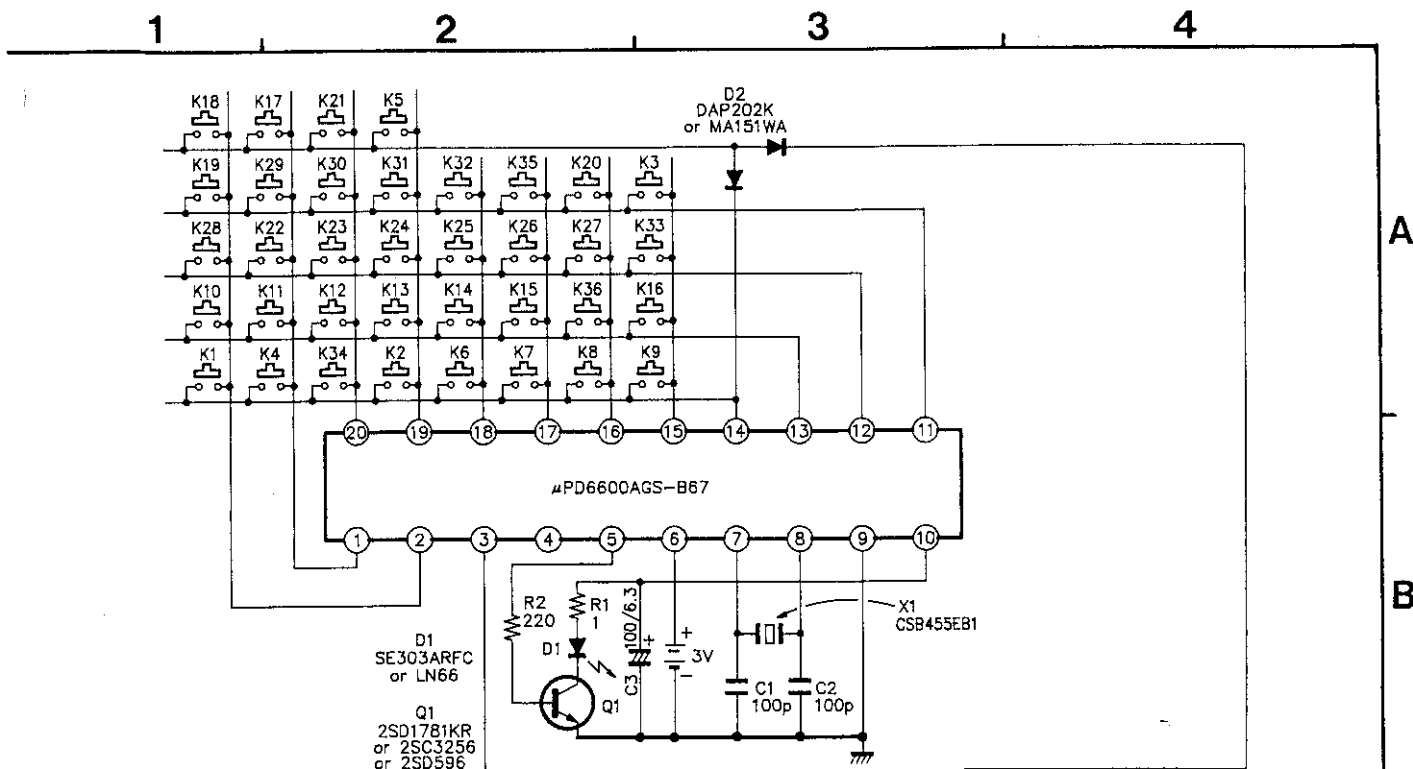

SPECIFICATIONS

- 1. When each Key is pressed double transmission is not performed. When one side is released from double pressed state, transmit code on unreleased side.

NOTES

ALL RESISTANCE VALUES IN OHM. k=1,000 OHM, M=1,000,000 OHM
 ALL CAPACITANCE VALUES IN MICRO FARAD. P=MICRO-MICRO FARAD
 EACH VOLTAGE AND CURRENT ARE MEASURED AT NO SIGNAL INPUT CONDITION.
 CIRCUIT AND PARTS ARE SUBJECT TO CHANGE WITHOUT PRIOR NOTICE.

REMOTE CONTROL UNIT ASS'Y

PARTS LIST OF EXPLODED VIEW

Ref. No.	Part No.	Part Name	Remarks	Q'ty	Ref. No.	Part No.	Part Name	Remarks	Q'ty
SEMICONDUCTORS GROUP									
IC1	—	μPD6600AGSB67	μ-Com		1	—	Case Top Ass'y		1
Q1	—	Transistor 2SD1781KR Transistor 2SC3256 Transistor 2SD596			2	—	Panel		1
D1	—	LED SE303ARF-C LED LN66	Infrared Infrared		3	—	Switch Rubber		1
D2	276 0559 909 or 276 0438 907	Diode DAP202K Diode MA151WA			4	—	Case Bottom Ass'y		1
RESISTORS GROUP									
R1	241 2407 901	Carbon Resistor 1ohm, 1/4W	RD14B2E010J		5	—	Cover Battery		1
R2	241 2397 901	Carbon Resistor 220ohm 1/4W	RD14B2E221J		6	—	Tapping Screw		2
CAPACITORS GROUP									
C1,C2	257 0004 961	Chip Ceramic 100pF/50V	CC73SL1H101J		7	—	Filter		1
C3	254 4213 034	Electrolytic 100μF/6.3V	CE04W0J101M		8	—	Spring Coil		1
OTHER GROUP									
X1	—	(P.W. Board) Ceramic Resonator	CSB455EB	(1) 1	9	—	Spring Coil		1
					10	—	Poly Cover		1
					11	—	P.W.B. Unit Ass'y		1 ^S

CORDS TABLE

KEY No.	System address					Custom code						Extension		Mask	Judgment	Remarks	
	C1	C2	C3	C4	C5	C6	C7	C8	C9	C10	C11	C12	C13	C14	K		
K1	0	0	1	0	0	1	1	1	0	1	0	1	0	0	0	0	◀ PLAY (REV)
K2	0	0	0	1	0	0	0	1	1	1	0	1	0	0	0	0	▶ PLAY
K3	0	1	0	0	0	0	1	1	0	1	1	1	1	0	0	0	▼ CENTER
K4	0	0	1	0	0	0	0	1	1	1	0	1	0	0	0	0	▶ PLAY
K5	0	0	1	0	0	1	1	0	0	1	0	1	0	0	0	0	A/B
K6	0	0	1	0	0	0	1	1	1	1	0	1	0	0	0	0	■ STOP
K7	0	0	0	1	0	1	1	0	1	0	1	1	0	0	0	0	DISC SKIP
K8	0	0	0	1	0	0	1	1	1	1	1	0	1	0	0	0	■ STOP
K9	0	0	1	0	0	0	1	0	1	1	0	1	0	0	0	0	▶▶ FF
K10	0	0	0	1	0	1	0	0	1	1	0	1	0	0	0	0	◀◀ RR
K11	0	0	0	1	0	0	0	0	1	1	0	1	0	0	0	0	▶▶ TUNER
K12	0	1	0	0	0	1	0	1	0	0	0	1	1	0	0	0	
K13	0	1	0	0	0	1	0	1	1	0	0	1	1	0	0	0	VCR
K14	0	1	0	0	0	0	1	0	1	0	0	1	1	0	0	0	VDP/DBS
K15	0	1	0	0	0	0	1	0	0	1	0	1	1	0	0	0	DAT/TAPE MONITOR
K16	0	1	0	0	0	1	1	0	0	0	0	1	1	0	0	0	PHONO
K17	0	0	1	0	0	1	1	0	1	1	0	1	0	0	0	0	◀◀ REW
K18	0	0	1	1	0	0	1	1	1	0	1	0	1	0	0	0	▶▶ PRESET ▲
K19	0	0	1	1	0	1	0	1	0	1	0	1	1	0	0	0	PRESET ▼
K20	0	1	0	0	0	0	1	0	0	1	1	1	1	0	0	0	MASTER VOL. ▼
K21	0	1	0	0	0	0	0	1	0	1	1	1	1	0	0	0	REAR ▼
K22	0	1	0	0	0	1	0	0	1	0	1	1	1	0	0	0	DELAY ▲
K23	0	1	0	0	0	0	1	0	1	0	1	1	1	0	0	0	T. TONE
K24	0	1	0	0	0	0	1	1	0	0	1	1	1	0	0	0	SURR. MODE
K25	0	1	0	0	0	0	0	0	1	0	1	1	1	0	0	0	DELAY ▼
K26	0	0	1	1	0	1	0	0	1	0	1	0	1	0	0	0	MEMORY
K27	0	0	1	1	0	0	1	0	1	0	1	0	1	0	0	0	1
K28	0	1	0	0	0	0	1	1	1	0	0	1	1	1	0	0	BYPASS
K29	0	1	0	0	0	0	0	0	0	1	1	1	1	0	0	0	MUTING
K30	0	1	0	0	0	1	0	1	0	1	1	1	1	0	0	0	CENTER ▲
K31	0	1	0	0	0	1	1	0	0	1	1	1	1	0	0	0	REAR ▲
K32	0	1	0	0	0	0	1	0	0	0	1	1	1	0	0	0	MASTER VOL. ▲
K33	0	0	1	1	0	1	1	0	1	0	1	0	1	0	0	0	2
K34	0	0	0	1	0	1	0	1	1	1	0	1	0	0	0	0	PAUSE
K35	0	1	0	0	0	1	0	0	0	0	0	1	1	0	0	0	POWER
K36	0	1	0	0	0	0	0	1	0	0	0	1	1	0	0	0	CD

NOTE FOR PARTS LIST

- Part indicated with the mark "⊙" are not always in stock and possibly to take a long period of time for supplying, or in some case supplying of part may be refused.
- When ordering of part, clearly indicate "1" and "1" (i) to avoid mis-supplying.
- Ordering part without stating its part number can not be supplied.
- Part indicated with the mark "★" is not illustrated in the exploded view.
- Not including Carbon Film ±5%, 1/6W, 1/4W Type in the P.W.Board parts list. (Refer to the Schematic Diagram for those parts.)

WARNING:

Parts marked with this symbol  have critical characteristics. Use ONLY replacement parts recommended by the manufacturer.