

DENON

Hi-Fi AV Surround Receiver

SERVICE MANUAL

MODEL AVR-950RD

AV SURROUND RECEIVER

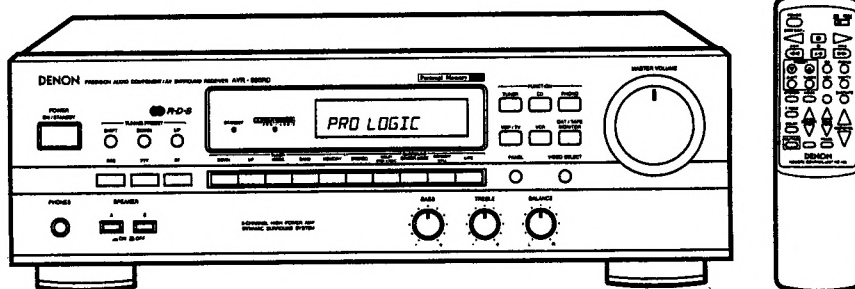

For servicing, refer to the service manual of AVR-900 already issued at the same time. This service manual is common to AVR-900 including operating instruction, exploded view, printed wiring board, schematic diagram etc. Also, it is mentioned to only difference for parts list of P.W. Board.

CONTENTS





OPERATING INSTRUCTIONS	2-10
PARTS LIST OF P. W. BOARD	11, 12
PRINTED WIRING BOARD	13-17
EXPLODED VIEW	18
PARTS LIST OF EXPLODED VIEW	19
SCHEMATIC DIAGRAM	21-25

NIPPON COLUMBIA CO., LTD.

1 INTRODUCTION / EINFÜHRUNG / INTRODUCCION / INTRODUCCION / INLEIDING / INLEIDNING

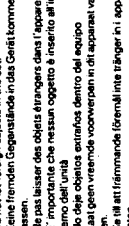
NOTE ON USE / HINWEISE ZUM GEBRAUCH
OBSERVATIONS RELATIVES A L'UTILISATION / NOTE SULL'USO
NOTAS SOBRE EL USO / ALVORENS TE GEBRUIKEN / OBSERVERA
OBSERVAÇÕES QUANTO AO USO

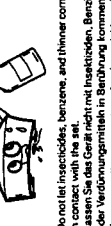
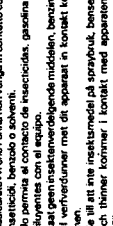
<ul style="list-style-type: none"> ■ We greatly appreciate your purchase of the AVR-900/950RD. ■ Model AVR-950RD has the same specifications as the AVR-900 except for the addition of the RDS broadcast reception function. ■ To be sure you take maximum advantage of all the features the AVR-900/950RD has to offer, read these instructions carefully and use the set properly. Be sure to keep this manual for future reference should any questions or problems arise. 	<ul style="list-style-type: none"> ■ Wir begrüßen Ihren Kauf des AVR-900/950RD außerordentlich. ■ Das Modell AVR-950RD hat die gleichen technischen Daten wie das Modell AVR-900, mit Ausnahme der zusätzlichen RDS-Rundfunkempfangsfunktion. ■ Lesen Sie sich diese Bedienungsanleitung sorgfältig durch und bedienen Sie die Anlage richtig, damit Sie alle Merkmale, die der AVR-900/950RD zu bieten hat, maximal ausnutzen können. Bewahren Sie diese Bedienungsanleitung gut auf, so daß Sie Ihnen bei eventuell auftretenden Fragen oder Störungen, jederzeit als Referenz zur Verfügung steht. 	<ul style="list-style-type: none"> ■ Nous vous remercions de l'achat de cet ampli-tuner AVR-900/950RD. ■ Le modèle AVR-950RD possède les mêmes caractéristiques que le modèle AVR-900 sauf pour l'addition de la fonction de réception d'émission RDS. ■ Prière de lire attentivement ce mode d'emploi afin d'obtenir la meilleure performance et une longue durée de vie sans problème de cet ampli-tuner AVR-900/950RD. S'assurer de conserver ce mode d'emploi pour s'y référer ultérieurement. 	<ul style="list-style-type: none"> ■ Apprezziamo veramente il fatto che voi avete acquistato l'AVR-900/950RD. ■ Il modello AVR-950RD presenta le stesse caratteristiche del modello AVR-900 ad eccezione della funzione di ricezione delle stazioni RDS. ■ Leggete questo manuale attentamente ed usate l'unità in modo corretto per ottenere le migliori prestazioni di tutte le caratteristiche dell'AVR-900/950RD. Tenete questo manuale in un luogo sicuro per futuri riferimenti in caso sorgessero dei dubbi. 	<ul style="list-style-type: none"> ■ Le estamos sinceramente agradecidos por su compra del AVR-900/950RD. ■ El modelo AVR-950RD tiene las mismas especificaciones que el AVR-900, excepto por el hecho de que además incorpora la función de recepción de emisiones RDS. ■ A fin de aprovechar plenamente las características del AVR-900/950RD, le detenidamente este manual de instrucciones antes de usar la unidad, asegúrese de operar la unidad correctamente, de acuerdo a las instrucciones. Conserve este manual para futuras consultas en caso de dudas o problemas. 	<ul style="list-style-type: none"> ■ Wij stellen het zeer op prijs dat u de AVR-900/950RD heeft gekocht. ■ Het model AVR-950RD heeft dezelfde technische gegevens als de AVR-900, maar beschikt daarnaast ook over de functie voor ontvangst van RDS-uitzendingen. ■ Om alle kenmerken die de AVR-900/950RD te bieden heeft optimaal te kunnen benutten, is het nodig dat u deze gebruiksaanwijzing nauwkeurig doorleest en dat u het toestel juist gebruikt. Houd de handleiding bij zodat u ze later kan raadplegen wanneer u vragen heeft of zich eventueel problemen voordoen.
<ul style="list-style-type: none"> ■ Keine fremden Gegenstände in das Gerät kommen lassen. ■ Ne pas laisser des objets étrangers dans l'appareil. ■ E' importante che nessun oggetto è inserito all'interno. ■ No deje objetos extraños dentro del equipo. ■ Laat geen vreemde voorwerpen in het apparaat vallen. ■ Se til alt fremmede (fremål) inte tringer inn i apparatet. ■ Não deixe objetos estranhos no aparelho. 	<ul style="list-style-type: none"> ■ Do not let foreign objects in the set. ■ Keine fremden Gegenstände in das Gerät kommen lassen. ■ Ne pas laisser des objets étrangers dans l'appareil. ■ E' importante che nessun oggetto è inserito all'interno. ■ No deje objetos extraños dentro del equipo. ■ Laat geen vreemde voorwerpen in het apparaat vallen. ■ Se til alt fremmede (fremål) inte tringer inn i apparatet. ■ Não deixe objetos estranhos no aparelho. 	<ul style="list-style-type: none"> ■ Do not let insecticide, benzene, and thinner come in contact with the set. ■ Lassen Sie das Gerät nicht mit Insektiziden, Benzin oder Verdünnungsmitteln in Berührung kommen. ■ Ne pas mettre en contact des insecticides, du benzène ou des diluants avec l'appareil. ■ Assicurarsi che l'unità non venga in contatto con insetticidi, benzolo o solventi. ■ No permita el contacto de insecticidas, gasolina y diluyentes con el equipo. ■ Laat geen insectenverdelende middelen, benzine of verdunningsmiddelen in contact komen met het apparaat. ■ Não permita que inseticidas, benzina e dissolventes entrem em contacto com o aparelho. 	<ul style="list-style-type: none"> ■ Never disassemble or modify the set in any way. ■ Versuchen Sie niemals das Gerät auseinander zu nehmen oder auf jegliche Art zu verändern. ■ Ne jamais démonter ou modifier l'appareil d'une manière quelconque. ■ Non smontare mai, né modificare l'unità in nessun modo. ■ Nunca desarme o modifique el equipo de ninguna manera. ■ Never disassemble or modify the set in any way. ■ Versuchen Sie niemals das Gerät auseinander zu nehmen oder auf jegliche Art zu verändern. ■ Ne jamais démonter ou modifier l'appareil d'une manière quelconque. ■ Non smontare mai, né modificare l'unità in nessun modo. ■ Nunca desarme o modifique el equipo de ninguna manera. 	<ul style="list-style-type: none"> ■ Never disassemble or modify the set in any way. ■ Versuchen Sie niemals das Gerät auseinander zu nehmen oder auf jegliche Art zu verändern. ■ Ne jamais démonter ou modifier l'appareil d'une manière quelconque. ■ Non smontare mai, né modificare l'unità in nessun modo. ■ Nunca desarme o modifique el equipo de ninguna manera. ■ Never disassemble or modify the set in any way. ■ Versuchen Sie niemals das Gerät auseinander zu nehmen oder auf jegliche Art zu verändern. ■ Ne jamais démonter ou modifier l'appareil d'une manière quelconque. ■ Non smontare mai, né modificare l'unità in nessun modo. ■ Nunca desarme o modifique el equipo de ninguna manera. 	<ul style="list-style-type: none"> ■ Vi tackar dig för ditt val av AVR-900/950RD. ■ Modell AVR-950RD har samma specifikationer som AVR-900 bortsett från att den också är försedd med RDS-funktioner för radiomottagning. ■ Läs bruksanvisningen nog och följ föreskrifterna, så att du säkert kan utnyttja egenskaperna hos din AVR-900/950RD på bästa sätt. Behåll bruksanvisningen som hjälp i framtiden om frågor eller problem skulle uppstå.

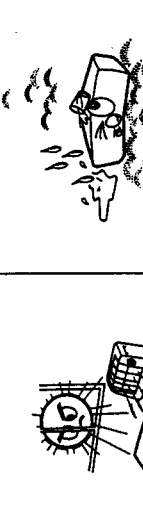
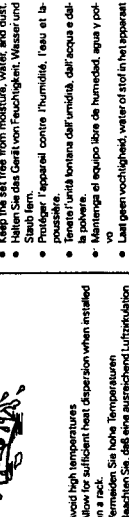
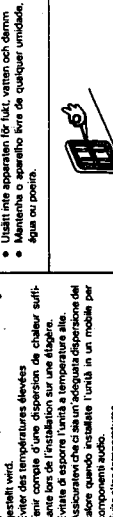
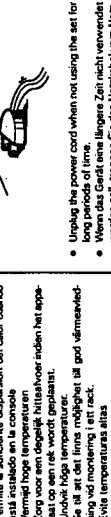
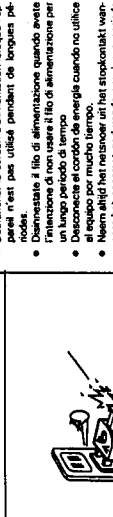
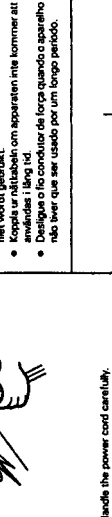
 <ul style="list-style-type: none"> ■ Keep the set free from moisture, water and dust. ■ Halten Sie das Gerät von Feuchtigkeit, Wasser und Staub fern. ■ Protéger l'appareil contre l'humidité, l'eau et la poussière. ■ Tenete l'unità lontana dall'umidità, dall'acqua e dalla polvere. ■ Manténgase el equipo libre de humedad, agua y polvo. ■ Laat geen vochtigheid, water of stof in het apparaat binnendringen. ■ Mantenha o aparelho livre de qualquer umidade, água ou poeira. 	 <ul style="list-style-type: none"> ■ Plug the power cord when not using the set for long periods of time. ■ Wenn das Gerät eine längere Zeit nicht verwendet werden soll, trennen Sie das Netzkabel vom Netzstecker. ■ Débrancher le cordon d'alimentation lorsque l'appareil n'est pas utilisé pendant de longues périodes. ■ Desconecte el hilo de alimentación cuando avierte que el equipo no va a ser utilizado por un largo periodo de tiempo. ■ Disconecte el cordón de energía cuando no utilice el equipo por mucho tiempo. ■ Neem altijd het netstroom-uit het stopcontact wanneer het apparaat gedurende een lange periode niet wordt gebruikt. ■ Koposd az áramkábelt az apparátustól amikor azt anélkül is látványt. ■ Desligue o fio condutor de força quando o aparelho não estiver a ser usado por um longo período. 	 <ul style="list-style-type: none"> ■ Do not obstruct the ventilation holes. ■ Die Belüftungöffnungen dürfen nicht verdeckt werden. ■ Ne pas obstruer les trous de ventilation. ■ Non coprire i fori di ventilazione. ■ Não obstrua as aberturas de ventilação. ■ Do not obstruct the ventilation holes. ■ Die Belüftungöffnungen dürfen nicht verdeckt werden. ■ Ne pas obstruer les trous de ventilation. ■ Non coprire i fori di ventilazione. ■ Não obstrua as aberturas de ventilação. 	 <ul style="list-style-type: none"> ■ Handle the power cord carefully. ■ Geben Sie vorsichtig mit dem Netzkabel um. ■ Soyez prudent avec le câble au secteur, wenn Sie ihn benutzen. ■ Manipulez le cordon d'alimentation avec précaution. ■ Tené la presa lora de cablear el cable del cordón. ■ Maneggiare il filo di alimentazione con cura. ■ Handle the power cord carefully. ■ Geben Sie vorsichtig mit dem Netzkabel um. ■ Soyez prudent avec le câble au secteur, wenn Sie ihn benutzen. ■ Manipulez le cordon d'alimentation avec précaution. ■ Tené la presa lora de cablear el cable del cordón. ■ Maneggiare il filo di alimentazione con cura. 	 <ul style="list-style-type: none"> ■ Handle the power cord carefully. ■ Geben Sie vorsichtig mit dem Netzkabel um. ■ Soyez prudent avec le câble au secteur, wenn Sie ihn benutzen. ■ Manipulez le cordon d'alimentation avec précaution. ■ Tené la presa lora de cablear el cable del cordón. ■ Maneggiare il filo di alimentazione con cura. ■ Handle the power cord carefully. ■ Geben Sie vorsichtig mit dem Netzkabel um. ■ Soyez prudent avec le câble au secteur, wenn Sie ihn benutzen. ■ Manipulez le cordon d'alimentation avec précaution. ■ Tené la presa lora de cablear el cable del cordón. ■ Maneggiare il filo di alimentazione con cura. 	 <ul style="list-style-type: none"> ■ Handle the power cord carefully. ■ Geben Sie vorsichtig mit dem Netzkabel um. ■ Soyez prudent avec le câble au secteur, wenn Sie ihn benutzen. ■ Manipulez le cordon d'alimentation avec précaution. ■ Tené la presa lora de cablear el cable del cordón. ■ Maneggiare il filo di alimentazione con cura. ■ Handle the power cord carefully. ■ Geben Sie vorsichtig mit dem Netzkabel um. ■ Soyez prudent avec le câble au secteur, wenn Sie ihn benutzen. ■ Manipulez le cordon d'alimentation avec précaution. ■ Tené la presa lora de cablear el cable del cordón. ■ Maneggiare il filo di alimentazione con cura.
 <ul style="list-style-type: none"> ■ Avoid high temperatures. ■ Allow for sufficient heat dissipation when installed on a rack. ■ Beachten Sie, daß eine ausreichende Luftzirkulation gewährleistet wird, wenn das Gerät auf ein Regal gestellt wird. ■ Éviter des températures élevées. ■ Permettre d'une dissipation de chaleur suffisante lorsqu'il est installé sur un socle. ■ Evitare di esporre l'unità a temperature alte. ■ Assicurarsi che ci sia un'adeguata dissipazione del calore quando si installa l'unità in un mobile per componenti audio. ■ Evite altas temperaturas. ■ Permita una adecuada disipación del calor cuando está instalado en la consola. ■ Vermeid hohe temperaturen. ■ Zorg voor een degelijke hitteafvoer indien het apparaat op een rek wordt geplaatst. ■ Se til alt høye temperaturer. ■ Evite temperaturas altas. ■ Conceda suficiente dissipación de calor cuando o equipamento for instalado numa prateleira. 	 <ul style="list-style-type: none"> ■ Avoid high temperatures. ■ Allow for sufficient heat dissipation when installed on a rack. ■ Beachten Sie, daß eine ausreichende Luftzirkulation gewährleistet wird, wenn das Gerät auf ein Regal gestellt wird. ■ Éviter des températures élevées. ■ Permettre d'une dissipation de chaleur suffisante lorsqu'il est installé sur un socle. ■ Evitare di esporre l'unità a temperature alte. ■ Assicurarsi che ci sia un'adeguata dissipazione del calore quando si installa l'unità in un mobile per componenti audio. ■ Evite altas temperaturas. ■ Permita una adecuada disipación del calor cuando está instalado en la consola. ■ Vermeid hohe temperaturen. ■ Zorg voor een degelijke hitteafvoer indien het apparaat op een rek wordt geplaatst. ■ Se til alt høye temperaturer. ■ Evite temperaturas altas. ■ Conceda suficiente dissipación de calor cuando o equipamento for instalado numa prateleira. 	 <ul style="list-style-type: none"> ■ Avoid high temperatures. ■ Allow for sufficient heat dissipation when installed on a rack. ■ Beachten Sie, daß eine ausreichende Luftzirkulation gewährleistet wird, wenn das Gerät auf ein Regal gestellt wird. ■ Éviter des températures élevées. ■ Permettre d'une dissipation de chaleur suffisante lorsqu'il est installé sur un socle. ■ Evitare di esporre l'unità a temperature alte. ■ Assicurarsi che ci sia un'adeguata dissipazione del calore quando si installa l'unità in un mobile per componenti audio. ■ Evite altas temperaturas. ■ Permita una adecuada disipación del calor cuando está instalado en la consola. ■ Vermeid hohe temperaturen. ■ Zorg voor een degelijke hitteafvoer indien het apparaat op een rek wordt geplaatst. ■ Se til alt høye temperaturer. ■ Evite temperaturas altas. ■ Conceda suficiente dissipación de calor cuando o equipamento for instalado numa prateleira. 	 <ul style="list-style-type: none"> ■ Avoid high temperatures. ■ Allow for sufficient heat dissipation when installed on a rack. ■ Beachten Sie, daß eine ausreichende Luftzirkulation gewährleistet wird, wenn das Gerät auf ein Regal gestellt wird. ■ Éviter des températures élevées. ■ Permettre d'une dissipation de chaleur suffisante lorsqu'il est installé sur un socle. ■ Evitare di esporre l'unità a temperature alte. ■ Assicurarsi che ci sia un'adeguata dissipazione del calore quando si installa l'unità in un mobile per componenti audio. ■ Evite altas temperaturas. ■ Permita una adecuada disipación del calor cuando está instalado en la consola. ■ Vermeid hohe temperaturen. ■ Zorg voor een degelijke hitteafvoer indien het apparaat op een rek wordt geplaatst. ■ Se til alt høye temperaturer. ■ Evite temperaturas altas. ■ Conceda suficiente dissipación de calor cuando o equipamento for instalado numa prateleira. 	 <ul style="list-style-type: none"> ■ Avoid high temperatures. ■ Allow for sufficient heat dissipation when installed on a rack. ■ Beachten Sie, daß eine ausreichende Luftzirkulation gewährleistet wird, wenn das Gerät auf ein Regal gestellt wird. ■ Éviter des températures élevées. ■ Permettre d'une dissipation de chaleur suffisante lorsqu'il est installé sur un socle. ■ Evitare di esporre l'unità a temperature alte. ■ Assicurarsi che ci sia un'adeguata dissipazione del calore quando si installa l'unità in un mobile per componenti audio. ■ Evite altas temperaturas. ■ Permita una adecuada disipación del calor cuando está instalado en la consola. ■ Vermeid hohe temperaturen. ■ Zorg voor een degelijke hitteafvoer indien het apparaat op een rek wordt geplaatst. ■ Se til alt høye temperaturer. ■ Evite temperaturas altas. ■ Conceda suficiente dissipación de calor cuando o equipamento for instalado numa prateleira. 	 <ul style="list-style-type: none"> ■ Avoid high temperatures. ■ Allow for sufficient heat dissipation when installed on a rack. ■ Beachten Sie, daß eine ausreichende Luftzirkulation gewährleistet wird, wenn das Gerät auf ein Regal gestellt wird. ■ Éviter des températures élevées. ■ Permettre d'une dissipation de chaleur suffisante lorsqu'il est installé sur un socle. ■ Evitare di esporre l'unità a temperature alte. ■ Assicurarsi che ci sia un'adeguata dissipazione del calore quando si installa l'unità in un mobile per componenti audio. ■ Evite altas temperaturas. ■ Permita una adecuada disipación del calor cuando está instalado en la consola. ■ Vermeid hohe temperaturen. ■ Zorg voor een degelijke hitteafvoer indien het apparaat op een rek wordt geplaatst. ■ Se til alt høye temperaturer. ■ Evite temperaturas altas. ■ Conceda suficiente dissipación de calor cuando o equipamento for instalado numa prateleira.

DECLARATION OF CONFORMITY

We declare under our sole responsibility that the product AV surround receiver AVR-900/950RD to which this declaration relates is in conformity with the following standards: EN55013, EN55020, EN60555-2 and EN60555-3.

TABLE OF CONTENTS

1	Introduction	2, 3	5	Listening to the radio	7
2	Connections		5-1	Auto preset memory	8
2-1	Connecting the antenna terminals	4	5-2	Auto tuning	8
2-2	Connecting the audio components	4	5-3	Manual tuning	8
2-3	Speaker system connections	5	5-4	Preset memory	8
2-4	Connecting the video components	5	5-5	Recalling preset stations	8
3	Remote Control Unit	5	5-6	RDS (Radio Data System)*	8
4	Operations		5-7	RDS search*	8
4-1	Preparations for playback (stereo play back)	6	5-8	PTY search*	9
4-2	Playing the program source		5-9	TP search*	9
4-3	Simultaneous play back	6	5-10	RT (Radio Text)*	9
4-4	Using the muting function	6	* This function is only effective in the AVR-950RD.		
4-5	Listen with headphones	6	6	Initialization of the Microprocessor	9
4-6	Recording the program source (recording the source currently being monitored.)	6	7	Last function memory	9
4-7	Front panel display	6	8	Troubleshooting	10
4-8	Using the surround function	6, 7	9	Specifications	10

ACCESSORIES

Check that the following parts are included in addition to the main unit:

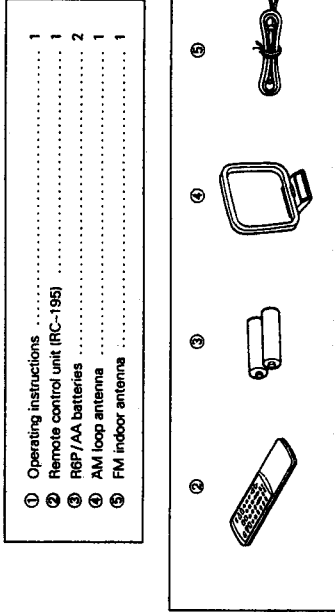

"SERIAL NO.

PLEASE RECORD UNIT SERIAL NUMBER ATTACHED TO THE REAR OF THE CABINET FOR FUTURE REFERENCE"

A note on stacking/Hinweis zum Aufeinanderstellen von Geräten/Remarque sur la juxtaposition/Nota sulla sovrapposizione/Aggiungimento/ Een opmerking t.v.m. het op elkaar plaatsen van de toestellen/Stapelung av utrustningen:

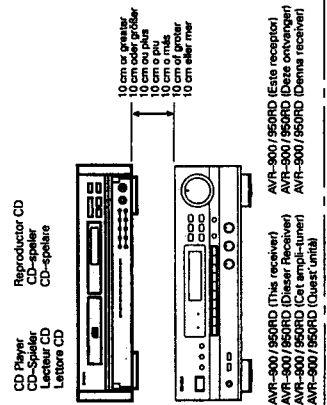

- PRECAUCIONES DURANTE LA INSTALACION**
El uso simultáneo de este receptor o de otros equipos que contengan microprocesadores, con un sintonizador o televisor, podrá causar interferencias en el sonido o imagen.
Si se emplea, como se sugiere, antenas medidas:
• Instale el receptor tan lejos del sintonizador o televisor como sea posible.
• Mantenga las líneas de antena del sintonizador o la TV tan lejos como sea posible del cable de alimentación del receptor o de los cables de conexión.
• Este problema será especialmente frecuente al usar antenas interiores o cables alimentadores de 300 ohms. Le recomendamos emplear antenas exteriores y cables coaxiales de 75 Ω/ohmios.

- VOORZORGSMAATREGELEN BIJ DE INSTALLATIE**
Het gebruik van deze ontvanger of andere elektronische toestellen die microprocessors bevatten in combinatie met een tuner of een TV kan leiden tot storing in het geluid of het beeld.
Tref de volgende maatregelen als dit gebeurt:
• Installeer de ontvanger zo ver mogelijk uit de buurt van de tuner of TV.
• Houd de antennesdraden van de tuner of de TV zo ver mogelijk uit de buurt van het net snoer en de aansluitkabels van de ontvanger.
• Dit probleem stelt zich vooral bij gebruik van binnenantennes of voedingsdraden van 300 ohm. Wij raden u aan gebruik te maken van buitenantennes en koaxkabels van 75 Ω/ohm.

- Zet geen andere audio/video-komponent direct bovenop de ontvanger, met het oog op afkoelen van de apparatuur. Wij raden u aan een ruimte open te laten van minstens 10 cm.
- SÄRSKILDA PUNKTER VID INSTALLATIONEN**
Om receiver eller annan elektronisk utrustning som innehåller mikroprocessor står påslagen alltför nära en tuner eller TV kan brus i ljud eller bild uppstå.
• Flytta receivern så långt som möjligt från tunern eller TV:n.
• Dra tunerns eller TV:n:s antennkablar så långt som möjligt från receiverns nätsladd och signalkablar.
• Problemet är särskilt märkbart vid användning av inomhusantenner eller 300 ohmsiga matarkablar. Vi rekommenderar därför utomhusantenn och 75 Ω/ohmiga koaxialkablar.
Med tanke på kylningen får ingen annan apparat ställas direkt på receivern. Se till att det finns ett mellanrum på minst 10 cm.

- INSTALLATION PRECAUTIONS**
Using this receiver or other electronic equipment containing microprocessors simultaneously with a tuner or TV may result in noise in the sound or picture.
• If this should happen, take the following steps:
• Keep the antenna lines of the tuner or TV as far as possible from the receiver's power cord and connection cables.
• This problem is especially frequent when using indoor antennas. We recommend using outdoor antennas and 75 Ω/ohms coaxial cables.

- For cooling purposes, do not place another AV component directly on top of the receiver. Be sure to leave a space of at least 10 cm.
- VORKEHRUNGEN ZUR INSTALLATION**
Wenn Sie diesen Receiver oder ein anderes elektronisches Gerät, das Mikroprozessoren beinhaltet, zusammen mit einem Tuner oder einem Fernsehgerät benutzen, so können daraus Ton- oder Bildstörungen resultieren.
Führen Sie in einem derartigen Fall die nachfolgend aufgeführten Schritte aus:
• Installieren Sie den Receiver so weit wie möglich entfernt vom Tuner oder Fernsehgerät.
• Halten Sie die Antennenleitungen des Tuners oder Fernsehgeräts soweit wie möglich vom Netzkabel und den Anschlusskabeln des Receivers entfernt.
• Dieses Problem tritt besonders häufig bei der Verwendung von Innenantennen oder 300 Ohm Antennenleitungen auf. Wir empfehlen die Verwendung von 75Ω/Ohm Koaxialkabeln.
- Stellen Sie kein anderes AV-Gerät direkt auf den Receiver, damit eine ausreichende Belüftung gewährleistet ist. Achten Sie darauf, daß stets ein Zwischenraum von mindestens 10 cm gegeben ist.

- PRECAUTIONS D'INSTALLATION**
L'utilisation de cet ampli-tuner ou de tout autre appareil électronique à microprocesseur près d'un tuner ou d'un téléviseur peut produire des parasites dans le son ou l'image.
Si cela se produit, prendre les mesures suivantes:
• Installer l'ampli-tuner aussi loin que possible du tuner ou du téléviseur.
• Disposer les fils d'antenne du tuner et du téléviseur aussi loin que possible du cordon d'alimentation du récepteur et des câbles de connexion.
• Du bruit et des parasites peuvent se produire en particulier lors de l'utilisation d'antennes intérieures ou de câbles d'alimentation de 300 ohms. L'utilisation d'antennes extérieures et de câbles coaxiaux de 75 Ω/ohms est recommandée.
- Pour permettre la dissipation de la chaleur, ne pas placer un appareil audio/vidéo directement sur le dessus de l'ampli-tuner. Laisser un espace d'au moins 10 cm.

- PRECAUZIONI RIGUARDANTI L'INSTALLAZIONE**
L'uso di questo ricevitore, o di altri componenti elettronici che contengono dei microprocessori, contemporaneamente con un sintonizzatore o un televisore potrebbe causare la generazione di rumore nel suono o nell'immagine.
In tal caso, procedere come segue:
• Installare il ricevitore il più lontano possibile dal sintonizzatore o dal televisore.
• Tenete le linee dell'antenna del sintonizzatore o del televisore il più lontano possibile dal cavo di alimentazione del ricevitore e dai cavi di collegamento.
• Questo problema si verifica spesso quando vengono usate delle antenne interne oppure dei fili alimentatori da 300 ohm. Vi raccomandiamo l'uso di antenne esterne e di cavi coassiali da 75 Ω/ohm.
Per motivi di raffreddamento, non collocare un altro componente AV direttamente sopra il ricevitore. Assicurare quindi lasciare uno spazio di almeno 10 cm tra le unità.

2 CONNECTIONS

2-1 Connecting the antenna terminals

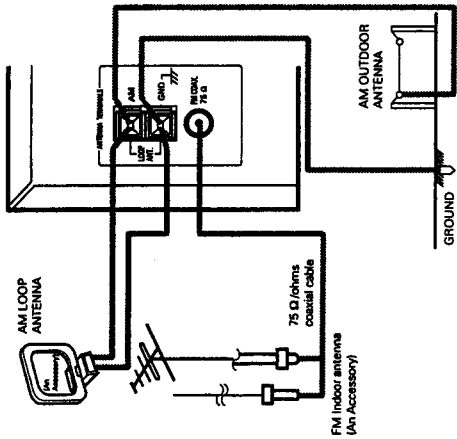
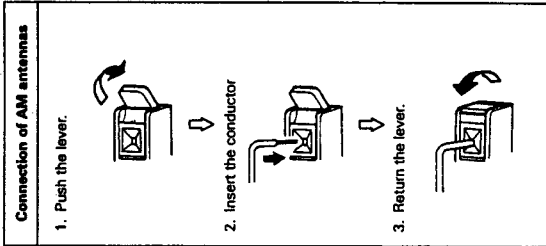

ANTENNA INSTALLATION

- **FM ANTENNA**
The supplied FM antenna can be used inside wooden houses for receiving local FM stations and other strong FM signals. Stretch out the ends of the antenna and mount the antenna on the wall or ceiling where optimum reception is achieved. A indoor FM antennas may not consistently ensure stable reception, due to environment changes. In such cases, the indoor FM antenna should only be used temporarily until an outdoor FM antenna has been installed.
When connecting an outdoor FM antenna, the use of 75 Ω Ohms coaxial cable (BC-2V, SC-2V) is strongly recommended.
 - **AM ANTENNA**
Attach the supplied AM loop antenna even when using an outdoor AM antenna.
Connect the leads to the AM and GND terminals.
Also use the AM terminals for connecting an outdoor AM antenna (when making such a connection do not disconnect the AM loop antenna.)
Adjust the loop antenna to obtain optimum reception. Where broadcast stations are distant and only weak signals are received, or where signals are blocked, it is best to install an outdoor AM antenna.
- NOTES**
- This receiver has a full back-up system. When the power is turned on, the INPUT SELECTOR buttons are set to the last mode set before the power was turned off.
 - When using this receiver in close proximity to video equipment (TV, VCR, VDP, etc.), noise may be generated in AM broadcasts. To avoid this, keep the receiver as far away from other video components as possible, or detach the AM loop antenna from the antenna holder and place it where noise is reduced. If the noise is not reduced, turn off the power of the video components when listening to AM broadcasts.

Note to CATV system installer:
This reminder is provided to call the CATV system installer's attention to Article 820-40 of the NEC, which provides guidelines for proper grounding and, in particular, specifies that the cable ground shall be connected to the grounding system of the building, as close to the point of cable entry as practical.

- Do not plug in the power cord until all connections have been completed.
- Be sure to connect the left and right channels properly (left with left, right with right).
- Insert the plugs securely. Incomplete connections will result in the generation of noise.
- Note that binding pin plug cords together with power cords or placing them near a power transformer will result in the introduction of hum or other noise.
- If hum or other noise is produced when the ground wire is connected, disconnect it.
- Noise or humming may be generated if a connected component is used independently without turning the power of the AVR-900/950RD on. If this happens, turn on the power of the AVR-900/950RD.

2-2 Connecting the audio components

- NOTE:**
The receiver cannot be used with MC cartridges directly. Use a separate head amplifier or step-up transformer.
- Precautions when connecting speakers**
If a speaker is placed near a TV or video monitor, the colors on the screen may be disturbed by the speaker's magnetism. If this should happen, move the speaker away to a position where it does not have this effect.

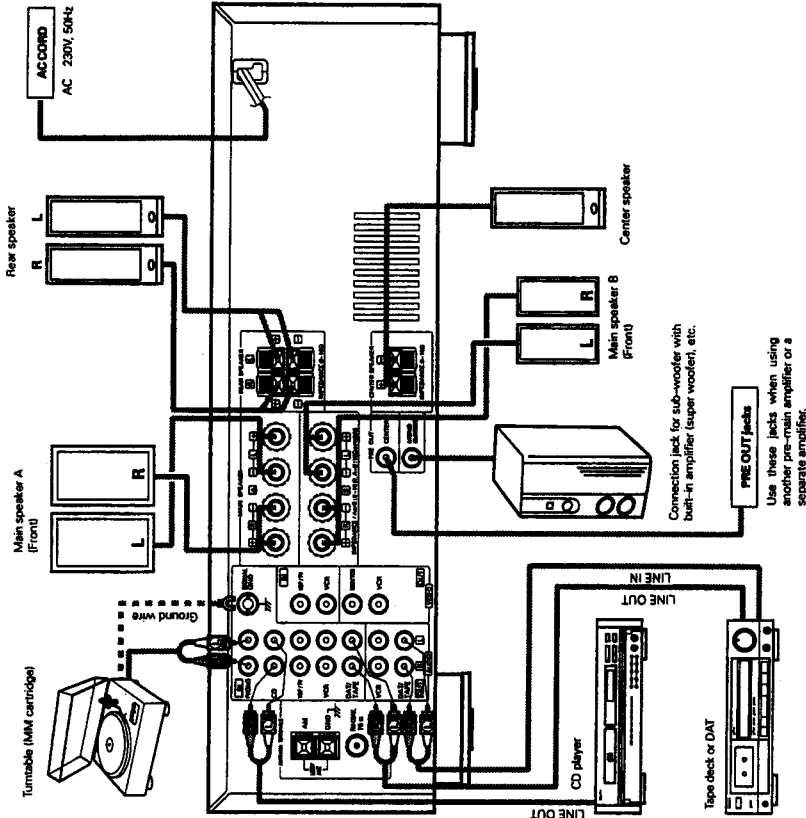

3 REMOTE CONTROL UNIT

Following the procedure outlined below, insert the batteries before using the remote control unit.

Range of operation of the remote control unit

Point the remote control unit at the remote control sensor as shown on the diagram at the left.

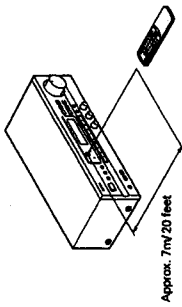

Approx. 7m/20 feet

NOTES:

- The remote control unit can be used from a straight distance of approximately 7 meters/20 feet, but this distance will shorten or operation will become difficult if there are obstacles between the remote control unit and the remote control sensor, if the remote control sensor is exposed to direct sunlight or other strong light, or if operated from an angle.
- Neon signs or other devices emitting pulse-type noise nearby may result in malfunction, so keep the set as far away from such devices as possible.

Inserting the batteries

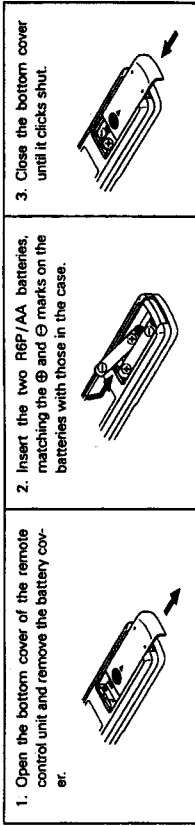

NOTES

- Use only AA, R6P, UM-3 batteries for replacement.
- Be sure the polarities are correct. (See the illustration inside the battery compartment.)
- Remove the batteries if the remote control transmitter will not be used for an extended period of time.
- If batteries leak, dispose of them immediately. Avoid touching the leaked material or letting it come in contact with clothing, etc. Clean the battery compartment thoroughly before installing new batteries.
- Have replacement batteries on hand so that the old batteries can be replaced as quickly as possible when the time comes.

System code buttons

DENON remote-controllable audio components can be controlled using this unit's remote control unit. Note that some components, however, cannot be operated with this remote control unit.

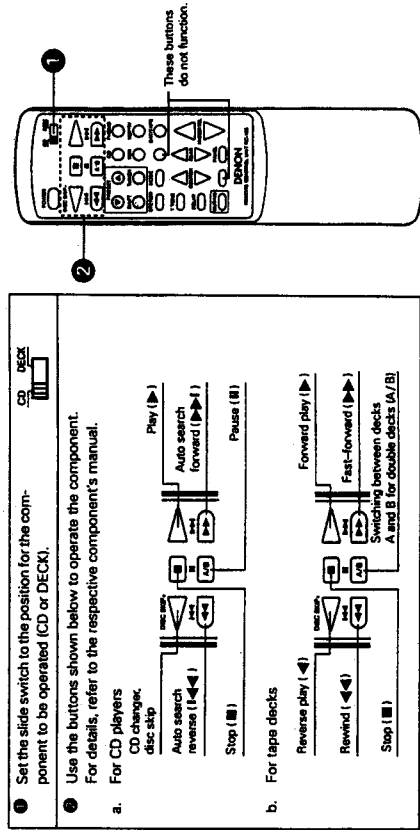

- Set the slide switch to the position for the component to be operated (CD or DECK).
- Use the buttons shown below to operate the component. For details, refer to the respective component's manual.
 - For CD players:
 - Auto search reverse (|<<|)
 - Play (▶)
 - Auto search forward (▶|)
 - CD change, disc skip
 - Pause (||)
 - Stop (■)
 - For tape decks:
 - Reverse play (◀|)
 - Forward play (▶|)
 - Fast-forward (▶▶|)
 - Fast-forward (▶▶|)
 - Switching between decks A and B for double decks (A/B)
 - Stop (■)

2-3 Speaker System Connections

- This receiver can accommodate connections of a total of seven speakers including two set of (front) main amplifier speakers (A and B), one set of rear speakers, and one center speaker.
- Connect the speaker terminals with the speakers making sure that like polarities are matched (⊕ with ⊕, ⊖ with ⊖). Mismatching of polarities will result in weak central sound, unclear orientation of the stereo being impaired.
- When making connections, take care that none of the individual conductors of the speaker cord come in contact with adjacent terminals, with other speaker cord conductors, or with the rear panel.

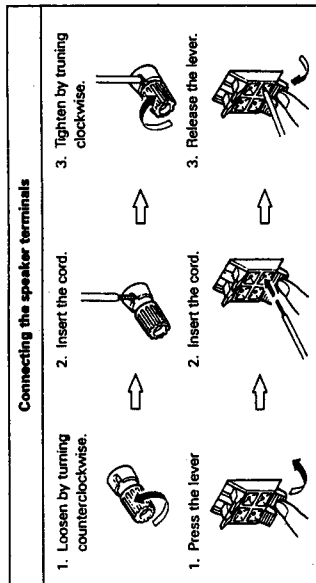

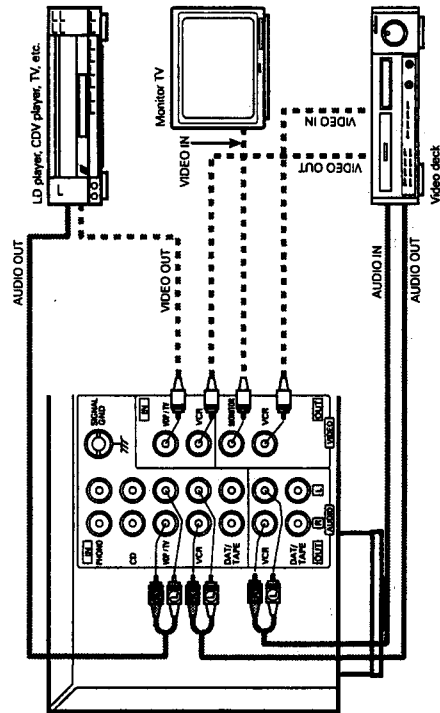

2-4 Connecting the video components

To connect the video signal, connect using a 75 Ω/ohms video signal cable cord. Using an improper cable can result in a drop in sound quality.



4 OPERATIONS

4-1 Preparations for Play Back

- Check that all connections are proper.
 - Set to the minimum position.
- MASTER VOLUME
- 
- Set to the center position.
- 
- Press the power button to turn the power on.

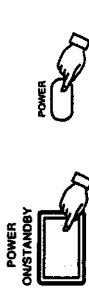

4-2 Playing the program source (Stereo play back)

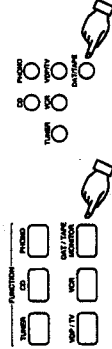
- Select the source to be played.
- 
- Select the STEREO mode.
-
- STEREO PLAY BACK
- Adjust the MASTER VOLUME control.
-
- MASTER VOLUME

- Adjust the front left/right BALANCE. Turn the control counterclockwise to reduce the volume of the right channel, clockwise to reduce the volume of the left channel.
-
- BALANCE

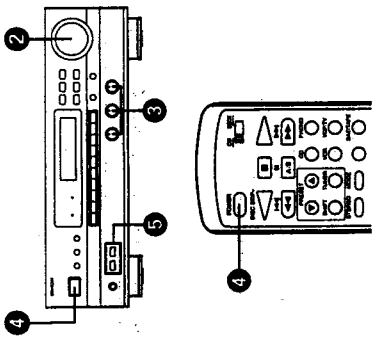

- Select the front speakers. Press the speaker A or B switch to turn the speaker on.

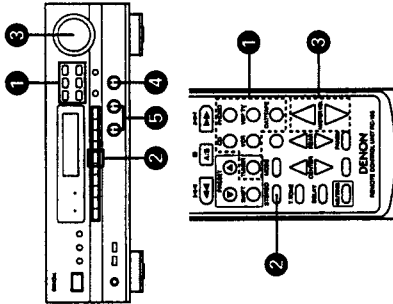

- Adjust the BASS and TREBLE.



Turn the control clockwise to increase the bass, counterclockwise to decrease it.

Turn the control clockwise to increase the treble, counterclockwise to decrease it.

4-3 Simulcast playback

Use this switch to monitor a video source other than the audio source.

- Press and hold the VIDEO SELECT button until the desired source appears on the display.
-
- VIDEO SELECT
- The source switches as shown above.
- Canceling simulcast playback
 - Press the VIDEO SELECT button once more.
 - Select the VIDEO function.

4-4 Using the muting function

Use this to turn off the audio output temporarily.

- Press the MUTING button.
- Canceling MUTING mode. Press the MUTING button again.



This function can only be set from the remote control unit. The STANDBY LED flashes when the muting function is set.

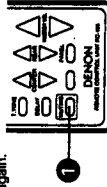

4-5 Listen with headphones

Connect the headphones to the PHONES jacks. When listening with headphones privately, set A, B SPEAKER switches and the superwoofer's power switch to the OFF position and set the stereo surround mode.

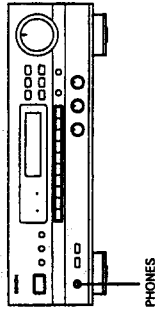

4-6 Recording the program source (recording the source currently being monitored)

- Follow steps 1 to 3 under "Playing the program source".

- Start recording on the tape or video deck. For instructions, refer to the component's operating instructions.

Simultaneous recording

The signals of the source selected with the function selector button are output simultaneously to the DAT/TAPE and VCR REC OUT jacks. If a total of two tape and/or video decks are connected and set to the recording mode, the same source can be recorded simultaneously on both decks. In addition, if the TAPE MONITOR (DAT/TAPE) button is pressed, the audio signals from the tape deck are output to the VCR AUDIO REC OUT jacks.

4-7 Front panel display

Descriptions of the unit's operations are also displayed on the front panel display. In addition, the display can be switched to check the unit's operating status while playing a source by pressing the PANEL button.

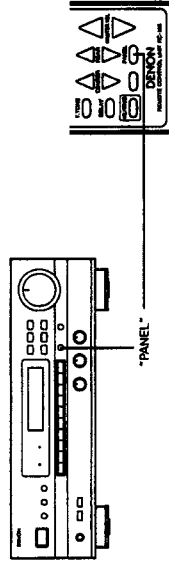







4-8 Using the surround function

Types of surround modes and their characteristics

1	Dolby Pro Logic	Use this when playing program sources recorded in Dolby Surround or Dolby stereo.
2	CONCERT HALL	Use this setting to create the atmosphere of a concert hall. There will be no output from the center speaker.
3	LIVE	Use this setting to create the atmosphere of watching a live performance. There will be no output from the center speaker.

Before using the surround function

Make the following adjustments before using the surround function.

1. Set the Dolby Pro Logic mode. 
2. Select the center mode. Select the center mode according to the center speaker.  The mode changes as shown above.
3. Emit the test tone. 
4. Adjust the center and rear levels to set the volume of the speakers to the same level. 
5. Turn the test tone off. 
6. Adjust the delay time and seating position as necessary. 

Test tones are produced from the speakers in the order shown below, at 4 second intervals for the first two cycles, 2 second intervals after that.

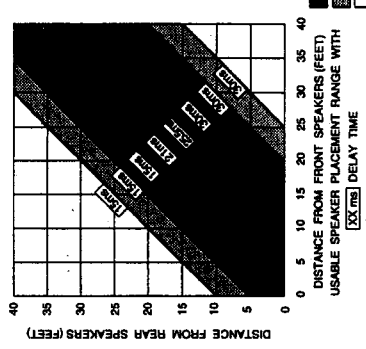
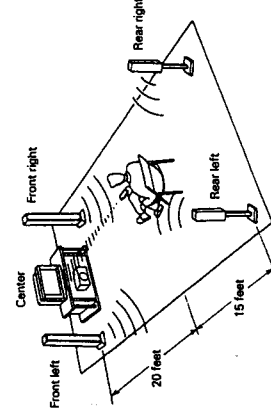
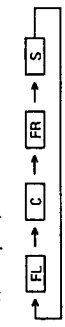

Personal Memory Plus function ... for EASY TO USE

The AVR-900/950RD automatically stores the surround mode adding effects for all input sources. The corresponding surround mode is recalled automatically each time an input source is selected.

Using the surround function

1. Select the surround mode according to the input source. 
2. If necessary, adjust the levels. 
3. Adjust the parameters to the desired settings. 

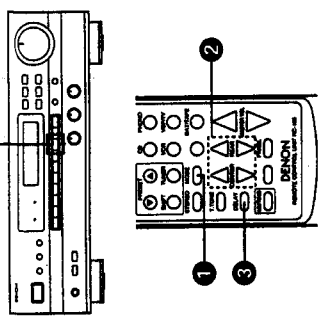

Manufactured under license from Dolby Laboratories Licensing Corporation. Additionally licensed under Canadian patent number 1,037,877. "Dolby," "Pro Logic," and the double-D symbol are trademarks of Dolby Laboratories Licensing Corporation.

Operating Possible in the Various Surround Modes

The following is a list of the buttons and functions which can be operated during the different surround modes. Figures in parentheses indicate adjustment ranges.

	OUTPUT	CENTER LEVEL	REAR LEVEL	CENTER MODE	TEST TONE	DELAY TIME
DOLBY PRO LOGIC	NORMAL	O 10--24dB	O 10--24dB	O	O	O 15--30ms
	PHANTOM	x	O 10--24dB	O	O	O 15--30ms
	WIDE	O 10--24dB	O 10--24dB	O	O	O 15--30ms
CONCERT HALL	O	x	O 10--24dB	Δ 1	x	O 10--30ms
	O	x	O 10--24dB	Δ 1	x	O 10--30ms



*1 Switches to the Dolby Pro Logic from any modes other than Dolby Pro Logic. The level of the center and rear channels can be adjusted by 2 dB step. The delay time can be set by 1.5 ms step.

The sound may be distorted for some sources if the rear level is raised during surround playback. If this happens, lower the rear level.

5 LISTENING TO THE RADIO

5-1 Auto preset memory

This unit is equipped with a function for automatically searching for FM broadcast stations and storing them in the preset memory.

1. Press the POWER button while holding in the MEMORY button. The unit automatically begins searching for FM broadcast stations. 
2. When the first FM broadcast station is found, that station is stored in the preset memory at channel A1. Subsequent stations are automatically stored in order at preset channels A2 to A8, B1 to B8, C1 to C8, D1 to D8 and E1 to E8, for a maximum of 40 stations. 
3. Channel A1 is tuned in after the auto preset memory operation is completed. 

NOTES:

- If an FM station cannot be preset automatically due to poor reception, use the "Manual tuning" operation to tune in the station, then press it using the manual "Preset memory" operation.
- RDS stations are stored in the memory with priority.
- To interrupt this function, press the power button.

5-2 Auto tuning

- 1 Set the input function to "TUNER".



- 2 Watching the display, press the BAND button to select the desired band (AM or FM).



- 3 Press the MODE button to set the auto tuning mode.



"AUTO" appears on the display.

If tuning does not stop at the desired station, use the "Manual tuning" operation.

5-3 Manual tuning

- 1 Set the input function to "TUNER".
- 2 Watching the display, press the BAND button to select the desired band (AM or FM).
- 3 Press the MODE button to set the manual tuning mode. Check that the display's "AUTO" indicator turns off.

NOTES:

- When in the auto tuning mode on the FM band, the "STEREO" indicator lights on the display when a stereo broadcast is tuned in. At open frequencies, the noise is muted and the "TUNED" and "STEREO" indicators turn off.
- When the manual tuning mode is set, FM stereo broadcasts are received in monaural and the "STEREO" indicator turns off.

5-4 Preset memory

- 1 Use the "Auto tuning" or "Manual tuning" operation to tune in the station to be preset in the memory.
- 2 Press the MEMORY button.
- 3 Press the SHIFT button and select the desired memory block (A to E).



- 4 Press the PRESET UP or DOWN button to select the desired preset channel (1 to 8).



To preset other channels, repeat steps 3 to 4. A total of 40 broadcast stations can be preset — 8 stations (channels 1 to 8) in each of blocks A to E.

5-5 Recalling preset stations

- 1 Watching the display, press the SHIFT button to select the preset memory block.

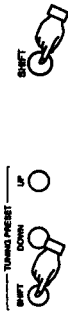

- 2 Watching the display, press the PRESET UP or DOWN button to select the desired preset channel.

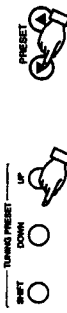

5-6 RDS (Radio Data System) (for AVR-950RD only)

RDS (works only on the FM band) is a broadcasting service which allows station to send additional information along with the regular radio program signal.

The following three types of RDS information can be received on this unit:

Program Type (PTY)

PTY identifies the type of RDS program. The program types and their displays are as follows:

NEWS	(News)	VARIED	(Varied)
AFFAIRS	(Current Affairs)	POP M	(Pop Music)
INFO	(Information)	ROCK M	(Rock Music)
SPORT	(Sports)	MOR M	(M.O.R. Music)
EDUCATE	(Education)	LIGHT M	(Light Classics)
DRAMA	(Drama)	CLASSICS	(Serious Classics)
CULTURE	(Culture)	OTHER M	(Other Music)
SCIENCE	(Science)		

Traffic Program (TP)

TP identifies programs that carry traffic announcements. This allows you to easily find out the latest traffic conditions in your area before you leaving home.

Radio Text (RT)

RT allows the RDS station to send text messages that appear on the display.

5-7 RDS search (for AVR-950RD only)

Use this function to automatically tune to FM stations that provide RDS service.

- 1 Set the input function to "TUNER".



- 2 Press the RDS button until "RDS SEARCH" appears on the display.



- 3 Press the PRESET UP or DOWN button to automatically begin the RDS search operation.



- 4 When a broadcast station is found, that station's name appears on the display.

- 5 To continue searching, repeat step 3. If no other RDS station is found when all the frequencies are searched, "NO RDS" is displayed.

If no RDS stations is found with above operation, all the respection band are searched.

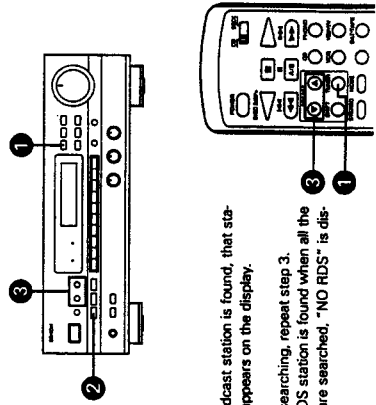

5-8 PTY search (for AVR-950RD only)

Use this function to find RDS stations broadcasting a designated program type (PTY). For a description of each program type, refer to "Program Type (PTY)".

- 1 Set the input function to "TUNER".
- 2 Press the RDS button until "PTY SEARCH" appears on the display.
- 3 Watching the display, press the PTY button to call out the desired program type.
- 4 Press the PRESET UP or DOWN button to automatically begin the PTY search operation.

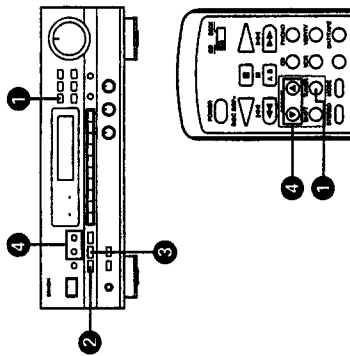

If there is no station broadcasting the designated programme type with above operation, all the reception bands are searched.

- 5 The station name is displayed on the display after searching stops.
- 6 To continue searching, repeat step 4. If no other station broadcasting the designated programme type is found when all the frequencies are searched, "NO PROGRAMME" is displayed on the display.

5-9 TP search (for AVR-950RD only)

Use this function to find RDS station broadcasting traffic programme (TP stations).

- 1 Set the input function to "TUNER".
 - 2 Press the RDS button until "TP SEARCH" appears on the display.
 - 3 Press the PRESET UP or DOWN button TP search begins.
- If no TP station is found with above operation, all the reception bands are searched.
- 4 The station name is displayed after searching stops.
 - 5 To continue searching, repeat step 3. If no other TP station is found when all the frequencies are searched, "NO PROGRAMME" is displayed.

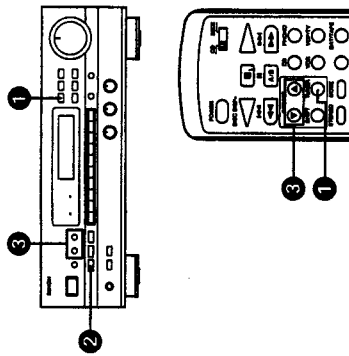

5-10 RT (Radio Txt) (for AVR-950RD only)

"RT" appears on the display when radio text data is received. When the RT button is pressed while receiving an RDS broadcast station, the text data broadcast from the station is displayed. To turn the display off, press the RT button again. If no text data is being broadcast, "NO TEXT DATA" is displayed.

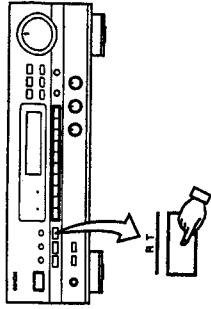

6 INITIALIZATION OF THE MICROPROCESSOR

When the indication of the MFD display is not normal or when the operation of the unit does not show the reasonable result, the initialization of the microprocessor is required by the following procedure.

- 1 Switch off the unit and remove the AC power cord from the wall outlet.
- 2 Hold the following TUNER button and VIDEO SELECT button, and plug the power cord into the outlet.
- 3 Check that the entire display is flashing with an interval of about 1 second, and release your fingers from the 2 buttons.
- 4 Switch on the unit and the microprocessor will be initialized.

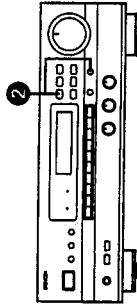

7 LAST FUNCTION MEMORY

- This receiver is equipped with a last function memory which stores the input and output setting conditions as they were immediately before the power is switched off. This function eliminates the need to perform complicated resettings when the power is switched on.
- This receiver is also equipped with a back-up memory. This function provides approximately one week of memory storage with the power cord disconnected.

8 TROUBLESHOOTING

If a problem should arise, first check the following:

1. Are the connections correct?
2. Have you operated the amplifier according to the Operating Instructions?
3. Are the speakers, turntable, and other components operating properly?

If the receiver is not operating properly, check the items listed in the table below. Should the problem persist, there may be a malfunction. Disconnect the power immediately and contact your store of purchase.

Symptom	Cause	Measures	Page
DISPLAY not lit and sound not produced when power switch is turned on.	<ul style="list-style-type: none"> Power cord not plugged in securely. 	<ul style="list-style-type: none"> Check the insertion of the power cord plug. 	4
DISPLAY lit but sound not produced.	<ul style="list-style-type: none"> Speaker cords not securely connected. Speaker switch is off. Improper position of the audio function button. Remote control set to minimum. MUTING is on. 	<ul style="list-style-type: none"> Connect securely. Turn on speaker switch. Set to a suitable position. Turn volume up to suitable level. Switch off MUTING. 	4, 5 6 6 6 6
-PROTECT- display appears.	<ul style="list-style-type: none"> Speaker terminals are short-circuited. Block the ventilation holes of the set. The unit is operating at continuous high power conditions and/or inadequate ventilation. 	<ul style="list-style-type: none"> Switch power off, connect speakers properly, then switch power back on. Turn off the set's power, then ventilate it well to cool it down. Once the set is cooled down, turn the power back on. Turn off the set's power, then ventilate it well to cool it down. Once the set is cooled down, turn the power back on. 	4
Sound produced only from one channel.	<ul style="list-style-type: none"> Incomplete connection of speaker cords. Incomplete connection of input/output cords. Left/right balance is off. 	<ul style="list-style-type: none"> Connect securely. Connect securely. Adjust balance knob properly. 	4 4, 5 6
Positions of instruments reversed during stereo playback.	<ul style="list-style-type: none"> Reverse connections of left and right speakers or left and right input/output cords. 	<ul style="list-style-type: none"> Check left and right connections. 	—
Sound seems distorted.	<ul style="list-style-type: none"> Rear level is too high. 	<ul style="list-style-type: none"> Set the rear level to lower level. 	7
Humming noise produced when record is playing.	<ul style="list-style-type: none"> Ground wire of turntable not connected properly. Incomplete PHONO jack connection. TV or radio transmission antenna nearby. 	<ul style="list-style-type: none"> Connect securely. Connect securely. Contact your store of purchase. 	4 4 —
Howling noise produced when volume is high.	<ul style="list-style-type: none"> Turntable and speaker systems too close together. Room is unstable and vibrates easily. 	<ul style="list-style-type: none"> Separate as much as possible. Use cushions to absorb speaker vibrations transmitted by floor. If turntable is not equipped with insulators, use audio insulators (commonly available). 	—
Sound is distorted.	<ul style="list-style-type: none"> Stylus pressure too weak. Dust or dirt on stylus. Cartridge defective. 	<ul style="list-style-type: none"> Apply proper stylus pressure. Check stylus. Replace cartridge. 	— — —
Volume is weak.	<ul style="list-style-type: none"> MC cartridge being used. 	<ul style="list-style-type: none"> Replace with MM cartridge or use a head amplifier or step-up transformer. 	4
Receiver does not operate properly when remote control unit is used.	<ul style="list-style-type: none"> Batteries dead. Remote control unit too far from receiver. Obstacle between receiver and remote control unit. Different button is being pressed. ⊕ and ⊖ ends of battery inserted in reverse. 	<ul style="list-style-type: none"> Replace with new batteries. Move closer. Remove obstacle. Press the proper button. Insert batteries properly. 	5 5 5 5

9 SPECIFICATION

- **Audio Section**
(Power amplifier)
Rated output: FRONT (main 2ch driven) [AVR-950RD] 80 W + 60 W 65 W + 65 W (8 Ω/ohms, 20 Hz - 20 kHz with 0.08% T.H.D.)
CENTER (center 1ch driven) 60 W 65 W (8 Ω/ohms, 20 Hz - 20 kHz with 0.08% T.H.D.)
REAR (rear 2ch driven) 15 W + 15 W 15 W + 15 W (8 Ω/ohms, 1 kHz with 0.3% T.H.D.)
Output terminals: Front: 8 to 16 Ω/ohms
Center: 8 to 16 Ω/ohms
Rear: 8 to 16 Ω/ohms
- **(Pre-amplifier)**
Line input (Each line input - FRONT SP OUT)
Input sensitivity / Impedance: 150 mV/47 kΩ/kohms PHONO (MM): 2.5 mV/47 kΩ/kohms
Frequency response: 10 Hz to 50 kHz: ± 3 dB
BASS: ± 10 dB at 100 Hz
TREBLE: ± 10 dB at 10 kHz
- **Signal-to-noise ratio:** 92 dB (STEREO)
Phono equalizer (PHONO input - REC OUT)
RIAA deviation: ± 10B (20 Hz to 20 kHz)
Signal-to-noise ratio: 74 dB (A weighting, with 5 mV input)
Rated output / Maximum output: 150 mV/8 V
Distortion factor: 0.03% (1 kHz, 1 V)
- **Tuner Section**
Receiving Range: [FM] (note: μV at 75 Ω/ohms, 0 dBf = 1 × 10⁻¹⁵ W) 87.50 MHz ~ 108.00 MHz 522 kHz ~ 1611 kHz
Usable Sensitivity: 1.0 μV (11.2 dB)
50 dB Quieting Sensitivity: MONO 1.6 μV (15.3 dB) STEREO 23 μV (38.5 dB)
Signal to Noise Ratio (HF-A): MONO 80 dB STEREO 75 dB
Total Harmonic Distortion (at 1 kHz): MONO 0.4% STEREO 0.5%
- **Video Section**
Standard video jacks
Input and output level / impedance: 1 Vp-p/75 Ω/ohms
Frequency response: 2 Hz to 8 MHz +0, -3 dB
- **General**
Power supply: AC 230 V, 50 Hz
Power consumption: 200 W (AVR-900) 220 W (AVR-950RD)
Maximum external dimensions: 434 (W) × 142 (H) × 303 (D) mm (17-3/32" × 5-19/32" × 11-15/16")
Weight: 7.7 kg (17 lbs)
- **Remote control unit**
System remote control amplifier or step-up transformer: RC-195:
Total buttons: 28
DENON system code
CD player: 6 buttons (SWITCHED)
Cassette deck: 6 buttons
Batteries: R6P/AA Type (two batteries) AVR-900/950RD fixed codes: 22 buttons
51 (W) × 175 (H) × 18.5 (D) mm (2" × 6-57/64" × 47/64")
Weight: 100 g (Approx. 3.5 oz) (including batteries)

* For purposes of improvement, specifications and design are subject to change without notice.

PARTS LIST OF P. W. BOARD



Note. Refer to the service manual of AVR-900 for parts list of P.W.Board as the following.

Part Name	Part No.	Reference Page
Main Amp.	1U-2865	Page 24-25
Input & Surround	1U-2867	Page 26-27
Tuner & Volume	1U-2889	Page 27-28
FLD & Video	1U-2883	Page 29
Rear Amp.	1U-2866	Page 30

1U-2865D MAIN AMP P.W.B. UNIT ASS'Y
 (Same as 1U-2865 except the following.)

Ref. No.	Part No.	Part Name	Remarks
SEMICONDUCTORS GROUP			
IC911	262 1701 906	IC :SAA6579T	Add
IC912	262 1929 908	IC LC7074M-TE-R	Add
D911	276 0616 907	Diode 1SS252	Add
RESISTORS GROUP			
R375	241 2398 984	Carbon 1.3kohm 1/4W	Change
CAPACITORS GROUP			
C351,352	254 6200 003	Electrolytic 10000 μ F/56V	Change
C428	255 1264 982	Film 0.0047 μ F/50V	Add
C911,912	253 4537 908	Ceramic 27pF/50V	Add
C913	254 4254 909	Electrolytic 10 μ F/16V	Add
C914	254 4260 951	Electrolytic 2.2 μ F/50V	Add
C915	253 1179 990	Ceramic 560pF/50V	Add
C918	254 4254 909	Electrolytic 10 μ F/16V	Add
C919	253 1181 904	Ceramic 0.01 μ F/50V	Add
OTHERS PARTS GROUP			
XT911	399 0178 007	Crystal (4.332MHz)	Add
XT912	399 0261 901	CO.DCRHTP4.00M	Add
CN14A	205 0375 042	14P Connector Base (KR-PH)	Change

1U-2866A REAR AMP P.W.B. UNIT ASS'Y
 (Same as 1U-2866 except the following.)

Ref. No.	Part No.	Part Name	Remarks
SEMICONDUCTORS GROUP			
IC501,502	263 0855 005	IC :SI-18725	Change
RESISTORS GROUP			
 R557	242 0073 000	Metallic 2.2Mohm 1/2W	Delete
CAPACITORS GROUP			
C361-364	255 1265 907	Film 6800pF/50V	Add
C513,514	255 1264 982	Film 4700pF/50V	Add
C517,518	254 4257 713	Electrolytic 3300 μ F/35V	Change
C531,532	253 1179 903	Ceramic 100pF/50V	Change
C559	253 8014 702	Film 0.1 μ F/400V	Change
OTHERS PARTS GROUP			
	203 0640 001	1P SIN Cord Ass'y	Delete
	203 0640 014	1P SIN Cord Ass'y	Delete
	203 3841 008	AC Outlet (2P)	Delete
	205 0606 025	2P Wrapping Terminal	Add
F011,012	206 1076 000	Fuse 5.0A	Delete
F001	206 1076 026	Fuse 8.0A	Delete
F002	206 1075 056	Fuse 3.15A	Change
	233 8058 012	Power Trans	Change
	415 0299 000	Condenser Cover	Add

1U-2867A INPUT & SURROUND P.W.B. UNIT ASS'Y
(Same as 1U-2867 except the following.)

Ref. No.	Part No.	Part Name	Remarks
SEMICONDUCTORS GROUP			
IC101	263 0896 909	IC NJM2068MD	Change
RESISTORS GROUP			
J101,102	241 2400 911	Carbon 4.7kohm 1/4W	Add
CAPACITORS GROUP			
C105,106	257 0004 961	Ceramic 100pF/50V (Chip)	Add
C121~128	257 0004 903	Ceramic 56pF/50V (Chip)	Add
C147,148	257 0004 961	Ceramic 100pF/50V (Chip)	Add
C281,282	255 1264 908	Film 0.001 μ F/50V	Add
OTHERS PARTS GROUP			
LF101,102	235 9003 002	FTZ Choke Coil	Add

1U-2883E FLD & VIDEO P.W.B. UNIT ASS'Y
(Same as 1U-2883 except the following.)

Ref. No.	Part No.	Part Name	Remarks
RESISTORS GROUP			
R706	241 2399 967	Carbon 3kohm 1/4W	Add
JV83	241 2398 955	Carbon 1kohm 1/4W	Add
OTHERS PARTS GROUP			
SW705~707	212 4788 002	Tact Switch	Add
CN14A	204 6554 000	14P PH-SAN Connector Cord	Change

1U-2889D TUNER & VOLUME P.W.B. UNIT ASS'Y
(Same as 1U-2889 except the following.)

Ref. No.	Part No.	Part Name	Remarks
SEMICONDUCTORS GROUP			
IC004	261 0079 005	IC FM Front End (U)	Change
TR001	275 0051 909	Transistor 2SK161(GR)	Add
RESISTORS GROUP			
R002	241 2400 937	Carbon 5.6kohm 1/4W	Add
R004	241 2400 995	Carbon 10kohm 1/4W	Add
R005	241 2397 969	Carbon 390kohm 1/4W	Change
R006	241 2397 943	Carbon 330kohm 1/4W	Add
R022	241 2402 935	Carbon 39kohm 1/4W	Change
R023	241 2399 909	Carbon 1.6kohm 1/4W	Add
R032	241 2403 989	Carbon 160kohm 1/4W	Add
R035	241 2403 989	Carbon 160kohm 1/4W	Add
R037,038	241 2403 934	Carbon 100kohm 1/4W	Change
R039,040	241 2399 912	Carbon 1.8kohm 1/4W	Change
R041,042	241 2399 970	Carbon 3.3kohm 1/4W	Change
R050	241 2396 928	Carbon 1kohm 1/4W	Add
CAPACITORS GROUP			
C006	253 1181 904	Ceramic 0.01 μ F/50V	Add
C023	253 4538 949	Ceramic 100pF/50V	Delete
C026	254 4254 912	Electrolytic 22 μ F/16V	Add
C053,054	253 4448 903	Ceramic 330pF/50V	Change
C055	253 4538 965	Ceramic 120pF/50V	Add
C266	253 1180 934	Ceramic 1200pF/50V	Change
OTHERS PARTS GROUP			
LF001	232 9010 009	Anti Birdie Filter	Add
LF002,003	232 0085 004	:LPF	Add
CF001	261 0146 006	FMCFSK107M2-A	Change

PRINTED WIRING BOARD

1 2 3 4 5 6 7 8

1U-2867 A INPUT AND SURROUND P.W.B. ASS'Y

IC101	○
J101, 102	○
C105, 106	○
C121-128	○
C147, 148	○
C281, 282	○
LF101, 102	○

Note:
○ : Used
X : Not used

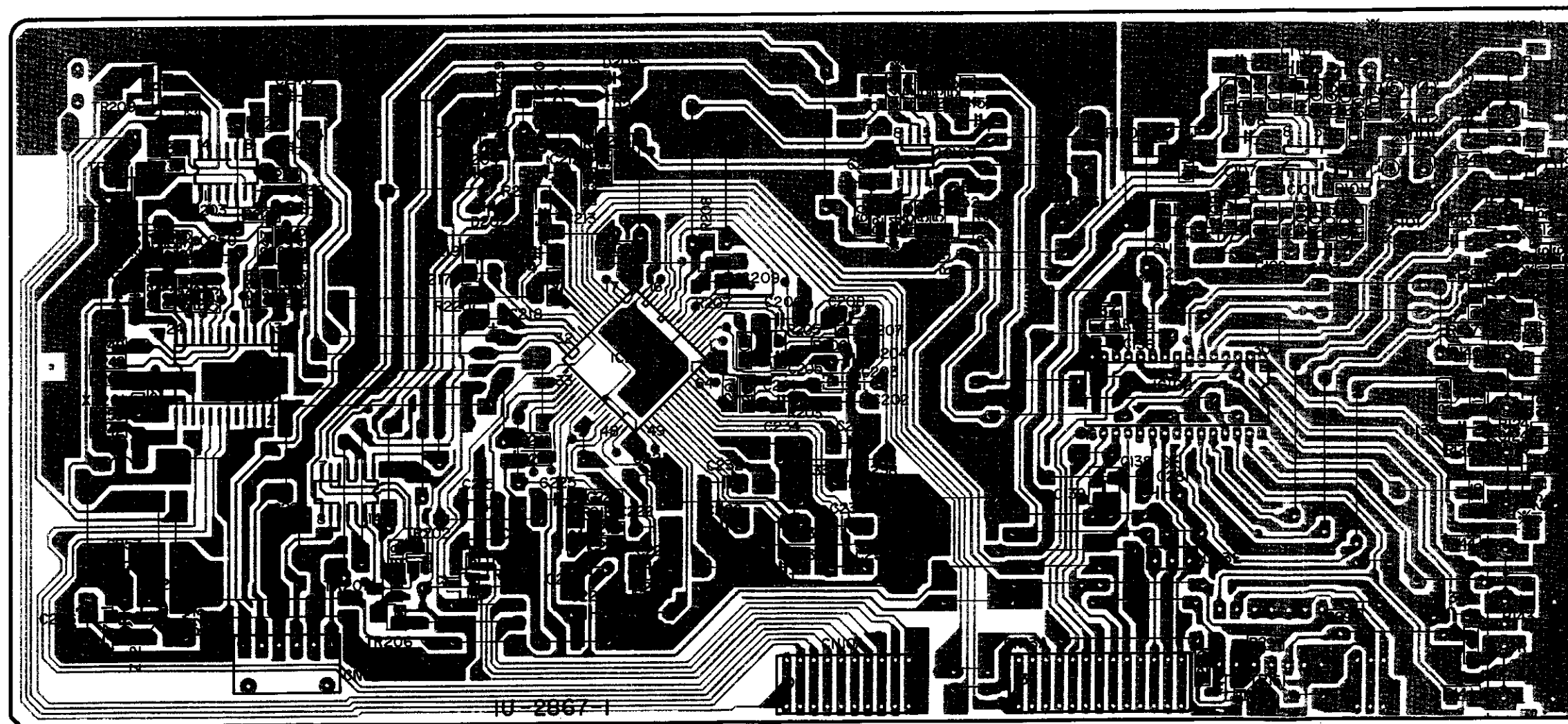

A
B
C
D
E

1 2 3 4 5 6 7 8

1U-2865 D MAIN AMP. P.W.B. UNIT ASS'Y

IC911, 912	○
D911	○
C428	○
C911~915	○
C918, 919	○
XT911, 912	○

Note:
○ : Used
X : Not used

A
B
C
D
E

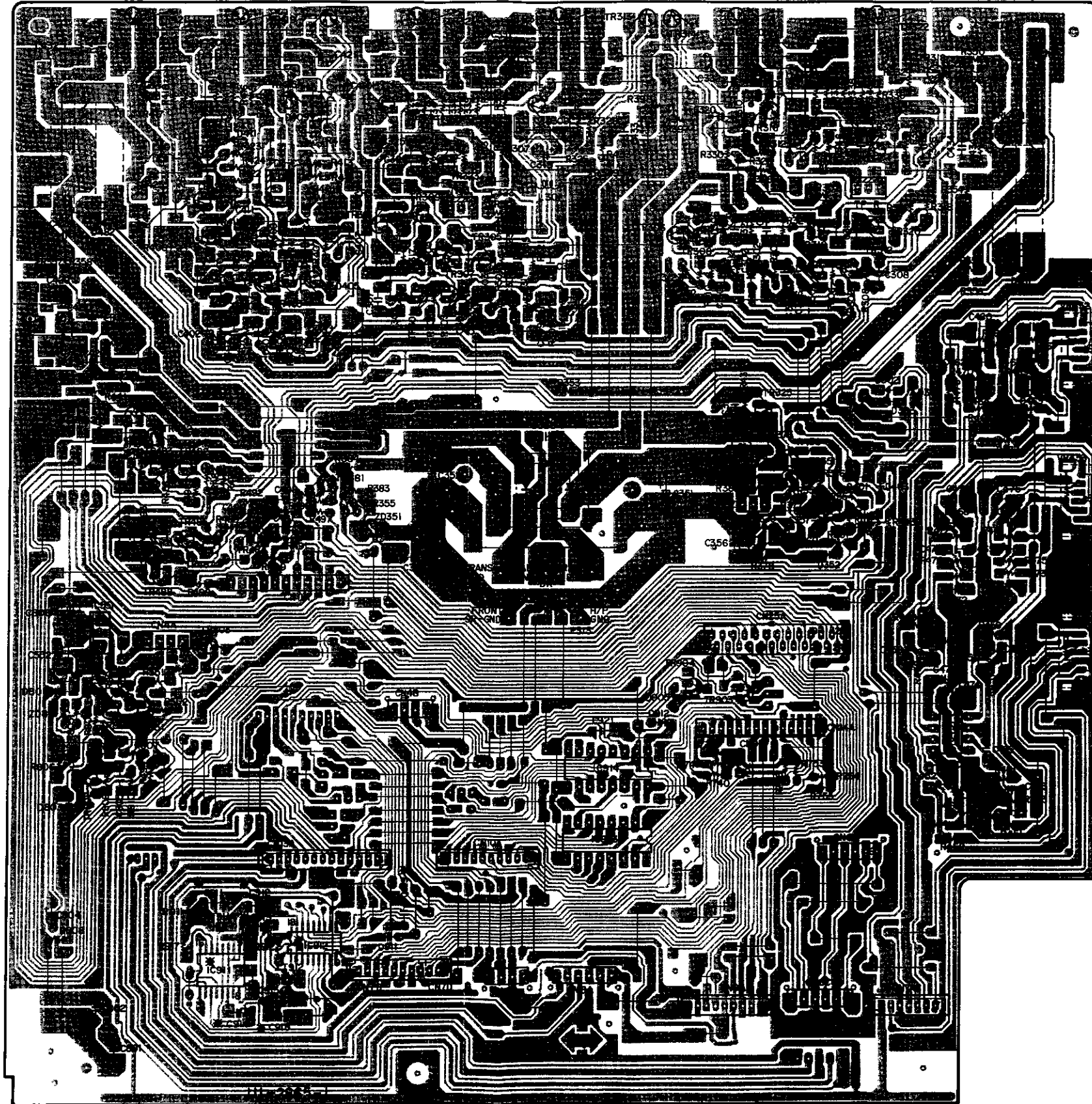

1 2 3 4 5 6 7 8

1U-2866 A REAR AMP. P.W.B. UNIT ASS'Y

1U-2866 A

R557	X
C361-364	O
C513, 514	O
C531, 532	O
F011, 012	X
F001	X
AC outlet	X

Note:
O : Used
X : Not used

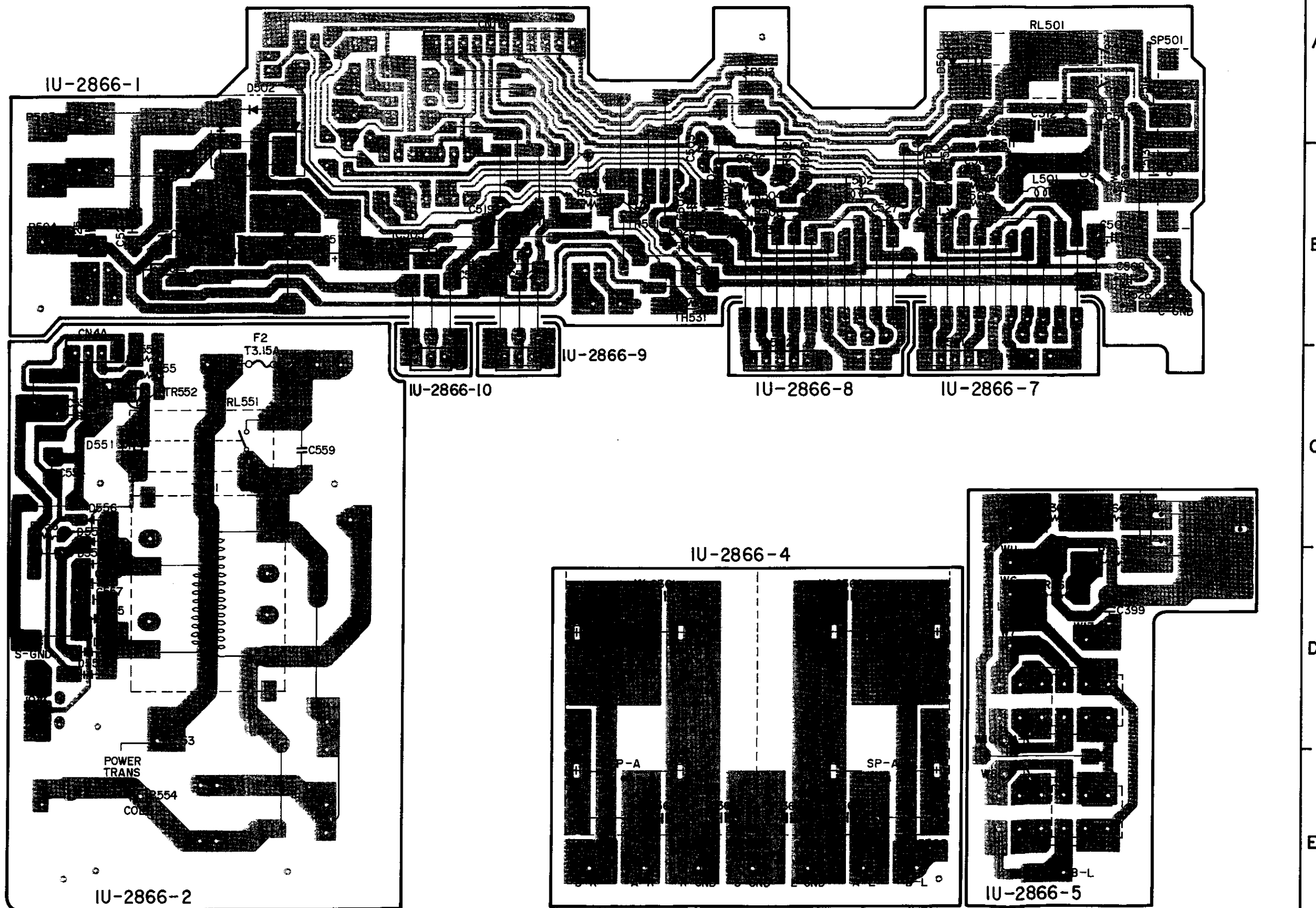

1 2 3 4 5 6 7 8

1U-2889 D TUNER AND VOLUME P.W.B. UNIT ASS'Y

TR001	○
R023	○
R032	○
R035	○
C055	○
LF001	○
LF002	○
LF003	○

Note:
 ○ : Used
 X : Not used

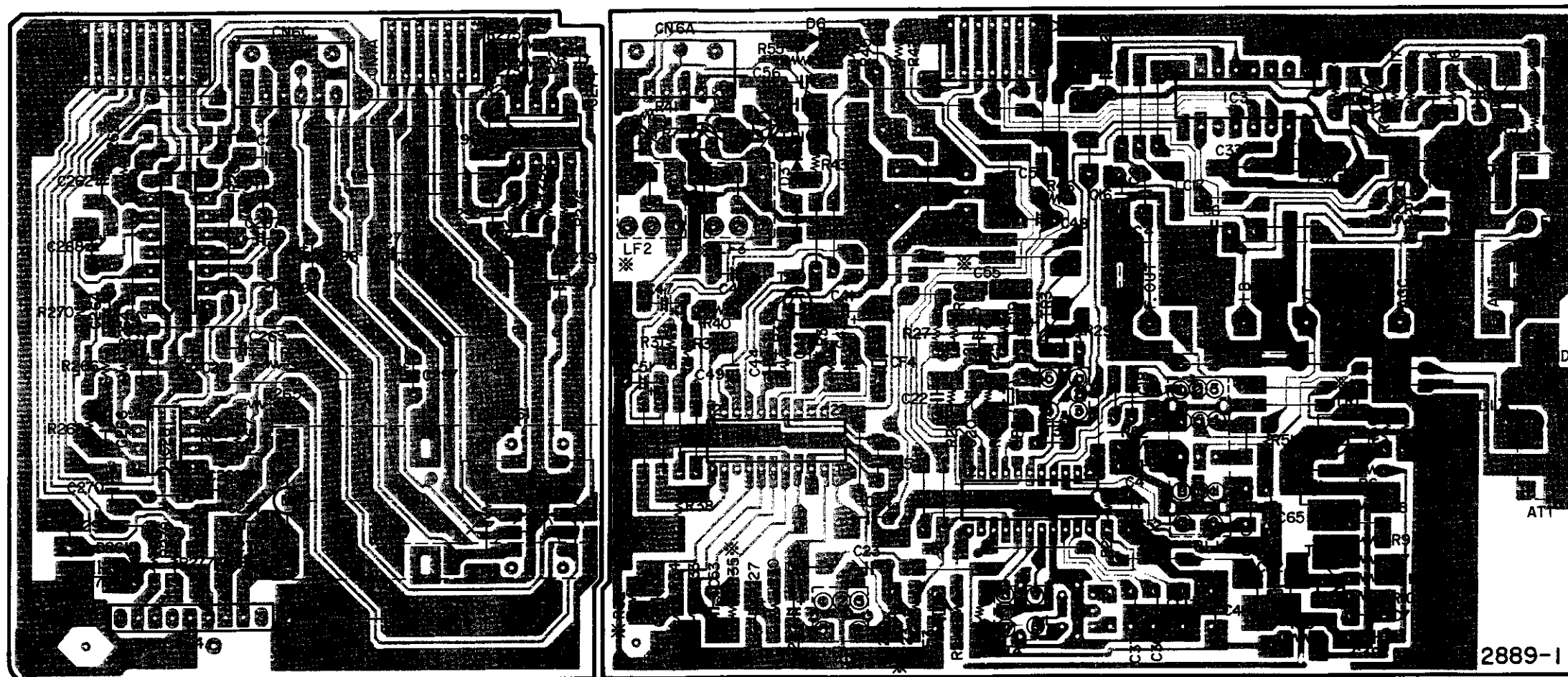

A
B
C
D
E

1 2 3 4 5 6 7 8

1U-2883 E FLD AND VIDEO P.W.B. UNIT ASS'Y

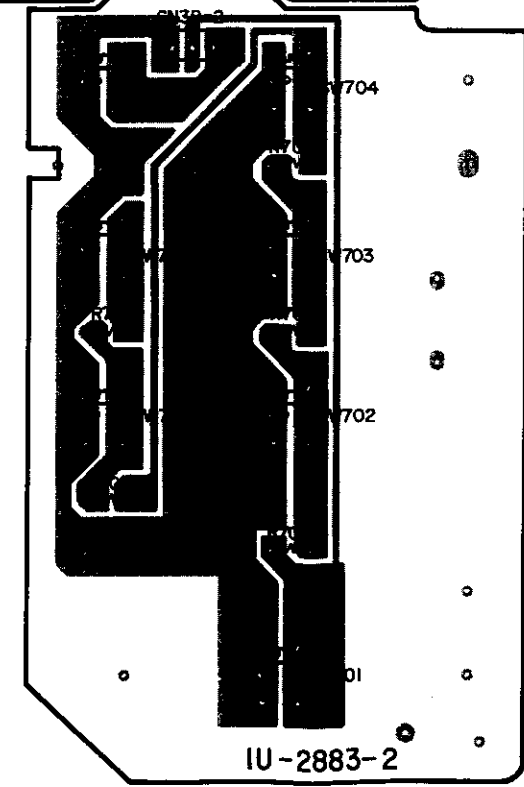
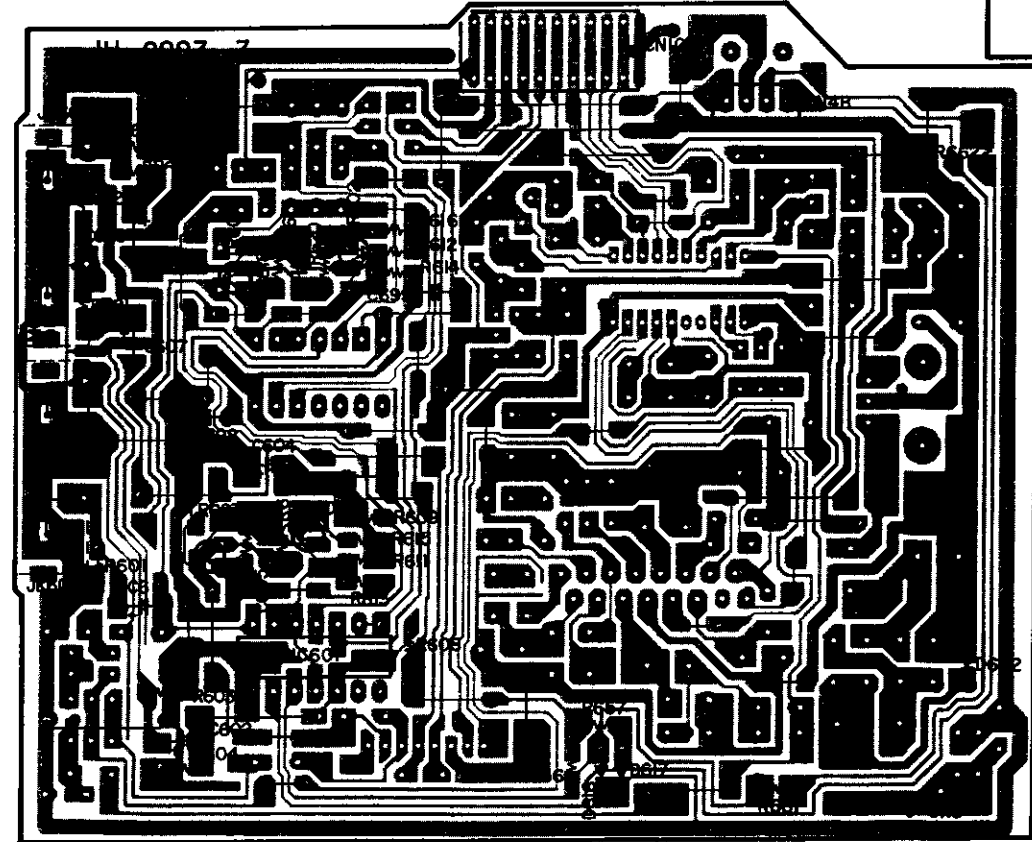
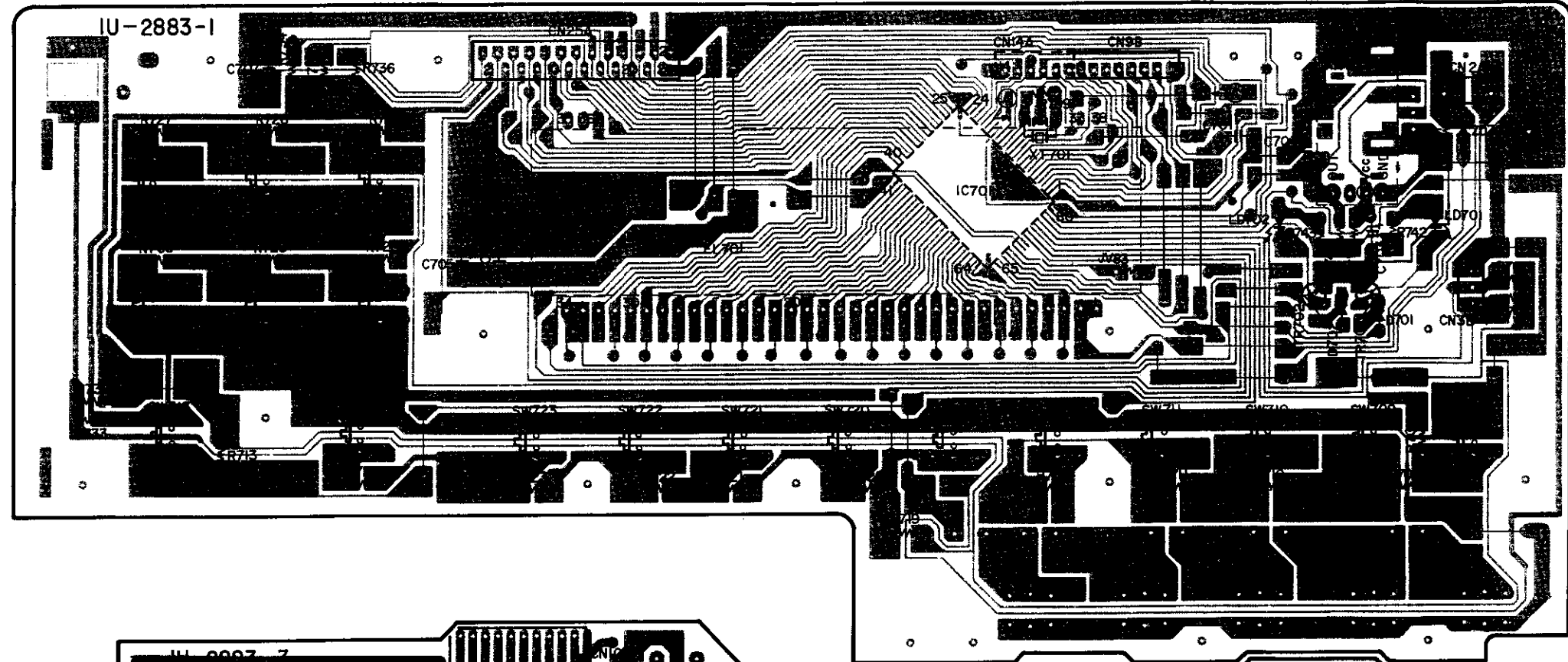

A
B
C
D
E

EXPLODED VIEW

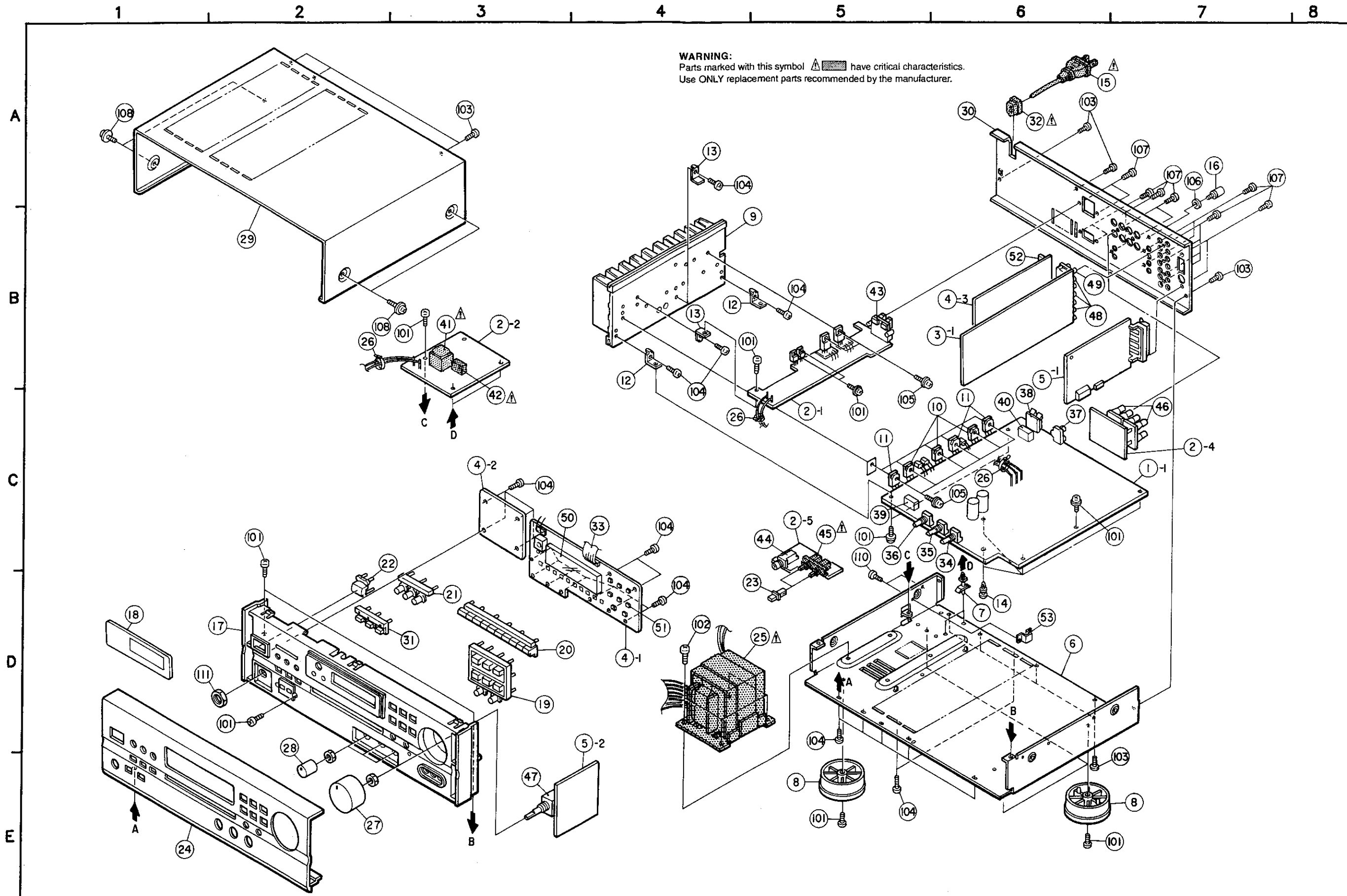

WARNING:
Parts marked with this symbol  have critical characteristics.
Use ONLY replacement parts recommended by the manufacturer.

PARTS LIST OF EXPLODED VIEW

Ref. No.	Part No.	Part Name	Remarks	Q'ty	Ref. No.	Part No.	Part Name	Remarks	Q'ty
① 1	1U-2865 D	Main Amp. P.W.B. Unit Ass'y		1	46	205 0952 009	4P Speaker Terminal		2
1-1	—	Main Amp. P.W.B. Unit			47	211 0858 001	Variable Resistor 100kohm	VR261	1
① 2	1U-2866 A	Rear Amp. P.W.B. Unit Ass'y		1	48	204 8497 000	4P Pin Jack (GND)(K)	JK101~103	3
2-1	—	Rear Amp. P.W.B. Unit			49	204 8509 008	2P Pin Jack (C-GND)	JK104	1
2-2	—	Power Supply P.W.B. Unit			50	393 4155 002	FLD (FIP14AM7R)	FL701	1
2-4	—	Front SP. P.W.B. Unit			51	212 4788 002	Tact Switch	SW701~704, 708~713, 719~730	25
2-5	—	H/P and SP. P.W.B. Unit			52	204 8468 000	2P Pin Jack	JK601,602	2
① 3	1U-2867 A	Input and Surround P.W.B. Unit Ass'y		1	53	412 2955 107	Side Bracket		1
3-1	—	Input and Surround P.W.B. Unit			★	513 2236 006	Label		
① 4	1U-2883 E	FLD and Video P.W.B. Unit Ass'y		1	SCRWES				
4-1	—	FLD P.W.B. Unit			101	473 7002 018	Screw 3x8 (S)		14
4-2	—	Tact S.W P.W.B. Unit			102	473 7004 016	Screw 4x6 (S)		4
4-3	—	Video P.W.B. Unit			103	473 7015 018	Screw 3x8 (S) BK		10
① 5	1U-2889 D	Tuner and Volume P.W.B. Unit Ass'y		1	104	473 7500 044	Screw 3x8 (P) BK		33
5-1	—	Tuner P.W.B. Unit			105	473 8007 009	Screw 3x12 cup		8
5-2	—	Volume P.W.B. Unit			106	477 0018 001	Washer(P-87)		1
① 6	411 1334 108	Main Chassis		1	107	477 0064 107	Fixing Screw		17
① 7	443 0518 016	P.W.B. Holder		2	108	477 0263 005	3P Swelling Screw		4
8	104 0282 007	*Foot Ass'y		4	109	477 0096 007	Push Rivet	Europe Model	8
9	417 0513 009	*Power Radiator		1	110	473 7015 005	Screw 3x6 (S)		2
10	273 0389 002	2SC3855(O/P/Y)(Z)		3	111	475 6124 003	12 Nut		1
11	271 0240 006	2SA1491(O/P/Y)(Z)		3	PACKING & ACCESSORIES				
12	412 4000 005	*P.W.B. Bracket(A)		2	Ref. No.	Part No.	Part Name	Remarks	Q'ty
13	412 3766 007	*L Bracket		2		231 0922 009	AM Lope Antenne		1
14	412 2814 002	Card Spacer (L=8)		4		394 0038 003	Battery (GER6M)		2
△ 15	208 2063 009	AC Cord With Plug	Europe Model	1		395 0023 008	:FM Antenne Ass'y		1
△ 15	206 2132 008	AC Cord With Plug	U.K. Model	1		399 0292 006	Remoto Control Unit	RC195	1
16	205 0071 016	Terminal Ass'y		1		501 1887 013	Carton Case		1
① 17	146 1574 103	Inner Panel		1		503 1190 007	Cushion		2
① 18	143 0942 009	Window		1		504 0092 086	Stylen Paper	(700x600xT1)	1
19	113 1753 005	Tact Knob (A)		1		504 0168 004	AC Protect Sheet	U.K. Model	1
20	113 1692 001	*Function Knob		1		505 0075 006	Cabinet Cover	(750x350)	1
21	113 1743 002	Tact Knob (3 Key)		1		505 8006 019	Envelope		1
22	113 1636 106	*Push Knob (P)		1		511 2800 009	Instructions Manual		1
23	113 1558 006	Push Knob (KAKU)		2		513 1349 004	Thermal Carbon Film		1
① 24	144 2451 012	Front Panel		1		513 1389 006	Control Card Base		1
△ 25	253 0178 002	Power Trans		1		515 0671 229	S.S. List		1
26	445 8004 007	Wire Clamper		5		513 2446 003	China Label (E)	Europe Model	
27	112 0761 008	*Volume Knob		1		513 2447 002	China Label (F)	Europe Model	
28	112 0762 007	*Knob		3					
① 29	102 0565 003	Top Cover		1					
30	105 1167 111	Back Panel		1					
★ 31	113 1759 009	Tact Knob (13x5)-3		1					
△ 32	445 0056 006	Cord Bush		1					
33	009 0105 012	25P FFC Cable		1					
34	211 0798 103	Variable Resistor 100kohm	VR451	1					
35	211 0797 117	Variable Resistor 30kohm	VR452	1					
36	211 0797 133	Variable RESISTOR 10kohm	VR453	1					
37	204 8509 011	2P Pin Jack (C-GND)	JK301	1					
38	205 0971 006	2P Push Terminal	SP003	1					
39	214 0129 001	Relay (DH2TU)	RL481	1					
40	214 0187 001	Relay (DH24D2-OS(M)-2)	RL482	1					
△ 41	233 6058 012	Power Trans (Mini)		1					
△ 42	214 0186 000	Relay (VS-12MBNFI-SM2)(TV-B)	RL551	1					
43	205 0972 005	4P Push Terminal		1					
44	204 8503 004	:Headphone Jack		1					
△ 45	212 4778 009	2P Push Switch	SW001	1					

MEMO:

SCHEMATIC DIAGRAM

1

2

3

4

5

6

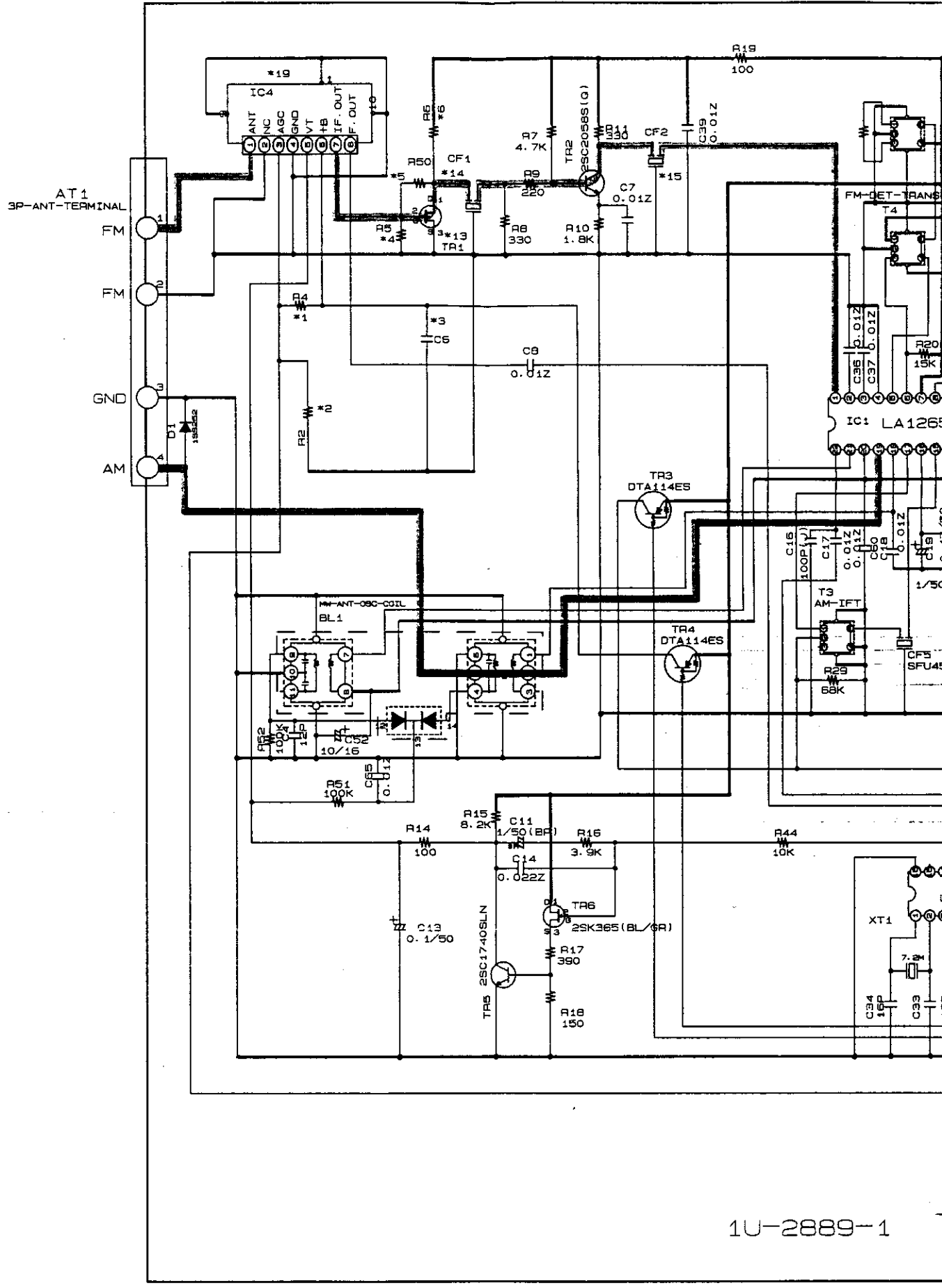

1U-2889-1

		900E3	900E1	900E2/EK
*1	R4	---	---	10K
2	R2	---	---	5.6K
3	C6	---	---	CK0.01
4	R5	1K	1K	390
5	R50	100	100	---
6	R6	---	---	330
7	R23	JUMPER	JUMPER	1.6K
8	R32, 35	100K	100K	160K
9	C53, 54	CC750P	CC750P	CC330P
10	R33, 34	120K	120K	200K
11	C23	CC100P	CC100P	---
12	R41, 42	6.8K	6.8K	4.7K
13	TR1	---	---	2SK161
14	CF1	CFSK107M1-A	CFSK107M1-A	CFSK107M2-A
15	CF2	CFSK107M2-A	CFSK107M2-A	CFSK107M2-A
16	C26	---	---	22/16
17	LF1	---	---	ANTI-BIRDIE FILTER
18	LF2, 3	---	---	LFP
19	IC4	F/E 2160102008	F/E 2160102008	F/E 2160079005
20	J4, 5, 6	JUMPER	JUMPER	---
21	R22	18K	39K	39K
22	LF4	---	---	2329010009
23	C55	---	---	CC120P

6 7 8 9 10 11

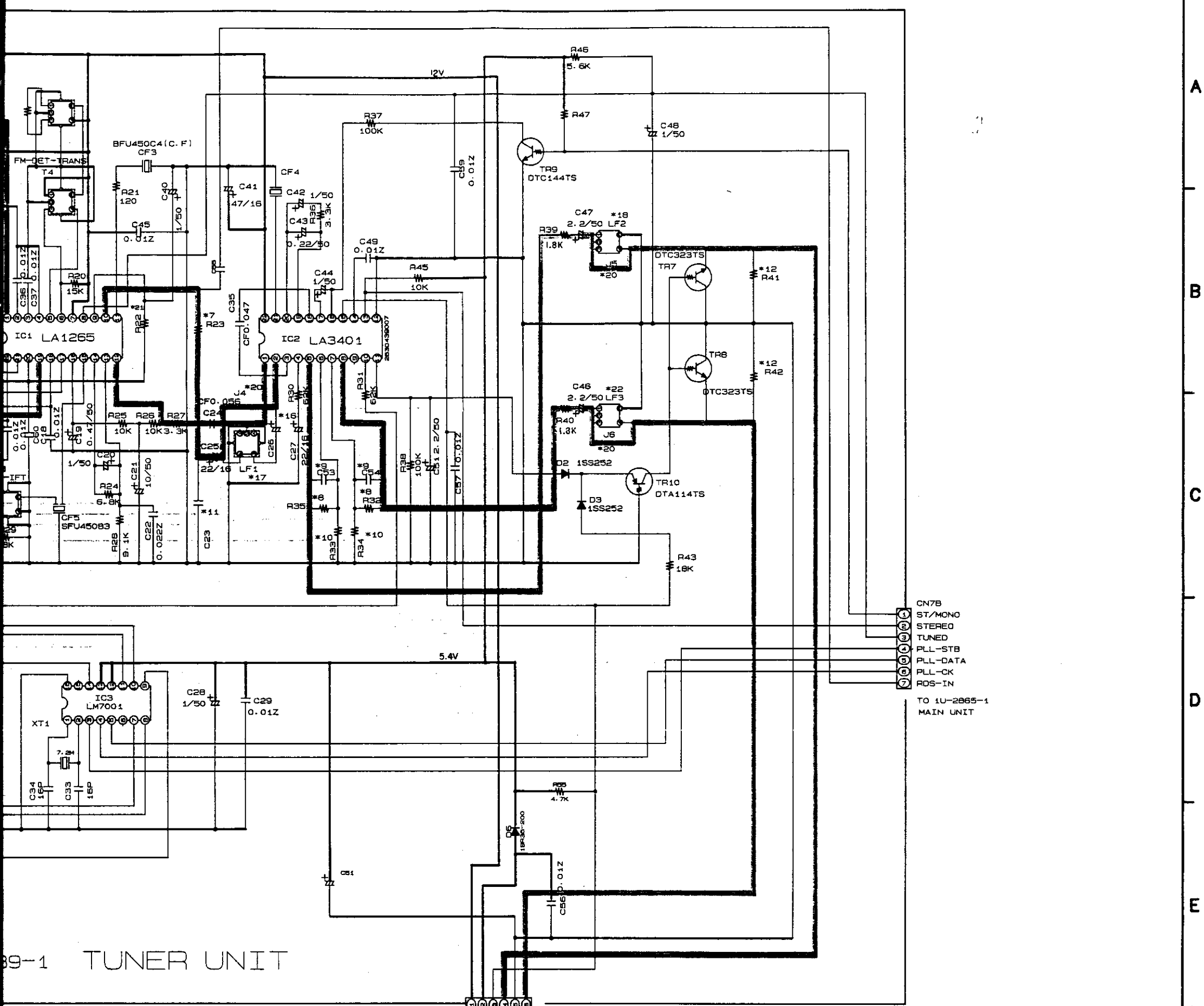

89-1 TUNER UNIT

900E2/EK	950RDE2/EK
K	10K
6K	5.6K
0.01	CK0.01
30	390
30	330
6K	1.2K
10K	100K
330P	CC330P
200K	200K
7K	4.7K
2K161	25K161
FSK107M2-A	CFSK107M2-A
FSK107M2-A	CFSK107M2-A
1/16	22/16
ANTI-BIRDIE FILTER	ANTI-BIRDIE FILTER
F	LPF
F/E	F/E
160079005	2160065006
39K	39K
229010009	2329010009
CCI20P	CC120P

12V
5V
TU-MUTE
J
GND
CN5A
TO 1U-2865-1
MAIN UNIT

— +B LINE
— SIGNAL LINE

NOTES
ALL RESISTANCE VALUES IN OHM. K=1,000 OHM, M=1,000,000 OHM
ALL CAPACITANCE VALUES IN MICRO FARAD. P=MICRO-MICRO FARAD
EACH VOLTAGE AND CURRENT ARE MEASURED AT NO SIGNAL INPUT CONDITION.
CIRCUIT AND PARTS ARE SUBJECT TO CHANGE WITHOUT PRIOR NOTICE.

WARNING:
Parts marked with this symbol have critical characteristics. Use ONLY replacement parts recommended by the manufacturer.

CAUTION:
Before returning the unit to the customer, make sure you make either (1) a leakage current check or (2) a line to chassis resistance check. If the leakage current exceeds 0.5 millamps, or if the resistance from chassis to either side of the power cord is less than 240 kohms, the unit is defective.

WARNING:
DO NOT return the unit to the customer until the problem is located and corrected.

A
B
C
D
E
F
G
H

SCHEMATIC DIAGRAM

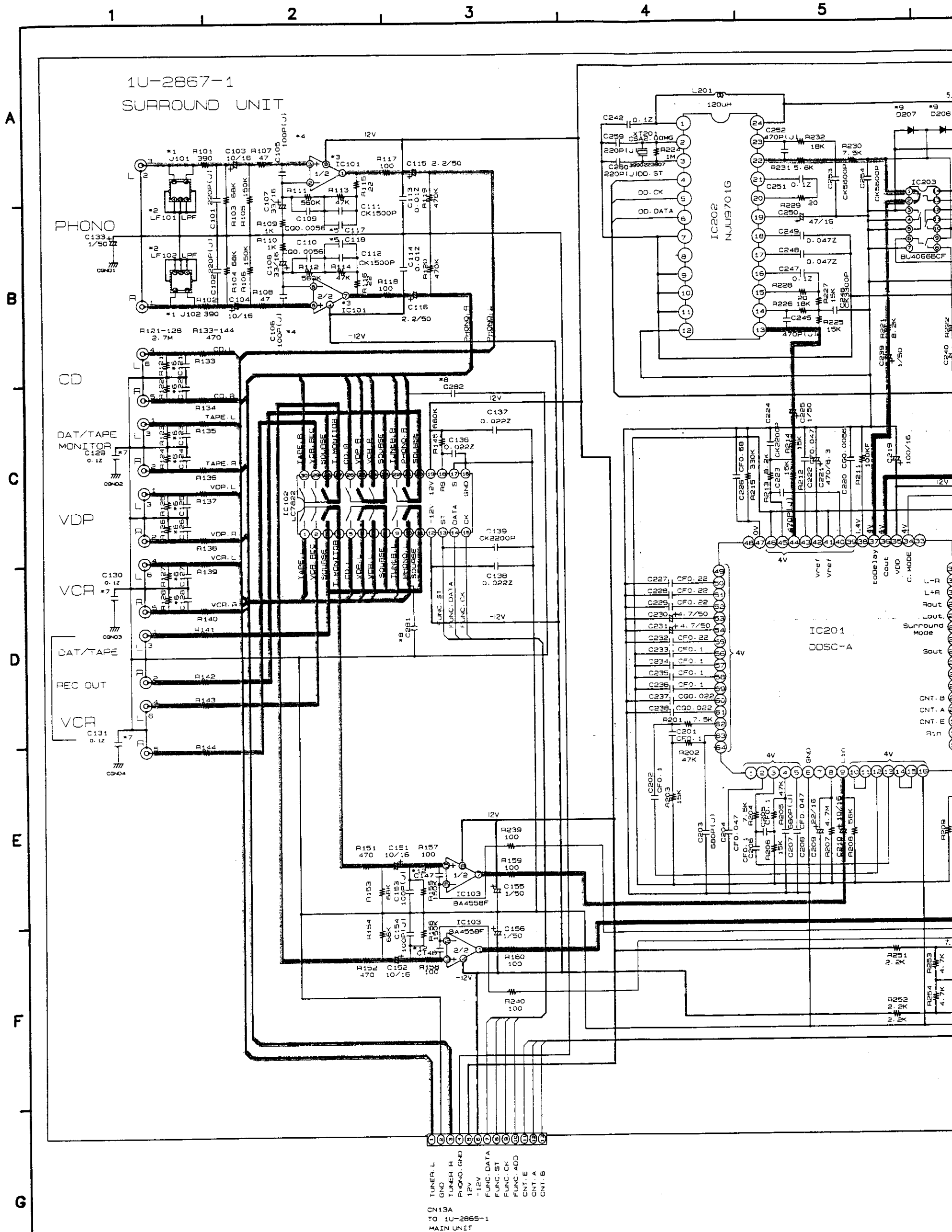

NOTES
 ALL RESISTANCE VALUES IN OHM. K=1,000 OHM, M=1,000,000 OHM
 ALL CAPACITANCE VALUES IN MICRO FARAD. P=MICRO-MICRO FARAD
 EACH VOLTAGE AND CURRENT ARE MEASURED AT NO SIGNAL INPUT CONDITION.
 CIRCUIT AND PARTS ARE SUBJECT TO CHANGE WITHOUT PRIOR NOTICE.

WARNING:
 Parts marked with this symbol have critical characteristics. Use ONLY replacement parts recommended by the manufacturer.

CAUTION:
 Before returning the unit to the customer, make sure you make either (1) a leakage current check or (2) a line to chassis resistance check. If the leakage current exceeds 0.5 milliamps, or if the resistance from chassis to either side of the power cord is less than 240 kohms, the unit is defective.

WARNING:
 DO NOT return the unit to the customer until the problem is located and corrected.

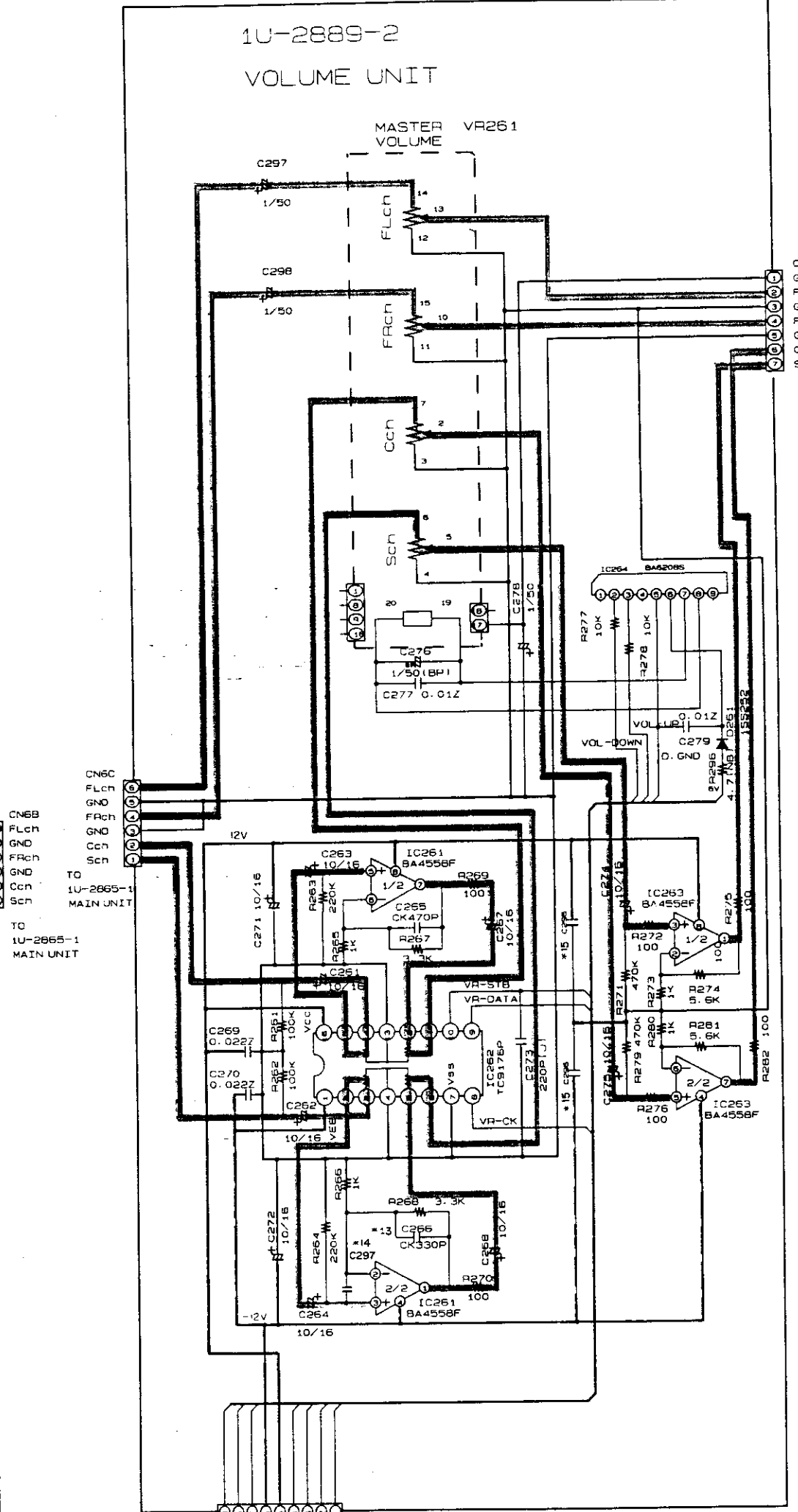
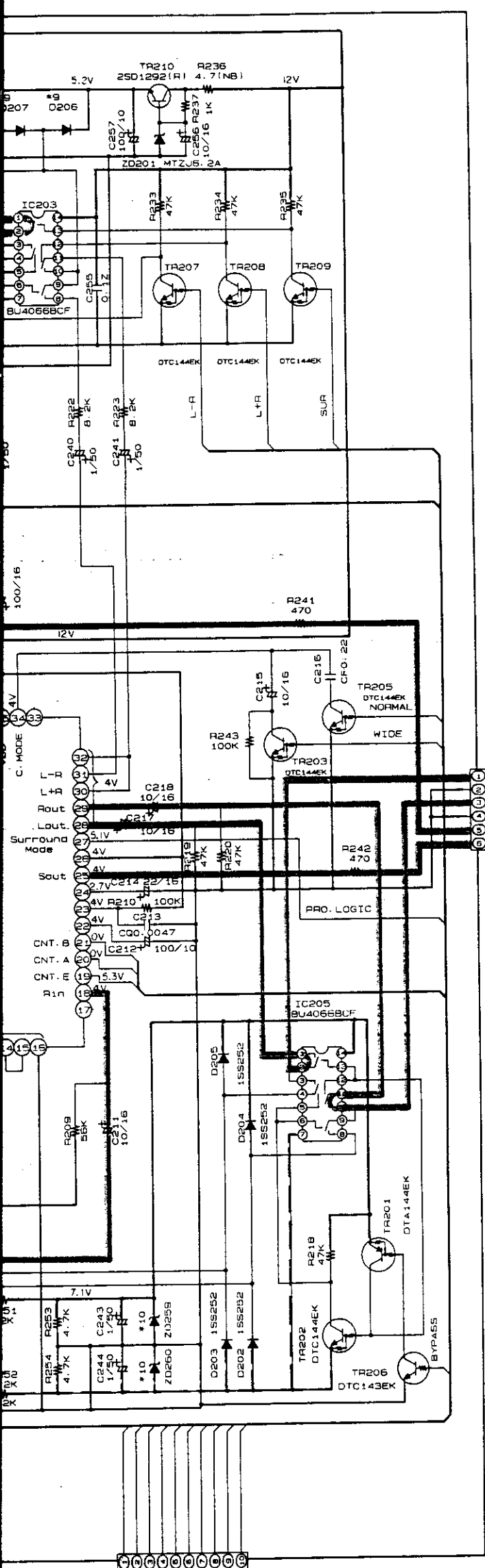

BYPASS
 PRO. LOGIC
 NORMAL
 WIDE
 DD. DATA
 DD. CK
 DD. ST
 SUR
 L+R
 L-R
 CN10A
 TO 1U-2865-1
 MAIN UNIT

	*1	*2	*3	*4	*5	*6	*7	*8	*9	*10	*11	*12	*13	*14	*15
	J101 J102	LF101 LF102	IC101	C105 C106	C117 C118	C121-128	C129-131	C281 C282	D206 D207	ZD259 ZD260	CN3C	C147 C148	C266	C297	C295 C296
900 E3	JW		BA4558F												
900 E2/EK/E1	4.7K	FTZ-COIL	NJM-2068MD	100P		CC560		C00.001				1000	CK330P		47p
950RD E2/EK	4.7K	FTZ-COIL	NJM-2068MD	100P		CC56p		C00.001				100p	CK1200P		47p

VR-DATA
 VR-STB
 VR-CK
 -12V
 12V
 VOL-DOWN
 VOL-UP
 5V
 D. GND
 CN5A
 TO 1U-2865-1
 MAIN UNIT

+B LINE
 -B LINE
 SIGNAL LINE

SCHEMATIC DIAGRAM

1 | 2 | 3 | 4 | 5 | 6

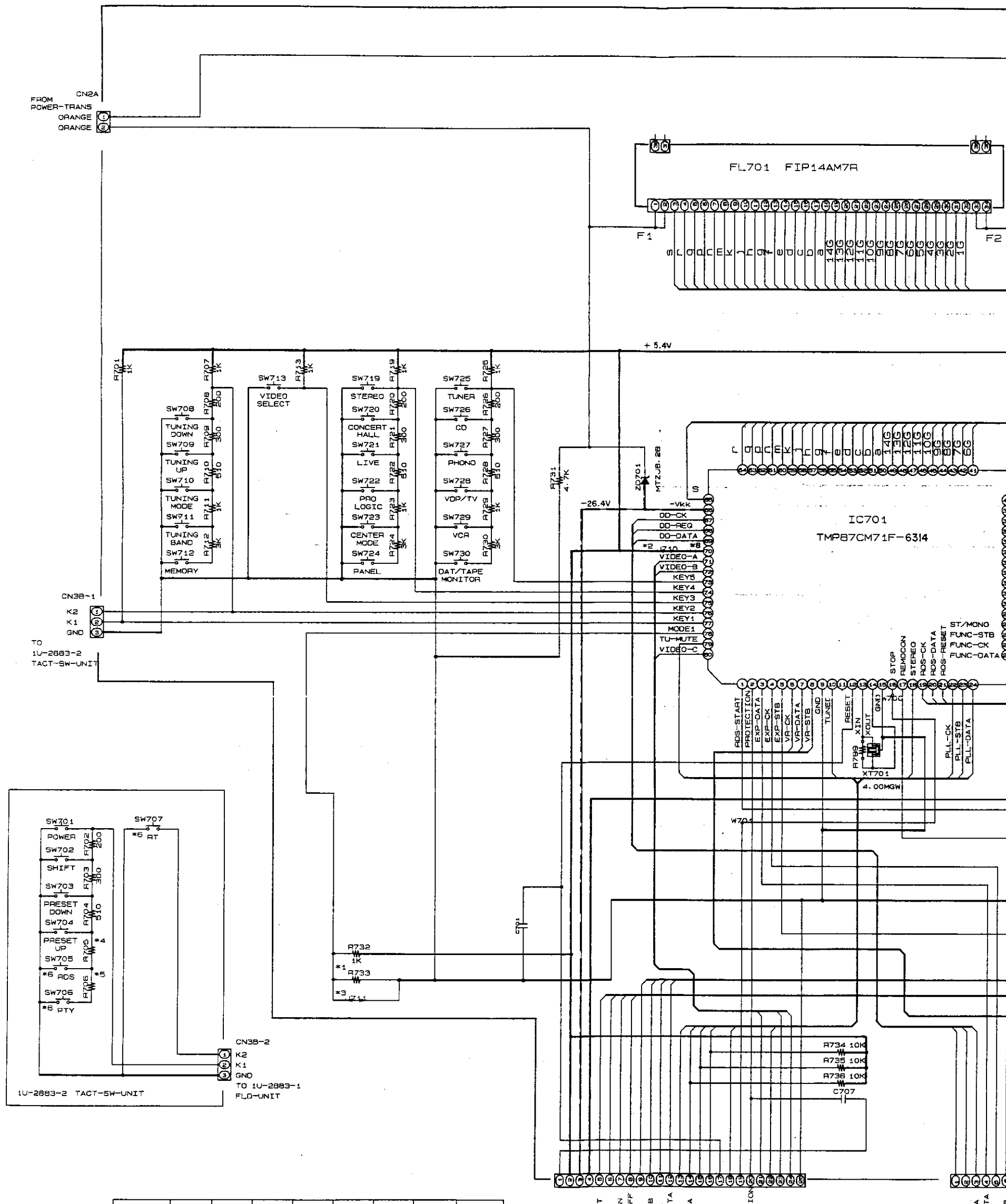

	*1	*2-RDS	*3	*4	*5	*6	*7	*8
900E3	R733	J710	J711	R705	R706	SW705-7	CN9B	JV83
900E2/EK/E1	200ohm	-	-	-	-	-	0	-
900E1T	200ohm	-	cut	-	-	-	0	-
950RD E2/EK	200ohm	JUMPER	-	1K	3K	SWITCH	CN14A	1K ohm

5V-S
5V
-VKK
VDD
SP-FRONT
VOL-UP
VOL-DOWN
POWER-OFF
ST/MONO
FUNC-STB
FUNC-CK
FUNC-DATA
STEREO
PLL-DATA
PLL-STB
PLL-CK
RESET
TUNED
STOP
PROTECTION
VIDEO-C
TU-MUTE
VIDEO-A
VIDEO-B
GND

CN25A
TO 1U-2885-1
MAIN-UNIT

DD-CK
DD-REG
DD-DATA
EXP-DATA
EXP-CK
EXP-STB

*7 CN9B (CN14)
TO 1U-2885-1
MAIN-UNIT

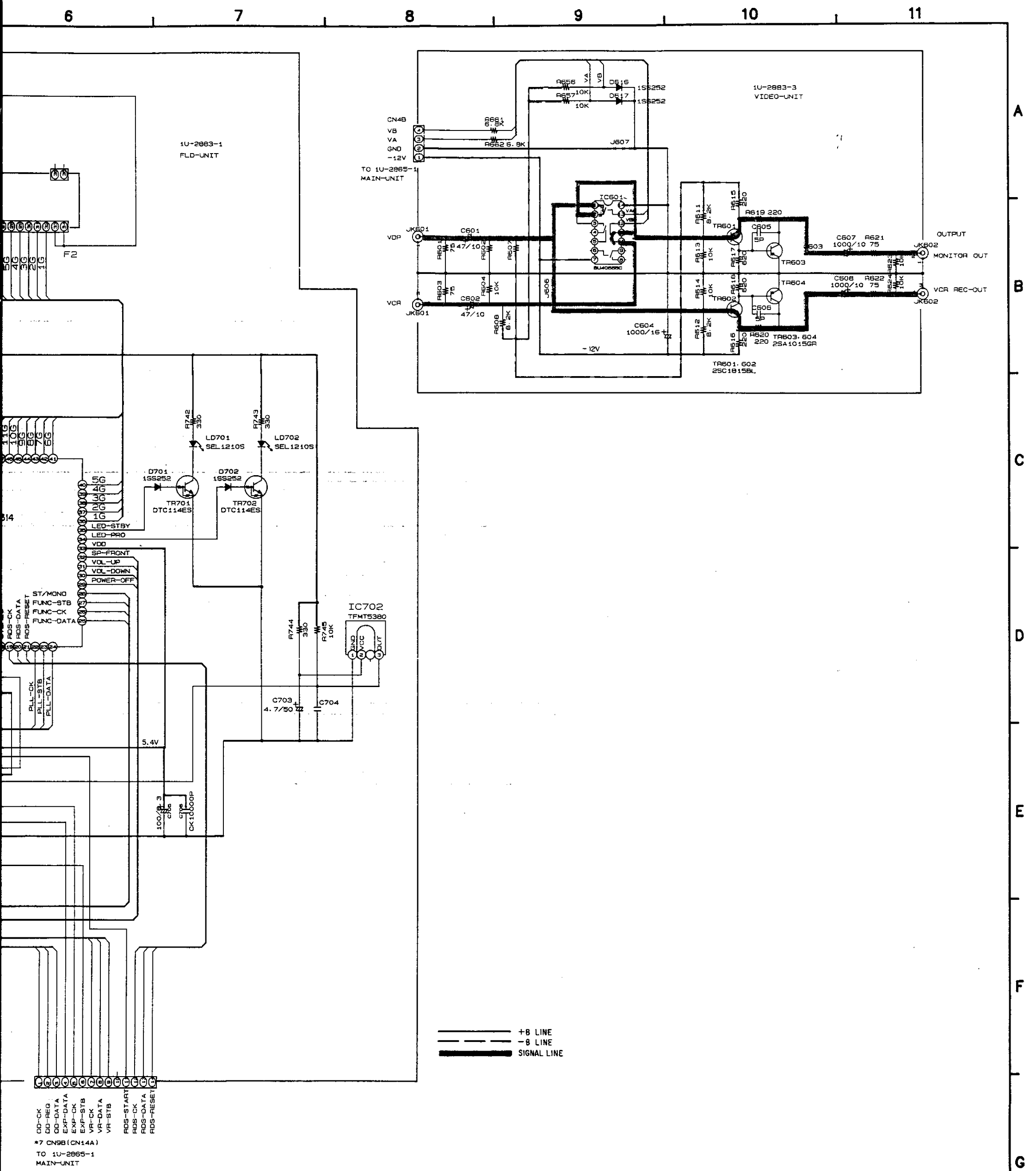

00-CK
00-REG
00-DATA
EXP-DATA
EXP-CK
EXP-STB
VR-CK
VR-DATA
VR-STB
RDS-START
RDS-CK
RDS-DATA
RDS-RESET

*7 CN9B (CN14A)
TO 1U-2885-1
MAIN-UNIT

WARNING:
Parts marked with this symbol have critical characteristics. Use ONLY replacement parts recommended by the manufacturer.

CAUTION:
Before returning the unit to the customer, make sure you make either (1) a leakage current check or (2) a line to chassis resistance check. If the leakage current exceeds 0.5 milliamps, or if the resistance from chassis to either side of the power cord is less than 240 kohms, the unit is defective.

WARNING:
DO NOT return the unit to the customer until the problem is located and corrected.

NOTES
ALL RESISTANCE VALUES IN OHM. k=1,000 OHM, M=1,000,000 OHM
ALL CAPACITANCE VALUES IN MICRO FARAD. P=MICRO-MICRO FARAD
EACH VOLTAGE AND CURRENT ARE MEASURED AT NO SIGNAL INPUT CONDITION.
CIRCUIT AND PARTS ARE SUBJECT TO CHANGE WITHOUT PRIOR NOTICE.

SCHEMATIC DIAGRAM

1

2

3

4

5

6

1U-2865-1

A

B

C

D

E

F

G

H

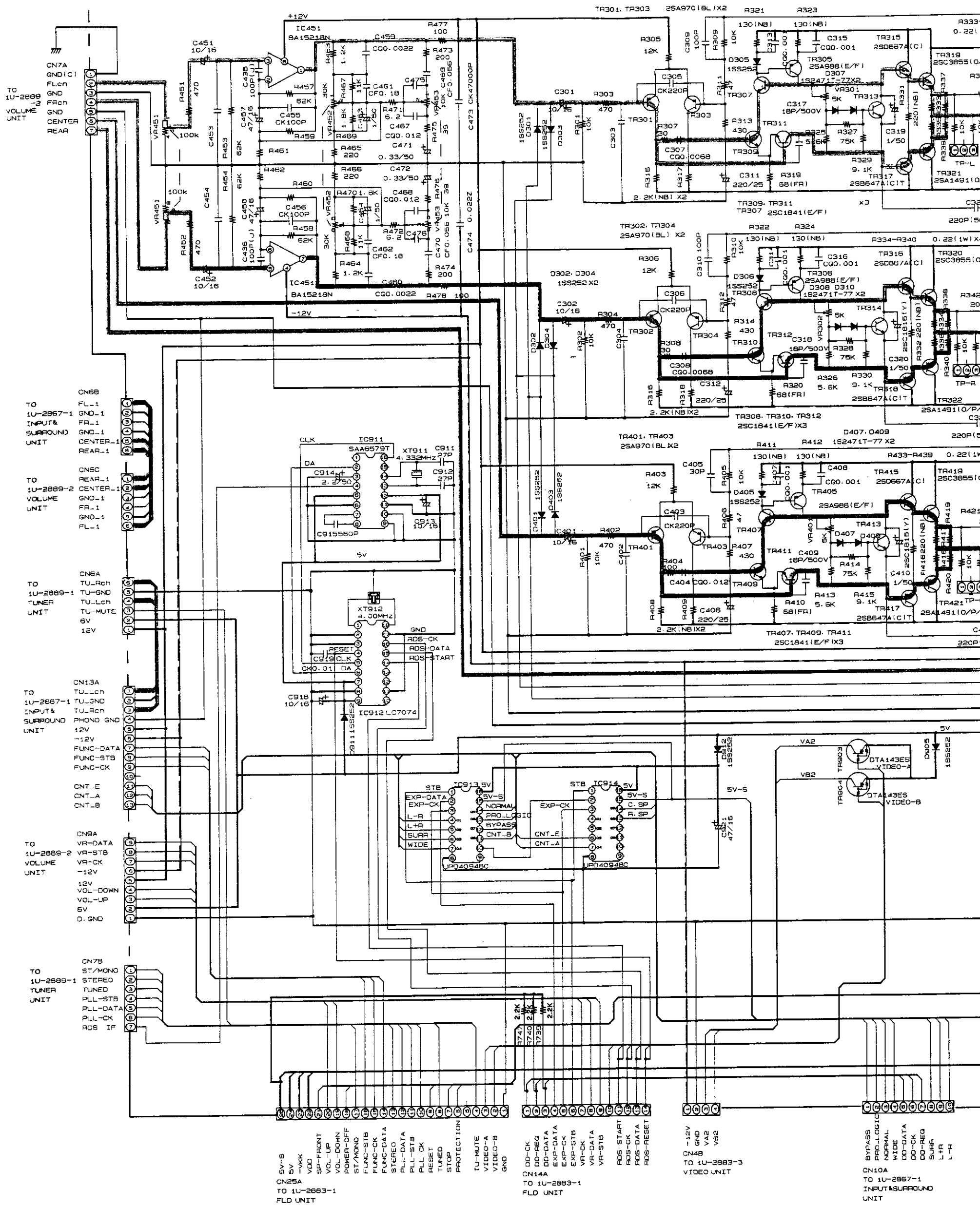

NOTES
 ALL RESISTANCE VALUES IN OHM. K=1,000 OHM, M=1,000,000 OHM
 ALL CAPACITANCE VALUES IN MICRO FARAD. P=MICRO-MICRO FARAD
 EACH VOLTAGE AND CURRENT ARE MEASURED AT NO SIGNAL INPUT
 CONDITION.
 CIRCUIT AND PARTS ARE SUBJECT TO CHANGE WITHOUT PRIOR
 NOTICE.

WARNING:
 Parts marked with this symbol have critical characteristics.
 Use ONLY replacement parts recommended by the manufacturer.

CAUTION:
 Before returning the unit to the customer, make sure you make either (1) a
 leakage current check or (2) a line to chassis resistance check. If the leakage
 current exceeds 0.5 millamps, or if the resistance from chassis to either side
 of the power cord is less than 240 kohms, the unit is defective.

WARNING:
 DO NOT return the unit to the customer until the problem is located and
 corrected.

CENTER MONO

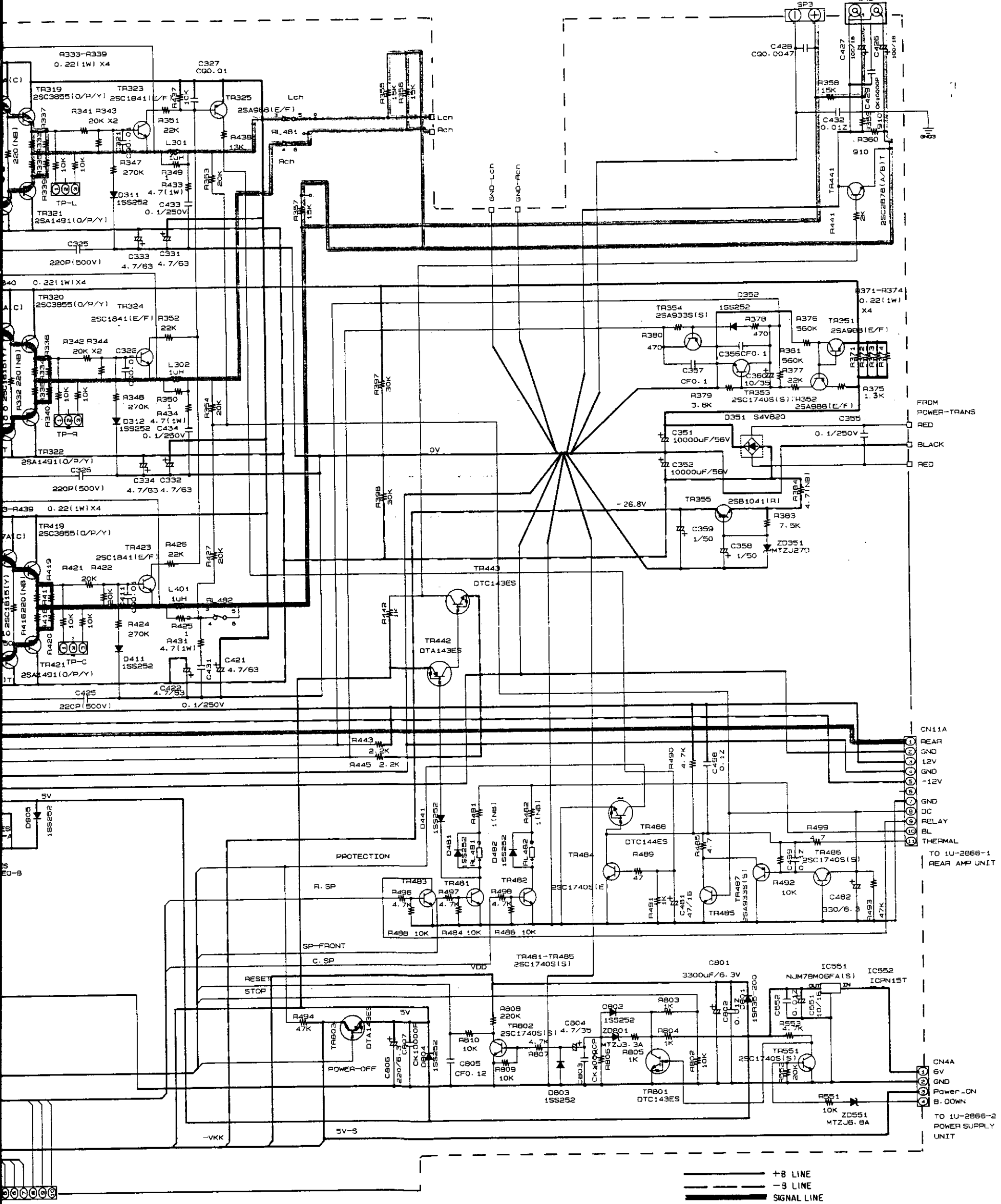

——— +B LINE
 - - - -B LINE
 ——— SIGNAL LINE

DD-DATA
 DD-CK
 DD-REG
 SUPP
 L-R
 L-R

67-1
 GROUND

SCHEMATIC DIAGRAM

1 2 3 4 5 6

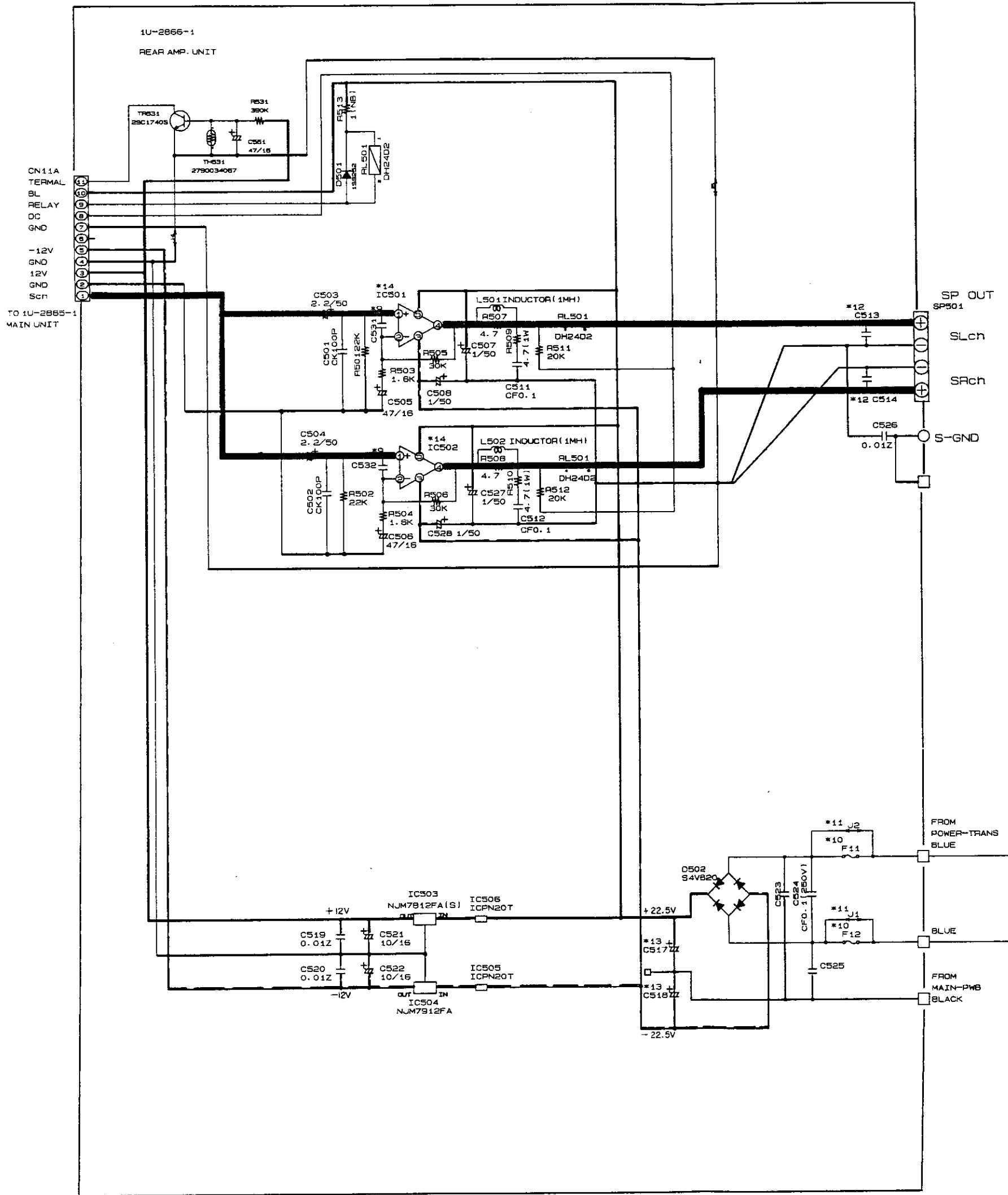

	*9 C531 C532	*10 F11 F12	*11 J1 J2	*12 C513 C514	*13 C517 C518	*14 IC501 IC502
900 E3	-	5A /250V	-	-	3300uF/25V	SI-18751
904/950 E2/EK E1	CK100P	-	0	0.04700P	3300uF/35V	SI-18752

6 7 8 9 10 11

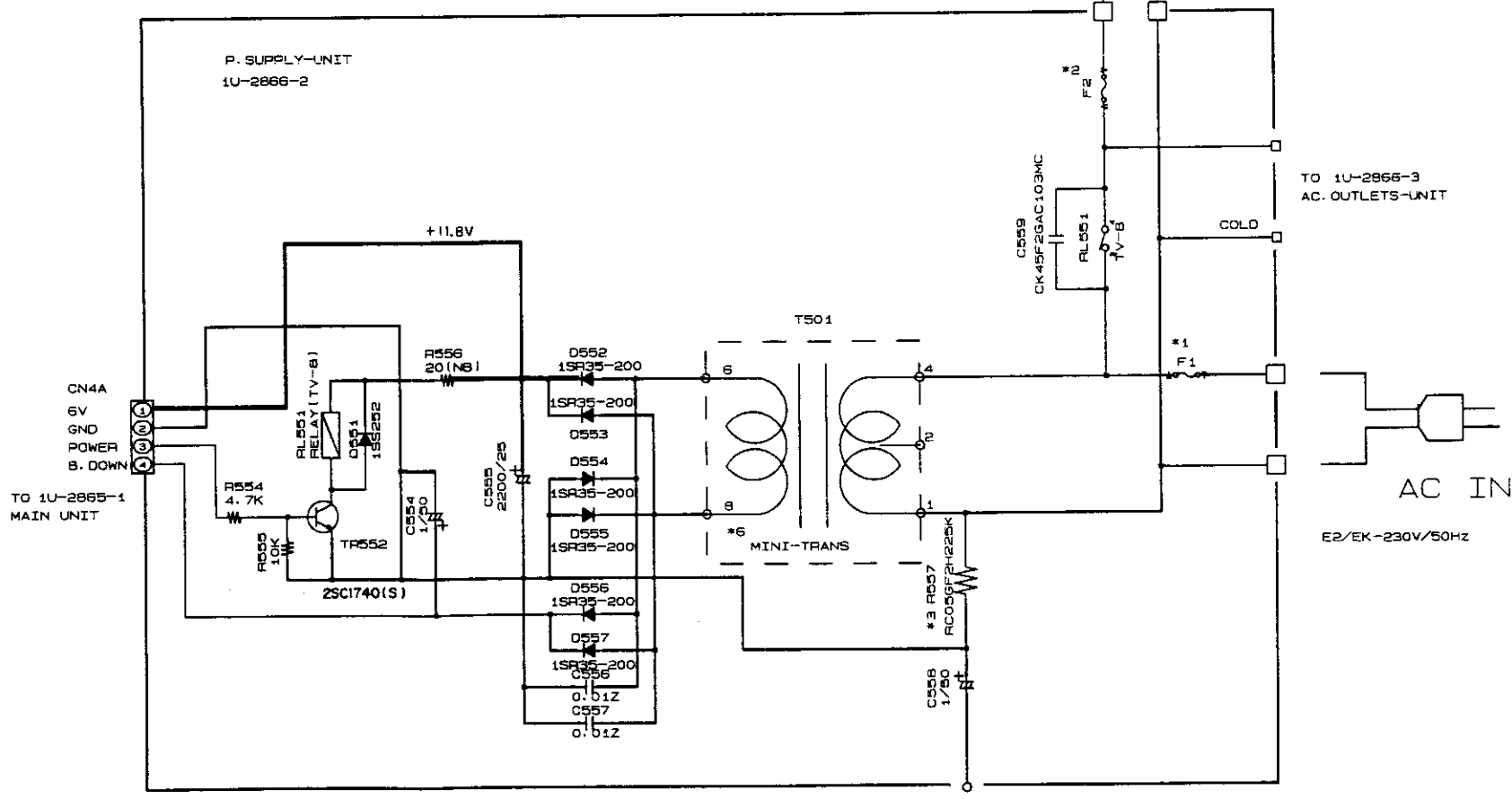
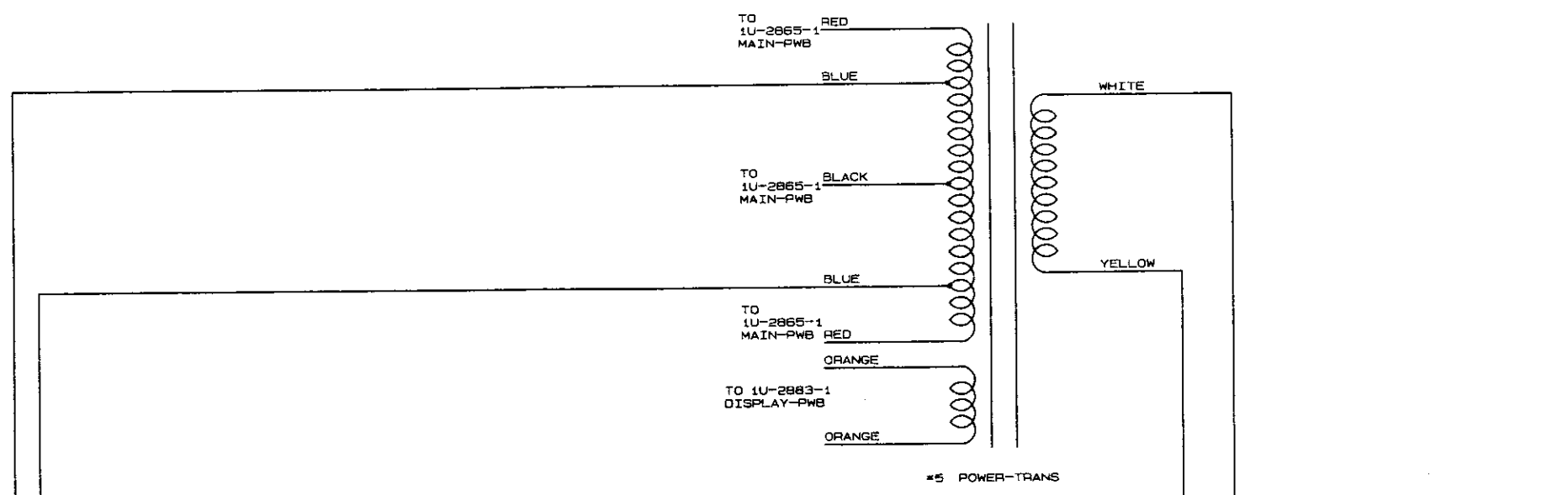
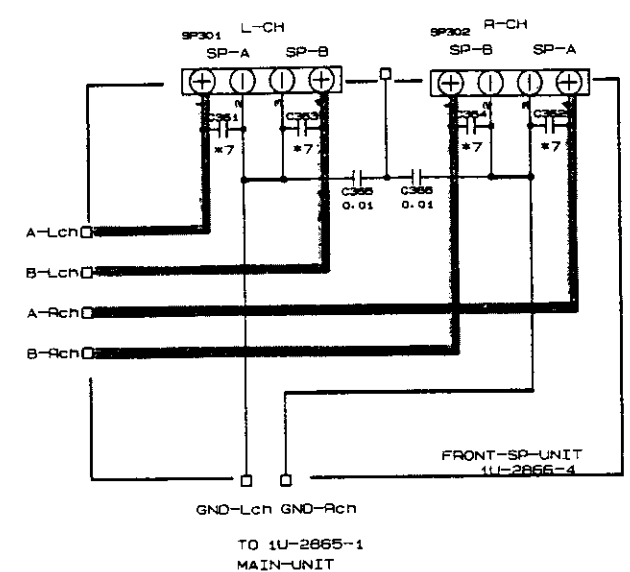
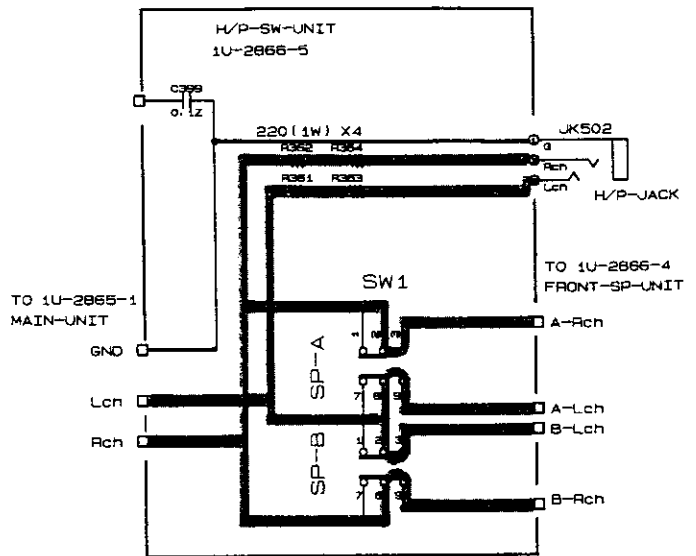

	#1	#2	#3	#4	#5	#6	#7
	F1	F2	RES7	AC OUTLETS	POWER TRANS	MINI-TRANS	SW361-364
900 CS	5A / 250V	5.3A / 250V	2.2M	0	2336178004	2336073000	-
900 E2/EK	JUMPER	2.5A / 250V	-	-	2336178002	2336058012	006800P
960RD E2/EK	JUMPER	3.15A / 250V	-	-	2336178002	2336058012	006800P

--- +B LINE
 --- -B LINE
 ——— SIGNAL LINE

NOTES
 ALL RESISTANCE VALUES IN OHM. k=1,000 OHM, M=1,000,000 OHM
 ALL CAPACITANCE VALUES IN MICRO FARAD. P=MICRO-MICRO FARAD
 EACH VOLTAGE AND CURRENT ARE MEASURED AT NO SIGNAL INPUT CONDITION.
 CIRCUIT AND PARTS ARE SUBJECT TO CHANGE WITHOUT PRIOR NOTICE.

WARNING:
 Parts marked with this symbol have critical characteristics. Use ONLY replacement parts recommended by the manufacturer.

CAUTION:
 Before returning the unit to the customer, make sure you make either (1) a leakage current check or (2) a line to chassis resistance check. If the leakage current exceeds 0.5 milliamps, or if the resistance from chassis to either side of the power cord is less than 240 kohms, the unit is defective.

WARNING:
 DO NOT return the unit to the customer until the problem is located and corrected.

A
B
C
D
E
F
G
H



DENO-00279

DENON

Hi-Fi AV Surround Receiver

SERVICE MANUAL MODEL AVR-900 AV SURROUND RECEIVER

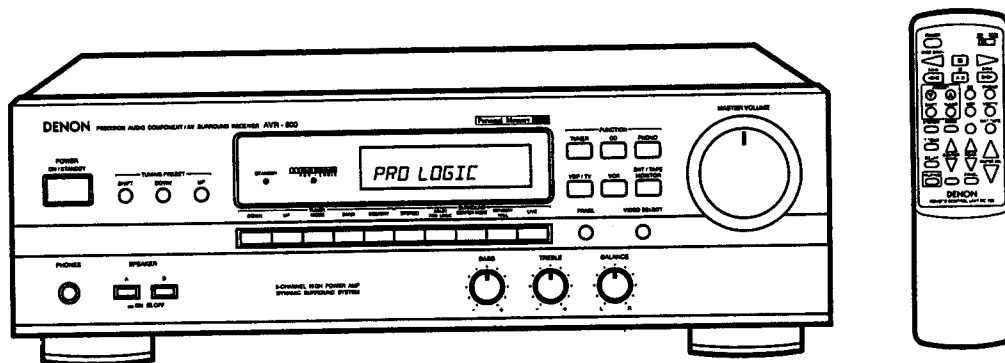

CONTENTS

OPERATING INSTRUCTIONS	2-9
WIRE ARRANGEMENT	10
DISASSEMBLY	11
CONNECTION DIAGRAM OF MEASURING INSTRUMENTS	12, 13
SEMICONDUCTORS	14-22
NOTE FOR PARTS LIST	23
PARTS LIST OF P. W. BOARD	24-30
PRINTED WIRING BOARD	31-35
EXPLODED VIEW	36
PARTS LIST OF EXPLODED VIEW	37
ADDENDUM PARTS LIST	37
BLOCK DIAGRAM	38
WIRING DIAGRAM	39
REMOTE CONTROL UNIT (RC-195)	40
SCHEMATIC DIAGRAM	41-45

NIPPON COLUMBIA CO., LTD.

● SAFETY PRECAUTIONS

CAUTION
RISK OF ELECTRIC SHOCK
DO NOT OPEN

!

CAUTION: TO REDUCE THE RISK OF ELECTRIC SHOCK, DO NOT REMOVE COVER (OR BACK). NO USER SERVICE-ABLE PARTS INSIDE. REFER SERVICING TO QUALIFIED SERVICE PERSONNEL.

The lightning flash with arrowhead symbol, within an equilateral triangle, is intended to alert the user to the presence of uninsulated "dangerous voltage" within the product's enclosure that may be of sufficient magnitude to constitute a risk of electric shock to persons.

The exclamation point within an equilateral triangle is intended to alert the user to the presence of important operating and maintenance (servicing) instructions in the literature accompanying the appliance.

WARNING: TO REDUCE THE RISK OF FIRE OR ELECTRIC SHOCK, DO NOT EXPOSE THIS APPLIANCE TO RAIN OR MOISTURE.

CAUTION
RISK OF ELECTRIC SHOCK
DO NOT OPEN

!

● FOR U.S.A. & CANADA MODEL ONLY

CAUTION

TO PREVENT ELECTRIC SHOCK DO NOT USE THIS (POLARIZED) PLUG WITH AN EXTENSION CORD, RECEPTACLE OR OTHER OUTLET UNLESS THE BLADES CAN BE FULLY INSERTED TO PREVENT BLADE EXPOSURE

● POUR LES MODELE CANADIEN UNIQUEMENT

ATTENTION

POUR PREVENIR LES CHOC ELECTRIQUES NE PAS UTILISER CETTE FICHE POLARISEE AVEC UN PROLONGATEUR UNE PRISE DE COURANT EXTENSION CORD, RECEPTACLE OU AUTRE SORTIE UNLESS LES LAMES POUVENT ETRE INSEREES A FOND SANS EN LAISSER AUCUNE PARTIE DECOUVERT

● 安全事項

CAUTION
RISK OF ELECTRIC SHOCK
DO NOT OPEN

!

注意：為減少觸電危險，切勿拆下機殼（或機背）。機身內並無用戶修理用零件。請交由專業修理人員修理本機。

三角形內有箭頭的閃電符號旨在提醒用戶，本產品機殼內有未經絕緣的“危險電壓”，其幅度足以使人觸電而發生危險。

警告：為減少着火或觸電危險，切勿讓本機受雨淋濕或受潮。

SAFETY INSTRUCTIONS

1. Read Instructions – All the safety and operating instructions should be read before the appliance is operated.
2. Retain Instructions – The safety and operating instructions should be retained for future reference.
3. Heed Warnings – All warnings on the appliance and in the operating instructions should be adhered to.
4. Follow Instructions – All operating and use instructions should be followed.
5. Water and Moisture – The appliance should not be used near water – for example, near a bathtub, washbowl, kitchen sink, laundry tub, in a wet basement, or near a swimming pool, and the like.
6. Carts and Stands – The appliance should be used only with a cart or stand that is recommended by the manufacturer.
- 6A. An appliance and cart combination should be moved with care. Quick stops, excess force, and uneven surfaces may cause the appliance and cart combination to overturn.
7. Wall or Ceiling Mounting – The appliance should be mounted to a wall or ceiling only as recommended by the manufacturer.
8. Ventilation – The appliance should be situated so that its location or position does not interfere with its proper ventilation. For example, the appliance should not be situated on a bed, sofa, rug, or similar surface that may block the ventilation openings; or, placed in a built-in installation, such as a bookcase or cabinet that may impede the flow of air through the ventilation openings.
9. Heat – The appliance should be situated away from heat sources such as radiators, heat registers, stoves, or other appliances (including amplifiers) that produce heat.
10. Power Sources – The appliance should be connected to a power supply only of the type described in the operating instructions or as marked on the appliance.
11. Grounding or Polarization – Precautions should be taken so that the grounding or polarization means of an appliance is not defeated.
12. Power-Cord Protection – Power-supply cords should be routed so that they are not likely to be walked on or pinched by items placed upon or against them, paying particular attention to cords at plugs, convenience receptacles, and the point where they exit from the appliance.
13. Cleaning – The appliance should be cleaned only as recommended by the manufacturer.
14. Power Lines – An outdoor antenna should be located away from power lines.
15. Outdoor Antenna Grounding – If an outside antenna is connected to the receiver, be sure the antenna system is grounded so as to provide some protection against voltage surges and built-up static charges. Article 8 10 of the National Electrical Code, ANSI/NFPA 70, provides information with regard to proper grounding of the mast and supporting structure, grounding of the lead-in wire to an antenna-discharge unit, size of grounding conductor, location of antenna-discharge unit, connection to grounding electrodes, and requirements for the grounding electrode. See Figure A.
16. Nonuse Periods – The power cord of the appliance should be unplugged from the outlet when left unused for a long period of time.
17. Object and Liquid Entry – Care should be taken so that objects do not fall and liquids are not spilled into the enclosure through openings.
18. Damage Requiring Service – The appliance should be serviced by qualified service personnel when:
 - A. The power-supply cord or the plug has been damaged; or
 - B. Objects have fallen, or liquid has been spilled into the appliance; or
 - C. The appliance has been exposed to rain; or
 - D. The appliance does not appear to operate normally or exhibits a marked change in performance; or
 - E. The appliance has been dropped, or the enclosure damaged.
19. Servicing – The user should not attempt to service the appliance beyond that described in the operating instructions. All other servicing should be referred to qualified service personnel.

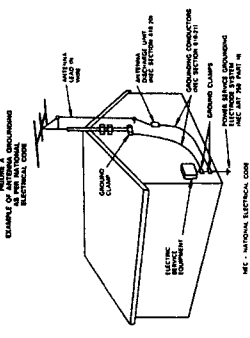

■ We greatly appreciate your purchase of the AVR-900.
 ■ To be sure you take maximum advantage of all the features the AVR-900 has to offer, read these instructions carefully and use the set properly. Be sure to keep this manual for future reference should any questions or problems arise.

**"SERIAL NO. _____"
 PLEASE RECORD UNIT SERIAL NUMBER ATTACHED TO THE REAR OF THE
 CABINET FOR FUTURE REFERENCE"**

1 INTRODUCTION

NOTE ON USE

<ul style="list-style-type: none"> Do not let foreign objects in the set. 	<ul style="list-style-type: none"> Do not let insecticides, benzene, and thinner come in contact with the set. 	<ul style="list-style-type: none"> Never disassemble or modify the set in any way.
<ul style="list-style-type: none"> Keep the set free from moisture, water, and dust. 	<ul style="list-style-type: none"> Unplug the power cord when not using the set for long periods of time. 	<ul style="list-style-type: none"> *(For sets with ventilation holes) Do not obstruct the ventilation holes.
<ul style="list-style-type: none"> Avoid high temperatures. Allow for sufficient heat dispersion when installed on a rack. 	<ul style="list-style-type: none"> Handle the power cord carefully. Hold the plug when unplugging the cord. 	

A note on stacking

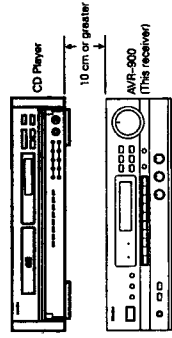

For cooling purposes, do not place another AV component directly on top of the receiver. Be sure to leave a space of at least 10 cm.

INSTALLATION PRECAUTIONS

Using this receiver or other electronic equipment containing microprocessors simultaneously with a tuner or TV may result in noise in the sound or picture.
 If this should happen, take the following steps:
 • Install the receiver as far as possible from the tuner or TV set.
 • Keep the antenna lines of the tuner or TV as far as possible from the receiver's power cord and connection cables.
 • This problem is especially frequent when using indoor antennas. We recommend using outdoor antennas and 75 Ω/ohms coaxial cables.

TABLE OF CONTENTS

1 Introduction	5	4-6 Recording the program source	11
2 Connections	6	4-7 Front panel display	11-13
2-1 Connecting the audio components	6	4-8 Using the surround function	11-13
2-2 Speaker system connections	7	5 Listening to the radio	13
2-3 Connecting the video components	7	5-1 Auto preset memory	13
2-4 Connecting the antenna terminals	8	5-2 Auto tuning	13
3 Remote Control Unit	8, 9	5-3 Manual tuning	14
4 Operations	9	5-4 Preset memory	14
4-1 Preparations for playback	9	5-5 Recalling preset stations	14
4-2 Playing the program source (stereo play back)	10	6 Initialization of the Microprocessor	15
4-3 Simulcast play back	10	7 Last function memory	15
4-4 Using the muting function	10	8 Troubleshooting	15
4-5 Listen with headphones	10	9 Specifications	16

TABLE DES MATIERES

1 Introduction	5	4-6 Enregistrement de la source de programme	11
2 Connexions	6	4-7 Affichage du panneau avant	11-13
2-1 Connexion des composants audio	6	4-8 Utilisation de la fonction d'ambiance	11-13
2-2 Connexions du système d'enceintes	7	5 Ecouter la radio	13
2-3 Connexions des composants vidéo	7	5-1 Mémoire préétablie automatique	13
2-4 Connexions des bornes d'antennes	8	5-2 Synchronisation automatique	13
3 Télécommande	8, 9	5-3 Synchronisation manuelle	14
4 Fonctionnement	9	5-4 Mémoire préétablie	14
4-1 Préparatifs pour la lecture	9	5-5 Rappel de stations préétablies	14
4-2 Lecture de la source de programme (lecture stéréo)	10	6 Initialisation du microprocesseur	15
4-3 Lecture simultanée	10	7 Mémoire de la dernière fonction	15
4-4 Utilisation de la fonction de mise en sourdine	10	8 Dépistage des pannes	15
4-5 Ecoute avec casque	10	9 Spécifications	16

目錄

1 引言	5	4-6 節目源錄音	11
2 連接方法	6	4-7 前面顯示	11-13
2-1 連接音響器材	6	4-8 使用環境聲功能	11-13
2-2 揚聲器系統連接法	7	5 收聽電台廣播	13
2-3 連接錄影機設備	7	5-1 自動預設記憶	13
2-4 連接天線端子	8	5-2 自動調諧	13
3 遙控器	8, 9	5-3 手動調諧	14
4 操作方法	9	5-4 預設記憶	14
4-1 播放準備	9	5-5 調出預設電台	14
4-2 播放程序音源 (立體聲廣播)	10	6 微處理器之初始化	15
4-3 雙音播放	10	7 最後功能記憶	15
4-4 使用靜音功能	10	8 故障診斷	15
4-5 用耳筒收聽	10	9 規格	16

ACCESSORIES Check that the following parts are included in addition to the main unit:

- ① Operating instructions
- ② Remote unit (RC-195)
- ③ Warranty (for North American model only)
- ④ R6P/AA batteries
- ⑤ AM loop antenna
- ⑥ FM indoor antenna

ACCESSOIRES Vérifier que les articles suivants sont inclus dans le carton en plus de l'unité principale:

- ① Mode d'emploi
- ② Télécommande (RC-195)
- ③ Garantie (uniquement pour modèle nord-américain)
- ④ Piles R6P/AA
- ⑤ Antenne-câble AM
- ⑥ Antenne intérieure FM

附件 下列附件應與主機附送:

- ① 操作說明書
- ② 遙控器 (RC-195)
- ③ 保用証 (只限北美洲機型)
- ④ R6P/AA 電池
- ⑤ AM 磁棒天線
- ⑥ FM 室內天線

2 CONNECTIONS

- Do not plug in the power cord until all connections have been completed.
- Be sure to connect the left and right channels properly (left with left, right with right).
- Insert the plugs securely. Incomplete connections will result in the operation of noise.
- Use the AC OUTLETS for audio equipment only. Do not use them for hair driers, etc.

2-1 Connecting the audio components

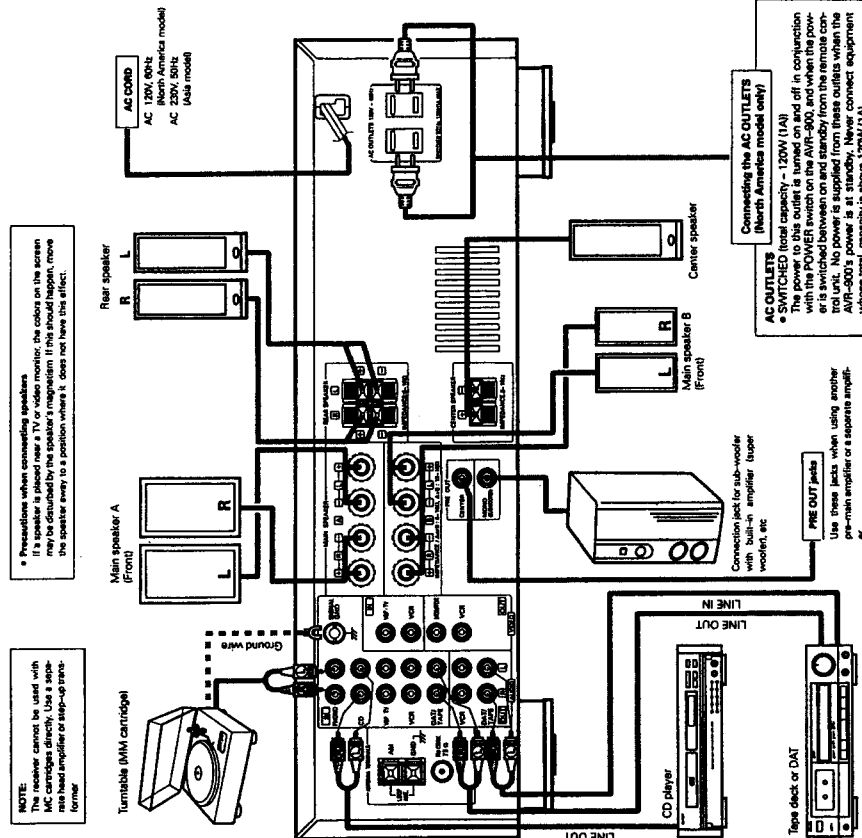

2-2 Speaker System Connections

- This receiver can accommodate connections of a total of seven speakers including two sets of (front) main amplifier speakers (A and B), one set of rear speakers, and one center speaker. Connect the speaker terminals with the speakers making sure that like polarities are matched (⊕ with ⊕, ⊖ with ⊖). Mismatching of polarities will result in weak central sound, unclear orientation of the various instruments, and the sense of direction of the stereo being impaired.
- When making connections, take care that none of the individual conductors of the speaker cord come in contact with adjacent terminals, with other speaker cord conductors, or with the rear panel.

Connecting the speaker terminals

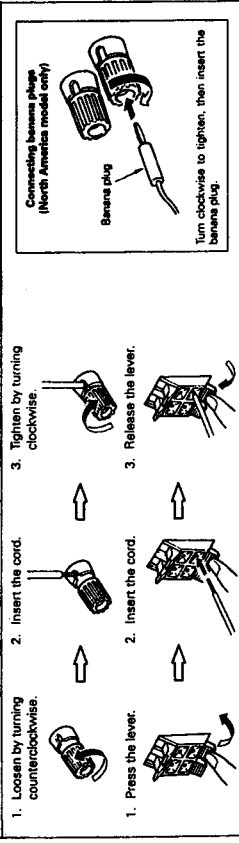

2-3 Connecting the video components

To connect the video signal, connect using a 75 Ω/ohms video signal cable cord. Using an improper cable can result in a drop in sound quality.

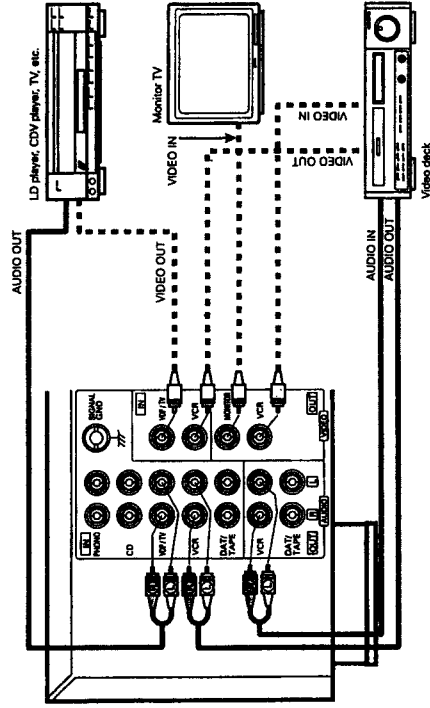

- Note that binding pin plug cords together with power cords or placing them near a power transformer will result in the introduction of hum or other noise.
- If hum or other noise is produced when the ground wire is connected, disconnect it.
- Noise or humming may be generated if a connected component is used independently without turning the power of the AVR-900 on. If this happens, turn on the power of the AVR-900.

2-2 Connecting the audio components

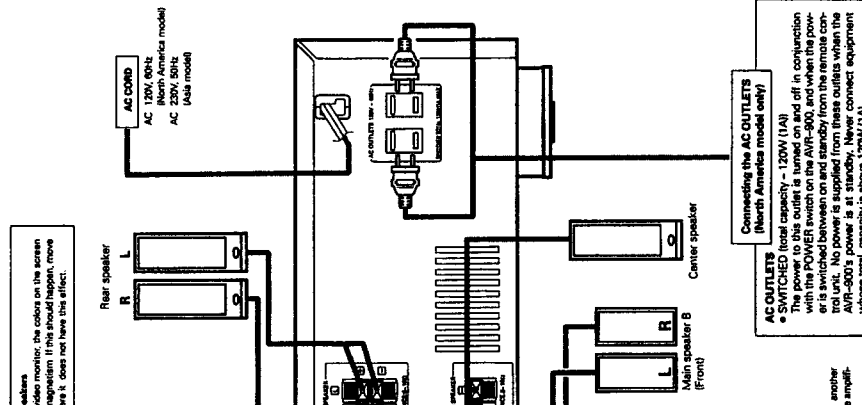

2-4 Connecting the antenna terminals

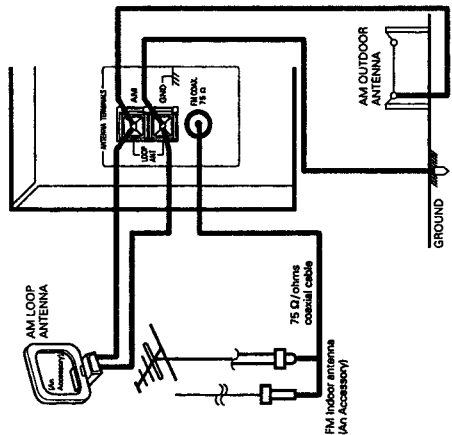

ANTENNA INSTALLATION

- The supplied FM antenna can be used inside wooden houses for receiving local FM stations and other strong FM signals. However, it is not recommended for use in areas with a lot of metal bars or on the wall or ceiling where optimum reception is achieved. A indoor FM antenna may not consistently ensure stable reception, due to environment changes. In such cases, the indoor FM antenna should only be used temporarily until an outdoor antenna is installed.
- When connecting an outdoor FM antenna, the use of 75 Ω/ohms coaxial cable (CC-2V, SC-2V) is strongly recommended.
- AM ANTENNA: An indoor AM loop antenna even when using an outdoor AM antenna. Connect the leads to the AM and GND terminals. Also use the AM terminals for connecting an outdoor AM antenna. When making such a connection do not disconnect the antenna from the receiver.
- Add the loop antenna to obtain optimum reception. Where broadcast stations are distant and only weak signals are received, or where signals are blocked, it is best to install an outdoor AM antenna.
- This receiver has a full back-up system. When the power is turned on, the INPUT SELECTOR buttons are set to the last mode set before the power was turned off.
- When using this receiver in close proximity to video equipment, the video signal may be generated in AM broadcasts. To avoid this, when possible, or place the AM loop antenna from the antenna holder and adjust the AM loop antenna from the antenna holder and adjust when noise is reduced. If the noise is not reduced, turn the power of the video components when listening to AM broadcasts.

Connection of AM antennas

1. Push the lever.
2. Insert the conductor.
3. Return the lever.

3 REMOTE CONTROL UNIT

Following the procedure outlined below, insert the batteries before using the remote control unit.

Range of operation of the remote control unit

Point the remote control unit at the remote control sensor as shown on the diagram at the left.

NOTES:

- The remote control unit can be used from a straight distance of approximately 7 meters/20 feet, but this distance will shorten or operation will become difficult if there are obstacles between the remote control unit and the remote control sensor. If the remote control sensor is exposed to direct sunlight or other strong light, or if operated from an angle.
- Neon signs or other devices emitting pulse-type noise nearby may result in malfunction, so keep the set as far away from such devices as possible.

Inserting the batteries

1. Open the bottom cover of the remote control unit and remove the battery cover.
2. Insert the two R6P/AA batteries, matching the (+) and (-) marks on the batteries with those in the case.
3. Close the bottom cover until it clicks shut.



NOTES

- Use only AA, R6P UM-3 batteries for replacement.
- Be sure the polarities are correct. (See the illustration inside the battery compartment.)
- Remove the batteries if the remote control transmitter will not be used for an extended period of time.
- If batteries leak, dispose of them immediately. Avoid touching the leaked material or letting it come in contact with clothing, etc. Clean the battery compartment thoroughly before installing new batteries.
- Have replacement batteries on hand so that the old batteries can be replaced as quickly as possible when the time comes.

System code buttons

NOTE: remote-controllable audio components can be controlled using this unit's remote control unit. Note that some components, however, cannot be operated with this remote control unit.

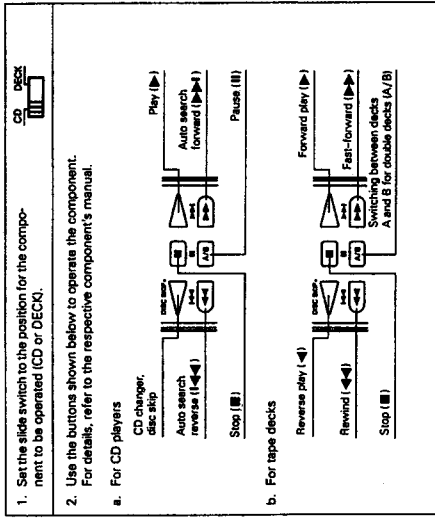

1. Set the slide switch to the position for the component to be operated (CD or DECK).

2. Use the buttons shown below to operate the component. For details, refer to the respective component's manual.

a. For CD players

b. For tape decks

4 OPERATIONS

4-1 Preparations for Play Back

- 1 Check that all connections are proper.
- 2 Set to the minimum position.

MASTER VOLUME



3 Set to the center position.

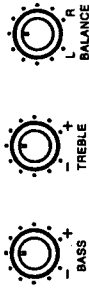

4 Press the power button to turn the power on.

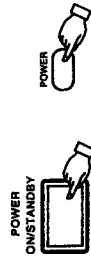

5 Select the front speakers. Press the speaker A or B switch to turn the speaker on.



4-2 Playing the program source (Stereo play back)

- Select the source to be played.
 - TURNER
 - VIDEO
 - VCR
 - VIDEO/TV
 - PROLOG
 - VIDEO
 - VIDEO
 - VIDEO
- Select the STEREO mode.
 - STEREO
 - STEREO
 - STEREO
 - STEREO
 - STEREO
 - STEREO
 - STEREO
 - STEREO
- Adjust the MASTER VOLUME control.
 - MASTER VOLUME
 - MASTER VOLUME
 - MASTER VOLUME
 - MASTER VOLUME
 - MASTER VOLUME
 - MASTER VOLUME
 - MASTER VOLUME
 - MASTER VOLUME
- Adjust the front left/right BALANCE.
 - BALANCE
 - BALANCE
 - BALANCE
 - BALANCE
 - BALANCE
 - BALANCE
 - BALANCE
 - BALANCE

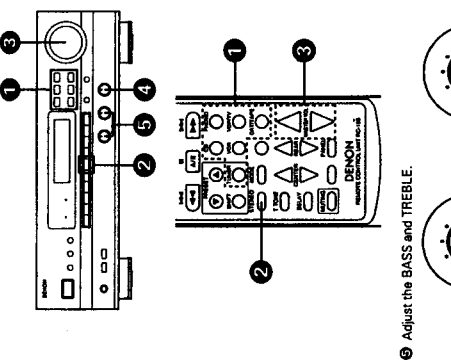

4-3 Simulcast playback

- Use this switch to monitor a video source other than the audio source.
- Press and hold the VIDEO SELECT button until the desired source appears on the display.
 - VIDEO SELECT
 - VIDEO SELECT
 - VIDEO SELECT
 - VIDEO SELECT
 - VIDEO SELECT
 - VIDEO SELECT
 - VIDEO SELECT
 - VIDEO SELECT
- ✳ Cancellling simulcast playback
- Press the VIDEO SELECT button once more.
 - Select the VIDEO function.

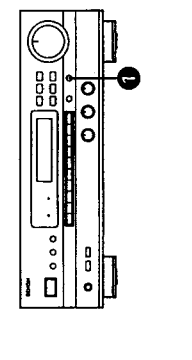

4-4 Using the muting function

- Use this to turn off the audio output temporarily.
- Press the MUTING button.
 - MUTING
 - MUTING
 - MUTING
 - MUTING
 - MUTING
 - MUTING
 - MUTING
 - MUTING
- ✳ Cancellling the MUTING mode. Press the MUTING button again.
- This function can only be set from the remote control unit. The STANDBY LED flashes when the muting function is set.

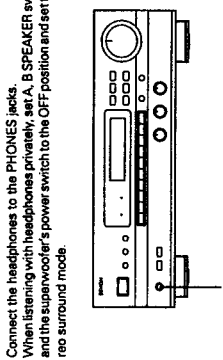

4-6 Recording the program source

- (Recording the source currently being monitored)
- Follow steps 1 to 3 under "Playing the program source".
 - Start recording on the tape or video deck. For instructions, refer to the component's operating instructions.

Simultaneous recording
 The signals of the source selected with the function selector button are output simultaneously to the DAT/TAPE and VCR REC OUT jacks. If a total of two tape and/or video decks are connected and set to the recording mode, the same source can be recorded simultaneously on both decks. In addition, if the TAPE MONITOR (DAT/TAPE) button is pressed, the audio signals from the tape deck are output to the VCR AUDIO REC OUT jacks.

4-7 Front panel display

Descriptions of the unit's operations are also displayed on the front panel display. In addition, the display can be switched to check the unit's operating status while playing a source by pressing the PANEL button

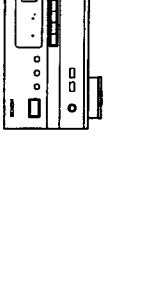

4-8 Using the surround function

Types of surround modes and their characteristics	
1 DOLBY Pro Logic	Use this when playing program sources recorded in Dolby Surround or Dolby Stereo.
2 CONCERT HALL	Use this setting to create the atmosphere of a concert hall. There will be no output from the center speaker.
3 LIVE	Use this setting to create the atmosphere of watching a live performance. There will be no output from the center speaker.

Before using the surround function

Make the following adjustments before using the surround function.

- Set the Dolby Pro Logic mode.
 - MODE
 - MODE
 - MODE
 - MODE
 - MODE
 - MODE
 - MODE
 - MODE
- Select the center mode.
 - SELECT
 - SELECT
 - SELECT
 - SELECT
 - SELECT
 - SELECT
 - SELECT
 - SELECT
- Adjust the center and rear levels to set the volume of the speakers to the same level.
 - LEVEL
 - LEVEL
 - LEVEL
 - LEVEL
 - LEVEL
 - LEVEL
 - LEVEL
 - LEVEL
- Adjust the delay time and setting position as necessary.
 - DELAY
 - DELAY
 - DELAY
 - DELAY
 - DELAY
 - DELAY
 - DELAY
 - DELAY
- Turn the test tone off.
 - T.TONE
 - T.TONE
 - T.TONE
 - T.TONE
 - T.TONE
 - T.TONE
 - T.TONE
 - T.TONE

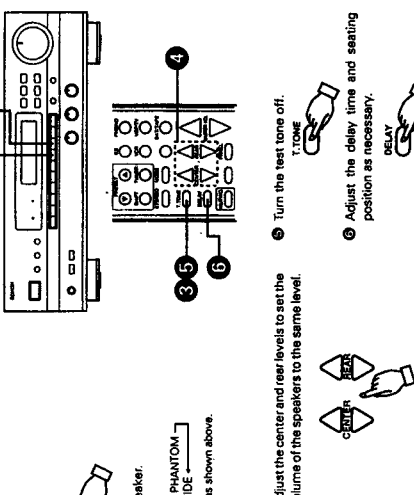

Center Mode

Set the center mode as described below, according to the type of center speaker being used.

Normal mode: This mode is suited for an arrangement in which the center channel speaker is smaller than the left and right speakers. Signals below 100 Hz which have almost no effect on directional orientation are distributed to the left and right channels, whereas the center channel output signals greater than 100 Hz. As a result, the bass of the left and right channels increases the apparent depth of the sound.

Wide mode: This mode is suited for an arrangement in which the center channel speaker is of the same grade as the left and right speakers. The entire sound band from low region to high is output to the center channel to provide an exciting sound field for your enjoyment.

Phantom mode: Use this mode when center channel speaker is not used. A directional emphasis circuit provides signal reproduction which is electrically oriented to the center and this provides an exciting sound field for your enjoyment.

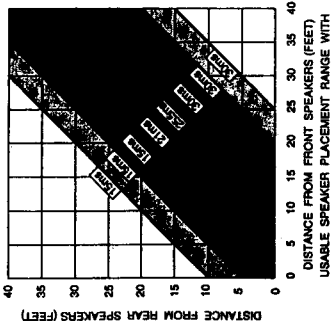
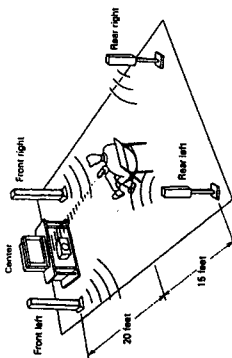

Delay Time

The optimum delay time will differ depending on the listening position. Referring to the chart at left, set the optimum delay time for your room's space and seating position. For example, when the distance from the front speakers to the listening position is 20 feet and that from the rear speakers to the listening position is 15 feet, the optimum delay time will be 21 ms. The variable range of the delay time differs depending on the mode.

Personal Memory Plus function . . . for EASY TO USE

The AVR-900 automatically stores the surround mode adding effects for all input sources. The corresponding surround mode is recalled automatically each time an input source is selected.

Using the surround function

- 1 Select the surround mode according to the input source.
- 2 If necessary, adjust the levels.
- 3 Adjust the parameters to the desired settings.



2 If necessary, adjust the levels.



3 Adjust the parameters to the desired settings.

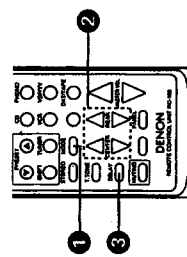
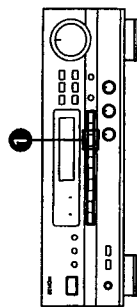

Manufactured under license from Dolby Laboratories Licensing Corporation. Additionally licensed under Canadian patent number 1,037,877. "Dolby," "Pro Logic," and the double-D symbol are trademarks of Dolby Laboratories Licensing Corporation.

Operating Possible in the Various Surround Modes

The following is a list of the buttons and functions which can be operated during the different surround modes. Figures in parentheses indicate adjustment ranges.

	NORMAL	PHANTOM	WIDE	CONCERT HALL	LIVE
OUTPUT	○	○	○	○	○
CENTER LEVEL	○ 10 -- 24dB	x	○ 10 -- 24dB	x	○ 10 -- 24dB
REAR LEVEL	○ 10 -- 24dB	○	○ 10 -- 24dB	○	○ 10 -- 24dB
CENTER MODE	○	○	○	△*1	○
TEST TONE	○ (15-30ms)	○	○ (15-30ms)	○	○ (15-30ms)
DELAY TIME	○ (15-30ms)	○	○ (15-30ms)	○	○ (15-30ms)

*1 Switches to the Dolby Pro Logic from any modes other than Dolby Pro Logic. The level of the center and rear channels can be adjusted by 2 dB step. The delay time can be set by 1.5 ms step.

○: Operation possible x: Operation not possible

The sound may be distorted for some sources if the rear level is raised during surround playback. If this happens, lower the rear level.

5 LISTENING TO THE RADIO

5-1 Auto preset memory

This unit is equipped with a function for automatically searching for FM broadcast stations and storing them in the preset memory.

- 1 Press the POWER button while holding in the MEMORY button. The unit automatically begins searching for FM broadcast stations.

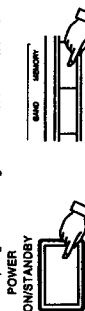

1 Channel A1 is tuned in after the auto preset memory operation is completed.

- NOTES:**
- If an FM station cannot be preset automatically due to poor reception, use the "Manual tuning" operation to tune in the station, then preset it using the manual "Preset memory" operation.
 - RDS stations are stored in the memory with priority.
 - To interrupt this function, press the POWER button.

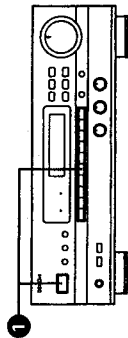

- 2 When the first FM broadcast station is found, that station is stored in the preset memory at channel A1. Subsequent stations are automatically stored in order at preset channels A2 to A8, B1 to B8, C1 to C8, D1 to D8 and E1 to E8, for a maximum of 40 stations.

5-2 Auto tuning

- 1 Set the input function to "TUNER".

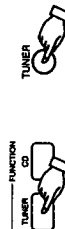

- 2 Watching the display, press the BAND button to select the desired band (AM or FM).

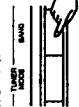

- 3 Press the MODE button to set the auto tuning mode.

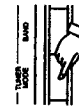

"AUTO" appears on the display.

If tuning does not stop at the desired station, use the "Manual tuning" operation.

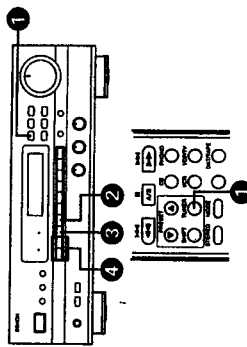

- 4 Press the TUNING UP or DOWN button.

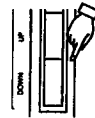

Automatic searching begins, then stops when a station is tuned in.

5-3 Manual tuning

- 1. Set the input function to "TUNER".
 - 2. Watching the display, press the BAND button to select the desired band (AM or FM).
Check that the display's "AUTO" indicator turns off.
- NOTES:
- When in the auto tuning mode on the FM band, the "STEREO" indicator lights on the display when a stereo broadcast is tuned in. At open frequencies, the noise is muted and the "TUNED" and "STEREO" indicators turn off.
 - When the manual tuning mode is set, FM stereo broadcasts are received in mono and the "STEREO" indicator turns off.

5-4 Preset memory

- 1. Use the "Auto tuning" or "Manual tuning" operation to tune in the station to be preset in the memory.
- 2. Press the MEMORY button.
- 3. Press the SHIFT button and select the desired memory block (A to E).

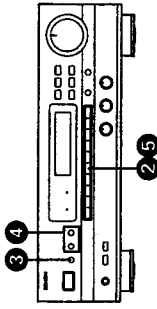

- 4. Press the MEMORY button again to store the station in the preset memory.



- 5. Press the PRESET UP or DOWN button to select the desired preset channel (1 to 8).
- NOTES:
- To preset other channels, repeat steps 3 to 5.
 - A total of 40 broadcast stations can be preset—8 stations (channels 1 to 8) in each of blocks A to E.



5-5 Recalling preset stations

- 1. Watching the display, press the SHIFT button to select the preset memory block.
- 2. Watching the display, press the PRESET UP or DOWN button to select the desired preset channel.

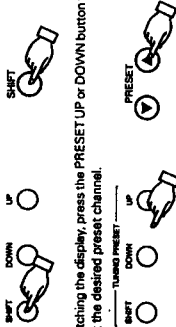

6 INITIALIZATION OF THE MICROPROCESSOR

- When the indication of the MFD display is not normal or when the operation of the unit does not show the reasonable result, the initialization of the microprocessor is required by the following procedure.
1. Switch off the unit and remove the AC power cord from the wall outlet.
 2. Hold the following TUNER button and VIDEO SELECT button, and plug the power cord into the outlet.
 3. Check that the entire display is flashing with an interval of about 1 second, and release your fingers from the 2 buttons.
 4. Switch on the unit and the microprocessor will be initialized.

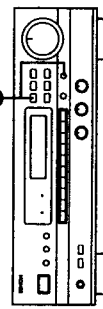

7 LAST FUNCTION MEMORY

- 1. This receiver is equipped with a last function memory which stores the input and output setting conditions as they were immediately before the power is switched off.
- 2. This function eliminates the need to perform complicated resettings when the power is switched on.
- 3. This receiver is also equipped with a back-up memory. This function provides approximately one week of memory storage with the power cord disconnected.

8 TROUBLESHOOTING

- If a problem should arise, first check the following:
1. Are the connections correct?
 2. Have you operated the amplifier according to the Operating Instructions?
 3. Are the speakers, turntable, and other components operating properly?
- If the receiver is not operating properly, check the items listed in the table below. Should the problem persist, there may be a malfunction. Disconnect the power immediately and contact your store of purchase.

Symptom	Cause	Measures	Page
DISPLAY not lit and sound not produced when power switch set to on.	• Power cord not plugged in securely.	• Check the insertion of the power cord plug.	6
DISPLAY lit but sound not produced.	• Speaker cords not securely connected. • Improper position of the audio function button. • Volume control set to minimum. • MUTING is on.	• Connect securely. • Turn on speaker switch. • Set to a suitable position. • Turn volume up to suitable level. • Switch off MUTING.	6, 7 9 10 9 10
-PROTECT- display appears.	• Speaker terminals are short-circuited. • Block the ventilation holes of the set	• Switch power off, connect speakers properly, then switch power back on. • Turn off the set's power, then ventilate it well to cool it down. • Turn on the set's power, then ventilate it well to cool it down. • Turn off the set's power, then ventilate it well to cool it down. • Once the set is cooled down, turn the power back on.	6, 7
Sound produced only from one channel.	• Incomplete connection of speaker cords. • Incomplete connection of input/output cards	• Connect securely. • Connect securely.	6, 7 6, 7
Positions of instruments reversed during stereo playback.	• Reverse connections of left and right speakers or left and right input/output cords.	• Adjust balance knob properly.	9
Sound seems distorted.	• Rear level is too high.	• Check left and right connections.	6, 7
Humming noise produced when record is playing.	• Ground wire of turntable not connected properly. • Incomplete PHONO jack connection. • TV or radio transmission antenna nearby.	• Connect securely. • Connect securely. • Contact your store of purchase.	11, 12 6 6
Howling noise produced when volume is high.	• Turntable and speaker systems too close together. • Floor is unstable and vibrates easily.	• Separate as much as possible. • Use cushions to absorb speaker vibrations transmitted by floor. If turntable is not equipped with insulators, use audio insulators (commonly available).	— —
Sound is distorted.	• Stylus pressure too weak. • Dust or dirt on stylus. • Cartridge defective.	• Apply proper stylus pressure. • Check stylus. • Replace cartridge.	— — —
Volume is weak.	• MC cartridge being used.	• Replace with MM cartridge or use a head amplifier or step-up transformer.	6
Receiver does not operate properly when remote control unit is used.	• Batteries dead. • Remote control unit too far from receiver. • Obstacle between receiver and remote control unit. • Different button is being pressed. • B and C model battery inserted in reverse.	• Replace with new batteries. • Move closer. • Remove obstacle. • Press the proper button. • Insert batteries properly.	8, 9 8, 9 8, 9 8, 9 8, 9

9 SPECIFICATIONS

- Audio Section (Power amplifier)**

Rated output:	FRONT (main 2ch driven) 60 W + 60 W (8 Ω/ohms, 20 Hz – 20 kHz with 0.08% THD) 90 W + 90 W (6 Ω/ohms, EIAJ)	
(All properties shown are only for the power amplifier stage.)	CENTER (center 1ch driven) 60 W (8 Ω/ohms, 20 Hz – 20 kHz with 0.08% THD) 90 W (6 Ω/ohms, EIAJ)	
	REAR (rear 2ch driven) 15 W + 15 W (8 Ω/ohms, 1 kHz with 0.3% THD) 25 W + 25 W (6 Ω/ohms, EIAJ)	
Output terminals:	Front: 6 to 16 Ω/ohms (for North America model) 8 to 16 Ω/ohms (for Asia model)	
	Center: 8 to 16 Ω/ohms	
	Rear: 8 to 16 Ω/ohms	

- (Pre-amplifier)**

Line input (Each line input – FRONT SP OUT)		
Input sensitivity / impedance:	150 mV/47 kΩ/kohms	PHONO (MM): 2.5 mV/47 kΩ/kohms
Frequency response:	10 Hz to 50 kHz:	±3 dB
Tone control range:	BASS:	± 10 dB at 100 Hz
	TREBLE:	± 10 dB at 10 kHz
Signal-to-noise ratio:	92 dB (STEREO)	
Phono equalizer (PHONO input – REC OUT)		
RIAA deviation:	± 1 dB (20 Hz to 20 kHz)	
Signal-to-noise ratio:	74 dB (A weighting, with 5 mV input)	
Rated output / Maximum output:	150 mV / 8 V	
Distortion factor:	0.03% (1 kHz, 1 V)	

- Tuner Section**

Receiving Range:	[FM] (note: μV at 75 Ω/ohms, 0 dBf = 1×10^{-15} W) 87.5 MHz ~ 107.9 MHz (for North America model)	[AM] 520 kHz ~ 1710 kHz (for North America model)
	87.50 MHz ~ 108.00 MHz (for Asia and Taiwan R.O.C. models)	522 kHz ~ 1611 kHz (for Asia and Taiwan R.O.C. models)
Usable Sensitivity:	1.0 μV (11.2 dBf)	18 μV
50 dB Quieting Sensitivity:	MONO 1.6 μV (15.3 dBf) STEREO 23 μV (38.5 dBf)	
Signal to Noise Ratio (IHF-A):	MONO 80 dB STEREO 75 dB	50 dB
Total Harmonic Distortion (at 1 kHz):	MONO 0.15% STEREO 0.3%	

- Video Section**

Standard video jacks	
input and output level / impedance:	1 Vp-p/75 Ω/ohms
Frequency response:	2 Hz to 8 MHz +0, -3 dB

- General**

Power supply:	AC 120 V, 60 Hz (for North America and Taiwan R.O.C. models) AC 230 V, 50 Hz (for Asia model)
Power consumption:	4.0 A (for North America model) 200 W (for Asia model)
Maximum external dimensions:	434 (W) × 142 (H) × 303 (D) mm (17-3/32" × 5-19/32" × 11-15/16")
Weight:	7.7 kg (17 lbs)

- Remote control unit**

System remote control RC-195:	
Total buttons:	28
DENON system code	
CD player:	6 buttons } (SWITCHED)
Cassette deck:	6 buttons }
AVR-900 fixed codes:	22 buttons
Batteries:	R6P/AA Type (two batteries)
External dimensions:	51 (W) × 175 (H) × 18.5 (D) mm (2" × 6-57/64" × 47/64")
Weight:	100 g (Approx. 3.5 oz) (including batteries)

* For purposes of improvement, specifications and design are subject to change without notice.

WIRE ARRANGEMENT

In case of wires require unclasping or loosening to move the location to perform adjustment or part replacement, be sure to rearrange them neatly to restore properly in the same location as they were originally placed, or causing to produce a noise may occasionally occur.

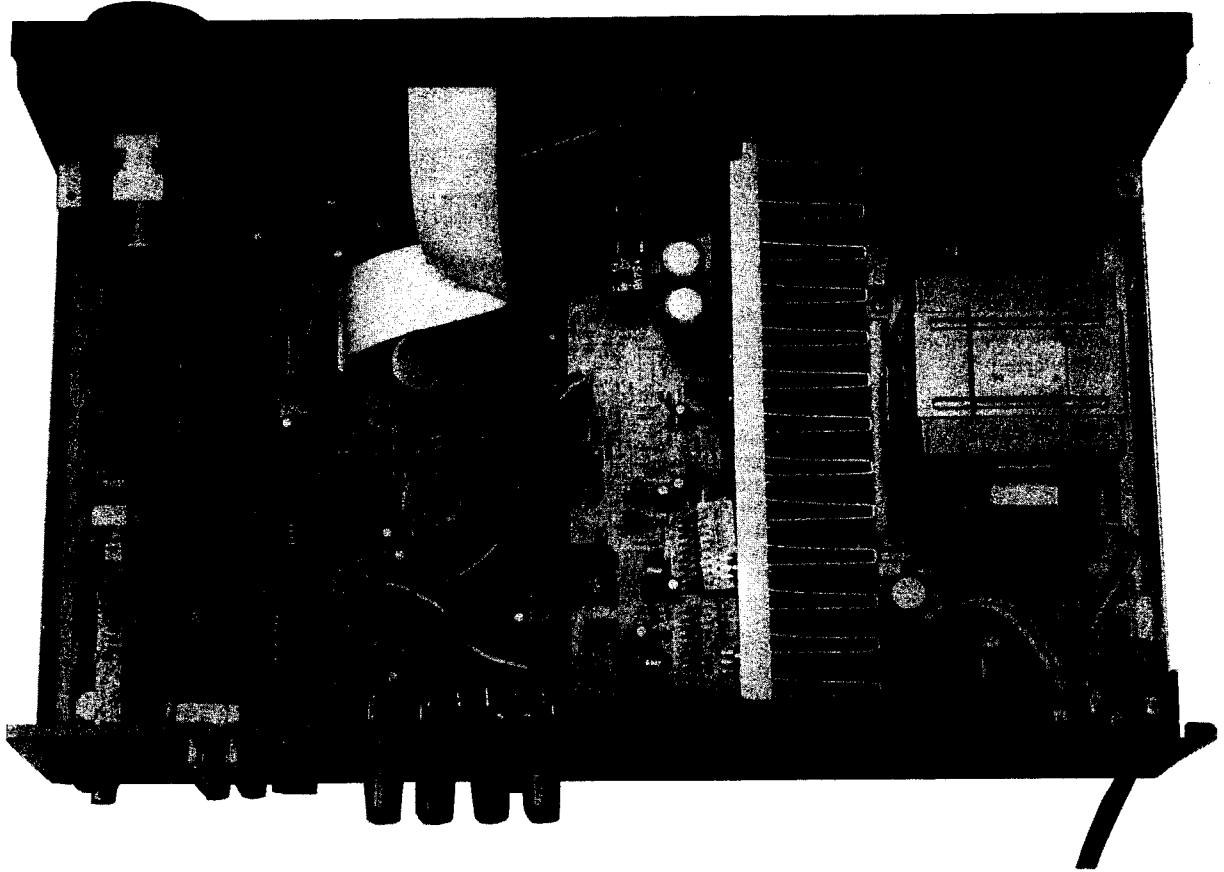

DISASSEMBLY

(To reassemble reverse disassembly)

1. Top Cover

Remove 4 screws ① and 3 screws ② .

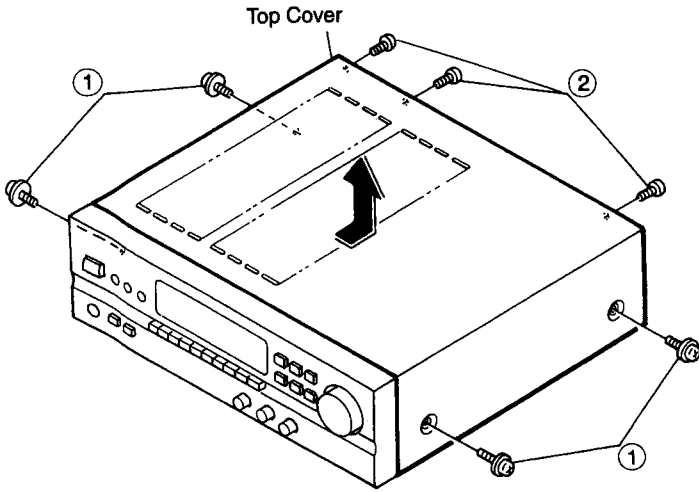

3. Front Mold Panel

- (1) Pull out Volume knob ④ and 3 round knobs ⑤ .
- (2) Remove 4 nuts ⑥ .
- (3) Remove 2 screws ⑨ .

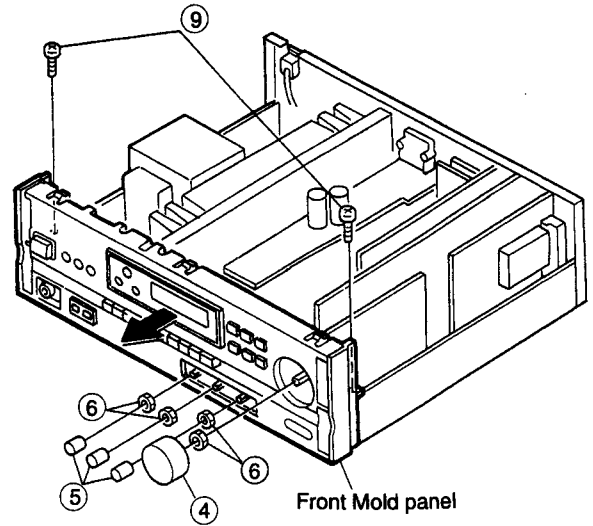

2. Front Aluminium Panel

Remove 5 screws ③ .

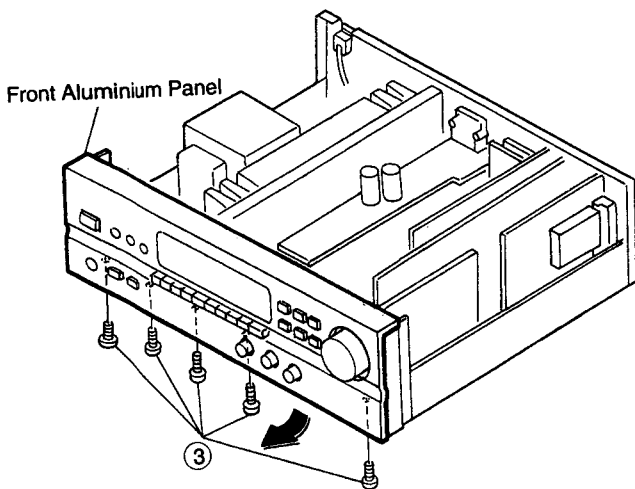

4. Rear Panel

- (1) Disconnect cord bush ⑩ .
- (2) Remove 7 screws ⑪ , and 17 screws ⑫ .

* Screws ⑫ is tighten.

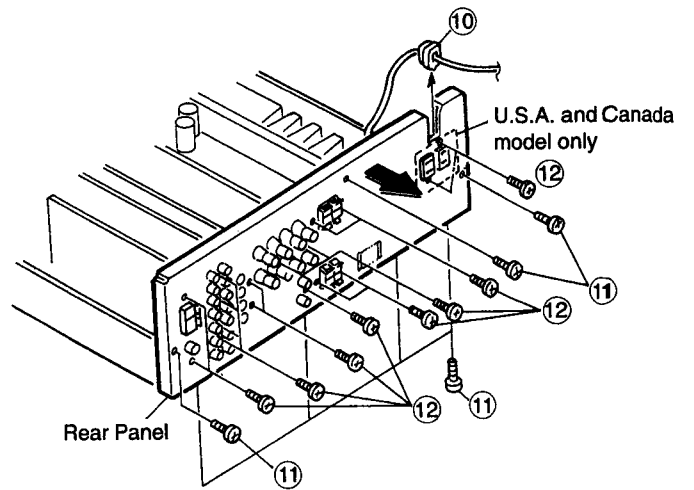

CONNECTION DIAGRAM OF MEASURING INSTRUMENTS

● FM SECTION

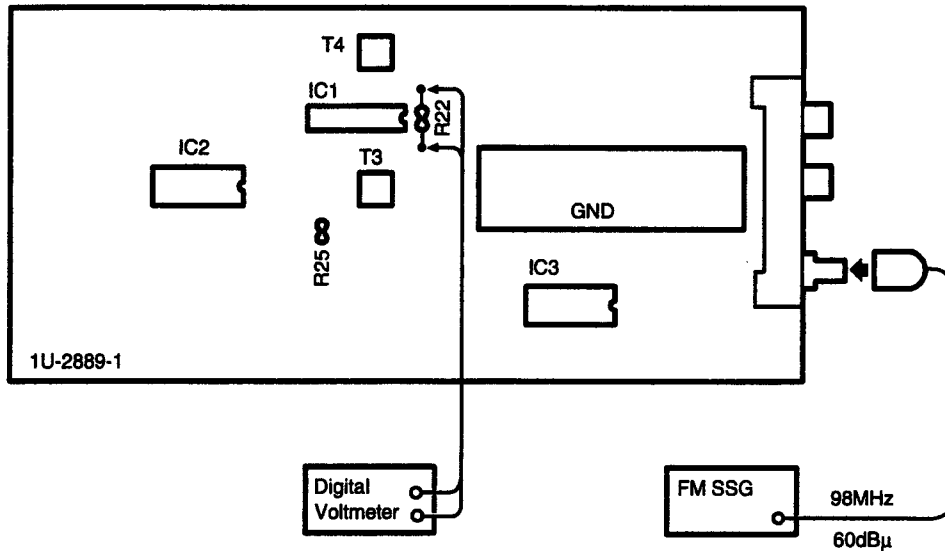

Adjust T4 potential difference across R22 should be within 50mV.

● Initiating (Memory clearing) Method

To clear memory contents of microcomputer and restore to the initial state, take the following steps;

1. Press power switch, turn off power of the unit, and set to standby mode.
2. Pull out power cord from wall outlet temporarily.
3. Insert power cord into outlet while simultaneously pressing two keys of TUNER and VIDEO SELECT.
4. Press power switch to confirm that memory contents are cleared.

By completion of the above, the initial state is restored. In case the memory can not be cleared due to some reasons, repeat steps 1 through 3.

● AUDIO SECTION

Idling Current (1U-2865-1)

Required measurement equipment: DC Voltmeter

Arrangement

(1) Avoid direct blow from an air conditioner or an electric fan, and adjust the unit at normal room temperature 15°C ~ 30°C. (59°F ~ 86°F).

(2) Presetting

- POWER (Power source switch) → ON
- MODE (Mode button) → STEREO
- FUNCTION (Function button) → CD
- VOLUME (Volume control) → 0: fully counterclockwise (1/4 min.)
- BASS, TREBLE (Tone control) → 0: (Controls to center)
- SPEAKERS (Speaker terminal) → No load (Do not connect speaker, dummy resistor, etc.)

Adjustment

- (1) Remove top cover and set VR401, VR301 and VR302 of 1U-2865-1 or 1U-2865A-1 (Main Unit) at counterclockwise fully.
- (2) Connect DC Voltmeter to test points (Lch T.P.301, Rch T.P.302, CENTER ch T.P.401).
- (3) Connect power cord to AC Line, and turn power switch "ON".
- (4) Allow 15 minutes, and turn VR301, VR302 and VR401 clockwise (1/4) and adjust the TEST POINTS voltage to 1.5 mV ± 0.5 mV DC.
- (5) After 2 minutes from preset, turn VR301, VR302 and VR401 to set the voltage to 3 mV ± 0.5mV DC.

1U-2865-1 Main Unit (Component Side)

	UNIT No.
U.S.A. and CANADA	1U-2865
EUROPE, U.K., Asia	1U-2865A

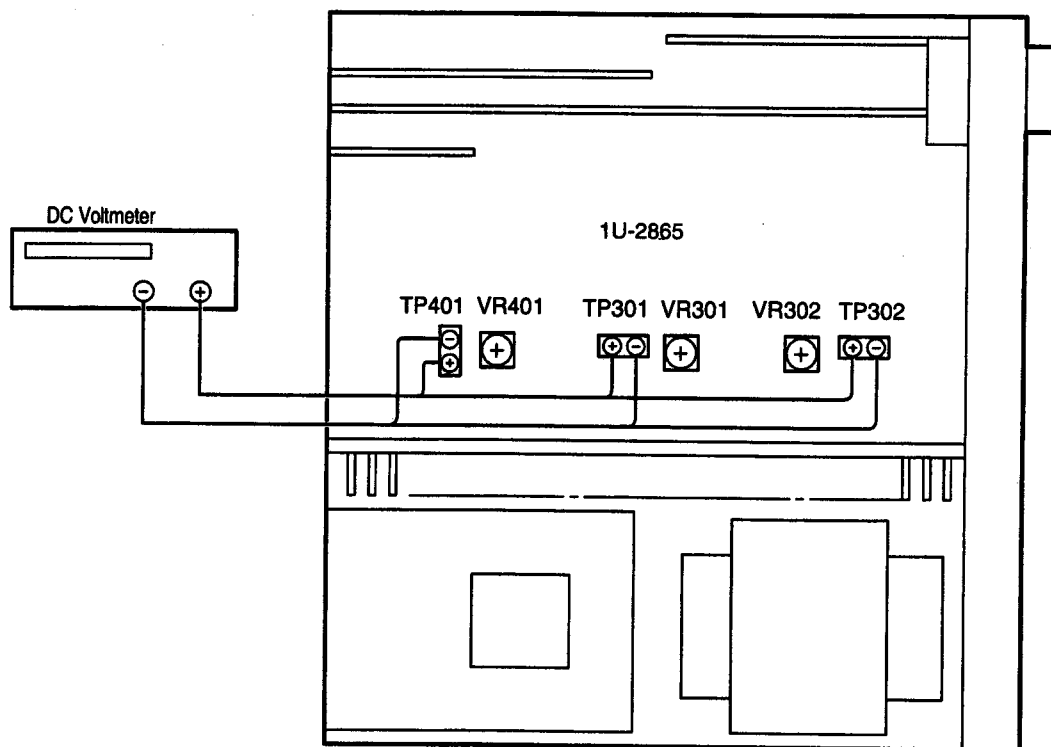

SEMICONDUCTORS

● IC's TMP87CM71F-6314 (IC701)

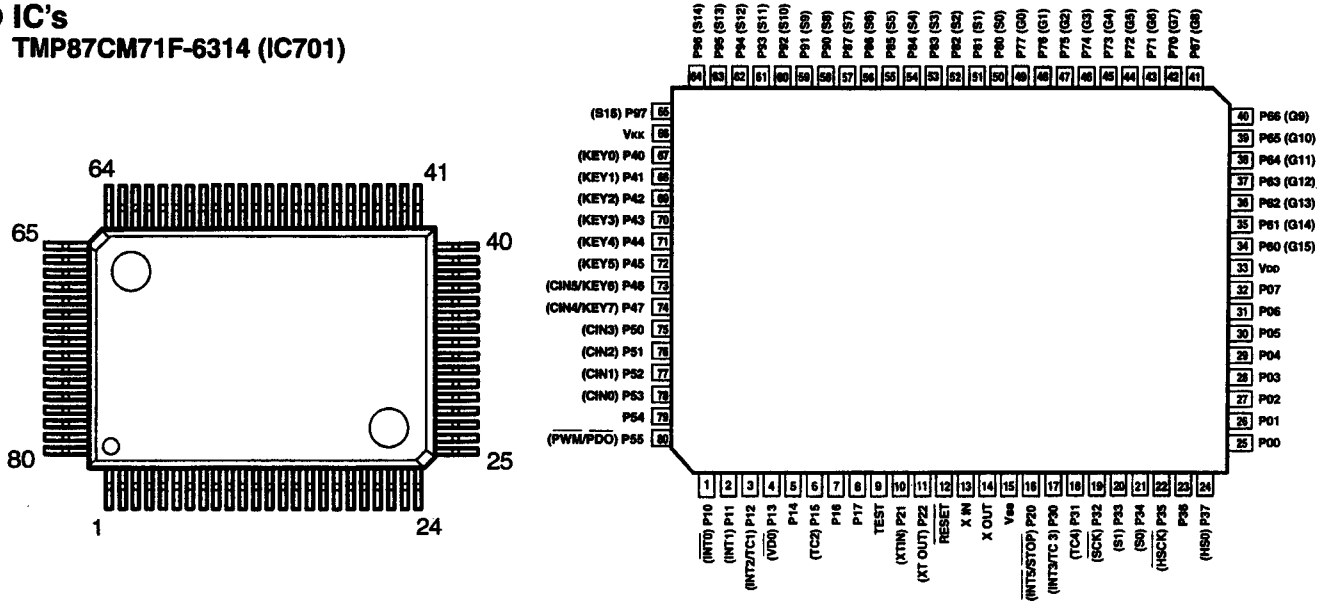

TMP87CM71F-6314 Terminal Function

Pin No.	Symbol	I/O	Type	Op	Det	Res	Ini	Function
1	STOP	I	—	Eu	Lv	Z	—	Detect power stop ("L" at power stop)
2	PROTECTION	I	—	Eu	E&L	Z	—	Protection input ("H" at protection)
3	EXP. DATA	O	C	—	—	Z	L	Port expand data output
4	EXP. CK	O	C	—	—	Z	L	Port expand clock output
5	EXP. STB	O	C	—	—	Z	L	Port expand strobe output
6	VR. CK	O	C	—	S	Z	L	TC9176 (electron VR) control clock output
7	VR. DATA	O	C	—	S	Z	L	TC9176 (electron VR) control data output
8	VR. STB	O	C	—	—	Z	L	TC9176 (electron VR) control strobe output
9	TEST	I	—	GND	—	—	—	Connect to ground
10	TUNED	I	—	Eu	Lv	Z	—	"L" at stereo receive
11		O	—	—	—	Z	L	Fixed output on "L"
12	RESET	I	—	Eu	Lv	Z	—	Reset input
13	X IN	I	—	—	—	—	—	Oscillating circuit (4 MHz)
14	X OUT	O	—	—	—	—	—	Oscillating circuit (4 MHz)
15	GND	I	—	GND	—	—	—	Ground
16	RDS START	I	—	Eu	Ed	Z	—	RDS data, Start signal input (LC704)*
17	REMOCON	I	—	Eu	E&L	Z	—	Remote control signal input
18	STEREO	I	—	Eu	—	Z	L	"L" at TUNER stereo receive
19	RDS. CK	I	—	Eu	S	Z	—	RDS clock input (LC7074)*
20	RDS. DATA	I	—	Eu	S	Z	—	RDS data input (LC7074)*
21	RDS. RESET	O	N	Eu	—	Z	L	RDS reset signal output (LC7074)*
22	PLL. CK	O	N	Eu	—	Z	L	LM7001 control clock output
23	PLL. STB	O	N	Eu	—	Z	L	LM7001 control strobe output
24	PLL. DATA	O	N	Eu	—	Z	L	LM7001 control data output
25	FUNC. DATA	O	C	—	—	Z	L	LC7822 (Function IC) control data output
26	FUNC. CK	O	C	—	—	Z	L	LC7822 (Function IC) control clock output
27	FUNC. STB	O	C	—	—	Z	L	LC7822 (Function IC) control strobe output
28	ST/MONO	O	C	—	—	Z	L	TUNER STEREO/MONO control output ("L" at STEREO)
29	POWER OFF	O	C	—	—	Z	L	"L" at ON
30	VOL. DOWN	O	C	—	—	Z	L	Electrically-driven volume control output (BA6208S)

* port is fixed on "L" at RDS non-selection mode.

Pin No.	Symbol	I/O	Type	Op	Det	Res	Ini	Function
31	VOL UP	O	C	—	—	Z	L	Electrically-driven volume control output (BA6208S)
32	SP-FRONT	O	C	Ed	—	Z	H	Front speaker relay control output
33	VDD	I	—	—	—	—	—	Connect to +5V
34	LED. PRO	O	P	Id	—	L	L	DOLBY PROLOIC indicating LED drive output ("H" at light)
35	LED. STBY	O	P	Id	—	L	L	Standby indicating LED drive output ("H" at light)
36	1G	O	P	Id	S	L	L	FLD control output
37	2G	O	P	Id	S	L	L	FLD control output
38	3G	O	P	Id	S	L	L	FLD control output
39	4G	O	P	Id	S	L	L	FLD control output
40	5G	O	P	Id	—	L	L	FLD control output
41	6G	O	P	Id	—	L	L	FLD control output
42	7G	O	P	Id	—	L	L	FLD control output
43	8G	O	P	Id	—	L	L	FLD control output
44	9G	O	P	Id	—	L	L	FLD control output
45	10G	O	P	Id	—	L	L	FLD control output
46	11G	O	P	Id	—	L	L	FLD control output
47	12G	O	P	Id	—	L	L	FLD control output
48	13G	O	P	Id	—	L	L	FLD control output
49	14G	O	P	Id	—	L	L	FLD control output
50	P (a)	O	P	Id	—	L	L	FLD control output
51	P (b)	O	P	Id	—	L	L	FLD control output
52	P (c)	O	P	Id	—	L	L	FLD control output
53	P (d)	O	P	Id	—	L	L	FLD control output
54	P (e)	O	P	Id	—	L	L	FLD control output
55	P (f)	O	P	Id	—	L	L	FLD control output
56	P (g)	O	P	Id	—	L	L	FLD control output
57	P (h)	O	P	Id	—	L	L	FLD control output
58	P (i)	O	P	Id	—	L	L	FLD control output
59	P (k)	O	P	Id	—	L	L	FLD control output
60	P (m)	O	P	Id	—	L	L	FLD control output
61	P (n)	O	P	Id	—	L	L	FLD control output
62	P (p)	O	P	Id	—	L	L	FLD control output
63	P (q)	O	P	Id	—	L	L	FLD control output
64	P (r)	O	P	Id	—	L	L	FLD control output
65	P (s)	O	P	Id	—	L	L	FLD control output
66	VKK	I	—	—	—	—	—	Connect to Vkk
67	DD. CK	O	N	Eu	—	Z	H	NJU9701G (Delay time) control clock output
68	DD. REQ	O	N	Eu	—	Z	H	NJU9701G (Delay time) control request output
69	DD. DATA	O	N	Eu	—	Z	H	NJU9701G (Delay time) control data output
70	MODE2	I	N	Id	—	Z	—	Select occurring or no RDS function ("H" at occurring RDS function)
71	VIDEO A	O	N	Eu	—	Z	H	BU4066 (Video shift) control output ("L" at selecting)
72	VIDEO B	O	N	Eu	—	Z	H	BU4066 (Video shift) control output ("L" at selecting)
73	KEY 5	I	—	Eu	Lv	Z	—	Button input 5
74	KEY 4	I	—	Eu	Lv	Z	—	Button input 4
75	KEY 3	I	—	Eu	Lv	Z	—	Button input 3
76	KEY 2	I	—	Eu	Lv	Z	—	Button input 2
77	KEY 1	I	—	Eu	Lv	Z	—	Button input 1
78	MODE 1	I	—	Eu	Lv	Z	—	Model version change input
79	TU MUTE	O	N	Eu	—	Z	L	Tuner muting output ("L" at muting)
80		O	N	Eu	—	Z	H	Fixed output on "H"

* port is in active software pull down mode.

LA1265 (S)
(IC001)

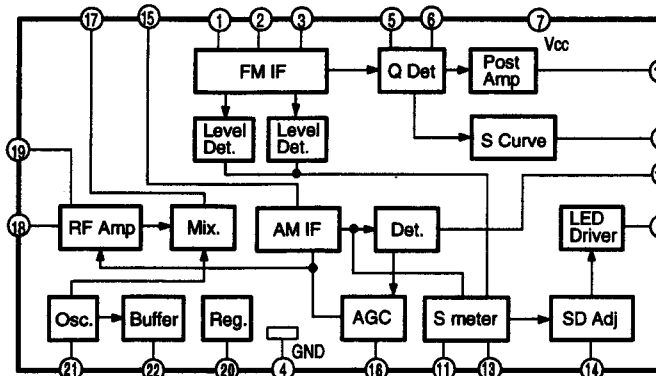
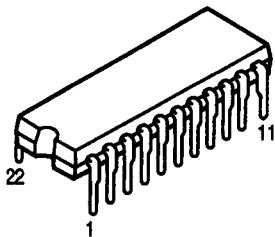

LA3401
(IC002)

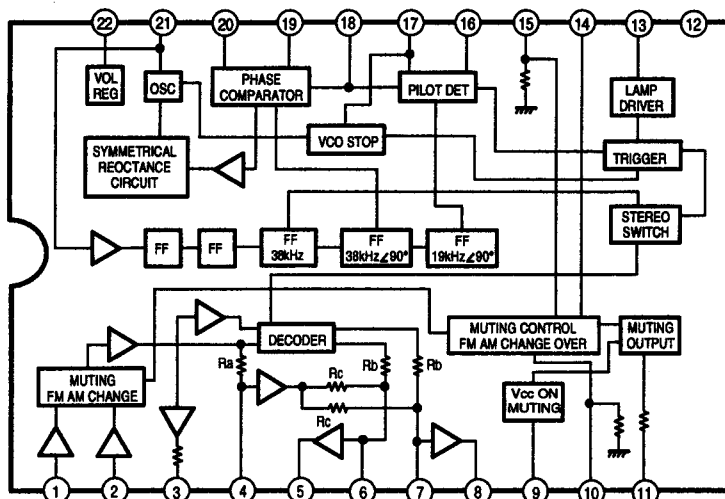
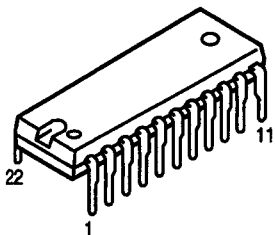

BA6208S
(IC264)

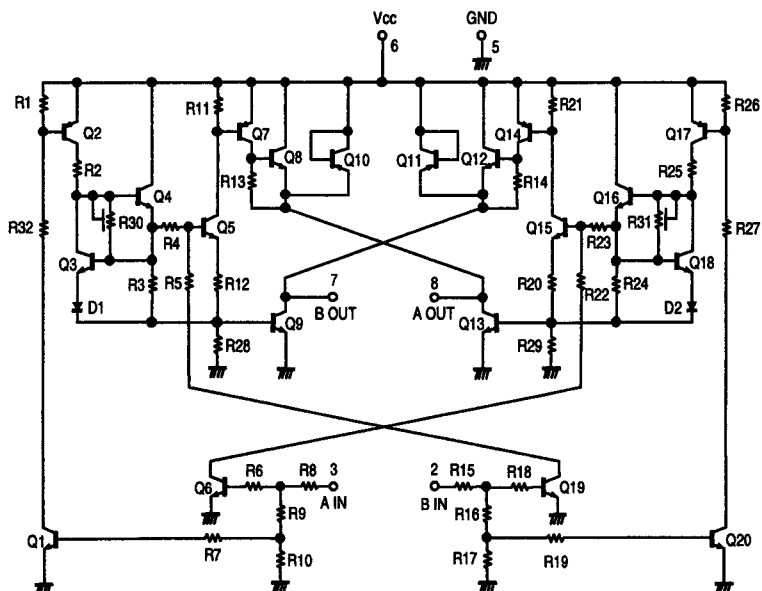
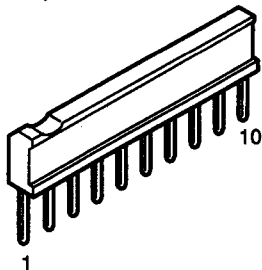

LM7001 (IC003)

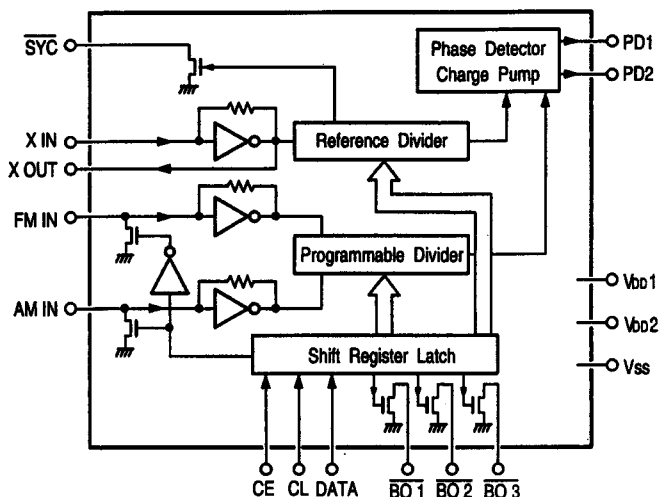
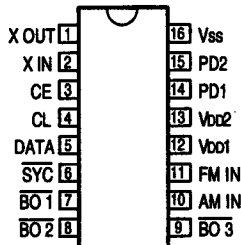
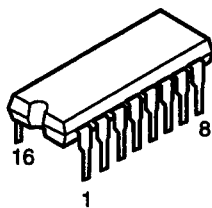

Terminal Description

- SYC : Clock for controller (400 kHz).
- XIN, XOUT : X'tal OSC (7.2 MHz).
- FMIN, AMIN : Station oscillation signal input.
- CE, CL, DATA : Data input.
- BO1, BO2, BO3 : Band data output. BO1 is feasible for time base output (8 Hz).
- Vdd1, Vdd2, Vss : Power supply. (VDD2 is for back-up).
- Pd1, Pd2 : Charge pump output.

Data input

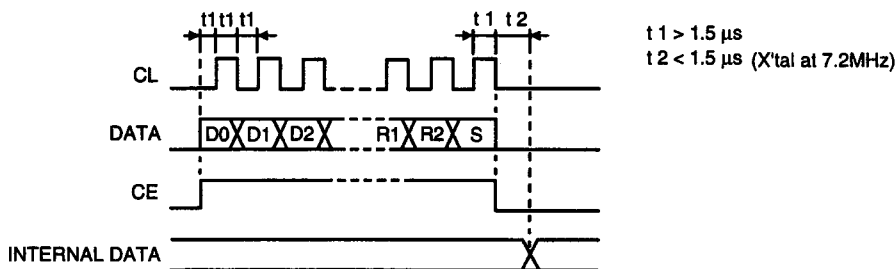

Input from D0.

D0	D1	D2	D3	D4	D5	D6	D7	D8	D9	D10	D11	D12	D13	T0	T1	B0	B1	B2	TB	R0	R1	R2	S
----	----	----	----	----	----	----	----	----	----	-----	-----	-----	-----	----	----	----	----	----	----	----	----	----	---

(1) D0 (LSB)~D13 (MSB): Frequency dividend data

For FMIN, use D0~D13; for AMIN, use D4~D13.

D0	D1	D2	D3	D4	D5	D6	D7	D8	D9	D10	D11	D12	D13
----	----	----	----	----	----	----	----	----	----	-----	-----	-----	-----

1 0 1 0 0 0 0 0 0 1 0 1 1 1 → FMIN Frequency dividend nnumber = 14853

LSB

MSB

x x x x 0 0 0 0 0 1 0 1 1 1 → FMIN Frequency dividend nnumber = 928

LSB

MBS

(2) T0, T1: For test of LSI (0, 0)

LC7822 (IC102)

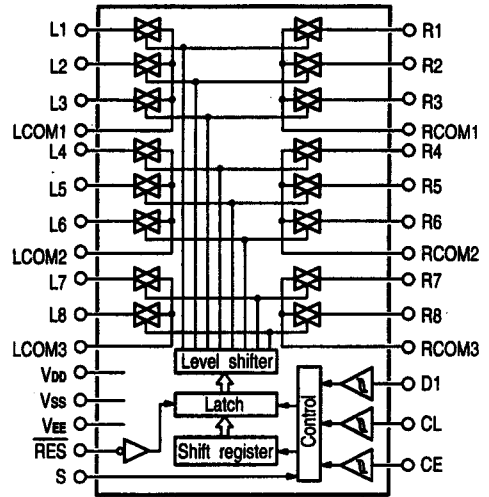
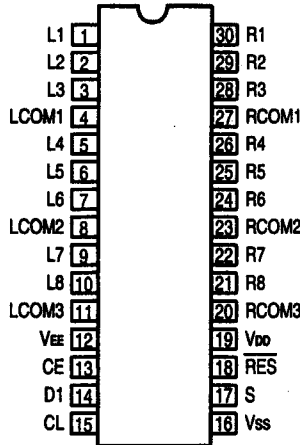
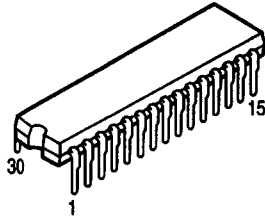

LC7822 Terminal Function

Name of Terminal	I/O	Equivalent Internal Circuit	Function of Terminal																					
VDD, VSS, VEE			Power terminal.																					
L1 - L8, R1 - R8 LCOM1 - LCOM4, BCOM1 - BCOM4		Refer to block diagram	In/Out terminal of analog switch.																					
CL, DI, CE	I		Serial data input terminal (Schmitt buffer). CL = Clock input terminal. DI = Data input terminal. CE = Chip enable terminal.																					
S	I		Selection terminal for using of two. Address will be shifted as per below table when switching S terminal to L or H. <table border="1" style="margin: 10px auto;"> <thead> <tr> <th rowspan="2">Name of Item</th> <th rowspan="2">S Terminal</th> <th colspan="4">Address</th> </tr> <tr> <th>A0</th> <th>A1</th> <th>A2</th> <th>A3</th> </tr> </thead> <tbody> <tr> <td rowspan="2">LC7822</td> <td>L</td> <td>0</td> <td>1</td> <td>0</td> <td>1</td> </tr> <tr> <td>H</td> <td>1</td> <td>1</td> <td>0</td> <td>1</td> </tr> </tbody> </table>	Name of Item	S Terminal	Address				A0	A1	A2	A3	LC7822	L	0	1	0	1	H	1	1	0	1
Name of Item	S Terminal	Address																						
		A0	A1	A2	A3																			
LC7822	L	0	1	0	1																			
	H	1	1	0	1																			
RES	I		Reset terminal. Condition of analog switch is not fixed at the time of turning on the power. When shift this terminal to L, all analog switches become OFF.																					

NJU9701G (IC202)

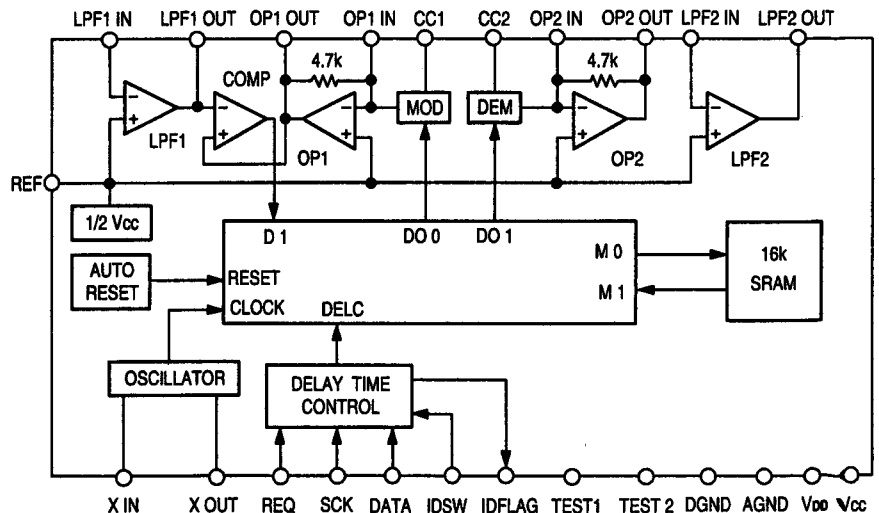
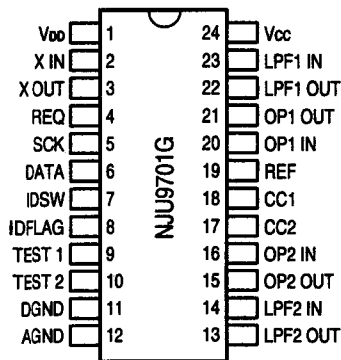

BA4558F (IC101, 103)

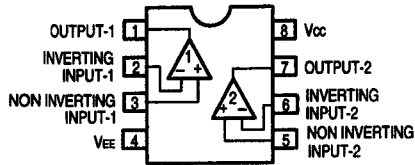
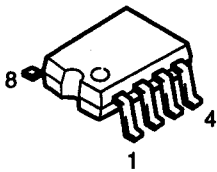

**BA4558 (IC261, 236)
BA15218 (IC451)**

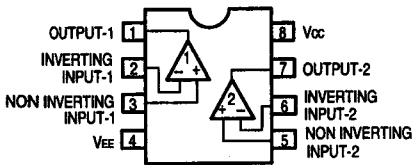
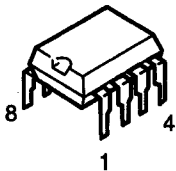

TC9176P (IC262)

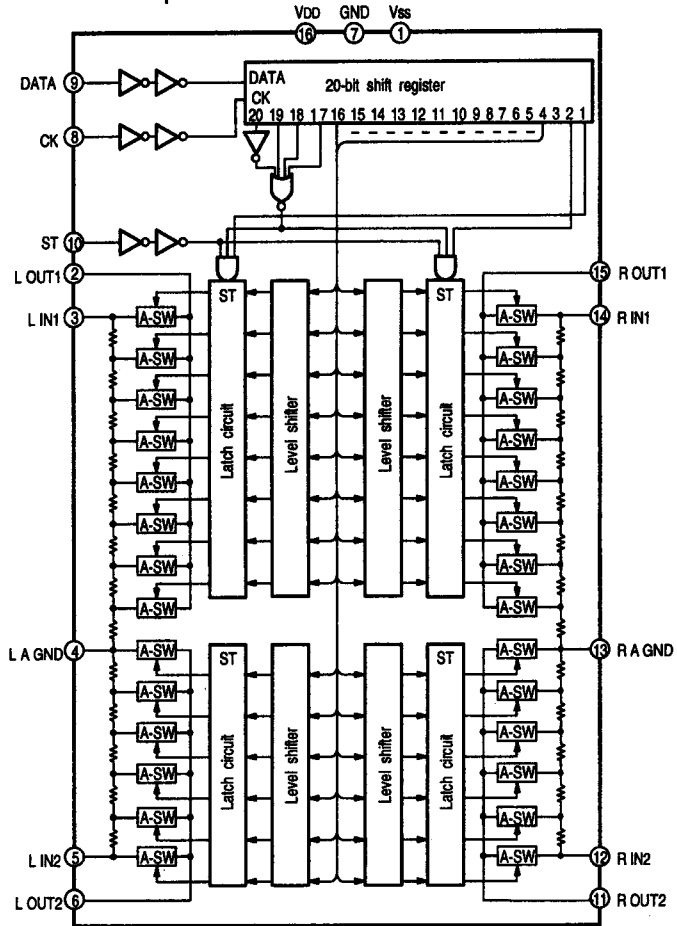
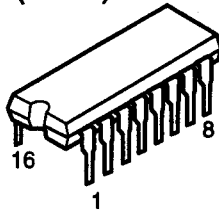

DDSC-A (IC201)

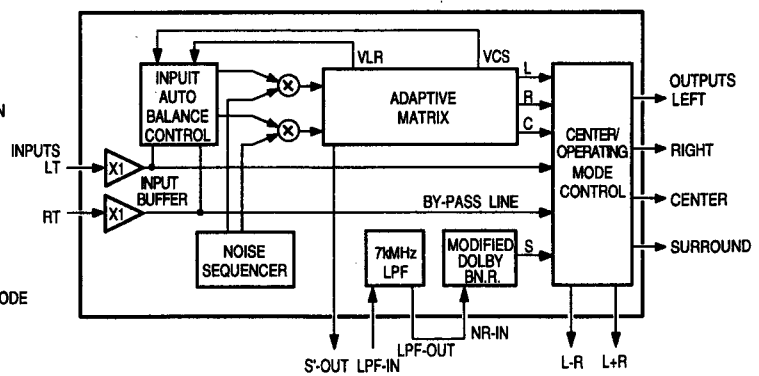
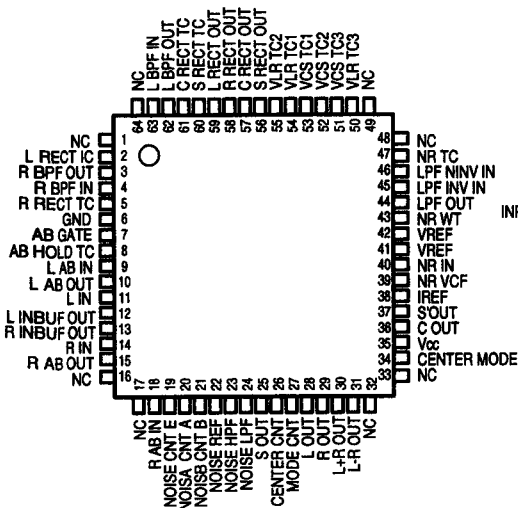

BU4066BCF
(IC203, 205)

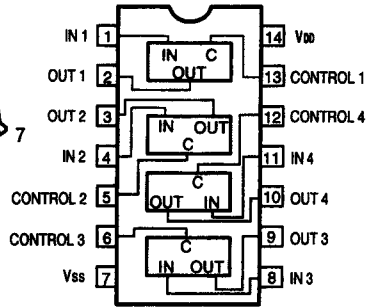
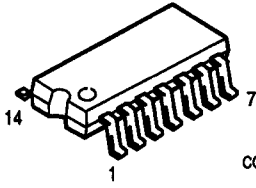

BU4066BC
(IC601)

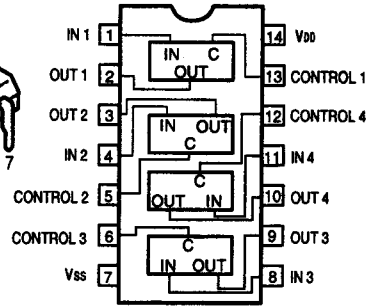
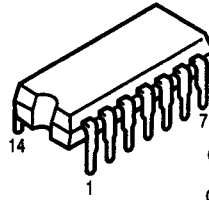

μPD4094BC
(IC913, 914)

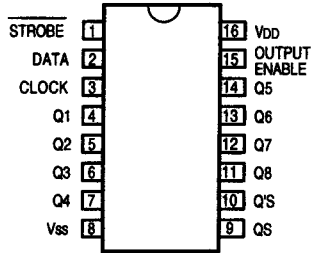
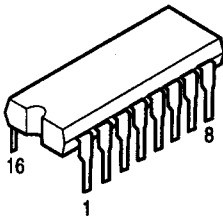

SI-18751
(IC501, 502)

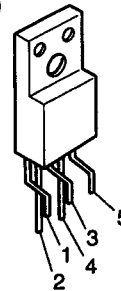

- 1: +IN
- 2: - IN
- 5: -VEE
- 4: OUTPUT
- 5: +Vcc

NJM7806FA (S) (IC551)
NJM7812FA (S) (IC503)

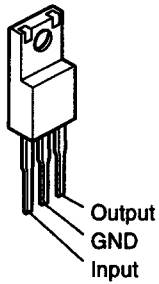

NJM7912FA
(IC504)

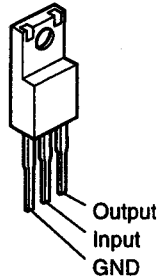

● **IC PROTECTORS**

ICP-N15 (IC552)
ICP-N20 (IC505, 506)

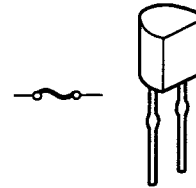

● **OTHERS**

SBX1610-52 (Remote Control Sensor)

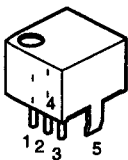

- 1. Vcc
- 2. Output
- 3. GND
- 4. Case Fin
- 5. Case Fin

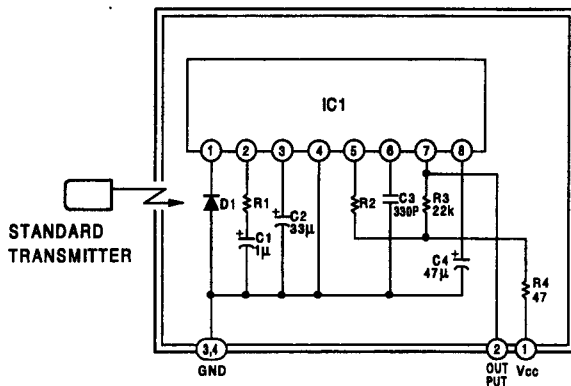

- IC1 : CX20106A Chip
- D1 : PIN Photo Diode Chip
- C1, C2, C4 : Aluminum Electrolytic Capacitor
- C3 : SL Characteristic ±5%
- R1 : Gain Adjuster
- R2 : fo Adjuster ±1% USE
- R3, R4 : ±5%

● TRANSISTORS

2SA970 (BL)
 2SA988 (E/F)
 2SC1015 (GR)
 2SC1815 (Y),(BL)
 2SC1841 (E/F)
 2SC2058 (Q)
 2SC2878 (A/B)

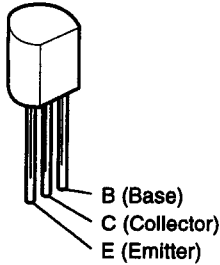

2SB647A (C)
 2SB1041 (R)
 2SD667A (C)
 2SD1292 (R)

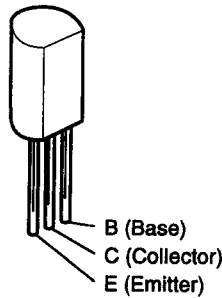

2SK365 (BL/RG)
 (FET)

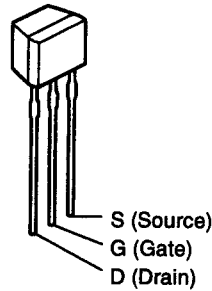

2SA933S (S)
 2SC1740S (S)

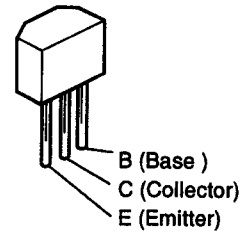

DTA114ES
 DTA114TS
 DTA143ES
 DTC114ES
 DTC143ES
 DTC144TS
 DTC323TS

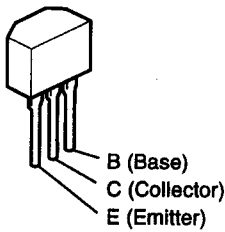

DTA144EK
 DTC143EK
 DTC144EK

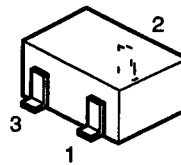

1: GND/Emitter
 2: Out/Collector
 3: In/Base

PNP Type

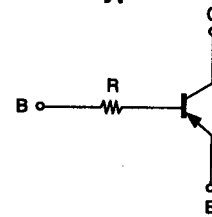

	R
DTA114TS	10kohm

NPN Type

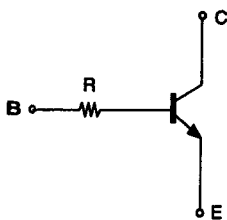

	R
DTC144TS	4.7kohm
DTC323TS	2.2kohm

NPN Type

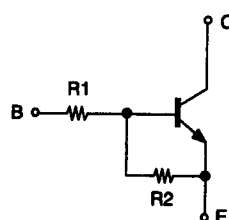

	R1	R2
DTC114ES	10kohm	10kohm
DTC143ES	4.7kohm	4.7kohm
DTC143EK	4.7kohm	4.7kohm
DTC144EK	47kohm	47kohm

PNP Type

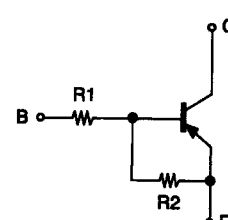

	R1	R2
DTA114ES	10kohm	10kohm
DTA143ES	4.7kohm	4.7kohm
DTA144EK	47kohm	47kohm

● DIODES (included LED)

1SS252
1S2471

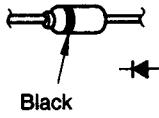

MTZJ3.3A MTZJ8.2B
MTZJ6.2A MTZ27D
MTZJ7.5A

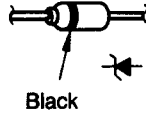

1SR35-200A

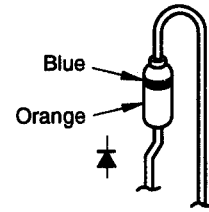

SEL1210S (Red)

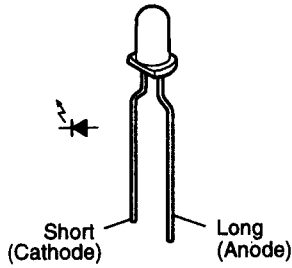

S4VB20

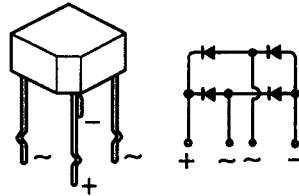

FL (FIP14AM7R)
(FL701)

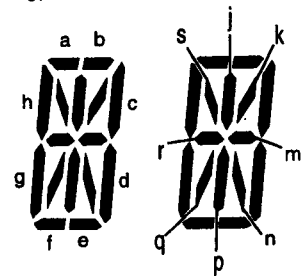
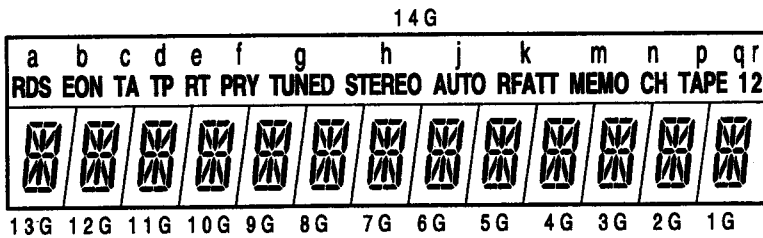
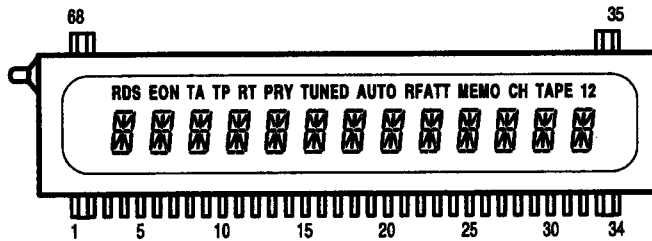

TERMIAL CONNECTION
(UPPER)

TERMINAL No.	68	67	66	65	64	63	62	61	60	59	58	57	56	55	54	53	52			
ELECTRODE	F1	F1	F1	NP	NP	NP	NP	NP	NP	NP	NP	NP	NP	NP	NP	NP	NP			
TERMINAL No.				51	50	49	48	47	46	45	44	43	42	41	40	39	38	37	36	35
ELECTRODE				NP	NP	NP	NP	NP	NP	NP	NP	NP	NP	NP	NP	NP	NP	NP	F2	F2

(LOWER)

TERMINAL No.				18	19	20	21	22	23	24	25	26	27	28	29	30	31	32	33	34
ELECTRODE				P	14G	13G	12G	11G	10G	9G	8G	7G	6G	5G	4G	3G	2G	1G	F2	F2
TERMINAL No.	1	2	3	4	5	6	7	8	9	10	11	12	13	14	15	16	17			
ELECTRODE	F1	F1	P	P	P	P	P	P	P	P	P	P	P	P	P	P	P			
			s	r	q	p	n	m	k	j	h	g	f	e	d	c	b			

Notes: F: Filament G: Grid P: Anode NP: No-Pin

NOTE FOR PARTS LIST

- Part indicated with the mark "◎" are not always in stock and possibly to take a long period of time for supplying, or in some case supplying of part may be refused.
- When ordering of part, clearly indicate "1" and "1" (i) to avoid mis-supplying.
- Ordering part without stating its part number can not be supplied.
- Part indicated with the mark "★" is not illustrated in the exploded view.
- Not including Carbon Film ±5%, 1/4W Type in the P.W.Board parts list. (Refer to the Schematic Diagram for those parts.)

WARNING:

Parts marked with this symbol  have critical characteristics.
Use ONLY replacement parts recommended by the manufacturer.

● **Resistors**

Ex.: RN 14K 2E 182 G FR

Type	Shape and performance	Power	Resistance	Allowable error	Others
RD : Carbon		2B : 1/8W	F : ±1%	P : Pulse-resistant type	
RC : Composition		2E : 1/4W	G : ±2%	NL : Low noise type	
RS : Metal oxide film		2H : 1/2W	J : ±5%	NB : Non-burning type	
RW : Winding		3A : 1W	K : ±10%	FR : Fuse-resistor	
RN : Metal film		3D : 2W	M : ±20%	F : Lead wire forming	
RK : Metal mixture		3F : 3W			
		3H : 5W			

• **Resistance**

1 8 2 ⇒ 1800 ohm = 1.8 kohm
 Indicates number of zeros after effective number.
 2-digit effective number.

• Units: ohm

1 R 2 ⇒ 1.2 ohm
 1-digit effective number.
 2-digit effective number, decimal point indicated by R.

• Units: ohm

● **Capacitors**

Ex.: CE 04W 1H 2R2 M BP

Type	Shape and performance	Dielectric strength	Capacity	Allowable error	Others
CE : Aluminum foil electrolytic		0J : 6.3V	F : ±1%	HS : High stability type	
CA : Aluminum solid electrolytic		1A : 10V	G : ±2%	BP : Non-polar type	
CS : Tantalum electrolytic		1C : 16V	J : ±5%	HR : Ripple-resistant type	
CC : Film		1E : 25V	K : ±10%	DL : For charge and discharge	
CK : Ceramic		1V : 35V	M : ±20%	HF : For assuring high frequency	
CC : Ceramic		1H : 50V	Z : +80%	U : UL part	
CP : Oil		2A : 100V	-20%	C : CSA part	
CM : Mica		2B : 125V	P : +100%	W : UL-CSA type	
CF : Metallized		2C : 160V	-0%	F : Lead wire forming	
CH : Metallized		2D : 200V	C : ±0.25pF		
		2E : 250V	D : ±0.5pF		
		2H : 500V	= : Others		
		2J : 630V			

• **Capacity (electrolyte only)**

2 2 2 ⇒ 2200µF
 Indicates number of zeros after effective number.
 2-digit effective number.

• Units: µF.

2 R 2 ⇒ 2.2µF
 1-digit effective number.
 2-digit effective number, decimal point indicated by R.

• Units: µF.

• **Capacity (except electrolyte)**

2 2 2 ⇒ 2200pF = 0.0022µF
 (More than 2) — Indicates number of zeros after effective number.
 2-digit effective number.

• Units: µF.

2 2 1 ⇒ 220pF
 (0 or 1) — Indicates number of zeros after effective number.
 2-digit effective number.

• Units: pF.

• When the dielectric strength is indicated in AC, "AC" is included after the dielectric strength value.

Version P.W.B. name	U.S.A. & Canada	Europe	Multi-Voltage	U.K.
Main amp	1U-2865		1U-2865A	
Rear amp	1U-2866		1U-2866A	
Input & Surround	1U-2867		1U-2867A	
FLD & Video	1U-2883		1U-2883A	
Tuner & Volume	1U-2889	1U-2889A	1U-2889B	1U-2889A

PARTS LIST OF P. W. BOARD

1U-2865 MAIN AMP P.W.B. UNIT ASS'Y

for U.S.A. and Canada models

Ref. No.	Part No.	Part Name	Remarks
SEMICONDUCTORS GROUP			
IC451	263 0565 007	IC BA15218	
IC551	263 0793 002	IC NJM7806FA(S)	
IC552	268 0073 905	IC ICP-N15	
IC913,914	262 1295 001	IC UPD4094BC	
TR301~304	271 0094 919	Transistor 2SA970(BL)	
TR305,306	271 0131 924	Transistor 2SA988(E/F)	
TR307~312	273 0235 923	Transistor 2SC1841(E/F)	
TR313,314	273 0198 002	Transistor 2SC1815(Y)	
TR315,316	274 0060 900	Transistor 2SD667A(C)	
TR317,318	271 0053 908	Transistor 2SB647A(C)	
TR323,324	273 0235 923	Transistor 2SC1841(E/F)	
TR325	271 0131 924	Transistor 2SA988(E/F)	
TR351,352	271 0131 924	Transistor 2SA988(E/F)	
TR353	273 0303 910	Transistor 2SC1740S(S)	
TR354	271 0192 905	Transistor 2SA933S(S)	
TR355	272 0131 901	Transistor 2SB1041(R)	
TR401	271 0094 919	Transistor 2SA970(BL)	
TR403	271 0094 919	Transistor 2SA970(BL)	
TR405	271 0131 924	Transistor 2SA988(E/F)	
TR407	273 0235 923	Transistor 2SC1841(E/F)	
TR409	273 0235 923	Transistor 2SC1841(E/F)	
TR411	273 0235 923	Transistor 2SC1841(E/F)	
TR413	273 0198 002	Transistor 2SC1815(Y)	
TR415	274 0060 900	Transistor 2SD667A(C)	
TR417	271 0053 908	Transistor 2SB647A(C)	
TR423	273 0235 923	Transistor 2SC1841(E/F)	
TR441	273 0253 918	Transistor 2SC2878(A/B)	
TR442	269 0022 904	Transistor DTA143ES(4.7k-4.7k)	
TR443	269 0018 905	Transistor DTC143ES(4.7k-4.7k)	
TR481~483	273 0303 910	Transistor 2SC1740S(S)	
TR484,485	273 0303 910	Transistor 2SC1740S(S)	
TR487	271 0192 905	Transistor 2SA933S(S)	Built in resistor
TR488	273 0303 910	Transistor 2SC1740S(S)	Built in resistor
TR551	273 0303 910	Transistor 2SC1740S(S)	Built in resistor
TR801	269 0018 905	Transistor DTC143ES(4.7k-4.7k)	Built in resistor
TR802	273 0303 910	Transistor 2SC1740S(S)	Built in resistor
TR803	269 0022 904	Transistor DTA143ES(4.7k-4.7k)	
TR902~904	269 0022 904	Transistor DTA143ES(4.7k-4.7k)	
D301~306	276 0616 907	Diode 1SS252	
D307~310	276 0619 904	Diode 1S2471	
D311,312	276 0616 907	Diode 1SS252	
D351	276 0305 001	Diode S4VB20	

Ref. No.	Part No.	Part Name	Remarks
D352	276 0616 907	Diode 1SS252	
D401	276 0616 907	Diode 1SS252	
D403	276 0616 907	Diode 1SS252	
D405	276 0616 907	Diode 1SS252	
D407	276 0619 904	Diode 1S2471	
D409	276 0619 904	Diode 1S2471	
D411	276 0616 907	Diode 1SS252	
D441	276 0616 907	Diode 1SS252	
D481,482	276 0616 907	Diode 1SS252	
D801	276 0553 905	Diode 1SR35-200A	
D802~804	276 0616 907	Diode 1SS252	
D912	276 0616 907	Diode 1SS252	
ZD351	276 0632 907	Zener diode MTZJ27D	
ZD551	276 0644 911	Zener diode MTZJ7.5A	
ZD801	276 0634 905	Zener diode MTZJ3.3A	

RESISTORS GROUP

VR301,302	211 6064 048	Semi fixed resistor 5kohm	V06PB502
VR401	211 6064 048	Semi fixed resistor 5kohm	V06PB502
VR451	211 0798 103	Variable resistor 100kohm	V14V20FW104K
VR452	211 0797 117	Variable resistor 30kohm	V14V20FC303K
VR453	211 0797 133	Variable resistor 10kohm	V14V20FC103K
△R315~318	241 2380 963	Carbon 2.2kohm 1/4W	RD14B2E22JNBS
△R319,320	241 2315 967	Carbon 68ohm 1/4W	RD14B2E68JGFRS
△R321~324	241 2377 976	Carbon 130ohm 1/4W	RD14B2E13JNBS
△R331~332	241 2378 920	Carbon 220ohm 1/4W	RD14B2E22JNBS
△R333~340	244 2043 982	Metallic 0.22ohm 1W	RS14B3AR22JNBS(S)
△R345,346	244 2051 987	Metallic 4.7ohm 1W	RS14B3A47JNBS(S)
△R371~374	244 2043 982	Metallic 0.22ohm 1W	RS14B3AR22JNBS(S)
△R384	241 2387 940	Carbon 4.7ohm 1/4W	RD14B2E47JNBS
△R408,409	241 2380 963	Carbon 2.2kohm 1/4W	RD14B2E22JNBS
△R410	241 2315 967	Carbon 68ohm 1/4W	RD14B2E68JGFRS
△R411,412	241 2377 976	Carbon 130ohm 1/4W	RD14B2E13JNBS
△R416	241 2378 920	Carbon 220ohm 1/4W	RD14B2E22JNBS
△R417~420	244 2043 982	Metallic 0.22ohm 1W	RS14B3AR22JNBS(S)
△R423	244 2051 987	Metallic 4.7ohm 1W	RS14B3A47JNBS(S)
△R481,482	241 2387 909	Carbon 1ohm 1/4W	RD14B2E01JNBS

CAPACITORS GROUP

C301,302	254 4254 909	Electrolytic 10μF/16V	CE04W1C10M
C305,306	253 1179 945	Ceramic 220pF/50V	CK45B1H221K
C307,308	255 1264 966	Film 3300pF/50V	CQ93M1H3CZJ(B)
C309,310	253 4536 909	Ceramic 10pF/50V	CC45SL1H10D

Ref. No.	Part No.	Part Name	Remarks
C311,312	254 4256 952	Electrolytic 220µF/25V	CE04W1E221M
C313-316	255 1264 908	Film 1000pF/50V	CQ93M1H102J(B)
C317,318	253 4476 904	Ceramic 18pF/500V	CC45SL2H180J
C319,320	254 4260 948	Electrolytic 1µF/50V	CE04W1H010M
C321,322	255 1265 936	Film 0.01µF/50V	CQ93M1H103J(B)
C323,324	256 1042 903	Metalizde 0.1µF/250V	CF93A2E104K
C325,326	253 1128 909	Ceramic 220pF/500V	CK45B2H221K
C327	255 1265 936	Film 0.01µF/50V	CQ93M1H103J(B)
C331-334	254 4262 904	Electrolytic 4.7µF/63V	CE04W1J4R7M
C351,352	254 4493 003	Electrolytic 8200µF/50V	CE04W1H822M(DL)
C355	256 1042 903	Metalizde 0.1µF/250V	CF93A2E104K
C356,357	256 1034 979	Metalizde 0.1µF/50V	CF93A1H104J
C358,359	254 4260 948	Electrolytic 1µF/50V	CE04W1H010M
C360	254 4258 918	Electrolytic 10µF/35V	CE04W1V100M
C401	254 4254 909	Electrolytic 10µF/16V	CE04W1C100M
C403	253 1179 945	Ceramic 220pF/50V	CK45B1H221K
C404	255 1264 966	Film 3300pF/50V	CQ93M1H332J(B)
C405	253 4536 909	Ceramic 10pF/50V	CC45SL1H100D
C406	254 4256 952	Electrolytic 220µF/25V	CE04W1E221M
C407,408	255 1264 908	Film 1000pF/50V	CQ93M1H102J(B)
C409	253 4476 904	Ceramic 18pF/500V	CC45SL2H180J
C410	254 4260 948	Electrolytic 1µF/50V	CE04W1H010M
C411	255 1265 936	Film 0.01µF/50V	CQ93M1H103J(B)
C412	256 1042 903	Metalizde 0.1µF/250V	CF93A2E104K
C421,422	254 4262 904	Electrolytic 4.7µF/63V	CE04W1J4R7M
C425	253 1128 909	Ceramic 220pF/500V	CK45B2H221K
C426,427	254 4254 941	Electrolytic 100µF/16V	CE04W1C101M
C429	253 1181 904	Ceramic 0.01µF/50V	CK45F1H103Z
C432	253 1181 904	Ceramic 0.01µF/50V	CK45F1H103Z
C451,452	254 4254 909	Electrolytic 10µF/16V	CE04W1C100M
C455,456	253 1179 903	Ceramic 100pF/50V	CK45B1H101K
C457,458	254 4254 938	Electrolytic 47µF/16V	CE04W1C470M
C459,460	255 1264 940	Film 2200pF/50V	CQ93M1H222J(B)
C461,462	256 1035 907	Metalizde 0.18µF/50V	CF93A1H184J
C463,464	254 4260 948	Electrolytic 1µF/50V	CE04W1H010M
C467,468	255 1265 949	Film 0.012µF/50V	CQ93M1H123J(B)
C469,470	256 1034 940	Metalizde 0.056µF/50V	CF93A1H563J
C471,472	254 4260 922	Electrolytic 0.33µF/50V	CE04W1HR33M
C473	253 9031 904	Ceramic 0.047µF/25V	CK45=1E473K
C474	253 1148 905	Ceramic 0.022µF/50V	CK45F1H223Z
C481	254 4254 938	Electrolytic 47µF/16V	CE04W1C470M
C482	254 4250 945	Electrolytic 330µF/6.3V	CE04W0J331M
C498,499	253 9039 906	Ceramic 0.1µF/25V	CK45=1E104Z
C551	253 1181 904	Ceramic 0.01µF/50V	CK45F1H103Z
C552	254 4254 909	Electrolytic 10µF/16V	CE04W1C100M
C801	254 4250 783	Electrolytic 3300µF/6.3V	CE04W0J332MC
C802,803	253 1181 904	Ceramic 0.01µF/50V	CK45F1H103Z
C804	254 4258 905	Electrolytic 4.7µF/35V	CE04W1V4R7M

Ref. No.	Part No.	Part Name	Remarks
C805	256 1034 982	Metalizde 0.12µF/50V	CF93A1H124J
C806	254 4250 932	Electrolytic 220µF/6.3V	CE04W0J221M
C807	253 1181 904	Ceramic 0.01µF/50V	CK45F1H103Z
C921	254 4254 938	Electrolytic 47µF/16V	CE04W1C470M

OTHERS PARTS GROUP

Ref. No.	Part No.	Part Name	Remarks
	EP- 5667 H2	Terminal	
	451 0309 071	PVC tube (L=10)	TR313,314,413
CN10A	205 0967 007	10P TXC base (P)	
CN11A	205 0275 016	11P EH connector base	
CN13A	205 0974 032	13P TXC base (P)	
CN25A	205 0736 089	25P FFC connector base	
CN4A	205 0233 045	4P EH connector base	
CN4B	205 0969 047	4P TAC-L base	
CN6A,6B,6C	205 0969 063	6P TAC-L base	
CN7A,7B	205 0967 078	7P TXC base (P)	
CN9A	205 0967 094	9P TXC base (P)	
CN9B	205 0343 090	9P connector base (KR-PH)	
J-PR	203 0524 046	1P SIN cord Ass'y	
JK301	204 8509 011	2P pin jack(C-GND)	
K-OR	203 0524 059	1P SIN cord Ass'y	
L301,302	235 0104 007	Inductor(1MH)	
L401	235 0104 007	Inductor(1MH)	
Q-BK	203 0632 080	1P SIN cord Ass'y	
R-BR	203 0632 077	1P SIN cord Ass'y	
RL481	214 0129 001	Relay(DH2TU)	
RL482	214 0187 001	Relay(DH24D2-OS(M)-2)	
SP003	205 0971 006	2P push terminal	
TP301,302	205 0190 036	3P NH connector base	
TP401	205 0190 036	3P NH connector base	

**1U-2865A MAIN AMP P.W.B. UNIT ASS'Y
for Europe, Asia and U.K. models
(Same as 1U-2865 except the followings)**

Ref. No.	Part No.	Part Name	Remarks
CAPACITORS GROUP			
C428	255 1264 982	Film 4700pF/50V	Add

1U-2867 INPUT & SURROUND P.W.B. UNIT ASS'Y
for U.S.A. and Canada models

Ref. No.	Part No.	Part Name	Remarks
SEMICONDUCTORS GROUP			
IC101	263 0672 903	IC BA4558F	
IC102	262 1228 007	IC LC7822	
IC103	263 0672 903	IC BA4558F	
IC201	263 0938 003	IC DDSC-A	
IC202	262 1874 008	IC NJU9701G	
IC203	262 1875 900	IC BU4066BCF	
IC205	262 1875 900	IC BU4066BCF	
TR201	269 0055 900	Transistor DTA144EK(47k-47k)	Built in resistor
TR202,203	269 0054 901	Transistor DTC144EK(47k-47k)	Built in resistor
TR205	269 0054 901	Transistor DTC144EK(47k-47k)	Built in resistor
TR206	269 0048 904	Transistor DTC143EK(4.7k-4.7k)	Built in resistor
TR207-209	269 0054 901	Transistor DTC144EK(47k-47k)	Built in resistor
TR210	274 0169 908	Transistor 2SD1292(R)	
D202-205	276 0616 907	Diode 1SS252	
ZD201	276 0637 902	Zener diode MTZJ6.2A	
RESISTORS GROUP			
R101,102	247 0006 946	Chip 390ohm 1/10W	RM73B--391J
R103,104	247 0011 986	Chip 68kohm 1/10W	RM73B--683J
R105,106	247 0012 969	Chip 150kohm 1/10W	RM73B--154J
R107,108	247 0004 922	Chip 47ohm 1/10W	RM73B--470J
R109,110	247 0007 945	Chip 1kohm 1/10W	RM73B--102J
R111,112	247 0014 909	Chip 560kohm 1/10W	RM73B--564J
R113,114	247 0011 944	Chip 47kohm 1/10W	RM73B--473J
R115,116	247 0003 949	Chip 22ohm 1/10W	RM73B--220J
R117,118	247 0005 905	Chip 100ohm 1/10W	RM73B--101J
R119,120	247 0013 984	Chip 470kohm 1/10W	RM73B--474J
R121-128	247 0015 966	Chip 2.7Mohm 1/10W	RM73B--275J
R133-144	247 0006 962	Chip 470ohm 1/10W	RM73B--471J
R145	247 0014 925	Chip 680kohm 1/10W	RM73B--684J
R151,152	247 0006 962	Chip 470ohm 1/10W	RM73B--471J
R153,154	247 0011 986	Chip 68kohm 1/10W	RM73B--683J
R155,156	247 0012 969	Chip 150kohm 1/10W	RM73B--154J
R157-160	247 0005 905	Chip 100ohm 1/10W	RM73B--101J
R201	247 0009 956	Chip 7.5kohm 1/10W	RM73B--752J
R202	247 0011 944	Chip 47kohm 1/10W	RM73B--473J
R203	247 0010 929	Chip 15kohm 1/10W	RM73B--153J
R204	247 0009 956	Chip 7.5kohm 1/10W	RM73B--752J
R205	247 0011 944	Chip 47kohm 1/10W	RM73B--473J
R206	247 0010 929	Chip 15kohm 1/10W	RM73B--153J
R207	247 0016 923	Chip 4.7Mohm 1/10W	RM73B--475K
R208,209	247 0011 960	Chip 56kohm 1/10W	RM73B--563J
R210	247 0012 927	Chip 100kohm 1/10W	RM73B--104J
R211	247 0019 988	Chip 100kohm 1/10W	RM73B--104F

Ref. No.	Part No.	Part Name	Remarks
R212	247 0010 929	Chip 15kohm 1/10W	RM73B--153J
R213	247 0009 969	Chip 8.2kohm 1/10W	RM73B--822J
R214	247 0010 929	Chip 15kohm 1/10W	RM73B--153J
R215	247 0013 942	Chip 330kohm 1/10W	RM73B--334J
R218-220	247 0011 944	Chip 47kohm 1/10W	RM73B--473J
R221-223	247 0009 969	Chip 8.2kohm 1/10W	RM73B--822J
R224	247 0014 967	Chip 1Mohm 1/10W	RM73B--105J
R225	247 0010 929	Chip 15kohm 1/10W	RM73B--153J
R226	247 0010 945	Chip 18kohm 1/10W	RM73B--183J
R227	247 0010 929	Chip 15kohm 1/10W	RM73B--153J
R228,229	247 0003 936	Chip 20ohm 1/10W	RM73B--200J
R230	247 0009 956	Chip 7.5kohm 1/10W	RM73B--752J
R231	247 0009 927	Chip 5.6kohm 1/10W	RM73B--562J
R232	247 0010 945	Chip 18kohm 1/10W	RM73B--183J
R233-235	247 0011 944	Chip 47kohm 1/10W	RM73B--473J
R236	247 0007 945	Chip 1kohm 1/10W	RM73B--102J
R237	247 0007 945	Chip 1kohm 1/10W	RM73B--102J
R239,240	247 0005 905	Chip 100ohm 1/10W	RM73B--101J
R241,242	247 0006 962	Chip 470ohm 1/10W	RM73B--471J
R251,252	247 0008 928	Chip 2.2kohm 1/10W	RM73B--222J
R253,254	247 0009 901	Chip 4.7kohm 1/10W	RM73B--472J
CAPACITORS GROUP			
C101,102	257 0005 944	Ceramic 220pF/50V	CC73SL1H221 J
C103,104	254 4254 909	Electrolytic 10µF/16V	CE04W1C100M
C107,108	254 4254 925	Electrolytic 33µF/16V	CE04W1C330M
C109,110	255 1264 995	Film 5600pF/50V	CQ93M1H562J(B)
C111,112	257 0009 908	Ceramic 1500PF/50V	CK73B1H152K
C113,114	257 0012 966	Ceramic 0.01µF/50V	CK73F1H103Z
C115,116	254 4260 951	Electrolytic 2.2µF/50V	CE04W1H2R2M
C129-131	253 9039 906	Ceramic 0.1µF/25V	CK45-1E104Z
C133	254 4260 948	Electrolytic 1µF/50V	CE04W1H010M
C136-138	257 0012 982	Ceramic 0.022µF/50V	CK73F1H223Z
C139	257 0009 924	Ceramic 2200PF/50V	CK73B1H222K
C151,152	254 4254 909	Electrolytic 10µF/16V	CE04W1C100M
C153,154	257 0004 961	Ceramic 100pF/50V	CC73SL1H101 J
C155,156	254 4260 948	Electrolytic 1µF/50V	CE04W1H010M
C201,202	256 1034 979	Metalizde 0.1µF/50V	CF93A1H104J
C203	257 0006 969	Ceramic 680pF/50V	CC73SL1H68J J
C204	256 1034 937	Metalizde 0.047µF/50V	CF93A1H473J
C205,206	256 1034 979	Metalizde 0.1µF/50V	CF93A1H104J
C207	257 0006 969	Ceramic 680pF/50V	CC73SL1H68J J
C208	256 1034 937	Metalizde 0.047µF/50V	CF93A1H473J
C209	254 4254 912	Electrolytic 22µF/16V	CE04W1C220M
C210,211	254 4254 909	Electrolytic 10µF/16V	CE04W1C100M
C212	254 4252 930	Electrolytic 100µF/10V	CE04W1A101M
C213	255 1264 982	Film 4700pF/50V	CQ93M1H472J(B)
C214	254 4254 912	Electrolytic 22µF/16V	CE04W1C220M
C215	254 4254 909	Electrolytic 10µF/16V	CE04W1C100M

1U-2867A INPUT & SURROUND P.W.B. UNIT ASS'Y
for Europe, Asia and U.K. models
(Same as 1U-2867 except the following)

Ref. No.	Part No.	Part Name	Remarks
C216	256 1035 910	Metalizde 0.22μF/50V	CF93A1H224J
C217,218	254 4254 909	Electrolytic 10μF/16V	CE04W1C100M
C219	254 4254 941	Electrolytic 100μF/16V	CE04W1C101M
C220	255 1264 995	Film 5600pF/50V	CQ93M1H582J(B)
C221	254 4250 958	Electrolytic 470μF/6.3V	CE04W0J471M
C222	256 1034 937	Metalizde 0.047μF/50V	CF93A1H473J
C223	257 0006 927	Ceramic 470pF/50V	CC73SL1H471J
C224	257 0009 924	Ceramic 2200PF/50V	CK73B1H222K
C225	254 4260 948	Electrolytic 1μF/50V	CE04W1H010M
C226	256 1035 978	Metalizde 0.68μF/50V	CF93A1H684J
C227-229	256 1035 910	Metalizde 0.22μF/50V	CF93A1H224J
C230,231	254 4260 977	Electrolytic 4.7μF/50V	CE04W1H4R7M
C232	256 1035 910	Metalizde 0.22μF/50V	CF93A1H224J
C233-236	256 1034 979	Metalizde 0.1μF/50V	CF93A1H104J
C237,238	255 1265 978	Film 0.022μF/50V	CQ93M1H223J(B)
C239-241	254 4260 948	Electrolytic 1μF/50V	CE04W1H010M
C242	257 0014 935	Ceramic 0.1μF/50V	CK73F1H104Z
C243,244	254 4260 948	Electrolytic 1μF/50V	CE04W1H010M
C245	257 0006 927	Ceramic 470pF/50V	CC73SL1H471J
C246	257 0009 940	Ceramic 3300PF/50V	CK73B1H332K
C247	257 0014 935	Ceramic 0.1μF/50V	CK73F1H104Z
C248,249	257 0013 907	Ceramic 0.047μF/50V	CK73F1H473Z
C250	254 4254 938	Electrolytic 47μF/16V	CE04W1C470M
C251	257 0014 935	Ceramic 0.1μF/50V	CK73F1H104Z
C252	257 0006 927	Ceramic 470pF/50V	CC73SL1H471J
C253,254	257 0009 979	Ceramic 5600PF/50V	CK73B1H562K
C255	257 0014 935	Ceramic 0.1μF/50V	CK73F1H104Z
C256	254 4254 909	Electrolytic 10μF/16V	CE04W1C100M
C257	254 4252 930	Electrolytic 100μF/10V	CE04W1A101M
C259,260	257 0005 944	Ceramic 220pF/50V	CC73SL1H221J
C321,322	255 1265 936	Film 0.01μF/50V	CQ93M1H103J(B)
C403	253 1179 945	Ceramic 220pF/50V	CK45B1H221K
C404	255 1264 966	Film 3300pF/50V	CQ93M1H332J(B)
C412	256 1042 903	Metalizde 0.1μF/250V	CF93A2E104K
C432	253 1181 904	Ceramic 0.01μF/50V	CK45F1H103Z
C806	254 4250 932	Electrolytic 220μF/6.3V	CE04W0J221M
OTHERS PARTS GROUP			
CN10A	205 0966 008	10P TXC socket(X)	
CN13A	205 0968 035	13P TXC socket(X)	
CN6B	205 0970 065	6P TAC-L socket	
JK101-103	204 8497 000	4P pin jack (GND)(K)	
JK104	204 8509 008	2P pin jack (C-GND)	
L201	235 0060 989	Inductor (121)	
XT201	399 0223 907	Crystal (CSA2.00MG-TF01)	

Ref. No.	Part No.	Part Name	Remarks
SEMICONDUCTORS GROUP			
IC101	263 0896 909	IC NJM2068MD	Add
IC103	263 0672 903	IC BA4558F	Change
RESISTORS GROUP			
R726	241 2396 999	Carbon 200ohm 1/4W	Change
R733	241 2396 999	Carbon 200ohm 1/4W	Change
J101,102	241 2400 911	Carbon 4.7kohm 1/4W	Add
CAPACITORS GROUP			
C121-128	257 0004 903	Ceramic 56pF/50V	Add
C147,148	257 0004 961	Ceramic 100pF/50V	Add
C281,282	255 1264 908	Film 0.001μF/50V	Add
OTHERS PARTS GROUP			
LF101,102	235 9003 002	FTZ choke coil	Add

1U-2889 TUNER & VOLUME P.W.B. UNIT ASS'Y
for U.S.A and Canada models

Ref. No.	Part No.	Part Name	Remarks
SEMICONDUCTORS GROUP			
IC001	263 0891 001	IC LA1265(S)	
IC002	263 0439 007	IC LA3401	
IC003	262 0719 009	IC LM7001	
IC004	261 0102 008	IC Front end	
IC261	263 0322 004	IC BA4558	
IC262	262 0625 009	IC TC9176P	
IC263	263 0322 004	IC BA4558	
IC264	263 0927 001	IC BA6208S	
TR002	273 0434 902	Transistor 2SC2058(Q)	
TR003,004	269 0046 906	Transistor DTA114ES(10k-10k)	Built in resistor
TR005	273 0435 901	Transistor 2SC1740SLN(E)	
TR006	275 0053 907	Transistor 2SK365(BL/GR)	
TR007,008	269 0072 909	Transistor DTC323TS(2.2k)	Built in resistor
TR009	269 0079 902	Transistor DTC144TS(47k)	Built in resistor
TR010	269 0080 904	Transistor DTA114TS(10k)	Built in resistor
D001-003	276 0616 907	Diode 1SS252	
D006	276 0553 905	Diode 1SR35-200A	
D261	276 0616 907	Diode 1SS252	

Ref. No.	Part No.	Part Name	Remarks
RESISTORS GROUP (Not included carbon film ±5% 1/4W)			
VR261	211 0858 001	Variable resistor 100kohm	V1640V30F=104R(MG)
CAPACITORS GROUP			
C004	253 4536 925	Ceramic 12pF/50V	CC45SL1H120J
C007,008	253 1181 904	Ceramic 0.01µF/50V	CK45F1H103Z
C011	254 3056 917	Electrolytic 1µF/50V	CE04D1H010MBP
C013	254 4260 906	Electrolytic 0.1µF/50V	CE04W1H0R1M
C014	253 1181 917	Ceramic 0.022µF/50V	CK45F1H223Z
C016	253 4538 949	Ceramic 100pF/50V	CC45SL1H101J
C017,018	253 1181 904	Ceramic 0.01µF/50V	CK45F1H103Z
C019	254 4260 935	Electrolytic 0.47µF/50V	CE04W1HR47M
C020	254 4260 948	Electrolytic 1µF/50V	CE04W1H010M
C021	254 4260 980	Electrolytic 10µF/50V	CE04W1H100M
C022	253 1181 917	Ceramic 0.022µF/50V	CK45F1H223Z
C023	253 4538 949	Ceramic 100pF/50V	CC45SL1H101J
C024	256 1034 940	Metalizde 0.056µF/50V	CF93A1H563J
C025	254 4254 912	Electrolytic 22µF/16V	CE04W1C220M
C027	254 4254 912	Electrolytic 22µF/16V	CE04W1C220M
C028	254 4260 948	Electrolytic 1µF/50V	CE04W1H010M
C029	253 1181 904	Ceramic 0.01µF/50V	CK45F1H103Z
C033,034	253 4536 954	Ceramic 16pF/50V	CC45SL1H160J
C035	256 1034 937	Metalizde 0.047µF/50V	CF93A1H473J
C036,037	253 1181 904	Ceramic 0.01µF/50V	CK45F1H103Z
C039	253 1181 904	Ceramic 0.01µF/50V	CK45F1H103Z
C040	254 4260 948	Electrolytic 1µF/50V	CE04W1H010M
C041	254 4254 938	Electrolytic 47µF/16V	CE04W1C470M
C042	254 4260 948	Electrolytic 1µF/50V	CE04W1H010M
C043	254 4260 919	Electrolytic 0.22µF/50V	CE04W1HR22M
C044	254 4260 948	Electrolytic 1µF/50V	CE04W1H010M
C045	253 1181 904	Ceramic 0.01µF/50V	CK45F1H103Z
C046,047	254 4260 951	Electrolytic 2.2µF/50V	CE04W1H2R2M
C048	254 4260 948	Electrolytic 1µF/50V	CE04W1H010M
C049	253 1181 904	Ceramic 0.01µF/50V	CK45F1H103Z
C051	254 4260 951	Electrolytic 2.2µF/50V	CE04W1H2R2M
C052	254 4254 909	Electrolytic 10µF/16V	CE04W1C100M
C053,054	253 4457 907	Ceramic 750pF/50V	CC45SL1H751J
C056,057	253 1181 904	Ceramic 0.01µF/50V	CK45F1H103Z
C059,060	253 1181 904	Ceramic 0.01µF/50V	CK45F1H103Z
C060	253 1181 904	Ceramic 0.01µF/50V	CK45F1H103Z
C065	253 1181 904	Ceramic 0.01µF/50V	CK45F1H103Z
C261~264	254 4254 909	Electrolytic 10µF/16V	CE04W1C100M
C265	253 1179 987	Ceramic 470pF/50V	CK45B1H471K
C266	253 1179 961	Ceramic 330pF/50V	CK45B1H331K
C267,268	254 4254 909	Electrolytic 10µF/16V	CE04W1C100M
C269,270	253 1181 917	Ceramic 0.022µF/50V	CK45F1H223Z
C271,272	254 4254 909	Electrolytic 10µF/16V	CE04W1C100M
C273	253 1179 945	Ceramic 220pF/50V	CK45B1H221K
C274,275	254 4254 909	Electrolytic 10µF/16V	CE04W1C100M

Ref. No.	Part No.	Part Name	Remarks
C276	254 3056 917	Electrolytic 1µF/50V	CE04D1H010MBP
C277	253 1181 904	Ceramic 0.01µF/50V	CK45F1H103Z
C278	254 4260 948	Electrolytic 1µF/50V	CE04W1H010M
C279	253 1181 904	Ceramic 0.01µF/50V	CK45F1H103Z
C297,298	254 4254 909	Electrolytic 10µF/16V	CE04W1C100M
OTHERS PARTS GROUP			
	205 0973 004	3P ANT.terminal	
BL001	231 2096 001	MW ANT-OSC coil	
CF001	261 0145 007	Ceramic filter	FMCFSK107M1-A
CF002	261 0146 006	Ceramic filter	FMCFSK107M2-A
CF003	261 0031 001	Ceramic filter	BFU450C4
CF004	261 0079 005	Ceramic filter	CBS456F11
CF005	261 0116 007	Ceramic filter	SFU450B3
CN6A,6C	205 0970 065	6P TAC-L socket	
CN7A,7B	205 0966 079	7P TXC socket(X)	
CN9A	205 0966 095	9P TXC socket(X)	
T003	231 1145 005	AM IFT	
T004	231 2099 008	FM DET Trans	
XT001	399 0075 003	Crystal (7.2MHZ)	

1U-2889A TUNER & VOLUME P.W.B. UNIT ASS'Y
for Europe and U.K. models
(Same as 1U-2889 except the following)

Ref. No.	Part No.	Part Name	Remarks
SEMICONDUCTORS GROUP			
IC004	261 0079 005	IC FM front end (U)	Change
TR001	275 0051 909	Transistor 2SK161(GR)	Add
RESISTORS GROUP			
R002	241 2400 937	Carbon 5.6kohm 1/4W	Change
R004	241 2400 995	Carbon 10kohm 1/4W	Add
R005	241 2397 969	Carbon 390ohm 1/4W	Change
R006	241 2397 943	Carbon 330ohm 1/4W	Change
R008	241 2397 943	Carbon 330ohm 1/4W	Change
R011	241 2397 943	Carbon 330ohm 1/4W	Change
R014	241 2396 928	Carbon 100ohm 1/4W	Change
R023	241 2399 909	Carbon 1.6kohm 1/4W	Add
R024	241 2400 953	Carbon 6.8kohm 1/4W	Change
R032	241 2403 976	Carbon 150kohm 1/4W	Add
R033,034	241 2404 904	Carbon 200kohm 1/4W	Change
R035	241 2403 976	Carbon 150kohm 1/4W	Add
R037,038	241 2403 934	Carbon 100kohm 1/4W	Change
R041,042	241 2399 970	Carbon 3.3kohm 1/4W	Change
R048	241 2400 937	Carbon 5.6kohm 1/4W	Change

1U-2883A FLD & VIDEO P.W.B. UNIT ASS'Y

Ref. No.	Part No.	Part Name	Remarks
R267,268	241 2399 970	Carbon 3.3kohm 1/4W	Change
R274	241 2400 937	Carbon 5.6kohm 1/4W	Change
R275	241 2396 928	Carbon 100ohm 1/4W	Change
R281	241 2400 937	Carbon 5.6kohm 1/4W	Change
R282	241 2396 928	Carbon 100ohm 1/4W	Change
CAPACITORS GROUP			
C006,007	253 1181 904	Ceramic 0.01μF/50V	Change
C016	253 4538 949	Ceramic 100PF/50V	Change
C025-027	254 4254 912	Electrolytic 22μF/16V	Change
C053,054	253 4448 903	Ceramic 330PF/50V	Change
OTHERS PARTS GROUP			
CF001	261 0146 006	FMCFSK107M2-A	Change
LF001	232 9010 009	Anti birdie filter	Add
LF002,003	232 0085 004	.LPF	Add

Ref. No.	Part No.	Part Name	Remarks
SEMICONDUCTORS GROUP			
IC601	262 1873 009	IC BU4066BC	
IC701	262 2190 011	IC TMP87CM71F-6314	
IC702	499 0150 008	IC SBX1610-52	
TR601,602	273 0198 918	Transistor 2SC1815(BL)	
TR603,604	271 0102 924	Transistor 2SC1015(GR)	
TR701,702	269 0020 906	Transistor DTC114ES(10k-10k)	Built in resistor
D616	276 0616 907	Diode 1SS252	
D617	276 0616 907	Diode 1SS252	
D701	276 0636 903	Diode MTZJ8.2B	
D701,702	276 0616 907	Diode 1SS252	
LD701,702	393 9434 906	LED SEL1210S	

RESISTORS GROUP			
RA R610	241 2375 907	Carbon 150ohm 1/4W	RD1482E100JNB5

1U-2889B TUNER & VOLUME P.W.B. UNIT ASS'Y
for Asia model
(Same as 1U-2889 except the followings)

Ref. No.	Part No.	Part Name	Remarks
RESISTORS GROUP			
R022	241 2402 935	Carbon 39kohm 1/4W	Change
CAPACITORS GROUP			
C266	253 1180 934	Ceramic 1200PF/50V	Change

CAPACITORS GROUP			
C601,602	254 4252 927	Electrolytic 47μF/10V	CE04W1A470M
C604	254 4254 776	Electrolytic 470μF/16V	CE04W1C471M
C605,606	253 4535 955	Ceramic 5pF/50V	CC45SL1H050C
C607,608	254 4252 778	Electrolytic 1000μF/10V	CE04W1A102MC
C703	254 4260 977	Electrolytic 4.7μF/50V	CE04W1H4R7M
C705	254 4250 929	Electrolytic 100μF/6.3V	CE04W0J0101M
C706	253 1181 904	Ceramic 0.01μF/50V	CK45F1H103Z

OTHERS PARTS GROUP			
CN25A	205 0736 089	25P FFC connector base	
CN2A	205 0075 025	2P terminal	
CN3B	203 5080 019	3P SCN-SCN connector cord	
CN4B	205 0970 049	4P TAC-L socket	
CN9B	204 2751 001	9P PH-SAN connector cord	
FL701	393 4155 002	FLD (FIP14AM7R)	
JK601,602	204 8468 000	2P pin jack	
SW701-704	212 4789 001	Tact switch	
SW708-713	212 4789 001	Tact switch	
SW719-730	212 4789 001	Tact switch	
XT701	399 0261 901	Crystal (CO.DCRHTP4.00M)	

1U-2866 REAR AMP P.W.B. UNIT ASS'Y
for U.S.A. and Canada models

Ref. No.	Part No.	Part Name	Remarks
SEMICONDUCTORS GROUP			
IC501,502	263 0985 001	IC SI-18751	
IC503	263 0801 004	IC NJM7812FA(S)	
IC504	263 0641 002	IC NJM7912FA	
IC505,506	268 0074 904	IC ICP-N20	
TR531	273 0303 910	Transistor 2SC1740S(S)	
TR552	273 0303 910	Transistor 2SC1740S(S)	
D501	276 0616 907	Diode 1SS252	
D502	276 0305 001	Diode S4VB20	
D551	276 0616 907	Diode 1SS252	
D552-557	276 0553 905	Diode 1SR35-200A	
TH531	279 0034 067	Thermistor	PTH9M04BB222TS2F333
RESISTORS GROUP			
△R361-364	244 2052 960	Metallic 220ohm 1W	RS14B3A221JNBS(S)
△R503,510	244 2051 987	Metallic 4.7ohm 1W	RS14B3A4R7JNBS(S)
△R513	241 2387 906	Carbon 1ohm 1/4W	RD14B2E010JNBS
△R556	241 2375 976	Carbon 20ohm 1/4W	RD14B2E200JNBS
△R557	242 0073 000	Metallic 2.2Mohm 1/2W	RC050F241225K
CAPACITORS GROUP			
C399	253 9039 906	Ceramic 0.1μF/25V	CK45-1E104Z
C501,502	253 1179 903	Ceramic 100pF/50V	CK45B1H101K
C503,504	254 4260 951	Electrolytic 2.2μF/50V	CE04W1H2R2M
C505,506	254 4254 938	Electrolytic 47μF/16V	CE04W1C470M
C507,508	254 4260 948	Electrolytic 1μF/50V	CE04W1H010M
C511,512	256 1034 979	Metalizde 0.1μF/50V	CF93A1H104J
C517,518	254 4257 702	Electrolytic 3300μF/25V	CE04W1E332MC
C519,520	253 1181 904	Ceramic 0.01μF/50V	CK45F1H103Z
C521,522	254 4254 909	Electrolytic 10μF/16V	CE04W1C100M
C524	256 1042 903	Metalizde 0.1μF/250V	CF93A2E104K
C526	253 1181 904	Ceramic 0.01μF/50V	CK45F1H103Z
C554	254 4260 948	Electrolytic 1μF/50V	CE04W1H010M
C555	254 4256 790	Electrolytic 2200μF/25V	CE04W1E222MC
C556,557	253 1181 904	Ceramic 0.01μF/50V	CK45F1H103Z
C558	254 4260 948	Electrolytic 1μF/50V	CE04W1H010M
△C559	253 6014 702	Ceramic 0.01μF/400V AC	CK45F2GAC103MC
C561	254 4254 938	Electrolytic 47μF/16V	CE04W1C470M
C565,566	253 1181 904	Ceramic 0.01μF/50V	CK45F1H103Z
OTHERS PARTS GROUP			
△	203 3941 008	AC outlet (2P)	
	203 0632 035	1P SIN cord Ass'y	
	203 0632 048	1P SIN cord Ass'y	
	415 0309 039	PVC tube	TH531

Ref. No.	Part No.	Part Name	Remarks
	203 0632 064	1P SIN cord Ass'y	
	203 0633 021	1P contact Ass'y	
	202 0040 909	Fuse clip	
	EP- 5667 H2	Terminal	
	203 0524 062	1P SIN cord Ass'y	
	204 8503 004	:Headphone jack	
	203 0524 075	1P SIN cord Ass'y	
	415 0496 036	UL tube (12.7) BK	
△	233 6073 000	Power trans	
	203 0633 018	1P contact Ass'y	
	203 0524 033	1P SIN cord Ass'y	
	203 0632 051	1P SIN cord Ass'y	
	203 0640 014	1P SIN cord Ass'y	
	205 0952 009	4P SP terminal	
	203 0640 001	1P SIN cord Ass'y	
CN11A	204 6552 002	11P EH-SCN connector cord	
CN4B	203 6475 018	4P EH-SCN connector cord	
△F001	206 1046 014	Fuse 8A	
△F002	206 1046 001	Fuse 0.3A UL 20MM	
△F011,012	206 1046 027	Fuse 5A	
L501,502	235 0104 007	Inductor(1MH)	
RL501	214 0187 001	Relay(DH24D2-OS(M)-2)	
RL551	214 0188 000	Relay(VS-12MBNR-SM2) (TV-8)	
SP005	205 0972 005	4P push terminal	
SW001	212 4778 009	2P push switch	

1U-2866A REAR AMP P.W.B. UNIT ASS'Y
for Europe, Asia and U.K. models
(Same as 1U-2866 except the followings)

Ref. No.	Part No.	Part Name	Remarks
RESISTORS GROUP			
△R557	242 0073 000	Metallic 2.2Mohm 1/2W	Delete
CAPACITORS GROUP			
C361-364	255 1264 982	Film 4700pF/50V	Add
C513,514	255 1264 982	Film 4700pF/50V	Add
OTHERS PARTS GROUP			
△	203 3941 008	AC outlet (2P)	Delete
△	233 6178 002	Power trans	Change

PRINTED WIRING BOARD

1 2 3 4 5 6 7 8

INPUT AND SURROUND P. W. B. ASS'Y

1U-2867 for U. S. A. and Canada

1U-2867A for Europe, Asia and U. K. models

※	1U-2867	1U-2867A
	U.S.A. and Canada	Europe, U.K. and Asia
IC101	x	o
J101	x	o
J102	x	o
C121	x	o
C122	x	o
C123	x	o
C124	x	o
C125	x	o
C126	x	o
C127	x	o
C128	x	o
C147	x	o
C148	x	o
C281	x	o
C282	x	o
LF101	x	o
LF102	x	o

Note: o : Used x : Not used

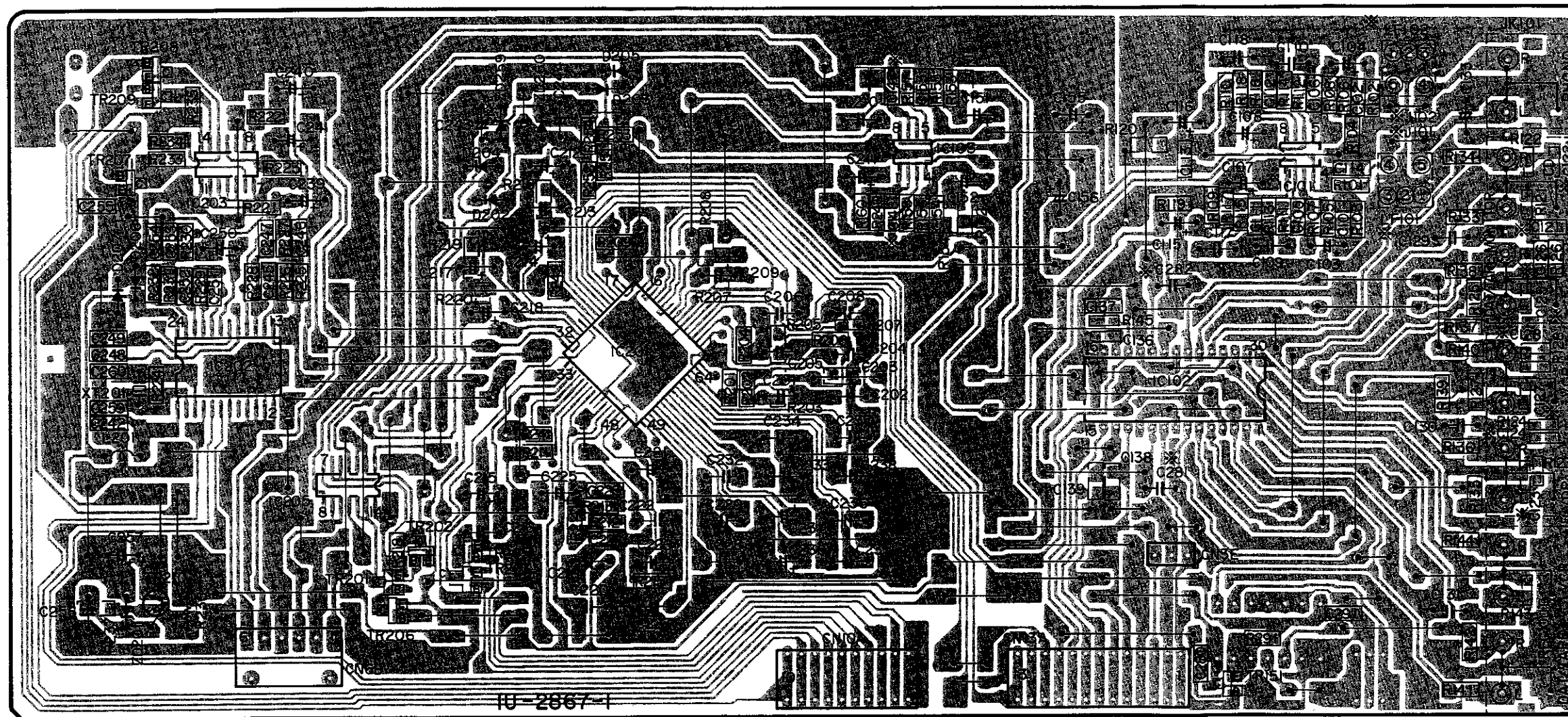

A
B
C
D
E

1

2

3

4

5

6

7

8

MAIN AMP. P. W. B. UNIT ASS'Y
1U-2865 for U. S. A. and Canada
1U-2865A for Europe, U. K. and Asia

A

*	1U-2865	1U-2865A
	U.S.A.and Canada	Europe,U.K.and Asia
IC911	×	×
IC912	×	×
D901	×	×
R035	×	×
C428	×	○
C911	×	×
C912	×	×
C913	×	×
C914	×	×
C915	×	×
C918	×	×
C919	×	×

Note: ○ : Used × : Not used

B

C

D

E

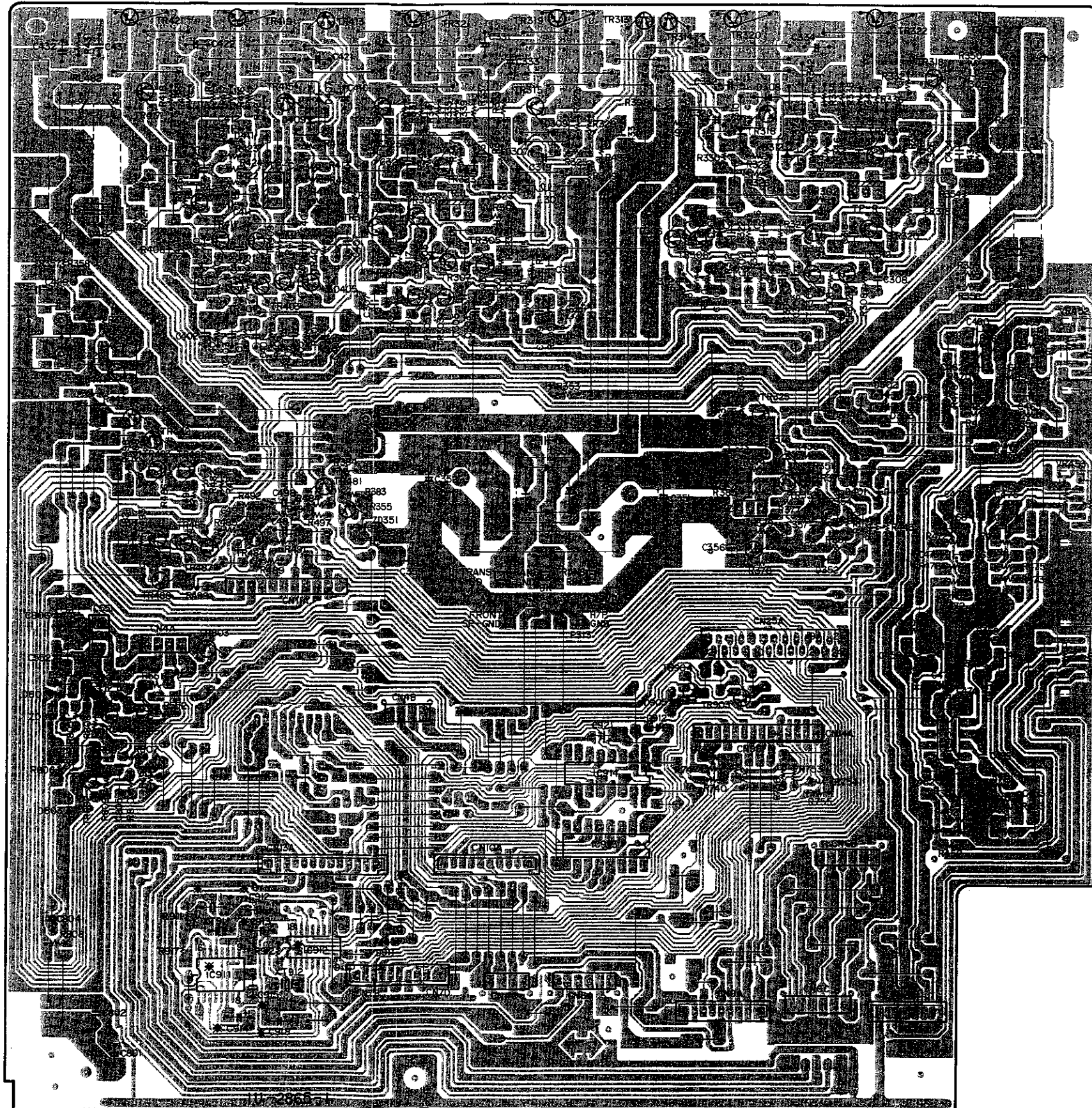

1 2 3 4 5 6 7 8

REAR AMP. P. W. B. UNIT ASS'Y
1U-2866 for U. S. A. and Canada
1U-2866A for Europe, U. K. and Asia

*	1U-2866	1U-2866A
	U.S.A. and Canada	Europe, U.K. and Asia
R557	○	×
C361	×	○
C362	×	○
C363	×	○
C364	×	○
AC outlet	○	×

Note: ○ : Used × : Not used

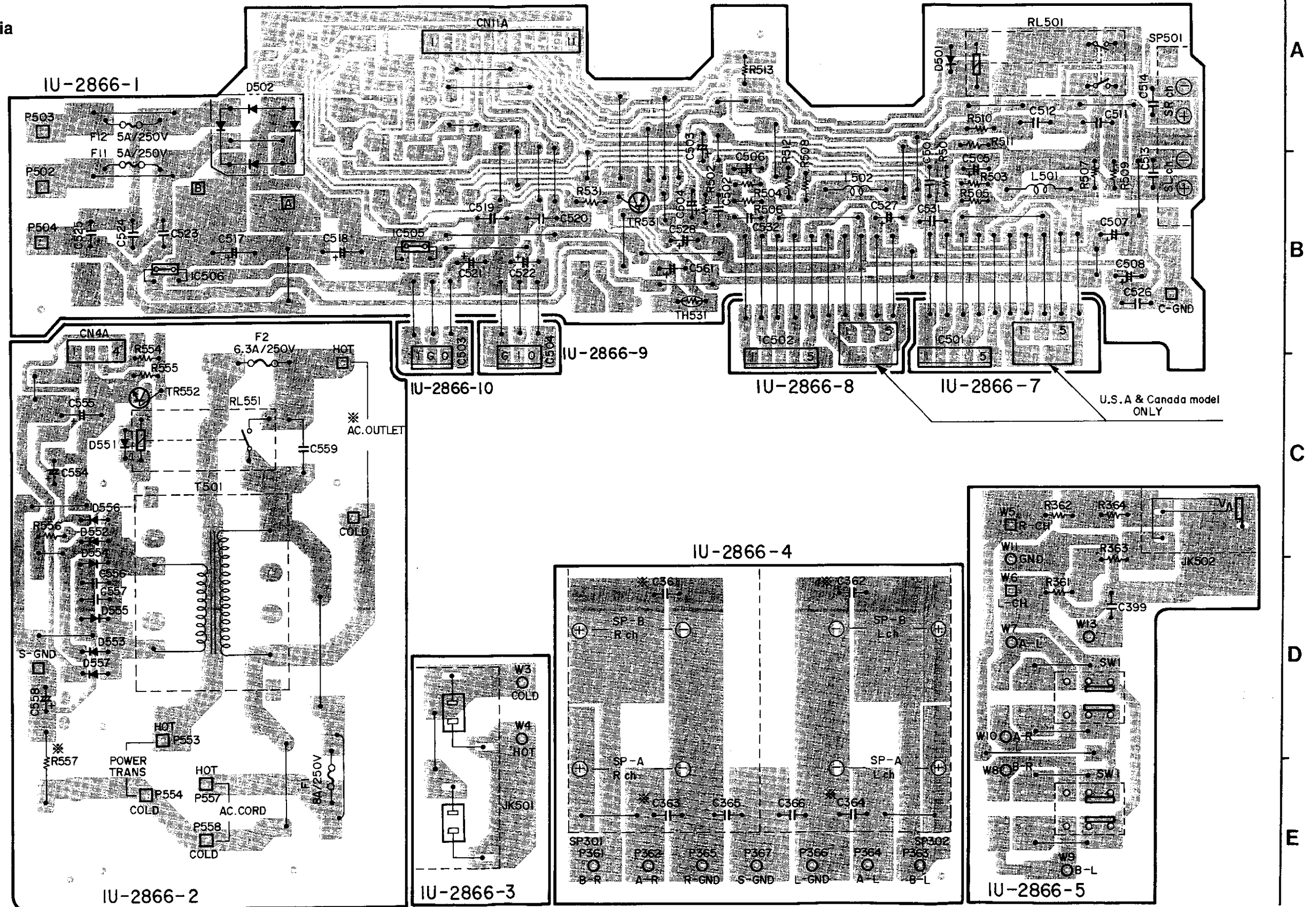

1 2 3 4 5 6 7 8

TUNER AND VOLUME P. W. B. UNIT ASS'Y
 1U-2889 for U. S. A. and Canada
 1U-2889A for Europe, and U. K.
 1U-2889B for Asia

A

*	1U-2889	1U-2889A	1U-2889B
	U.S.A. and Canada	Europe and U.K.	Asia
TR001	x	o	x
R004	x	o	x
R023	x	o	x
R032	x	o	x
R035	x	o	x
C055	x	x	x
LF001	x	o	x
LF002	x	o	x
LF003	x	o	x

Note: o : Used x : Not used

B

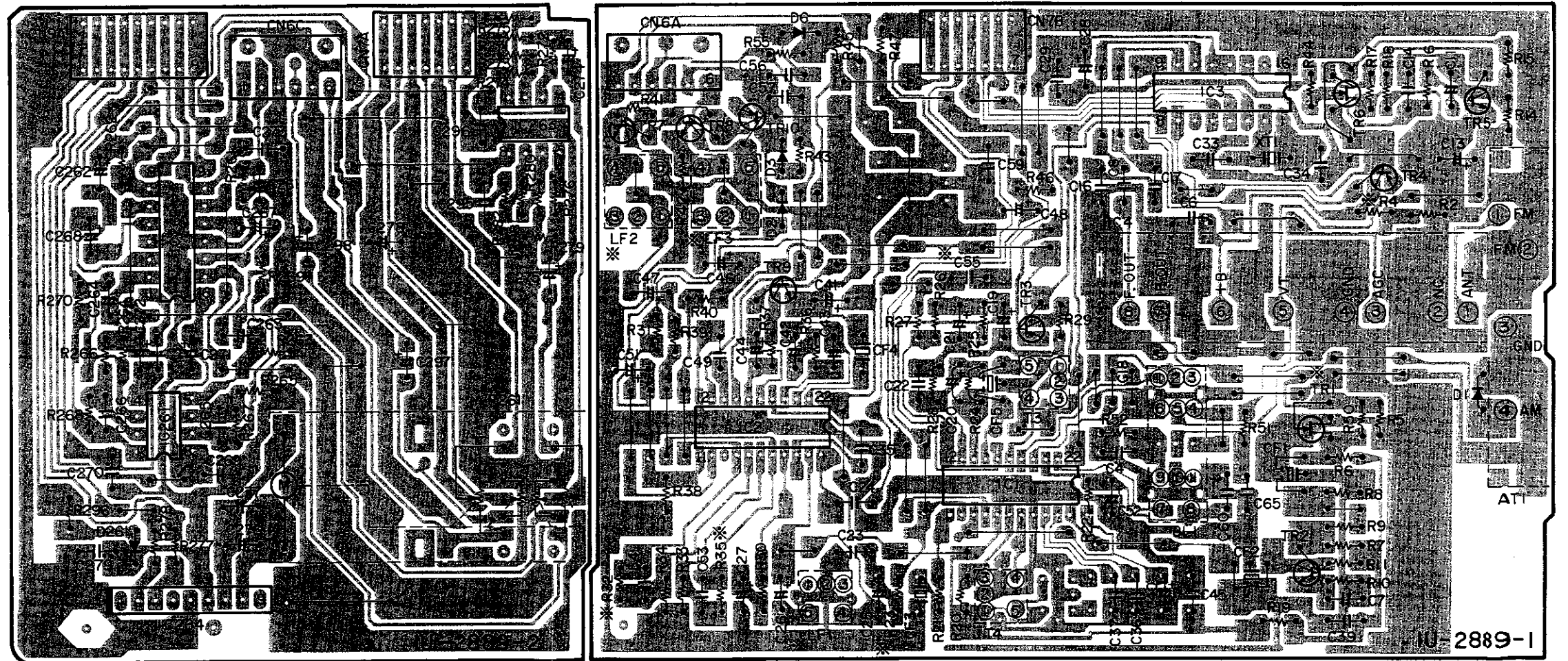

C

D

E

EXPLODED VIEW

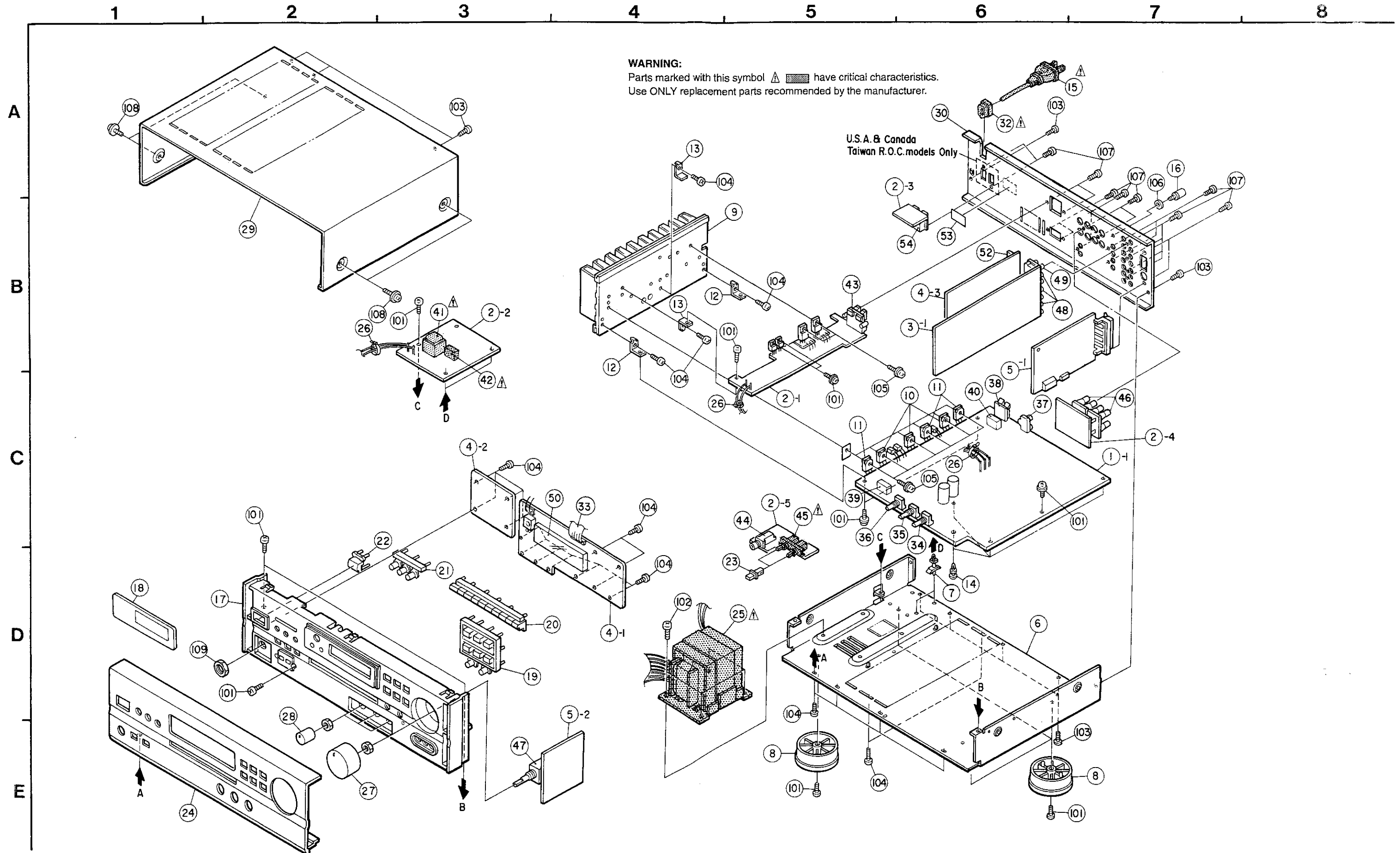

PARTS LIST OF EXPLODED VIEW

Ref. No.	Part No.	Part Name	Remarks	Q'ty
1	Note	Main amp. P.W.B. unit Ass'y		1
1-1	—	Main amp. P.W.B. unit		
2	Note	Rear amp. P.W.B. unit Ass'y		1
2-1	—	Rear amp. P.W.B. unit		
2-2	—	Power supply P.W.B. unit		
2-3	—	AC outlets P.W.B. unit		
2-4	—	Front SP. P.W.B. unit		
2-5	—	H/P and SW. P.W.B. unit		
3	Note	Input and surround P.W.B. unit Ass'y		1
3-1	—	Input and surround P.W.B. unit		
4	Note	FLD and video P.W.B. unit Ass'y		1
4-1	—	FLD P.W.B. unit		
4-2	—	Tact S.W P.W.B. unit		
4-3	—	Video P.W.B. unit		
5	Note	Tuner and Volume P.W.B. unit Ass'y		1
5-1	—	Tuner P.W.B. unit		
5-2	—	Volume P.W.B. unit		
6	411 1334 108	Main chassis		1
7	443 0518 016	P.W.B. holder		2
8	104 0282 007	*Foot Ass'y		4
9	417 0513 009	*Power radiator		1
10	273 0443 003	2SC4278(E/F)		3
11	271 0283 005	2SA1633(E/F)		3
12	412 4000 005	*P.W.B.bracket(A)		2
13	412 3766 007	*L bracket		2
14	412 2814 002	Card spacer (L=8)		4
15	Note	AC cord (with plug)		1
16	205 0071 016	Terminal Ass'y		1
17	146 1574 103	Inner panel		1
18	143 0942 009	Window		1
19	113 1753 005	Tact knob (A)		1
20	113 1692 001	*Function knob		1
21	113 1743 002	Tact knob (3 Key)		1
22	113 1636 106	*Push knob (P)		1
23	113 1558 006	Push knob (KAKU)		2
24	144 2451 106	Front panel		1
25	Note	Power trans		1
26	445 8004 007	Wire clasper		5
27	112 0761 008	*Volume knob		1
28	112 0762 007	*Knob		3
29	102 0565 003	Top cover		1
30	Note	Back panel		1
★	001 0198 009	VinylWire		1
31	Note	2SP push		1
32	445 0023 008	2SP push		1
33	009 0105 012	2SP FFC cable		1
34	211 0798 103	Variable resistor 100kohm	VR451	1
35	211 0797 117	Variable resistor 30kohm	VR452	1
36	211 0797 133	Variable resistor 10kohm	VR453	1
37	204 8509 011	2P pin jack (C-GND)	JK301	1
38	205 0971 006	2P push terminal	SP003	1
39	214 0129 001	Relay (DH2TU)	RL481	1

Ref. No.	Part No.	Part Name	Remarks	Q'ty
40	214 0187 001	Relay (DH24D2-OS(M)-2)	RL482	1
△ 41	Note	Power trans (mini)		1
△ 42	214 0188 000	Relay (NS-12MNR-SM2)(TV-8)	RL551	1
43	205 0972 005	4P push terminal		1
44	204 8503 004	:Headphone jack		1
△ 45	212 4778 009	2P push switch	SW001	1
46	205 0952 009	4P speaker terminal		2
47	211 0858 001	Variable resistor 100kohm	VR261	1
48	204 8497 000	4P pin jack (GND)(K)	JK101-103	3
49	204 8509 008	2P pin jack (C-GND)	JK104	1
50	393 4155 002	FLD (FIP14AM7R)	FL701	1
★	212 4789 001	Tact switch	SW701-704, 708-713,719-730	22
52	204 8468 000	2P pin jack	JK601,602	2
53	513 2404 029	Fuse caution label		1
54	Note	AC outlet (2P)		1
★	513 2236 006	Label		
★	513 2377 004	CUL label (1270)		
★	513 2433 003	Serial No.sheet		

SCREWS

Ref. No.	Part No.	Part Name	Remarks	Q'ty
101	473 7002 018	Screw 3x8 (S)		14
102	473 7004 016	Screw 4x6 (S)		4
103	473 7015 005	Screw 3x6 (S) BK		10
104	473 7500 044	Screw 3x8 (P) BK		22
105	473 8007 009	Screw 3x12 cup		8
106	477 0018 001	Washer(P-87)		1
107	477 0064 107	Fixing screw		17
108	477 0263 005	3P swelling screw		4
109	475 6124 003	12 Nut		1

PACKING & ACCESSORIES

Ref. No.	Part No.	Part Name	Remarks	Q'ty
	504 0092 086	Stylen paper	(700x600xT1)	1
	505 0075 006	Cabinet cover	(750x350)	1
	503 1190 007	Cushion		2
	505 8006 019	Envelope		1
	Note	Instructions manual		1
	515 0671 122	S.S.list		1
	399 0292 006	Remoto control unit	RC195	1
	231 0922 009	AM lobe antenne		1
	395 0023 008	:FM antenne Ass'y		1
	Note	Carton case		1
	Note	UPC label		1
	513 1389 006	Control card base		1
	513 1349 004	Thermal carbon film		1
	Note	DELWarranty home		1
	394 0038 003	Battery (GER6M)		2

**ADDENDUM PARTS LIST
PARTS LIST OF EXPLODED VIEW**

Ref.No.	Part Name	Part NO.			
		U.S.A./Canada	Europe	Multi-Voltage	U.K
1	Main amp. P.W.B. unit Ass'y	1U-2865	1U-2865 A	1U-2865 A	1U-2865 A
2	Rear amp. P.W.B. unit Ass'y	1U-2866	1U-2866 A	1U-2866 A	1U-2866 A
3	Input and surround P.W.B. unit Ass'y	1U-2867	1U-2867 A	1U-2867 A	1U-2867 A
4	FLD and video P.W.B. unit Ass'y	1U-2883	1U-2883 A	1U-2883 A	1U-2883 A
5	Tuner and volume P.W.B. unit Ass'y	1U-2889	1U-2889 A	1U-2889 B	1U-2889 A
△ 15	AC cord	205 2883 009	205 2883 009	205 2883 009	205 2883 009
△ 25	Power trans	233 6178 004	233 6178 002	233 6178 002	233 6178 002
30	Back panel	105 1167 001	105 1167 014	105 1167 014	105 1167 014
△ 41	Power trans (mini)	233 6073 000	233 6085 001	233 6085 001	233 6085 001
△ 54	AC outlet (2P)	203 3541 008			

PACKING AND ACCESSORIES

Ref.No.	Part Name	Part NO.			
		U.S.A./Canada	Europe	Multi-Voltage	U.K
	Inst. manual	511 2791 008	511 2800 009	511 2791 008	511 2801 008
	Carton case	501 1887 000	501 1887 000	501 1887 013	501 1887 000
	UPC label	517 0109 027	—	—	—
	DELWarranty	515 0690 006	—	—	—

BLOCK DIAGRAM

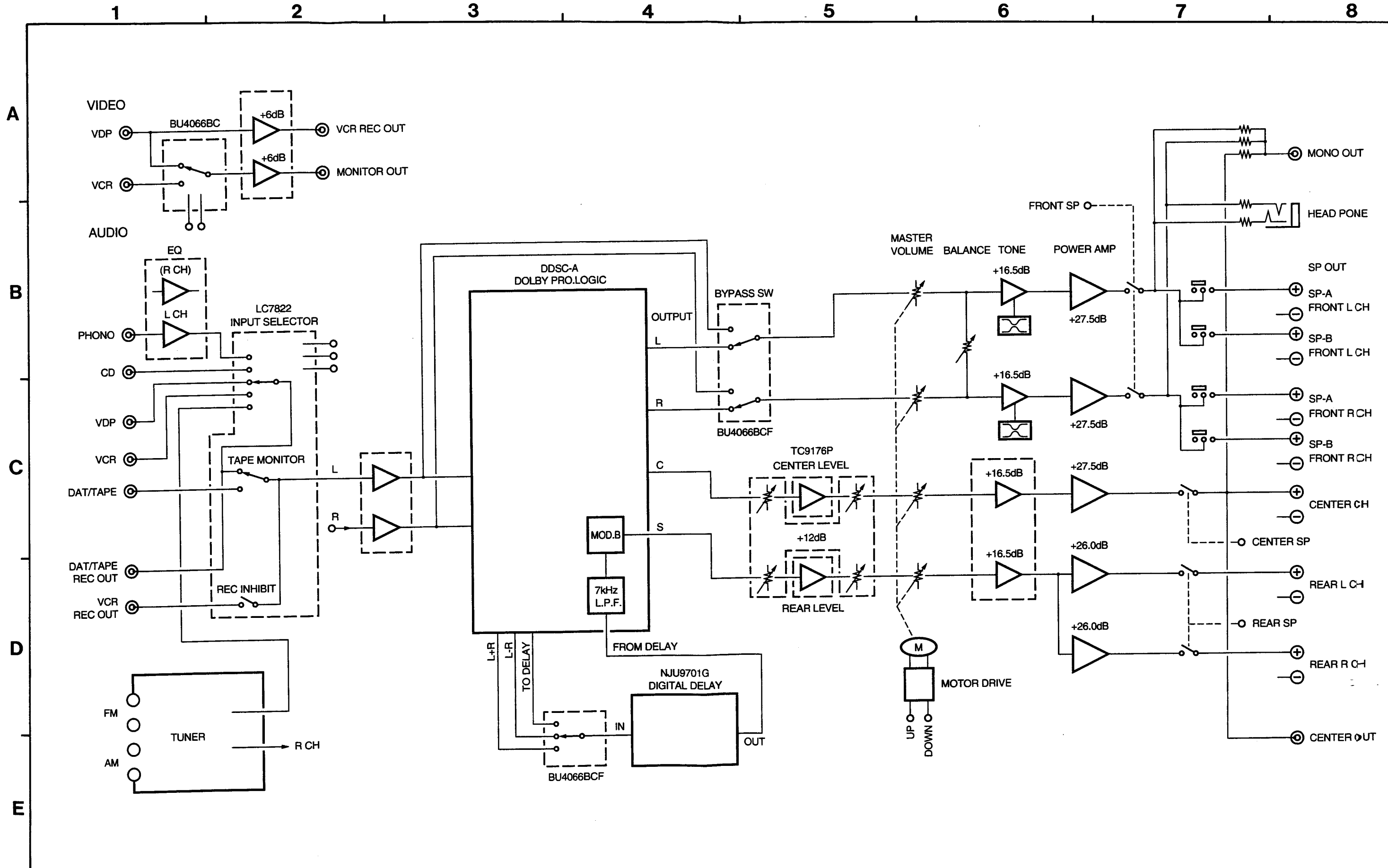

WIRING DIAGRAM

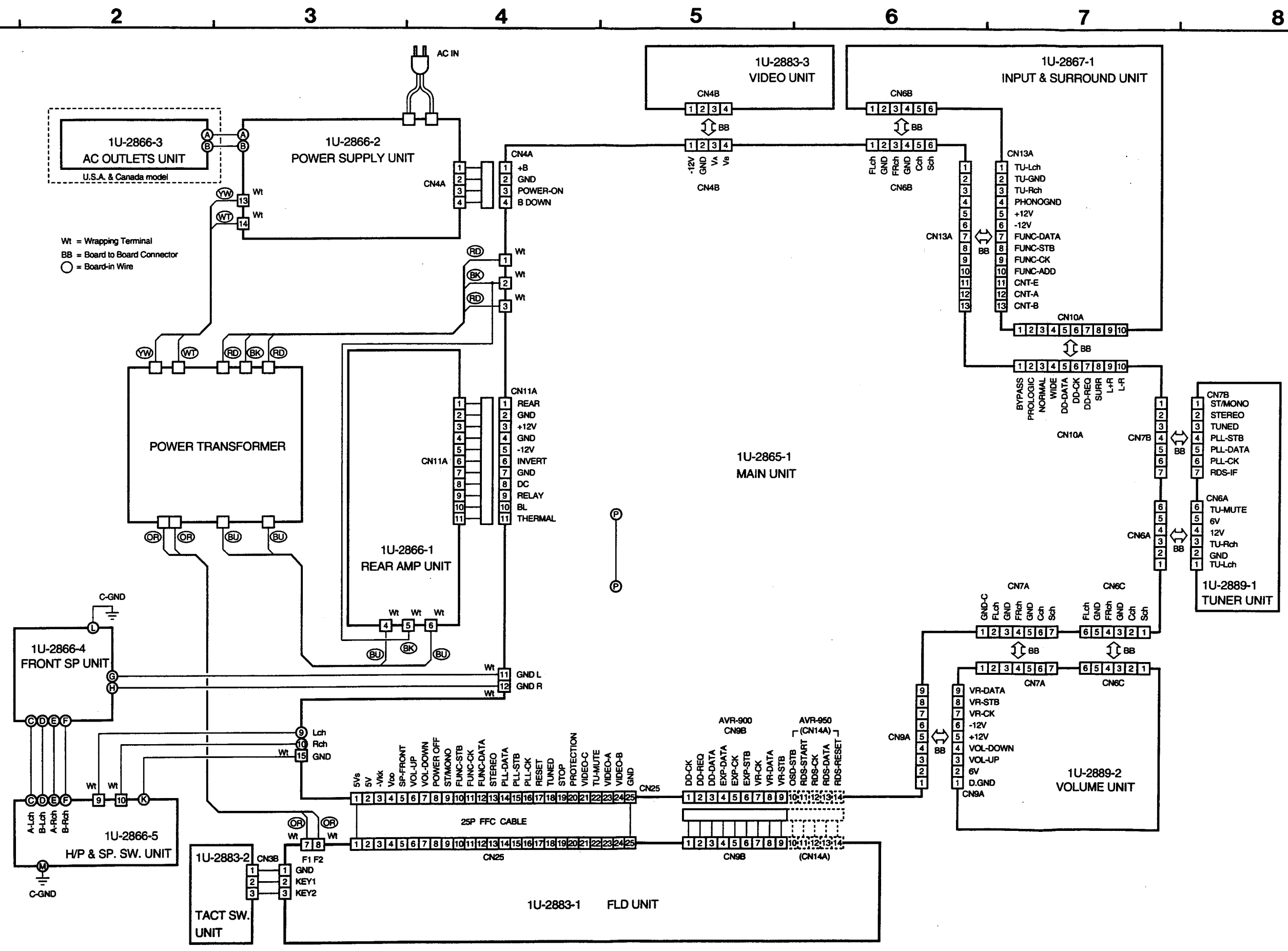

Wt = Wrapping Terminal
 BB = Board to Board Connector
 ○ = Board-in Wire

A
B
C
D
E

REMOTE CONTROL UNIT (RC-195)

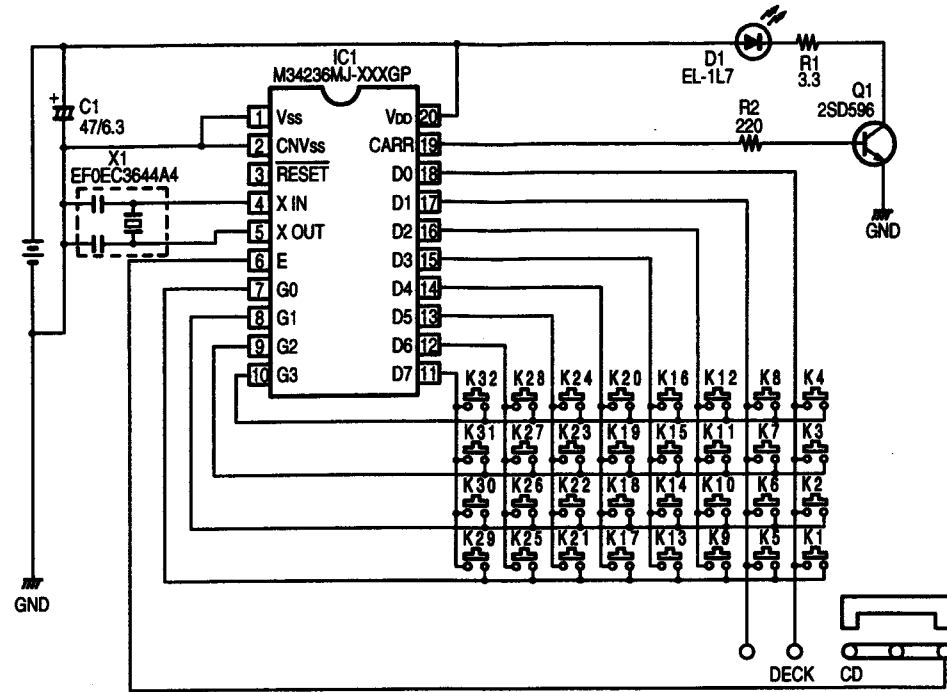

RC-195 Transmitting Code Table

KEY No.	Function	Classification	System address					Data code					Extension		Mask	Judge
			C1	C2	C3	C4	C5	C6	C7	C8	C9	C10	C11	C12		
1	POWER ON/OFF	AV. AMP	0	1	0	0	0	1	0	0	0	0	1	1	0	0
2	DISC SKIP +	CD	0	0	0	1	0	1	1	0	1	1	0	0	0	
3	STOP	CD	0	0	0	1	0	0	1	1	1	0	1	0	0	
4	PLAY	CD	0	0	0	1	0	0	0	1	1	1	0	0	0	
5	AUTO SEARCH	CD	0	0	0	1	0	1	0	0	1	1	0	0	0	
6	PAUSE	CD	0	0	0	1	0	1	0	1	1	1	0	0	0	
7	AUTO SEARCH	CD	0	0	0	1	0	0	0	0	1	0	1	0	0	
8	PRESET CH. DOWN	TUNER	0	0	1	1	0	1	0	1	0	1	1	0	0	
9	PRESET CH. UP	TUNER	0	0	1	1	0	0	1	1	0	1	1	0	0	
10	CD	AV. AMP	0	1	0	0	0	0	0	1	0	0	1	1	0	
11	PHONO	AV. AMP	0	1	0	0	0	1	1	0	0	1	1	0	0	
12	SHIFT	TUNER	0	0	1	1	0	1	0	1	0	0	1	1	0	
13	TUNER	AV. AMP	0	1	0	0	0	1	0	1	0	0	1	1	0	
14	VCR	AV. AMP	0	1	0	0	0	1	0	1	1	0	1	1	0	
15	VDP/DBS	AV. AMP	0	1	0	0	0	0	1	0	1	0	1	1	0	
16	STEREO	AV. AMP	0	1	0	0	0	1	1	0	0	1	1	1	0	
17	SURR. MODE	AV. AMP	0	1	0	0	0	0	1	1	0	0	1	1	0	
18	V. AUX/GAME	AV. AMP	0	1	0	0	0	0	0	1	1	0	0	1	0	
19	DAT/TAPE MONITOR	AV. AMP	0	1	0	0	0	0	1	0	0	1	1	1	0	
20	T. TONE	AV. AMP	0	1	0	0	0	0	1	0	1	0	1	1	0	
21	DELAY+	AV. AMP	0	1	0	0	0	0	1	0	0	1	1	1	0	
22	MUTING	AV. AMP	0	1	0	0	0	0	0	0	0	1	1	1	0	
23	SCREEN	AV. AMP	0	1	0	0	0	1	1	1	1	1	0	1	0	
24	PANEL	AV. AMP	0	1	0	0	0	0	1	1	1	1	0	1	0	
25	CENTER VOLUME UP	AV. AMP	0	1	0	0	0	1	0	1	1	1	1	1	0	
26	CENTER VOLUME DOWN	AV. AMP	0	1	0	0	0	0	1	1	1	1	1	1	0	
27	REAR VOLUME UP	AV. AMP	0	1	0	0	0	1	1	0	0	1	1	1	0	
28	REAR VOLUME DOWN	AV. AMP	0	1	0	0	0	0	0	1	0	1	1	1	0	
29	MASTER VOLUME UP	AV. AMP	0	1	0	0	0	1	0	0	0	1	1	1	0	
30	MASTER VOLUME DOWN	AV. AMP	0	1	0	0	0	0	1	0	0	1	1	1	0	

DECK

KEY No.	Function	Classification	System address					Data code					Extension		Mask	Judge
			C1	C2	C3	C4	C5	C6	C7	C8	C9	C10	C11	C12		
1	POWER ON/OFF	AV. AMP	0	1	0	0	0	1	0	0	0	0	1	1	0	0
2	PLAY	DECK	0	0	1	0	0	1	1	1	0	1	0	1	0	
3	STOP	DECK	0	0	1	0	0	0	1	1	1	0	1	0	0	
4	PLAY	DECK	0	0	1	0	0	0	0	1	1	1	0	1	0	
5	REW	DECK	0	0	1	0	0	1	1	0	1	1	0	1	0	
6	A/B	DECK	0	0	1	0	0	1	1	0	0	1	0	1	0	
7	FF	DECK	0	0	1	0	0	0	1	0	1	0	1	0	0	
8	PRESET CH. DOWN	TUNER	0	0	1	1	0	1	0	1	0	1	0	1	0	
9	PRESET CH. UP	TUNER	0	0	1	1	0	0	1	1	0	1	1	0	0	
10	CD	AV. AMP	0	1	0	0	0	0	0	1	0	0	1	1	0	
11	PHONO	AV. AMP	0	1	0	0	0	1	1	0	0	0	1	1	0	
12	SHIFT	TUNER	0	0	1	1	0	1	0	1	0	0	1	1	0	
13	TUNER	AV. AMP	0	1	0	0	0	1	0	1	0	0	1	1	0	
14	VCR	AV. AMP	0	1	0	0	0	1	0	1	0	0	1	1	0	
15	VDP/DBS	AV. AMP	0	1	0	0	0	0	1	0	1	0	1	1	0	
16	STEREO	AV. AMP	0	1	0	0	0	1	1	1	0	0	1	1	0	
17	SURR. MODE	AV. AMP	0	1	0	0	0	0	0	1	1	0	0	1	0	
18	V. AUX/GAME	AV. AMP	0	1	0	0	0	0	0	1	0	0	1	1	0	
19	DAT/TAPE MONITOR	AV. AMP	0	1	0	0	0	0	1	0	0	1	1	1	0	
20	T. TONE	AV. AMP	0	1	0	0	0	0	1	0	1	0	1	1	0	
21	DELAY+	AV. AMP	0	1	0	0	0	0	1	0	0	1	1	1	0	
22	MUTING	AV. AMP	0	1	0	0	0	0	0	0	0	1	1	1	0	
23	SCREEN	AV. AMP	0	1	0	0	0	1	1	1	1	1	0	1	0	
24	PANEL	AV. AMP	0	1	0	0	0	0	1	1	1	1	0	1	0	
25	CENTER VOLUME UP	AV. AMP	0	1	0	0	0	1	0	1	1	1	1	1	0	
26	CENTER VOLUME DOWN	AV. AMP	0	1	0	0	0	0	1	1	1	1	1	1	0	
27	REAR VOLUME UP	AV. AMP	0	1	0	0	0	1	1	0	0	1	1	1	0	
28	REAR VOLUME DOWN	AV. AMP	0	1	0	0	0	0	0	1	0	1	1	1	0	
29	MASTER VOLUME UP	AV. AMP	0	1	0	0	0	1	0	0	0	1	1	1	0	
30	MASTER VOLUME DOWN	AV. AMP	0	1	0	0	0	0	1	0	0	1	1	1	0	

SCHEMATIC DIAGRAM

1 2 3 4 5 6

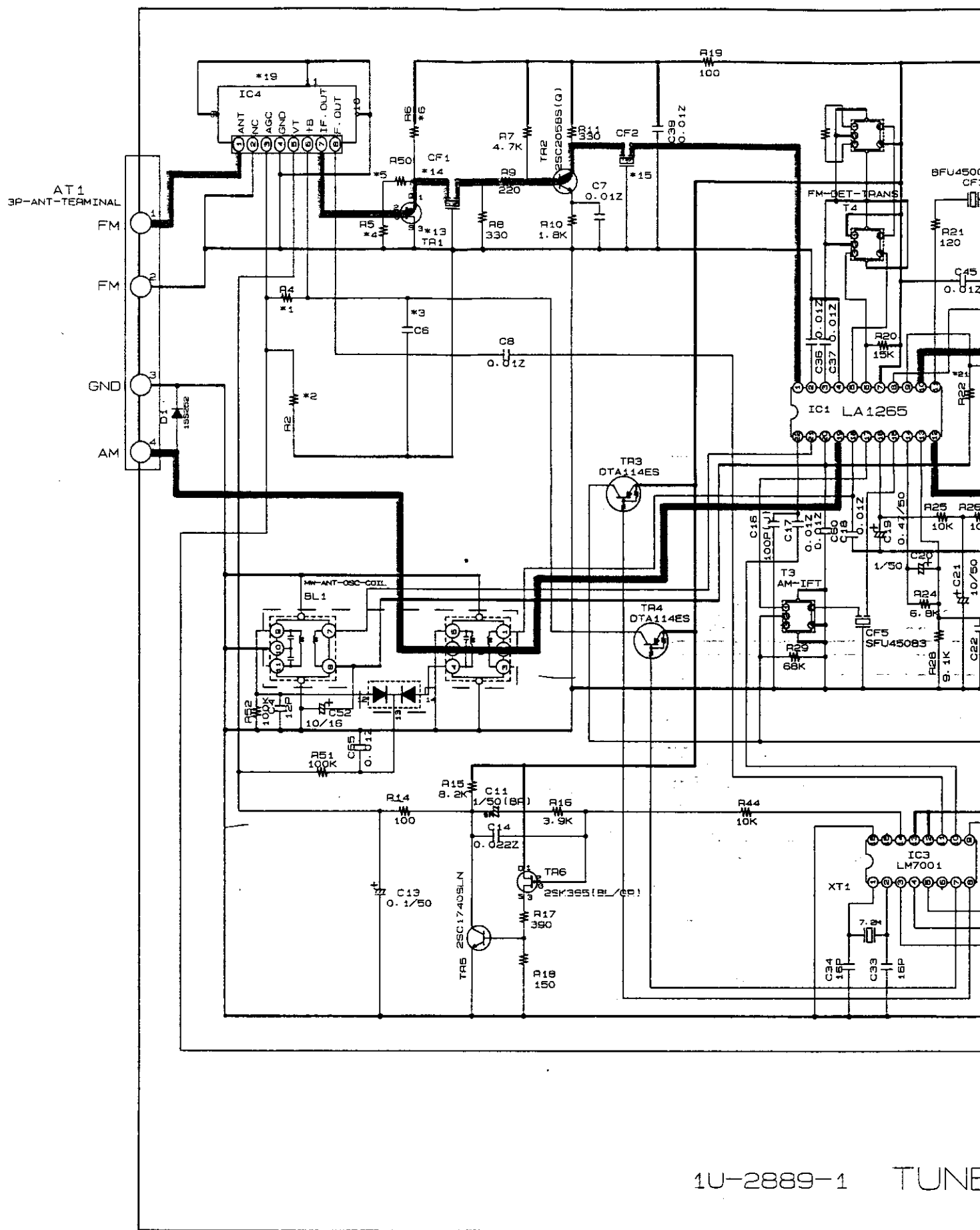

1U-2889-1 TUNE

		900E3	900E1	900E2/EK
*1	R4	---	---	10K
2	R2	---	---	5.6K
3	C6	---	---	CK0.01
4	R5	1K	1K	390
5	R50	100	100	---
6	R6	---	---	330
7	R23	JUMPER	JUMPER	1.6K
8	R32, 35	100K	100K	150K
9	C53, 54	CC750P	CC750P	CC330P
10	R33, 34	120K	120K	200K
11	C23	CC100P	CC100P	---
12	R41, 42	6.8K	6.8K	3.3K
13	TR1	---	---	2SK161
14	CF1	CFSK107M1-A	CFSK107M1-A	CFSK107M2-A
15	CF2	CFSK107M2-A	CFSK107M2-A	CFSK107M2-A
16	C26	---	---	22/16
17	LF1	---	---	ANTI-BIRDIE FILTER
18	LF2, 3	---	---	LPF
19	IC4	F/E 2160102008	F/E 2160102008	F/E 2160079005
20	J4, 5, 6	JUMPER	JUMPER	---
21	R22	18K	39K	39K
22	LF4	---	---	2329010009
23	C55	---	---	CC120P

6 7 8 9 10 11

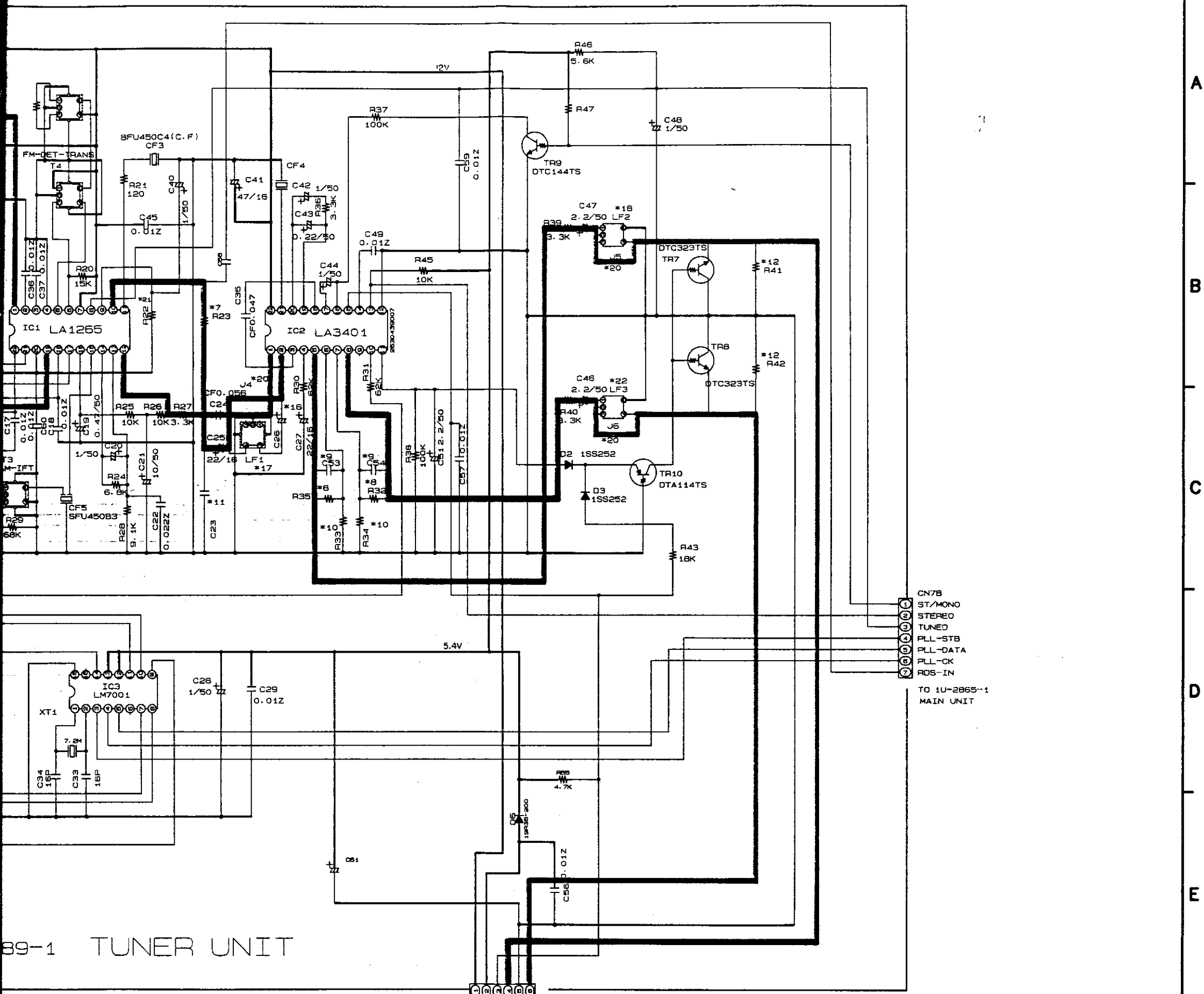

99-1 TUNER UNIT

900E2/EK
OK
.6K
KO.01
990
330
.6K
50K
C330P
00K
.3K
SK161
FSK107M2-A
FSK107M2-A
2/16
ANTI-BIRDIE FILTER
PF
/E
160079005
99K
329010009
CC120P

12V
5V
TU-MUTE
L
GND
R
CN8A
TO 1U-2865-1
MAIN UNIT

— +B LINE
— SIGNAL LINE

NOTES
ALL RESISTANCE VALUES IN OHM. K=1,000 OHM, M=1,000,000 OHM
ALL CAPACITANCE VALUES IN MICRO FARAD. P=MICRO-MICRO FARAD
EACH VOLTAGE AND CURRENT ARE MEASURED AT NO SIGNAL INPUT CONDITION.
CIRCUIT AND PARTS ARE SUBJECT TO CHANGE WITHOUT PRIOR NOTICE.

WARNING:
Parts marked with this symbol have critical characteristics. Use ONLY replacement parts recommended by the manufacturer.

CAUTION:
Before returning the unit to the customer, make sure you make either (1) a leakage current check or (2) a line to chassis resistance check. If the leakage current exceeds 0.5 millamps, or if the resistance from chassis to either side of the power cord is less than 240 kohms, the unit is defective.

WARNING:
DO NOT return the unit to the customer until the problem is located and corrected.

A
B
C
D
E
F
G
H

SCHEMATIC DIAGRAM

1 2 3 4 5 6

A

B

C

D

E

F

G

H

1U-2867-1
SURROUND UNIT

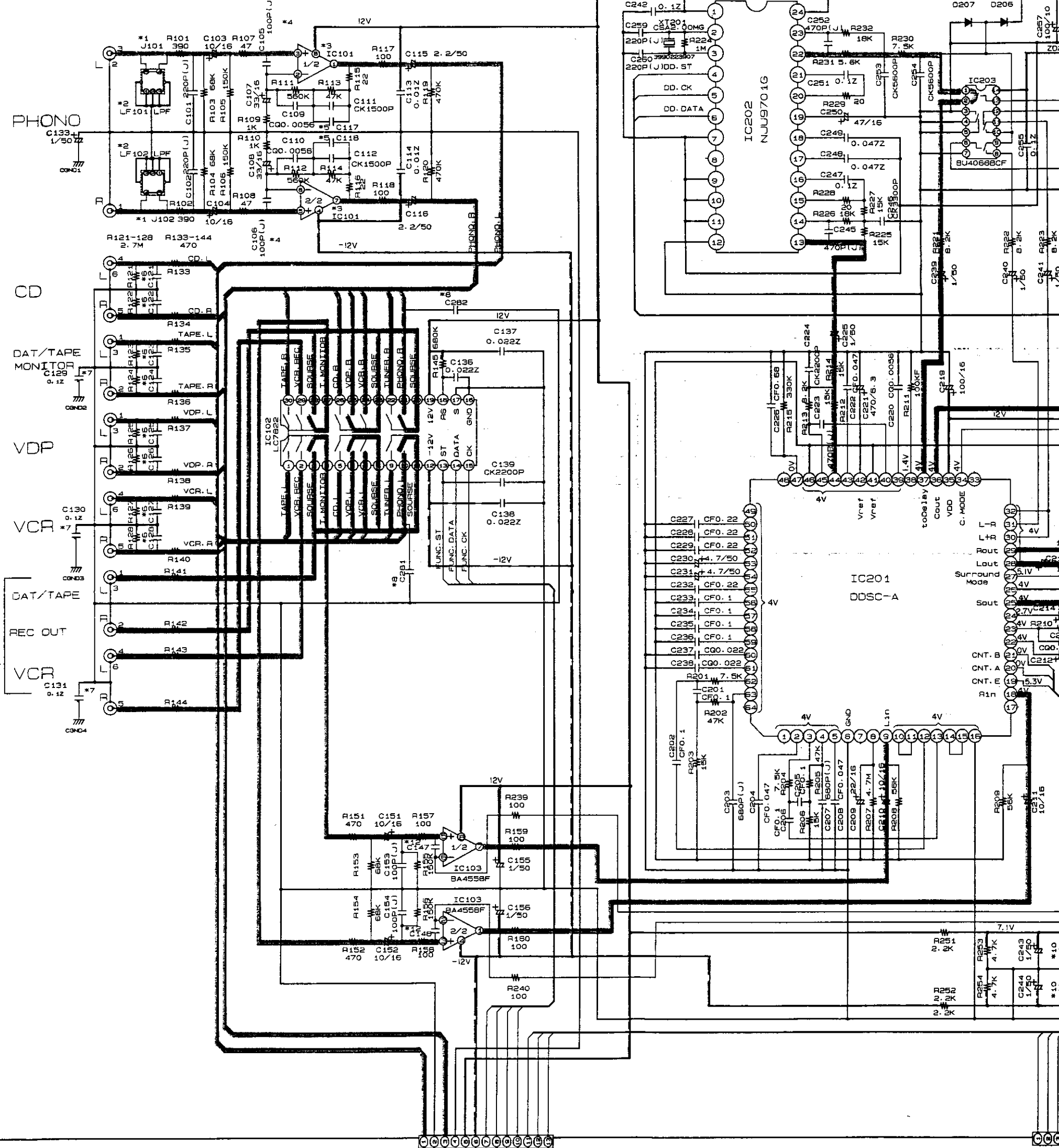

TUNER. L
GND
TUNER. R
PHONO. GND
12V
-12V
FUNC. DATA
FUNC. ST
FUNC. CK
FUNC. ADD
CNT. E
CNT. A
CNT. B

CN13A
TO 1U-2865-1
MAIN UNIT

BYPASS
PRO. LOGIC
NORMAL

CN10A
TO 1U-
MAIN U

NOTES
ALL RESISTANCE VALUES IN OHM. k=1,000 OHM, M=1,000,000 OHM
ALL CAPACITANCE VALUES IN MICRO FARAD. P=MICRO-MICRO FARAD
EACH VOLTAGE AND CURRENT ARE MEASURED AT NO SIGNAL INPUT
CONDITION.
CIRCUIT AND PARTS ARE SUBJECT TO CHANGE WITHOUT PRIOR
NOTICE.

WARNING:
Parts marked with this symbol have critical characteristics.
Use ONLY replacement parts recommended by the manufacturer.

CAUTION:
Before returning the unit to the customer, make sure you make either (1) a
leakage current check or (2) a line to chassis resistance check. If the leakage
current exceeds 0.5 milliamps, or if the resistance from chassis to either side
of the power cord is less than 240 kohms, the unit is defective.

WARNING:
DO NOT return the unit to the customer until the problem is located and
corrected.

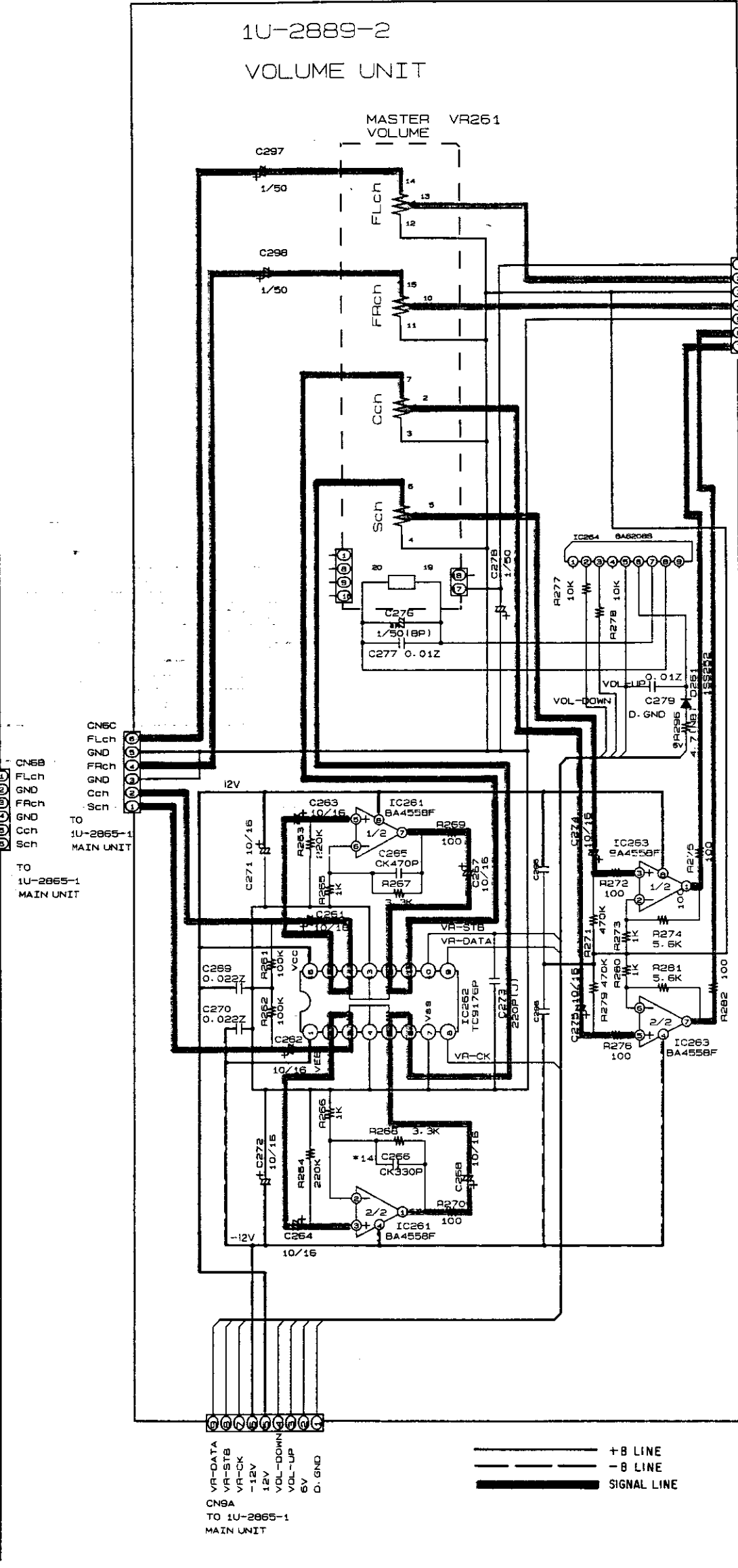
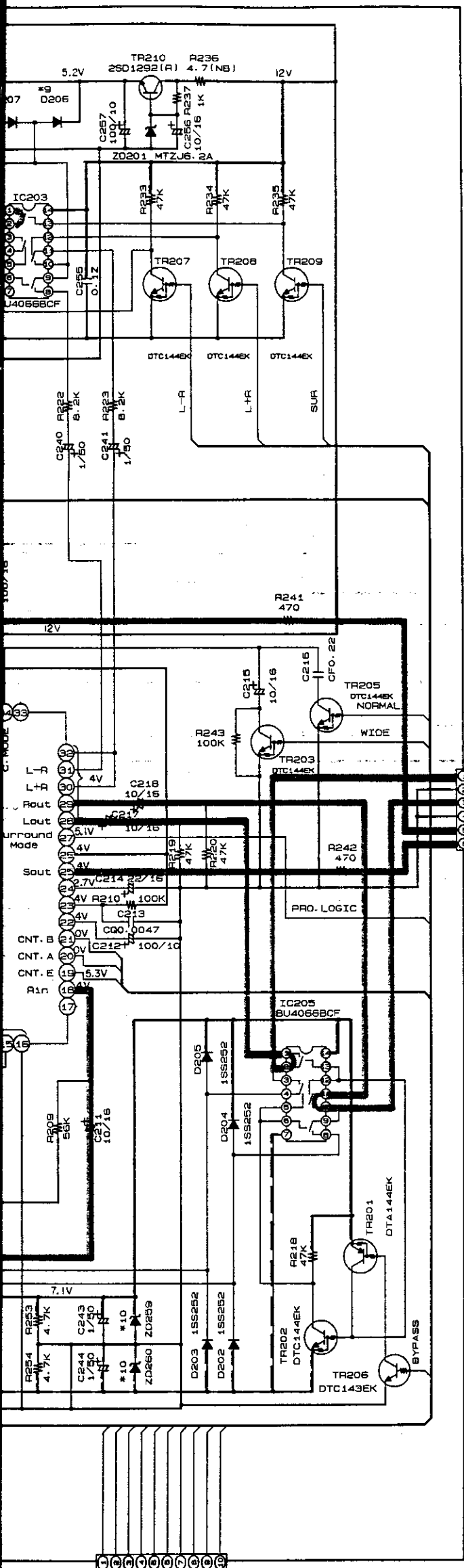

CN7A
GND(C) TO
FLch 1U-2865-1
GND MAIN UNIT
FRch
GND
Cch
Sch

CN6B
FLch
GND
FRch
GND
Cch
Sch
TO
1U-2865-1
MAIN UNIT

CN6C
FLch
GND
FRch
GND
Cch
Sch
TO
1U-2865-1
MAIN UNIT

VR-DATA
VR-STB
VR-CK
-12V
12V
VOL-DOWN
VOL-UP
6V
D.GND
TO 1U-2865-1
MAIN UNIT

--- +B LINE
--- -B LINE
--- SIGNAL LINE

BYPASS
PRO. LOGIC
NORMAL
WIDE
DD. DATA
DD. CK
DD. ST
SUR
L+R
L-R
CN10A
TO 1U-2865-1
MAIN UNIT

	*1	*2	*3	*4	*5	*6	*7	*8	*9	*10	*11	*12	*13
	J101 J102	LF101 LF102	IC101	C105 C106	C117 C118	C121-128 C129-131	C281 C282	D206 D207	ZD259 ZD260	CN3C	C147 C148	C266	
900 E3	JW		8A4558F										CK330P
900 E2/EK/E1	4.7K	FTZ-COIL	NJM-2088MD	100P		CC560		CG0.001				CC100p	CK1200P

SCHEMATIC DIAGRAM

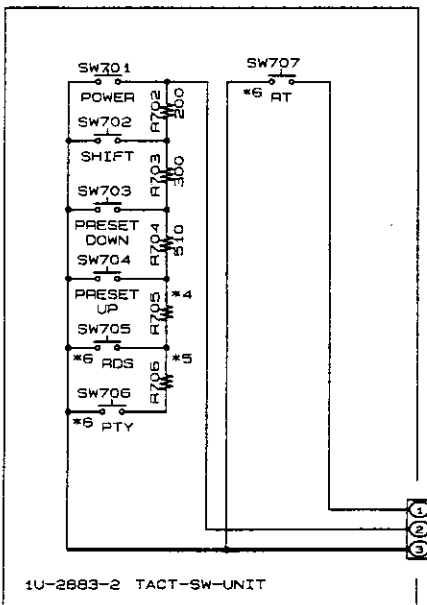
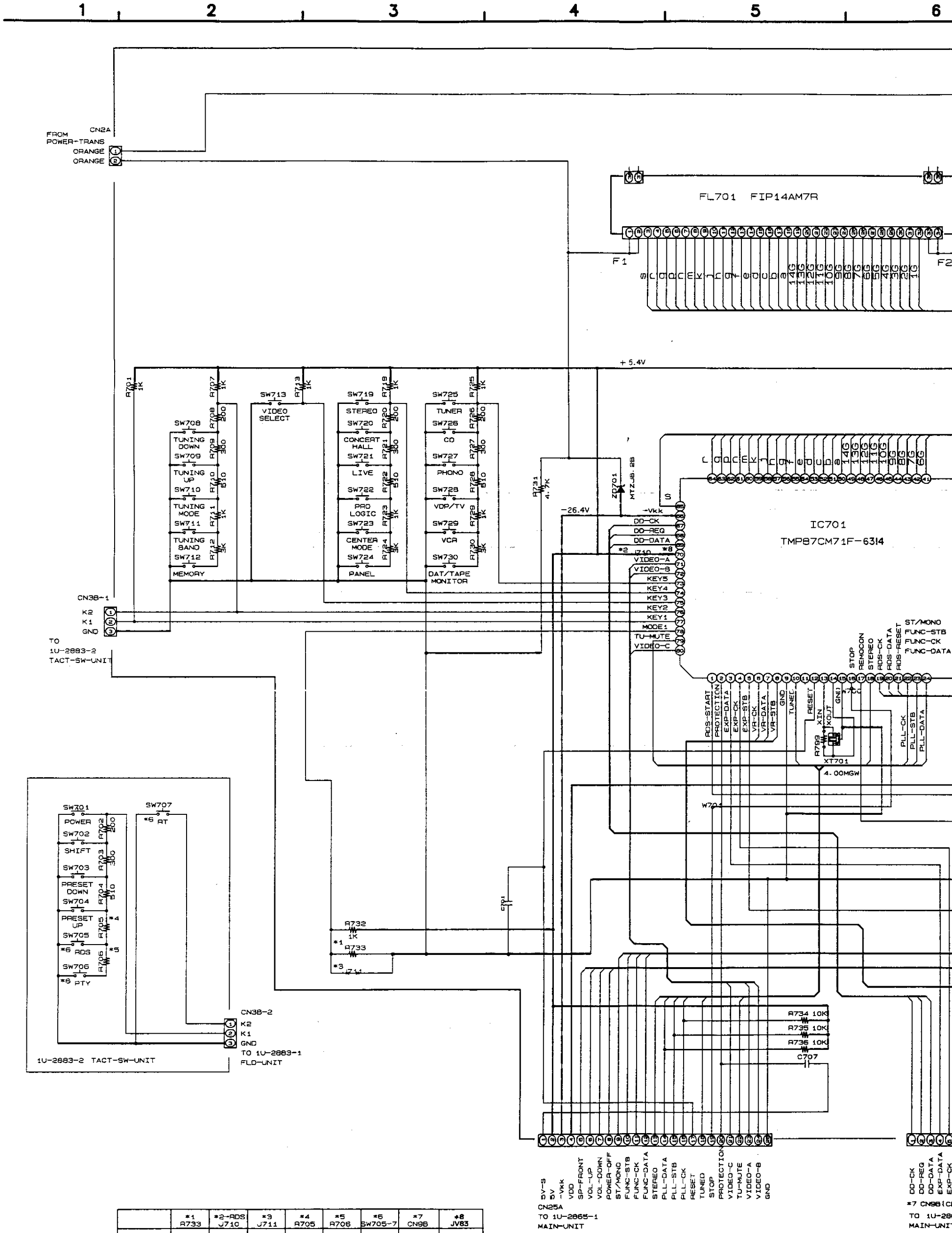

	*1 R733	*2-RDS J710	*3 JUMPER	*4 R705	*5 R706	*6 SW705-7	*7 CN9B	*8 JV83
900E3	200ohm	-	-	-	-	-	o	o
900E2/EK/E1	200ohm	-	-	-	-	-	o	o
900E1T	200ohm	-	cut	-	-	-	o	o

5V-S
 5V
 -VKK
 VDD
 SP-FRONT
 VOL-UP
 VOL-DOWN
 POWER-OFF
 ST/MONO
 FUNC-STB
 FUNC-CK
 FUNC-DATA
 STEREO
 PLL-DATA
 PLL-STB
 PLL-CK
 RESET
 TUNED
 STOP
 PROTECTION
 VIDEO-C
 VIDEO-A
 VIDEO-B
 GND

DD-CK
 DD-REG
 DD-DATA
 EXP-DATA
 EXP-CK

*7 CN9B (CN
 TO 1U-2883-1
 MAIN-UNIT

6 7 8 9 10 11

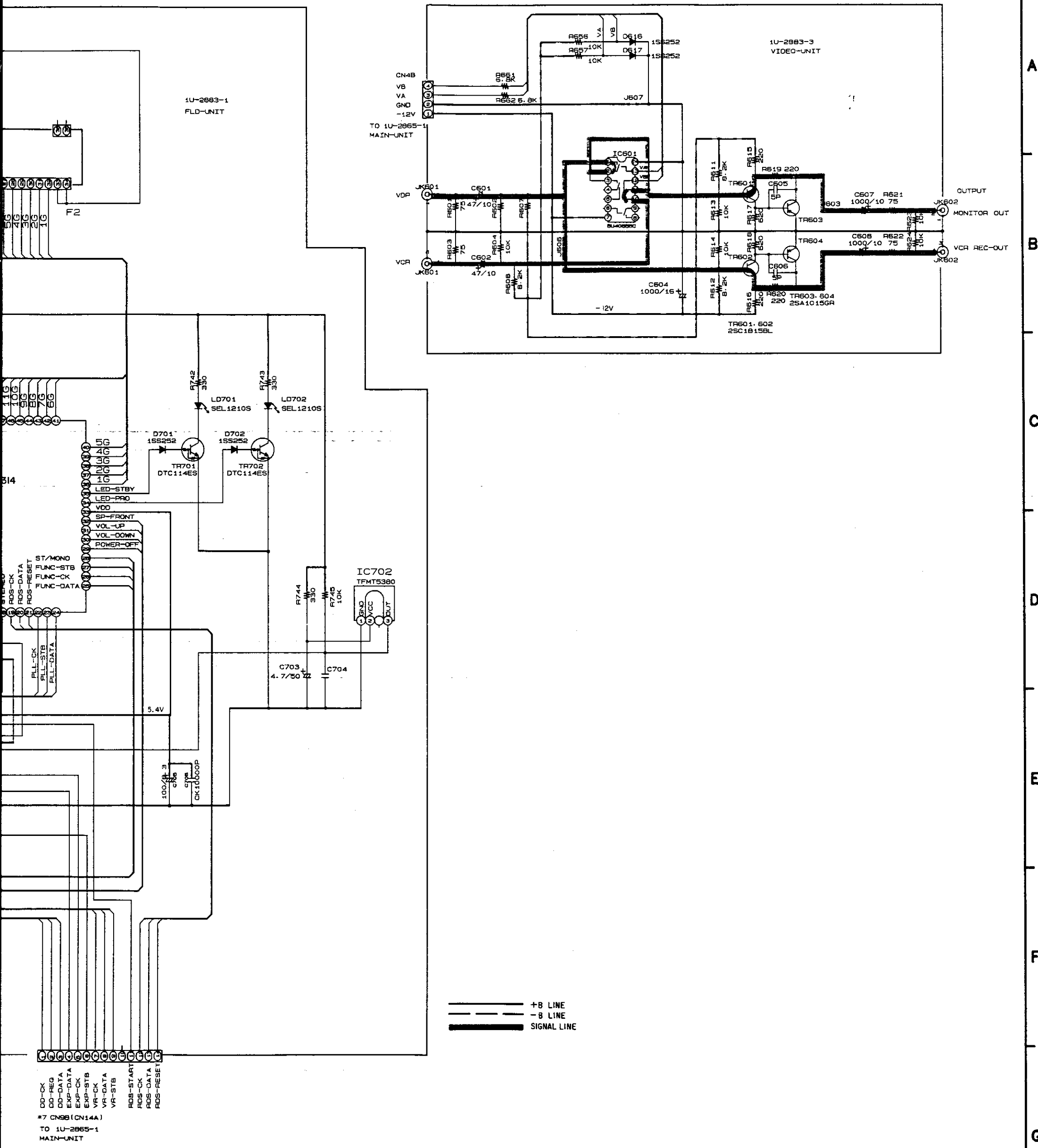

WARNING:
 Parts marked with this symbol have critical characteristics. Use ONLY replacement parts recommended by the manufacturer.

CAUTION:
 Before returning the unit to the customer, make sure you make either (1) a leakage current check or (2) a line to chassis resistance check. If the leakage current exceeds 0.5 milamps, or if the resistance from chassis to either side of the power cord is less than 240 kohms, the unit is defective.

WARNING:
 DO NOT return the unit to the customer until the problem is located and corrected.

NOTES
 ALL RESISTANCE VALUES IN OHM. k=1,000 OHM, M=1,000,000 OHM
 ALL CAPACITANCE VALUES IN MICRO FARAD. P=MICRO-MICRO FARAD
 EACH VOLTAGE AND CURRENT ARE MEASURED AT NO SIGNAL INPUT CONDITION.
 CIRCUIT AND PARTS ARE SUBJECT TO CHANGE WITHOUT PRIOR NOTICE.

A
B
C
D
E
F
G
H

SCHEMATIC DIAGRAM

1 2 3 4 5 6

A

B

C

D

E

F

G

H

1U-2865-1

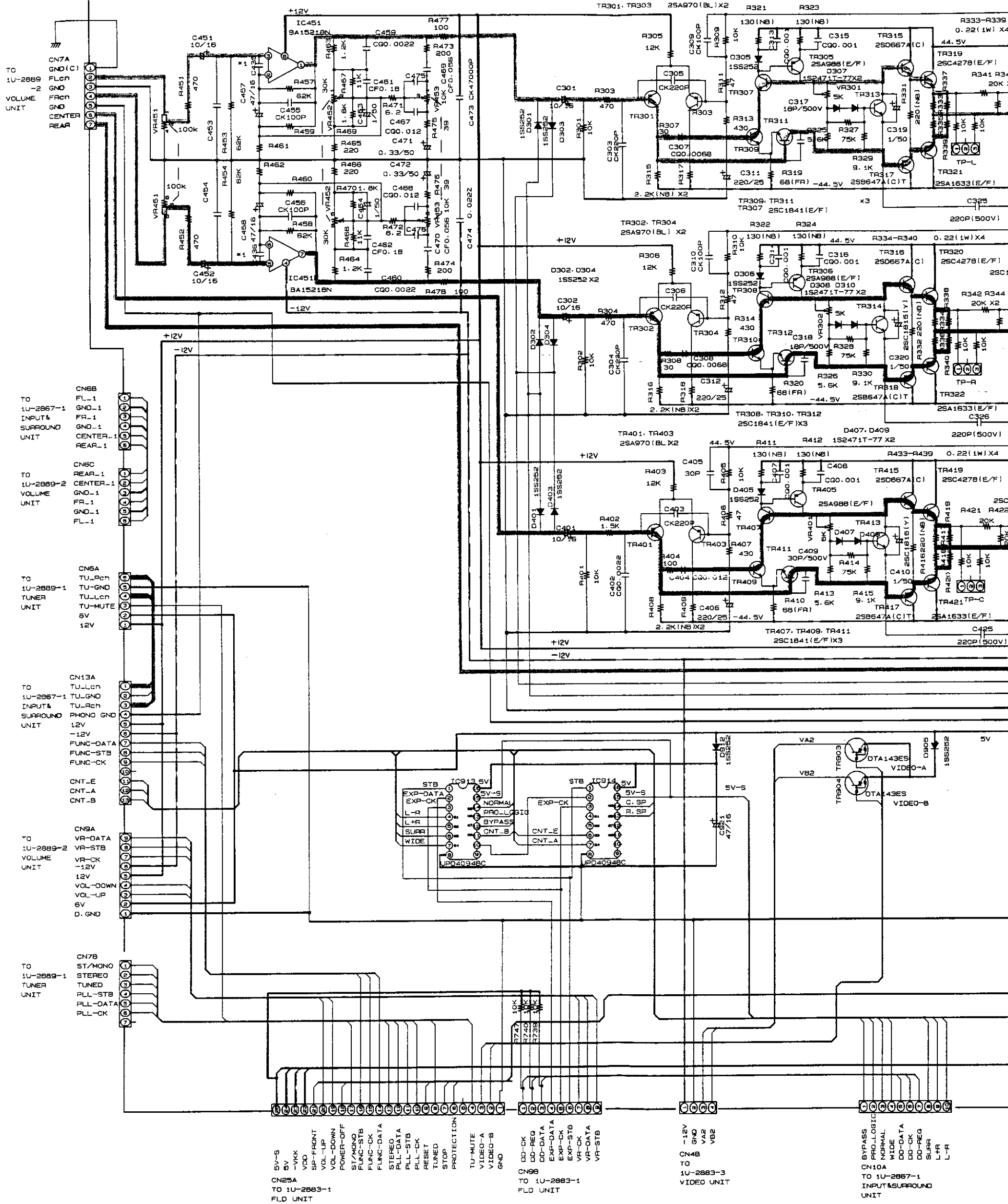

NOTES
 ALL RESISTANCE VALUES IN OHM. K=1,000 OHM, M=1,000,000 OHM
 ALL CAPACITANCE VALUES IN MICRO FARAD. P=MICRO-MICRO FARAD
 EACH VOLTAGE AND CURRENT ARE MEASURED AT NO SIGNAL INPUT CONDITION.
 CIRCUIT AND PARTS ARE SUBJECT TO CHANGE WITHOUT PRIOR NOTICE.

CAUTION:
 Before returning the unit to the customer, make sure you make either (1) a leakage current check or (2) a line to chassis resistance check. If the leakage current exceeds 0.5 millamps, or if the resistance from chassis to either side of the power cord is less than 240 kohms, the unit is defective.

WARNING:
 DO NOT return the unit to the customer until the problem is located and corrected.

CENTER MONO

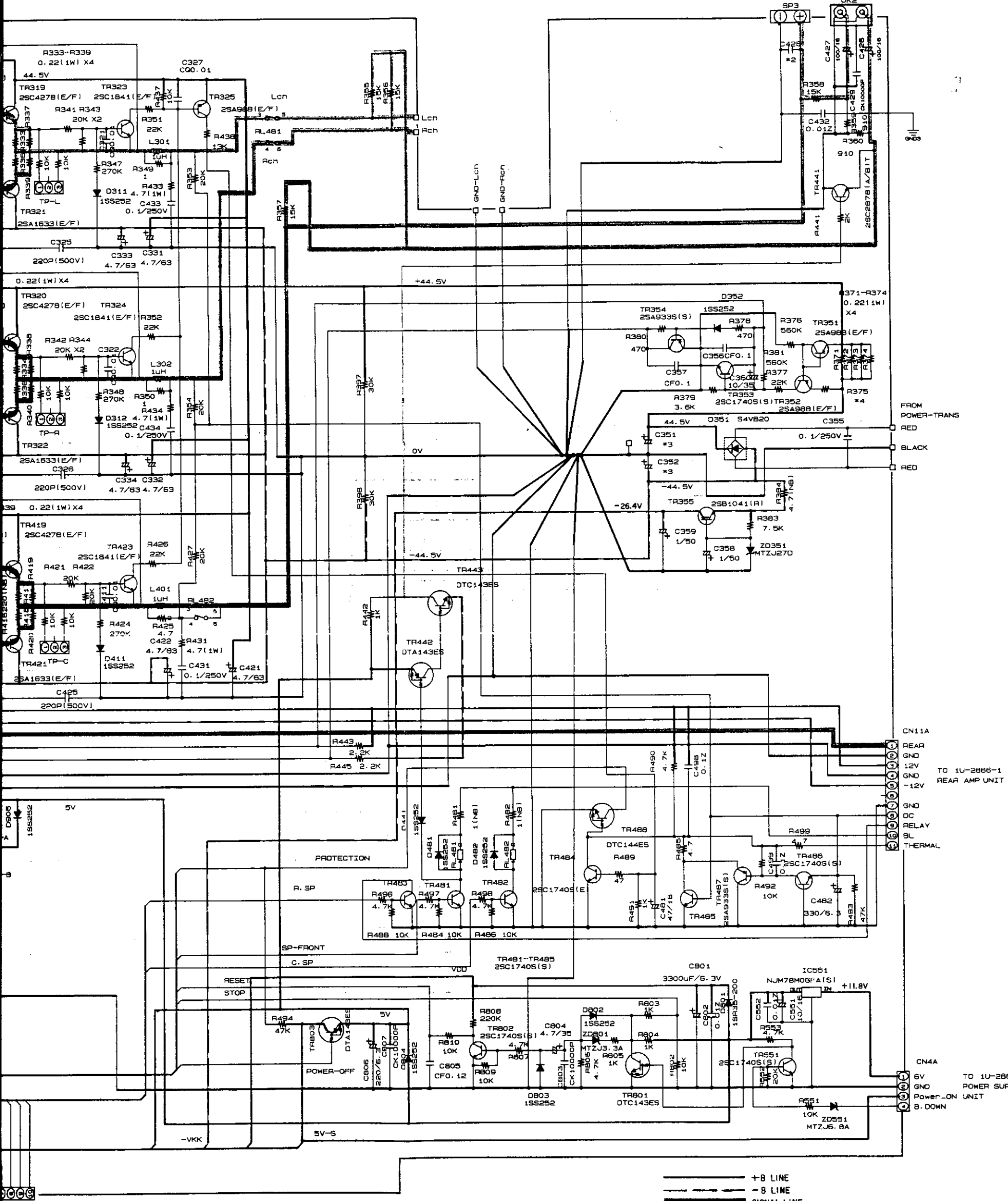

FROM POWER-TRANS
RED
BLACK
RED

CN11A
REAR
GND
12V
GND
-12V
GND
DC
RELAY
BL
THERMAL

CN4A
6V
GND
Power_ON UNIT
B. DOWN

— +B LINE
- - - -B LINE
— SIGNAL LINE

	*1	*2	*3	*4
900	C435, 436	C428	C351, 352	R375
E3	-	-	8200uF/50V	1.1k
E2/EK/E1	100P	0.0047	8200uF/56V	1.2k

SCHEMATIC DIAGRAM

1 | 2 | 3 | 4 | 5 | 6

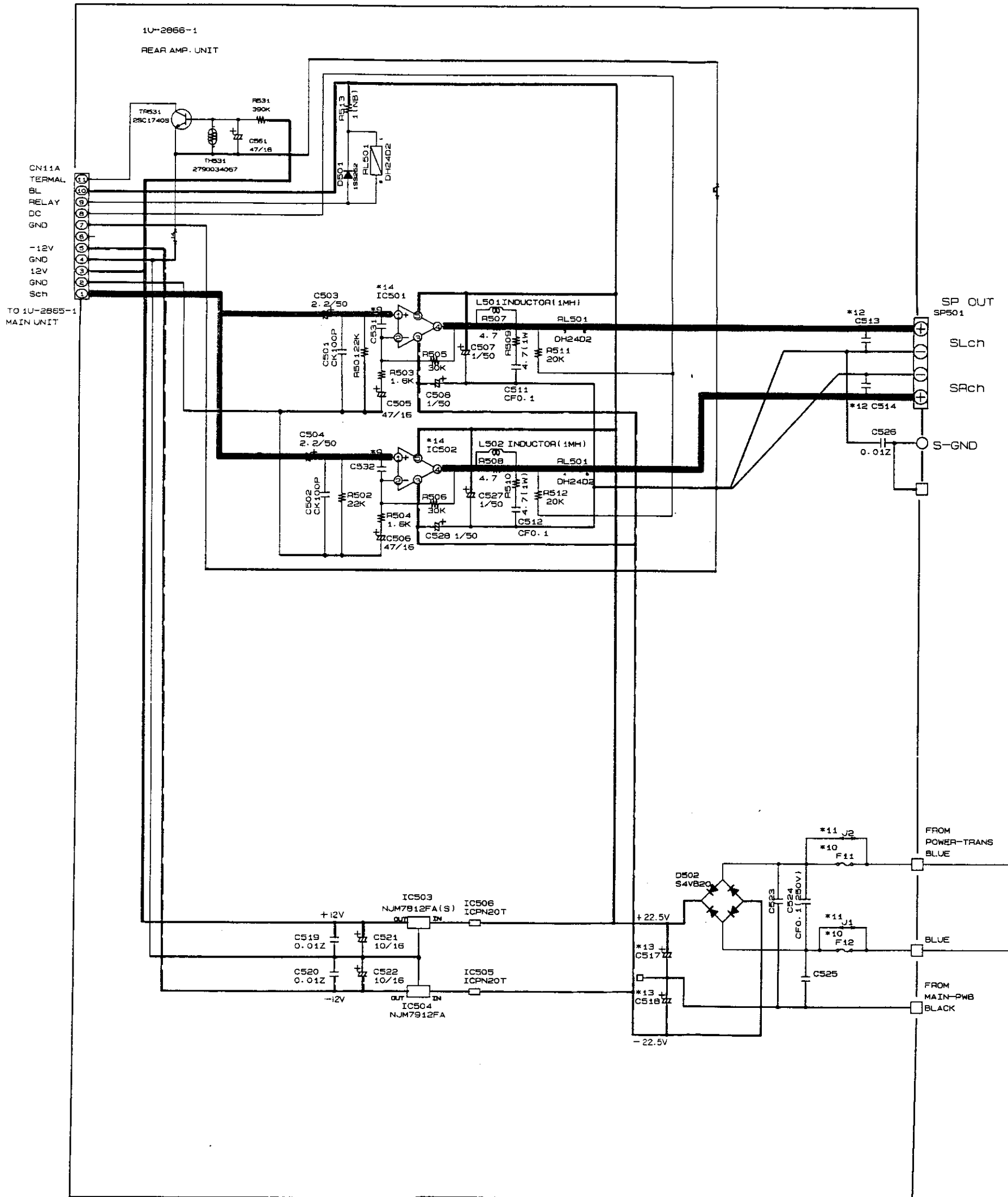

	*9	*10	*11	*12	*13	*14
	C531	F11	J1	C513	C517	IC501
900	C532	F12	J2	C514	C518	IC502
900	-	SA	-	-	3300µF/25V	SI-18781
900	CK100P	-	0	CG4700P	3300µF/25V	SI-18782

DENON 279

6 7 8 9 10 11

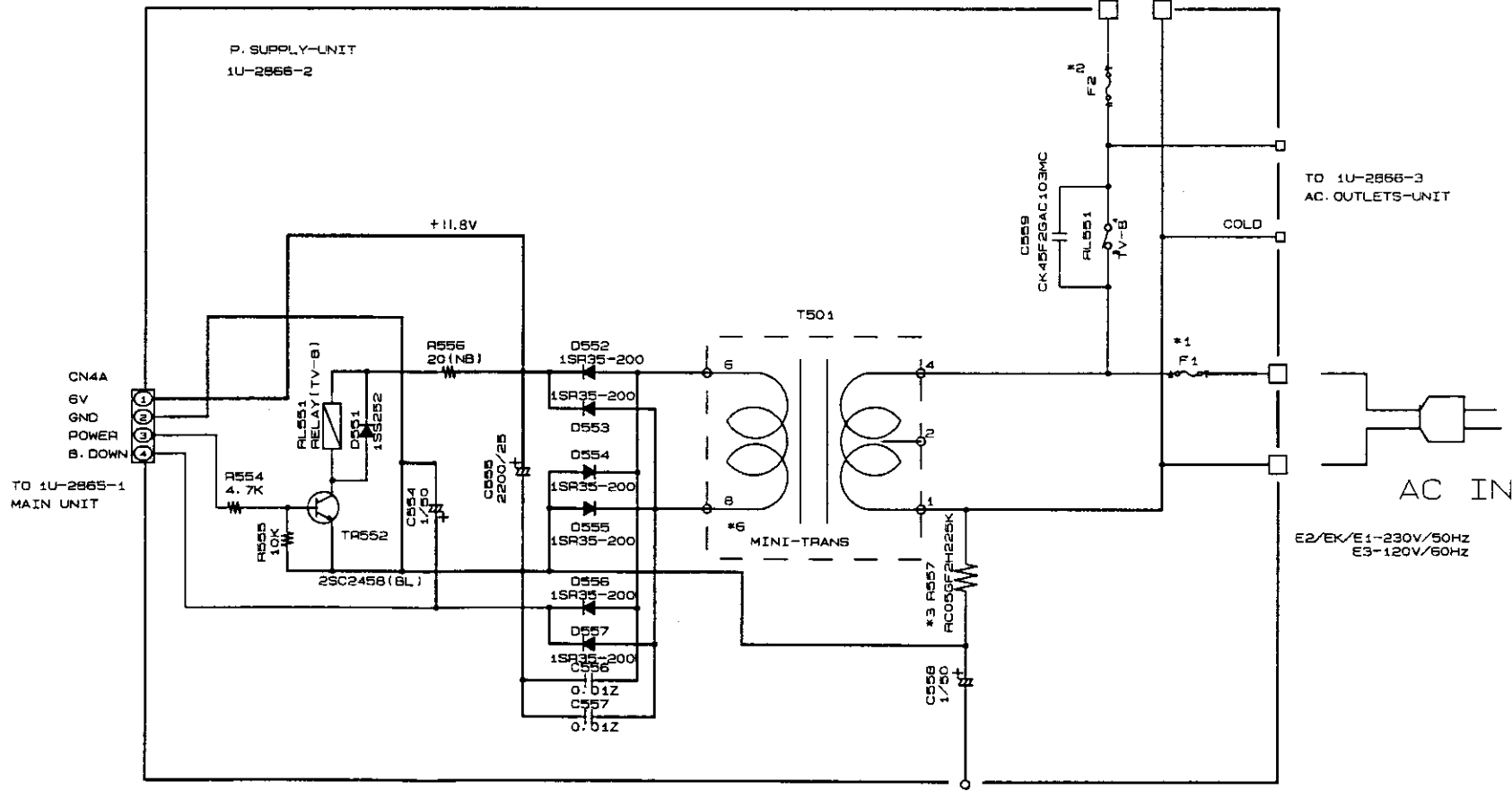
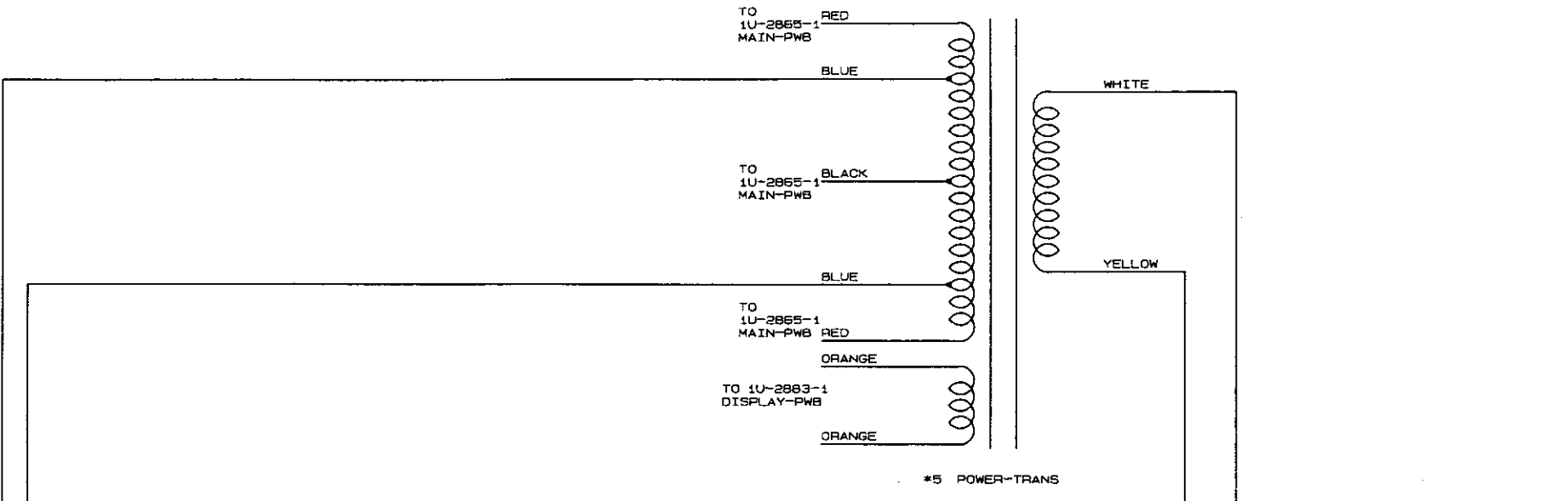
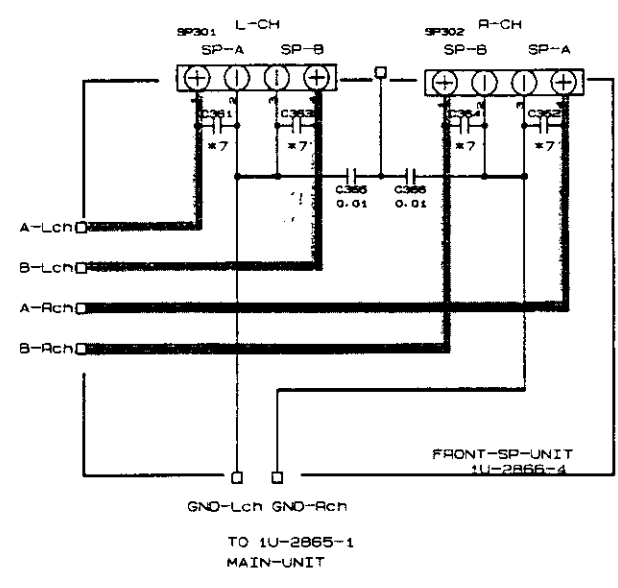
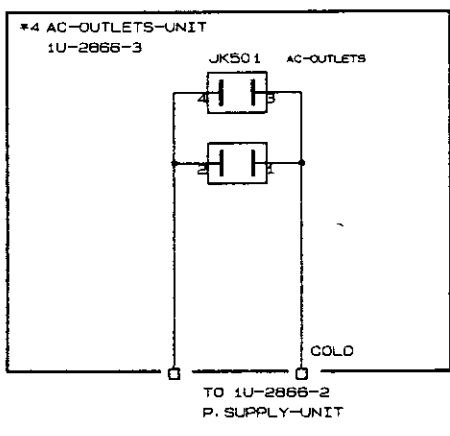
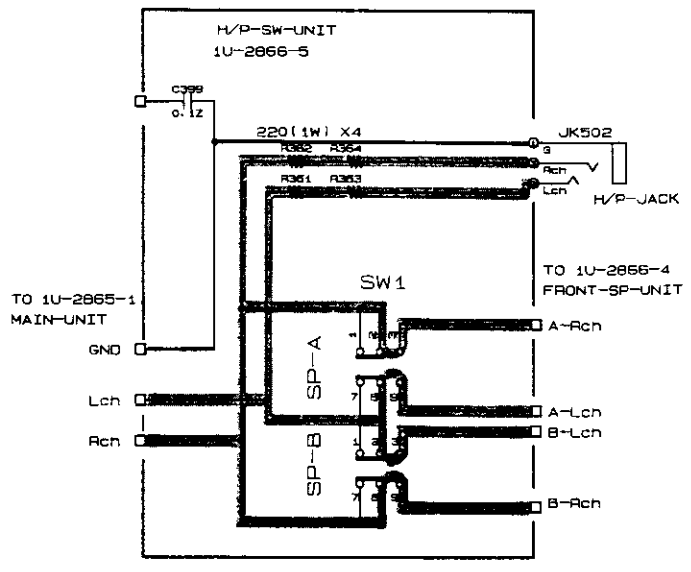

	*1	*2	*3	*4	*5	*6	*7
	F1	F2	R557	AC OUTLETS	POWER TRANS	MINI-TRANS	3K361-364
900 E3	5A /250V	5.3A /250V	2-2H	0	2336178004	2336073000	-
900 E2/EK/E1	-	2.5A /250V	-	-	2336178002	2336048012	006800P

--- +B LINE
 - - - -B LINE
 ——— SIGNAL LINE

NOTES
 ALL RESISTANCE VALUES IN OHM. K=1,000 OHM, M=1,000,000 OHM
 ALL CAPACITANCE VALUES IN MICRO FARAD. P=MICRO-MICRO FARAD
 EACH VOLTAGE AND CURRENT ARE MEASURED AT NO SIGNAL INPUT CONDITION.
 CIRCUIT AND PARTS ARE SUBJECT TO CHANGE WITHOUT PRIOR NOTICE.

WARNING:
 Parts marked with this symbol have critical characteristics. Use ONLY replacement parts recommended by the manufacturer.

CAUTION:
 Before returning the unit to the customer, make sure you make either (1) a leakage current check or (2) a line to chassis resistance check. If the leakage current exceeds 0.5 millamps, or if the resistance from chassis to either side of the power cord is less than 240 kohms, the unit is defective.

WARNING:
 DO NOT return the unit to the customer until the problem is located and corrected.