

DENON

Hi-Fi Digital Audio Preamplifier

SERVICE MANUAL

MODEL DAP-2500A

DIGITAL AUDIO PREAMPLIFIER

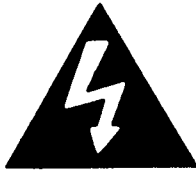

TABLE OF CONTENTS

OPERATING INSTRUCTIONS FOR U.S.A. & CANADA MODEL	2 ~ 13
OPERATING INSTRUCTIONS FOR EUROPE & U.K. MODEL	14 ~ 25
REMOVAL OF EACH SECTION	26
BLOCK DIAGRAM	27
METHOD OF ADJUSTMENTS	28
SEMICONDUCTORS	29 ~ 32
PRINTED WIRING BOARD PARTS LIST	
KU-9160B PRE AMP UNIT	33,34
KU-9161B CONTROL UNIT	35,36
1U-1991A DIG. INPUT UNIT	36,37
KU-9161 CONTROL UNIT & 1U-1991 DIG. INPUT UNIT FOR EACH VERSION	38
PRINTED WIRING BOARD PATTERNS	
KU-9160B PRE AMP UNIT	39
1U-1991A DIG. INPUT UNIT	40
KU-9161B CONTROL UNIT	41
EXPLODED VIEW OF CHASSIS AND CABINET & PARTS LIST	
EXPLODED VIEW OF CHASSIS AND CABINET	42
PARTS LIST OF EXPLODED VIEW	43 ~ 45
ADDENDUM LIST	45
WIRING DIAGRAM	46
SCHEMATIC DIAGRAM (ANALOG UNIT)	47
SCHEMATIC DIAGRAM (DIGITAL UNIT)	48

NIPPON COLUMBIA CO., LTD.

EXCEPT U.K. & AUSTRALIA MODELS

**CAUTION**

**RISK OF ELECTRIC SHOCK
DO NOT OPEN**



CAUTION: TO REDUCE THE RISK OF ELECTRIC SHOCK, DO NOT REMOVE COVER (OR BACK). NO USER SERVICEABLE PARTS INSIDE. REFER SERVICING TO QUALIFIED SERVICE PERSONNEL.



The lightning flash with arrowhead symbol, within an equilateral triangle, is intended to alert the user to the presence of uninsulated "dangerous voltage" within the product's enclosure that may be of sufficient magnitude to constitute a risk of electric shock to persons.



The exclamation point within an equilateral triangle is intended to alert the user to the presence of important operating and maintenance (servicing) instructions in the literature accompanying the appliance.

WARNING: TO REDUCE THE RISK OF FIRE OR ELECTRIC SHOCK, DO NOT EXPOSE THIS APPLIANCE TO RAIN OR MOISTURE.

CAUTION

TO PREVENT ELECTRIC SHOCK DO NOT USE THIS (POLARIZED) PLUG WITH AN EXTENSION CORD, RECEPTACLE OR OTHER OUTLET UNLESS THE BLADES CAN BE FULLY INSERTED TO PREVENT BLADE EXPOSURE.

ATTENTION

POUR PREVENIR LES CHOCS ELECTRIQUES NE PAS UTILISER CETTE FICHE POLARISEE AVEC UN PROLONGATEUR UNE PRISE DE COURANT OU UNE AUTRE SORTIE DE COURANT, SAUF SI LES LAMES PEUVENT ETRE INSEREES A FOND SANS EN LAISSER AUCUNE PARTIE A DECOUVERT.

SAFETY INSTRUCTIONS

1. Read Instructions – All the safety and operating instructions should be read before the appliance is operated.
2. Retain Instructions – The safety and operating instructions should be retained for future reference.
3. Heed Warnings – All warnings on the appliance and in the operating instructions should be adhered to.
4. Follow Instructions – All operating and use instructions should be followed.
5. Water and Moisture – The appliance should not be used near water – for example, near a bathtub, washbowl, kitchen sink, laundry tub, in a wet basement, or near a swimming pool, and the like.
6. Carts and Stands – The appliance should be used only with a cart or stand that is recommended by the manufacturer.
- 6A. An appliance and cart combination should be moved with care. Quick stops, excessive force, and uneven surfaces may cause the appliance and cart combination to overturn.
7. Wall or Ceiling Mounting – The appliance should be mounted to a wall or ceiling only as recommended by the manufacturer.
8. Ventilation – The appliance should be situated so that its location or position does not interfere with its proper ventilation. For example, the appliance should not be situated on a bed, sofa, rug, or similar surface that may block the ventilation openings; or, placed in a built-in installation, such as a book case or cabinet that may impede the flow of air through the ventilation openings.
9. Heat – The appliance should be situated away from heat sources such as radiators, heat registers, stoves, or other appliances (including amplifiers) that produce heat.



10. Power Sources – The appliance should be connected to a power supply only of the type described in the operating instructions or as marked on the appliance.
11. Grounding or Polarization – The precautions that should be taken so that the grounding or polarization means of an appliance is not defeated.
12. Power-Cord Protection – Power-supply cords should be routed so that they are not likely to be walked on or pinched by items placed upon or against them, paying particular attention to cords at plugs, convenience receptacles, and the point where they exit from the appliance.
13. Protective Attachment Plug – The appliance is equipped with an attachment plug having overload protection. This is a safety feature. See Instruction Manual for replacement or resetting of protective device. If replacement of the plug is required, be sure the service technician has used a replacement plug specified by the manufacturer that has the same overload protection as the original plug.
14. Cleaning – The appliance should be cleaned only as recommended by the manufacturer.
15. Power Lines – An outdoor antenna should be located away from power lines.
16. Outdoor Antenna Grounding – If an outside antenna is connected to the receiver, be sure the antenna system is grounded so as to provide some protection against voltage surges and built up static charges. Section 810 of the National Electrical Code, ANSI/NFPA No. 70-1984, provides information with respect to proper grounding of the mast and supporting structure, grounding of the lead-in wire to an antenna discharge unit, size of grounding conductors, location of antenna-discharge unit, connection to grounding electrodes, and requirements for the grounding electrode. See Figure A.
17. Nonuse Periods – The power cord of the appliance should be unplugged from the outlet when left unused for a long period of time.
18. Object and Liquid Entry – Care should be taken so that objects do not fall and liquids are not spilled into the enclosure through openings.
19. Damage Requiring Service – The appliance should be serviced by qualified service personnel when:
 - A. The power-supply cord or the plug has been damaged; or
 - B. Objects have fallen, or liquid has been spilled into the appliance; or
 - C. The appliance has been exposed to rain; or
 - D. The appliance does not appear to operate normally or exhibits a marked change in performance; or
 - E. The appliance has been dropped, or the enclosure damaged.
20. Servicing – The user should not attempt to service the appliance beyond that described in the operating instructions. All other servicing should be referred to qualified service personnel.

FIGURE A
EXAMPLE OF ANTENNA GROUNDING ACCORDING
TO NATIONAL ELECTRICAL CODE INSTRUCTIONS
CONTAINED IN ARTICLE 810 - "RADIO AND
TELEVISION EQUIPMENT"

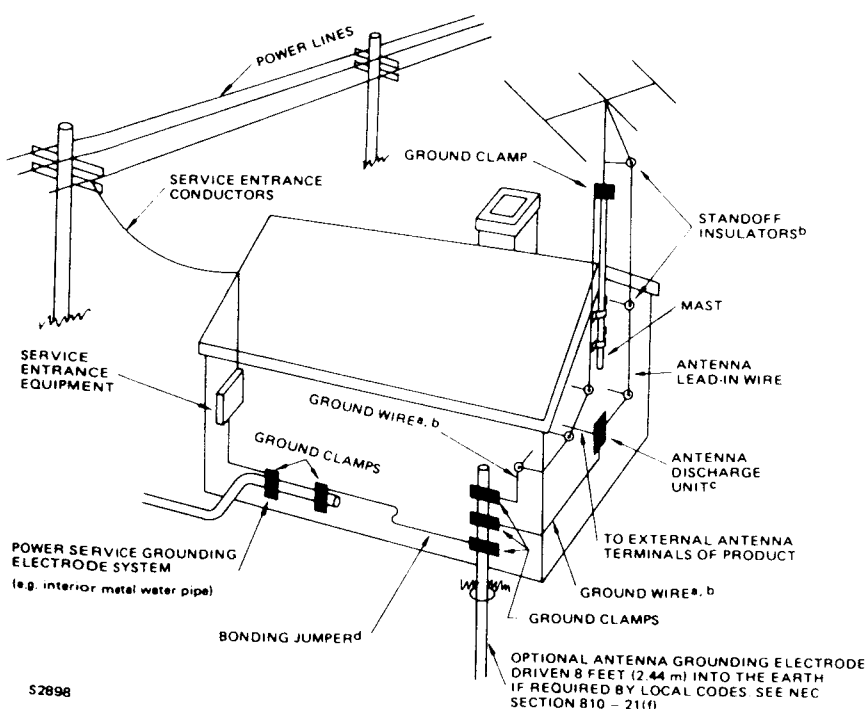

- a Use No. 10 AWG (5.3 mm²) copper, No. 8 AWG (8.4 mm²) aluminum, No. 17 AWG (1.0 mm²) copper-clad steel or bronze wire, or larger, as a ground wire.
- b Secure antenna lead-in and ground wires to house with stand-off insulators spaced from 4-6 feet (1.2-1.83 m) apart.
- c Mount antenna discharge unit as close as possible to where lead-in enters house.
- d Use jumper wire not smaller than No. 6 AWG (13.3 mm²) copper, or the equivalent, when a separate antenna-grounding electrode is used. See NEC Section 810-21 (f).

INSTALLATION PRECAUTIONS

This device (digital audio device) uses a microcomputer for control of the internal electronic circuits. In the event that this device is used at the same time as a tuner or television, interference could occur either in the sound from the tuner or the picture on the television.

Please take the following precautions to avoid such occurrences.

- Keep this device as far away from the tuner or television as possible.
- Keep the power cable and other cables connected to this device separated from the antenna wires of the tuner or television.
- Interference is particularly likely to occur when an indoor antenna or a 300 ohm feeder line is used, so instead use an outdoor antenna and a 75 ohm coaxial cable for the antenna.

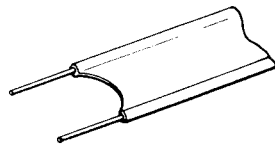

300 ohm feeder line
Ligne d'apport 300 ohms

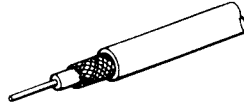

75 ohm coaxial cable
Câble coaxiale 75 ohms

PRECAUTIONS RELATIVES A L'INSTALLATION

Cet appareil (audio numérique) se sert d'un micro-ordinateur pour le contrôle de ses circuits électroniques internes. Si l'appareil est employé en même temps qu'un tuner ou un téléviseur, des interférences pourront apparaître soit dans le son du tuner, soit sur l'image du téléviseur.

Suivre les conseils suivants pour éviter la production d'interférences.

- Placer cet appareil aussi loin que possible du tuner ou du téléviseur.
- Installer le cordon d'alimentation et les autres câbles connectés à l'appareil loin des cordons d'antenne du tuner et du téléviseur.
- Des interférences apparaissent facilement quand une antenne intérieure ou une ligne d'apport de 300 ohms est employée; aussi, l'utilisation d'une antenne extérieure et d'un câble coaxial de 75 ohms est-elle recommandée pour l'antenne.

SPECIFICATIONS [ENGLISH]

Equalizer Amplifier (PHONO IN~REC OUT)

Input Sensitivity/Impedance:	PHONO MC: 0.2 mV/100 ohms
	PHONO MM: 2.5 mV/47 kohms
Max. input level:	PHONO MC: 13 mV/1 kHz
	PHONO MM: 160 mV/1 kHz
Max. output/rated output:	10 V/150 mV
Total harmonic distortion:	Less than 0.001% (1 kHz, rated output)
RIAA deviation:	PHONO MC: 20 Hz~100 kHz ± 0.3 dB
	PHONO MM: 20 Hz~ 20 kHz ± 0.2 dB
Signal-to-noise ratio:	PHONO MC: 79 dB (at 0.5 mV input)
(A-weighted)	PHONO MM: 96 dB (at 5 mV input)
Gain:	PHONO MC: 57.5 dB/1 kHz
	PHONO MM: 35.6 dB/1 kHz
Phono subsonic filter:	16 Hz, 12 dB/oct.

High Level Amplifier (AUX IN~PRE OUT-1)

Input terminals:	CD, TUNER, AUX/VIDEO-1, AUX/VIDEO-2
Tape input/output terminal:	TAPE-1, TAPE-2
Input sensitivity/impedance:	
SOURCE DIRECT ON:	1 V/10 kohms
SOURCE DIRECT OFF:	150 mV/33 kohms
Rated output/impedance:	PRE OUT-1: 1 V/10 ohms
	PRE OUT-2 (Balanced out): 2 V/600 ohms
Total harmonic distortion:	0.002% (20 Hz~20 kHz, 1 V output)
Signal-to-noise ratio	
(A-weighted):	105 dB
Frequency response:	1 Hz~300 kHz +0.2 dB, -3 dB
Tone control: TREBLE	10 kHz ± 8 dB
BASS	100 Hz ± 8 dB
Variable loudness:	100 Hz +8 dB,
	10 kHz +4 dB (at Max.)
OUTPUT Switch:	PRE OUT-1, 2/headphone select switch
MUTING Switch:	PRE OUT-1, 2,
	Headphone (- ∞ Muting) Switch

Digital Section (DIGITAL IN~REC OUT)

Digital signal format:	Digital audio interface format (16 bits linear)
Sampling frequencies:	32 kHz, 44.1 kHz, 48 kHz
Input terminals: (Optical):	DIGITAL-1: 1 line
(Coaxial):	DIGITAL-2, 3: 0.5 Vp-p/75 ohms
DAT terminals (Coaxial):	DAT DIGITAL IN 0.5 Vp-p/75 ohms
	DAT DIGITAL OUT 0.5 Vp-p/75 ohms
D/A conversion system:	20 BIT LAMBDA Super Linear Converter
Filter:	8-times oversampling digital filter
Rated output:	REC OUT: 2 V (at 0 dB, DAC OUT position)
Total harmonic distortion:	0.0025% (1 kHz, 0 dB)
Frequency response	2 Hz~20 kHz, ± 0.3 dB
Signal-to-noise ratio:	108 dB
(A-weighted)	
Dynamic range:	100 dB
Channel separation:	100 dB (1 kHz)

Video Section

Video input:	VIDEO-1, 2: 1 Vp-p/75 ohms
Video output:	VIDEO-2 OUT: 1 Vp-p/75 ohms
	MONITOR OUT: 1 Vp-p/75 ohms
Video copy:	VIDEO-1 IN \rightarrow VIDEO-2 OUT

General

REMOTE ON/OFF terminals:	Output $\times 2$
Power supply	AC120 V, 60 Hz (U.S.A and CANADA),
	AC110/120/220/240, 50/60 Hz (multiple)
AC outlets:	Switched $\times 3$: Total 120 W max.
	Unswitched $\times 1$: 240 W max.
Power consumption:	28 W
Dimensions:	434(W) \times 136(H) \times 386(D) mm
Weight:	8.5 kg

Remote Control Unit RC-109

(40 key system remote control unit)

Remote control system:	Infrared pulse system
Power supply:	3 V DC two size R03 (AAA) dry cell batteries
External dimensions:	60(W) \times 180(H) \times 17.5(D) mm
Weight:	110 g (includes batteries)

* Specifications are subject to change without notice.

SPECIFICATIONS [FRANCAIS]

Amplificateur égaliseur (PHONO IN~REC OUT)

Sensibilité d'entrée / impédance:	PHONO MC: 0,2 mV/100 ohms PHONO MM: 2,5 mV/47 ohms
Niveau d'entrée max.:	PHONO MC: 13 mV/1 kHz PHONO MM: 160 mV/1 kHz
Puissance de sortie max. / nominale:	10 V/150 mV
Distorsion harmonique totale:	Inférieur à 0,001% (1 kHz, sortie nominale)
Courbe de correction RIAA:	PHONO MC: 20 Hz~100 kHz $\pm 0,3$ dB PHONO MM: 20 Hz~20 kHz $\pm 0,2$ dB
Rapport signal / bruit pondéré:	PHONO MC: 79 dB (à une entrée de 0,5 mV) PHONO MM: 96 dB (à une entrée de 5 mV)
Gain:	PHONO MC: 57,5 dB/1 kHz PHONO MM: 35,6 dB/1 kHz
Filtre subsonique phono:	16 Hz, 12 dB/oct.

Amplificateur grande puissance (AUX IN~PRE OUT-1)

Bornes d'entrée:	CD, TUNER, AUX/VIDEO-1, AUX/VIDEO-2
Bornes d'entrée / sortie cassette:	TAPE-1, TAPE-2
Sensibilité d'entrée / impédance:	
SOURCE DIRECT ON:	1 V/10 kohms
SOURCE DIRECT OFF:	150 mV/33 kohms
Impédance de sortie nominale:	PRE OUT-1: 1 V/10 ohms PRE OUT-2 (sortie équilibrée): 2 V/600 ohms
Distorsion harmonique totale:	0,002% (20 Hz~20 kHz, sortie 1 V)
Rapport signal / bruit: (pondéré A)	105 dB
Réponse en fréquence:	1 Hz~300 kHz $\pm 0,2$ dB, -3 dB
Contrôle de tonalité: TREBLE	10 kHz ± 8 dB
BASS	100 Hz ± 8 dB
Correcteur physiologique:	100 Hz +8 dB 10 kHz +4 dB (au max.)
Commutateur de sortie: (OUTPUT)	PRE OUT-1, 2/sélecteur de casque
Commutateur silencieux: (MUTING)	PRE OUT-1, 2, Prise casque (- ∞) silencieux

Section numérique (Entrée numérique~sortie enregistrement) (DIGITAL IN~REC OUT)

Format du signal numérique:	Format interface audio numérique (16 octets linéaires)
Fréquences d'échantillonnage:	32 kHz, 44,1 kHz, 48 kHz
Bornes d'entrée: (optiques):	DIGITAL-1: 1 ligne
(coaxiales):	DIGITAL-2, 3: 0,5 Vp-p/75 ohms
Bornes DAT (coaxiales):	DAT DIGITAL IN 0,5 Vp-p/75 ohms DAT DIGITAL OUT 0,5 Vp-p/75 ohms
Système de conversion D/A:	20 BIT LAMBDA - Super Linear Converter
Filtre:	Filtre à suréchantillonnage (8 fois) numérique
Puissance de sortie nominale:	REC OUT: 2 V (à 0 dB, position sortie DAC OUT)
Distorsion harmonique totale:	0,0025% (1 kHz, 0 dB)
Réponse en fréquence:	2 Hz~20 kHz, $\pm 0,3$ dB
Rapport signal / bruit: (pondéré A)	108 dB
Dynamique:	100 dB
Séparation de canaux:	100 dB (1 kHz)

Section vidéo

Entrée vidéo:	VIDEO-1, 2: 1 Vp-p/75 ohms
Sortie vidéo:	VIDEO-2 OUT: 1 Vp-p/75 ohms MONITOR OUT: 1 Vp-p/75 ohms
Copie vidéo:	VIDEO-1 IN \rightarrow VIDEO-2 OUT

Généralités

Bornes sous tension / hors circuit ON / OFF de la télécommande: (REMOTE ON / OFF)	Sortie $\times 2$
Alimentation:	CA 120 V, 60 Hz (Etats-Unis et Canada) CA 110/120/220/240, 50/60 Hz (multiple)
Sorties CA:	Commutées 3 \times : total 120 W max. Non-commutées 1 \times : 240 W max.
Consommation:	28 W
Dimensions:	434 (L) \times 136 (H) \times 386 (P) mm
Poids:	8,5 kg

Télécommande RC-109 (télécommande à 40 touches)

Système de télécommande:	Système à pulsation Infrarouge
Alimentation:	3 piles sèches de type R03 (AAA) de 3 V CC
Dimensions extérieures:	60 (L) \times 180 (H) \times 17,5 (P) mm
Poids:	110 g (y compris les piles)

* Les spécifications sont sujettes de modifications sans préavis.

FRONT PANEL / PANNEAU AVANT

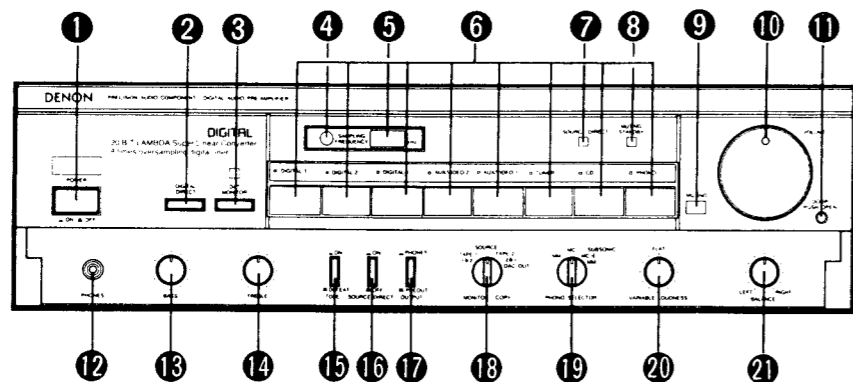

CONNECTIONS/CONNEXIONS

TV (must have a video input terminal)
/ Téléviseur (doit être doté d'une borne d'entrée d'vidéo)

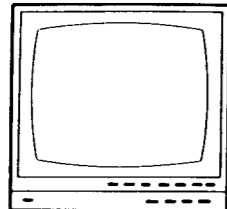

Record Player
(with MC or MM cartridge)
/ Table de lecture
(avec cellule MC ou MM)

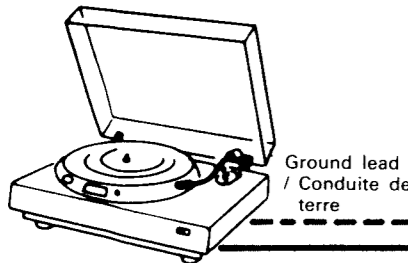

CD player
/ Lecteur de disques compacts

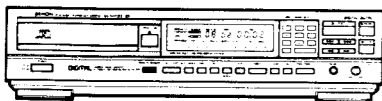

Tuner
/ Syntoniseur



VCR or Video Disc Player
/ Magnétoscope ou lecteur de vidéodisque



VCR / Magnétoscope

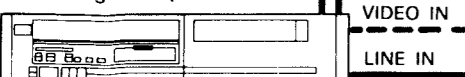

Power amp with balanced input terminal (CANNON plug)
Amplificateur de puissance à bornes d'entrée équilibrée (fiches CANNON)

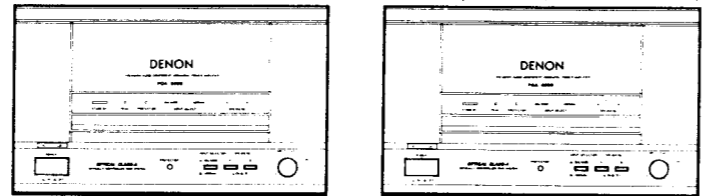

Power Amplifier
/ Amplificateur de puissance

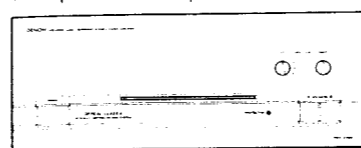

The power can be turned on and off with the remote control unit.

CAUTION

This AC outlet is for use with electronic equipment. DO NOT connect electric equipment whose total power consumption exceeds 120 W.

L'appareil peut être mis sous tension ou hors circuit avec la télécommande.

ATTENTION

Cette prise de sortie CA doit être utilisée avec un appareil électronique. NE CONNECTEZ PAS un appareil électrique, dont la consommation totale dépasse 120 W.

REMOTE ON-OFF Terminals

These terminals are used for remote control of the power amplifier and/or active speaker system. A low-voltage DC current is emitted from the terminals to turn on the power of an active speaker system and/or DENON power amplifier (models POA-4400A, POA-6600A, etc.). Two channels will emit independent signals for left and right channels.

Bornes de mise sous/hors tension à distance (REMOTE ON-OFF)

Ces bornes sont utilisées pour la télécommande sur l'amplificateur de puissance et/ou sur le système d'enceinte utilisé. Un courant CC de faible tension est émis à partir des bornes pour mettre sous tension l'alimentation d'un système d'enceintes en fonctionnement et/ou l'amplificateur de puissance DENON (modèles POA-4400A, POA-6600A, etc.). Deux canaux émettront des signaux indépendants pour les canaux de gauche et de droite.

AC OUTLET (AC Convenience Outlets)

The AC convenience outlets can be used for connecting other audio and video components, such as a tuner, turntable, tape deck, etc.

- SWITCHED (MAX. 120 W)
Power to this outlet is turned on and off by the POWER switch. The maximum capacity is 120 W.
- UNSWITCHED (MAX. 240 W)
Power is always supplied to this outlet no matter whether the POWER switch has been turned on or off. The maximum capacity is 240 W.
- Line Voltage Selection (for multiple voltage model only)
The desired voltage may be set with the VOLTAGE SELECTOR knob on the rear panel, using a screwdriver.
- Do not twist the VOLTAGE SELECTOR knob with excessive force as this may cause damage.
- If the VOLTAGE SELECTOR knob does not turn smoothly, please contact a qualified serviceman.

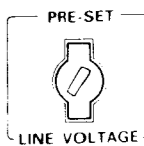

Prises secteur CA (AC OUTLET)

Les prises secteur CA peuvent être utilisées pour raccorder d'autres composants audio et vidéo, tels que tuner, tourne-disque, magnétophone, etc.

- SWITCHED (MAX. 120 W)
L'alimentation de cette prise est enclenchée/déclenchée par l'interrupteur d'alimentation POWER. La capacité maximum de cette prise est de 120 W.
- UNSWITCHED (MAX. 240 W)
Cette prise est toujours sous tension, indépendamment de la position de l'interrupteur d'alimentation POWER. La capacité maximum de cette prise est de 240 W.
- Sélection de la tension de ligne (pour modèle multitenion uniquement)
La tension désirée peut être réglée avec le sélecteur de tension (VOLTAGE SELECTOR) situé sur le panneau arrière, au moyen d'un tournevis.
- Ne pas tordre le sélecteur de tension (VOLTAGE SELECTOR) avec une force excessive, car cela pourrait provoquer un dommage.
- Si le sélecteur de tension (VOLTAGE SELECTOR) ne tourne pas librement, consulter un technicien de service qualifié.

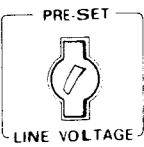

NAMES AND FUNCTIONS OF PARTS

1 POWER switch and LED indicator

(Power supply switch and LED indicator)

When this switch is pressed ON, the power is turned on, and the LED indicator lights. A few seconds will elapse after the power is turned on before operation can begin. This is due to the muting circuitry that is built in to eliminate noise when the power is turned on.

2 DIGITAL DIRECT (Digital direct switch)

Use this switch when playing back components connected to one of the DIGITAL INPUT terminals (DIGITAL-1, 2, 3 DAT IN). When the DIGITAL DIRECT switch is set to "ON", the SAMPLING FREQUENCY indicator 4 will light up.

3 DAT MONITOR (DAT monitor switch)

This switch is used when playing back a component connected to the DAT input terminal when the DIGITAL DIRECT switch is "ON".

The signals of DIGITAL INPUT terminals (DIGITAL-1, 2, 3) cannot be played back when this switch is "ON". The DAT MONITOR indicator will light up when this switch is "ON".

4 REMOTE SENSOR

This is where the signals from the included remote control unit are received.

Refer to Page 11 for operation of the remote control unit.

5 SAMPLING FREQUENCY (Sampling frequency indicator)

This function detects and displays the sampling frequency of the digital signal input to the digital input terminals (DIGITAL-1, 2, 3 or DAT).

- 32 kHz: DAT 32 kHz mode, etc.
- 44 kHz: CD, DAT (When pre-recorded tapes are played back)
- 48 kHz: DAT 48 kHz mode, etc.
- -- kHz: When the DIGITAL DIRECT switch is "ON" and a digital input is not connected, or when the input signal's sampling frequency is not synchronized.

* The indicator closest to the input sampling frequency will light up.

6 INPUT SELECTOR (Input select switches)

This switch is used to select the input signal.

- PHONO: Used to select the output from a record player that is connected to the PHONO terminals. The PHONO selector 19 is used to switch the sensitivity to suit the cartridge type.
- CD: Used to listen to a compact disc player or other component that is connected to the CD terminals.

- TUNER: Used to listen to a component such as an FM/AM tuner, a TV tuner, or an 8-track player that is connected to the TUNER terminals.
- AUX/VIDEO-1 } Used to play a component such as a
- AUX/VIDEO-2 } Hi-Fi video component that is connected to the AUX/VIDEO-1 or AUX/VIDEO-2 terminals.

Set the DIGITAL DIRECT switch 2 to "OFF" (the Frequency display LED will not be lit) in the case of selecting PHONO ~ AUX/VIDEO-2.

- DIGITAL-1: Used when playing back the optical output of a digital audio component such as a CD player or DAT equipped with an optical output terminal which is connected to the DIGITAL-1 terminal.
- DIGITAL-2, 3: Used when playing back a coaxial type digital output of a digital audio component such as a CD player or DAT equipped with a digital output terminal which is connected to the DIGITAL-2 or 3 terminal.

Set the DIGITAL DIRECT switch 2 to "ON" (the Frequency display LED will light up) when selecting DIGITAL-1 ~ 3.

Digital components have different sampling frequencies depending on the component. This amplifier will automatically switch for appropriate operation, so input can be made without any changes.

Normally one indicator lights up for each of the DIGITAL side (DIGITAL-1 ~ 3) and the ANALOG side (PHONO ~ AUX/VIDEO-2).

- * The DAP-2500A uses a high-performance electronic switch for input selection. When the power switch 1 is turned ON, the INPUT SELECTOR switch is automatically set to the TUNER position.
- * When power is turned on using the remote control unit, the INPUT SELECTOR is set to the position selected just before power was turned off (the DAT MONITOR position, however, cannot be selected).

7 SOURCE DIRECT (Source direct indicator)

Lights up when the SOURCE DIRECT switch 16 is turned on.

8 MUTING/STANDBY (Muting/Standby indicator)

The muting circuit operates and the indicator flashes in the following circumstances:

- When the power is turned on (for approx. 8 seconds)
- When the input selector is switched (for approx. 1 second)
- When the digital direct switch is on and no digital signals are being input or the sampling frequency of the input signals is not synchronized.

If the power is turned off with the remote control unit, this indicator lights to indicate that the unit is in the standby mode, and that the power can be turned on from the remote control unit.

The muting operation will be performed when the DIGITAL DIRECT switch is set to "ON" and a digital input is not input to the DIGITAL INPUT terminals. Muting also operates when, at digital input, synchronization of the sampling frequency cannot be taken.

9 MUTING (Muting switch)

Pressing this switch will activate the muting condition and a signal will not be sent to the output side.

Muting indication LED **8** will flash on and off during the muting operation.

Pressing this switch again will cancel the muting.

10 VOLUME (Volume control)

This knob is used to adjust the volume of the entire range.

Turn the knob to the right to raise the volume and to the left to lower it.

The volume can be turned up or down with the remote control unit.

The volume LED flashes when the volume is adjusted with the remote control unit.

11 DOOR (Door-open button)

Press this button to open the door.

This is the only way to open the door. Be sure to push this button. **12** ~ **14** are the functions provided inside the door.

12 PHONES (Headphones jack)

This jack is used to plug in the headphones.

Set the OUTPUT switch to the PHONES (**➤**) position when using headphones.

13 BASS (Bass control)

This is used to regulate the degree of bass in the sound. When the knob is set to the center position, the frequency characteristic curve is flattened in the range below 1000 Hz. The bass increases as the knob is moved off center to the right, and decreases as it is moved to the left.

14 TREBLE (Treble control)

This is used to regulate the degree of treble in the sound.

When the knob is set to the center position, the frequency characteristic curve is flattened in the range above 1000 Hz. The treble increases as the knob is moved off center to the right, and decreases as it is moved to the left.

15 TONE (Tone switch)

The tone control function is operated by using the TONE switch.

When the switch is set to DEFEAT (**■**), the transmission characteristic curve is flattened, and the positions of the BASS and TREBLE knobs have no effect.

When the switch is pressed ON (**➤**), tone control is enabled.

(The level of BASS and TREBLE can be varied.)

16 SOURCE DIRECT (Source direct switch)

The controls (BALANCE, VARIABLE LOUDNESS, and TONE) can be used when this switch is in the OFF (**■**) position.

When set to the ON (**➤**) position, the above controls and the flat amplifier are by-passed and the signals are input directly to the volume control circuit, providing high quality sound. The input sensitivity changes when this switch is turned on and off, so set the volume accordingly.

17 OUTPUT (Output selector switch)

Use this switch to select PREOUT or PHONES.

■ PREOUT: In this position, signals are output from the PREOUT jacks. No signals are output from the headphones jack.

➤ PHONES: Set to this position when using headphones. No signals are output from the PREOUT jacks.

18 MONITOR/COPY (Tape monitor/copy switch)

Set this switch to "SOURCE" for tape deck recording. The signal from the program source selected by the FUNCTION switch will then be output from the REC terminals for TAPE-1 and TAPE-2.

When using two tape decks to make a recording of one tape onto another, set the switch to either TAPE-1 / 1▶2 or TAPE-2 / 2▶1 copy.

- The TAPE-1 / 1▶2 position is used to play the tape deck that is connected to the tape-1 terminals.
- The TAPE-2 / 2▶1 position is used to play the tape deck that is connected to the tape-2 terminals.
- In the DAC OUT position, a program source in which the DIGITAL 1-2 or DAT digital input has undergone D/A conversion is output from the TAPE-1 and TAPE-2 REC terminals.

19 PHONO SELECTOR (Cartridge Selection/Subsonic Filter Switch)

Set this switch to correspond to the type of cartridge (MC or MM) used on your record player. The switch also features positions for activating the subsonic filter, effectively suppressing ultra-low frequencies generated by motor vibrations from the record player and warped records. Such ultra-low (subsonic) frequencies could easily damage your speakers.

- MM: Use this position when an MM cartridge is used on the player connected to the PHONO input jacks.
- MC: Use this position when an MC cartridge is used on the player connected to the PHONO input jacks.
- SUBSONIC-MC: Use this position to eliminate subsonic frequencies when an MC cartridge is used.
- SUBSONIC-MM: Used this position to eliminate subsonic frequencies when an MM cartridge is used.

20 VARIABLE LOUDNESS (Loudness Control)

At low volumes, the human ear is less sensitive to low and high frequencies. Use this control to compensate for this deficiency when listening at low volume levels. Turn this control counter-clockwise until a natural balance of bass and treble sound has been restored.

21 BALANCE (Balance control)

The balance between left and right channels is adjusted by using this knob.

When it is set to the center position, the amplifier gain is the same for the left and the right.

If there seems to be a difference in the left and right channel output voltages for the cartridge, try moving the knob to the left and the right to adjust it. If the volume on the right side is too low, turn the knob to the right. If the volume on the left side is too low, turn the knob to the left.

Video Input Function

The DAP-2500A provides a video input function. VIDEO-1 has first priority in the image selection circuitry, unless VIDEO-2 has specifically been chosen using the INPUT SELECTOR buttons.

The video image function may be used, for example, for watching images on a TV monitor while you are playing a compact disc. In this case, the video signal from the component connected to the VIDEO-1 input terminal, such as a VCR, video disc player or the like, can be routed to the monitor connected to the MONITOR OUT terminal, and pictures be enjoyed for "background video" audio-visual entertainment, combining sound and images.

Video Rec

VIDEO-2 is an auxiliary terminal for recording use. Recording can be performed from VIDEO-1 → VIDEO-2 REC.

Simultaneous recording can be performed by inputting a video signal to the VIDEO terminal of VIDEO-1, and selecting the audio signal (PHONO ~ AUX/VIDEO-1) on the INPUT SELECTOR.

NOTES ON INSTALLING THE PRE-AMPLIFIER

To prevent harmful influence caused by heat build-up and electric radiation from the power amplifier or externally induced humming, preferably install the pre-amplifier next to the power amplifier. If such an installation is not possible, be sure there is a free space of 15 cm or more between the pre-amplifier and power amplifier or other system component.

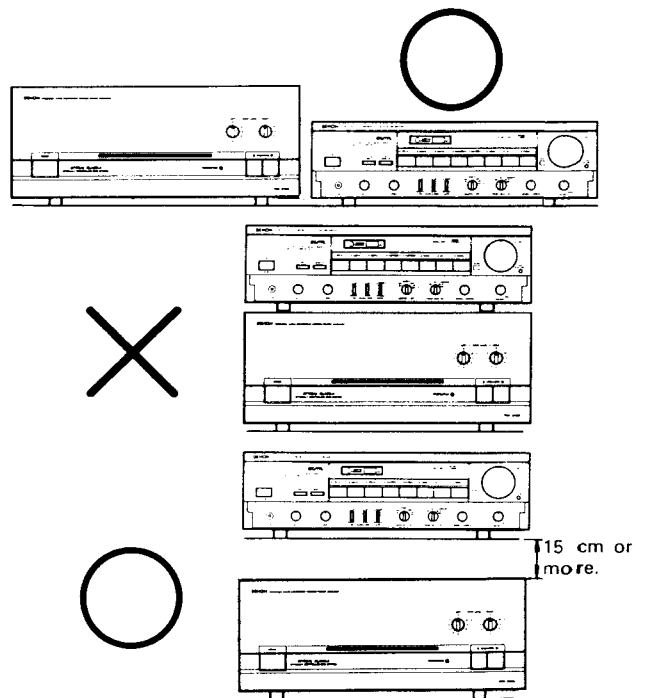

NOTES ON CONNECTION

- Do not plug the power cord into the AC wall outlet until all connections have been completed.
- Make sure channels are correctly connected. Connect Left channels to Left channels and Right channels to Right channels. Follow the color markings of plugs and terminals to make sure mistakes are not made.
- Connect all pin-plugs securely, pushing them completely into the jacks. Incomplete connections will cause noise generation.
- Do not use the AC convenience outlets to power other appliances than audio and video components.
- Binding the connection cables to power cords, or running such cables close to power supply transformers will cause humming or noise, and should thus be avoided.
- The PHONO input jacks are extremely sensitive. Avoid using the power amplifier if no connection has been made to these jacks, as this otherwise may cause low humming from the speakers when the power-amplifier is on.

PLAYBACK USING THE REMOTE CONTROL

The accessory RC-109 remote control unit is used to control the PREAMPLIFIER from a distance.

(1) Inserting the dry cell batteries

- 1 Remove the rear cover on the remote control unit.

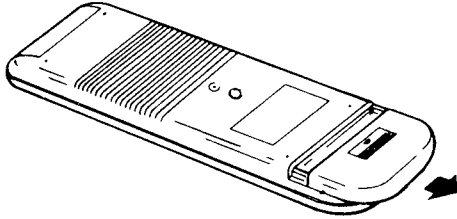

- 2 Insert two size R03 (AAA) dry cell batteries as shown in the diagram on the battery supply unit.

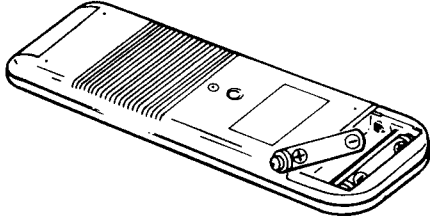

- 3 Replace the rear cover.

Notes on Use of the Batteries

- The remote control unit uses size R03 (AAA) dry cell batteries.
- The batteries will need to be replaced approximately once a year. This will depend upon how often the remote control is used.
- If, in less than a year from the time new batteries were inserted, the remote control fails to operate the preamplifier from a near-by position, it is time to replace the batteries.
- Insert the batteries properly, following the diagram on the remote control battery supply unit, and making sure to align the plus and minus sides of each battery.
- Batteries are prone to damage and leakage. Therefore:
 - Do not combine new batteries with used ones.
 - Do not combine different types of batteries.
 - Do not jumper the opposite poles of the batteries, expose them to heat or break them open, or put them into open fire.
- When the remote control is not to be used for a long period of time, remove the batteries from the unit.
- If the batteries have leaked, remove any battery fluid from the inside of the battery supply unit by wiping it out thoroughly, and insert new batteries.

CAUTION

It may be difficult to operate the remote unit with a fluorescent light near the set, in particular near the remote control sensor, but this is not a malfunction. Should this happen, move the fluorescent light away from the set.

(2) Directions for use

- Operate the remote control unit while it is pointed toward the photosensitive window, as shown in the diagram below.

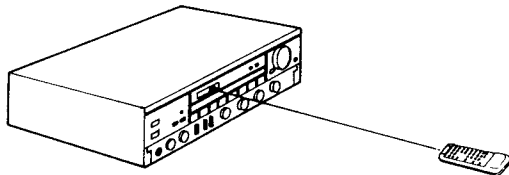

- The remote control unit can be used at distances up to about 7 meters in a straight line away from the player. This distance will decrease if there are obstructions in the way of the transmission or if the light shaft is not directed straight at the player.

Note on Operation

- Do not press the operating buttons on the preamplifier and the remote control unit at the same time. This will cause misoperation.
- Operation of the remote control will become less effective if the infrared photosensitive window is exposed to strong light or if there are obstructions between the remote control unit and the photosensitive window.
- When the remote control productive TV or VCR is used with this pre amplifier, do not press the operating buttons on the remote control unit of both at the same time. This will cause misoperation.

POWER ON-OFF KEY (POWER)

INPUT SELECTOR KEY (AUX/VIDEO-1, TUNER, CD, PHONO, AUX/VIDEO-2, DIGITAL-3, DIGITAL-2, OPTICAL DIGITAL-1, DIGITAL DIRECT, DAT MONITOR, MUTING)

TUNER (TUNER, PRESET CHANNEL, DOWN, UP)

CD (PLAY, PAUSE, STOP, REPEAT)

DECK (PLAY, STOP, PAUSE, REC, REVERSE, W-DECK, REW, FF)

VOLUME KEY (VOLUME +, VOLUME -)

MUTING KEY (MUTING)

▲ UP	CHANNEL UP KEY
▼ DOWN	CHANNEL DOWN KEY
▶ PLAY	PLAY KEY
■ STOP	STOP KEY
⏮	Automatic Search Reverse KEY
⏭	Automatic Search Forward KEY
⏪	Manual Search Reverse KEY
⏩	Manual Search Forward KEY
⏸ PAUSE	PAUSE KEY
⏹ REPEAT	REPEAT KEY

▶ PLAY	PLAY KEY
■ STOP	STOP KEY
⏸ PAUSE	PAUSE KEY
● REC	RECORD KEY
⏮	Automatic Search Reverse KEY
⏭	Automatic Search Forward KEY
⏪	Manual Search Reverse KEY
⏩	Manual Search Forward KEY
▶ PLAY	PLAY KEY
■ STOP	STOP KEY
⏸ PAUSE	PAUSE KEY
● REC	RECORD KEY
◀ PLAY	REVERSE PLAY KEY
SELECT A/B	TAPE SELECTOR KEY
⏮	REVERSE KEY
⏭	FORWARD KEY

DENON SYSTEM REMOTE CONTROL UNIT RC-109

CONNECTION

DIGITAL-1 CONNECTION

Remove the optical connector protection cap and connect the optical cable. Be sure to attach the protective cap when the optical cable is disconnected.

DIGITAL-2, 3 DAT CONNECTION

Be sure to use 75-ohm coaxial cable pin cords for the connection cord.

OPERATION



Proper care

Avoid installing the amplifier in a sealed, airtight cabinet.

1. Check the connections.

- Refer to the connection diagrams on pages (6) and (7), and make sure that no mistakes in the connection have been made.
- Check to make sure that left (L) and right (R) sides of the pin cords are plugged in properly.
- Check to make sure that all cords are firmly connected.

2. Check the setting of each knob and switch.

- Turn the volume knob (VOLUME) all the way to the left to the "minimum" position.
- Set the balance knob (BALANCE) to its center position.
- Set the tone knobs (BASS, TREBLE) to their center positions.
- Set the variable loudness knobs (VARIABLE LOUDNESS) to its "FLAT" position.
- Set the SOURCE DIRECT switch to its "OFF" position ().
- Set the monitor/copy knob (MONITOR/COPY) to the "SOURCE" position.
- Set the OUTPUT switch to its "PRE OUT" position ().
- Set the TONE switch to its "ON" position ().
- Set the muting switch (MUTING) to "OFF".

After checking all of the above, press the power switch (POWER) to turn the power supply ON. The power indicator will light, and a few seconds later, the amplifier will be ready for operation.

- NOTE:**
- While a DIGITAL signal is not being input and the DIGITAL DIRECT switch ② is set to the "ON" position, the muting condition will continue. To cancel this condition, input a DIGITAL signal or set the DIGITAL DIRECT switch to the "OFF" position.
 - Make absolutely sure that the signal cable is never disconnected during DIGITAL-1, 2 or 3 playback. Set the MUTING switch to "ON" or the power to "OFF" if the cable should be disconnected.
 - This unit may be connected with components that have a digital output in accordance with the digital audio interface format.

Playing an Analog Program Source

1. Set the DIGITAL DIRECT (digital direct switching) switch ② to the "OFF" position. Indicator ⑤ will not light.
2. Select the desired program source with INPUT SELECTOR (analog input switching) and TAPE MONITOR (tape input switching).

PROGRAM SOURCE	INPUT SELECTOR	MONITOR/COPY
Record	PHONO	SOURCE
Compact disc	CD	SOURCE
Tuner	TUNER	SOURCE
The other audio equipment	AUX/VIDEO-1, AUX/VIDEO-2	SOURCE
When listening to a tape on a tape deck connected to the TAPE-1 terminals	—	TAPE-1 / 1 ▶ 2
When listening to a tape on a tape deck connected to the TAPE-2 terminals	—	TAPE-2 / 2 ▶ 1

3. Begin playing the program source.

For information on the operating method, refer to the operating instructions for the various components.

4. Adjust the volume.

○ **Playing a Digital Program Source**

1. Set the DIGITAL DIRECT switch ② to the "ON" position. Indicator ⑤ will light.
2. Select the desired program source with the INPUT SELECTOR (digital input switching) and the DAT MONITOR.

PROGRAM SOURCE	INPUT SELECTOR	DAT MONITOR
Digital source with optical output	DIGITAL-1	OFF
Digital source with a coaxial type digital output	DIGITAL-2, 3	OFF
Coaxial type digital source from DAT	-	ON

The sampling frequency indicator will light up in correspondence with the sampling frequency of the digital signal that has been input.

3. Begin playing the program source.
For information on the operating method, refer to the operating instructions for the various components.
4. Adjust the volume.

○ **Analog Recording to the Tape Deck and Tape Copying.**

1. Select the program source that you wish to record with the MONITOR/COPY (recording output switching).

PROGRAM SOURCE	MONITOR/COPY
When recording program sources connected to PHONO ~ AUX/VIDEO-2	SOURCE
When recording from the component connected to the TAPE-1 terminals to TAPE-2	TAPE-1 / 1▶2
When recording from the component connected to the TAPE-2 terminals to TAPE-1	TAPE-2 / 2▶1
When recording a program source connected to DIGITAL-1, 2, 3 DAT MONITOR (Set the DIGITAL DIRECT switch to "ON" at this time)	DAC OUT

Don't change the MONITOR/COPY switch while recording, or you will get intermittent sounds.

2. Begin playing the program source.
3. Begin recording with the tape deck.
For information on the operating method, refer to the operating instructions for the various components.

○ **Digital Copying to the Digital Tape Deck**

NOTE: In some cases digital copying is not possible due to differences in sampling frequency, etc.

For digital tape decks equipped with digital recording input terminals, copying of the unchanged digital signal from the DAT OUT terminals is possible.

1. Set the DIGITAL DIRECT switch ② to "ON".
2. Select the program source that you wish to record with the DIGITAL INPUT SELECTOR (DIGITAL-1, 2, 3).
3. Begin playing the digital program source.
4. Begin recording with the digital tape deck.

For information on the operating method, refer to the operating instructions for the various components.

○ **Monitoring the Recording**

A recording in progress can be monitored if a tape deck with three individual heads for recording and playback is used. A tape deck in which a common head is used for both recording and playback cannot be used to monitor recording.

Set the MONITOR/COPY knob of TAPE-1 or TAPE-2 to corresponding to the tape deck that is being used for the recording. Use the MONITOR/COPY switch to switch between the recording monitor and the program source.

NOTE: When digital signals are being input from a CD player, DAT, etc., noise may be produced from the DAP-2500A if the power of the component sending digital signals is turned off before the power of the DAP-2500A. We recommend either turning off the power of the DAP-2500A first, or turning down the DAP-2500A's main volume control before turning off the power of the CD player, DAT, etc.

OPERATING INSTRUCTIONS FOR EUROPE & U.K. MODEL

For United Kingdom model only.

WARNING:

As the colours of the wires in the mains lead of this appliance may not correspond with the coloured markings identifying the terminals in your plug proceed as follows:

- The wire which is coloured blue must be connected to the terminal which is marked with the letter N or coloured black.
- The wire which is coloured brown must be connected to the terminal which is marked with the letter L or coloured red.

IMPORTANT

The wires in this mains lead are coloured in accordance with the following code:

- Blue: Neutral
- Brown: Live

Die Deutsche Bundespost informiert

Sehr geehrter Rundfunkteilnehmer,

Dieses Gerät ist von der Deutschen Bundespost als Ton- bzw. Fernseh-Rundfunkempfänger bzw. als Komponente einer solchen Anlage (Tuner, Verstärker, aktive Lautsprecherbox, Fernseh-Monitor u. dgl.) zugelassen. Es entspricht den zur Zeit geltenden Technischen Vorschriften und ist zum Nachweis dafür mit dem Zulassungszeichen der Deutschen Bundespost gekennzeichnet. Bitte überzeugen Sie sich selbst. Dieses Gerät darf im Rahmen der "Allgemeingenehmigung für das Errichten und Betreiben von Ton- und Fernseh-Rundfunkempfängern" in der Bundesrepublik Deutschland betrieben werden. Beachten Sie aber bitte, daß aufgrund dieser Genehmigung nur für die Allgemeinheit bestimmte Sendungen und solche, für die ebenfalls eine Allgemeine Empfangsgenehmigung erteilt worden ist¹⁾, empfangen und wiedergegeben werden dürfen. Wer unbefugt andere Sendungen (z. B. des Polizeifunks, des Motofunks) empfängt und wiedergibt, verstößt gegen die Genehmigungsaufgaben und macht sich daher nach § 15, Absatz 2a des Gesetzes über Fernmeldeanlagen strafbar.

Die Kennzeichnung mit dem Zulassungszeichen bietet Ihnen die Gewähr, daß dieses Gerät keine anderen ordnungsgemäß errichteten und betriebenen elektrischen Anlagen stört. Der Zusatzbuchstabe S¹⁾ beim Zulassungszeichen besagt außerdem, daß das Gerät gegen störende Beeinflussungen durch andere ordnungsgemäß errichtete und betriebene elektrische Anlagen weitgehend unempfindlich ist. Geräte ohne den Zusatz S sind nicht besonders sicher gegen Beeinflussungen.

Sollten bei Geräten mit dem Zusatz S ausnahmsweise trotzdem Beeinflussungen auftreten, oder wenn Sie Fragen haben, so wenden Sie sich bitte an die örtlich zuständige Funkstörungswelstelle.

- ¹⁾ Zur Zeit für den Empfang der Aussendungen von Amateurfunkstellen und der Normalfrequenz- und Zeitzeichensendungen.
- ²⁾ Weitere Zusätze haben in Bezug auf die Störfestigkeit keine Bedeutung. Sie geben bei Empfängern vielmehr Aufschluß über Empfangsmöglichkeiten.

Allgemeine Genehmigung für Ton- und Fernseh-Rundfunkempfänger

Die Allgemeine Ton- und Fernseh-Rundfunkgenehmigung vom 11.12.1970 (veröffentlicht im Bundesanzeiger Nr. 234 vom 16.12.1970) wird unter Bezug auf Abschnitt III der Genehmigung durch folgende Fassung der Allgemeinen Genehmigung für Ton- und Fernseh-Rundfunkempfänger gemäß den §§ 1 und 2 des Gesetzes über Fernmeldeanlagen ersetzt:

Genehmigung für Ton- und Fernseh-Rundfunkempfänger

- Die Errichtung und der Betrieb von Ton- und Fernseh-Rundfunkempfängern werden nach §§ 1 und 2 des Gesetzes über Fernmeldeanlagen in der Fassung der Bekanntmachung vom 17.3.1977 (BGBl. I S. 459) allgemein genehmigt.
- Ton- und Fernseh-Rundfunkempfänger im Sinne dieser Genehmigung sind Funkanlagen gemäß § 1 Abs. 1 des Gesetzes über Fernmeldeanlagen, die ausschließlich die für Rundfunkempfänger zugelassenen Frequenzbereiche¹⁾ aufweisen und zum Aufnehmen und gleichzeitigen Hör- oder Sichtbarmachen von Ton- oder Fernseh-Rundfunksendungen bestimmt sind. Zum Empfänger gehören auch eingebaute oder mit ihm fest verbundene Antennen sowie bei Unterteilung in mehrere Geräte die funktionsmäßig zugehörigen Geräte. Außer für den Empfang von Rundfunksendungen dürfen Ton- und Fernseh-Rundfunkempfänger nur mit besonderer Genehmigung der Deutschen Bundespost für andere Fernmeldezwecke zusätzlich benutzt werden. In den Empfängern eingebaute oder sonst mit ihm verbundene Zusatzgeräte (z. B. Ultraschallfernmeldeanlagen, Infrarotfernmeldeanlagen) werden von dieser Genehmigung nicht erfaßt (ausgenommen die Einrichtungen zum Empfang des Verkehrsfunks). Desgleichen sind andere technische Empfängereigenschaften, die über den eigentlichen Zweck eines Rundfunkempfängers hinausgehen (z. B. zum Empfang anderer Funkdienste, für die Wiedergabe im Rahmen von Textübertragungsverfahren) hierdurch nicht genehmigt. Hierfür gelten besondere Regelungen.

Diese Genehmigung wird unter nachstehenden Auflagen erteilt:

- Ton- und Fernseh-Rundfunkempfänger müssen den jeweils geltenden Technischen Vorschriften für Ton- und Fernseh-Rundfunkempfänger entsprechen. Eingebaute Zusatzgeräte müssen den für sie geltenden Bestimmungen und technischen Vorschriften genügen. Änderungen der Technischen Vorschriften, die im Amtsblatt des Bundesministers für das Post- und Fernmeldewesen veröffentlicht werden, muß bei schon errichteten und in Betrieb genommenen Ton- und Fernseh-Rundfunkempfängern nachgekommen werden, wenn durch den Betrieb dieser Rundfunkempfänger andere elektrische Anlagen gestört werden. Serienmäßig hergestellte Ton- und Fernseh-Rundfunkempfänger müssen zum Nachweis dafür, daß sie den

Technischen Vorschriften entsprechen, mit einer DBP-Prüfnummer gekennzeichnet sein. ²⁾ Die DBP-Prüfnummer sagt über die elektrische und mechanische Sicherheit und die Einhaltung der Strahlenschutzbestimmungen nichts aus.

- Ton- und Fernseh-Rundfunkempfänger dürfen an ortsfesten oder nichtortsfesten Rundfunk-Empfangsantennenanlagen, Verteilanlagen oder Kabelfernsehanlagen betrieben und im Rahmen der Bestimmungen über private Drahtfernmeldeanlagen mit Drahtfernmeldeanlagen verbunden werden. Auf demselben Grundstück oder innerhalb eines Fahrzeuges dürfen Ton- und Fernseh-Rundfunkempfänger mit anderen Geräten oder sonstigen Gegenständen (z. B. Plattenspieler, Magnetaufzeichnungs- und Wiedergabegeräte, Antennen) verbunden werden, sofern diese Geräte von der Deutschen Bundespost genehmigt sind oder keiner Genehmigung bedürfen. Die räumliche Kombination von Funkanlagen mit Ton- oder Fernseh-Rundfunkempfängern ist nur dann zulässig, wenn die betreffenden Funkanlagen je für sich genehmigt sind.
- Mit Ton- oder Fernseh-Rundfunkempfängern dürfen aufgrund dieser Genehmigung nur Sendungen des Rundfunks empfangen werden, also übertragene Tonsignale (Musik, Sprache) und Fernsehsignale (nur Bildinformationen). Andere Sendungen (z. B. des Polizeifunks, der öffentlichen beweglichen Landfunkdienste, Datenübertragungen) dürfen nicht aufgenommen werden, werden sie jedoch unbeabsichtigt empfangen, so dürfen sie weder aufgezeichnet, noch anderen mitgeteilt, noch für irgendwelche Zwecke ausgewertet werden. Das Vorhandensein solcher Sendungen darf auch nicht anderen zur Kenntnis gebracht werden.
- Durch Ton- oder Fernseh-Rundfunkempfänger darf der Betrieb anderer elektrischer Anlagen nicht gestört werden.
- Änderungen der Ton- oder Fernseh-Rundfunkempfänger, die die zulässigen Frequenzabstimmbereiche der Empfänger erweitern (gehen über den Umfang dieser Genehmigung hinaus und bedürfen vor ihrer Ausführung einer besonderen Genehmigung der Deutschen Bundespost. Wer aufgrund dieser Genehmigung einen Ton- oder Fernseh-Rundfunkempfänger betreibt, hat bei einer Änderung der kennzeichnenden Merkmale von Ton- oder Fernseh-Rundfunksendern (insbesondere bei Änderung des Sendeverfahrens oder bei Frequenzwechsel) die ggf. notwendig werdenden Änderungen an den Rundfunkempfängern auf seine Kosten vornehmen zu lassen.
- Die Deutsche Bundespost ist berechtigt, Rundfunkempfänger und mit ihnen verbundene Geräte darauf zu prüfen, ob die Auflagen der Genehmigung und die Technischen Vorschriften eingehalten werden. Den Beauftragten der Deutschen Bundespost ist das Betreten der Grundstücke oder Räume, in denen sich Ton- oder Fernseh-Rundfunkempfänger befinden, zu den verkehrsüblichen Zeiten zu gestatten. Befinden sich die Rundfunkempfänger oder mit ihnen verbundene Geräte nicht im Verfügungsbereich desjenigen, der die Empfänger betreibt, so hat er den Beauftragten der Deutschen Bundespost Zutritt zu diesen Teilen zu ermöglichen.

Bei Funkstörungen die nicht durch Mängel der Rundfunkempfänger oder der mit ihnen verbundenen Geräte verursacht werden, können die Funkmedien der Deutschen Bundespost zur Feststellung der Störung in Anspruch genommen werden.

- Diese Genehmigung kann allgemein oder durch die örtlich zuständige Oberpostdirektion einem einzelnen Betreiber gegenüber für einen bestimmten Rundfunkempfänger widerrufen werden. Ein Widerruf ist insbesondere zulässig, wenn die unter Abschnitt II aufgeführten Auflagen nicht erfüllt werden. Anstatt die Genehmigung zu widerrufen, kann die Deutsche Bundespost anordnen, daß bei einem Verstoß gegen eine Auflage ein Ton- oder Fernseh-Rundfunkempfänger außer Betrieb zu setzen ist und erst bei Einhaltung der Auflagen wieder betrieben werden darf. Die Auflagen dieser Genehmigung können jederzeit ergänzt oder geändert werden.
- Diese Genehmigung ersetzt die Allgemeine Ton- und Fernseh-Rundfunkgenehmigung vom 11.12.1970, sie gilt ab 1.7.1979.

Bonn, den 14.5.1979

Der Bundesminister
für das Post- und Fernmeldewesen
im Auftrag
Haist

¹⁾ Siehe Technische Vorschriften für Ton- und Fernseh-Rundfunkempfänger, veröffentlicht im Amtsblatt des Bundesministers für das Post- und Fernmeldewesen.
²⁾ Für ausnahmsweise noch nicht gekennzeichnete, vor dem 1.7.1979 errichtete und in Betrieb genommene Ton-Rundfunkempfänger wird die Kennzeichnung nicht verlangt.

INSTALLATION PRECAUTIONS

This device (digital audio device) uses a microcomputer for control of the internal electronic circuits. In the event that this device is used at the same time as a tuner or television, interference could occur either in the sound from the tuner or the picture on the television. Please take the following precautions to avoid such occurrences.

- Keep this device as far away from the tuner or television as possible.
- Keep the power cable and other cables connected to this device separated from the antenna wires of the tuner or television.
- Interference is particularly likely to occur when an indoor antenna or a 300 ohm feeder line is used, so instead use an outdoor antenna and a 75 ohm coaxial cable for the antenna.

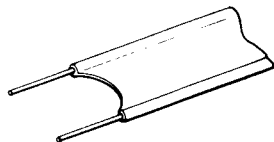

300 ohm feeder line
300 Ohm Flachbandkabel
Ligne d'apport 300 ohms
300 ohms materledning
Piattina da 300 ohm
Linea alimentaoara de 300 ohms.

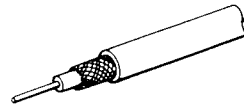





75 ohm coaxial cable
75 Ohm Koaxialkabel
Câble coaxiale 75 ohms
75 ohms koaxialkabel
Cavo coassiale da 75 ohm
Cable coaxial de 75 ohms

VORSICHTS-MAßREGELN ZUR AUFSTELLUNG

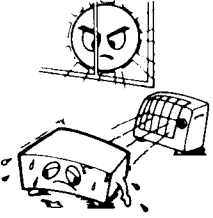
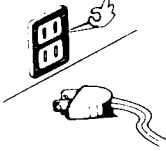
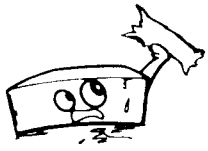
- Halten Sie dieses Gerät so weit wie möglich entfernt von dem Tuner oder Fernseher.
- Halten Sie das Netzkabel und die anderen an dieses Gerät angeschlossenen Kabel von den Antennenstrahlen des Tuners oder des Fernsehers getrennt.
- Interferenz tritt besonders leicht dann auf, wenn eine Innenantenne oder ein 300 Ohm Zuleitungskabel benutzt wird. Bringen Sie aus diesem Grund anstelle dessen eine Außenantenne und ein 75 Ohm Koaxialkabel für die Antenne zur Anwendung.

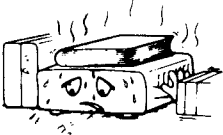
NOTE ON USE/HINWEISE ZUM GEBRAUCH/OBSERVATIONS RELATIVES A L'UTILISATION
NOTE SULL'USO/NOTAS SOBRE EL USO/OBSERVERA

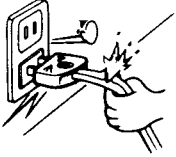
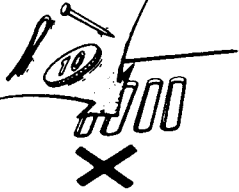
 <ul style="list-style-type: none"> • Be careful of high temperatures. • Vor hohen Temperaturen schützen. • Prendre garde aux fortes températures. • Evitate alte temperature. • Tenga cuidado de las altas temperaturas. • Undvik höga temperaturer. 	 <ul style="list-style-type: none"> • During your absence • Im Falle längerer Abwesenheit • Pendant votre absence • Durante le vostre assenze • Durante su ausencia • Vid ång frånvaro 	 <ul style="list-style-type: none"> • Be sure to read and follow the instructions before using chemically treated cloth. • Lesen und folgen Sie in jedem Fall den Anweisungen, bevor Sie ein chemisch behandeltes Tuch anwenden. • Assurez-vous de lire et suivre les instructions avant d'utiliser un chiffon traité chimiquement. • Fate attenzione di leggere e seguire le istruzioni prima di usare un panno che è stato preparato con dei prodotti chimici. • Asegúrese de leer y seguir las siguientes instrucciones antes de usar un paño con tratamiento químico. • Läs och följ anvisningarna noggrant innan en kemiskt behandlad torkduk används.
 <ul style="list-style-type: none"> • Humidity, water and dust must be prohibited. • Vor Feuchtigkeit, Nässe und Staub schützen! • L'humidité, l'eau et la poussière sont à éviter. • Evitate ogni contatto con umidità, acqua o polvere. • Humedad, agua y polvo deben ser evitados. • Undvik fukt, vatten och damm. 	 <ul style="list-style-type: none"> • Do not place objects on top of the ventilation holes. • Keine Gegenstände auf bzw. vor die Entlüftungsöffnungen stellen! • Ne pas placer d'objets sur les orifices de ventilation de l'appareil. • Non sistemate oggetti sulle aperture di ventilazione. • No coloque objetos sobre las ranuras de la ventilación. • Täck inte över ventilationshålen. 	 <ul style="list-style-type: none"> • Do not open the cabinet. • Das Gehäuse nicht öffnen! • Ne pas ouvrir le boîtier. • Non aprite l'involucro. • No abra el gabinete. • Öppna inte apparatens hölje.
 <ul style="list-style-type: none"> • Be careful with the power supply cord. • Vorsicht bei der Handhabung des Netzkabels! • Manipuler le cordon d'alimentation avec soin. • Maneggiate con cura il cavo d'alimentazione. • Tenga cuidado con el cordón de alimentación. • Var aktsam om nätsladden. 	 <ul style="list-style-type: none"> • Do not allow foreign matter to get inside the equipment. • Keine Fremdkörper ins Geräteinnere gelangen lassen! • Eviter l'entrée de matériaux étrangers dans l'appareil. • Fate attenzione che oggetti estranei non penetrino all'interno dell'unità. • No permita que materias extrañas se introduzcan dentro del equipo. • Inga främmande föremål i apparaten. 	<p>PRECAUTIONS RELATIVES A L'INSTALLATION</p> <ul style="list-style-type: none"> • Eloignez le plus loin possible l'appareil du tuner ou de la télévision. • Ne reliez pas le câble d'alimentation et les autres câbles connectés à cet appareil aux fils d'antenne du tuner ou de la télévision. • Des interférences peuvent se produire si vous utilisez une antenne intérieure ou une ligne d'apport de 300 ohms. Il faut donc utiliser une antenne extérieure et un câble coaxial de 75 ohms pour l'antenne.
<p>PRECAUZIONI PER L'INSTALLAZIONE</p> <ul style="list-style-type: none"> • Tenete quest'unità tanto lontano possibile dal sintonizzatore o dal televisore. • Assicuratevi che il filo di alimentazione e gli altri cavi collegati con quest'unità siano separati dai fili dell'antenna del sintonizzatore o del televisore. • E' particolarmente probabile che risulterà dell'interferenza quando usate un'antenna interna oppure un filo alimentare di 300 ohm. Usate perciò un'antenna esterna e un cavo coassiale di 75 ohm per l'antenna. 	<p>PRECAUCIONES PARA LA INSTALACION</p> <ul style="list-style-type: none"> • Mantenga este artefacto lo más lejos posible del sintonizador o del televisor. • Asegúrese de que el cable de alimentación y demás cables conectados a este artefacto, no queden demasiado cerca de los cables de antena del sintonizador o televisor. • Al usar una antena interior o un alimentador de 300 ohmios podrán producirse interferencias. Por lo tanto, use en vez una antena exterior y un cable coaxial de 75 ohmios. 	<p>OBSERVERA VID INSTALLERING</p> <ul style="list-style-type: none"> • Håll apparaten på så långt avstånd från radio- och TV-apparater som möjligt. • Lägg strömkabeln och andra anslutningskablar från denna apparat separat från antennkablar som går till radio- och TV-apparater. • Störningar kan mycket väl uppstå om en inomhusantenn eller en 300 ohms matarkabel används. Istället bör du därför använda en utomhusantenn eller 75 ohms koaxialkabel för antennen.

[ENGLISH]

SPECIFICATIONS

Equalizer Amplifier (PHONO IN ~ REC OUT)
Input Sensitivity / Impedance: PHONO MC: 0.2 mV/100 ohms
 PHONO MM: 2.5 mV/47 kohms
 PHONO MC: 13 mV/1 kHz
 PHONO MM: 160 mV/1 kHz
Max. input level: 10 V/150 mV
Max. output / rated output: Less than 0.001% (1 kHz, rated output)
Total harmonic distortion: PHONO MC: 20 Hz ~ 100 kHz ± 0.3 dB
 PHONO MM: 20 Hz ~ 20 kHz ± 0.2 dB
RIAA deviation: PHONO MC: 79 dB (at 0.5 mV input)
 PHONO MM: 96 dB (at 5 mV input)
Signal-to-noise ratio: PHONO MC: 57.5 dB/1 kHz
 PHONO MM: 35.6 dB/1 kHz
Gain: 16 Hz, 12 dB/oct.
Phono subsonic filter: 16 Hz, 12 dB/oct.

High Level Amplifier (AUX IN ~ PRE OUT-1)
Input terminals: CD, TUNER, AUX-1, AUX-2
Tape input / output terminal: TAPE-1, TAPE-2
Input sensitivity / impedance: 1 V/10 kohms
SOURCE DIRECT ON: 150 mV/33 kohms
SOURCE DIRECT OFF: PRE OUT-1: 1 V/10 ohms
Rated output / impedance: PRE OUT-2 (Balanced out): 2 V/600 ohms
 0.002% (20 Hz ~ 20 kHz, 1 V output)
Total harmonic distortion: 0.002% (20 Hz ~ 20 kHz, 1 V output)
Signal-to-noise ratio (A-weighted): 105 dB
Frequency response: 1 Hz ~ 300 kHz + 0.2 dB, -3 dB
Tone control: TREBLE 10 kHz ± 8 dB
 BASS 100 Hz ± 8 dB
Variable loudness: 100 Hz + 8 dB, 10 kHz + 4 dB (at Max.)
OUTPUT Switch: PRE OUT-1, 2/Headphone Select Switch
MUTING Switch: PRE OUT-1, 2/Headphone (∞ Muting) Switch

Digital Section (DIGITAL IN ~ REC OUT)
Digital signal format: Digital audio interface format (16 bits linear)
Sampling frequencies: 32 kHz, 44.1 kHz, 48 kHz
Input terminals: (Optical): DIGITAL-1: 1 ligne
 (Coaxial): DIGITAL-2, 3: 0.5 Vp-p/75 ohms
DAT terminals (Coaxial): DAT DIGITAL IN 0.5 Vp-p/75 ohms
 DAT DIGITAL OUT 0.5 Vp-p/75 ohms
D/A conversion system: 20 BIT LAMBDA Super Linear Converter
Filter: 8-times oversampling digital filter
Rated output: REC OUT: 2 V (at 0 dB, DAC OUT position)
Total harmonic distortion: 0.0025% (1 kHz, 0 dB)
Frequency response: 2 Hz ~ 20 kHz, ± 0.3 dB
Signal-to-noise ratio (A-weighted): 108 dB
Dynamic range: 100 dB
Channel separation: 100 dB (1 kHz)

General
Remote ON / OFF terminals: Output × 2
Power supply: AC 220 V/50 Hz (for Europe),
 AC 240 V/50 Hz (for UK & Australia)
Power consumption: 28 W
Dimensions: 434(W) × 136(H) × 386(D) mm
Weight: 8.5 kg

Remote Control Unit RC-110 (40 key system remote control unit)
Remote control system: Infrared pulse system
Power supply: 3 V DC two size R03 (AAA) dry cell batteries
External dimensions: 60(W) × 180(H) × 17.5(D) mm
Weight: 110 g (includes batteries)

* Specifications are subject to change without notice.

[DEUTSCH]

TECHNISCHE DATEN:

Entzerrer Verstärker (PHONO IN ~ REC OUT)
Eingangsempfindlichkeit / Impedanz: PHONO MC: 0,2 mV/100 Ohm
 PHONO MM: 2,5 mV/47 kOhm
Maximaler Eingangspegel: PHONO MC: 13 mV/1 kHz
 PHONO MM: 160 mV/1 kHz
Maximaler Ausgang / Nennausgang: 10 V/150 mV
Gesamtklirr: Weniger als 0,001% (1 kHz, Nennausgang Ausgabel)
RIAA Abweichung: PHONO MC: 20 Hz ~ 100 kHz ± 0,3 dB
 PHONO MM: 20 Hz ~ 20 kHz ± 0,2 dB
Rauschabstand: (A bewertet) PHONO MC: 79 dB (bei 0,5 mV Eingang)
 PHONO MM: 96 dB (bei 5 mV Eingang)
Zunahme: PHONO MC: 57,5 dB/1 kHz
 PHONO MM: 35,6 dB/1 kHz
Subsonic-Phonofilter: 16 Hz, 12 dB/okt.

Hochpegel-Verstärker (AUX IN ~ PRE OUT-1)
Eingangsklemmen: CD, TUNER, AUX-1, AUX-2
Bandeingang / Ausgangsklemme: TAPE-1, TAPE-2
Eingangsempfindlichkeit / Impedanz: 1 V/10 kOhm
SOURCE DIRECT ON: 150 mV/33 kOhm
SOURCE DIRECT OFF: PRE OUT-1: 1 V/10 Ohm
Nennausgang / Impedanz: PRE OUT-2 (Balancierter Ausgang): 2 V/600 Ohm
 0,002% (20 Hz ~ 20 kHz, 1 V Ausgabel)
Gesamtklirr: 105 dB
Rauschabstand (A gewertet): 1 Hz ~ 300 kHz + 0,2 dB, -3 dB
Frequenzgang: 10 kHz ± 8 dB
Klangregler: Höhen (TREBLE) 100 Hz ± 8 dB
 Tiefen (BASS) 100 Hz ± 8 dB
Variable Lautheit: 100 Hz + 8 dB, 10 kHz + 4 dB (bei Max.)
Ausgangsschalter (OUTPUT): PRE OUT-1, 2/Kopfhörerwahlschalter
Stummhaltungsschalter (MUTING): PRE OUT-1, 2/Kopfhörer (∞ Stummhaltung) Schalter

Digitalkomponent (DIGITAL IN ~ REC OUT)
Digitales SignalfORMAT: Digitales Audio-Schnittstellenformat (16 Bit linear)
Samplfrequenz: 32 kHz, 44,1 kHz, 48 kHz
Eingangsklemmen: (Optisch): DIGITAL-1: 1 Leitung
 (Koaxial): DIGITAL-2, 3: 0,5 Vp-p/75 Ohm
DAT-Klemmen (Koaxial): DAT DIGITAL IN 0,5 Vp-p/75 Ohm
 DAT DIGITAL OUT 0,5 Vp-p/75 Ohm
D/A-Wandlersystem: 20 BIT LAMBDA Super Linear Converter
Filter: 8-faches digitales oversampling-Filter
Nennausgang: REC OUT: 2 V (bei 0 dB, DAC OUT Position)
Gesamtklirr: 0,0025% (1 kHz, 0 dB)
Frequenzgang: 2 Hz ~ 20 kHz, ± 0,3 dB
Rauschabstand (A gewertet): 108 dB
Dynamischer Bereich: 100 dB
Kanaltrennung: 100 dB (1 kHz)

Allgemeines
Ein / Ausklemmen (ON / OFF) für Fernbedienung (REMOTE ON / OFF): Ausgang × 2
Stromversorgung: Wechselstrom 220 V/50 Hz (für Europa)
 Wechselstrom 240 V/50 Hz (für Großbritannien und Australien)
Stromverbrauch: 28 W
Abmessungen: 434 (B) × 136 (H) × 386 (T) mm
Gewicht: 8,5 kg

Fernbedienungsgerät RC-110 (Fernbedienungsgerät mit 40 Tastensystem)
Fernbedienungs-system: Infrarot-Impulssystem
Stromversorgung: 3 V Gleichstrombatterien von Form at R03 (AAA) Trocken-zellenbatterien
Außere Abmessungen: 60 (B) × 180 (H) × 17,5 (T) mm
Gewicht: 110 g (einschließlich Batterien)

* Änderung der technischen Daten ohne vorherige Bekanntgabe vorbehalten.

[FRANCAIS]

SPECIFICATIONS

Amplificateur égaliseur (PHONO IN ~ REC OUT)
Sensibilité d'entrée / impédance: PHONO MC: 0,2 mV/100 ohms
 PHONO MM: 2,5 mV/47 ohms
Niveau d'entrée max.: PHONO MC: 13 mV/1 kHz
 PHONO MM: 160 mV/1 kHz
Puissance de sortie max. / nominale: 10 V/150 mV
Distorsion harmonique totale: Inférieure à 0,001% (1 kHz, sortie nominale)
Courbe de correction RIAA: PHONO MC: 20 Hz ~ 100 kHz ± 0,3 dB
 PHONO MM: 20 Hz ~ 20 kHz ± 0,2 dB
Rapport signal / bruit pondéré: PHONO MC: 79 dB (à une entrée de 0,5 mV)
 PHONO MM: 96 dB (à une entrée de 5 mV)
Gain: PHONO MC: 57,5 dB/1 kHz
 PHONO MM: 35,6 dB/1 kHz
Filter subsonique phono: 16 Hz, 12 dB/oct.

Amplificateur grande puissance (AUX IN ~ PRE OUT-1)
Bornes d'entrée: CD, TUNER, AUX-1, AUX-2
Bornes d'entrée / sortie cassette: TAPE-1, TAPE-2
Sensibilité d'entrée / impédance: 1 V/10 kohms
SOURCE DIRECT ON: 150 mV/33 kohms
SOURCE DIRECT OFF: PRE OUT-1: 1 V/10 ohms
Impédance de sortie nominale: PRE OUT-2 (sortie équilibrée): 2 V/600 ohms
 0,002% (20 Hz ~ 20 kHz, sortie 1 V)
Distorsion harmonique totale: 0,002% (20 Hz ~ 20 kHz, sortie 1 V)
Rapport signal / bruit (pondéré A): 105 dB
Reponse en fréquence: 1 Hz ~ 300 kHz ± 0,2 dB, -3 dB
Contrôle de tonalité: Basses 10 kHz ± 8 dB
 Aiguës 100 Hz ± 8 dB
Correcteur physiologique: 100 Hz + 8 dB, 10 kHz + 4 dB (au max.)
Commutateur de sortie (OUTPUT): PRE OUT-1, 2/Selecteur de casque
Commutateur silencieux (MUTING): PRE OUT-1, 2/Prise casque (∞) silencieux

Section numérique (Entrée numérique ~ sortie enregistrement) (DIGITAL IN ~ REC OUT)
Format du signal numérique: Format interface audio numérique (16 octets linéaires)
Frequences d'échantillonnage: 32 kHz, 44,1 kHz, 48 kHz
Bornes d'entrée: (optiques): DIGITAL-1: 1 ligne
(coaxiales): DIGITAL-2, 3: 0,5 Vp-p/75 ohms
Bornes DAT (coaxiales): DAT DIGITAL IN 0,5 Vp-p/75 ohms
 DAT DIGITAL OUT 0,5 Vp-p/75 ohms
Système de conversion D/A: 20 BIT LAMBDA Super Linear Converter
Filter: Filtre à suréchantillonnage (Elois) numérique
Puissance de sortie nominale: REC OUT: 2 V (à 0 dB, position sortie DA; OUT T)
 0,0025% (1 kHz, 0 dB)
Distorsion harmonique totale: 2 Hz ~ 20 kHz, ± 0,3 dB
Reponse en fréquence: 108 dB
Rapport signal / bruit (pondéré A): 100 dB
Dynamic: 100 dB
Séparation de canaux: 100 dB (1 kHz)

Généralités
Bornes sous tension / hors circuit ON / OFF de la télécommande (REMOTE ON / OFF): Sortie × 2
Alimentation: CA 220 V/50 Hz (pour l'Europe),
 CA 240 V/50 Hz (pour le Royaume-Uni et l'Australie)
Consommation: 28 W
Dimensions: 434 (L) × 136 (H) × 386 (P) mm
Poids: 8,5 kg

Télécommande RC-110 (télécommande à 40 touches)
Système de télécommande: Systeme à pulsation Infrarouge
Alimentation: 3 piles sèches de type R03 (A.A.) de 3 V CC
Dimensions extérieures: 60 (L) × 180 (H) × 17,5 (P) mm
Poids: 110 g (y compris les piles)

* Les specifications sont sujettes de modifications sans préavis.

[ITALIANO]

SPECIFICAZIONI

Amplificatore equalizzatore (PHONO IN ~ REC OUT)

Sensibilità di ingresso / impedenza:	PHONO MC: 0,2 mV/100 ohm PHONO MM: 2,5 mV/47 kohm
Livello massimo di ingresso:	PHONO MC: 13 mV/1 kHz PHONO MM: 160 mV/1 kHz
Uscita massima / uscita nominale:	10 V/150 mV
Distorsione armonica totale:	Meno di 0,001% (ad 1 kHz, nominale di uscita)
Deviazione RIAA:	PHONO MC: 20 Hz ~ 100 kHz $\pm 0,2$ dB PHONO MM: 20 Hz ~ 20 kHz $\pm 0,2$ dB
Rapporto S/R (pesato A):	PHONO MC: 79 dB (all'ingresso di 0,5 mV) PHONO MM: 96 dB (all'ingresso di 5 mV)
Guadagno:	PHONO MC: 57,5 dB/1 kHz PHONO MM: 35,6 dB/1 kHz
Filtro subsonico:	16 Hz, 12 dB/oct.

Amplificatore di alto livello (AUX IN ~ PRE OUT-1)

Terminali di ingresso:	CD, TUNER, AUX-1, AUX-2
Terminale di ingresso / uscita della cassetta:	TAPE-1, TAPE-2
Sensibilità di ingresso / impedenza:	1 V/10 kohm
SOURCE DIRECT ON:	150 mV/33 kohm
SOURCE DIRECT OFF:	PRE OUT-1: 1 V/10 ohm
Uscita nominale / impedenza:	PRE OUT-2 (uscita bilanciata): 2 V/600 ohm
Distorsione armonica totale:	0,002% (20 Hz ~ 20 kHz, uscita 1 V)
Rapporto S/R (pesato A):	105 dB
Risposta di frequenza:	1 Hz ~ 300 kHz $\pm 0,2$ dB, -3 dB
Controllo della tonalità:	ACUTI BASSI
Loudness variabile:	100 Hz ± 8 dB
Interruttore di uscita (OUTPUT):	100 Hz ± 8 dB 10 kHz + 4 dB (al livello massimo)
Interruttore attenuatore (MUTING):	PRE OUT-1, 2/Interruttore di selezione delle cuffie PRE OUT-1, 2/Interruttore delle cuffie (attenuatore)

Sezione digitale (DIGITAL IN ~ REC OUT)

Formato del segnale digitale:	Formato di interfaccia digitale audio (16 bit lineare)
Frequenze di campione:	32 kHz, 44,1 kHz, 48 kHz
Terminali di ingresso:	DIGITAL-1: 1 linea
(Ottico):	DIGITAL-2, 3: 0,5 Vp-p/75 ohm
(Coassiale):	DAT DIGITAL IN 0,5 Vp-p/75 ohm
Terminali DAT (Coassiali):	DAT DIGITAL OUT 0,5 Vp-p/75 ohm
Sistema di conversione D/A:	20 BIT LAMBDA - Super Linear Converter
Filtro:	Filtro digitale di ottuplo sovracampionamento
Uscita nominale:	REC OUT: 2 V (a 0 dB, posizione DAC OUT)
Distorsione armonica totale:	0,0025% (1 kHz, 0 dB)
Risposta di frequenza:	2 Hz ~ 20 kHz, $\pm 0,3$ dB
Rapporto S/R (pesato A):	108 dB
Gamma dinamica:	100 dB
Separazione dei canali:	100 dB (1 kHz)

Generale

Terminali di accensione / spegnimento (ON/OFF) a telecomando (REMOTE ON/OFF):	2 uscite
Alimentazione:	CA 220V/50 Hz (per l'Europa) CA 240 V/50 Hz (per il Regno Unito e per l'Australia)
Consumo:	28 W
Dimensioni:	434 (L) \times 136 (A) \times 386 (P) mm
Peso:	8,5 kg

Telecomando RC-110

(telemando dal funzionamento con 40 tasti)

Sistema di telecomando:	Sistema agli impulsi infrarossi
Alimentazione:	2 batterie a secco di 3 V CC della misura R03 (AAA)
Dimensioni esterne:	60 (L) \times 180 (A) \times 17,5 (P) mm
Peso:	110 g (le batterie incluse)

* Le specificazioni sono soggette a cambiamenti senza preavviso

[ESPAÑOL]

ESPECIFICACIONES

Ecuador Amplificador (PHONO IN ~ REC OUT)

Impedancia / Sensibilidad de Entrada:	PHONO MC: 0,2 mV/100 Ohmios PHONO MM: 2,5 mV/47 Kohmios
Nivel Máximo de Salida:	PHONO MC: 13 mV/1 kHz PHONO MM: 160 mV/1 kHz
Salida Máxima / Salida Nominal:	10 V/150 mV
Distorsión Armónica Total:	Menos de 0,001% (1kHz, nominal output)
Desviación RIAA:	PHONO MC: 20 Hz ~ 100kHz $\pm 0,3$ dB PHONO MM: 20 Hz ~ 20 kHz $\pm 0,2$ dB
Señal/Ruido: (A-compensado)	PHONO MC: 79dB (a 0,5 mV de entrada) PHONO MM: 96 dB (a 5 mV de entrada)
Gainancia:	PHONO MC: 57,5 dB/1kHz PHONO MM: 35,6 dB/1 kHz
Filtro Subsonico de Phono:	16 Hz, 12 dB/oct.

Amplificador de Alto Nivel (AUX IN ~ PRE OUT-1)

Terminales de Entrada:	CD, TURNER, AUX-1, AUX-2
Terminal de Entrada / Salida de Tape:	TAPE-1, TAPE-2
Impedancia / Sensibilidad de Entrada:	1 V/10 Kohmios
SOURCE DIRECT ON:	150 mV/33 kohmios
SOURCE DIRECT OFF:	PRE OUT-1: 1 V/10 Ohmios
Impedancia / Salida Nominal:	PRE OUT-2: Fuera de balance: 2 V/600 Ohmios
Distorsión Armónica Total:	0,002% (20Hz ~ 20kHz, 1 V de salida)
Señal/Ruido (A-weighted):	105 dB
Respuesta de Frecuencia:	1Hz ~ 300kHz $\pm 0,2$ dB, -3dB
Control de Tono:	AGUDOS GRAVES
Variable de Sonoridad:	100 Hz ± 8 dB, 10 kHz + 4 dB (como máximo)
Interruptor de Salida (OUTPUT):	PRE OUT-1, 2/Interruptor de selección de auriculares
Interruptor de Silenciamiento (MUTING):	PRE OUT-1, 2/Interruptor (- ∞ Silenciamiento) del auricular

Sección Digital (ENTRADA DIGITAL ~ SALIDA DE GRABACIÓN)

Formato de Señal Digital:	Formato adaptador del audio digital (16 bits lineal)
Muestreo de frecuencias:	32 kHz, 44,1 kHz, 48 kHz
Terminales de Entrada:	DIGITAL-1: 1 Línea
(Optical):	DIGITAL-2, 3: 0,5 Vp-p/75 Ohmios
(Coaxial):	DAT DIGITAL IN 0,5 Vp-p/75 Ohmios
Terminales de DAT (Coaxial):	DAT DIGITAL OUT 0,5 Vp-p/75 Ohmios
Sistema de Conversión D/A:	20 BIT LAMBDA - Super Linear Converter
Filtro:	Filtro digital 8-veces sobre expuesto
Salida Nominal:	REC-OUT: 2 V (a 0 dB, en la posición de DAC-OUT)
Distorsión Armónica Total:	0,0025% (1kHz, 0 dB)
Respuesta de Frecuencia:	2Hz ~ 20kHz, $\pm 0,3$ dB
Ruido / Señal (A-weighted):	108 dB
Intervalo Dinámico:	100 dB
Separación de canal:	100dB (1kHz)

Caracteres Generales

Terminales de Control Remoto de Encendido / apagado (ON/OFF) (REMOTE ON/OFF):	2 \times salida
Suministro de Alimentación:	CA 220 V/50 Hz (para Europa) CA 240 V/50 Hz (para el Reino Unido y Australia)
Consumo de Encendido:	28 W
Dimensiones:	434(W) \times 136(H) \times 386(D) mm
Peso:	8,5 Kg

Unidad de Control Remoto RC-110

(Unidad de Control Remoto con Sistema de 40 operaciones de mando)

Sistema de Control Remoto:	Sistema de envío con infrarrojos
Suministro de Alimentación:	3 baterías dry cell V DC tamaño dos R03 (AAA)
Dimensiones externas:	60(W) \times 180(H) \times 17,5(D) mm
Peso:	110 g. (incluida las baterías)

* Las especificaciones se pueden cambiar sin previo aviso.

[SUENSKA]

SPECIFIKATIONER

Tonkorrektionsförstärkare (PHONO IN ~ REC OUT)

Inkänslighet / impedans:	PHONO MC: 0,2 mV/100 ohm PHONO MM: 2,5 mV/47 kohm
Max. innvä:	PHONO MC: 13 mV/1 kHz PHONO MM: 160 mV/1 kHz
Max. utnivå / märknivå:	10 V/150 mV
Total harmonisk distorsion:	Mindre än 0,001% (1 kHz, märkeffekt utnivå)
RIAA-kurvavvikelse:	PHONO MC: 20 Hz ~ 100 kHz $\pm 0,3$ dB PHONO MM: 20 Hz ~ 20 kHz $\pm 0,2$ dB
Signalbrusförhållande (A-vägt):	PHONO MC: 79 dB (vid 0,5 mV innvä) PHONO MM: 96 dB (vid 5 mV innvä)
Förstärkning:	PHONO MC: 57,5 dB/1 kHz PHONO MM: 35,6 dB/1 kHz
PHONO subsoniskt filter:	16 Hz, 12 dB/oktav

Högnivåförstärkare (AUX IN ~ PRE OUT-1)

Ingångar:	CD, TUNER, AUX-1, AUX-2
Bandin- / utgångar:	TAPE-1, TAPE-2
Inkänslighet / impedans:	1 V/10 kohm
SOURCE DIRECT ON:	150 mV/33 kohm
SOURCE DIRECT OFF:	PRE OUT-1: 1 V/10 ohm
Märknivå / impedans:	PRE OUT-2 (symmetrisk utgång): 2 V/600 ohm
Total harmonisk distorsion:	0,002% (20 Hz ~ 20 kHz, 1 V utnivå)
Signalbrusförhållande (A-vägt):	105 dB
Frekvensgång:	1 Hz ~ 300 kHz, $\pm 0,2$ dB, -3 dB
Tonkontroll:	TREBLE BASS
Variabel loudness:	100 Hz ± 8 dB, 100 Hz ± 8 dB, 100 Hz + 4 dB (maximum)
OUTPUT-väljare (OUTPUT):	PRE OUT-1, 2/Hörlursomkopplare
Dämpningsomkopplare (MUTING):	PRE OUT-1, 2/Hörlursomkopplare (- ∞ dämpning)

Digitala delen (DIGITAL IN ~ REC OUT)

Digitalt signalförhållande:	Digital Audio Interface (16 bitar linjär)
Samplingsfrekvenser:	32 kHz, 44,1 kHz, 48 kHz
Ingångar:	DIGITAL-1, 1 anslutning
(Optisk)	DIGITAL-2, 3: 0,5 Vt-t/75 ohm
(Koaxial)	DAT DIGITAL IN 0,5 Vt-t/75 ohm
DAT-anslutningar: (koaxiala)	DAT DIGITAL OUT 0,5 Vt-t/75 ohm
D/A-omvandling:	20 BIT LAMBDA - Super Linear Converter
Filtre:	Digitalt filter med 8 gånger översampling
Märknivå:	REC OUT: 2 V (vid 0 dB, DAC OUT-laget)
Total harmonisk distorsion:	0,0025% (1 kHz, 0 dB)
Frekvensgång:	2 Hz ~ 20 kHz $\pm 0,3$ dB
Signalbrusförhållande: (A-vägt)	108 dB
Dynamiskt omfång:	100 dB
Kanalseparation:	100 dB (1 kHz)

Allmänt

Fjärrkontrollanslutningar (REMOTE ON/OFF):	2 utgångar
Strömförsörjning:	220V växelström, 50 Hz (för Europa) 240 V växelström, 50 Hz (för Storbritannien och Australien)
Strömförbrukning:	28 W
Yttermått:	434 (B) \times 136 (H) \times 386 (D) mm
Vikt:	8,5 kg

Fjärrkontroll RC-110

(40-tangenters fjärrkontroll)

Fjärrkontrollsystem:	Infraröda pulskoder
Strömförsörjning:	3 V likström, två R03 (AAA) torrcellbatterier
Yttermått:	60 (B) \times 180 (H) \times 17,5 (D) mm
Vikt:	110 g (inkl. batterier)

* Rätt till ändring av specifikationer förbehålles utan varsel.

FRONT PANEL / FRONTPLATTE / PANNEAU AVANT / PANNELLO ANTERIORE / PANEL FRONTAL / FRAMPANEL

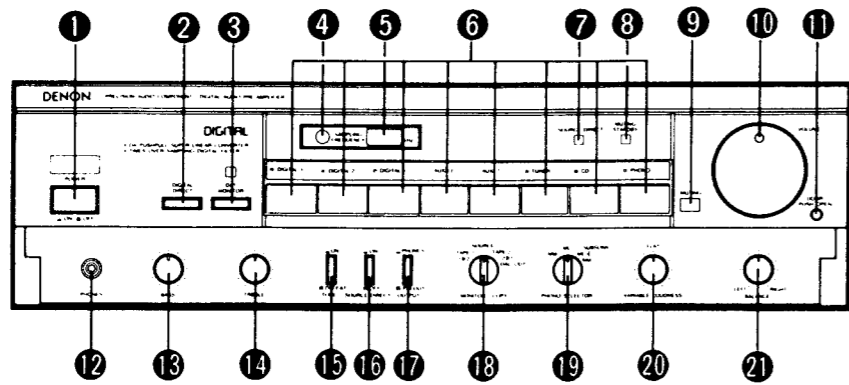

CONNECTIONS / ANSCHLÜSSE / CONNEXION / COLLEGAMENTI / CONEXIONES / ANSLUTNINGAR

Power amp with balanced input terminals (CANNON plugs) / Endverstärker mit symmetrischen Eingangsbuchsen (CANNON-Steckverbindung) / Amplificateur de puissance à bornes d'entrée équilibrée (fiches CANNON) / Amplificatore di potenza con terminali d'ingresso bilanciati (spina CANNON) / Amplificador de poder con terminales balanceadas de salida (clavijas CANNON) / Effektförstärkare med balanserade ingångar (CANNON-pluggar)

Record Player (with MC or MM cartridge) / Schallplattenspieler (mit MC- oder MM-Tonabnehmer) / Table de lecture (avec cellule MC ou MM) / Giradischi (con una cartuccia MC o MM) / Giradiscos (con cápsula MM o MC) / Skivspelare (med MC- eller MM-pickup)

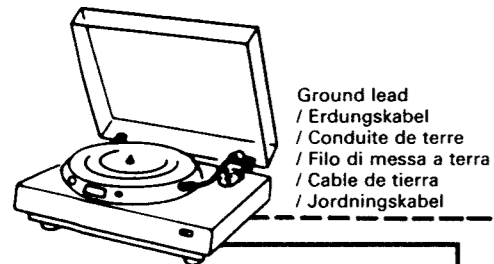

Ground lead / Erdungskabel / Conduite de terre / Filo di messa a terra / Cable de tierra / Jordningskabel

CD Player / CD-Spieler / Lecteur de disque compact / Lettore di Compact Disc / Reproductor de discos compactos / CD-spelare

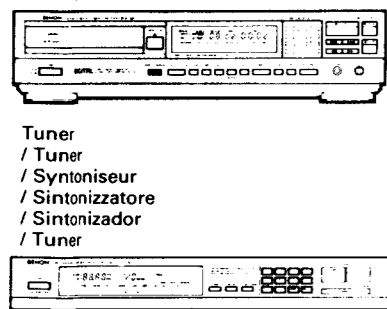

Tuner / Tuner / Syntoniseur / Sintonizzatore / Sintonizador / Tuner

VCR or Video Disc Player (Sound only) / Video-Kassettenrekorder oder Video-Plattenspieler (nur Ton) / Magnéscope ou lecteur de disque vidéo (son uniquement) / Videoregistratore oppure lettore di Video Disc (solo suono) / Grabador de videocassettes o reproductor de videodiscos (Sonido solamente) / Videobåndspilare eller video disc-spelare (endast ljud)

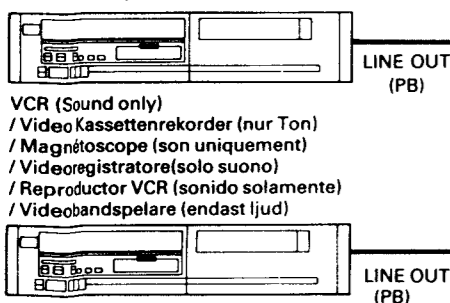

VCR (Sound only) / Video-Kassettenrekorder (nur Ton) / Magnéscope (son uniquement) / Videoregistratore (solo suono) / Reproductor VCR (sonido solamente) / Videobåndspilare (endast ljud)

Tape Deck 1 / Tonbandgerät 1 / Magnétocassette 1 / Piastra a cassette 1 / Magnetófono de cassettes 1 / Bandsplare 1

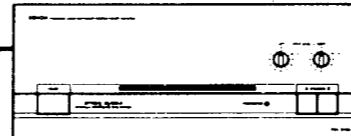
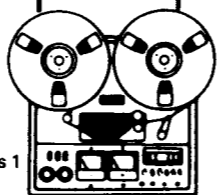

Power Amplifier / Leistungsverstärker / Amplificateur de puissance / Amplificatore di potenza / Amplificador de potencia / Effektförstärkare

TAPE / REMOTE CONTROL (Tape Deck Remote Control Jack) Remote control of the connected DENON cassette deck is enabled by connecting the tape deck remote control lead to this jack. The jack is a mini-jack designed for connection of a 3.5 mm plug. NOTE: Do not connect headphones or a microphone to this jack. Use this jack only to connect a Denon cassette deck with a remote control jack (wired).

TAPE / REMOTE CONTROL (Fernbedienungsbuchse des Cassettendecks) Die Fernbedienung des angeschlossenen DENON-Cassettendecks ist möglich, wenn Sie das Fernbedienungskabel des Cassettendecks an diese Buchse anschließen. Bei dieser Buchse handelt es sich um eine Mini-buchse. Diese ist für den Anschluß eines 3,5 mm Steckers vorgesehen. HINWEIS: Schließen Sie keine Kopfhörer und kein Mikrofon an diese Buchse an. Benutzen Sie die Buchse lediglich für den Anschluß eines Denon-Cassettendecks mit einer Fernbedienungsbuchse (verdrahtet).

TAPE / REMOTE CONTROL (Jack de télécommande de magnétocassette) La télécommande du magnétocassette DENON raccordé est possible en branchant le câble de télécommande du magnétocassette à ce jack. C'est un mini-jack conçu pour le branchement d'une fiche de 3,5 mm. REMARQUE: Ne pas brancher un casque ou un microphone à ce jack. N'utiliser ce jack que pour raccorder un magnétocassette Denon équipé d'un jack de télécommande (câblé).

TAPE / REMOTE CONTROL (presa di controllo a telecomando della piastra a cassette) Potete controllare la piastra a cassette della DENON a telecomando, se collegate il filo di controllo a telecomando della piastra a cassette con questa presa. La presa è una presa mini disegnata per il collegamento di una spina di 3,5 mm. NOTA: Non collegate le cuffie o un microfono con questa presa. Usatela soltanto per il collegamento di una piastra a cassette DENON con una presa di controllo a telecomando (a fili).

Toma para control remoto de magnetofono (TAPE / REMOTE CONTROL) La operación a control remoto del magnetofono de cassettes DENON conectado a la unidad, será posible al conectar el cable de control remoto del magnetofono a esta toma. La toma es una minitoma diseñada para la conexión de un clavija de 3,5 mm. NOTA: No conecte un par de auriculares o un micrófono a esta toma. Use esta toma sólo para conectar una magnetofono de cassettes Denon provisto de una toma de control remoto.

Fjärrkontrollanslutning för kassettdäck (TAPE / REMOTE CONTROL) Det är möjligt att fjärrstyra ett anslutet DENON-kassettdäck genom att ansluta kassettdäckets fjärrkontrollkabel till denna ingång. Kontakten är en minikontakt avsedd för anslutning av en kontakt med diameter 3,5 mm. OBSERVERA: Anslut inte hörlurar eller mikrofon till anslutning ingång. Använd endast uttag för anslutning av ett DENON-kassettdäck med uttag för fjärrkontroll.

REMOTE ON-OFF Terminals These terminals are used for remote control of the power amplifier and/or active speaker system. A low-voltage DC current is emitted from the terminals to turn on the power of an active speaker system and/or DENON power amplifier (models POA-4400A, POA-6600A, etc.). Two channels will emit independent signals for left and right channels.

Fernbedienungsbuchsen Ein/Aus (REMOTE ON-OFF) Diese Buchsen werden für die Fernbedienung des Leistungsverstärkers und/oder aktiven Lautsprechersystems benutzt. Von den Buchsen wird ein Niederspannung-Gleichstromfluß ausgesendet, um ein aktives Lautsprecher-system und/oder DENON Leistungsverstärker einzuschalten. (Modelle POA-4400A, POA-6600A, usw.). Zwei Kanäle werden unabhängige Signale für die linken und rechten Kanäle aussenden.

Bornes de mise sous/hors tension à distance (REMOTE ON-OFF) Ces bornes sont utilisées pour la télécommande sur l'amplificateur de puissance et/ou sur le système d'enceinte utilisé. Un courant CC de faible tension est émis à partir des bornes pour mettre sous tension l'alimentation d'un système d'enceintes en fonctionnement et/ou l'amplificateur de puissance DENON (modèles POA-4400A, POA-6600A, etc.). Deux canaux émettront des signaux indépendants pour les canaux de gauche et de droite.

Fjärrkontrollanslutningar (REMOTE ON-OFF) Dessa anslutningar används för fjärrkontroll av effektförstärkaren och/eller ett aktivt högtalarsystem. Från anslutningarna sänds en likströmssignal med låg spänning som kan sätta på det aktiva högtalarsystemet och/eller en DENON effektförstärkare (modell POA-4400A, POA-6600A, m.fl.). De två anslutningarna skickar ut var sin signal två olika kanaler.

Terminali di accensione/spengimento del controllo a telecomando (REMOTE ON-OFF) Questi terminali vengono usati per un controllo a telecomando dell'amplificatore di potenza e/o del sistema di altoparlanti. La corrente di basso voltaggio CC viene emessa dai terminali per accendere un sistema attivo di altoparlanti e/o l'amplificatore di potenza della DENON (modelli POA-4400A, POA-6600A, ecc.). Due canali emetteranno dei segnali indipendenti per i canali sinistro e destro.

Terminales de activación/desactivación a control remoto (REMOTE ON-OFF) Estos terminales son usados para la operación a control remoto del amplificador, o para activar el sistema de altavoces. Estos terminales emiten corriente CC de bajo voltaje para activar la unidad o el sistema de altavoces/o el amplificador de potencia DENON (modelos POA-4400A, POA-6600, etc.). Los dos canales emitirán señales independientes para los canales derecho e izquierdo.

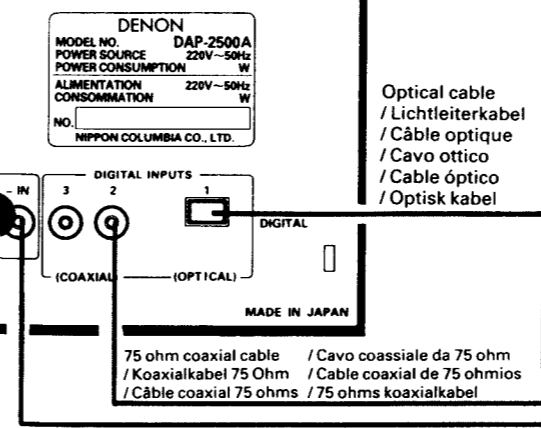

Optical cable / Lichtleiterkabel / Câble optique / Cable óptico / Optisk kabel

75 ohm coaxial cable / Cavo coassiale da 75 ohm / Koaxialkabel 75 Ohm / Cable coaxial de 75 ohms / Câble coaxial 75 ohms / 75 ohms koaxialkabel

AC wall outlet / Netzsteckdose / Sortie secteur murale / Presa murale CA / Tomacorriente de CA de pared / El-uttag i väggen

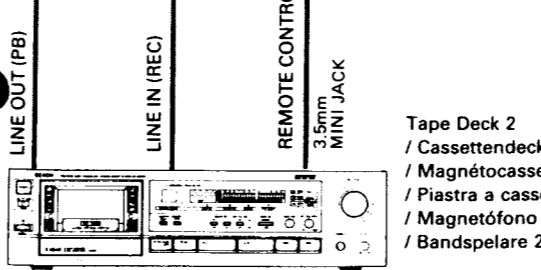

CD Player / CD-Spieler / Lecteur de disque compact / Lettore di Compact Disc / Reproductor de discos compactos / CD-spelare

Component with optical and coaxial digital output terminals / Komponente mit optischen und koaxialen digitalen Ausgangsbuchsen / Composant muni de bornes de sortie numériques optiques et coaxiales / Componente con dei terminali di uscita ottica e di uscita coassiale digitale / Componente con terminales de salida digital óptica y coaxial. / Komponent med optiska och koaxiala utgångar för digitalsignaler

DAT / Digitales Audio Kassettdeck / DAT (magnetophone audio numérique) / DAT (piastra a cassette audio digitale) / DAT / DAT-däck

75 ohm coaxial cable (pin cord) / Koaxialkabel 75 Ohm (mit Stiftkontakten) / Câble coaxial 75 ohms (cordon à brèche) / Cavo coassiale da 75 ohm / Cable coaxial de 75 ohms (conexión de clavija) / 75 ohms koaxialkabel (med stiftkontakt)

NAMES AND FUNCTIONS OF PARTS

1 POWER switch and LED indicator

(Power supply switch and LED indicator)

When this switch is pressed ON, the power is turned on, and the LED indicator lights. A few seconds will elapse after the power is turned on before operation can begin. This is due to the muting circuitry that is built in to eliminate noise when the power is turned on.

2 DIGITAL DIRECT (Digital direct switch)

Use this switch when playing back components connected to one of the DIGITAL INPUT terminals (DIGITAL-1, 2, 3 DAT IN). When the DIGITAL DIRECT switch is set to "ON", the SAMPLING FREQUENCY indicator 4 will light up.

3 DAT MONITOR (DAT monitor switch)

This switch is used when playing back a component connected to the DAT input terminal when the DIGITAL DIRECT switch is "ON".

The signals of DIGITAL INPUT terminals (DIGITAL-1, 2, 3) cannot be played back when this switch is "ON". The DAT MONITOR indicator will light up when this switch is "ON".

4 REMOTE SENSOR

This is where the signals from the included remote control unit are received.

Refer to Page 11 for operation of the remote control unit.

5 SAMPLING FREQUENCY (Sampling frequency indicator)

This function detects and displays the sampling frequency of the digital signal input to the digital input terminals (DIGITAL-1, 2, 3 or DAT).

- 32 kHz: DAT 32 kHz mode, etc.
- 44 kHz: CD, DAT (When pre-recorded tapes are played back)
- 48 kHz: DAT 48 kHz mode, etc.
- -- kHz: When the DIGITAL DIRECT switch is "ON" and a digital input is not connected, or when the input signal's sampling frequency is not synchronized.

* The indicator closest to the input sampling frequency will light up.

6 INPUT SELECTOR (Input select switches)

This switch is used to select the input signal.

- PHONO: Used to select the output from a record player that is connected to the PHONO terminals. The PHONO selector 19 is used to switch the sensitivity to suit the cartridge type.
- CD: Used to listen to a compact disc player or other component that is connected to the CD terminals.

• TUNER: Used to listen to a component such as an FM/AM tuner, a TV tuner, or an 8-track player that is connected to the TUNER terminals.

- AUX-1 } : Used to play a component such as a
- AUX-2 } : Hi-Fi video component that is connected to the AUX-1 or AUX-2 terminals.

Set the DIGITAL DIRECT switch 2 to "OFF" (the Frequency display LED will not be lit) in the case of selecting PHONO ~ AUX-2.

• DIGITAL-1: Used when playing back the optical output of a digital audio component such as a CD player or DAT equipped with an optical output terminal which is connected to the DIGITAL-1 terminal.

• DIGITAL-2, 3: Used when playing back a coaxial type digital output of a digital audio component such as a CD player or DAT equipped with a digital output terminal which is connected to the DIGITAL-2 or 3 terminal.

Set the DIGITAL DIRECT switch 2 to "ON" (the Frequency display LED will light up) when selecting DIGITAL-1 ~ 3.

Digital components have different sampling frequencies depending on the component. This amplifier will automatically switch for appropriate operation, so input can be made without any changes.

Normally one indicator lights up for each of the DIGITAL side (DIGITAL-1 ~ 3) and the ANALOG side (PHONO ~ AUX-2).

* The DAP-2500A uses a high-performance electronic switch for input selection. When the power switch 1 is turned ON, the INPUT SELECTOR switch is automatically set to the TUNER position.

* When power is turned on using the remote control unit, the INPUT SELECTOR is set to the position selected just before power was turned off (the DAT MONITOR position, however, cannot be selected).

7 SOURCE DIRECT (Source direct indicator)

Lights up when the SOURCE DIRECT switch 18 is turned on.

8 MUTING/STANDBY (Muting/Standby indicator)

The muting circuit operates and the indicator flashes in the following circumstances:

- When the power is turned on (for approx. 8 seconds)
- When the input selector is switched (for approx. 1 second)
- When the digital direct switch is on and no digital signals are being input or the sampling frequency of the input signals is not synchronized.

If the power is turned off with the remote control unit, this indicator lights to indicate that the unit is in the standby mode, and that the power can be turned on from the remote control unit.

The muting operation will be performed when the DIGITAL DIRECT switch is set to "ON" and a digital input is not input to the DIGITAL INPUT terminals. Muting also operates when, at digital input, synchronization of the sampling frequency cannot be taken.

9 MUTING (Muting switch)

Pressing this switch will activate the muting condition and a signal will not be sent to the output side.

Muting indication LED ⑧ will flash on and off during the muting operation.

Pressing this switch again will cancel the muting.

10 VOLUME (Volume control)

This knob is used to adjust the volume of the entire range.

Turn the knob to the right to raise the volume and to the left to lower it.

The volume can be turned up or down with the remote control unit.

The volume LED flashes when the volume is adjusted with the remote control unit.

11 DOOR (Door-open button)

Press this button to open the door.

This is the only way to open the door. Be sure to push this button. ⑫ ~ ⑭ are the functions provided inside the door.

12 PHONES (Headphones jack)

This jack is used to plug in the headphones.

Set the OUTPUT switch to the PHONES (—) position when using headphones.

13 BASS (Bass control)

This is used to regulate the degree of bass in the sound. When the knob is set to the center position, the frequency characteristic curve is flattened in the range below 1000 Hz. The bass increases as the knob is moved off center to the right, and decreases as it is moved to the left.

14 TREBLE (Treble control)

This is used to regulate the degree of treble in the sound.

When the knob is set to the center position, the frequency characteristic curve is flattened in the range above 1000 Hz. The treble increases as the knob is moved off center to the right, and decreases as it is moved to the left.

15 TONE (Tone switch)

The tone control function is operated by using the TONE switch.

When the switch is set to DEFEAT (■), the transmission characteristic curve is flattened, and the positions of the BASS and TREBLE knobs have no effect.

When the switch is pressed ON (—), tone control is enabled.

(The level of BASS and TREBLE can be varied.)

16 SOURCE DIRECT (Source direct switch)

The controls (BALANCE, VARIABLE LOUDNESS, and TONE) can be used when this switch is in the OFF (■) position.

When set to the ON (—) position, the above controls and the flat amplifier are by-passed and the signals are input directly to the volume control circuit, providing high quality sound. The input sensitivity changes when this switch is turned on and off, so set the volume accordingly.

17 OUTPUT (Output selector switch)

Use this switch to select PREOUT or PHONES.

■ PREOUT: In this position, signals are output from the PREOUT jacks. No signals are output from the headphones jack.

— PHONES: Set to this position when using headphones. No signals are output from the PREOUT jacks.

18 MONITOR/COPY (Tape monitor/copy switch)

Set this switch to "SOURCE" for tape deck recording. The signal from the program source selected by the FUNCTION switch will then be output from the REC terminals for TAPE-1 and TAPE-2.

When using two tape decks to make a recording of one tape onto another, set the switch to either TAPE-1 / 1▶2 or TAPE-2 / 2▶1 copy.

- The TAPE-1 / 1▶2 position is used to play the tape deck that is connected to the tape-1 terminals.
- The TAPE-2 / 2▶1 position is used to play the tape deck that is connected to the tape-2 terminals.
- In the DAC OUT position, a program source in which the DIGITAL 1-2 or DAT digital input has undergone D/A conversion is output from the TAPE-1 and TAPE-2 REC terminals.

19 PHONO SELECTOR (Cartridge Selection/Subsonic Filter Switch)

Set this switch to correspond to the type of cartridge (MC or MM) used on your record player. The switch also features positions for activating the subsonic filter, effectively suppressing ultra-low frequencies generated by motor vibrations from the record player and warped records. Such ultra-low (subsonic) frequencies could easily damage your speakers.

- **MM:** Use this position when an MM cartridge is used on the player connected to the PHONO input jacks.
- **MC:** Use this position when an MC cartridge is used on the player connected to the PHONO input jacks.
- **SUBSONIC-MC:** Use this position to eliminate subsonic frequencies when an MC cartridge is used.
- **SUBSONIC-MM:** Used this position to eliminate subsonic frequencies when an MM cartridge is used.

20 VARIABLE LOUDNESS (Loudness Control)

At low volumes, the human ear is less sensitive to low and high frequencies. Use this control to compensate for this deficiency when listening at low volume levels. Turn this control counter-clockwise until a natural balance of bass and treble sound has been restored.

21 BALANCE (Balance control)

The balance between left and right channels is adjusted by using this knob.

When it is set to the center position, the amplifier gain is the same for the left and the right.

If there seems to be a difference in the left and right channel output voltages for the cartridge, try moving the knob to the left and the right to adjust it. If the volume on the right side is too low, turn the knob to the right. If the volume on the left side is too low, turn the knob to the left.

NOTES ON INSTALLING THE PRE-AMPLIFIER

To prevent harmful influence caused by heat build-up and electric radiation from the power amplifier or externally induced humming, preferably install the pre-amplifier next to the power amplifier. If such an installation is not possible, be sure there is a free space of 15 cm or more between the pre-amplifier and power amplifier or other system component.

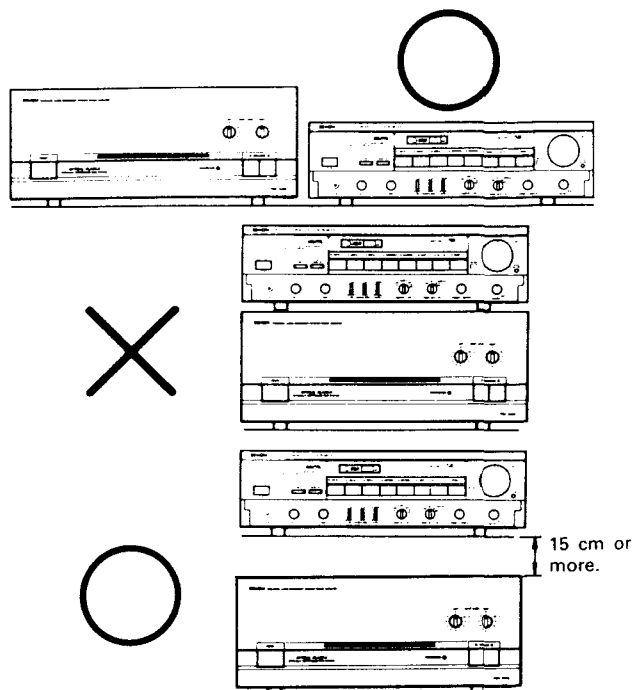

NOTES ON CONNECTION

- Do not plug the power cord into the AC wall outlet until all connections have been completed.
- Make sure channels are correctly connected. Connect Left channels to Left channels and Right channels to Right channels. Follow the color markings of plugs and terminals to make sure mistakes are not made.
- Connect all pin-plugs securely, pushing them completely into the jacks. Incomplete connections will cause noise generation.
- Binding the connection cables to power cords, or running such cables close to power supply transformers will cause humming or noise, and should thus be avoided.
- The PHONO input jacks are extremely sensitive. Avoid using the power amplifier if no connection has been made to these jacks, as this otherwise may cause low humming from the speakers when the power-amplifier is on.

PLAYBACK USING THE REMOTE CONTROL

The accessory RC-110 remote control unit is used to control the PREAMPLIFIER from a distance.

(1) Inserting the dry cell batteries

- 1 Remove the rear cover on the remote control unit.

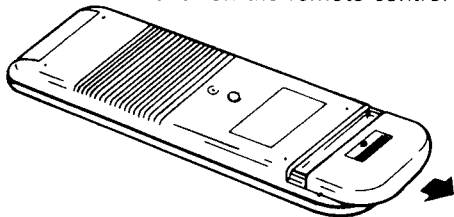

- 2 Insert two size R03 (AAA) dry cell batteries as shown in the diagram on the battery supply unit.

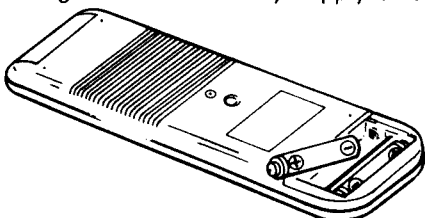

- 3 Replace the rear cover.

Notes on Use of the Batteries

- The remote control unit uses size R03 (AAA) dry cell batteries.
- The batteries will need to be replaced approximately once a year. This will depend upon how often the remote control is used.
- If, in less than a year from the time new batteries were inserted, the remote control fails to operate the preamplifier from a near-by position, it is time to replace the batteries.
- Insert the batteries properly, following the diagram on the remote control battery supply unit, and making sure to align the plus and minus sides of each battery.
- Batteries are prone to damage and leakage. Therefore:
 - Do not combine new batteries with used ones.
 - Do not combine different types of batteries.
 - Do not jumper the opposite poles of the batteries, expose them to heat or break them open, or put them into open fire.
- When the remote control is not to be used for a long period of time, remove the batteries from the unit.
- If the batteries have leaked, remove any battery fluid from the inside of the battery supply unit by wiping it out thoroughly, and insert new batteries.

CAUTION

It may be difficult to operate the remote unit with a fluorescent light near the set, in particular near the remote control sensor, but this is not a malfunction. Should this happen, move the fluorescent light away from the set.

(2) Directions for use

- Operate the remote control unit while it is pointed toward the photosensitive window, as shown in the diagram below.

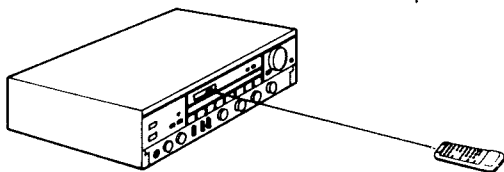

- The remote control unit can be used at distances up to about 7 meters in a straight line away from the player. This distance will decrease if there are obstructions in the way of the transmission or if the light shaft is not directed straight at the player.

Note on Operation

- Do not press the operating buttons on the pre amplifier and the remote control unit at the same time. This will cause misoperation.
- Operation of the remote control will become less effective if the infrared photosensitive window is exposed to strong light or if there are obstructions between the remote control unit and the photosensitive window.
- When the remote control productive TV or VCR is used with this pre amplifier, do not press the operating buttons on the remote control unit of both at the same time. This will cause misoperation.

POWER ON-OFF KEY

INPUT SELECTOR KEY

TUNER

CD

VOLUME KEY

MUTING KEY

DAT

DECK

▲ UP	CHANNEL UP KEY
▼ DOWN	CHANNEL DOWN KEY

▶ PLAY	PLAY KEY
■ STOP	STOP KEY
⏮	Automatic Search Reverse KEY
⏭	Automatic Search Forward KEY
⏪	Manual Search Reverse KEY
⏩	Manual Search Forward KEY
⏸ PAUSE	PAUSE KEY
REPEAT	REPEAT KEY

▶ PLAY	PLAY KEY
■ STOP	STOP KEY
⏸ PAUSE	PAUSE KEY
● REC	RECORD KEY
⏮	Automatic Search Reverse KEY
⏭	Automatic Search Forward KEY
⏪	Manual Search Reverse KEY
⏩	Manual Search Forward KEY
▶ PLAY	PLAY KEY
■ STOP	STOP KEY
⏸ PAUSE	PAUSE KEY
● REC	RECORD KEY
◀ PLAY	REVERSE PLAY KEY
SELECT A/B	TAPE SELECT OR KEY
⏮	REVERSE KEY
⏭	FORWARD KEY

DENON SYSTEM REMOTE CONTROL UNIT RC-110

CONNECTION

○ **DIGITAL-1 CONNECTION**

Remove the optical connector protection cap and connect the optical cable. Be sure to attach the protective cap when the optical cable is disconnected.

○ **DIGITAL-2, 3 DAT CONNECTION**

Be sure to use 75-ohm coaxial cable pin cords for the connection cord.

OPERATION



○ **Proper care**

Avoid installing the amplifier in a sealed, airtight cabinet.

1. Check the connections.

- Refer to the connection diagrams on pages (6) and (7), and make sure that no mistakes in the connection have been made.
- Check to make sure that left (L) and right (R) sides of the pin cords are plugged in properly.
- Check to make sure that all cords are firmly connected.

2. Check the setting of each knob and switch.

- Turn the volume knob (VOLUME) all the way to the left to the "minimum" position.
- Set the balance knob (BALANCE) to its center position.
- Set the tone knobs (BASS, TREBLE) to their center positions.
- Set the variable loudness knobs (VARIABLE LOUDNESS) to its "FLAT" position.
- Set the SOURCE DIRECT switch to its "OFF" position ().
- Set the monitor/copy knob (MONITOR/COPY) to the "SOURCE" position.
- Set the OUTPUT switch to its "PRE OUT" position ().
- Set the TONE switch to its "ON" position ().
- Set the muting switch (MUTING) to "OFF".

After checking all of the above, press the power switch (POWER) to turn the power supply ON. The power indicator will light, and a few seconds later, the amplifier will be ready for operation.

NOTE:

- While a DIGITAL signal is not being input and the DIGITAL DIRECT switch ② is set to the "ON" position, the muting condition will continue. To cancel this condition, input a DIGITAL signal or set the DIGITAL DIRECT switch to the "OFF" position.
- Make absolutely sure that the signal cable is never disconnected during DIGITAL-1, 2 or 3 playback. Set the MUTING switch to "ON" or the power to "OFF" if the cable should be disconnected.
- This unit may be connected with components that have a digital output in accordance with the digital audio interface format.

○ **Playing an Analog Program Source**

1. Set the DIGITAL DIRECT (digital direct switching) switch ② to the "OFF" position. Indicator ⑤ will not light.
2. Select the desired program source with INPUT SELECTOR (analog input switching) and TAPE MONITOR (tape input switching).

PROGRAM SOURCE	INPUT SELECTOR	MONITOR/COPY
Record	PHONO	SOURCE
Compact disc	CD	SOURCE
Tuner	TUNER	SOURCE
The other audio equipment	AUX-1, AUX-2	SOURCE
When listening to a tape on a tape deck connected to the TAPE-1 terminals	—	TAPE-1 / 1▶ 2
When listening to a tape on a tape deck connected to the TAPE-2 terminals	—	TAPE-2 / 2▶ 1

3. Begin playing the program source.

For information on the operating method, refer to the operating instructions for the various components.

4. Adjust the volume.

○ Playing a Digital Program Source

1. Set the DIGITAL DIRECT switch ② to the "ON" position. Indicator ⑤ will light.
2. Select the desired program source with the INPUT SELECTOR (digital input switching) and the DAT MONITOR.

PROGRAM SOURCE	INPUT SELECTOR	DAT MONITOR
Digital source with optical output	DIGITAL-1	OFF
Digital source with a coaxial type digital output	DIGITAL-2, 3	OFF
Coaxial type digital source from DAT	-	ON

The sampling frequency indicator will light up in correspondence with the sampling frequency of the digital signal that has been input.

3. Begin playing the program source.
For information on the operating method, refer to the operating instructions for the various components.
4. Adjust the volume.

○ Analog Recording to the Tape Deck and Tape Copying.

1. Select the program source that you wish to record with the MONITOR/COPY (recording output switching).

PROGRAM SOURCE	MONITOR/COPY
When recording program sources connected to PHONO ~ AUX-2	SOURCE
When recording from the component connected to the TAPE-1 terminals to TAPE-2	TAPE-1 / 1▶2
When recording from the component connected to the TAPE-2 terminals to TAPE-1	TAPE-2 / 2▶1
When recording a program source connected to DIGITAL-1, 2, 3 DAT MONITOR (Set the DIGITAL DIRECT switch to "ON" at this time)	DAC OUT

Don't change the MONITOR/COPY switch while recording, or you will get intermittent sounds.

2. Begin playing the program source.
3. Begin recording with the tape deck.
For information on the operating method, refer to the operating instructions for the various components.

○ Digital Copying to the Digital Tape Deck

NOTE: In some cases digital copying is not possible due to differences in sampling frequency, etc.

For digital tape decks equipped with digital recording input terminals, copying of the unchanged digital signal from the DAT OUT terminals is possible.

1. Set the DIGITAL DIRECT switch ② to "ON".
 2. Select the program source that you wish to record with the DIGITAL INPUT SELECTOR (DIGITAL-1, 2, 3).
 3. Begin playing the digital program source.
 4. Begin recording with the digital tape deck.
- For information on the operating method, refer to the operating instructions for the various components.

○ Monitoring the Recording

A recording in progress can be monitored if a tape deck with three individual heads for recording and playback is used. A tape deck in which a common head is used for both recording and playback cannot be used to monitor recording.

Set the MONITOR/COPY knob of TAPE-1 or TAPE-2 to corresponding to the tape deck that is being used for the recording. Use the MONITOR/COPY switch to switch between the recording monitor and the program source.

NOTE: When digital signals are being input from a CD player, DAT, etc., noise may be produced from the DAP-2500A if the power of the component sending digital signals is turned off before the power of the DAP-2500A. We recommend either turning off the power of the DAP-2500A first, or turning down the DAP-2500A's main volume control before turning off the power of the CD player, DAT, etc.

REMOVAL OF EACH SECTION

1. Top Cover Removal

Remove 10 screws and take out the Top Cover as per the arrow shows.

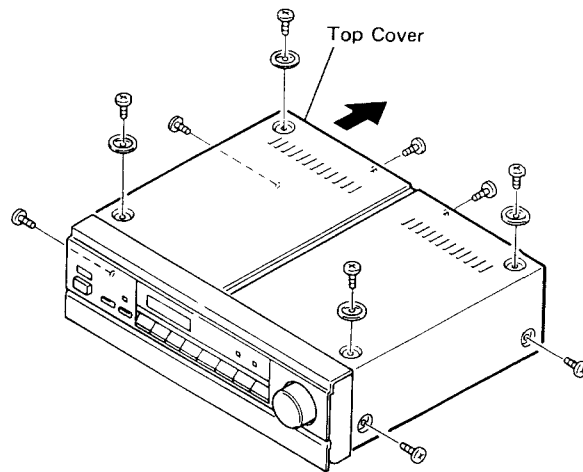

2. Front Panel Removal

Remove 6 screws and draw out the Front Panel as per the arrow shows.

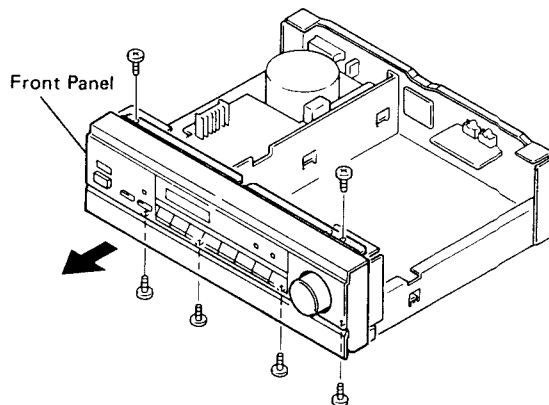

3. Front Sub-panel Removal

- 1 Remove screw (A), slide the chassis frame toward arrow direction, and release the hook from the chassis frame.
- 2 Unsecure 2 screws (B) (purposing to make a gap above the bottom plate so that the hook of Front Sub-panel releasing from the chassis) and 2 screws (C), then release the hooks from the both sides and detach the Front Sub-panel.

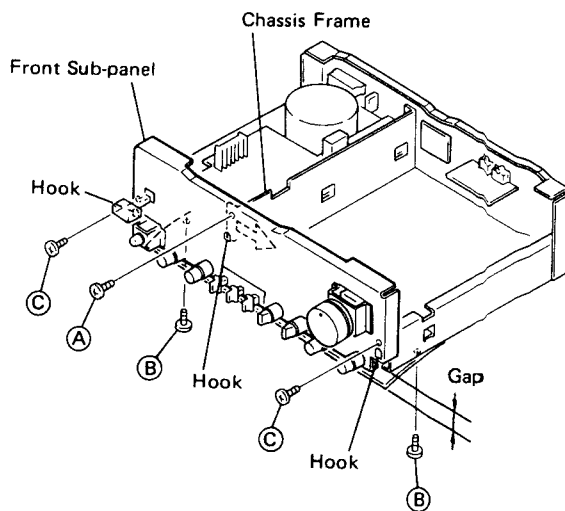

4. Rear Panel Removal

Unfasten 4 screws (A) and 10 screws (B), then detach the Rear Panel.

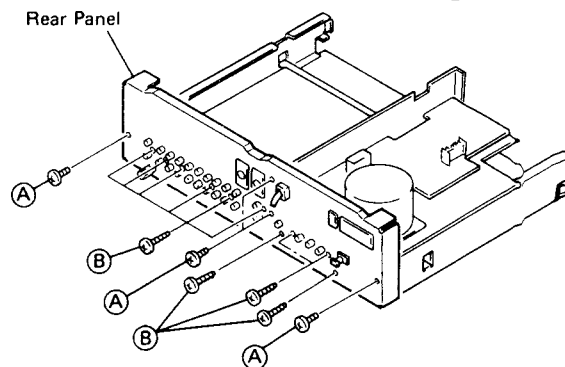

BLOCK DIAGRAM

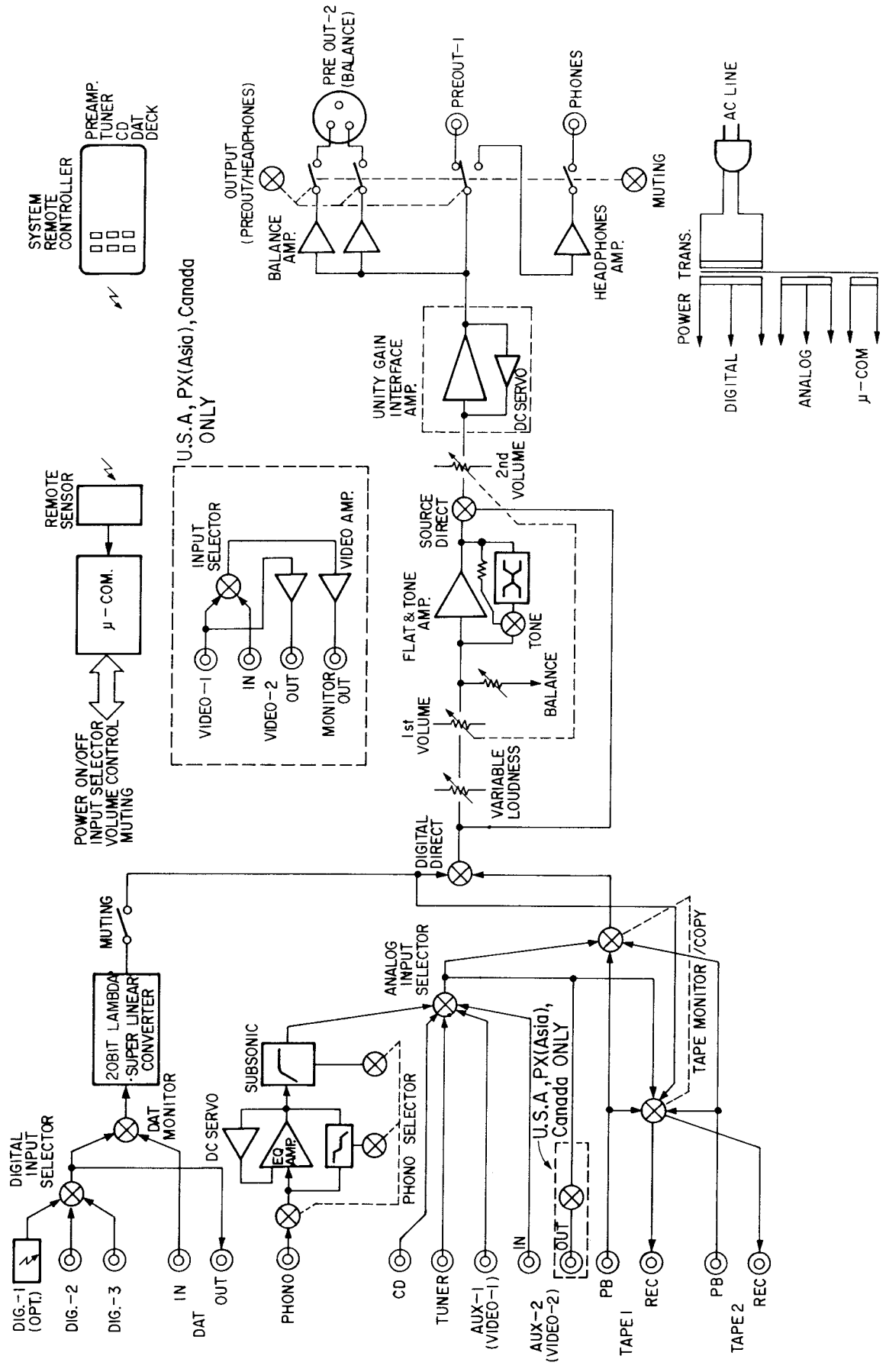

METHOD OF ADJUSTMENTS

When marking adjustments, be sure the power supply is at the rated voltage and the room air is in normal condition with respect to temperature and humidity.

DC OFFSET ADJUSTMENT

1. Keep the unit away from direct wind blown by an air-conditioner and an electric fan, and keep the unit under normal conditions. Adjust the range of ambient temperature to 15 ~ 30°C.
2. Set the following switches as follows:
 - POWER (power switch) to off
 - VOLUME (VOLUME CONTROL) to 0 (↶)
3. Remove the top cover and connect a DC digital voltmeter to the test points of KU-9161-3 (VOLUME unit) (between the positive terminal (TP1) and the negative terminal (TP2), and between the positive terminal (TP3) and the negative terminal (TP2)).
4. Connect Power cord to AC outlet, and turn Power Switch "on" (■). After 1 minute turn VR305 (Lch) and VR306 (Rch) so that the DC voltmeter reads 0 mV ± 1 mV.

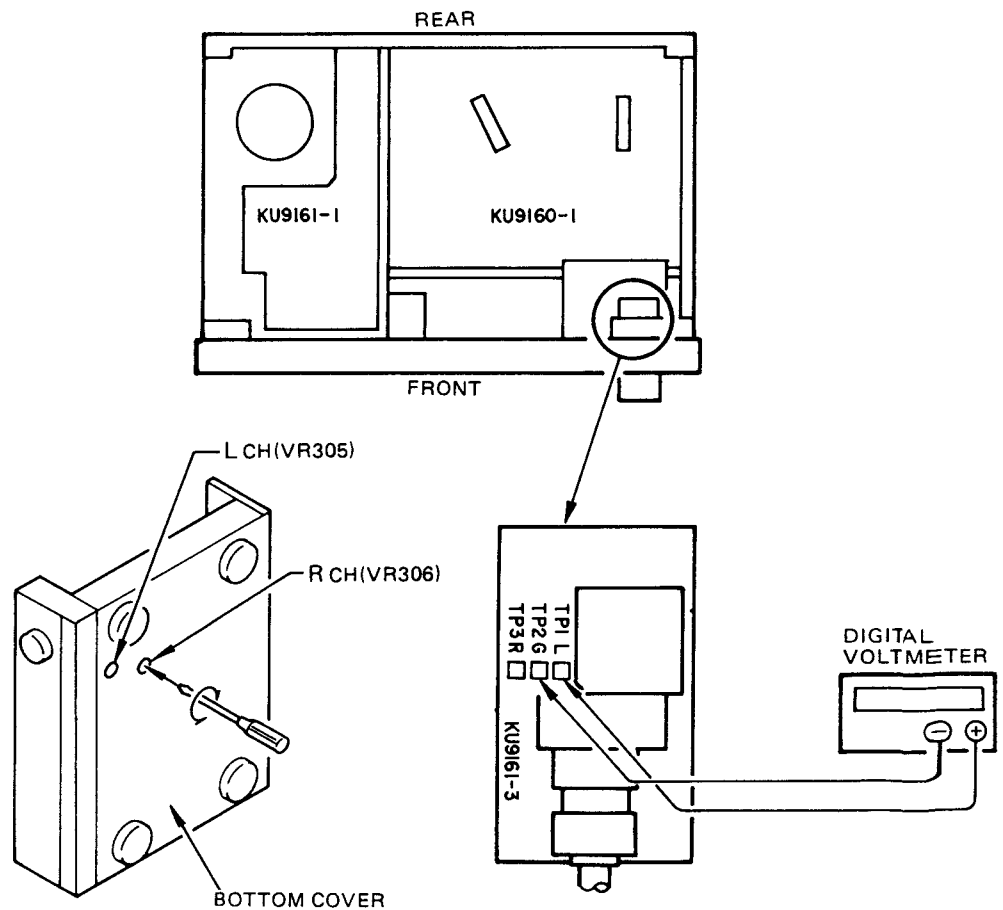

SEMICONDUCTORS

• IC

NJM79L05A

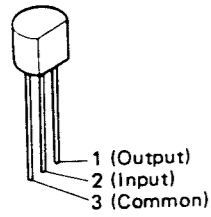

L78M05ML
L78M09ML
NJM78M15FA
L78M18ML

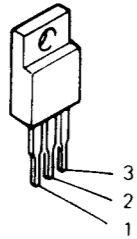

NJM79M09FA
NJM79M15FA
NJM79M18FA

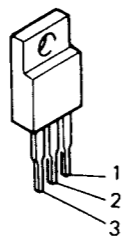

NJM78L05A

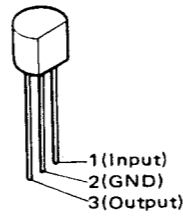

ICP-N10 (+5V PROTECTOR)



PCM61P

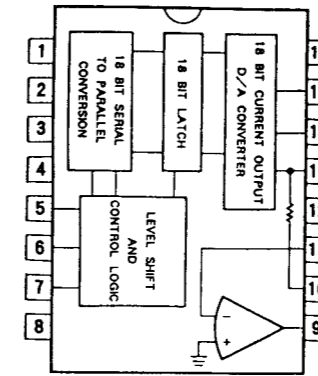
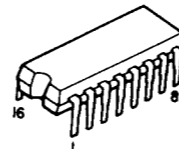

CF37606

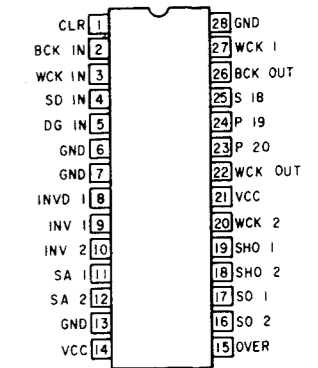
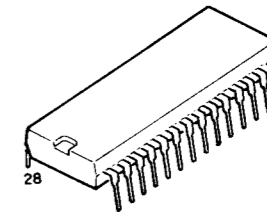

PST524C

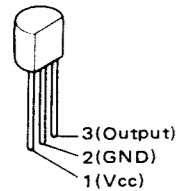

M5218P
M5238P
NJM2068DAC
NJM4556D
LA-6458DF

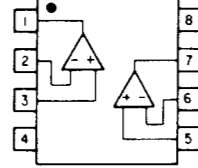
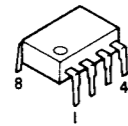

BA6109

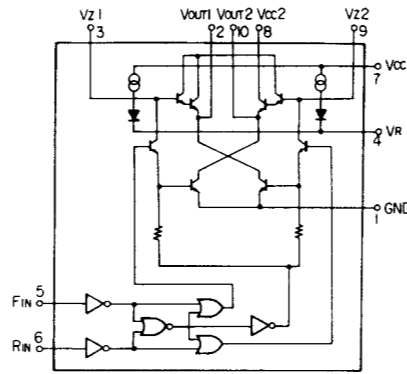
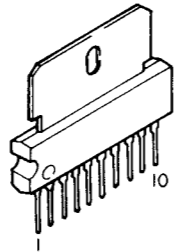

TC9152P

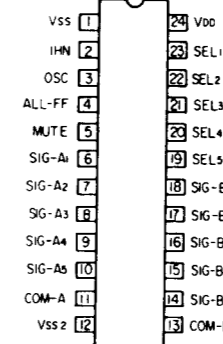
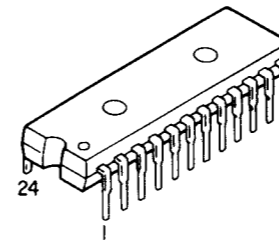

SM5813APA

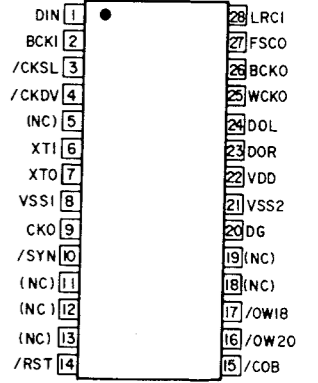
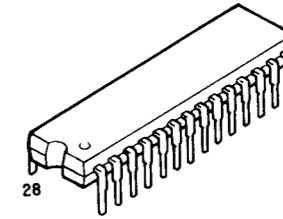

HD74HC00P
HD74HC08P
HD74HC74P
HD14011BP
TC74HCU04AP

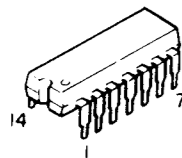

HD74HC00P

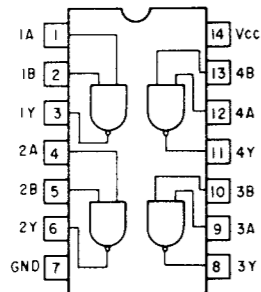

HD74HC08P

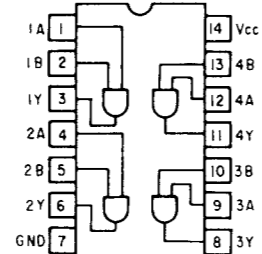

HD74HC74P

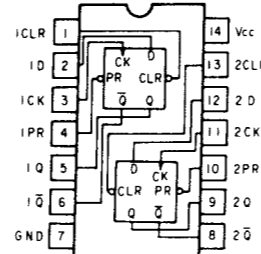

HD14011BP

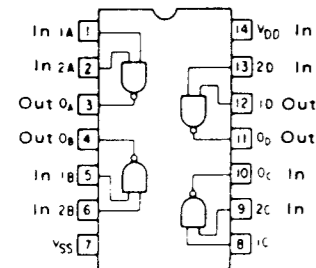

TC74HCU04AP

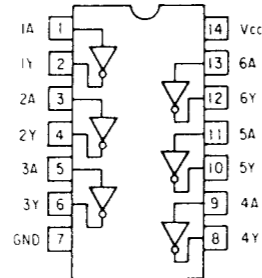

LC7815H

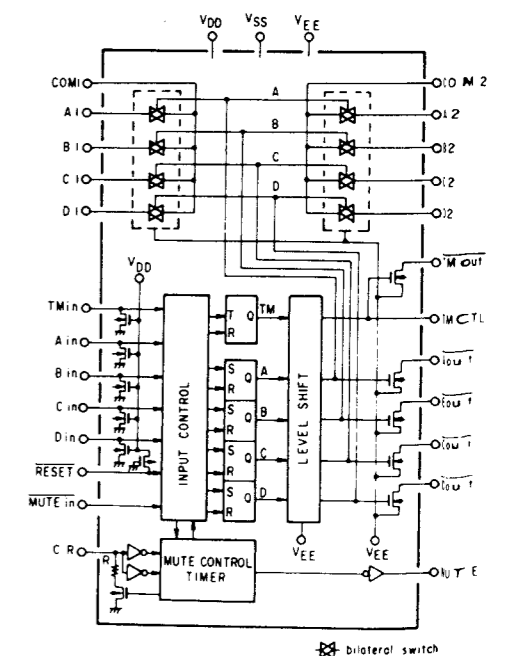
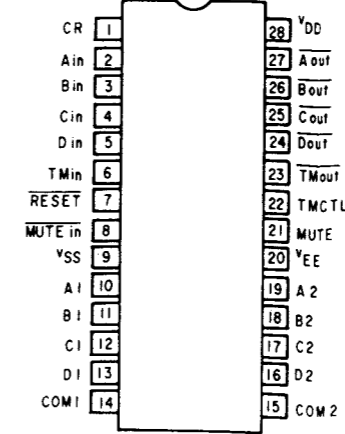
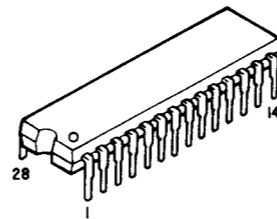

TORX172

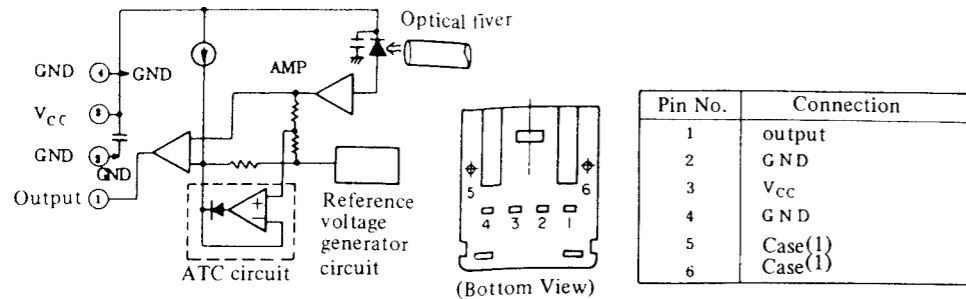

YM3623B

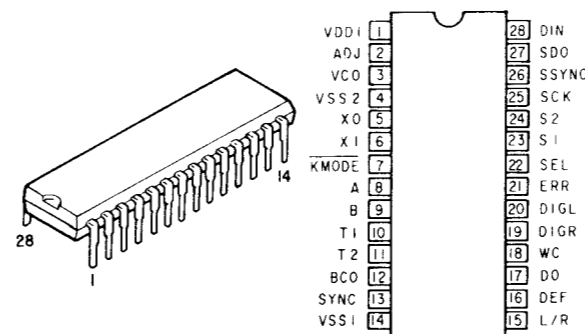

Input	Output	Output
SEL	S1	S2
L	L	L
L	H	H
H	L	L
H	H	H
H	H	L
H	L	L

LC7815H TERMINAL FUNCTION

Name of Terminal	Terminal No.	Type of Input/Output	Description																									
V _{DD} V _{SS} V _{EE}	28 9 20		Power supply terminal. When using 1 power supply source (+): V _{SS} = V _{EE} = GND When using 2 power supply sources (+ -): V _{SS} = GND, V _{EE} = (-)V																									
A _{in} , B _{in} C _{in} , D _{in}	2,3,4,5		<ul style="list-style-type: none"> Designated input terminal to turn on each analog switch. Priority in simultaneous pushing of buttons (A_{in} > B_{in} > C_{in} > D_{in}). Protection against mis-operation caused by pulse noise (discriminate pulse-width by delay time). 																									
A _{out} , B _{out} , C _{out} , D _{out}	27, 26, 25, 24		<ul style="list-style-type: none"> L LED driver output for ON state indication corresponding to each analog switch. N channel open drain (source is connected to V_{EE}). 																									
A ₁ , B ₁ , C ₁ , D ₁ A ₂ , B ₂ , C ₂ , D ₂ COM 1 COM 2	10,11, 12,13 19,18, 17,16 14 15		<ul style="list-style-type: none"> A ~ D = Audio signal input terminal. COM = Audio signal output terminal. Signal inputs (A ~ D) are connected as per following table with signal inputs (A_{in} ~ D_{in}). <table border="1"> <thead> <tr> <th>COM_n Output</th> <th>A_n</th> <th>B_n</th> <th>C_n</th> <th>D_n</th> </tr> </thead> <tbody> <tr> <td>Designate</td> <td>A_{in}</td> <td>B_{in}</td> <td>C_{in}</td> <td>D_{in}</td> </tr> <tr> <td>Input</td> <td>1</td> <td>1</td> <td>1</td> <td>1</td> </tr> <tr> <td></td> <td>*</td> <td>*</td> <td>*</td> <td>*</td> </tr> <tr> <td></td> <td>*</td> <td>*</td> <td>*</td> <td>*</td> </tr> </tbody> </table> <p>*: Don't care.</p>	COM _n Output	A _n	B _n	C _n	D _n	Designate	A _{in}	B _{in}	C _{in}	D _{in}	Input	1	1	1	1		*	*	*	*		*	*	*	*
COM _n Output	A _n	B _n	C _n	D _n																								
Designate	A _{in}	B _{in}	C _{in}	D _{in}																								
Input	1	1	1	1																								
	*	*	*	*																								
	*	*	*	*																								
TM _{in}	6		<ul style="list-style-type: none"> Designated input terminal for tape monitor mode ON/OFF. Detects the raise of input terminal and if it is monitor mode ON shifts to OFF; if it is OFF reverts to ON. 																									
TMCTL	22		<ul style="list-style-type: none"> Output terminal to control external analog switch (LC4066B) for tape monitor. N channel transistor source of complimentary buffer output is connected V_{EE}. 																									
TM _{out}	23		<ul style="list-style-type: none"> Output terminal to control external analog switch (LC4066B) for tape monitor in conjunction with the LED driver for indicating tape monitor condition. TM_{out} is reverse polarity output to TMCTL. 																									
MUTE _{in}	8		<ul style="list-style-type: none"> Forced external triggering input terminal for audio mute control signal (MUTE). Fix to "L" level makes MUTE output to "H". 																									
MUTE	21		<ul style="list-style-type: none"> Output terminal of audio muting control signal. Emits pulse width signal which is decided by the external CR constant at the time switching the function, or at the time MUTE_{in} is input. 																									
CR	1		<ul style="list-style-type: none"> Terminal to make time constant of CR which decides time length of audio muting controlling signal. Time difference (MUTE delay) from the raise of muting signal to the time shifting analog switch is decided by C, R_s time constant at the time of transistor is in ON. 																									
PRESET	7		<ul style="list-style-type: none"> Input terminal to set all the analog switches to OFF state and to reset tape monitor flip-flop ("L" level = active). 																									

(PU) Denotes the terminal is pulled-up internally.

Pin No.	Name of Terminal	I/O	Function
1	VDD1		System power supply (+5V).
2	ADJ	I	VCO oscillation frequency adjustment terminal, not to be connected.
3	VCO	I/O	External capacitor connecting terminal for VCO circuit.
4	VSS2		Ground terminal for VCO circuit. Connect in common with VSS1. It is not in common in LSI.
5	XO	O	Crystal oscillator terminal (16.9344 MHz ~ 20 MHz).
6	XI	I	Crystal oscillator terminal.
7	KMODE	I(PU)	H: Actuates PLL circuit when input is applied to DIN terminal, if no input is applied utilizing crystal oscillator to actuate. L: In despite of DIN terminal input, use crystal oscillator.
8	φA	O	Varies crystal oscillation frequency when crystal oscillator is used, when PLL circuit is actuated, varies with the input data velocity to PLL circuit. (Approx. 5.6448 MHz at the time f _s = 44.1 kHz)
9	φB	O	Varies crystal oscillation frequency when crystal oscillator is used, when PLL circuit is actuated, varies with the input data velocity to PLL circuit. (Approx. 5.6448 MHz at the time f _s = 44.1 kHz)
10	T1	I(PU)	Check terminal for internal circuit.
11	T2	I(PU)	Check terminal for internal circuit.
12	BCO	O	Timing lock for output signal emitted from DO terminal.
13	SYNC	O	Synchronous signal.
14	VSS1	O	System power supply GND (+0V).
15	L/R	O	Indicates output emits from DO terminal, H = L-ch; L = R-ch data.
16	DEF	O	H = Indicates input is deemphasized. L = Indicates input is not deemphasized.
17	DO	O	16 bits data output.
18	WC	O	Indicates data is emitting to DO terminal.
19	DIGR	O	Delitch signal for R-ch.
20	DIGL	O	Delitch signal for L-ch.
21	ERR	O	H = Parity error, or actuating with crystal. L = No error.
22	SEL	I(PU)	Refer to other column.
23	S1	O	Refer to other column.
24	S2	O	Refer to other column.
25	SCK	O	Sub-code output clock.
26	SSYNC	O	Signal for sub-code.
27	SDO	O	Sub-code data output terminal.
28	DIN	I(PU)	Data input terminal.

HD614120SA80

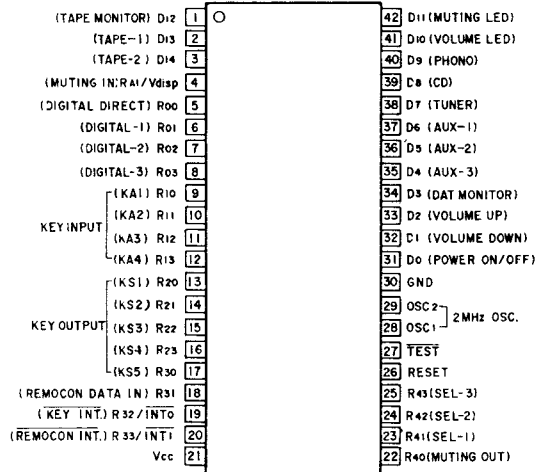
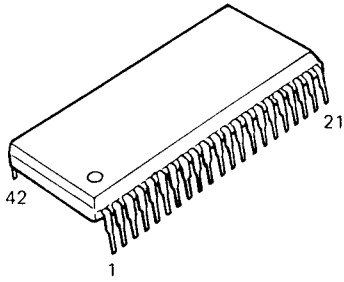

Pin No.	I/O	Name of Terminal	Active	Terminal Function
1	O	TAPE MONITOR		Tape monitor ON/OFF output (momentary).
2	O	TAPE-1		Tape selection output (mutual reset).
3	O	TAPE-2		
4	I	MUTING IN	H	
5	O	DIGITAL DIRECT		Digital direct ON/OFF output. For each input to emit puls output (150m sec.).
6	O	DIGITAL-1		Digital selection output (mutual reset).
7	O	DIGITAL-2		
8	O	DIGITAL-3		
9	O	KA1	H	Key output
10	O	KA2	H	
11	O	KA3	H	
12	O	KA4	H	
13	I	KS1	H	Key input.
14	I	KS2	H	
15	I	KS3	H	
16	I	KS4	H	
17	I	KS5	H	
18	I	REMOCON DATA		Remote control reception data input.
19	I	KEY INT.		Key int. input.
20	I	REMOCON INT.		
21	-	Vcc	-	Power supply
22	O	MUTING OUT		∞ Muting output (power ON: 8 sec., function selection: 1 sec.).
23	I	SEL-1	H	Function switch output port signal type (pulse/latch) selection. DAP2500 SEL-1: "L", SEL-2: "H".
24	I	SEL-2	H	
25	I	SEL-3	H	
26	I	RESET	H	Micro-computer reset input, "H": Reset.
27	I	TEST	L	
28	I	OSC1	-	Oscillator (clock) input (2 MHz.).
29	O	OSC2	-	Oscillator output.
30	-	GND	-	Ground
31	O	POWER ON/OFF		Power control output. "H": ON, "L": OFF.
32	O	VOLUME DOWN		Volume control output. "H": Down
33	O	VOLUME UP		Volume control output. "H": Up.
34	O	DATA MONITOR		DAT monitor ON/OFF output. For each input to emit puls output (150m sec.).
35	O	AUX-3		Analog selection output. Pulse output (150m sec.) at the time of input.
36	O	AUX-2		
37	O	AUX-1		
38	O	TUNER		
39	O	CD		
40	O	PHONO		
41	O	VOLUME LED		Volume Up/Down mode LED indication (250m sec. interval blinking).
42	O	MUTING LED		∞ Muting/Stand-by LED indication. ∞ Muting: 250m sec. interval blinking. Stand-by: Remote control. Lights at the time of power OFF.

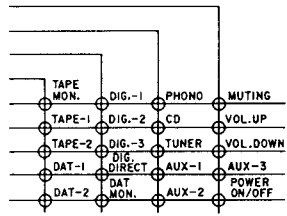

• Transistor

2SA988 (E/F)
2SA1015 (GR)
2SC1815 (BL)
2SC1815 (Y)
2SC2878 (A/B)

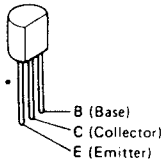

2SA1020 (Y)
2SB562 (C)
2SC2655 (Y)

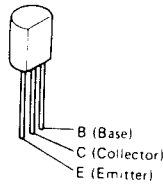

2SK369 (BL)/(GR)-C

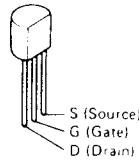

2SJ103 (BL/V)
2SK246 (BL/V)

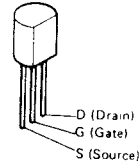

2SK381 (D)/(E)

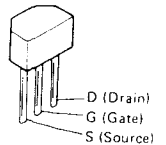

RN1201 (NPN)
RN1202 (NPN)
RN1204 (NPN)
RN2202 (PNP)

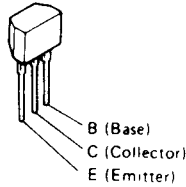

RN1202

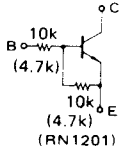

RN1204

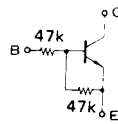

RN2202

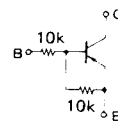

• Diode (LED)

1S2076A

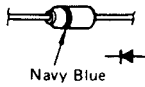

1SS270A

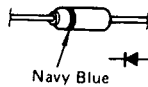

HZ5C-1
HZ6B-2
HZ18-2

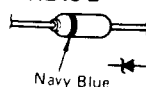

DSM1A2 (TYPE-2)

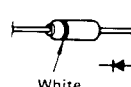

DSA1A2 (TYPE-3)
DSM1D2 (TYPE-3)

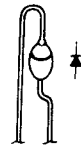

LD-701DU

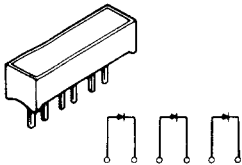

SEL2210R (RED)
SEL2410G (GREEN)
SEL2910D (ORANGE)
SEL4214S (RED)

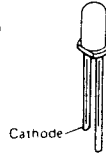

LB-202VA (LED RED)

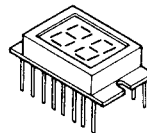

NOTE ON PARTS LIST

- Part indicated with the mark "⊙" are not always in stock and possibly to take a long period of time for supplying, or in some case supplying of part may be refused.
- When ordering of part, clearly indicate "1" and "I" (i) to avoid mis-supplying.
- Ordering part without stating its part number can not be supplied.
- Part indicated with the mark "★" is not illustrated in the exploded view.

WARNING:

Parts marked with this symbol have critical characteristics. Use ONLY replacement parts recommended by the manufacturer.

• Resistors

Ex.: RN 14K 2E 182 G FR
Type Shape and performance Power Resistance Allowable error Others

RD : Carbon	2B : 1/4W	F : ±1%	P : Pulse-resistant type
RC : Fixed	2E : 1/2W	G : ±2%	NL : Low noise type
RS : Metallic film	2H : 1/2W	J : ±5%	NB : Non-burning type
RW : Winding	3A : 1W	K : ±10%	FR : Fuse resistor
RN : Metal film	3D : 2W	M : ±20%	F : Lead wire forming
RK : Metal mixture	3F : 3W		
	3H : 5W		

★ Resistance

1 8 2 ⊙ 1800Ω = 1.8kΩ
Indicates number of zeros after effective number
2-digit effective number, decimal point indicated by R.
• Units: Ω

• Capacitors

Ex.: CE 04W 1H 2R2 M BP
Type Shape and performance Dielectric strength Capacity Allowable error Others

CE : Aluminum foil electrolyte	0J : 6.3V	F : ±1%	HS : High stability type
CA : Aluminum solid electrolyte	1A : 10V	G : ±2%	BP : Non-polar type
CS : Tantalum electrolyte	1C : 16V	J : ±5%	HR : Ripple-resistant type
CO : Film	1E : 25V	K : ±10%	DL : For charge and discharge
CK : Ceramic	1V : 35V	M : ±20%	HF : For assuring high frequency
CC : Ceramic	1H : 50V	Z : +80%	U : UL part
CP : Oil	2A : 100V	-20%	C : CSA part
CM : Mica	2B : 125V	P : +100%	W : UL-CSA type
CF : Metallized	2C : 160V	-0%	F : Lead wire forming
CH : Metallized	2D : 200V	C : ±0.25pF	
	2E : 250V	D : ±0.5pF	
	2H : 500V	= : Others	
	2J : 630V		

★ Capacity

2 R 2 : 2.2μF
1-digit effective number, decimal point indicated by R.
2-digit effective number, decimal point indicated by R.

- Units: μF, (for P, pF (μμF))
- When the dielectric strength is indicated in AC, "AC" is included after the dielectric strength value.

PRINTED WIRING BOARD PARTS LIST
KU-9160B PRE AMP UNIT

WARNING:

 Parts marked with this symbol \triangle have critical characteristics.
 Use ONLY replacement parts recommended by the manufacturer.

Ref. No.	Part No.	Part Name	Remarks
SEMICONDUCTOR			
IC201	2630257001	M5218P	
IC202	2630229013	LA-6458DF	
IC203	2650030004	NJM4558D-D	
IC261	2620581004	TC9152P	
IC301	2630257001	M5218P	
IC351	2620679000	M5238P	
IC352	2630229013	LA-6458DF	
IC353	2630198005	NJM4556D	
IC401,402	2630594007	NJM2068DAC	
IC501	2630507007	NJM78M15FA	
IC502	2630508006	NJM79M15FA	
IC503	2630556003	L78M18ML	
IC504	2630592009	NJM79M18FA	
TR201~208	2750038045	2SK369(BL)/(GR)-C	
TR301~304	2750038045	2SK369(BL)/(GR)-C	
TR305~308	2730198002	2SC1815 (Y)	
TR351,352	2750050010	2SK246 (BL/V)	
TR353,354	2750054003	2SJ103 (BL/V)	
TR501	2710117003	2SA1020 (Y)	
TR502	2730212001	2SC2655 (Y)	
TR503	2710131021	2SA988 (E/F)	
TR504	2730198015	2SC1815 (BL)	
TR508,509	2730198015	2SC1815 (BL)	
TR511	2730198015	2SC1815 (BL)	
D201~204	2760049011	1S2076A	
D265	2760049011	1S2076A	
D301,302	2760236031	HZ5C-1	
D303	2760049011	1S2076A	
D351,352	2760049011	1S2076A	
D401,402	2760049011	1S2076A	
D501~508	2760427015	DSA1A2 (TYPE-3)	
D508	2760049011	1S2076A	
D510	2760049011	1S2076A	
D513	2760249002	HZ18-2	
D514,515	2760433009	DSM1A2 (TYPE-2)	
RESISTORS (not included Carbon Film $\pm 5\%$ 1/4W type)			
\triangle R227,228	2440038025	RS14B3A581JNBF	560ohm,1W
\triangle R309,310	2412379981	RD14B2E821JNBST	820ohm,1/4W
\triangle R311~314	2412380921	RD14B2E152JNBST	1.5kohm,1/4W
\triangle R350	2412376919	RD14B2E300JNBST	30ohm,1/4W
\triangle R379	2412377947	RD14B2E101JNBST	100ohm,1/4W
\triangle R380	2412378917	RD14B2E201JNBST	200ohm,1/4W
\triangle R395,396	2442051958	RS14B3A221JST	220ohm,1W
\triangle R423	2412377947	RD14B2E101JNBST	100ohm,1/4W
\triangle R505	2440053026	RS14B3A103JNBF	10kohm,1W
VR301	2119074006	V1620V20FB104 (V.LOUDNESS)	100kohm,Variable resistor
VR302	2119073007	V16V20FB254T (BALANCE)	250kohm,Variable resistor
VR305,306	2116016009	V08PB101	100ohm,Semifixed resistor
Ref. No.	Part No.	Part Name	Remarks
VR307	2119075005	V1620V20FC303K (BASS)	30kohm,Variable resistor
VR308	2119075018	V1620V20FC502K (TREBLE)	5kohm,Variable resistor
CAPACITORS			
C317,318	2534537968	CC45SL1H470J	47pF/50V $\pm 5\%$
C353,354	2534537908	CC45SL1H270J	27pF/50V $\pm 5\%$
C385,386	2534537908	CC45SL1H270J	27pF/50V $\pm 5\%$
C409,410	2534537908	CC45SL1H270J	27pF/50V $\pm 5\%$
C201,202	2533634006	CC45SL1H201J	200pF/50V $\pm 5\%$
C203,204	2533631009	CC45SL1H151J	150pF/50V $\pm 5\%$
C251,252	2533619005	CC45SL1H470J	47pF/50V $\pm 5\%$
C372	2531024003	CK45F1H103Z	0.01 μ F/50V +80,-20%
C508	2539036006	CK45=1E104Z	0.1 μ F/25V +80,-20%
C516	2539036006	CK45=1E104Z	0.1 μ F/25V +80,-20%
C519,520	2531024003	CK45F1H103Z	0.01 μ F/50V +80,-20%
C205,206	2544254048	CE04W1C101M (SME)	100 μ F/16V $\pm 20\%$
C213,214	2544260045	CE04W1H010M (SME)	1 μ F/50V $\pm 20\%$
C223,224	2544250932	CE04W0J221M (SME)	22 μ F/6.3V $\pm 20\%$
C225,226	2544260045	CE04W1H010M (SME)	1 μ F/50V $\pm 20\%$
C227,228	2544250026	CE04W0S101M (SME)	100 μ F/6.3V $\pm 20\%$
C235,236	2544260016	CE04W1HR22M (SME)	0.22 μ F/50V $\pm 20\%$
C237,238	2544260003	CE04W1HOR1M (SME)	0.1 μ F/50V $\pm 20\%$
C239,240	2544256004	CE04W1E100M (SME)	10 μ F/25V $\pm 20\%$
C250	2544260045	CE04W1H010M (SME)	1 μ F/50V $\pm 20\%$
C261,262	2544260045	CE04W1H010M (SME)	1 μ F/50V $\pm 20\%$
C263	2544260032	CE04W1HR47M (SME)	0.47 μ F/50V $\pm 20\%$
C265	2544254019	CE04W1C220M (SME)	22 μ F/16V $\pm 20\%$
C311,312	2544260045	CE04W1H010M (SME)	1 μ F/50V $\pm 20\%$
C315,316	2544258002	CE04W1V4R7M (SME)	4.7 μ F/35V $\pm 20\%$
C323,324	2544260045	CE04W1H010M (SME)	1 μ F/50V $\pm 20\%$
C331,332	2544260032	CE04W1HR47M (SME)	0.47 μ F/50V $\pm 20\%$
C355,356	2544260045	CE04W1H010M (SME)	1 μ F/50V $\pm 20\%$
C363,364	2554199902	CQ92M1H104J (MRZ)	0.1 μ F/50V $\pm 5\%$
C367,368	2544250026	CE04W0J101M (SME)	100 μ F/6.3V $\pm 20\%$
C371	2544254006	CE04W1C100M (SME)	10 μ F/16V $\pm 20\%$
C381~384	2544260045	CE04W1H010M (SME)	1 μ F/50V $\pm 20\%$
C389,390	2543053936	CE04D1C470MBP (SME)	47 μ F/16V $\pm 20\%$
C401	2544260003	CE04W1HOR1M (SME)	0.1 μ F/50V $\pm 20\%$
C403	2544260003	CE04W1HOR1M (SME)	0.1 μ F/50V $\pm 20\%$
C407,408	2543054948	CE04D1E101MBP (SME)	100 μ F/25V $\pm 20\%$
C411,412	2543054948	CE04D1E101MBP (SME)	100 μ F/25V $\pm 20\%$
C502~505	2544261769	CE04W1H102MC (SME)	1000 μ F/50V $\pm 20\%$
C509	2544260045	CE04W1H010M (SME)	1 μ F/50V $\pm 20\%$
C510	2544260032	CE04W1HR47M (SME)	0.47 μ F/50V $\pm 20\%$
C511	2544258057	CE04W1V101M (SME)	100 μ F/15V $\pm 20\%$

Ref. No.	Part No.	Part Name	Remarks
C517	2544260045	CE04W1H010M (SME)	1 μF/50V ±20%
C518	2544254006	CE04W1C100M (SME)	10 μF/16V ±20%
C523	2544254006	CE04W1C100M (SME)	10 μF/16V ±20%
C209,210	2554199986	CQ92M1H102J (MRZ)	0.001 μF/50V ±5%
C211,212	2551249965	CQ93M1H472J (B)	0.0047 μF/50V ±5%
C215,216	2554199973	CQ93M1H103J (MRZ)	0.01 μF/50V ±5%
C217,218	2554199957	CQ92M1H183J (MRZ)	0.018 μF/50V ±5%
C219,220	2554219989	CQ09P1H152J (PDH)	0.0015 μF/50V ±5%
C221,222	2554199931	CQ92M1H683J (MRZ)	0.068 μF/50V ±5%
C229,230	2554219989	CQ09P1H152J (PDH)	0.0015 μF/50V ±5%
C301,302	2551250909	CQ93M1H223J (B)	0.022 μF/50V ±5%
C303,304	2551249910	CQ93M1H581J (B)	560pF/50V ±5%
C307,308	2554199986	CQ92M1H102J (MRZ)	0.001 μF/50V ±5%
C309,310	2554213943	CQ93M1H332J (B)	0.0033 μF/50V ±5%
C319,320	2554199986	CQ92M1H102J (MRZ)	0.001 μF/50V ±5%
C325,326	2551249949	CQ93M1H182J (B)	0.0018 μF/50V ±5%
C327,328	2551249981	CQ93M1H123J (B)	0.012 μF/50V ±5%
C351,352	2554214052	CQ09P1H221J	220pF/50V ±5%
C359~362	2554214052	CQ09P1H221J	220pF/50V ±5%
C387,388	2554199973	CQ92M1H103J (MRZ)	0.01 μF/50V ±5%
C405,406	2551249907	CQ93M1H471J (B)	470pF/50V ±5%
C501	2554228967	CQ92P2A103J	0.01 μF/100V ±5%
C521,522	2554199902	CQ92M1H104J (MRZ)	0.1 μF/50V ±5%
C321,322	2561034092	CF93A1H154J	0.15 μF/50V ±5%
C329,330	2561034050	CF93A1H683J	0.068 μF/50V ±5%

Ref. No.	Part No.	Part Name	Remarks	Q'ty
CN17	2050233058	5P EH CONN.BASE		1
CN18	2050233061	6P EH CONN.BASE		1
CN19	2050343032	3P CONN.BASE(KR-PH)		1
	2032233005	2P DA-DA CONN. CORD	L=250 CN-21	1
	2034551002	3P NH-SCN CONN. CORD	L=180 White CN-10	1
	2034552001	3P EH-SCN CONN. CORD	L=180 Red CN-11	1
	2034552014	3P EH-SCN CONN. CORD	L=180 White CN-12	1
	2040243003	6P EH-SCN CONN. CORD	L=200 CN-18	1
	2040244002	7P SCN-3P SCN CONN. CORD	L=270 CN-20	1
	2034455001	3P KR-DA CONN. CORD	L=140 CN-19	1
	2042226028	8P KR-DA CONN. CORD	L=270 CN-1	1
	2030330007	CONNECTING.CORD Ass'y	L=105 B-B Blue	1
	0049003000	TWIN SHIELD WIRE	L=330 A-A	1

SWITCH, RELAY, COIL

L201,202	2399001006	FTZ CHOKE COIL (221)	
L203,204	2350016917	INDUCTOR (180k)	
L351,352	2350016917	INDUCTOR (180k)	
SW201	2129521002	SLIDE SW (REMOTE)	PHONO SELECT
SW261	2124254002	SLIDE SW (REMOTE)	TAPE
SW301	2129547015	3P PUSH SWITCH	PRE OUT-TONE
RL261	2149005100	RELAY (BSR-H-12S)	
RL301	2149005100	RELAY (BSR-H-12S)	
RL351~353	2149005100	RELAY (BSR-H-12S)	
RL401,402	2149005100	RELAY (BSR-H-12S)	

OTHER PARTS

			Q'ty
	4170307008	HEAT SINK	2
	4700012022	Cross Pan Screw with S.W.,W 3×12	(for IC501~504) 4
PJ201	2048225007	2P CONNECTOR BASE	PHONO 1
PJ261~264	2048287003	4P CONNECTOR BASE	CD TU AUX T1 T2 4
PJ351	2048225007	2P CONNECTOR BASE	PREOUT-1 1
DJ501,502	2048289001	DC POWER JACK	REMOTE 2
	2050185038	3P WIRE HOLDER	2
CN2	2050343058	5P CONN.BASE (KR-PH)	1
CN13	2050190036	3P NH CONN.BASE	1
CN14~16	2050233032	3P EH CONN.BASE	3

KU-9161B CONTROL UNIT

WARNING:

Parts marked with this symbol \triangle have critical characteristics.
Use ONLY replacement parts recommended by the manufacturer.

Ref. No.	Part No.	Part Name	Remarks
SEMICONDUCTOR			
PT001	2680072003	ICP-N10	0.4A PROTECTOR
IC2	2630432004	NJM78L05A	+5V
IC3	2620999007	PST524C	RESET
IC4	2621082007	HD814120SA80	MICRO COM.
IC5	2620326007	BA6109	MOTOR DRIVE
IC6	2630492002	L78M09ML	
IC7	2630518009	NJM79M09FA	
TR1,2	2690029004	RN1204 (47k-47k)	
TR5~9	2690025008	RN1202 (10k-10k)	
TR10~14	2690028007	RN2202 (10k-10k)	
TR15~20	2690025008	RN1202 (10k-10k)	
TR21~25	2690026007	RN2202 (10k-10k)	
TR26,27	2690025008	RN1202 (10k-10k)	
TR28	2710102021	2SA1015 (GR)	
TR29	2710117003	2SA1020 (Y)	
TR30	2730212001	2SC2655 (Y)	
TR31	2690029004	RN1204 (47k-47k)	
TR101	2690026007	RN2202 (10k-10k)	
D1	2760432000	1SS270A	
D2~5	2760427015	DSA1A2 (TYPE-3)	
D7~9	2760432000	1SS270A	
D14,15	2760432000	1SS270A	
D16,17	2760432000	1SS270A	
D18	2760173039	HZ6B-2	
D19	2760432000	1SS270A	
D101	2760249002	HZ18-2	
D102~107	2760432000	1SS270A	
LE101~105	3939409009	SEL-2410G	PHONO-AUX1(GR) AUX2(GR) DIG-1-3,DAT(OR)
LE106~108	3939402006	SEL-2910D	
LE110	3939402006	SEL-2910D	
LE111	3939401007	SEL2210R	MUTING(RD)
LE112	3939402006	SEL-2910D	S.DIRECT(OR)
LE113	3939405003	LB-202VA(LED RED)	SAMPLING FREQ
LE114	3939319018	LD-701DU	POWER
LE301	3939408000	SEL-4214S	VOLUME(RD)
RESISTORS (not included Carbon Film $\pm 5\%$ 1/4W type)			
\triangle R31 VR303	2440050029 2119081002	RS14B3A562JNBF V1640V30FR...R	5.6kohm,1W MOTOR VOL.
CAPACITORS			
C1,2	2538014702	CK45F2GAC103MC	400VAC 0.01 μ F
C4	2538014702	CK45F2GAC103MC	400VAC 0.01 μ F
C5	2531024003	CK45F1H103Z	0.01 μ F/50V
C8	2531024003	CK45F1H103Z	0.01 μ F/50V
C9	2544250929	CE04W0J101M	100 μ F/6.3V $\pm 20\%$
C10	2531024003	CK45F1H103Z	0.01 μ F/50V +80,-20%
C12	2544260948	CE04W1H010M (SME)	1 μ F/50V $\pm 20\%$
Ref. No.	Part No.	Part Name	Remarks
C13	2531024003	CK45F1H103Z	0.01 μ F/50V +80,-20%
C14~17	2544260948	CE04W1H010M	1 μ F/50V $\pm 20\%$
C18,19	2531024003	CK45F1H103Z	0.01 μ F/50V +80,-20%
C21	2544254941	CE04W1C100M (SME)	100 μ F/16V $\pm 20\%$
C22	2544254909	CE04W1C100M (SME)	10 μ F/16V $\pm 20\%$
C23	2531025002	CK45F1H223Z	0.022 μ F/50V +80,-20%
C101	2531024003	CK45F1H103Z	0.01 μ F/50V +80,-20%
C305	2531024003	CK45F1H103Z	0.01 μ F/50V +80,-20%
C306	2543053907	CE04D1C100MBP (SME)	10 μ F/16V $\pm 20\%$
C413	2544254938	CE04W1C470M (SME)	47 μ F/16V $\pm 20\%$
SWITCH, COIL			
LF1	2398019002	LINE FILTER COIL	
\triangle SW1	2120286003	POWER SWITCH	
SW101~111	2124388907	TACT SWITCH	
CF1	3999023001	CST 2.00MG	OSC
OTHER PARTS			
RS101	4170307008 4700012022 4990088002	HEAT SINK Cross Pan Screw with S.W.,W 3x12 QH3031HO	1 2 1
F1	2020022008 2061015003 5130711015	FUSE HOLDER FUSE (0.5A) FUSE LABEL (T500MA)	2 for F1 1
HP351	2048253008	HEADPHONES JACK	1
MJ1	2048260004	MINI JACK	REM,DATA OUT 1
	2050243022	2P WIRE HOLDER	CN-8 4
	2050190036	3P NH CONN. BASE	CN10 1
	2050233032	3P EH CONN. BASE	CN4,11,12 3
	2050233074	7P EH CONN. BASE	CN-D4 1
	2050233087	8P EH CONN. BASE	CN-D7 1
	2050275003	10P EH CONN. BASE	CN-D3 1
	2050343045	4P CONN. BASE (KR-PH)	CN-3 2
	2050343058	5P CONN. BASE	CN2 1
	2050343074	7P CONN. BASE	CN8 1
	2050343087	8P CONN. BASE	CN1 1
	2050375000	10P CONN. BASE	CN7 1
	2050375026	12P CONN. BASE	CN5 1
	2050355075	7P KR CONN. BASE(L)	CN6 1
	2050480005	10P KR CONN. BASE	CN7 1
	2050480021	12P KR CONN. BASE	CN5 1

1U-1991A DIG. INPUT UNIT

Ref. No.	Part No.	Part Name	Remarks	Q'ty	Ref. No.	Part No.	Part Name	Remarks
	0029013023	2C RIBBON WIRE	L=230 CN-8	1	SEMICONDUCTOR			
	2034552014	3P EH-SCN CONN. CORD	L=180 CN-15 White	1	IC601	269 0044 005	TORX-172	
	2030226056	1P CONTACT Ass'y	L=60	1	IC602,603	262 1265 002	TC74HCU04AP	
	2030330036	CONNECTING CORD Ass'y	L=60 Black A-A	1	IC604~606	262 0591 007	HD74HC00P	
	2034551015	3P NH-SCN CONN. CORD	L=240 CN-13 Red	1	IC607	262 0300 007	HD14011BP	
	2034553000	3P EH-SCN CONN. CORD	L=320 CN-16	1	IC608	262 0910 002	YM3623B	
					IC609	262 1128 000	SM5813APA	
					IC610	262 1095 007	LC7815H	
					IC611	262 0729 002	HD74HC08P	
					IC612	263 0567 005	NJM78M05FA	
					IC701,702	262 1180 006	CF37606	
					IC703	262 0594 004	HD74HC74P	
					IC704	262 1265 002	TC74HCU04AP	
					IC705,706	262 0591 007	HD74HC00P	
					IC707	263 0432 907	NJM78L05A	
					IC708	263 0433 003	NJM79L05A	
					IC709,710	262 1171 002	PCM61P	
					IC711,712	263 0594 007	NJM2068DAC	
					IC713	263 0432 907	NJM78L05A	
					IC714	263 0433 003	NJM79L05A	
					TR601	269 0025 901	RN1202 (10K-10K)	
					TR602	269 0023 903	RN1201 (4.7K-4.7K)	
					TR603	273 0253 918	2SC2878 (A/B)	
					TR604~607	269 0023 903	RN1201 (4.7K-4.7K)	
					TR608	271 0102 924	2SA1015 (GR)	
					TR609~611	273 0198 918	2SC1815 (BL)	
					TR612	272 0025 907	2SB562 (C)	
					TR613	273 0253 918	2SC2878 (A/B)	
					TR614	269 0023 903	RN1201 (4.7K-4.7K)	
					TR701	269 0025 901	RN1202 (10K-10K)	
					TR702	269 0026 900	RN2202 (10K-10K)	
					TR703,704	273 0253 918	2SC2878 (A/B)	
					TR705	269 0023 903	RN1201 (4.7K-4.7K)	
					TR706	271 0102 924	2SA1015 (GR)	
					TR707	269 0023 903	RN1201 (4.7K-4.7K)	
					TR709,710	269 0023 903	RN1201 (4.7K-4.7K)	
					D601~611	276 0432 903	1SS270A	
					D612~616	276 0548 910	DSM1D2 (TYPE-3)	
					D701	276 0432 903	1SS270A	
					RESISTORS (not included Carbon Film $\pm 5\%$ 1/4W type)			
					R766,767	244 2050 962	RS14B3A361JST (S)	360 Ω /1W $\pm 5\%$
					VR701,702	211 6077 938	V06PB104	10k Ω ohm semifixed resistor
					VR705,706	211 6077 938	V06PB104	
					CAPACITORS			
					C601	253 1146 907	CK45F1H103Z	0.01 μ F/50V +8%, -20%
					C604	253 1146 907	CK45F1H103Z	0.01 μ F/50V +8%, -20%
					C606~609	253 4436 902	CC45SL1H101J	10 μ F/50V $\pm 5\%$
					C616~619	253 1146 907	CK45F1H103Z	0.01 μ F/50V +8%, -20%
					C624,625	253 1146 907	CK45F1H103Z	0.01 μ F/50V +8%, -20%
					C627,628	253 1146 907	CK45F1H103Z	0.01 μ F/50V +8%, -20%
					C630,631	253 1146 907	CK45F1H103Z	0.01 μ F/50V +8%, -20%

Ref. No.	Part No.	Part Name	Remarks
C634,635	253 4412 900	CC45SL1H100D	10pF/50V ±0.5pF
C639	253 1146 907	CK45F1H103Z	0.01 μF/50V +80,-20%
C646	253 1146 907	CK45F1H103Z	0.01 μF/50V +80,-20%
C652	253 1151 905	CK45E2H472P	4700pF/500V +100,-0%
C656,657	253 9036 909	CK45=1E104Z	0.1 μF/25V +80,-20%
C662	253 9036 909	CK45=1E104Z	0.1 μF/25V +80,-20%
C663,664	253 1146 907	CK45F1H103Z	0.01 μF/50V +80,-20%
C665	253 1116 908	CK45B1H222K	2200pF/50V ±10%
C668,669	253 1146 907	CK45F1H103Z	0.01 μF/50V +80,-20%
C674	253 1146 907	CK45F1H103Z	0.01 μF/50V +80,-20%
701,702	253 9036 909	CK45=1E104Z	0.1 μF/25V +80,-20%
C707,708	253 9036 909	CK45=1E104Z	0.1 μF/25V +80,-20%
C723~725	253 9036 909	CK45=1E104Z	0.1 μF/25V +80,-20%
C727,728	253 1146 907	CK45F1H103Z	0.01 μF/50V +80,-20%
C729,730	253 4537 908	CC45SL1H270J (DD-3)	27pF/50V ±5%
C802,803	254 4254 909	CE04W1C100M(SME)	10 μF/16V ±20%
C805	254 4254 909	CE04W1C100M (SME)	10 μF/16V ±20%
C620~823	254 4256 923	CE04W1E330M (SME)	33 μF/25V ±20%
C826	254 4254 909	CE04W1C100M (SME)	10 μF/16V ±20%
C629	254 4254 909	CE04W1C100M (SME)	10 μF/16V ±20%
C636	254 4260 948	CE04W1H010M (SME)	1 μF/50V ±20%
C640	254 4254 909	CE04W1C100M (SME)	10 μF/16V ±20%
C645	254 4254 909	CE04W1C100M (SME)	10 μF/16V ±20%
C650,651	254 4256 790	CE04W1E222MC (SME)	2200 μF/25V ±20%
C653	254 4260 935	CE04W1HR47M (SME)	0.47 μF/50V ±20%
C654	254 4256 949	CE04W1E101M (SME)	100 μF/25V ±20%
C655	254 4256 923	CE04W1E330M (SME)	33 μF/25V ±20%
C658,659	254 4254 909	CE04W1C100M (SME)	10 μF/16V ±20%
C660,661	254 4254 941	CE04W1C101M (SME)	100 μF/16V ±20%
C666	254 4254 909	CE04W1C100M (SME)	10 μF/16V ±20%
C670,671	254 4258 905	CE04W1V4R7M (SME)	4.7 μF/35V ±20%
C672	254 4260 948	CE04W1H010M (SME)	1 μF/50V ±20%
C673	254 4254 909	CE04W1C100M (SME)	10 μF/16V ±20%
C699	254 4254 941	CE04W1C101M (SME)	100 μF/16V ±20%
C703,704	254 4254 909	CE04W1C100M (SME)	10 μF/16V ±20%
C705,706	254 4254 938	CE04W1C470M (SME)	47 μF/16V ±20%
C709,710	254 4254 909	CE04W1C100M (SME)	10 μF/16V ±20%
C726	254 4258 905	CE04W1V4R7M (SME)	4.7 μF/35V ±20%
C731~738	254 4313 905	CE04W1H3R3M (ASF)	3.3 μF/50V ±20%
C751,752	254 4356 001	CE04W1H100 (ARS)	10 μF/50V
C632	255 4199 973	CQ92M1H103J (MRZ)	0.01 μF/50V ±5%
C633	255 1220 900	CQ93M1H473J	0.047 μF/50V ±5%
C739,740	255 4217 981	CQ09P1H221J	220pF/50V ±5%
C741,742	255 4199 931	CQ92M1H683J (MRZ)	0.068 μF/50V ±5%
C743,744	255 4219 921	CQ09P1H821J (PDH)	820pF/50V ±5%
745,746	255 4218 922	CQ09P1H331J	330pF/50V ±5%

Ref. No.	Part No.	Part Name	Remarks
C747~750	255 4199 973	CQ92M1H103J (MRZ)	0.01 μF/50V ±5%
C753,754	254 1251 937	CQ92M1H332J (MR2)	3300pF/50V ±5%
RELAY COIL TRANS			
L601	235 0027 003	INDUCTOR (47 μH)	
L602~605	235 0025 047	INDUCTOR (2.2 μH)	
L606,607	235 0025 089	INDUCTOR (4.7 μH)	
T601	231 8060 002	PULSE TRANS	
RL701	214 0127 003	RELAY (RY-12W)	
OTHER PARTS			
XT601	399 0036 026	X'TAL (20 MHz)	1
PJ601	204 8252 009	3P PIN JACK	1
PJ602	204 8251 000	1P PIN JACK	1
	202 0022 008	FUSE HOLDER	4
F601,602	206 1015 016	FUSE (1.25A)	2
FB601~603	235 9006 009	BL02RN1-R62	3
	205 0185 054	5P WIRE HOLDER	CN-D1
	205 0185 070	7P WIRE HOLDER	CND1
	205 0190 036	3P NH CONNECTOR	CN-D6
	205 0233 058	5P EH CONNECTOR	CND17
	205 0275 029	12P EH CON. BASE	CN-D1
	203 0226 056	1P CONTACT Ass'y	L=60
	203 0226 072	1P CONTACT Ass'y	L=40
	204 6277 002	12P EH-SCN CON.	L=190
	204 2313 009	7P EH-SCN CON.	L=240
	204 2314 008	8P EH-SCN CON.	L=340
	204 2315 007	10P EH-SCN CON.	L=200

PARTS LIST KU-9161D for ASIA

[Same as KU-9161B (for EUROPE) except the followings]

PARTS LIST KU-9161E for U.S.A. and CANADA

[Same as KU-9161B (for EUROPE) except the followings]

Ref. No.	Part No.	Part Name	Remarks
SEMICONDUCTORS GROUP			
TR451	2750043030	2SK381 (D/E)	ADD
TR452	2750054003	2SJ103 (BL/V)	ADD
TR453,455 456,458	2730198015	2SC1815 (BL)	ADD
D451,452	2760049011	1S2076A	ADD
RESISTORS (not included Carbon Film ±5% 1/4W type)			
△R1	2440038025	RS14B3A561JNBF	560ohm/1W ADD
△R470	2412387940	RD14B2E4R7JNBST	4.7ohm/1/4W ADD
CAPACITORS			
△C3	2538014702	CK45F2GAC103MC	0.01 μF/400V AC ADD
C451,452	2544254941	CE04W1C101 (SME)	100 μF/16V ADD
C453~455	2544254967	CE04W1C331 (SME)	330 μF/16V ADD
C456	2531024003	CK45F1H103Z	0.01 μF/50V ADD
RELAY			
RL1	2140117000	RELAY (VS48MBUL TV-5)	OUTLET RELAY ADD
OTHER PARTS			
F1	2061053007 5130711015	FUSE 1.0A FUSE LABEL (T500MA)	CHANGE for F1 DELETE
F2	2061035012 2020022008 2030228085	FUSE 5A (T) FUSE HOLDER 1P CONTACT Ass'y	ADD ADD D.I.WIRE L=60 CHANGE
PJ451,452	2034482029 2048247030	3P KR-DS CONN. CORD 2P PIN JACK	CN-9 L=120 ADD VIDEO I/O ADD

Ref. No.	Part No.	Part Name	Remarks
SEMICONDUCTORS GROUP			
TR451	2750043030	2SK381 (D/E)	ADD
TR452	2750054003	2SJ103 (BL/V)	ADD
TR453,455 456,458	2730198015	2SC1815 (BL)	ADD
TR454,457	2710102021	2SA1015 (GR)	ADD
D451,452	2760049011	1S2076A	ADD
RESISTORS (not included Carbon Film ±5% 1/4W type)			
△R1	2440038025	RS14B3A561JNBF	560ohm/1W ADD
△R470	2412387940	RD14B2E4R7JNBST	4.7ohm/1/4W ADD
CAPACITORS			
△C3	2538014702	CK45F2GAC103MC	0.01 μF/400V AC ADD
C451,452	2544254941	CE04W1C101M (SME)	100 μF/16V ADD
C453~455	2544254967	CE04W1C331M (SME)	330 μF/16V ADD
C456	2531024003	CK45F1H103Z (DD-3)	0.01 μF/50V ADD
RELAY			
RL1	2140117000	RELAY (VS48MBUL TV-5)	OUTLET RELAY ADD
OTHER PARTS			
F1	2061039034 5130711015	FUSE 1A FUSE LABEL (T500MA)	CHANGE for F1 DELETE
F2	2061048027 2020022008 2034482029	FUSE 5A FUSE HOLDER 3P KR-DS CONN. CORD	ADD ADD CN-9 L=120 ADD
PJ451,452	2048247030	2P PIN JACK	VIDEO I/O ADD

PARTS LIST 1U-1991B for U.S.A. and CANADA

[Same as 1U-1991A (for EUROPE) except the followings]

PARTS LIST 1U-1991C for ASIA

[Same as 1U-1991A (for EUROPE) except the followings]

Ref. No.	Part No.	Part Name	Remarks	Q'ty
OTHER PARTS				
F601,602	2061039047	FUSE 1.25A	UL, CSA CHANGE	2
	5130854066	FUSE LABEL	for F601,F602 ADD	2

Ref. No.	Part No.	Part Name	Remarks	Q'ty
OTHER PARTS				
F601,602	2061035025 5130854066	FUSE 1.25A (T) FUSE LABEL	Interior CHANGE for F601, F602 ADD	2 2

WARNING:
Parts marked with this symbol Δ have critical characteristics.
Use ONLY replacement parts recommended by the manufacturer.

KU-9160B PRE AMP UNIT

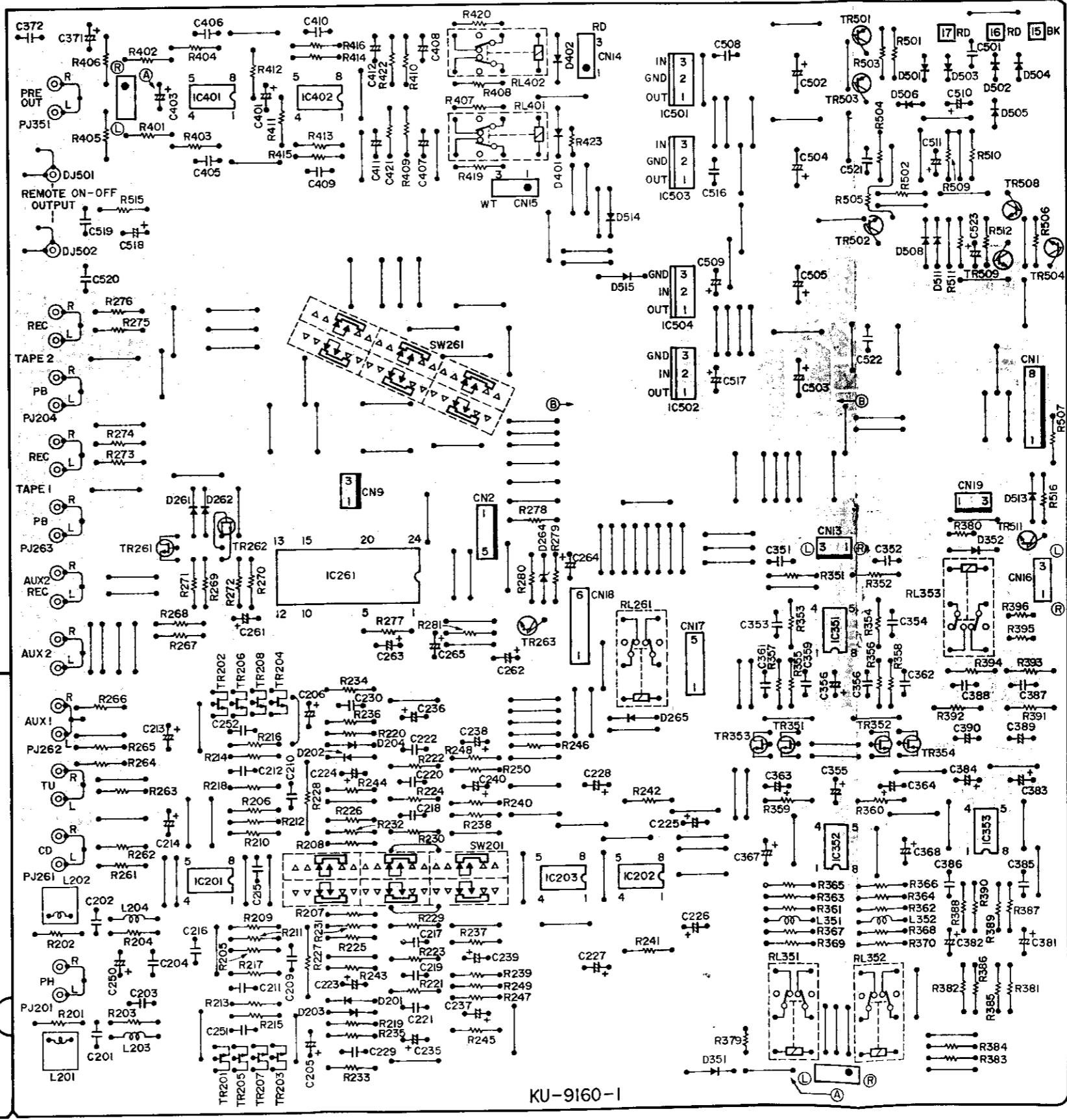
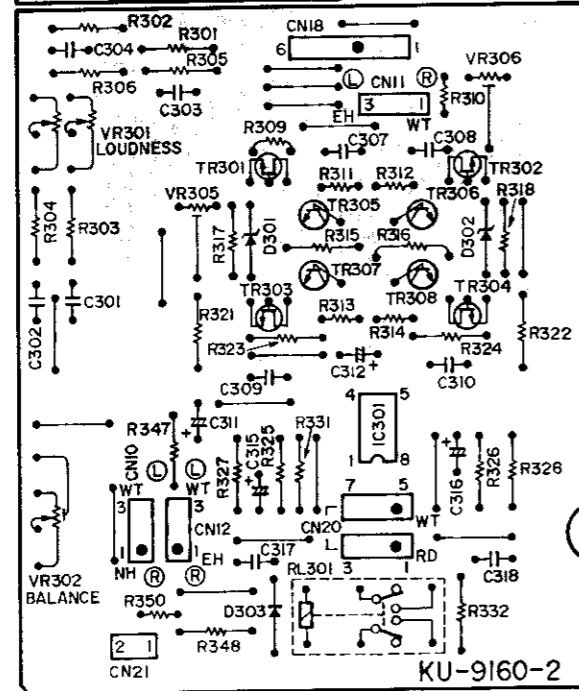
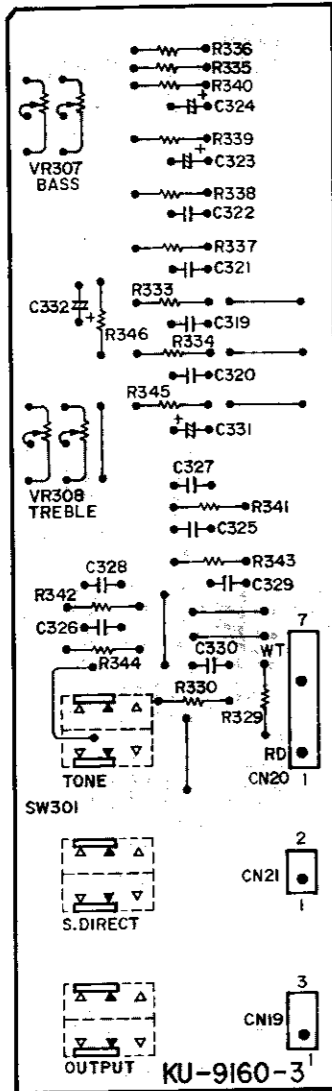

207

1U-1991A DIG. INPUT UNIT

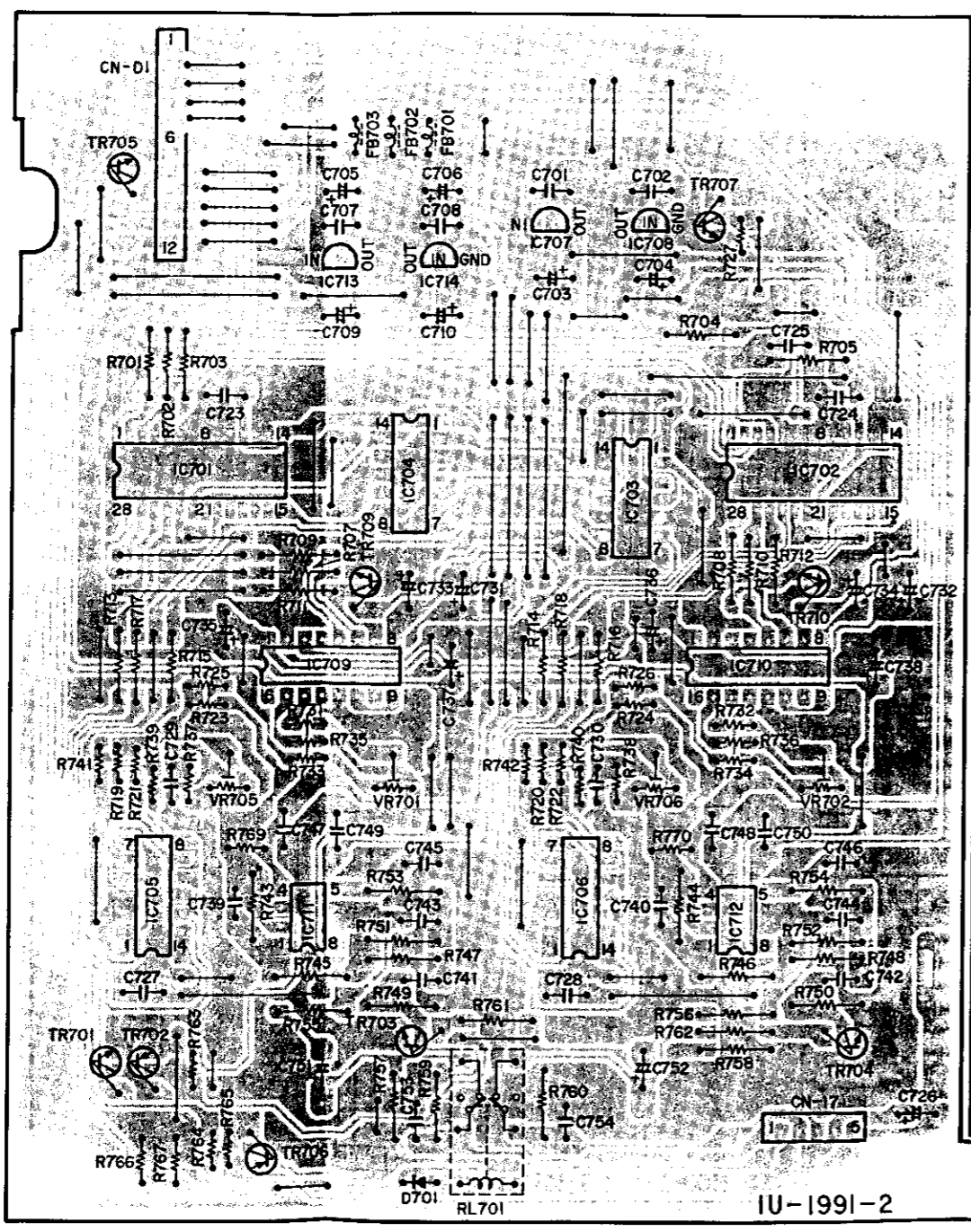

IU-1991-2

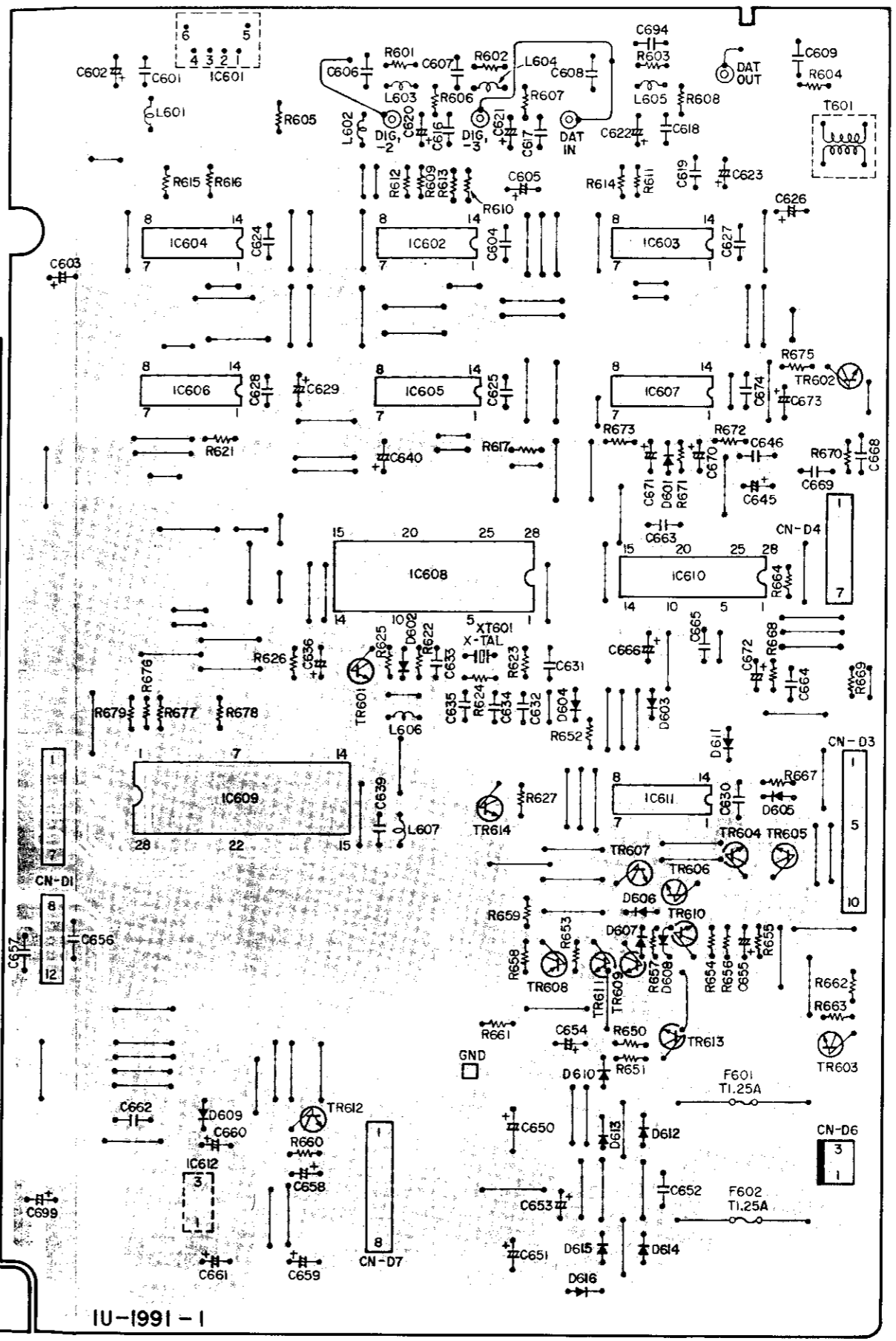

IU-1991-1

KU-9161B CONTROL UNIT

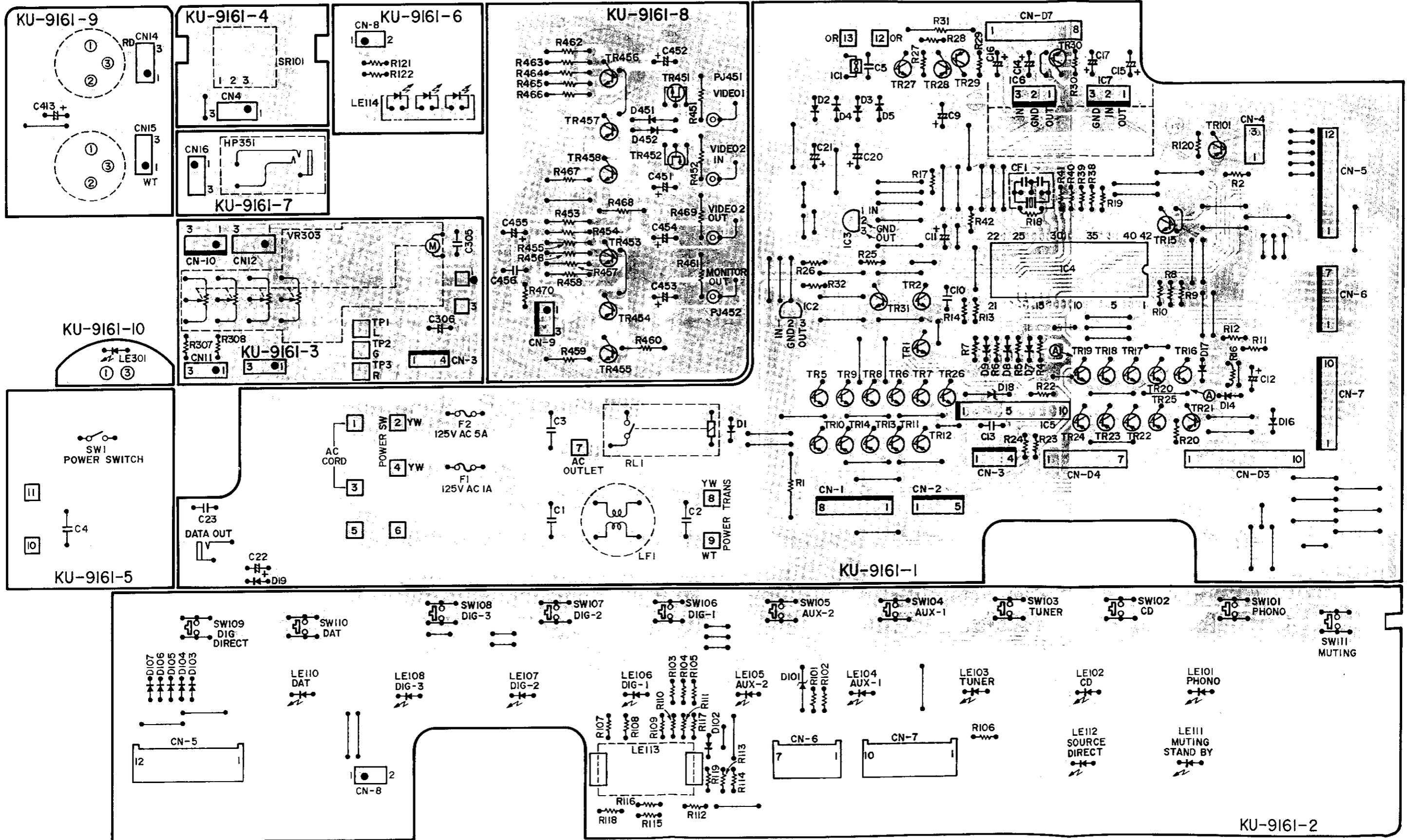

EXPLODED VIEW OF CHASSIS AND CABINET & PARTS LIST
• EXPLODED VIEW OF CHASSIS AND CABINET

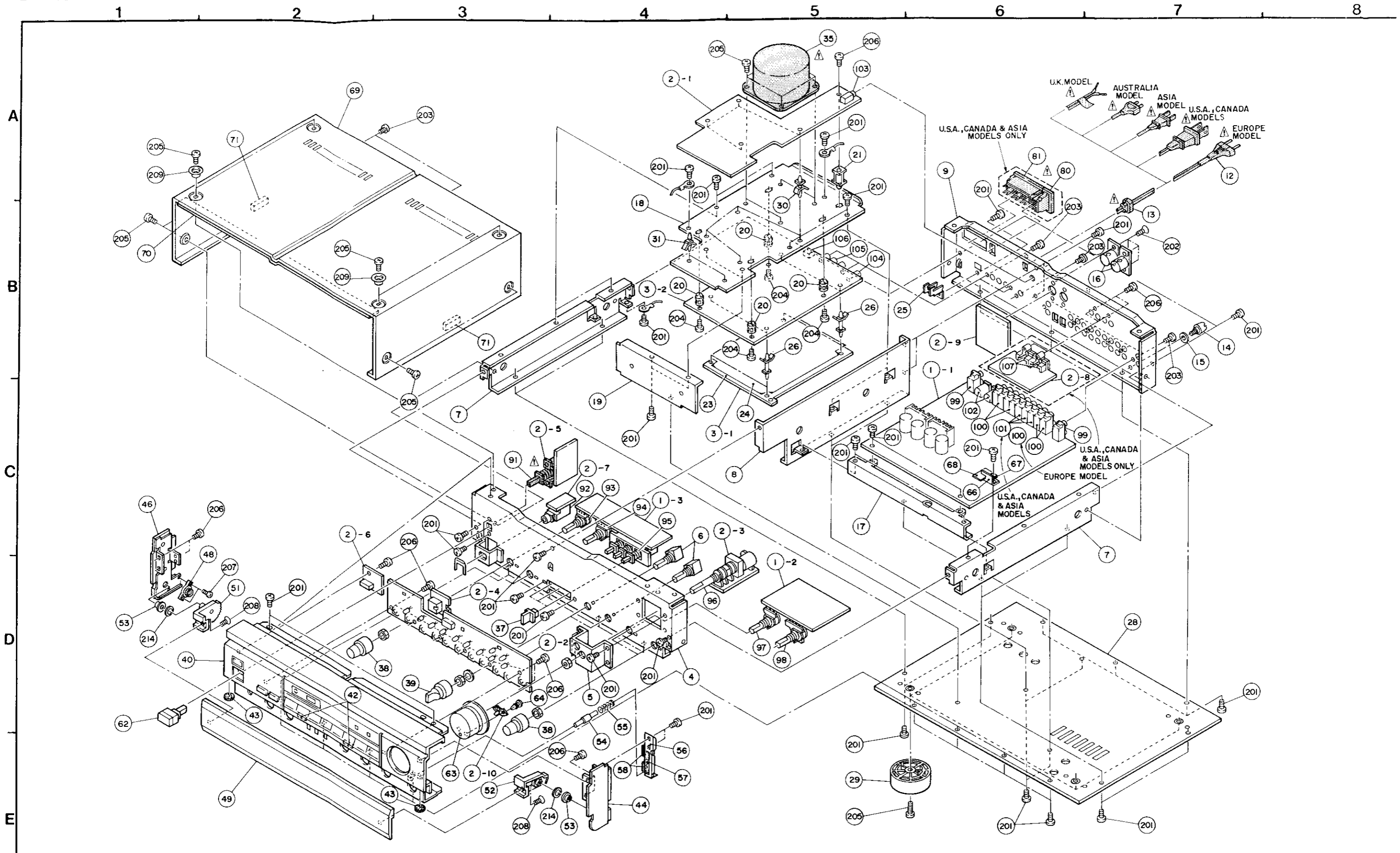

• PARTS LIST OF EXPLODED VIEW

WARNING:

Parts marked with this symbol  have critical characteristics. Use ONLY replacement parts recommended by the manufacturer.

Ref. No.	Part No.	Part Name	Remarks	Q'ty	Ref. No.	Part No.	Part Name	Remarks	Q'ty	
⊙	1	KU-9160B	PRE AMP UNIT	1	48	4210261004	MINI DAMPER		1	
⊙	2	KU-9161B	CONTROL UNIT	1	49	1441982003	DOOR		1	
⊙	3	1U-1991A	DIG. INPUT UNIT	1	50	—	—		—	
⊙	4	4119066106	FRONT CHASSIS Ass'y	1	51	4019003007	HINGE (L)		1	
⊙	5	4129206105	VR BRACKET	1	52	4019004006	HINGE (R)		1	
6	2123614038	ROTARY REMOTE SWITCH		2	53	4259002004	BEARING		2	
⊙	7	4119064001	SIDE CHASSIS	2	54	1139205102	DOOR KNOB		1	
⊙	8	4119063002	CENTER CHASSIS	1	55	4630182080	SPRING	for DOOR KNOB	1	
9	1050889005	BACK PANEL		1	56	4639059004	SPRING PLATE		1	
★	10	5139172008	BLIND SHEET		57	1229013039	SPACER		1	
★	11	1259002052	UL TUBE	4.12×37 BLACK	2	58	4619009058	DAMP SHEET (C)		2
△	12	2062063009	AC CORD WITH PLUG	1	⊙★	59	2042316006	7P PH-PH CONN. CORD	L=240 CN-6	1
△	13	4450056008	CORD BUSH	1	⊙★	60	2042317005	10P PH-PH CONN. CORD	L=240 CN-7	1
14	2050071016	TERMINAL Ass'y		1	⊙★	61	2046212009	12P PH-PH CONN. CORD	L=200 CN-5	1
15	4770018001	WASHER (P-87)		1	62	1139198002	P.KNOB(P) Ass'y		1	
16	2050506002	3P CANNON CONNECTOR		2	63	1129067004	VR KNOB Ass'y		1	
⊙	17	4129205009	CENTER FRAME	1	64	4770096007	PUSH RIVET		1	
⊙	18	4149071103	SHIELD PLATE (D)	1	⊙★	65	2099001018	TWIN VINYL WIRE Ass'y	L=250 for VOL. LED	1
⊙	19	4149072005	SHIELD BRACKET	1	⊙	66	4129210007	P.W.B. BRACKET		1
20	4439015002	P.W. SPACER		4	⊙	67	4619012016	CUSHION		1
21	4159032006	P.C.B. HOLDER (T)		1	⊙	68	4159018033	INSULATING SHEET		1
22	—	—		—	69	1029030005	TOP COVER		1	
⊙	23	4149059002	PWB SHIELD PLATE	1	70	1229006004	SPACER		1	
⊙	24	4159040001	INSULATION SHEET	1	71	4619001001	RUBBER SHEET		2	
25	4129102115	TORX SUPPORT		1	91	2120286003	POWER SW	SW001	1	
26	4159016048	P.C.B. HOLDER		4	92	2048253008	HEADPHONE JACK	HP351	1	
★	27	4458004007	WIRE CLAMPER	7	93	2119075005	V1620V20FC303K	VR307	1	
28	1059126109	BOTTOM COVER		1	94	2119075018	V1620V20FC502K	VR308	1	
29	1040194001	FOOT Ass'y		4	95	2129547015	3P PUSH SWITCH	SW301	1	
30	4159018006	P.C.B. HOLDER		5	96	2119081002	V1640V30FR...R	VR303	1	
31	4159016019	P.C.B. HOLDER		2	97	2119074006	V1620V20FB104	VR301	1	
⊙★	32	2036253007	4P PH-PH CONN. CORD	L=350 CN-3	1	98	2119073007	V16V20FB254T	VR302	1
⊙★	33	2038232000	5P PH-PH CONN. CORD	L=350 CN-2	1	99	—	—	—	
⊙★	34	2038212017	5P EH-EH CONN. CORD	L=400 CN-17	1	100	—	—	—	
△	35	2339596005	POWER TRANS		101	—	—	—	—	
⊙★	36	0019016072	D.I WIRE	YW390	2	102	2048289001	DC POWER JACK	DJ501.5(2) REMOTE	2
37	1139071006	PUSH KNOB (T) TONE, SOURCE DIRECT OUTPUT		3	103	2048260004	MINI JACK	MJ001	1	
38	1129056002	KNOB Ass'y BASS TREBLE VARIABLE LOUDNESS		4	104	2048251000	1P PIN JACK	PJ602	1	
39	1129058000	KNOB Ass'y MONITOR/COPY PHONO SELECTOR		2	105	2048252009	3P PIN JACK	PJ601	1	
40	GEN0944	FRONT PANEL Sub Ass'y		1	106	2690044005	TORX-172 OPTICAL CONNECTOR	IC601	1	
41	—	—		—	SCREWS & NUTS					
42	4159018046	INSULATING SHEET		2	201	4737002034	TAPPING SCREW (S) 3×6 (BLACK)		51	
43	1040034006	STOPPER		2	202	4737012008	CROSS-RECESSED HEAD TAPPING SCREW (S)3×10		4	
44	GEN7051	SP. (R) Sub Ass'y		1	203	4770064107	FIXING SCREW		9	
45	—	—		—	204	4737501014	TAPPING SCREW (P)3×14		4	
46	GEN7052	SP. (L) Sub Ass'y		1	205	4737007000	TAPPING SCREW (S) 4×8 (BLACK)		16	
47	—	—		—						

Ref. No.	Part No.	Part Name	Remarks	Q'ty	Ref. No.	Part No.	Part Name	Remarks	Q'ty
206	4737500044	TAPPING SCREW (P) 3×8 (BLACK)		13	301	5040063060	STYLEN PAPER	T0.5×460×50	1
207	4737000052	TAPPING SCREW (S) 2×4		2	302	5139177003	NOTICE SHEET		1
208	4712801030	CROSS-RECESSED HEAD MACHINE SCREW 3×5 (BLACK)		2	303	5049102003	STYLEN PAPER	T0.5×800×650	1
209	1469116000	SCREW CUP		4	304	5059102006	POLY COVER	820W×400D	1
214	4770195005	WASHER	for HINGE	2	305	5039176007	CUSHION Ass'y		
					306	5019157062	CARTON CASE	K280×SX K280W	1
					307	5058006019	ENVELOPE		1
					308	5119255204	INST MANUAL		1
					309	2048121004	2P PIN CORD		1
					310	3999022002	REMOTE CONTROLLER RC-110		1

NOTE ON PARTS LIST

- Part indicated with the mark "⊙" are not always in stock and possibly to take a long period of time for supplying, or in some case supplying of part may be refused.
- When ordering of part, clearly indicate "1" and "I" (I) to avoid mis-supplying.
- Ordering part without stating its part number can not be supplied.
- Part indicated with the mark "★" is not illustrated in the exploded view.

WARNING:

Parts marked with this symbol  have critical characteristics.
Use ONLY replacement parts recommended by the manufacturer.

PARTS LIST OF EXPLODED VIEW (DAP-2500 EUROPE GOLD VERSION)

[Same as parts list of BLACK VERSION except the followings]

Ref. No.	Part No.	Part Name	Remarks	Q'ty
37	1139071019	PUSH KNOB (T)		3
38	1129056015	KNOB Ass'y		4
39	1129058013	KNOB Ass'y		2
40	GEN0944-01	FRONT PANEL SUB ASS'Y		1
44	GEN7051-01	SP. (R) Sub Ass'y		1
46	GEN7052-01	SP. (L) Sub Ass'y		1
49	1441982016	DOOR		1
51	4019003010	HINGE (L)		1
52	4019004019	HINGE (R)		1
53	4259002017	BEARING		2
54	1139205115	DOOR KNOB		1
62	1139198015	P.KNOB (P) Ass'y		1
63	1129067017	VR KNOB Ass'y		1
69	1029030018	TOP COVER		1
205	4737014006	TAPPING SCREW (S) 4x8 (MFCR)		8
208	4712302050	CROSS-RECESSED HEAD MACHINE SCREW 3x5 (CFS-N)		2
209	1469116039	SCREW CUP		4
306	5011426005	CARTON CASE		1
316	5139111001	COLOR LABEL (GOLD)		2

ADDENDUM LIST

WARNING:
Parts marked with this symbol  have critical characteristics.
Use ONLY replacement parts recommended by the manufacturer.

Ref. No.	Part Name & Description	Part No.				Remarks
		U.S.A.	ASIA	CANADA	U.K.	
⊙ 1	PRE AMP UNIT	KU-9160E	KU-9160D	KU-9160E	KU-9160B	
⊙ 2	CONTROL UNIT	KU-9161E	KU-9161D	KU-9161E	KU-9161B	
⊙ 3	DIG. INPUT UNIT	1U-1991B	1U-1991C	1U-1991B	1U-1991A	
9	BACK PANEL	1050889018	1059133118	1059133105	1059134104	
10	BLIND SHEET	-	-	-	5139172008	
11	UL TUBE	-	1259002052(2)	-	1259002052(2)	
△ 12	AC CORD WITH PLUG	-	-	-	-	
	AC CORD (POLARIZED)	2062060002	-	2062060002	-	
	AC CORD	-	2062054005	-	-	
	AC CORD WITH LABEL	-	-	-	2062024006	
△ 35	POWER TRANS	2339595006	2339597004	2339595006	2339598003	
⊙ 36	D.I. WIRE	-	0019016072(2)	-	0019016072(2)	} for AC Switch Use
⊙	V.WIRE	0019013033(2)	-	0019013033(2)	-	
40	FRONT PANEL SUB Ass'y	GEN0944	GEN7049	GEN7049	GEN7049-01	
64	PUSH RIVET	4770096007(3)	4770096007(1)	4770096007(1)	4770096007(1)	
△ 80	AC OUTLET	2033915005	2033915005	2033915005	-	
△ 81	AC OUTLET (POLARIZED)	2033939007	2033939007	2033939007	-	
82	DANGEROUS MARK	5138266009	-	-	-	
83	FUSE LABEL	5139194002	-	5139194002	-	
84	VOLTAGE SEL SWITCH	-	2129555007	-	-	
85	CORD HOLDER (L50)	-	4450048016	-	-	
86	VOLTAGE LABEL	-	-	-	5130362008(2)	
⊙ 87	V.WIRE	0019010052	0019016001	0019010052	-	} for AC Outlets Use and Voltage Selector Switch Use (Asia Model)
⊙ 88	V.WIRE	0019010065	0019005096	0019010065	-	
⊙ 89	V.WIRE	0019010078	0019016014	0019010078	-	
⊙ 90	V.WIRE	0019010081	0019016027	0019010081	-	
206	TAPPING SCREW (P) 3x8 (BLACK)	4737500044(15)	4737500044(15)	4737500044(15)	4737500044(13)	
308	INST MANUAL	5119254108	5119254108	5119254108	5119255204	
310	RM CONTROLLER RC-110	-	-	-	3999022002	
	RM CONTROLLER RC-109	3999021003	3999021003	3999021003	-	
311	UL LABEL	5130772009	-	-	-	
312	DAI WARRANTY HOME	5150418301	-	-	-	
313	PRESET LABEL	-	5158030008	-	-	
314	DCI WARRANTY	-	-	5150388004	-	
315	CAUTION SHEET	-	-	-	5130364006	

WIRING DIAGRAM

(This figure is specifications of Europe)

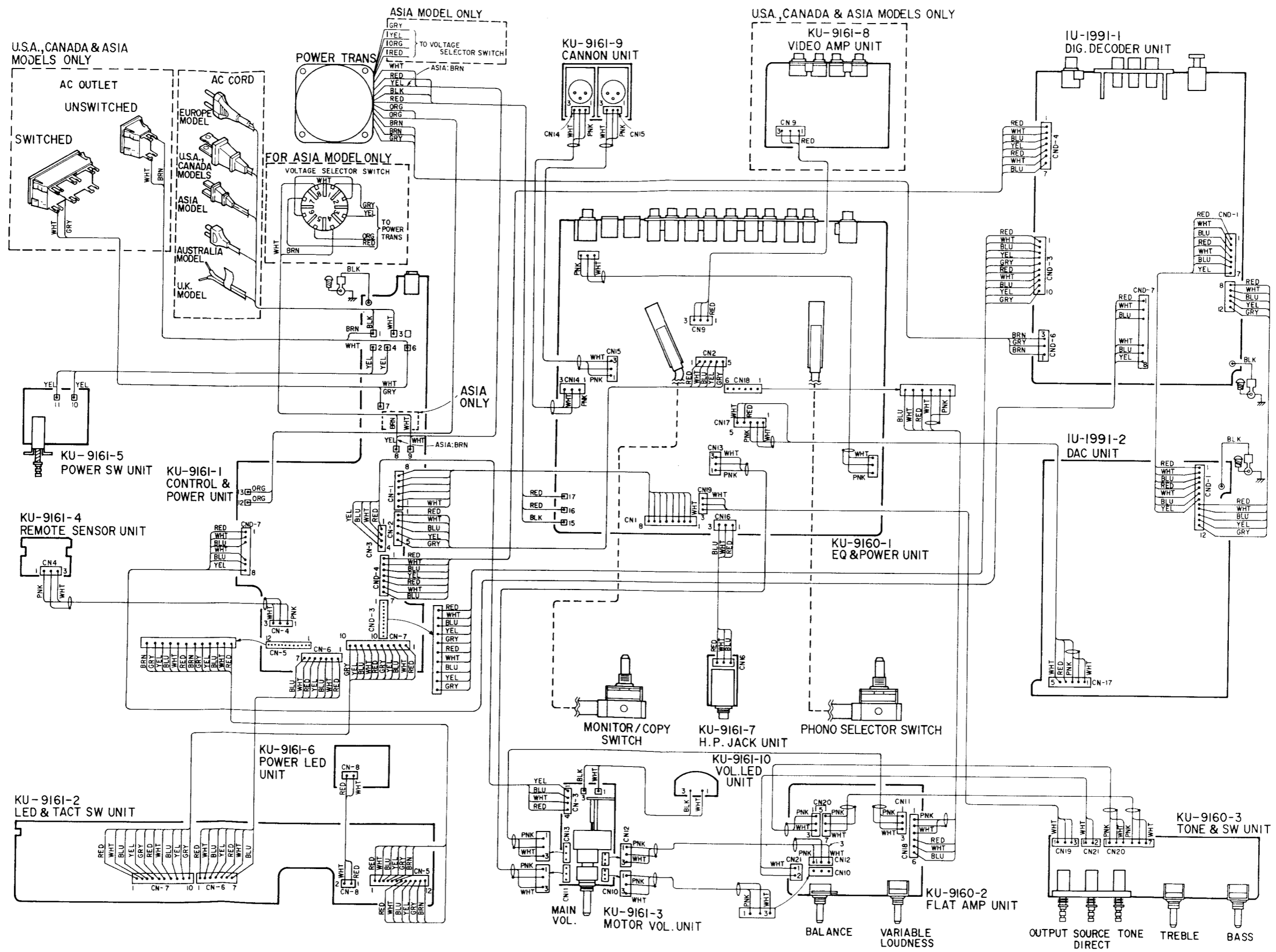

SCHEMATIC DIAGRAM (ANALOG UNIT)

1

2

3

4

5

6

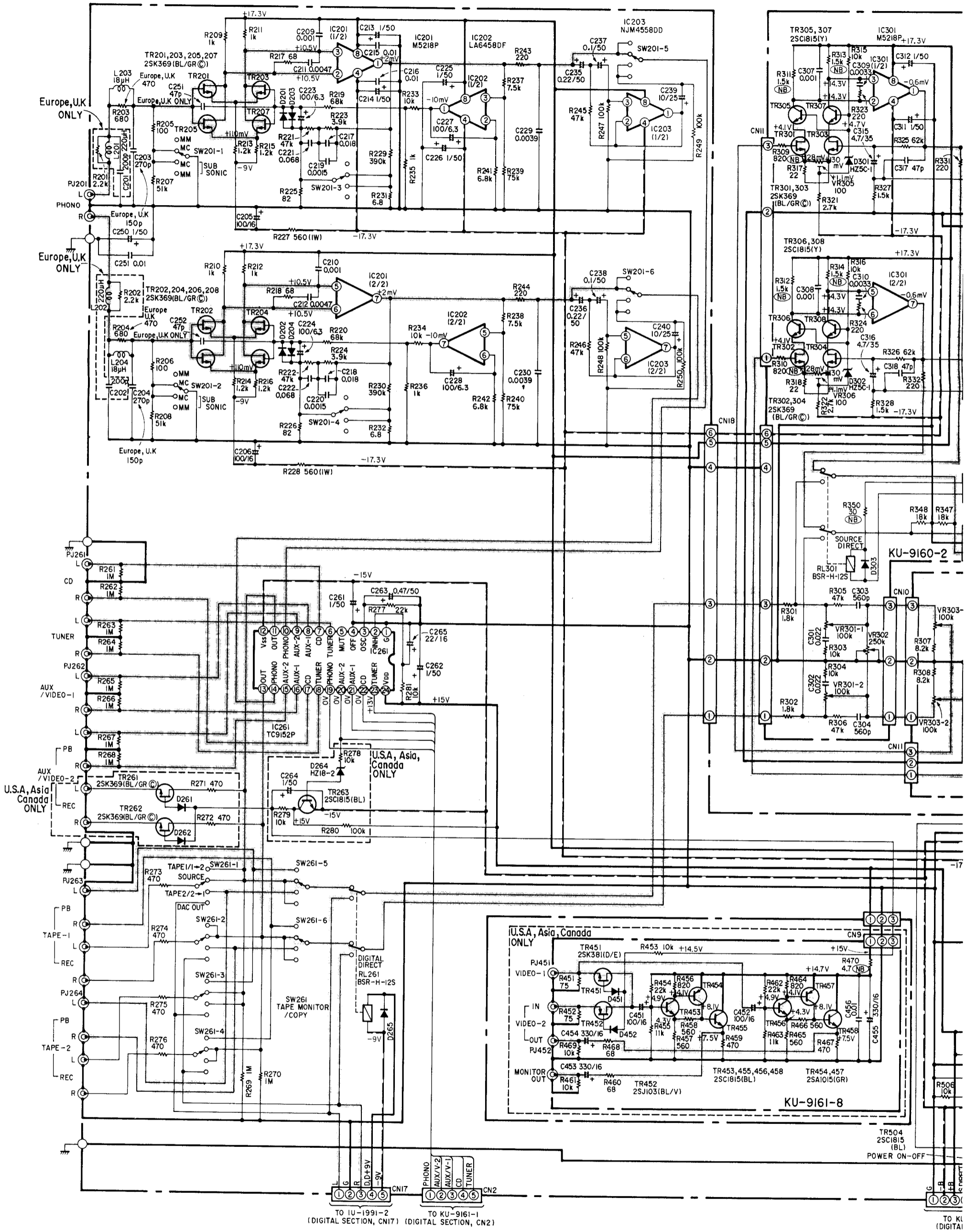

TO IU-1991-2 (DIGITAL SECTION, CN17) TO KU-9161-1 (DIGITAL SECTION, CN2)

NOTES
 ALL RESISTANCE VALUES IN OHM K - 1
 ALL CAPACITANCE VALUES IN MICRO F.
 EACH VOLTAGE AND CURRENT ARE MEASUREMENTS.
 CIRCUIT AND PARTS ARE SUBJECT TO CHANGE WITHOUT NOTICE.

6 7 8 9 10 11

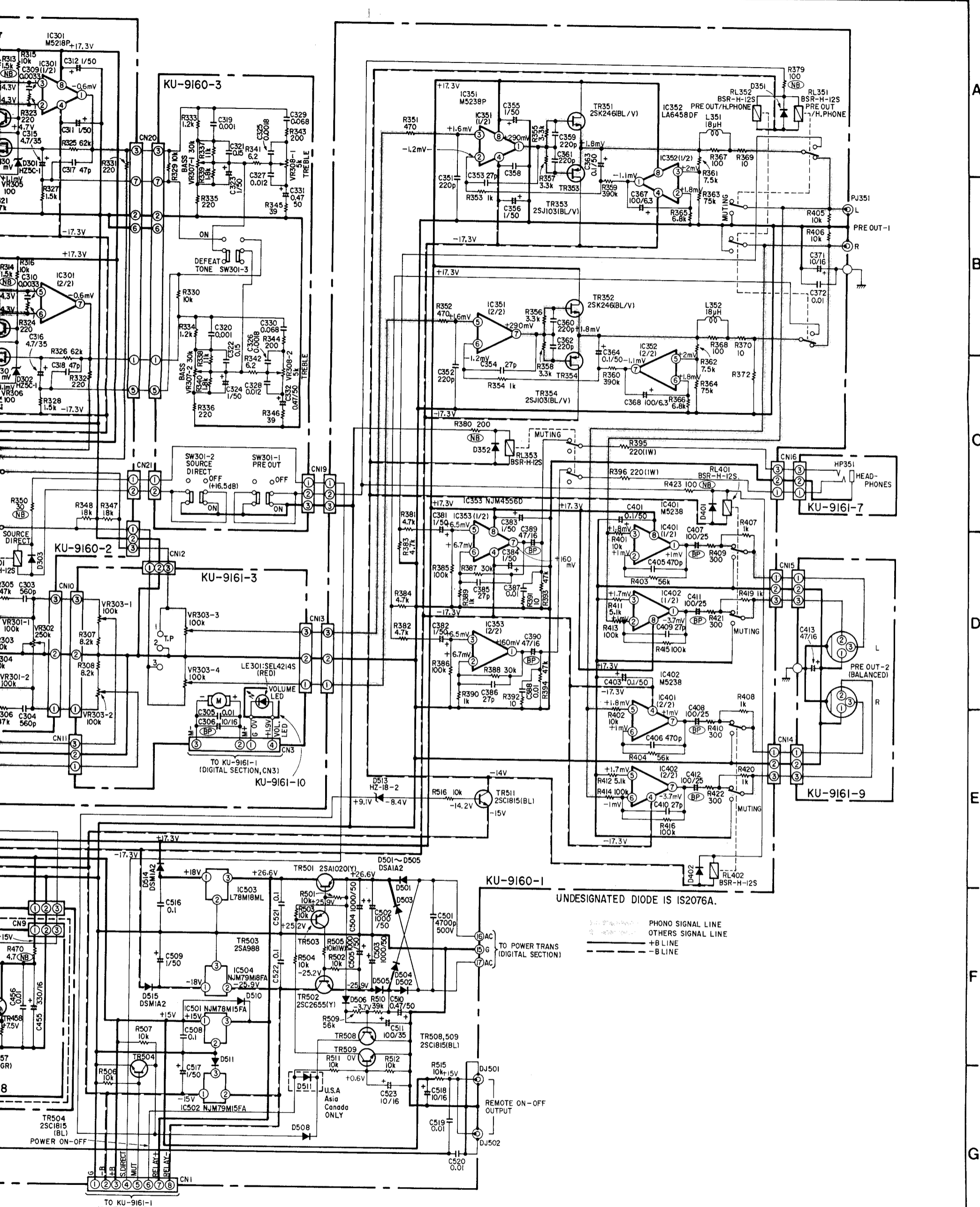

A
B
C
D
E
F
G
H

UNDESIGNATED DIODE IS IS2076A.

PHONO SIGNAL LINE
OTHERS SIGNAL LINE

TO POWER TRANS (DIGITAL SECTION)

TO KU-9161-1 (DIGITAL SECTION, CN1)

WARNING:
Parts marked with this symbol have critical characteristics. Use ONLY replacement parts recommended by the manufacturer.

CAUTION:
Before returning the unit to the customer, make sure you make either (1) a leakage current check or (2) a line to chassis resistance check. If the leakage current exceeds 0.5 millamps, or if the resistance from chassis to either side of the power cord is less than 240 k ohms, the unit is defective.

WARNING:
DO NOT return the unit to the customer until the problem is located and corrected.

RESISTANCE VALUES IN OHMS K = 1,000 OHMS M = 1,000,000 OHMS
CAPACITANCE VALUES IN MICRO FARAD P = MICROFARAD
VOLTAGE AND CURRENT ARE MEASURED AT NO SIGNAL INPUT CONDITION
AND PARTS ARE SUBJECT TO CHANGE WITHOUT PRIOR NOTICE.

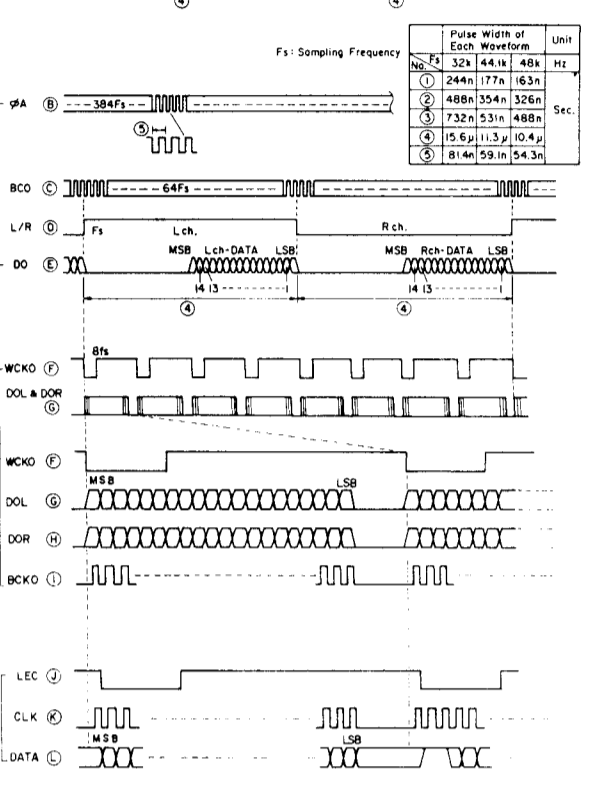
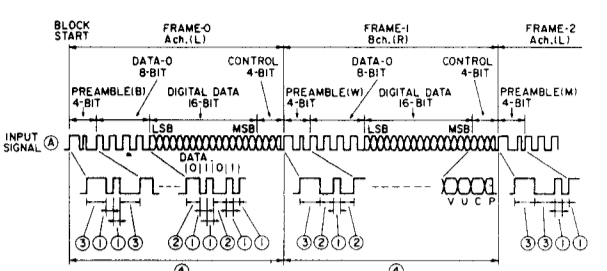
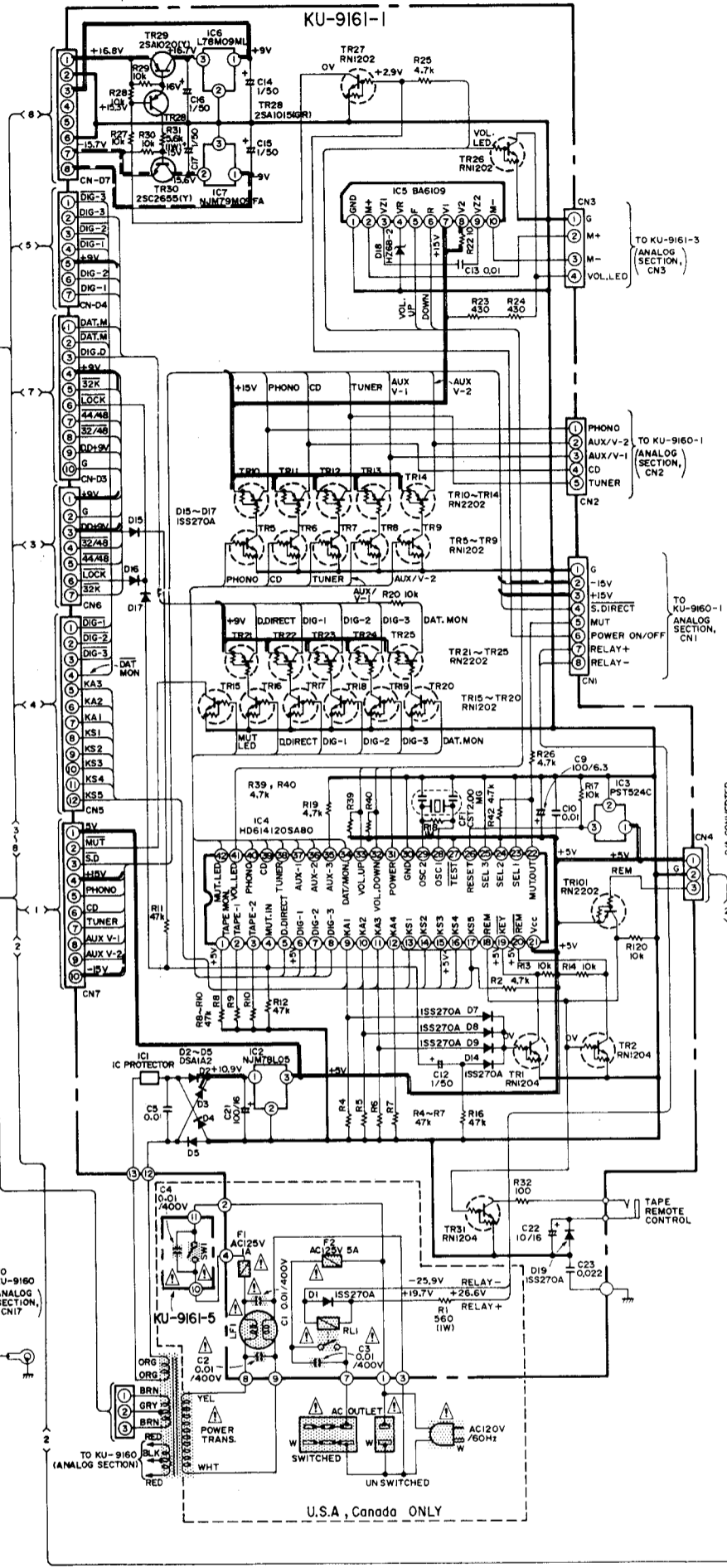
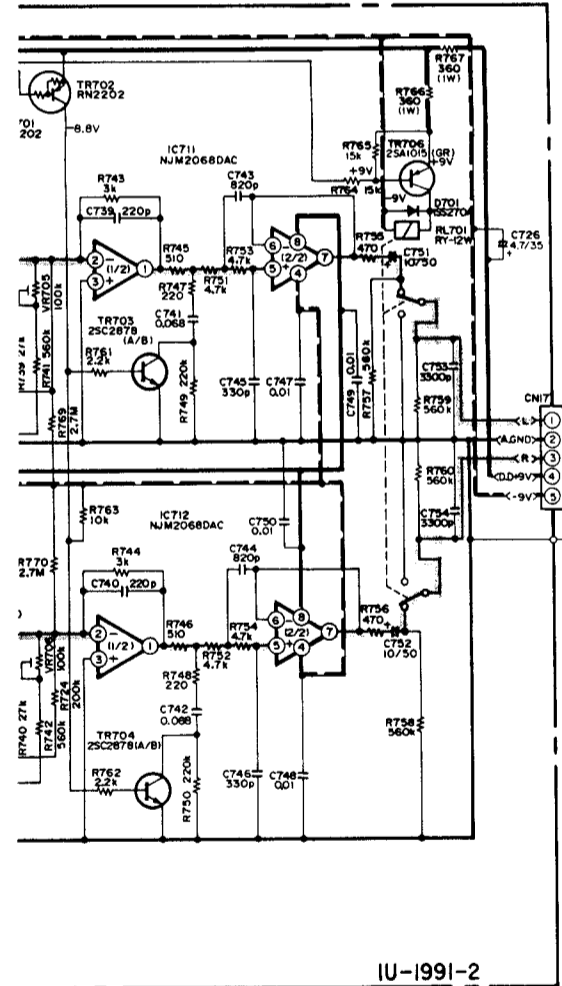
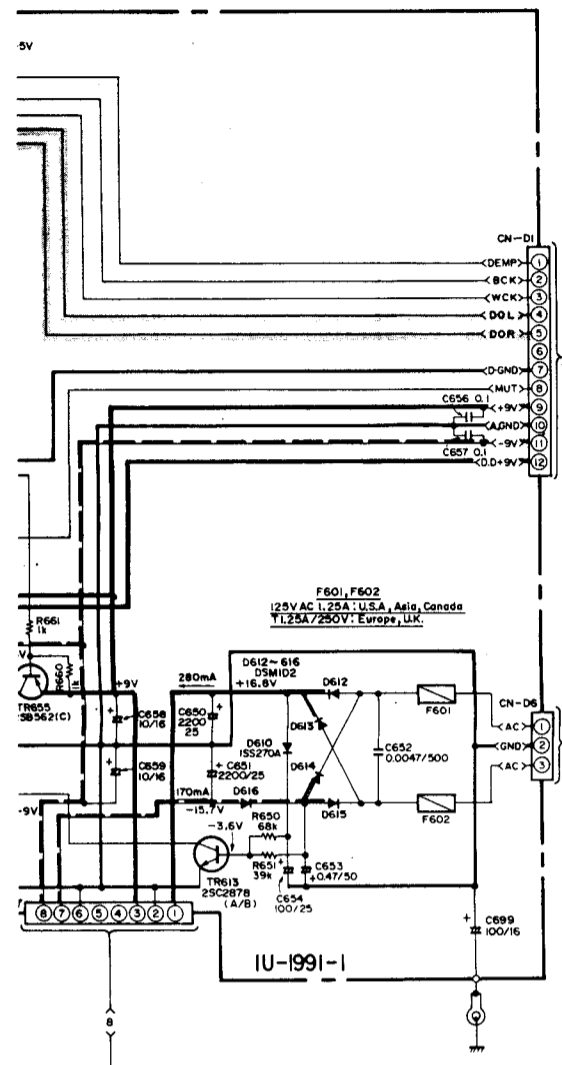

MEASURING CONDITIONS
 DIGITAL DIRECT SWITCH - ON
 DIGITAL - 1
 NO SIGNAL INPUT

--- DIGITAL-1 SIGNAL LINE
 --- DIGITAL-2/-3/DAT SIGNAL LINE
 --- +B LINE
 --- -B LINE

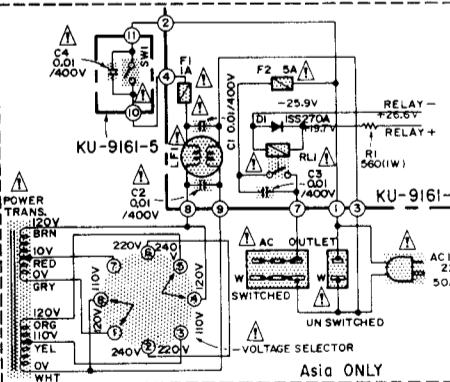
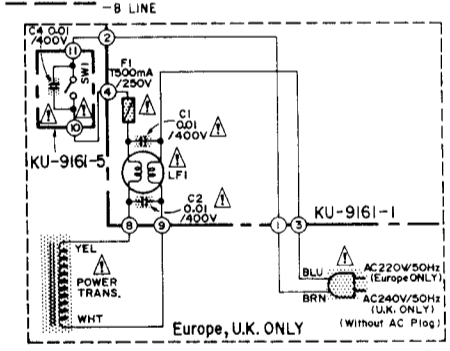

M = 1,000,000 OHM
 MICRO-MICRO FARAD
 T NO SIGNAL INPUT CONDITION.
 THOUT PRIOR NOTICE

SCHEMATIC DIAGRAM (DIGITAL UNIT)

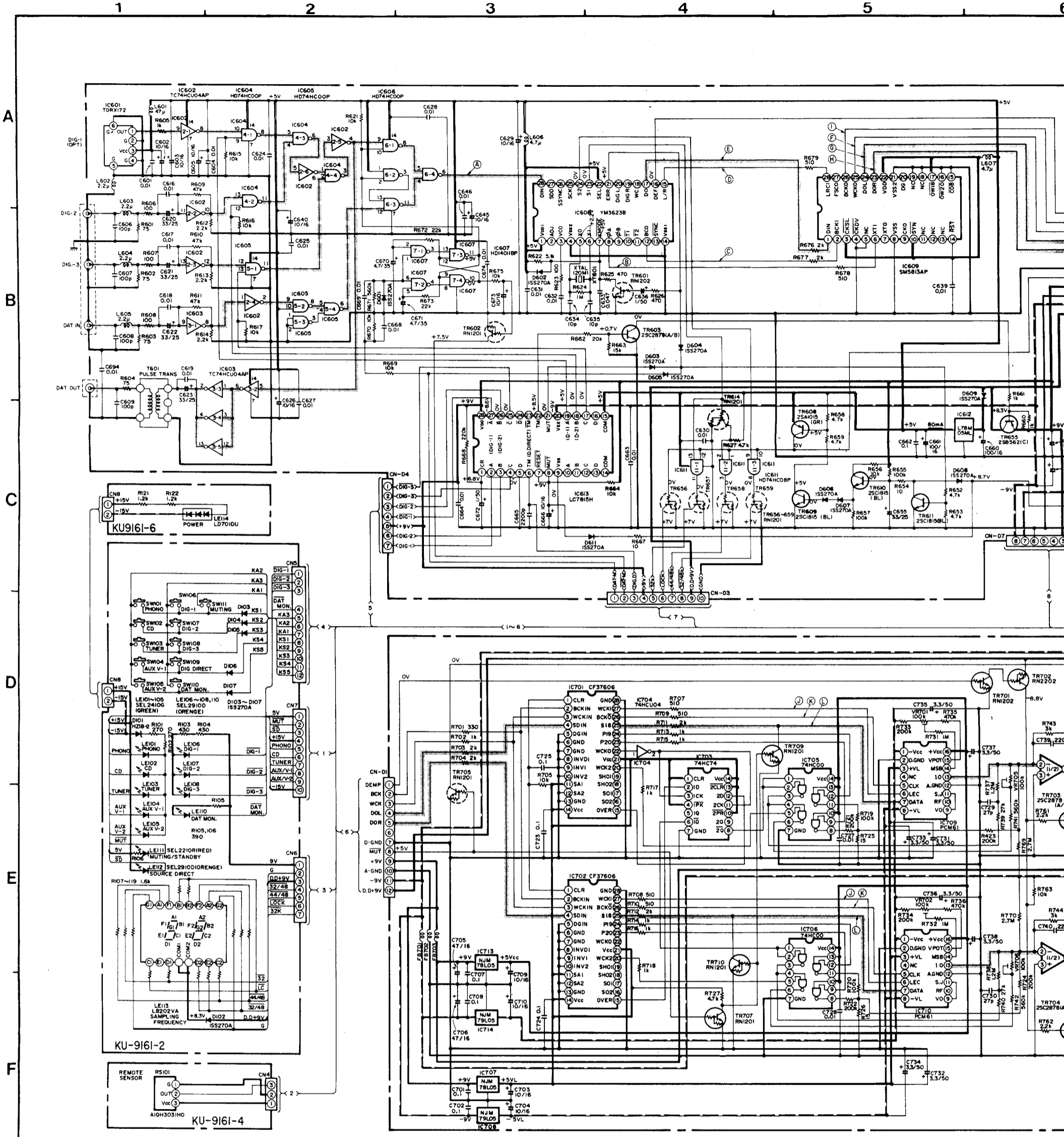

WARNING:
Parts marked with this symbol  have critical characteristics. Use ONLY replacement parts recommended by the manufacturer.

CAUTION:
Before returning the unit to the customer, make sure you make either (1) a leakage current check or (2) a line to chassis resistance check. If the leakage current exceeds 0.5 milliamperes, or if the resistance from chassis to either side of the power cord is less than 240 k ohms, the unit is defective.

WARNING:
DO NOT return the unit to the customer until the problem is located and corrected.

NOTES
ALL RESISTANCE VALUES IN OHM K = 1,000 OHM M = 1,000,000 OHM
ALL CAPACITANCE VALUES IN MICRO FARAD P = MICRO-MICRO F
EACH VOLTAGE AND CURRENT ARE MEASURED AT NO SIGNAL IF
CIRCUIT AND PARTS ARE SUBJECT TO CHANGE WITHOUT PRIOR NOTICE