

DENON

Hi-Fi Component

SERVICE MANUAL

STEREO CD PLAYER

MODEL DCD-2560



TABLE OF CONTENTS

OPERATING INSTRUCTIONS	2 ~ 14
SPECIFICATIONS	15
NOTE FOR HANDLING OF LASER PICK-UP	16 ~ 17
DISASSEMBLY	18 ~ 19
ADJUSTMENT	20 ~ 25
HEAT RUN MODE FUNCTION	26
IC TERMINAL FUNCTION LIST	27 ~ 31
PARTS LIST OF P.W.BOARD	32, 33
PARTS LIST OF EXPLODED VIEW	34
PARTS LIST OF PACKING & ACCESSORIES	34
EXPLODED VIEW	35
EXPLODED VIEW OF MECHA UNIT	36
PARTS LIST OF MECHA UNIT	36
P.W.BOARD	37, 38
WIRING DIAGRAM	39
SEMICONDUCTORS	40
SCHEMATIC DIAGRAM	41

NIPPON COLUMBIA CO., LTD.

IMPORTANT TO SAFETY

WARNING:

TO PREVENT FIRE OR SHOCK HAZARD, DO NOT EXPOSE THIS APPLIANCE TO RAIN OR MOISTURE.

CAUTION:

- Handle the power supply cord carefully**
Do not damage or deform the power supply cord. If it is damaged or deformed, it may cause electric shock or malfunction when used. When removing from wall outlet, be sure to remove by holding the plug attachment and not by pulling the cord.
- Do not open the top cover**
In order to prevent electric shock, do not open the top cover. If problems occur, contact your DENON DEALER.
- Do not place anything inside**
Do not place metal objects or spill liquid inside the CD player. Electric shock or malfunction may result.

NOTE:

This CD player uses the semiconductor laser. To allow you to enjoy music at a stable operation, it is recommended to use this in a room of 5°C - 35°C.

LABELS (for U.S.A. model only)

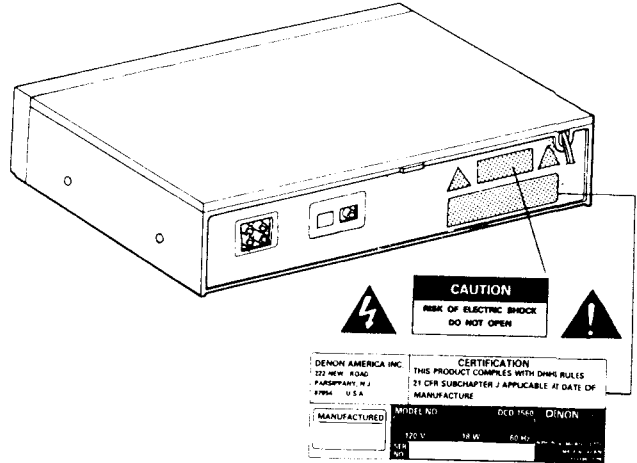

CAUTION:

USE OF CONTROLS OR ADJUSTMENTS OR REPERFORMANCE OF PROCEDURES OTHER THAN THOSE SPECIFIED HEREIN MAY RESULT IN HAZARDOUS RADIATION EXPOSURE.

THE COMPACT DISC PLAYER SHOULD NOT BE ADJUSTED OR REPAIRED BY ANYONE EXCEPT PROPERLY QUALIFIED SERVICE PERSONNEL.

NOTE:

This unit may cause interference to radio and television reception if you do not operate it in strict accordance with this OPERATING INSTRUCTIONS.

This unit complies with Class B computing device rules in accordance with the specifications in Sub-part J or Part 15 of the FCC Rules, which are designed to provide reasonable protection against such interference in a residential installation. If the unit does cause interference to any radio or television reception, try to reduce it by one or more of the following means:

- Turn the other unit to improve reception
- Move this unit
- Move this unit away from others
- Plug this unit respectively into a different AC outlet

* This is note in accordance with Section 15.838 of the FCC Rules.



CAUTION

RISK OF ELECTRIC SHOCK
DO NOT OPEN



CAUTION: TO REDUCE THE RISK OF ELECTRIC SHOCK, DO NOT REMOVE COVER (OR BACK). NO USER SERVICEABLE PARTS INSIDE. REFER SERVICING TO QUALIFIED SERVICE PERSONNEL.



The lightning flash with arrowhead symbol within an equilateral triangle is intended to alert the user of the presence of uninsulated "dangerous voltage" within the product's enclosure that may be of sufficient magnitude to constitute a risk of electric shock to persons.



The exclamation point within an equilateral triangle is intended to alert the user of the presence of important operating and maintenance (servicing) instruction in the literature accompanying the appliance.

IMPORTANT (BRITISH MODEL ONLY)

The wires in this mains lead are coloured in accordance with the following code:

Blue: Neutral Brown: Live

The colours of the wires in the mains lead of this apparatus may not correspond with the coloured markings identifying the terminals in your plug proceed as follows.

The wire which is coloured blue must be connected to the terminal which is marked with the letter N or coloured black.

The wire which is coloured brown must be connected to the terminal which is marked with the letter L or coloured red.

Thank you for purchasing this DENON Compact Disc Player. Please read the operating instructions thoroughly in order to acquaint yourself with the CD player and achieve maximum satisfaction from it.

— TABLE OF CONTENTS —

FEATURES	3
NAMES AND FUNCTIONS OF PARTS	4, 5
CONNECTION	6
OPENING AND CLOSING THE DISC HOLDER AND LOADING A DISC	6
NORMAL CD PLAYBACK	6, 7
ADVANCED CD PLAYBACK	7 ~ 12
PLAYBACK USING THE REMOTE CONTROL UNIT	13, 14
SPECIFICATIONS	15

Please check to make sure the following items are included with the main unit in the carton:

- | | |
|--------------------------------------|---|
| (1) Operating Instructions | 1 |
| (2) Connection Cord | 1 |
| (3) Remote Control Unit RC-232 | 1 |
| (4) R6P AA Dry Cell Battery | 2 |
| (5) Mini Screwdriver | 1 |

FEATURES

The DCD-2560G/2560 is a CD player equipped with Denon's unique lambda super linear converter which eliminates loss of sound quality in the PCM playback section, plus carefully selected parts. It reproduces all the sounds of the studio or hall where the compact disc was recorded with high performance and rich musical expression.

- (1) Real 20-bit λ S.L.C.**
The DCD-2560G/2560 uses a new " λ S.L.C." (lambda super linear converter) circuit in effect eliminating zero cross distortion, the main cause of loss of sound quality in the PCM playback section. Together with a real 20-bit digital/analog converter with excellent resolution, it greatly improves music reproducibility, especially at low volumes. In addition, two digital/analog converters are used for each channel, and the 16-times oversampling further reduces noise and improves resolution to recreate sound fields with rich musical expression.
- (2) Brawny power source**
The DCD-2560G/2560 uses a large transformer with independent coils for the digital servo circuitry and audio circuitry. In conjunction with a high capacity smooth capacitor, this offers power with room to spare.
- (3) A wealth of functions**
The DCD-2560G/2560 is equipped with a wide variety of functions, including such editing functions as time editing, auto editing, peak search and fading, as well as pitch control and remote control volume adjustment.
- (4) Simple design**
Controls for seldom used functions are hidden behind a trap door to keep the appearance simple and elegant.

BEFORE USE — Be sure to release the shipping lock.

- Remove the two shipping cushions inserted in the trap door.
- "Shipping lock"**
The shipping lock keeps the laser pickup inside the player from moving during shipment.
- When using the player**
Before turning the power on, set the player so that the front panel is facing up, insert the included mini screwdriver into the shipping lock, then turn it counterclockwise until it stops. (APPROXIMATELY 1/2 TURN).
Do not use any tool other than the included mini screwdriver.
Remove the two shipping cushions inserted in the trap door.
- Reshipping**
 - Turn the power on, open the disc holder, check that no disc is loaded, then close the disc holder.
 - Turn the power off, set the player so that front panel is facing up, then turn the shipping lock clockwise until it stops. (APPROXIMATELY 1/2 TURN)

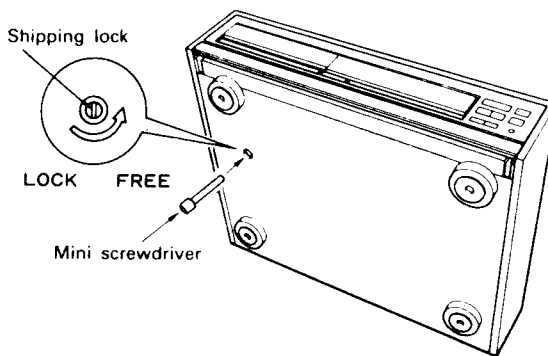

CAUTION

Be sure to release the shipping lock on the bottom panel before turning the power on.
When locking or freeing the shipping lock, be sure to set the player with the front panel facing up, the back panel facing down. (Refer to the diagram)

THE COMPACT DISC

1. Precautions on handling compact discs

- Do not allow fingerprints, oil or dust on the surface of the compact disc. If the signal surface is dirty, wipe it off with a soft, dry cloth. Wipe in circular motions from the center and out. Use of DENON's AMC-20/21 CD cleaner is recommended.
- Do not use water, benzene, thinner, record sprays, electrostatic proof chemicals, or silicone-treated cloth to clean discs.
- Always use care when handling discs to prevent damaging the surface, in particular when removing a disc from the case and returning it.
- Do not bend compact discs.
- Do not apply heat to compact discs.
- Do not enlarge the hole in the center of the disc.
- Do not write on the disc and do not attach any labels.
- Condensation will form on the disc surface if it is brought into a warm room from a cold area, such as outdoors during winter. Wait until the condensation disappears. Never dry discs with hair dryers, etc.

2. Precautions on storage

- After playing a disc, always return it to its case.
- Keep discs in the cases when they are not to be played. This will protect them from dust and dirt and prolong their service life.
- Do not store discs in the following places:
 - Places exposed to direct sunlight for a considerable time.
 - Places subject to accumulation of dust or high humidity.
 - Places exposed to high temperatures, such as close to heater outlets.

NAMES AND FUNCTIONS OF PARTS

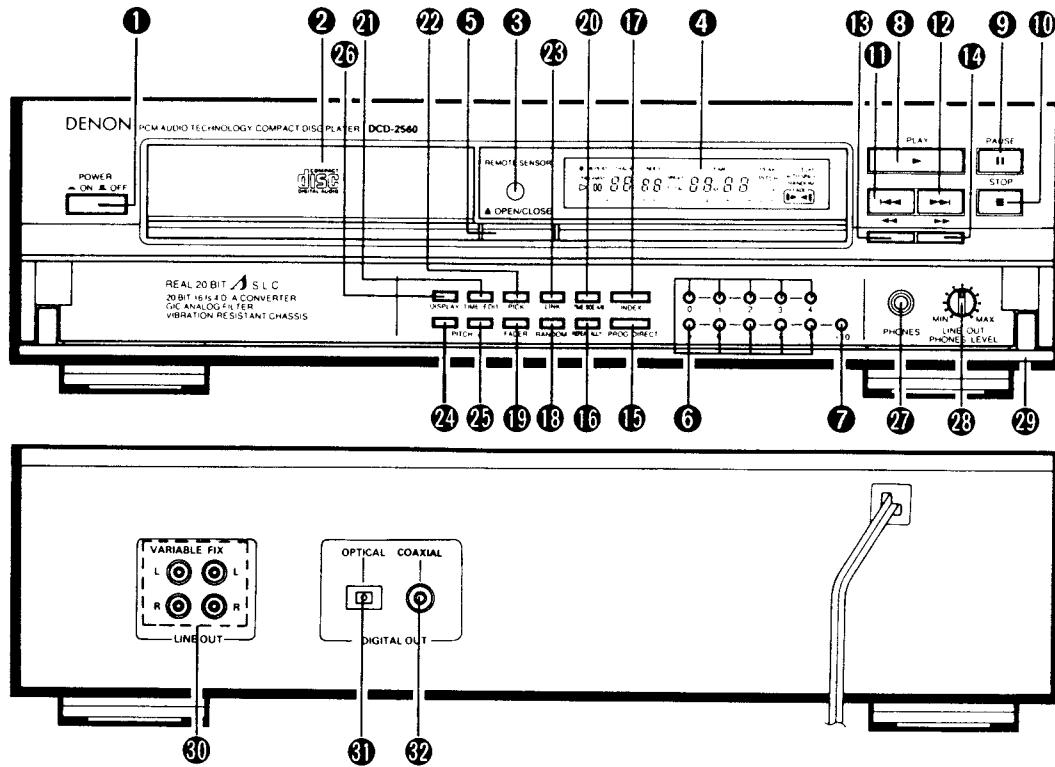

1 Power Switch (POWER)

- When the power is turned on, "00" appears at the track number display, and if no disc is loaded, "0000000" appears on the number display and the calendar lights.
- If a disc is loaded when the power is turned on, in several seconds the total number of tracks on the disc appears at the track number display, the total time appears at the time display, and the numbers on the calendar display light up to the total number of tracks on the disc, then playback starts.

2 Disc Holder

- This is where the disc is loaded.
- Press the disc holder open/close button (▲ OPEN/CLOSE) to open and close the disc holder.
- The disc holder is also closed if the play button (▶ PLAY), pause button (⏸ PAUSE), or one of the number buttons (0-9) is pressed.

3 Remote Control Sensor (REMOTE SENSOR)

- This is the sensor for the wireless remote control signals.
- For remote control, point the supplied remote control unit RC-232 towards this sensor.
- When a signal is transmitted from the remote control unit, the remote control indicator in the display (4) will light up briefly.

4 Display Window

- The digital display is divided into sections, such as displays for track number, index, playback time and calendar, as shown below.

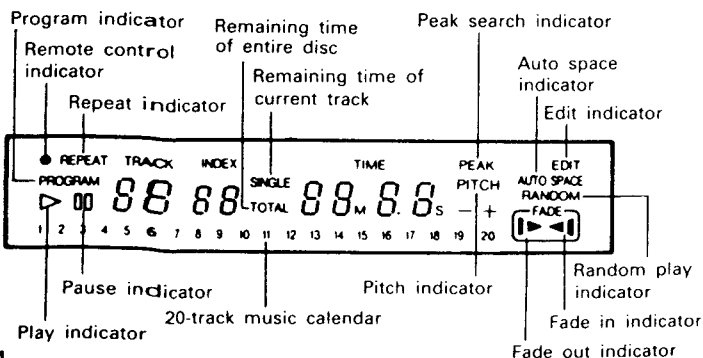

5 Disc Holder Open/Close Button (▲ OPEN/CLOSE)

- Press this to open and close the disc holder (2).
- When pressed, the disc holder (2) opens. When pressed again, the disc holder (2) closes.
- If a disc is loaded, the total number of tracks on the disc and the total playing time appear on the display window (4) several seconds after the disc holder (2) is closed.

6 Number Buttons (0, 1, 2, 3, 4, 5, 6, 7, 8, and 9)

- Use these buttons for the direct search and program memory functions.
- For direct search, press for example button (3) if you want to hear track number 3. For track number 12, press [+10] then (2). To program tracks, press the PROG/DIRECT button (6) to set to the program mode.

7 +10 Button (+10)

- Press this button first when selecting track numbers over 10. Use it together with the number buttons (0-9). For example, to select track number 15, press [+10] then (5). For track number 33, press [+10] three times, then press (3).

8 Play Button (▶ PLAY)

- Press this button to start playback of a disc.
- When this button is pressed, (▶) is displayed, and the track number being played is displayed together with the elapsed playback time of the track.
- Tracks are shown on the calendar display. Once a track has been played, the corresponding track number goes out on the calendar display.

9 Pause Button (⏸ PAUSE)

- Press this button to interrupt playback momentarily.
- When pressed during playback, playback stops, the (▶) indicator turns off, and the (⏸) indicator lights.
- To cancel the pause mode, either press the play button (▶) or press the pause button (⏸) again.

- 10 Stop Button (■ STOP)**
- Press this button to stop playback. The disc will stop rotating, and the number of tracks and total playing time of the disc are displayed on the TRACK NO. and TIME displays, respectively.
 - In case programmed playback is engaged when this button is pressed, the number of tracks and total playing time of the program are displayed.

- 11 Automatic Search Reverse Button (⏮)**
- Press this button to return the pickup to the beginning of the present track. Press again to return to other tracks.
 - By pressing the button a number of times, the pickup will move back the corresponding number of tracks.

- 12 Automatic Search Forward Button (⏭)**
- Press this button to move the pickup forward to the beginning of the next track. Press again to move ahead to other tracks.
 - By pressing the button a number of times, the pickup will advance the corresponding number of tracks.

- 13 Manual Search Reverse Button (⏪)**
- Press this button during playback for fast reverse search. As long as the button is kept pressed, music signals are played back faster than normal.
 - Pressing this button when the pause mode is engaged, you can quickly reverse the pickup to a desired position, three times faster compared to manual reverse search during playback. During this time, no sound is heard.

- 14 Manual Search Forward Button (⏩)**
- Press this button during playback for fast forward search. As long as the button is kept pressed, music signals are played back faster than normal.
 - Pressing this button when the pause mode is engaged, you can quickly forward the pickup to a desired position, three times faster compared to manual forward search during playback. During this time, no sound is heard.

- 15 Program/Direct Button (PROG/DIRECT)**
- Press this button when you want to enter tracks for programmed playback. (Refer to page 7, 8 for details.)

- 16 Repeat All/1 button (REPEAT ALL/1)**
- Press to play repeatedly. When pressed once, the [REPEAT] indicator lights and all tracks on the disc are played repeatedly. When pressed again, only one number is displayed on the calendar display, and only that track is repeated. When pressed a third time, the [REPEAT] indicator turns off and the repeat mode is canceled. Only the all-track repeat mode will function during programmed playback.

- 17 Index button (INDEX)**
- Press this button to start playback from an index number within the track. Use the number buttons to specify the desired index number. (See Page 7.)

- 18 Random Play Button (RANDOM)**
- Press this button to play the tracks on the disc in random order.

- 19 Fader Button (FADER)**
- Press to perform fade out or fade in. (Refer to Page 11, 12.)

- 20 Time/Side A/B button (TIME/SIDE A/B)**
- Press this button to switch between the displays for side A and B of the tape during the time editing operation. (Stop only)
 - Use this button to switch the time display between the elapsed time for the track being played, the remaining time for the track being played, and the total remaining time. (During play or when stopped.)

Normally the elapsed time for the track being played is displayed. If the button is pressed once, the [SINGLE] indicator lights and the display changes to the remaining time for the track being played. If pressed again, the [SINGLE] indicator turns off, the [TOTAL] indicator lights, and the total remaining time is displayed. If pressed once again, the [TOTAL] indicator turns off and the display returns to the elapsed time for the track being played.

During program playback, the total remaining time for all programmed tracks is displayed when the [TOTAL] indicator is lit.

- 21 Time Edit Button (TIME EDIT)**
- Press this button to edit in conjunction with the tape time. (Refer to Page 10.)

- 22 Pick Button (PICK)**
- Press this button when substituting a track with the time edit. (Refer to Page 10, 11.)

- 23 Link Button (LINK)**
- Press this button when editing spans a number of discs. (Refer to Page 11.)

- 24 Pitch - Button (PITCH -)**
- Press this button to slow down the playing speed. (Refer to Page 12.)

- 25 Pitch + Button (PITCH +)**
- Press this button to make the playing speed faster. (Refer to Page 12.)

- 26 Display Button (DISPLAY)**
- Press this button to change the brightness of the display.
 - Press once to make the display 2/3 as bright as normal.
 - Press again to make the display 1/3 as bright as normal.
 - Press once again to turn the entire display off during playback and all but the track number off in any other mode.

- 27 Headphones Jack (PHONES)**
- Use this jack to plug in headphones. (Headphones are sold separately.)

- 28 Volume Adjust Control (LINE OUT)**
- Use this to adjust the output level (volume) of the headphones or the line out (VARIABLE) output level.
 - This operation is also possible using the included remote control unit (RC-232). (Refer to Page 15.)

- 29 Trap Door**
- Press the right edge to open the door.
 - To close it, press on the right edge. A click is heard to indicate that the door is closed.

- 30 Output Terminal (FIX and VARIABLE)**
- Connect these to the amplifier's input jacks. (Refer to page 6.)

- 31 Digital Output Jack (OPTICAL)**
- Digital data is output in optical form from this jack.
 - Contact your nearest Denon Consumer Center or office for information on the optical fiber cable to be used for connection.

- 32 Digital Output Jack (COAXIAL)**
- This jack outputs digital data.
 - We recommend using a 75-ohm pin cord (available in stores) for connections.

Continuous Operation

If the automatic search reverse button 11, the automatic search forward button 12, the pitch - button 24, the pitch + button 25 or the +10 button 7 are held in, the function of that button will be repeated.

CONNECTION

- (1) **Connections to the Output Jacks (FIX and VARIABLE)**
Using the included pin cords, connect the left (L) and right (R) output jacks (FIX and VARIABLE) on the DCD-2560 to the left (L) and right (R) CD, AUX, or TAPE PLAY input jacks on an amplifier. There are two types of output jacks. The output is variable for the VARIABLE jacks, and fixed for the FIX jacks. If you want to be able to control the output level on the DCD-2560, use the VARIABLE jacks.

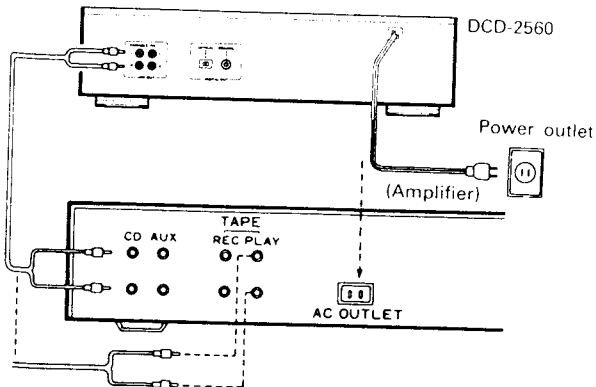

- (2) **Connections to the Digital Optical Output Jack (OPTICAL)**
Use an optical fiber cable to connect the digital optical output jack on the DCD-2560 to the optical input jack on a digital processor or D/A unit.

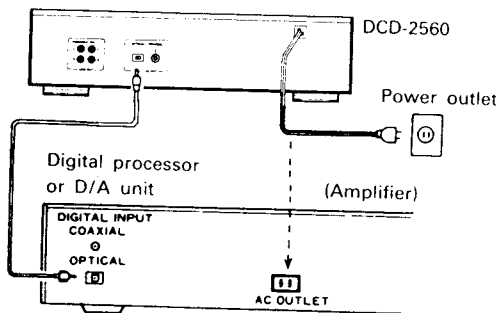

- (3) **Connections to the Digital Output Jack (COAXIAL)**
Use a 75-ohm pin cord to connect the digital output jack (COAXIAL) of the DCD-2560 to the digital input jack (COAXIAL) on a digital processor or D/A unit, available in stores.

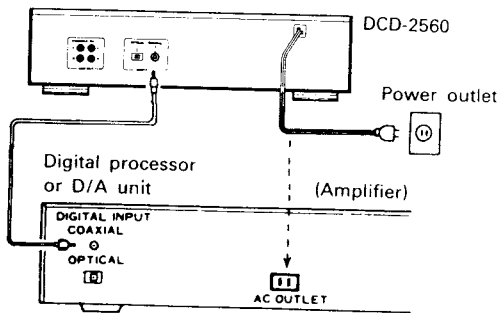

Connection Precautions

- Before proceeding with connections or disconnections of cables and power cords, be sure to turn all system components off.
- Ensure that all cables are connected properly to the L (left) and R (right) jacks.
- Insert plugs fully into the terminals.
- Connect the output jacks to the amplifier CD, AUX or TAPE PLAY input jacks.

OPENING AND CLOSING THE DISC HOLDER AND LOADING A DISC

Opening and closing the disc holder (This operation only works while the power is on.)

1. Press the power switch (POWER) to turn on the power.
2. Press the open/close button (▲ OPEN/CLOSE).

How to load a disc

- Make sure the disc holder is completely open.
- Hold the disc by the edges and place it on the disc tray. (Do not touch the signal surface, i.e., the glossy side.)
- When using 12 cm. diameter discs, make sure the outer edge matches the tray guide circumference (Fig. 1), and when using CD singles (8 cm. diameter) match the outer edge with the inner tray guide circumference. (Fig. 2)
- Press the open/close button (▲ OPEN/CLOSE) to close the disc holder.
- When the disc holder is closed, the disc is read and after a few seconds the number of tracks and total playing time are displayed on the TRACK NO. and TIME displays, respectively.
- When the disc holder is open and a disc is loaded, you may also press the play (▶ PLAY) or pause (⏸ PAUSE) button to close the disc holder. (If the play button (▶ PLAY) is pressed, playback will start immediately upon the disc contents having been read.)

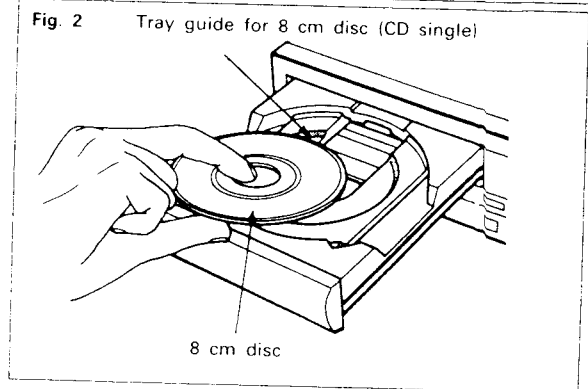
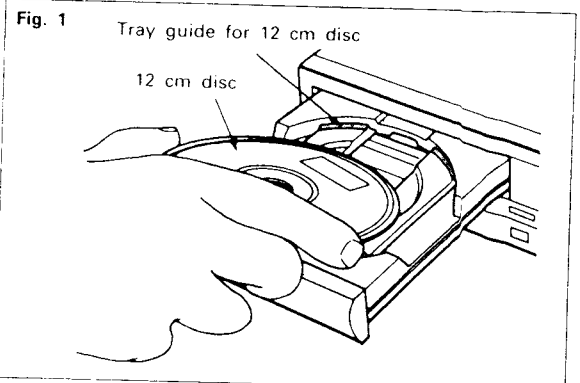

Caution:

- If your finger should get caught in the disc holder when it closes, press the open/close button (▲ OPEN/CLOSE).
- Do not place any foreign objects on the disc tray, and do not place more than one disc on the tray at a time. Otherwise malfunction may occur.
- Do not push in the disc tray manually when the power is off as this may cause malfunction and damage the CD player.

NORMAL CD PLAYBACK

(1) Starting Playback

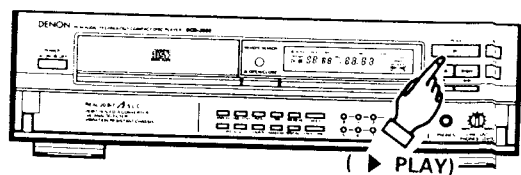

- 1 Turn the power switch on and load the disc.
 - 2 Press the play button (▶ PLAY).
- The number of the track currently playing, the index number, and the elapsed time, etc., are displayed.

(2) Stopping Playback

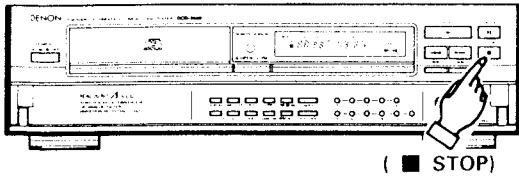

- 1 Press the stop button (■ STOP).
- The stop mode is set automatically once all tracks on the disc are played.

NOTE:

- If no disc is loaded or if the disc is loaded upside-down, the track number, index, and time displays will all read zero, and the entire calendar will light.



- If the information at the innermost side of the disc cannot be read properly due to dirt or scratches, the display will be as shown below, and the number of tracks and remaining time per track will not be displayed. Also, the search operation may take longer than usual.

When normal

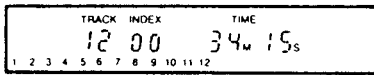

When data cannot be read properly

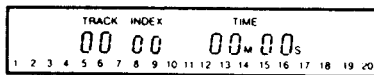

ADVANCED CD PLAYBACK

① Playing a Specific Track Direct Search

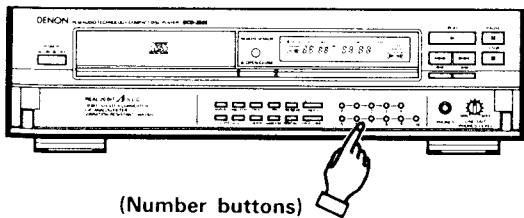

- ① Use the number buttons and the +10 button to input the number of the desired track.
For example, to play the fourth track press [4], and to play the 12th track press [+10] and [2]. The beginning of the track is found and playback starts.

② Moving to Following Tracks During Playback Automatic Search

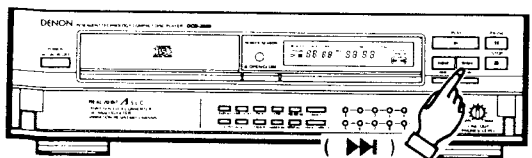

Press the automatic search forward button (▶▶).

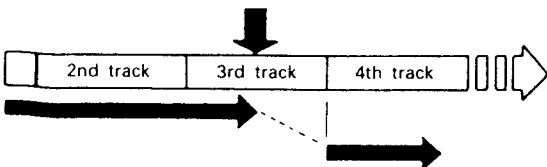

- ① Press the automatic search forward button (▶▶).
- If the automatic search forward button (▶▶) is pressed again during the search operation, the pickup moves on to the next track, etc.

③ Returning to the Beginning of the Current Track Automatic Search

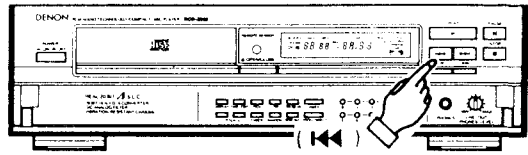

Press the automatic search reverse button (◀◀).

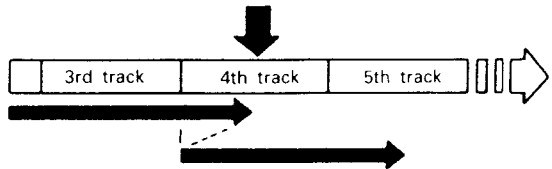

- ① Press the automatic search reverse button (◀◀).
- If the automatic search reverse button (◀◀) is pressed again during the search operation, the pickup moves on to the previous track, etc.

④ Finding Sections Within a Track Index Search

- Use this function to start playback from certain sections within a track divided by index numbers.

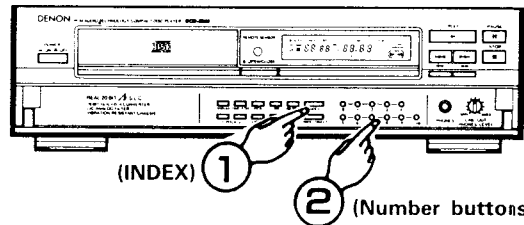

- ① Press the INDEX button. "--" appears at the TRACK NO. display.
- ② Use the number buttons to specify the track number. "--" now appears at the INDEX display. Input the desired index number. Playback starts from there.
For example, to start listening from index number 2 on track 3, press INDEX, 3 and 2.

Indexes

- Indexes are numbers which are assigned to sections within a track. Check the disc's explanatory notes for the index numbers.
- If you make an index search for an index number that is not on the disc, playback will start from the last index number on the track.

⑤ Playing Specific Tracks in a Specific Order Programmed Play

- With this function, you can choose any of the tracks on the disc and program them to play in any order.
- Programming is possible with the disc holder open.
- Up to 20 tracks can be programmed.
- The programmed tracks are shown on the calendar.

(1) Programming

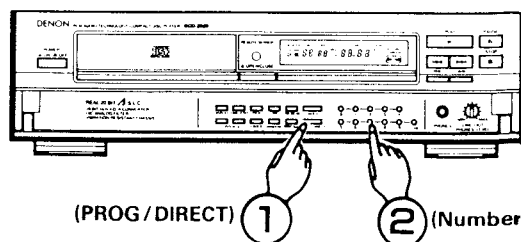

(PROG/DIRECT) ① ② (Number buttons)

- The **PROGRAM** indicator lights when the program/direct button (PROG/DIRECT) is pressed. Next, use the number buttons and the +10 button to program the tracks. To program tracks 3, 12, and 7, for example, press **PROG/DIRECT**, **[3]**, **[+10]**, **[2]**, and **[7]**. The track number lights on the calendar each time a track is programmed. The number of tracks programmed is displayed at the index display, and the total playing time for the programmed tracks is indicated at the time display. After the tracks are programmed, the total number of programmed tracks is displayed at the track number display, and the total playing time for the programmed tracks is indicated at the time display.

(2) Checking the Programmed Tracks (Remote control only)

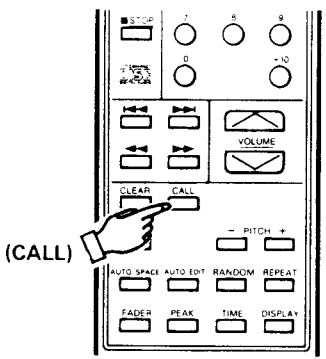

- Press the **CALL** button. The programmed tracks are displayed in order on the **TRACK NO.** display each time the **CALL** button is pressed.

(3) Playing the Programmed Tracks

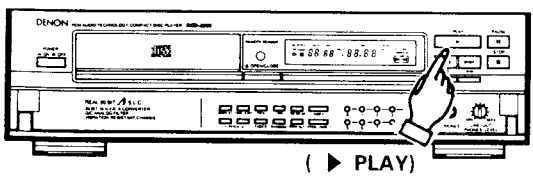

- Press the **(▶ PLAY)** button to play the tracks in the programmed order.

(4) Correcting Programs

(Remote control only)

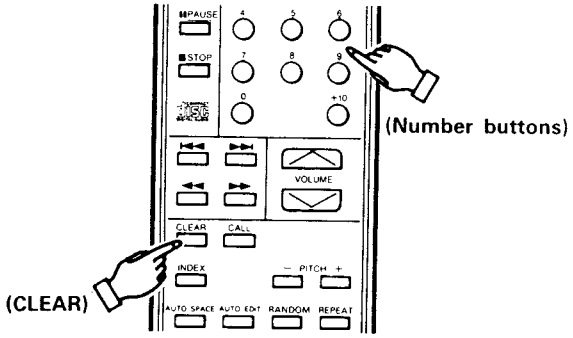

- To correct a programmed track, first press the **CLEAR** button, then program the correct track. The last track programmed is replaced with the correct track.
- To clear a track in the middle of the program, use the **CALL** button to call out that track, then press the **CLEAR** button to clear it from the program.

(5) Clearing the Entire Program

- Press the **PROG/DIRECT** button once again to clear the entire program. The entire program can also be cleared by pressing the **OPEN/CLOSE** button.
- If the **PROG/DIRECT** button is pressed during programmed playback, the program mode is cleared and normal playback continues from that track on.

NOTES

- If the programming operation is performed in the play or pause mode, the current track is programmed as the first track in the program. Other programs can be added, but the number of programmed tracks and playing time will not be displayed.
- Direct search is not possible during programmed playback. Pressing the number buttons adds tracks to the end of the program.
- Programming is also possible when the disc holder is open. A track number greater than the number of tracks on the disc can be set in the program, but it will automatically be cleared from the program before playback starts.
- The remaining time per track can only be displayed for the first 20 tracks on the disc.
- The total program time and remaining program time as well will not be displayed if tracks numbers greater than 20 are programmed.

6) Playing All Tracks Repeatedly Repeat Playback

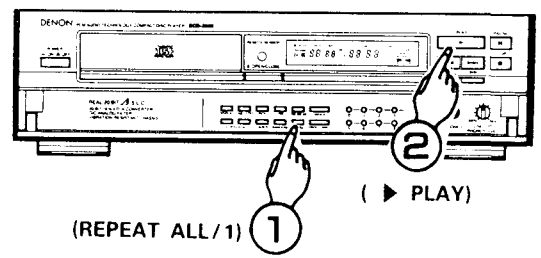

- Press the **REPEAT ALL/1** button. The **REPEAT** indicator lights.
- The operation is the same whether button ① or ② is pressed first.
- The one-track repeat mode is set if the **REPEAT ALL/1** button is pressed again during repeat playback.
- The all-track repeat mode is set even if the **REPEAT ALL/1** button is pressed during playback.
- To cancel the repeat mode, press the **REPEAT ALL/1** button twice.
- If the **REPEAT ALL/1** button is pressed during programmed playback, the tracks are repeated in the programmed order.

7) Playing a Single Track Repeatedly One-track Repeat

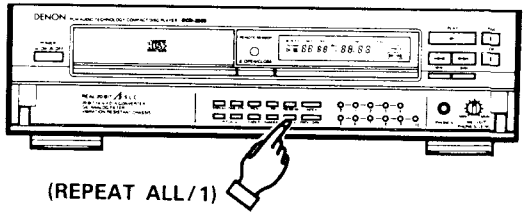

Press the **REPEAT ALL/1** button twice

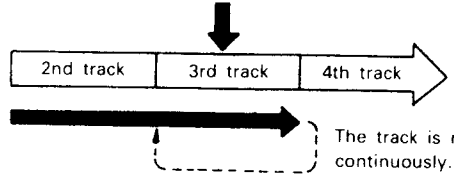

- Press this button when you hear a track you want to play repeatedly.
- Press the **REPEAT ALL/1** button twice during playback. The **REPEAT** indicator lights, and if you are at track number 20 or less that number appears on the calendar display and that track is played repeatedly.
- For track numbers 21 and above, the track number is not displayed on the calendar display but the one-track repeat mode will function.
- If the **REPEAT ALL/1** button is pressed twice in the stop mode, track number 1 appears on the calendar display and one-track repeat is possible. Press the **PLAY** button to start playback.
- Press the **REPEAT ALL/1** button once again to cancel the one-track repeat mode. The display and playback return to normal.

8 Stopping Momentarily During Playback **Pause**

- Playback can be stopped momentarily then resumed from the same point.

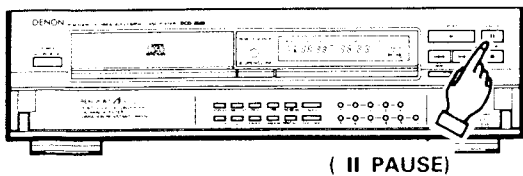

- 1 Press the pause button (|| PAUSE).

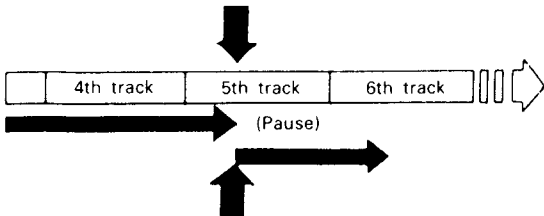

- 2 Press the play button (▶ PLAY) or the pause button (|| PAUSE).
 - To resume playback, press either the play button (▶ PLAY) or the pause button (|| PAUSE).

9 Finding a Track While Listening at High Speed **Manual Search**

- You can skip through the disc while listening at high speed. This function comes in handy for finding a certain part in the middle of a long track and starting playback from there.
- Once you find the desired position using the manual search operation, release the manual search forward button (▶▶) or manual search reverse button (◀◀) to start normal playback.

(1) **Manual Search Forward**

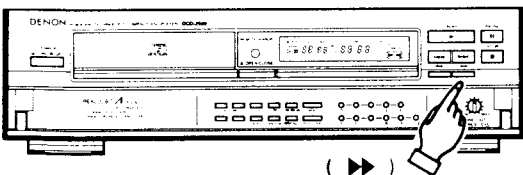

Hold in the manual search forward button (▶▶)

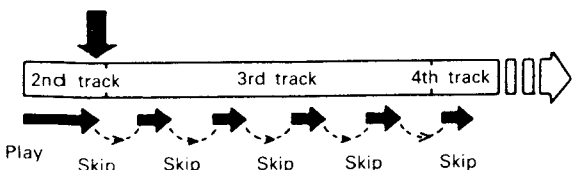

- 1 During playback, press and hold in the manual search forward button (▶▶) to skip through the disc while listening at high speed.
 - The number of the track being skipped through, the index, number, and the elapsed time for that track are indicated on the display window.
 - In the pause mode, the disc moves at about three times the speed as during the play mode, but no sound is heard.
 - When the end of the last track is reached while pressing the manual search forward button (▶▶), "]]]" appears on the display window and the manual search operation is stopped. To resume playback, press the manual search reverse button (◀◀), then do another operation once the "]]]" disappears from the display.

(2) **Manual Search Reverse**

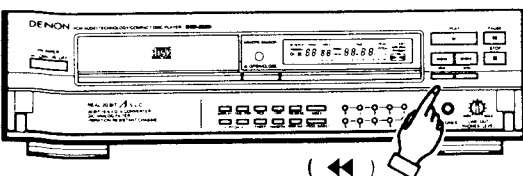

Hold in the manual search reverse button (◀◀)

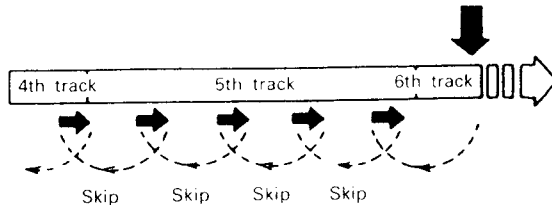

- 1 During playback, press and hold in the manual search reverse button (◀◀) to skip through the disc while listening at high speed.
 - The display is the same as during the manual search forward operation.

- In the pause mode, the disc moves at about three times the speed as during the play mode, but no sound is heard.
- When the beginning of the first track is reached while pressing the manual search reverse button (◀◀), "[[[appears on the display window and the manual search operation is stopped. To resume playback, press the manual search forward button (▶▶), then do another operation once the "[[[disappears from the display.

10 Inserting Blanks Between Tracks **Auto Space**
(Remote control only)

- This function inserts blank spaces between tracks, making editing easier.

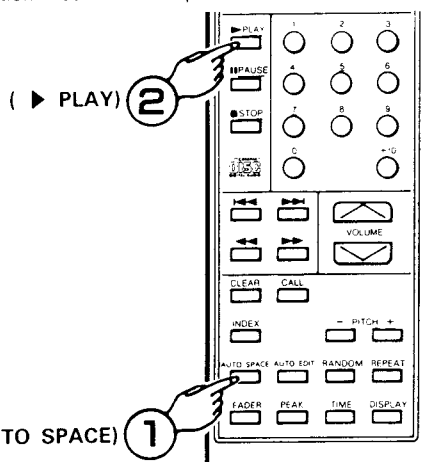

- 1 The AUTO SPACE indicator lights when the auto space button is pressed.
- 2 Press the play button (▶ PLAY) to start playback. When the end of a track is reached, a blank space of approximately 4 seconds is inserted before the beginning of the next track.
- 3 Press the auto space button again to turn the auto space function off.

11 Pausing At the Beginning of a Track After Searching **Pause**

(1) **Direct Search**

- Pausing at the beginning of a track found with the direct search operation comes in handy for practicing karaoke.

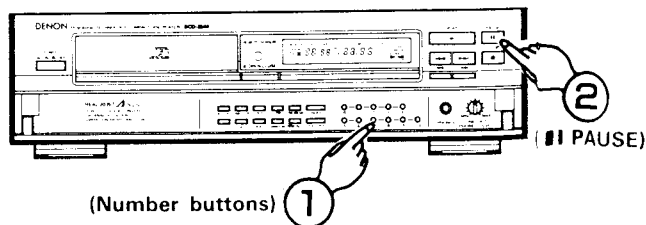

- 1 Use the number buttons to set the desired track.
- 2 Press the pause button (|| PAUSE).
 - To start playback, press either the play button (▶ PLAY) or the pause button (|| PAUSE).

(2) **Program Search**

- Press the pause button (|| PAUSE) after programming tracks. The beginning of the first track in the program is found and the disc is paused there.

12 Playing Tracks in Random Order Random Playback

- All of the tracks recorded on the disc can be played once in random order.

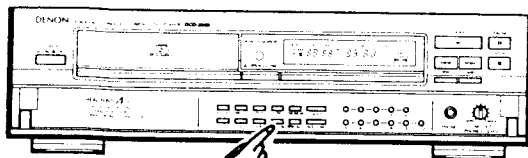

(RANDOM)

- When the random button (RANDOM) is pressed, the **RANDOM** indicator lights and random playback starts automatically.
- If the random button (RANDOM) is pressed when tracks are programmed, only the programmed tracks are played at random.
- If the random button (RANDOM) is pressed when the repeat function is set, all tracks will be played through once in random order, after which all tracks will be played through again in different order, and so on.
- During the search operation, the track numbers from the first to the last track on the disc are displayed in rapid succession on the track number display, so you cannot tell what track is going to be played next until playback begins.

NOTE:

- The total remaining time is not displayed during the random mode.
- The auto edit mode is cancelled if the random button (RANDOM) is pressed during the random mode.

13 Edit Recording on Sides A and B of the Tape Edit Function

(1) Auto Edit Function (AUTO EDIT) (Remoto control only)

The auto edit function automatically divides the tracks on the compact disc into sides A and B, with the division at the beginning of a track in such a way that the disc's total playing time is divided as close as possible by one half.

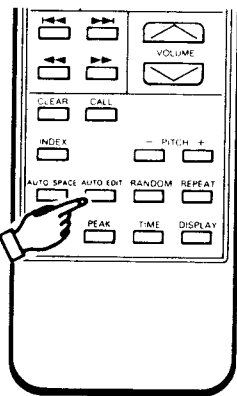

(AUTO EDIT)

- When the AUTO EDIT button is pressed in the stop condition, the total play time of side A (the first half) and the track numbers (on the calendar) are displayed for about 2 seconds. Next, the side B (last half) information is similarly displayed after which the player automatically pauses at the beginning of the first track of side A. **EDIT** and **PROGRAM** will be lit on the display at this time.
- Pressing the play button (▶ PLAY) or the pause button (⏸ PAUSE) will start the play mode. When side A has finished playing, the player will pause at the beginning of the first track on side B.
- Pressing the play button (▶ PLAY) or the pause button (⏸ PAUSE) again will start the play mode. When side B has finished playing, the player automatically stop.

(2) Editing by Tape Time Specification (TIME EDIT)

The time edit function permits highly efficient editing in conjunction with the length (tape time) of the cassette tape to be recorded.

- When the TIME EDIT button is pressed, (C-...) will appear and the player will wait for the tape time to be input. **EDIT** will light up.
- Input the tape time with the number buttons. (The tape time is the total time of sides A and B.)
Example: For a 46-minute tape, press 4 and 6.
- When the tape time has been specified, the tracks of side A that can be recorded are displayed on the calendar and the blank time of tape side A is displayed at TIME. (A-) is displayed at TRACK NO.
- Pressing the TIME/SIDE A/B button permits a check of the tracks that can be recorded on side B and the blank time. (b-) is displayed at TRACK NO. Each press of this button alternately displays side A and side B.
- Pressing the play button (▶ PLAY) starts the play from the first track of side A. When side A has finished playing, the player will automatically pause at the beginning of the first track of side B.
- Pressing the play button (▶ PLAY) or the pause button (⏸ PAUSE) again will start the play mode. When side B has finished playing, the player automatically stop.

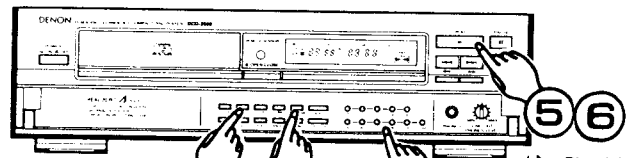

(TIME EDIT)

(TIME/SIDE A/B) (Number buttons)

When a mistake has been made in the time specification and the play button (▶ PLAY) has not yet been pressed, pressing the TIME EDIT button will return the settings to the condition of Step ①. This can be done any number of times.

- The time edit function also works in the program track selection mode (Page 7, 8). In this mode, sides A and B can be divided according to the program order. When the auto space function has been turned on, 4 seconds will be added to the play time of each track.

NOTE:

- The time edit function will not work for discs containing more than 21 tracks.
- The automatic search buttons (◀◀, ▶▶) and the manual search buttons (◀, ▶) do not function during the time edit operation.
- Pressing the stop button (■ STOP) or the open/close button (▲ OPEN/CLOSE) (except for at the time of the link operation) will cancel the time edit operation.

(3) Pick Function (PICK)

In (2) time edit, the tracks are ordered from the first track or in the programmed order so that a large blank space might remain at the end of the tape. The pick function is used to shorten this blank space and effectively use the time of the specified tape.

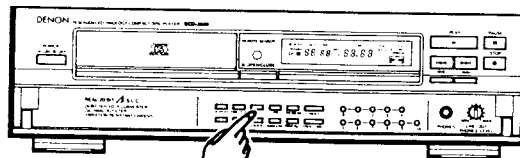

(PICK)

- In (2) time edit, press the pick button (PICK) following the tape time specification and before pressing the play button (▶ PLAY).
- When the display is showing side A, pick is executed from among the tracks other than those fixed on side A (in the blank portion of side A). When the display is showing side B, pick is executed from among the unfixed tracks (in the blank portion of side B).

Example of tracks being placed in the blank spaces

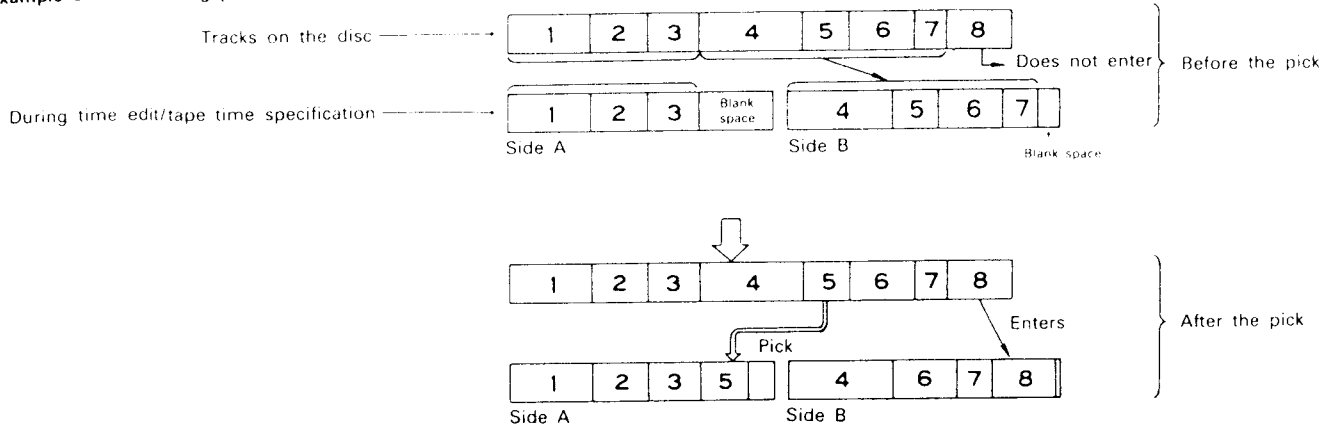

- ③ When there are no tracks that can be picked in the blank portion of side A (side B), cancel the last track of side A (side B), increase the blank portion, and pick an available track in the new blank portion. At this time the tracks cancelled from side A are automatically fixed on side B. When there are no tracks that can be picked even though the last track of side A (side B) has been cancelled, the setting will remain the same even if the cancellation is suspended.

Example of tracks not being placed in the blank spaces

When tracks are not placed in blank spaces as shown in the diagram to the right, the last track (track 3 in the example) is cancelled and substituted with a track from side B.

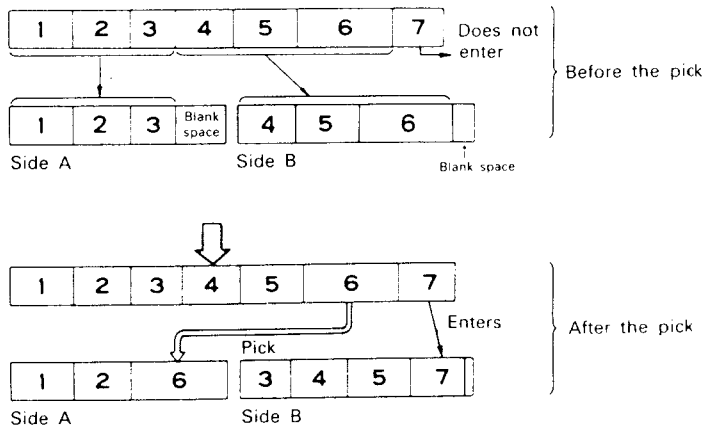

(4) Link Function (LINK)

The link function provides the convenience of editing a number of discs in succession.

The link operation is used following the tape time specification of the time edit function and before the end of playback.

- ① When the link button (LINK) is pressed, [EDIT] will start flashing.
- ② After the tracks have been played, the player will stop automatically. The blank time of the tape will be displayed at this time.
- ③ Press the open/close button (▲ OPEN/CLOSE) of the disc holder and change the disc.
- ④ Pressing the time edit (TIME EDIT) button will permit editing using the blank time of the tape in Step ②.

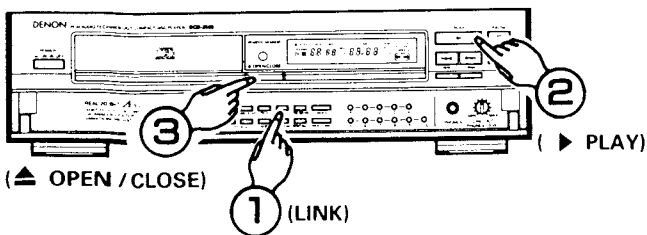

NOTE:

- The link operation is cancelled by the stop button (■ STOP). It will also be cancelled if the disc holder is opened during play.
- When editing has not been performed as far as side B with the time edit (i.e., only for part of side A), editing will be done within the blank time of side A and the blank time of side B.
- When editing has been performed as far as side B with the time edit, the blank time of side B will be used for editing.

(14) Fading Out or Fading In at the Desired Location

Fader Function

(Analog output only)

- (1) Fading out and fading in is possible at the desired position during play **Manual Fader**

① Fade Out

When the fader button (FADER) is pressed during play, fade out will be provided for about 5 seconds. (FADE) will light up during the operation and (▶) will flash. When fade out is completed the player will automatically pause.

② Fade In

When the fader button (FADER) is pressed from the pause mode, the player will start playing and fade in will be provided for about 3 seconds. (FADE) will light up during the operation and (◀) will flash.

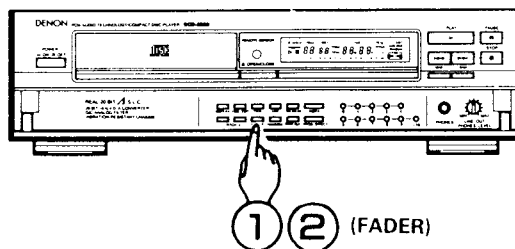

(2) Setting the Fade Out Time in Advance (TIME FADE)

- ① When the fader button (FADER) is pressed in the stop mode, the FADE indicator (FADE) will light up, TIME will appear as --M--, and the player will wait for the input of the fade out time.
- ② Input the fade out time with the (0~9) number buttons.
- ③ Pressing the play button (▶ PLAY) will start the playback and the FADE indicator (FADE) will light up.
- ④ The (▶) indication will start flashing 5 seconds before the specified fade out time and then the fade out will begin. The fade out will end at the specified time and the player will automatically pause.

The time fade function will be cancelled if an auto search or manual search is performed during playback.

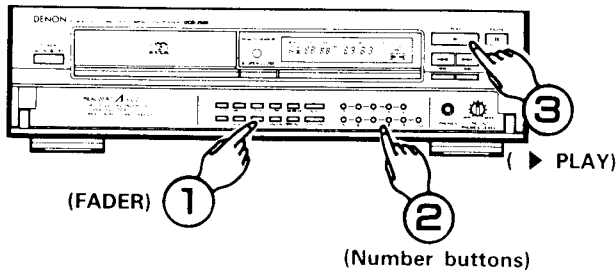

15 To Search for the Peak Level of the Disc **Peak Search**
(Remote control only)

- The player searches for the peak portion and plays a few seconds either side of this point repeatedly. This is convenient for making recording adjustments on the tape recorder.

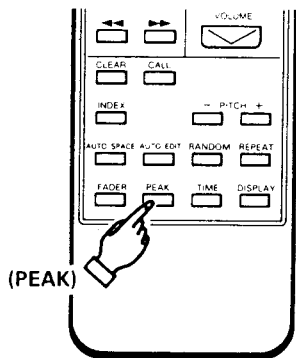

- ① When the peak search button (PEAK SEARCH) is pressed in the stop mode, the PEAK indicator will flash and the player will search for the portion having the peak level.
- ② After the search, the PEAK indicator lights up and a few seconds either side of the peak level point are played back repeatedly. This is convenient for making recording adjustments on the tape recorder.
- ③ To cancel the peak search, press the stop (■ STOP) button.
- ④ When the play button (▶ PLAY) or the pause button (⏸ PAUSE) is pressed during peak search or while playing the peak portion back repeatedly, the player will go to the beginning of the first track (the first track of the program for program playback, or the track that was first selected in the time edit) and begin playback from here if the play button was pressed or enter the pause mode if the pause button was pressed.

NOTE:

- The peak search function reads the level of the disc from the beginning of the disc to the end at a fixed interval and regards the maximum value that was read as the peak. Peak search takes a little time for this reason.
- The peak portion may change each time the disc is read and there may be a slight difference in the actual peak level, but since this difference is ever so slight there will be no adverse effects on the adjustment of the recording level.
- The time fade function is cancelled when the peak search operation is performed. To use the time fade function, set to the stop mode then reset the function.
- Buttons other than the open/close button (▲ OPEN/CLOSE), play button (▶ PLAY), pause button (⏸ PAUSE), and stop (■ STOP) button will not function during peak search or repeat play of the peak portion.

16 Changing the Speed of Playback **Pitch Control**

- Playback can be speeded up or slowed down.

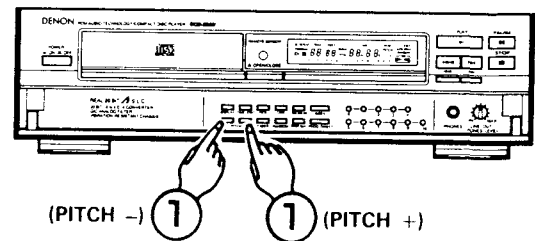

- ① Press the PITCH + or PITCH - button during the play or pause mode to change the speed of playback.
- ② When one of the PITCH buttons is pressed, the amount of the speed change appears on the seconds section ("S") of the TIME display for approximately 2 seconds. "PITCH -" appears when the speed is slower than normal, "PITCH +" when the speed is faster than normal. The speed can be changed in steps of 0.1% from -12.0% to +12.0%.
- ③ Press the PLAY button (▶ PLAY) during playback with a different speed to return to normal speed playback. Also, the speed setting is cancelled if the stop mode is set during playback at a different speed.

NOTES

- No data is output from the digital output jack (OPTCAL) during playback with a different speed (when "PITCH" is lit). If you want to output data, press the PLAY button (▶ PLAY) to return to normal speed playback.
- The pitch also changes when the speed is changed.
- If the speed is changed during the time edit operation, the total playing time changes, so the time of the blank space is not calculated accurately.
- The time display (elapsed playback time, remaining time per track, or total remaining time) will not be accurate during playback with a different speed.
- A maximum of 3 second is required to return to the normal speed when the PLAY button (▶ PLAY) is pressed during playback with a different speed. During this time, only the OPEN/CLOSE (▲ OPEN/CLOSE) and STOP button (■ STOP) will function.

PLAYBACK USING THE REMOTE CONTROL UNIT

The accessory RC-232 remote control unit can be used to control the CD player from a convenient distance.

(1) Inserting the dry cell batteries

1. Remove the battery cover on the back of the remote control unit.

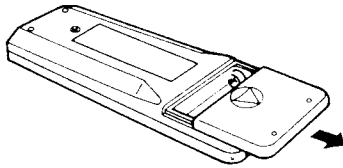

2. Insert two R6P (standard size AA) dry cell batteries with correct polarity as indicated inside the battery compartment.

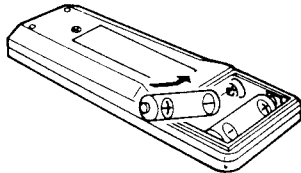

3. Replace the battery cover.

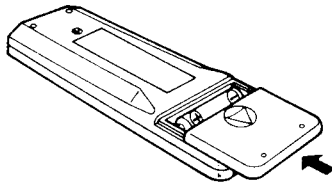

Notes on the Batteries

- The remote control unit uses standard size AA dry cell batteries.
- The batteries will need to be replaced approximately once a year. Replacement may be necessary earlier depending on how much the remote control unit is used.
- If, in less than a year from the time new batteries were inserted, the remote control fails to operate the CD player from a near-by position, it is time to replace the batteries.
- Insert the batteries properly, following the polarity diagram inside the battery compartment, in other words make sure (+) and (-) terminals are properly aligned.
- Batteries are prone to damage and leakage. Therefore:
 - Do not combine new batteries with used ones.
 - Do not combine different types of batteries.
 - Do not jumper opposite poles of the batteries, expose them to heat, break them open nor expose of them in open fire.
- If the remote control unit is not to be used for a long period of time, remove the batteries from the unit.
- If the batteries have leaked, remove any traces of battery fluid from the battery compartment, wiping thoroughly with a dry cloth. Then insert new batteries.

(2) Directions for Use

- Operate the remote control unit while pointing it towards the remote control sensor on the CD player (see below).

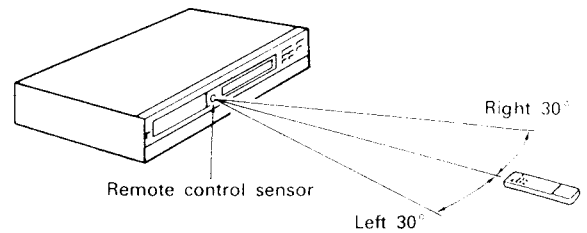

When a remote control signal is received, the remote control indicator on front of the CD player lights briefly.

- The remote control unit can be used at a distance up to 8 meters in a straight line from the CD player. This distance decreases if there are obstructions blocking the signal path or when the remote control unit is operated at an angle from the remote control sensor.
- The buttons on the remote control unit have identical functions with those on the CD player. However, the following functions cannot be remote controlled: Power ON/OFF.

Cautions on Use

- Do not press the operation buttons on the main unit and on the remote control unit simultaneously, as this will result in malfunction.
- The remote control unit may not operate properly if the remote control sensor is exposed to direct sunlight or strong artificial lighting, or if there is an object between the remote control unit and the remote control sensor.

REMOTE CONTROL UNIT RC-232

Setting to the Program Mode

- For program search, press the PROGRAM button then the number buttons (0 through 9 and +10).
- The remote control unit is normally set to the direct mode.

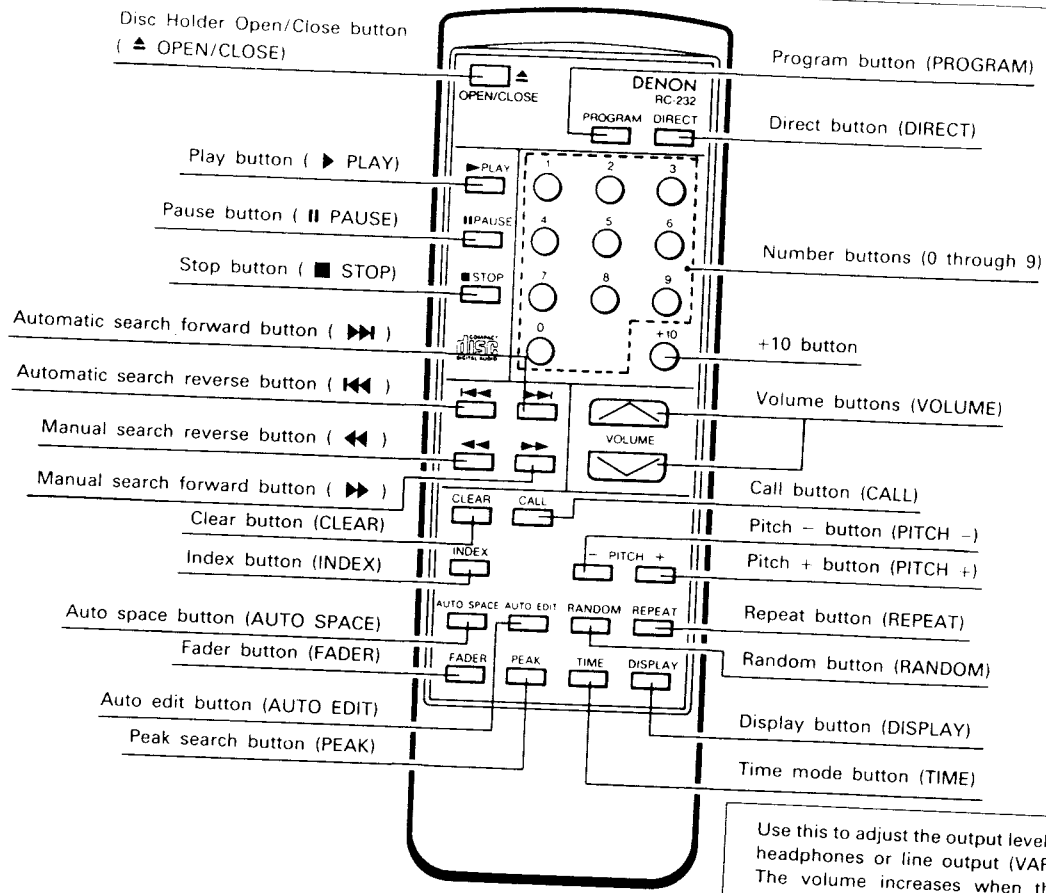

- **Direct Search**
Normally, direct search is possible simply by pressing the desired number buttons.
- **Program Search (During playback, the track which is currently playing is programmed as the 1st track.)**
Press the PROGRAM button, then press the number buttons.
For example, to program tracks number 3, 11, and 5, press PROGRAM → 3 → +10 and 1 → 5.
To cancel the program, press the DIRECT button.

- **Inputting the Track Numbers**
For track numbers below 9, simply press the corresponding button. For track numbers of 10 and greater, press the +10 then the number buttons.
For example, for track number 22 press +10 twice then 2.
- **Volume**
The volume control on the unit will operate when the volume buttons are pressed. The volume can be checked by looking at the position of the control.

SPECIFICATIONS

AUDIO

No. of Channels:	2 channels
Frequency Response:	2 – 20,000 Hz
Dynamic Range:	100 dB
Signal-to-noise Ratio:	116 dB
Harmonic Distortion:	0.0018% (1 kHz)
Separation:	110 dB (1 kHz)
Wow & Flutter:	Below measurable limit: (±0.001% W. peak)
Output Voltage:	2.0 V, VARIABLE 0 – 2.0 V

DISCS

Compact Disc format

GENERAL CHARACTERISTICS

Power Supply:	50/60 Hz, voltage is shown on rating label
Power Consumption:	20W
Dimensions:	434 (17-3/32") W × 122 (4-51/64") H × 360 (14-11/64") D mm
Weight:	10.5 kg

FUNCTIONS AND DISPLAY

Functions:	Direct selection, automatic search, programmed playback, repeat playback, manual search, auto space, time mode, pitch control, index search, fader, pick, link, peak search, time edit, auto edit, emphasis feature
Display:	Track number, time, music calendar, and engaged modes
Others:	Headphones jack

REMOTE CONTROL UNIT:

Remote Control System:	RC-232 Infrared pulse system
Power Supply:	3 V DC; two R6P (standard size AA) dry cell batteries
External Dimensions:	60 (2-23/64") W × 177 (6-31/32") H × 18 (45/64") D mm
Weight:	100 g (including batteries)

SUPPLIED ACCESSORIES

Pin-plug connection cord, mini screwdriver.

* Design and specifications are subject to change without notice in the course of product improvement.

NOTE FOR HANDLING OF LASER PICK-UP

● **NAMES OF PARTS**

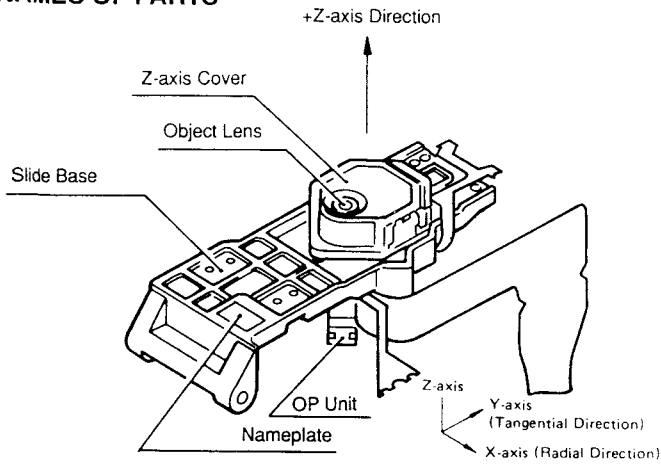

If a voltage values across Pin ⑥ of TP102 (+5V) and Pin ② (iop) of Unit (2U-2165) is V1, the value or laser diode current "iop 1" can be found a formula "iop 1" = $\frac{V1}{22}$.

● **NAME PLATE**

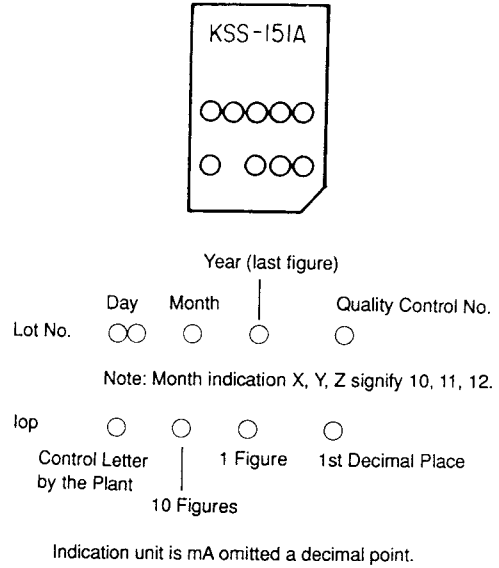

● **CONNECTION DIAGRAM OF CONNECTOR (1)**
KSS-151A Accessory flexible wire terminals.

No.	Description	No.	Description
1	Linear motor	11	PD
2	Linear motor	12	VR
3	2-axis -F	13	GND
4	-T	14	PD D
5	+T	15	C
6	+F	16	A
7	Sensor	17	B
8	Sensor	18	K
9	LD GND	19	F
10	LD	20	E

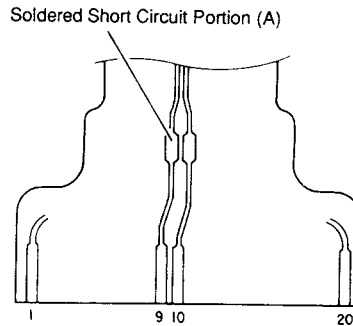

● **CONNECTION DIAGRAM OF CONNECTOR (2)**
KSS-151A → TERMINAL P.W.B. → MAIN P.W.B.

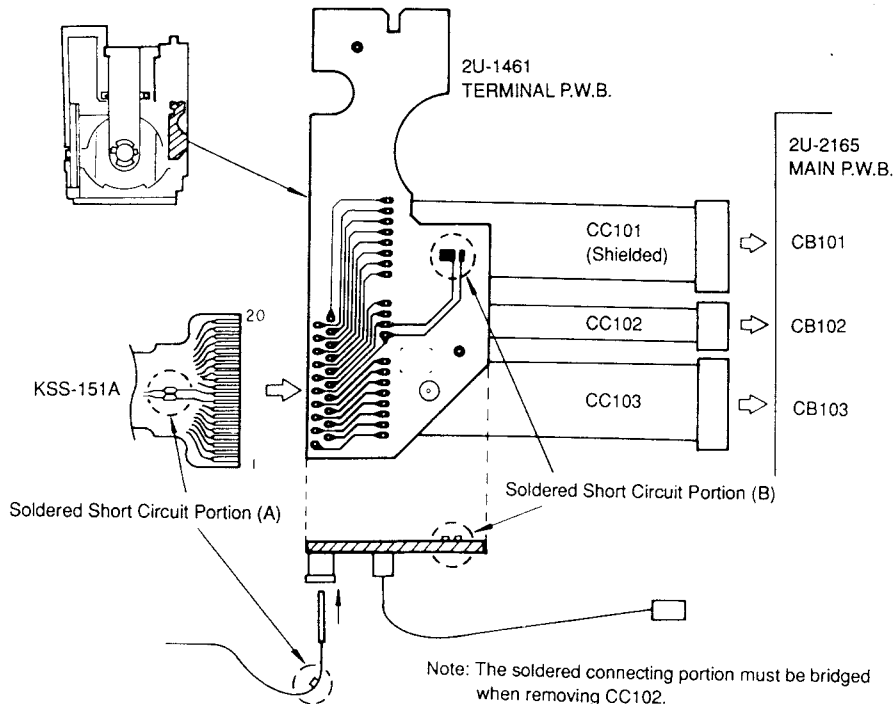

Caution for Handling the Laser Pick-up

The laser pick-up KSS-151A is assembled and precisely adjusted using a sophisticated manufacturing process in our plant. Do not disassemble or attempt to readjust it. Please keep the following instructions carefully in handling pick-up.

1. General Care

- (1) Storage
Do not store the pick-up in dusty, high-temperature or high-humidity environments.
- (2) Please take care for preventing from shock by falling down or careless handling.

2. Laser Diode (LD)

- (1) Protect your eyes
The laser beam may damage the human eye, since the intensity of the focused spot may reach $1.3 \times 10^4 \text{ W/cm}^2$ even if the intensity at the objective lens is $400 \mu\text{W}$ maximum. As the light beam spreads after focused through the objective lens, it does not effect you in the place as far as more than 30 cms. However, do not look at the laser light beam either through the objective lens directly nor another lens or a mirror.
- (2) Poison of As
Since the LD chip contains As (Arsenic), as GaAs + GaAlAs, as known as the poison, although the poison is relatively weak, in comparing with others, e.g. As_2O_3 , AsCl_3 etc., and the amount is small, avoid putting the chip in acid or an alkali solution, heating it over 200°C or putting it into your mouth.
- (3) Avoid surge current or electrostatic discharge
The LD may be damaged or deteriorated by its own strong light if a large current is supplied to it, even if only a short pulse.
Make sure that there is no surge current in the LD driving circuit by switches or else. Be careful to handle pick-up as it may be damaged in a moment by human electrostatic discharge. The pins of the LD are short-circuited by solder for protection during shipment [Soldered short circuit portion (A)].
For safety handling of an LD, grounding the human body, measuring equipments and jig is strongly recommended. And still it is further desirable to make use of mat on the platform and floor for handling the LD.
To open the short circuit, remove the soldering quickly with a soldering iron whose metal part is grounded.
The temperature of the soldering iron should be less than 320°C (30W).

3. X-axis Actuator

- (1) The performance of the actuator may be effected if magnetic material is located nearby, since the actuator has a strong magnetic circuit. Do not permit dust to enter through the clearance of the cover.
- (2) Cleaning the lens
It may change the specifications when dust or dirt is stuck on the object lens. For cleaning, use a dry lens cleaning paper applying no excessive pressure to the lens. If it is difficult to remove it, moisten the paper with a little amount of water. At this time never drip water other than the lens portion.

4. The Metal Bearing

The metal bearing of Cu-compound sintered alloy is impregnated with oil. However, supply oil with the specified oil FROIL 947P (529 0054 007), at the pick-up replacing time. You do not normally need lubricate the bushing in initializing time nor supplying oil in running time.

5. Handling

Please handle the laser pick-up with holding by optical base. When either a part of human body or some other things may happen to touch directly with the circuit part of either the LD or PD PCB, it may cause deterioration, take careful attention in handling this base.

6. Deterioration of Laser Pick-up

When difficulty occurs either in focus or tracking adjustment nor able to adjust the focus or tracking, it seems that the laser pick-up is deteriorated. In these cases, check a value of laser diode current and give a decision for deterioration.

7. Fundamental Deterioration Decision of Laser Pick-up

- (1) If a voltage value in across Pin ⑥ of TP102 (+5V) and pin ② (iop) of Unit (2U-2165) is V1, the value of laser diode current "iop 1" can be found a formula
$$\text{"iop 1"} = \frac{V1}{22}$$
- (2) If a "iop" exceeds $\pm 10\%$ compared with the IOP indication on the laser pick-up nameplate, there is a fair chance for deterioration when it is checked under a circumambient temperature 23°C .
- (3) When the circumambient temperature changes $\pm 10^\circ\text{C}$, "iop 1" will change $\pm 5\%$. The "iop 1" will also be changed by the passage of time.
- (4) In case of the above conditions taking into consideration and performed the adjustment in proper way, if the HF level across pin ① and across (HF) GND of TP102 in 2U-2165 becomes 0.6V or less values; or a jitter occurs great, the laser pick-up may be deteriorated.

DISASSEMBLY

1. Top Cover

Remove 4 screws from top cover and 5 screws from both sides. Then, remove top cover toward the arrow direction while expanding the both side cover outside.

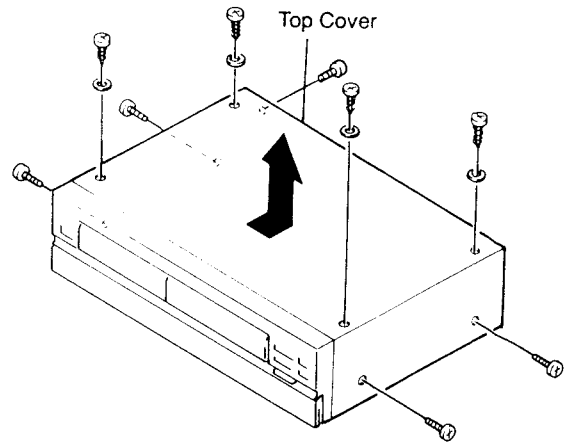

2. Front Panel

Firstly, remove 3 screws on front panel. Secondly, remove hook by inserting and screwing of -screwdriver on 3 parts of top and 3 parts of bottom, and then remove front panel toward the arrow direction. (At this time do not push the hook excessively strong as this may invite the breakage of hook.)

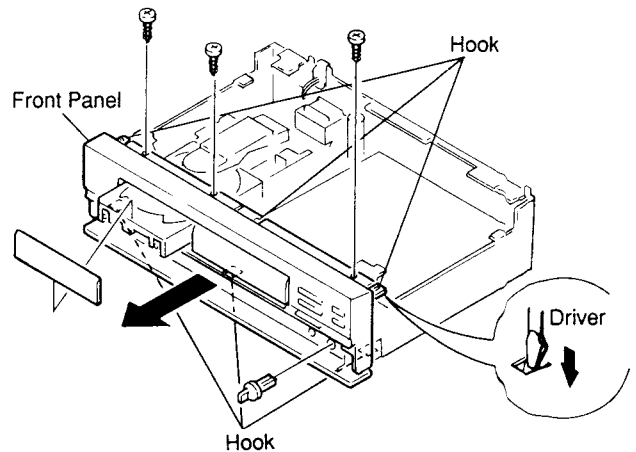

3. Bottom Cover

Remove 10 screws from bottom cover, and then remove bottom cover toward the arrow direction.

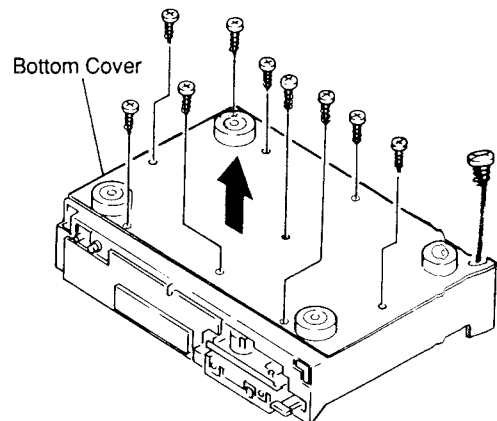

FG-612 LASER PICK-UP MECHANISM

● How to move the Loader Frame manually

Manually push the lock arm (A) to the rightward and pull the Loader frontward, then the Loader can be open/close manually.

● WHOLE body of the Laser Pick-up Mechanism FG-612

Removing 6 screws (B) makes possible to detach whole body of the Laser Pick-up Mechanism from the Chassis.

● Loader Frame

Remove whole body of the Laser Pick-up Mechanism FG-612, pull the Loader Frame (28) frontward, then after unfasten screw C lift the Loader Rail (34) upward and pull it out backward, then the Loader Frame can be taken out (Fig. 1).

● Housing Assembly

Remove 4 screws (A) 1 ~ (A) 3, and detach the Assembly composed of Laser Pick-up Magnet, Yoke, Turntable, and Spindle Motor.

By removing of screw (A), the parts for mechanism floating can be taken down as illustration shows. (Fig. 2-2)

When reassembling, remind that the Washer and H-damper are commonly used, but the Coil Spring and Collar are provided two types for maintaining equilibrium.

A 1	463 0515 000 COIL SPRING (D)	433 0484 004 COLLAR (A)
A 2	463 0515 000 COIL SPRING (D)	433 0485 003 COLLAR (B)
A 3	463 0514 001 COIL SPRING (C)	433 0485 003 COLLAR (B)

- Coil spring (D) (used 3 each) is marked in red.
- Coil spring (C) (used 3 each) is not marked.
- Collar (B) (used 2 each) is made of brass (yellow).
- Collar (A) (used 2 each) is made of brass plated with nickel (white).

● Laser Pick-up KSS-151A

- (1) Detach the Housing Assembly, then remove 6 screws (B). (Fig. 2-1)
- (2) Remove 2 screws (A), unsolder 2 portions (B), and detach the Speed Detection Coil. (Fig. 3)
- (3) Next, remove 2 screws (C), unsolder 2 portions (D), and detach the Drive Coil. And pull out the Shaft at portion (E), then the Laser Pick-up can be taken out. (Fig. 3)

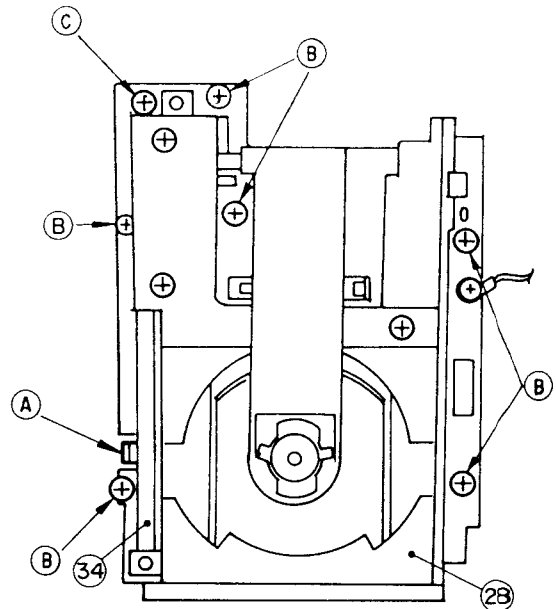

Fig. 1

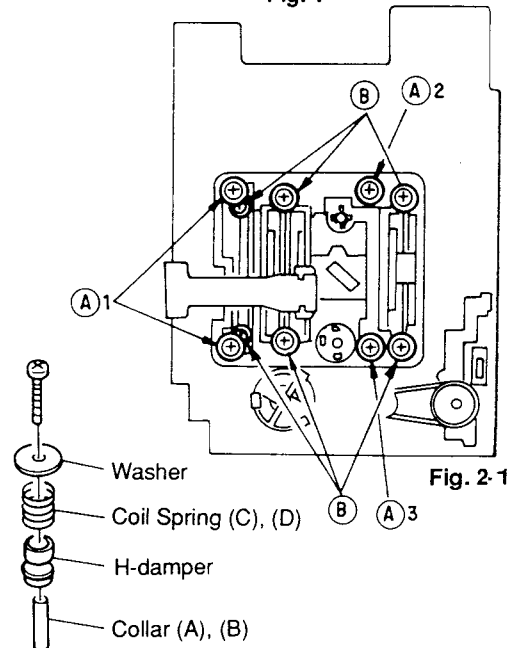

Fig. 2-1

Fig. 2-2

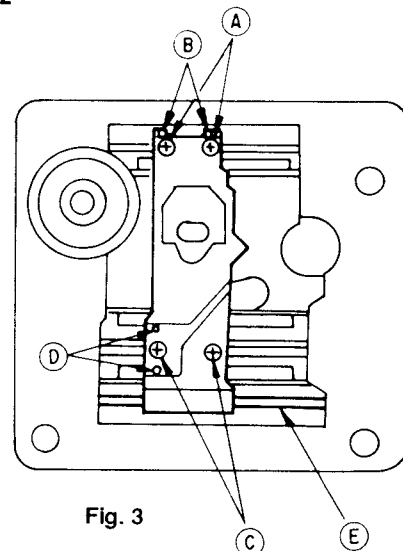

Fig. 3

ADJUSTMENT

Microcomputer built in the unit, comprises service program to facilitate servo adjustment by pushing operation button.

1. Start service program

- (1) Turn power switch OFF.
- (2) Shortcircuit JV175 (SWOP) and JV176 (SWCL) of TP102 on P.W.B. (Main Unit)
(Caution) Do not touch other jumper wires.
- (3) Turn power switch ON.
(Service program starts, and displays track number 01)

(Caution)

- When service program started normal operation of buttons will be defeated.

2. Service program function

Button	Function	Description
▲ OPEN/CLOSE	Opens or closes the disc holder.	<ul style="list-style-type: none"> ● Opens or closes only when disc is stopped. ● Operate other keys after open or close.
■ STOP	Stops system function.	<ul style="list-style-type: none"> ● Displays track number 01. ● Push when adjustment completed, or do it again.
▶ PLAY	Starts focus servo and disc turns.	<ul style="list-style-type: none"> ● Push when adjust tracking offset. ● When completed, displays track number 02.
PAUSE	Starts focus servo, tracking servo, slide servo, spindle servo.	<ul style="list-style-type: none"> ● When PLAY button is pushed, starts tracking servo and slide servo. ● When completed, track number 03.
Other button	No normal operation.	<ul style="list-style-type: none"> ● Do not operate buttons other than above. ● If misoperated, immediately turn power switch OFF.

(Caution)

- Do not use remote control during service program mode.

3. Adjustment

(1) Necessary equipment for adjustment

1. Dual trace oscilloscope
2. Reference disc (CA-1094)
3. Oscillator (10 Hz ~ 10 kHz, 0 ~ 3 Vp-p)
4. Frequency counter (readable more than 5 KHz)

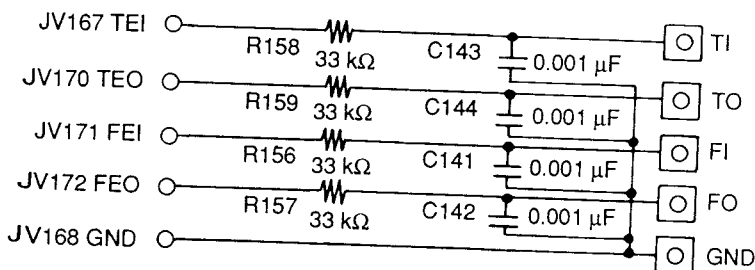



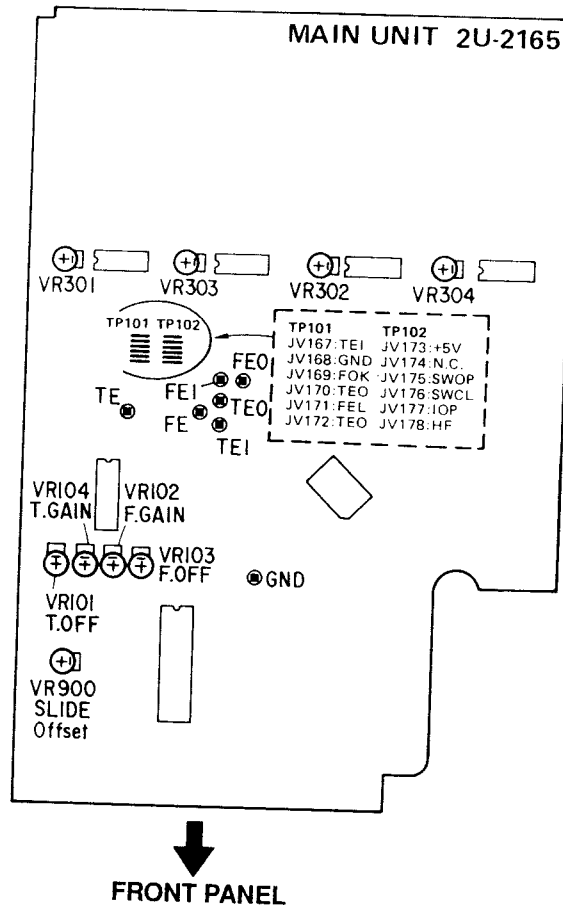

"□" is Terminal Pin on Main Unit.

(Filter for measurement in Main Unit)

(2) Location



(3) Preset

1.	Start service program.	
2.	Preset VR101 ~ 104, VR900 as per left figure.	<p>VR103 (F-O)  6 O'clock</p> <p>VR101 (T-O)  5 O'clock</p> <p>VR102 (F-G)  6 O'clock</p> <p>VR104 (T-G)  6 O'clock</p> <p>VR900 (SLIDE)  9 O'clock</p>
3.	Step.	<ol style="list-style-type: none"> 1. Slide offset 2. Tracking offset 3. Focus gain 4. Focus offset 5. Tracking gain 6. Tracking offset recheck

4. Slide offset

Connection

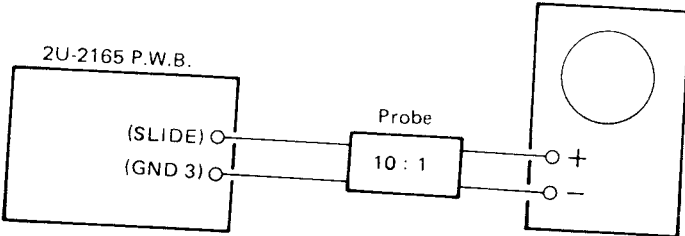

Oscilloscope (DC range)		Adjust	Check	Step
V	H	(Volume)	(Oscilloscope)	
0.1V/div	1-2 ms/div	VR900	0V ± 0.1V	1. Short the + and - terminal of the oscilloscope. 2. Adjust the VR900 [SLIDE] to 0V ± 0.1V.

5. Tracking offset

Connection

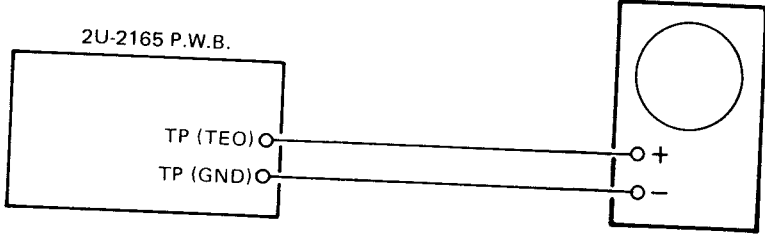

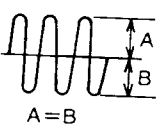
Oscilloscope (DC range)		Adjust	Check	Step
V	H	(Volume)	(Oscilloscope)	
0.1 V/div	1-2 ms/div	VR101		1. Push ▲ OPEN/CLOSE and load disc holder reference disk. 2. Push ▲ OPEN/CLOSE and close disc holder. 3. Push ▶ PLAY to turn disc. 4. Short (+) (-) of oscilloscope and check the base line. 5. Adjust VR101 [T-OFFSET] to equalize upper and lower amplitude of the waveform.

6. Focus gain

Connection

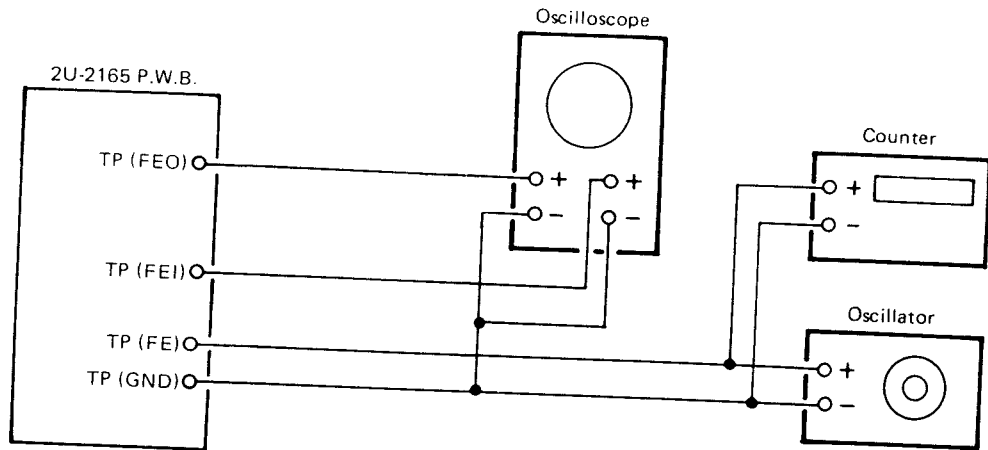

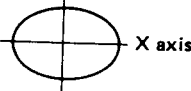
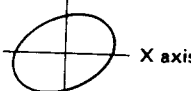
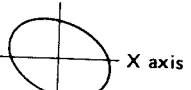
Oscillator	Counter	Oscilloscope		Adjust (Volume)	Check (Oscilloscope)	Step
		V	H			
580 Hz 1 Vp-p (±0.1 V)	580 Hz	<ul style="list-style-type: none"> ● DC range ● X-Y mode 		VR102	<p>Y axis</p>  <p>X axis</p> <p>Phase 90°</p> <p>Waveform not right</p>  <p>X axis</p> <p>Y axis</p>  <p>X axis</p> <p>Y axis</p>	<ol style="list-style-type: none"> 1. Push PAUSE. 2. Set oscillator to 580 Hz/1 Vp-p. 3. Switch oscilloscope input to X-Y mode. 4. Adjust VR102 [F-GAIN] to symmetrize Lissajous figures to X and Y axes. <ul style="list-style-type: none"> • If the tracking gain is not properly adjusted, the waveform becomes as per the left figure.

7. Focus offset

Connection

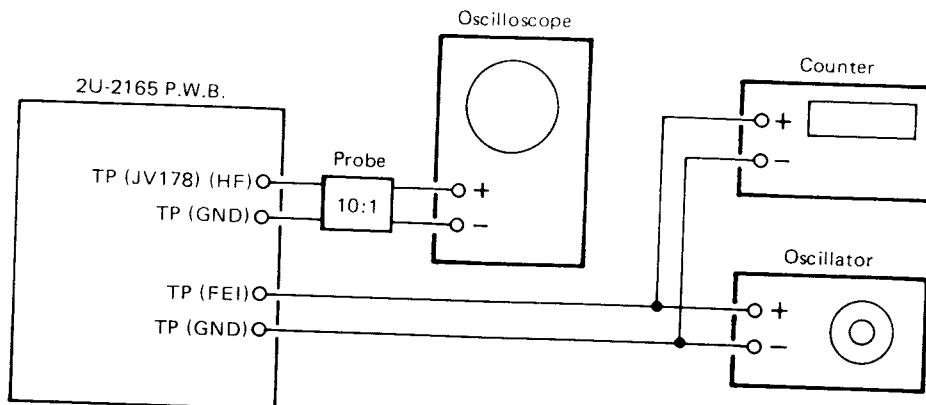

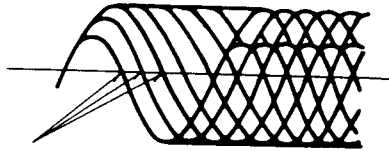
Oscillator	Counter	Oscilloscope		Adjust	Check
		V	H	(Volume)	(Oscilloscope)
580 Hz 1 Vp-p (±0.1V)	580 Hz	50 mV/div or 20 mV/div	0.2 μs/div or 0.5 μs/div	VR103	 Adjust to minimize pattern jitter.
		● Set input mode to ALTERNATE or CHOPPER.			

Step

1. Push **|| PAUSE**.
2. Set oscillator to 580 Hz, 1 Vp-p (±0.5 V).
3. VR 103 [F-OFFSET] to minimize pattern jitter.

- If the focus offset is not properly adjusted, causing the increase of jitter amount thus producing the intermittent sound may occur.

8. Tracking gain

Connection

• Caution: Connect oscillator after **|| PAUSE** pushed and servo function started.

Oscillator	Counter	Oscilloscope		Adjust (Volume)	Check (Oscilloscope)	Step
		V	H			
<ul style="list-style-type: none"> • 1.8 kHz (±120 Hz) • 3 Vp-p (±0.1V) 	1.8 kHz (±120 Hz)			VR104	<p>Y axis</p> <p>X axis</p> <p>Phase 90°</p> <p>Waveform not right</p> <p>X axis</p> <p>Y axis</p> <p>X axis</p> <p>Y axis</p>	<ol style="list-style-type: none"> 1. Push PAUSE. 2. Connect oscillator. 3. Set oscillator to 1.8 kHz/3 Vp-p. 4. Switch oscilloscope input to X-Y mode. 5. Adjust VR104 [T-GAIN] to symmetrize Lissajous figures to X-Y axes. <ul style="list-style-type: none"> • If the focus gain is not properly adjusted the waveform becomes as per the left figure.

9. Tracking offset adjustment check

- (1) Adjust tracking offset again.
- (2) Push **■ STOP** and stop disc.
- (3) Push **▶ PLAY** and check disc turns.

Note: If disc does not turn, push **▶ PLAY** again and check track number **02** is displayed.

- (4) Check oscilloscope waveform upper and lower amplitude are same to base line.
(Difference of vertical amplitude should be within the range of 5% to the base line.)
- (5) In case the height of waveform differs adjust with the VR101.
- (5) Push **■ STOP** and stop disc.
- (6) Push **▲ OPEN/CLOSE** and remove the reference disc.

HEAT RUN MODE FUNCTION

Heat Run Mode

1) To activate

While hold pushing 1, 4, 7, simultaneously, turn the unit power on. The remote control sensor indicator will light to show that the unit is shifted in Heat Run mode.

Be sure to load the disc previously.

Press the disc holder open/close button (▲ OPEN/CLOSE) to cancel Heat Run Mode.

Never push the PAUSE button.

2) Operation

During the Heat Run mode to shift the unit in Play mode makes the unit replays from the first music after opens the loader once and re-closes it when finish playing the last track (comes into lead out).

Hereafter, operates open/close of loader, servo on, reading of TOC, and playing repeatedly, For a disc with more than 30 tracks, repeat playing the two tracks; the first and the last ones.

3) Error Message

When the system error occurs while in Heat Run mode, the following error message will display on the Track No. indicator and stops operation.

1. E1

At the time of Focus Servo does not activate.

2. E2

When unable to detect synchronous pattern however the disc is in rotating. (GFS does not drive.)

3. E3

No synchronous pattern can be detected while in Play mode. (No GFS drives.)

4. E4

When TOC is unreadable in despite of servo is activated.

5. E5

In case of loader malfunctions. (Unable to turn on the switch.)

6. E6

The inner circle switch of Pick-up does not turn off.

7. E7

The inner circle switch of Pick-up does not turn on.

★ Also, displays the number of operation up to this time on the Time (Min.) indicator.

IC TERMINAL FUNCTION

CXA1081S Terminal Function

Terminal No.	Terminal Symbol	I/O	DC voltage (V)	Terminal Function
1	RFI	I	0	Input terminal of capacitance coupled RF summing amplifier output.
2	RFO	O	V _{RFO}	Terminal for RF summing amplifier output. Check point of Eye pattern.
3	RF(-)	I	0	Feedback input terminal of RF summing amplifier.
4	P/N	I	0 (VC)	P-sub/N-sub shifting terminal for Laser Diode (LD). (DC voltage: at N-sub.)
5	LD	O	-1.8	Output terminal of APC (Automatic Power Control) LD amplifier. (DC voltage: at N-sub, PD opened.)
6	PD	I	0	Input terminal of APC (Automatic Power Control) PD amplifier. (DC voltage: opened.)
7	PD1	I	0	Reverse input terminal of RF I-V amplifier (1). Receives an input current through A + C terminals of photo diode.
8	PD2	I	0	Reverse input terminal of RF I-V amplifier (2). Receives an input current through B + D terminals of photo diode.
9	VC	—	0	At ± dual-power supply: Becomes GND. At mono-power supply: Becomes VR. (connect to pin 14.)
10	F	I	0	Reverse input terminal of F I-V amplifier. Receives an input current through F terminal of photo diode.
11	E	I	0	Reverse input terminal of E I-V amplifier. Receives an input current through E terminal of photo diode.
12	EO	O	0	Output terminal of E I-V amplifier.
13	EI	I	0	Feedback input terminal of E I-V amplifier. For gain controlling of E I-V amplifier.
14	VR	O	V _{CV0}	Output terminal of DC voltages (V _{CC} + V _{EE})/2.
15	CC2	I	1.0	Input terminal of capacitance coupled detect bottom hold output.
16	CC1	O	1.2	Output terminal of defect bottom hold.
17	V _{EE}	—	-2.5	At ± dual-power supply: Becomes negative power supply terminal. At mono-power supply: Becomes GND.
18	FE BIAS	I	0	Bias terminal for non-reverse side of focus error amplifier. For CMR controlling of focus error amplifier.
19	FE	O	V _{FEO}	Output terminal of focus error amplifier.
20	TE	O	V _{TE0}	Output terminal of tracking error amplifier.
21	DEFECT	O	V _{DFCTL}	Output terminal of defect comparator. (DC voltage: Connect a 10 kΩ load resistance.)
22	MIRR	O	V _{MIRL}	Output terminal of MIRR comparator. (DC voltage: Connect a 10 kΩ load resistance.)
23	CP	I	-1.3	Connecting terminal for MIRR hold capacitor. Non-reverse input terminal of MIRR comparator.
24	CB	I	0	Connecting terminal for defect bottom hold capacitor.
25	D GND	—	-2.5	At ± dual-power supply: GND. At mono-power supply: GND (V _{EE}).
26	ASY	I	—	Input terminal of auto-asymmetry control.
27	EFM	O	V _{EFMH}	Output terminal of EFM comparator. (DC voltage: Connect a 10 kΩ load resistance.)
28	FOK	O	V _{FOKL}	Output terminal of focus OK comparator. (DC voltage: Connect a 10 kΩ load resistance.)
29	LD ON	I	-2.5 (D GND)	ON/OFF shifting terminal for laser diode (LD). (DC voltage: At LD ON.)
30	V _{CC}	—	2.5	Positive power supply terminal.

CXA1081S

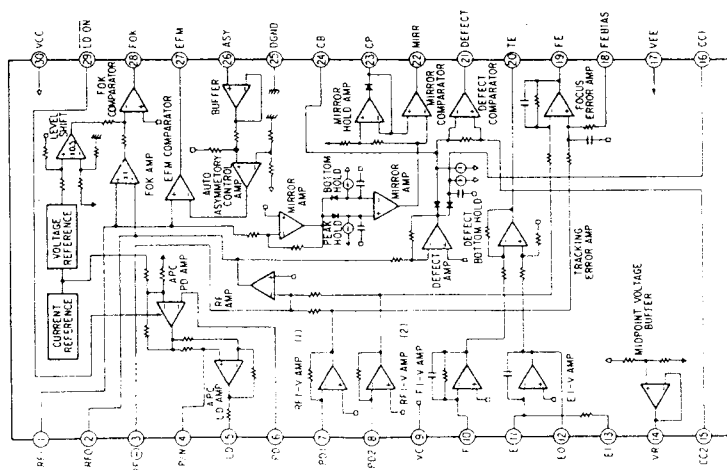

CXA1372S Terminal Function

Terminal No.	Symbol	I/O	Terminal Function
1	TE	I	Tracking error signal input terminal.
2	TDFCT	I	Capacitor connecting terminal for time constant at the time of defect.
3	ATSC	I	Input terminal of ATSC detecting window comparator.
4	FZC	I	Input terminal of focus zero-cross comparator.
5	FE	I	Focus error signal input terminal.
6	FDCT	I	Capacitor connecting terminal for time constant at the time of defect.
7	Vc	I	Mid-point voltage input terminal.
8	FGD	I	In case of reducing higher range gain of focus servo, connect a capacitor between this terminal and terminal number (9).
9	FS3	I	Shifts higher range gain of focus servo by FS3 ON/OFF.
10	FLB	I	Terminal for external time constant to increase lower range of focus servo.
11	FEO	O	Focus drive output.
12	FE-	I	Reverse input terminal for focus amplifier.
13	SRCH	I	Terminal for external time constant to make focus search waveform.
14	TGU	I	Terminal for external time constant to shift higher range gain of tracking.
15	TG2	I	Terminal for external time constant to shift higher range gain of tracking.
17	TAO	O	Tracking drive output.
18	TA-	I	Reverse input terminal for tracking amplifier.
19	SL+	I	Non-reverse input terminal for sled amplifier.
20	SLO	O	Sled drive output.
21	SL-	I	Reverse input terminal for sled amplifier.
22	FSET	I	Terminal to compensate peak in focus/tracking phase.
23	ISET	I	Delivers a current to set the height of focus search, track jump, and sled kick.
24	SSTOP	I	Terminal for limit switch ON/OFF to detect disc innermost circle.
26	DIRC	I	Terminal is used at the time of 1 track jump. A 47 kohm pull up resistor is included.
27	LOCK	I	Reckless drive protection circuit of sled; activates at "L". A 47k ohm pull up resistor is included.
28	CLK	I	Serial data transfer clock input from CPU.
29	XLT	I	Latch input from CPU.
30	DATA	I	Serial data input from CPU.
31	XRST	I	Reset input terminal. Resets at "L".
32	C.OUT	O	Terminal to output signal for track number count.
33	SENS	O	Terminal to output FZC, AS, TZC, SSTOP by command from CPU.
35	MIRR	O	Output terminal for MIRR comparator.
36	DFCT	O	Output terminal for DEFECT comparator.
37	ASY	I	Input terminal for auto-symmetric control.
38	EFM	O	Output terminal for EFM comparator.
39	FOK	O	Output terminal for focus OK (FOK) comparator.
40	CC1	O	DEFECT bottom hold output terminal.
41	CC2	I	Input terminal to input DEFECT bottom hold output by capacitance combination.
43	CB	I	Capacitor connecting terminal for DEFECT bottom hold.
44	CP	I	MIRR hold capacitor connecting terminal. A non-reverse input terminal for MIRR comparator.
45	RFI	I	Input terminal to input RF summing amplifier output by capacitance combination.
46	RFO	O	Output terminal for RF summing amplifier. Check point for eye pattern.
48	TZC	I	Tracking zero-cross comparator input terminal.

CXA1372S

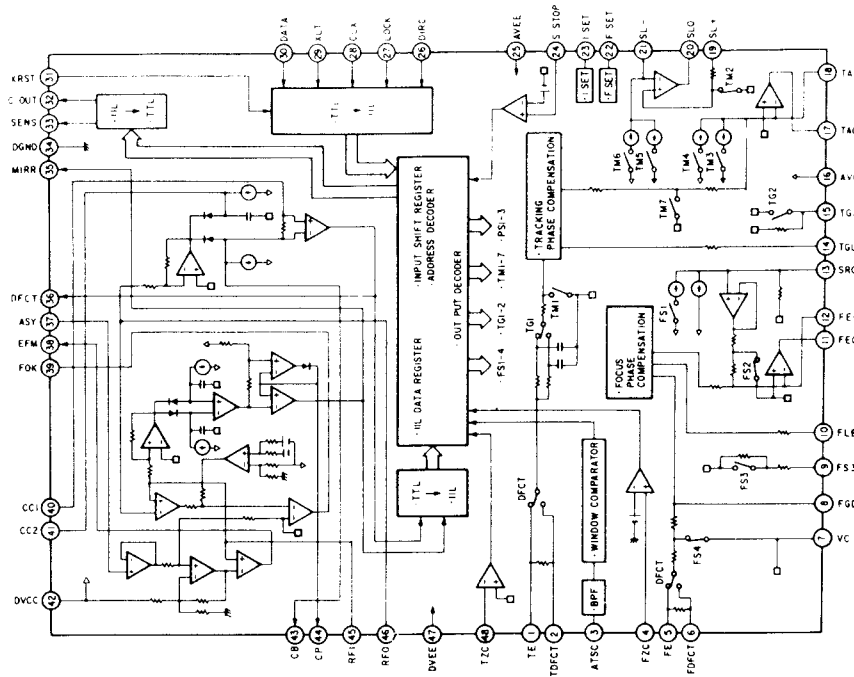

CXD2500Q Terminal Function

Terminal No.	Symbol	I/O	Terminal Function
1	FOK	I	Input terminal for OK focussing. Use for Servo-autosequencer.
2	FSW	O	Output to shift time constant of output filter for spindle motor.
3	MON	O	ON/OFF control output for spindle motor.
4	MDP	O	Servo control for spindle motor.
5	MDS	O	Servo control for spindle motor.
6	LOCK	O	Sampling GFS by 460 Hz and if it is "H", delivers "H" ; if it is continuously "L" 8 times, delivers "L".
7	NC	—	
8	VCOO	O	Oscillation current output for analog EFM PLL.
9	VCOI	I	Oscillation current output for analog EFM PLL. f LOCK=8.6436MHz.
10	TEST	I	TEST output. Normally GND.
11	PDO	O	Charge pump output for analog EFM PLL.
12	Vss		GND.
13	NC	—	
14	NC	—	
15	NC	—	
16	VPCO	O	Charge pump output for variable pitch PLL.
17	VCKI	O	Clock input from external VCO for variable pitch. fc center=16.9344MHz.
18	FILO	O	Filter output for master PLL. (slave=digital PLL)
19	FILI	I	Filter input for master PLL.
20	PCO	O	Charge pump output for master PLL.
21	AVss		Analog GND.
22	CLTV	I	Control voltage output for master VCO.
23	AVDD		Analog power supply (+5V).
24	RF	I	EFM signal input.
25	TEST2	I	Put to GND.
26	TEST3	I	Put to GND.
27	ASYO	O	Full swing output for EFM. (L=Vss, H=VDD).
28	TEST4	I	Put to GND.
29	NC	—	
30	PSSL	I	Input to shift output mode of audio data. Serial output at L; parallel output at H.

Terminal No.	Symbol	I/O	Terminal Function
31	WDCK	O	D/A Interface for 48 bit slot. Word-clock $f=2 F_s$.
32	LRCK	O	D/A Interface for 48 bit slot. LR-clock $f= F_s$.
33	V _{DD}		Power supply (+5V).
34	DA16	O	At PSSL=1 for DA16 (MBS) output; PSSL=0 for serial data of 48 bit slot. (2s'COMP, MSB first).
35	DA15	O	At PSSL=1 for DA15 output; PSSL=0 for bit clock of 48 bit slot.
36	DA14	O	At PSSL=1 for DA14 output; PSSL=0 for serial data of 64 bit slot. (2s'COMP, LSB first).
37	DA13	O	At PSSL=1 for DA13 output; PSSL=0 for bit clock of 64 bit slot.
38	DA12	O	At PSSL=1 for DA12 output; PSSL=0 for LR clock of 64 bit slot.
39	DA11	O	At PSSL=1 for DA11 output; PSSL=0 for GTOP output.
40	DA10	O	At PSSL=1 for DA10 output; PSSL=0 for XUGF output.
41	DA09	O	At PSSL=1 for DA09 output; PSSL=0 for XPLCK output.
42	DA08	O	At PSSL=1 for DA08 output; PSSL=0 for GFS output.
43	DA07	O	At PSSL=1 for DA07 output; PSSL=0 for RFCK output.
44	DA06	O	At PSSL=1 for DA06 output; PSSL=0 for C2PO output.
45	DA05	O	At PSSL=1 for DA05 output; PSSL=0 for XRAOF output.
46	DA04	O	At PSSL=1 for DA04 output; PSSL=0 for MNT3 output.
47	DA03	O	At PSSL=1 for DA03 output; PSSL=0 for MNT2 output.
48	DA02	O	At PSSL=1 for DA02 output; PSSL=0 for MNT1 output.
49	DA01	O	At PSSL=1 for DA01 output; PSSL=0 for MNT0 output.
50	APTR	O	Control output for aperture compensation. In H for R-ch.
51	APTL	O	Control output for aperture compensation. In H for L-ch.
52	V _{SS}		GND.
53	X _{TAL}	I	X'tal oscillation circuit input. By selecting of mode, $f=16.9344\text{MHz}$ or 33.8688MHz .
54	X _{TAO}	O	X'tal oscillation circuit input. $f=16.9344\text{MHz}$.
55	X _{TSL}	I	Selection input terminal of X'tal. "L" for X'tal 16.9344MHz ; H for 33.8688MHz .
56	F _{STT}	O	2/3 Dividing output of 53 and 54 terminal. No change by variable pitch.
57	C _{4M}	O	4.2336MHz output. When variable pitched, simultaneously changes.
58	C _{16M}	O	16.9344MHz output. When variable pitched, simultaneously changes.
59	MD2	I	Digital-out ON/OFF control. ON at H; OFF at L.
60	D _{OUT}	O	Digital-out output terminal.
61	EMPH	O	When playback disc emphasized, outputs H; otherwise outputs L.
62	WFCK	O	WFCK (Write Flame Clock) output.
63	SCOR	O	Output of subcode sync. S0+S1. H output when either one detected.
64	SBSO	O	Serial output of Sub P~W.
65	EXCK	I	Clock input for SBSO read-out.
66	SQSO	O	Output for Sub Q 80 bits and PCM peak level 16 bits.
67	SQCK	I	Clock input for SQSO read-out.
68	MUTE	I	Mute at H; remove mute at L.
69	SENS	—	SENS output. Outputs to CPU.
70	XRST	I	System reset input. Resets at "L".
71	DATA	I	Input of serial data from CPU.
72	XLAT	I	Input for latch from CPU. Latches serial data at release.
73	V _{DD}		Power supply (+5V).
74	C _{LOCK}	I	Serial data transfer clock input from CPU.
75	SEIN	I	SENS input from SSP.
76	CNIN	I	Input of tracking pulse.
77	D _{ATO}	O	Serial data output to SSP.
78	XL _T O	O	Serial data latch output to SSP.
79	CL _K O	O	Serial data transfer clock output to SSP.
80	MIRR	I	Mirror signal input. Use for track jump for over 128 tracks, using autosequencer.

CXD2500Q

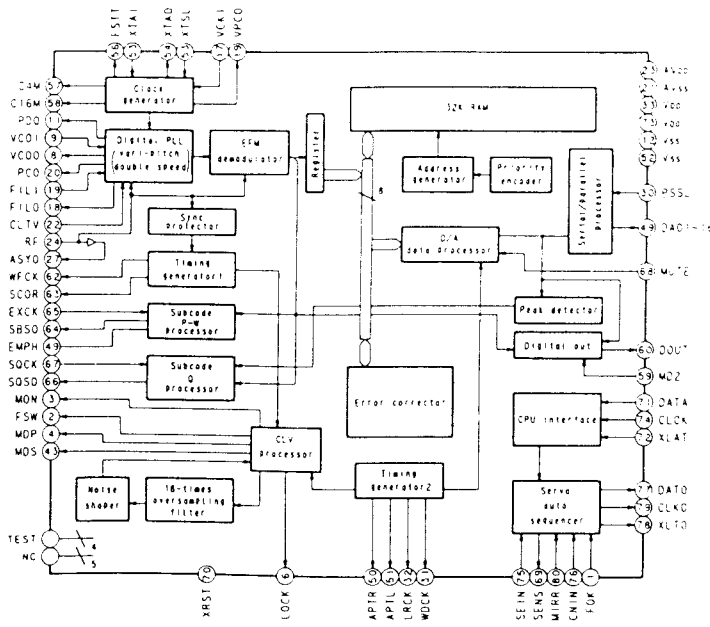

NOTE FOR PARTS LIST

- Part indicated with the mark "⊙" are not always in stock and possibly to take a long period of time for supplying, or in some case supplying of part may be refused.
- When ordering of part, clearly indicate "1" and "I" (i) to avoid mis-supplying.
- Ordering part without stating its part number can not be supplied.
- Part indicated with the mark "★" is not illustrated in the exploded view.

WARNING:
 Parts marked with this symbol have critical characteristics.
 Use ONLY replacement parts recommended by the manufacturer.

● Resistors

Ex.: RN 14K 2E 182 G FR

Type	Shape and performance	Power	Resistance	Allowable error	Others
RD : Carbon		2B : 1/4W	F : ±1%	P : Pulse-resistant type	
RC : Fixed		2E : 1/4W	G : ±2%	NL : Low noise type	
RS : Metallic film		2H : 1/2W	J : ±5%	NB : Non-burning type	
RW : Winding		3A : 1W	K : ±10%	FR : Fuse resistor	
RN : Metal film		3D : 2W	M : ±20%	F : Lead wire forming	
RK : Metal mixture		3F : 3W			
		3H : 5W			

Resistance
 1 8 2 \Rightarrow 1800Ω = 1.8kΩ
 T Indicates number of zeros after effective number
 2-digit effective number, decimal point indicated by R.
 • Units: Ω

● Capacitors

Ex.: CE 04W 1H 2R2 M BP

Type	Shape and performance	Dielectric strength	Capacity	Allowable error	Others
CE : Aluminum foil electrolyte		0J : 6.3V	F : ±1%	HS : High stability type	
CA : Aluminum solid electrolyte		1A : 10V	G : ±2%	BP : Non-polar type	
CS : Tantalum electrolyte		1C : 16V	J : ±5%	HR : Ripple-resistant type	
CO : Film		1E : 25V	K : ±10%	DL : For charge and discharge	
CK : Ceramic		1V : 35V	M : ±20%	HF : For assuring high frequency	
CC : Ceramic		1H : 50V	Z : +80%	U : UL part	
CP : Oil		2A : 100V	±20%	C : CSA part	
CM : Mica		2B : 125V	P : +100%	W : UL-CSA type	
CF : Metallized		2C : 160V	-0%	F : Lead wire forming	
CH : Metallized		2D : 200V	C : ±0.25pF		
		2E : 250V	D : ±0.5pF		
		2H : 500V	= : Others		
		2J : 630V			

Capacity
 2 R 2 \Rightarrow 2.2μF
 T 1-digit effective number, decimal point indicated by R.
 2-digit effective number, decimal point indicated by R.

- Units: μF, (for P, pF (μμF))
- When the dielectric strength is indicated in AC, "AC" is included after the dielectric strength value.

PARTS LIST OF P.W.BOARD

2U-2165 SIG. AUDIO UNIT

Ref. No.	Part No.	Part Name	Remarks
SEMICONDUCTOR GROUP			
IC101	262 1305 001	CXA1372S	
IC102	262 0842 002	CXA-1081S	
IC103	263 0565 007	BA15218	
IC105	263 0565 007	BA15218	
IC201	262 1304 002	CXD2500Q (80P-QFP)	
IC202	262 1395 008	M50959-404SP	
IC203	262 1059 0S1	TC74HCT04P	
IC204	262 0824 004	SN74LS624N	
IC205,206	262 1180 006	CF37606	
IC207	272 1306 000	SM5840AP	
IC208	262 1394 009	SM5828	
IC209	262 1265 002	TC74HCU04AP	
IC210	263 0423 000	M51953B	
IC211	262 1318 001	TC74HC00AP	
IC212	263 0565 007	BA15218	
IC301-304	263 0723 001	AD1862N	
IC309-312	263 0360 008	NE5532 (or μ PC4570)	Refer to page 33
IC313-318	262 0864 006	μ PC4570	
IC501	263 0195 005	NJM4556D	
IC801	262 1265 002	TC74HCU04AP	
IC900	263 0713 008	M5218AL	
TR101	274 0136 009	2SD1913	
TR102	272 0025 907	2SB562(C)TF	
TR103	274 0036 905	2SD468(C)TF	
TR104	272 0025 907	2SB562(C)TF	
TR105	274 0036 905	2SD468(C)TF	
TR106,107	272 0025 907	2SB562(C)TF	
TR108	274 0036 905	2SD468(C)TF	
TR109	272 0025 907	2SB562(C)TF	
TR110	274 0036 905	2SD468(C)TF	
TR111	272 0025 907	2SB562(C)TF	
TR116	274 0036 905	2SD468(C)TF	
TR117	272 0025 907	2SB562(C)TF	
TR351	269 0026 900	RN2202(10K-10K)T	
TR352	269 0025 901	RN1202(10K-10K)T	
TR353,401	271 0101 925	2SA933(Q)T-70	
TR501,502	273 0253 918	2SC2878(A/B)TPE2	
TR900,901	273 0178 925	2SC1740(R/S)T-70	
D201,351	276 0432 903	1SS270A TE	
D403	276 0501 928	HZ33L-3TD	
D404	276 0051 973	HZ7C-2TE	
D900,901	276 0432 903	1SS270A TE	
RESISTOR GROUP			
VR101,102	211 6077 912	V06PB203	20K Ω
V103	211 6077 925	V06PB103	10K Ω
VR104	211 6077 912	V06PB203	20K Ω
VR105	211 6077 983	V06PB473	47K Ω
VR301-304	211 6077 938	V06PB104	100K Ω

Ref. No.	Part No.	Part Name	Remarks
CAPACITOR GROUP			
(Ceramic)			
C109	253 1179 990	CK45B1H561KT(DD-3)	560pF/50V
C121,122	253 4536 909	CC45SL1H100CT(DD-3)	10pF/50V
C123	253 1180 921	CK45B1H102KT(DD-3)	0.001 μ F/50V
C124	253 4537 940	CC45SL1H390JT(DD-3)	39pF/50V
C128	253 4443 908	CC45SL1H201JT	200pF/50V
C129,134	253 4538 949	CC45SL1H101JT(DD-3)	100pF/50V
C135	253 9036 909	CK45=1E104ZT	0.1 μ F/25V
C141-144	253 1180 921	CK45B1H102KT(DD-3)	0.001 μ F/50V
C204	253 4536 909	CC45SL1H100CT(DD-3)	10pF/50V
C205,206,209	253 9036 909	CK45=1E104ZT	0.1 μ F/25V
C210	253 4538 949	CC45SL1H101JT(DD-3)	100pF/50V
C212	253 4535 955	CC45SL1H050CT(DD-3)	5pF/50V
C213	253 4535 939	CC45SL1H030TC(DD-3)	3pF/50V
C218	253 1180 947	CK45B1H152KT(DD-3)	0.0015 μ F/50V
C221	253 4537 937	CC45SL1H360JT(DD-3)	36pF/50V
C223-226	253 9036 909	CK45=1E104ZT	0.1 μ F/25V
C228	253 1180 921	CK45B1H102KT(DD-3)	0.001 μ F/50V
C251	253 9036 909	CK45=1E104ZT	0.1 μ F/25V
C801,802	253 1181 904	CK45F1H103ZT(DD-3)	0.01 μ F/50V
C804,805	253 9036 909	CK45=1E104ZT	0.1 μ F/25V
C806	253 1179 961	CK45B1H331KT(DD-3)	330pF/50V
C807,902	253 9036 909	CK45=1E104ZT	0.1 μ F/25V
C904	253 1181 904	CK45F1H103ZT(DD-3)	0.01 μ F/50V
(Electrolytic)			
C102,103	254 4260 919	CE04W1HR22MT(SME)	0.22 μ F/50V
C117	254 4337 910	CE04W1H6R8MT(SME)	6.8 μ F/50V
C125	254 4368 934	CE04W1E101MT(ASF)	100 μ F/25V
C126	254 4313 905	CE04W1H3R3MT(ASF)	3.3 μ F/50V
C201	254 4313 963	CE04W1H010MT(ASF)	1 μ F/50V
C208	254 4383 906	CE04W1V330MT(ASF)	33 μ F/35V
C215	254 4289 738	CE04W1H101MC(AWF)	100 μ F/50V
C216,227	254 4260 922	CE04W1HR33MT(SME)	0.33 μ F/50V
C313-316	254 4313 963	CE04W1H010MT(ASF)	1 μ F/50V
C321-324	254 4313 918	CE04W1H100MT(ASF)	10 μ F/50V
C351	254 4368 947	CE04W1E221MT(ASF)	220 μ F/25V
C361-368	254 4289 738	CE04W1H101MC(AWF)	100 μ F/50V
C371-374	254 4387 708	CE04W1H471M(ASF)	470 μ F/50V
C403,404	254 4382 907	CE04W1C331MT(ASF)	330 μ F/16V
C503	254 4313 918	CE04W1H100MT(ASF)	10 μ F/50V
C504	254 4368 947	CE04W1E221MT(ASF)	220 μ F/25V
(Film)			
C101	255 4235 934	CQ93P2A103JT(NH)	0.01 μ F/100V
C105	255 4237 903	CQ93P2A272JT(NH)	0.0027 μ F/100V
C106	255 4232 995	CQ93P2A332JT(NH)	0.0033 μ F/100V
C107	255 4235 934	CQ93P2A103JT(NH)	0.01 μ F/100V
C110	255 4232 995	CQ93P2A332JT(NH)	0.0033 μ F/100V
C115	255 4232 982	CQ93P2A222JT(NH)	0.0022 μ F/100V
C127	255 4235 963	CQ93P2A562JT(NH)	0.0056 μ F/100V

2U-2133 DISPLAY UNIT

Ref. No.	Part No.	Part Name	Remarks
C133	255 4235 934	CQ93P2A103JT(NH)	0.01μF/100V
C353-356	255 4235 921	CQ93P2A271JT(NH)	270pF/100V
C357-360	255 4235 918	CQ93P2A101JT(NH)	100pF/100V
C371,372	255 4232 911	CQ93P2A181JT(NH)	180pF/100V
C373,374	255 4232 908	CQ93P2A821JT(NH)	820pF/100V
C375-380	255 4237 903	CQ93P2A272JT(NH)	0.0027μF/100V
C901	255 1214 903	CQ93M1H153JT	0.015μF/50V
C903	255 1206 908	CQ93M1H332JT	0.0033μF/50V

(Metallized)

C108	256 1034 911	CF93A1H333JT	0.033μF/50V
C112	256 1034 979	CF93A1H104JT	0.1μF/50V
C112	256 1034 937	CF93A1H473JT	0.047μF/50V
C113	256 1034 979	CF93A1H104JT	0.1μF/50V
C114	256 1034 966	CF93A1H823JT	0.082μF/50V
C116	256 1034 911	CF93A1H333JT	0.033μF/50V
C118	256 1035 910	CF93A1H224JT	0.22μF/50V
C217	256 1034 937	CF93A1H473JT	0.047μF/50V
C900	256 1034 940	CF93A1H563JT	0.056μF/50V

OTHER PARTS

CB101	205 0343 087	8P CONN. BASE (KR-PH)	
CB103	205 0321 033	8P CONN. BASE (RED)	
CB106	205 0406 034	3P CONN. BASE (KR-PH)	
CB130	205 0343 087	8P CONN. BASE (KR-PH)	
CB701	205 0343 087	8P CONN. BASE (KR-PH)	
CB703	205 0233 032	3P EH CONN. BASE	
CB704	205 0233 032	3P EH CONN. BASE	
★	205 0343 032	3P CONN. BASE (KR-PH)	
★	205 0323 036	3P CONN. BASE (BLK)	
★	205 0321 038	3P CONN. BASE (RED)	
★	205 0321 041	4P CONN. BASE (RED)	
★	205 0491 010	31P FFC CONN. BASE	
★	203 4650 026	3P PH-SAN CONN. CORD	
★	204 2447 001	8P PH-SAN SHIELD CORD	

Ref. No.	Part No.	Part Name	Remarks
D601-604 709-712	276 0049 914	1S2076ATE	FL TUBE REMOTE SENSOR
	393 4095 007	FIP10SM6	
	499 0172 002	GR1U521X-38	
	205 0491 010	31P FFC CONN. BASE	
	009 0011 009	31P FFC	
	212 4699 900	TACT SWITCH	

2U-2135 POWER SUPPLY UNIT

Ref. No.	Part No.	Part Name	Remarks
IC701	263 0516 001	NJM7812FA	
IC702	263 0539 004	NJM79M12FA	
IC703	263 0553 006	NJM7805FA	
IC704	263 0501 003	NJM79M05FA	
IC705	276 0405 901	S1WB(A)10	
IC706,707	268 0074 904	ICP-N20T	
D701-704 713,714	276 0550 908	1SR139-200T-62	
C701,702	254 4289 783	CE04W1H222MC(AWF)	2200μF/50V
C703,704	254 4254 792	CE04W1C222MC(SME)	2200μF/16V
C705	254 4262 946	CE04W1J470MT(SME)	47μF/63V
C706	254 4260 906	CE04W1H0R1MT(SME)	0.1μF/50V
C900	253 8014 702	CK45F2GAC103MC	0.01μF/4.00VAC
CB703,704	205 0233 032	3P EH CONN. BASE	
	205 0581 001	2P VH CONN. BASE	
	204 2446 002	8P PH-SAN CORD	
△	212 4697 009	POWER SWITCH	
△	233 5857 007	POWER TRANS.	Europe, U.K., Australia
△	233 5858 006	POWER TRANS. (EU)	U.S.A., Canada

About for IC309, 310, 311, 312

Units with undermentioned Serial Numbers are using μPD4570 (Part No. 262 0864 004).

Version	Serial Number
Europe (Gold)	XXXXXX0511 and after
Europe (Black)	XXXXXX3521 and after
Australia	XXXXXX0101 and after
U.K.	XXXXXX0310 and after
U.S.A.	XXXXXX1421 and after
Canada	XXXXXX0301 and after

PARTS LIST OF EXPLODED VIEW

Ref. No.	Part No.	Part Name	Remarks
⊙ 1	411 1016 219	CHASSIS	
⊙ 2	105 0925 244	BACK PANEL	Europe
⊙	105 0925 260	BACK PANEL	U.S.A.
⊙	105 0925 273	BACK PANEL	Canada
⊙	105 0925 257	BACK PANEL	U.K., Australia
⊙ 3	2U- 2133	DISPLAY UNIT	
⊙ 4	105 0927 200	BOTTOM COVER	
⊙ 5	105 0926 201	INSIDE BOTTOM COVER	
⊙ 6	2U- 2165	SIG. AUDIO UNIT	
⊙ 7	2U- 2135 C	P. SUPPLY UNIT	Europe
⊙	2U- 2135 A	P. SUPPLY UNIT	U.S.A., Canada
⊙	2U- 2135 D	P. SUPPLY UNIT	U.K.
⊙	2U- 2135 E	P. SUPPLY UNIT	Australia
⚠ 8	233 5857 007	POWER TRANS.	Europe, U.K. Australia
⚠	233 5858 006	POWER TRANS. (EU)	U.S.A., Canada
⚠ 9	206 2089 009	AC CORD WITH CONN.	Europe
⚠	206 2086 002	AC CORD WITH CONN.	U.S.A., Canada
⚠	206 2090 001	AC CORD WITH CONN.	U.K.
⚠	206 2087 001	AC CORD WITH CONN.	Australia
⚠ 10	445 0056 008	CORD BUSH	
12	113 1067 238	POWER SW. LEVER ASS'Y	
	113 1067 254	POWER SW. LEVER ASS'Y	(Gold)
⊙ 13	FG 612	CD MECHA.	
⚠ 15	212 4697 009	POWER SWITCH	
16	435 0113 009	LATCH (Y3Y18)	
17	112 0572 103	VOL. KNOB	
	112 0572 116	VOL. KNOB	(Gold)
19	144 2042 133	FRONT PANEL	
	144 2042 146	FRONT PANEL	(Gold)
20	146 1191 117	SUB PANEL	
21	113 1223 027	SERIES KNOB	
	113 1223 043	SERIES KNOB	(Gold)
22	113 1223 030	SERIES KNOB	
	113 1223 056	SERIES KNOB	(Gold)
23	113 1226 231	FUNCTION KNOB ASS'Y	
	113 1226 244	FUNCTION KNOB ASS'Y	(Gold)
24	113 1387 219	OPEN/CLOSE KNOB	
	113 1387 222	OPEN/CLOSE KNOB	(Gold)
25	421 9007 007	MINI DAMPER	
⊙ 26	102 0438 004	TOP COVER	
⊙	102 0438 017	TOP COVER	(Gold)
⊙ 27	412 3126 100	TOP PLATE	
28	146 0772 003	TOP COVER WASHER	
	146 0772 016	TOP COVER WASHER	(Gold)
⊙ 29	009 0011 009	31P FFC	
30	393 4095 007	FIP10SM6	FL TUBE
31	204 8322 007	HEADPHONE JACK	
32	211 0544 111	V1620FA203M	OUTPUT VOL.
33	269 0098 006	GP1F32T	OPTICAL OUT
⊙ 34	122 0193 000	SOUND PROOF SHEET	
35	204 8265 009	4P RCA JACK	ANALOG OUT
37	144 1955 014	TRAP DOOR	
	144 1955 043	TRAP DOOR	(Gold)
38	401 0120 219	HINGE (L)	
	401 0120 329	HINGE (L)	(Gold)
39	401 0121 218	HINGE (R)	
	401 0121 328	HINGE (R)	(Gold)
40	144 2064 001	LOADER PANEL ASS'Y	
	144 2064 014	LOADER PANEL ASS'Y	(Gold)
⊙ 48	129 0155 117	RUBBER SHEET	
⊙ 49	412 3166 209	MECHA. FIX BRACKET	

Ref. No.	Part No.	Part Name	Remarks
⊙ 50	412 3167 101	TRANS. FIX BRACKET	
58	104 0194 001	FOOT ASS'Y	
59	421 9007 007	MINI DAMPER	
⊙ 61	461 0385 001	RUBBER PAD	
⊙ 62	412 2657 104	LOADER SPRING	
70	499 0172 002	GP1U521X-38	REMOTE SENSOR
71	212 4699 900	TACT SWITCH	
72	205 0491 010	31P FFC CONN. BASE	
73	204 8375 009	1P RCA PIN JACK	
102	473 7002 021	3x8 CBTS (S)-B	
	473 3806 014	3x8 CBTS (2)-N	(Gold)
104	471 9020 018	SPECIAL SCREW	
	471 9020 005	SPECIAL SCREW	(Gold)
105	473 4454 025	4x8 CTTS (2) BKZN	
	473 4801 005	4x8 CTTS (2) BKZN	(Gold)

WARNING:

- Parts marked with ⚠ and/or shading have special characteristics important to safety. Be sure to use the specified parts for replacement.
- (Gold) in the Remarks column refers to models with gold front panels.

PARTS LIST OF PACKING & ACCESSORIES

Ref. No.	Part No.	Part Name	Remarks
	504 0092 060	STYRENE PAPER	
	505 0102 092	STYRENE PAPER	
	505 0038 030	POLY COVER	
	503 0905 109	CUSHION	
	501 1478 008	CARTON CASE	
	513 9111 001	COLOR LABEL	(Gold) Only
	511 2065 006	INST. MANUAL (3)	Europe, Canada U.K., Australia U.S.A.
	511 2067 004	INST. MANUAL (EU)	U.S.A.
	511 2066 005	SWEDISH INST. MANUAL	Europe Only
	204 8121 004	2P PIN CORD	
	529 0073 004	MINI DRIVER	
	499 0178 006	REMOTE CONTROLLER	RC-232

EXPLODED VIEW OF FG-612 MECHA UNIT

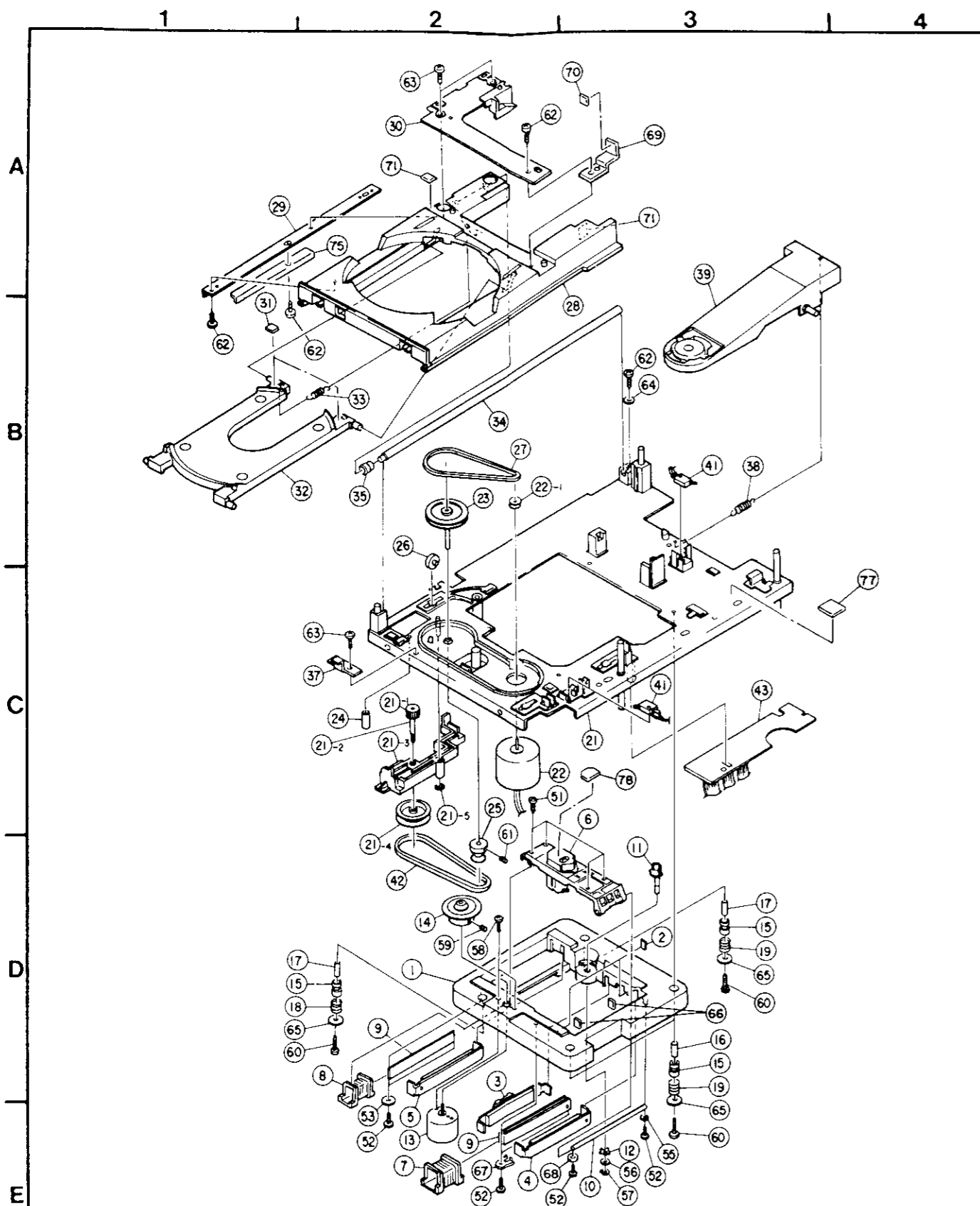

PARTS LIST OF FG-612 MECHANISM UNIT

Ref. No.	Part No.	Part Name	Remarks	Ref. No.	Part No.	Part Name	Remarks
1	315 0338 302	P.U. HOUSING		61	474 4300 033	2.6x6 BSS (A)	
2	461 0336 005	STOPPER		62	473 7508 017	3x10 CTBS (P)-B	
3	PM01A15	MAGNET SUB ASS'Y		64	475 1005 004	4W	
4	PM01A20	MAGNET SUB ASS'Y		65	412 2296 002	F-COVER	
5	PM01A21	MAGNET SUB ASS'Y (C)		66	441 1002 004	SPACER	
6	499 0078 009	PICK-UP KSS151A		67	441 0993 004	YOKE HOLDER	
7	239 0014 209	M. COIL ASS'Y		68	441 0857 001	P-RING	
8	239 0015 208	G. COIL ASS'Y		69	441 0994 003	STOPPER BRACKET	
9	433 0480 008	YOKE (B)		70	461 0336 005	STOPPER	
10	443 0617 302	P.U. SHAFT		71	122 0163 001	SPACER (M)	
11	421 0431 300	STOPPER COLLAR		75	412 2589 007	LOADER SPACER	
12	315 8451 003	FRICION WASHER		76	—	—	
13	217 0159 009	SPINDLE MOTOR		77	125 0019 028	SPACER	
14	421 0423 208	TURNTABLE		78	441 1129 000	P.U. PLATE	
15	462 0083 005	H. DAMPER					
16	433 0484 004	COLLAR (A)					
17	433 0485 100	COLLAR (B)					
18	463 0514 001	COIL SPRING (C)					
19	463 0515 000	COIL SPRING (D)					
21	411 0813 002	BASE PLATE ASS'Y					
21-1	—	DRIVE GEAR					
21-2	—	GEAR SHAFT					
21-3	—	LOCK ARM					
21-4	—	GEAR PULLEY					
21-5	476 1001 001	2E RING					
22	PLO1A34	LOADING M. SUB ASS'Y					
22-1	—	MOTOR PULLEY					
23	421 0439 108	GEAR PULLEY ASS'Y					
24	462 0084 020	TUBE					
25	421 0425 002	MOTOR PULLEY					
26	425 0170 003	SLIDER ROLLER					
27	423 0046 102	BELT (A)					
28	431 0267 403	LOADER FRAME					
29	412 2177 105	LOADER BRACKET					
30	411 0664 400	LOADER GUIDE					
31	122 0110 083	HIMERON SHEET					
32	431 0284 004	DISC TRAY ASS'Y					
33	463 0574 009	DISC TRAY SPRING					
34	443 0621 000	LOADER RAIL					
35	462 0084 004	TUBE					
36	—	—					
37	412 2512 003	BRACKET					
38	463 0598 001	CLAMPER SPRING					
39	PC01A37	CLAMPER ARM ASS'Y					
40	—	—					
41	212 4650 004	LEAF SW.					
42	423 0047 004	BELT (B)					
43	2U-1461A	TERMINAL UNIT					
51	473 8010 009	M1.7x4 #D (W) ZNB					
52	473 8014 005	3x8 CBTS (H-L) ZND					
53	475 1140 008	3 WASHER					
54	—	—					
55	475 1106 042	WASHER					
56	475 1005 017	4W BKNI					
57	441 0856 002	G-RING					
58	471 3103 025	2x6 CBS BK					
59	474 4300 004	2.6x4 BSS (A)					
60	471 1807 022	3x18 CPS BK					

2U-2133 DISPLAY UNIT

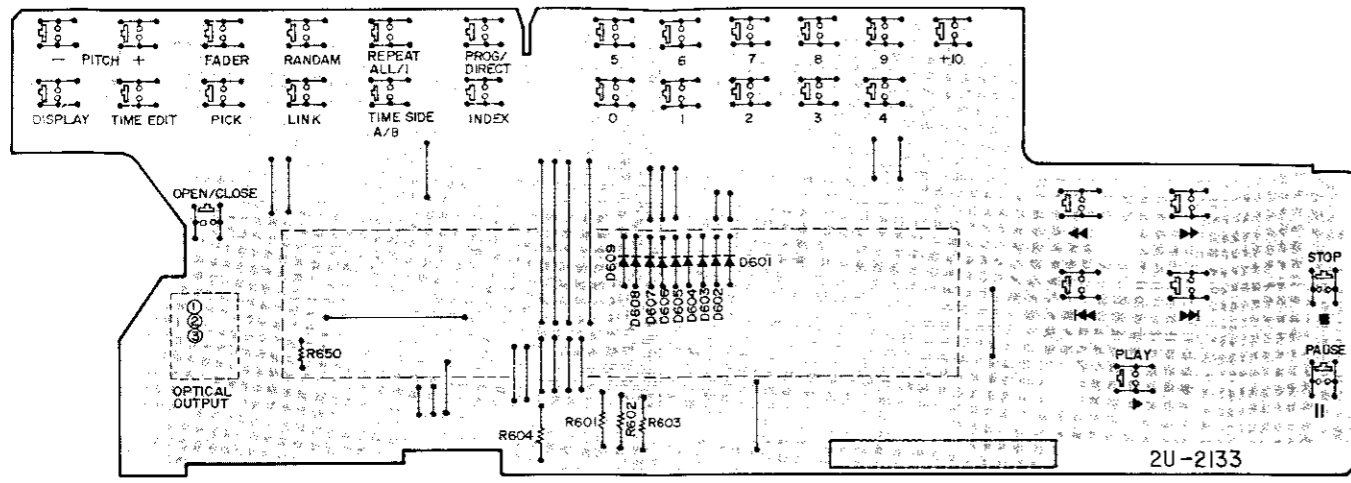

2U-2135C POWER SUPPLY UNIT (Europe model)

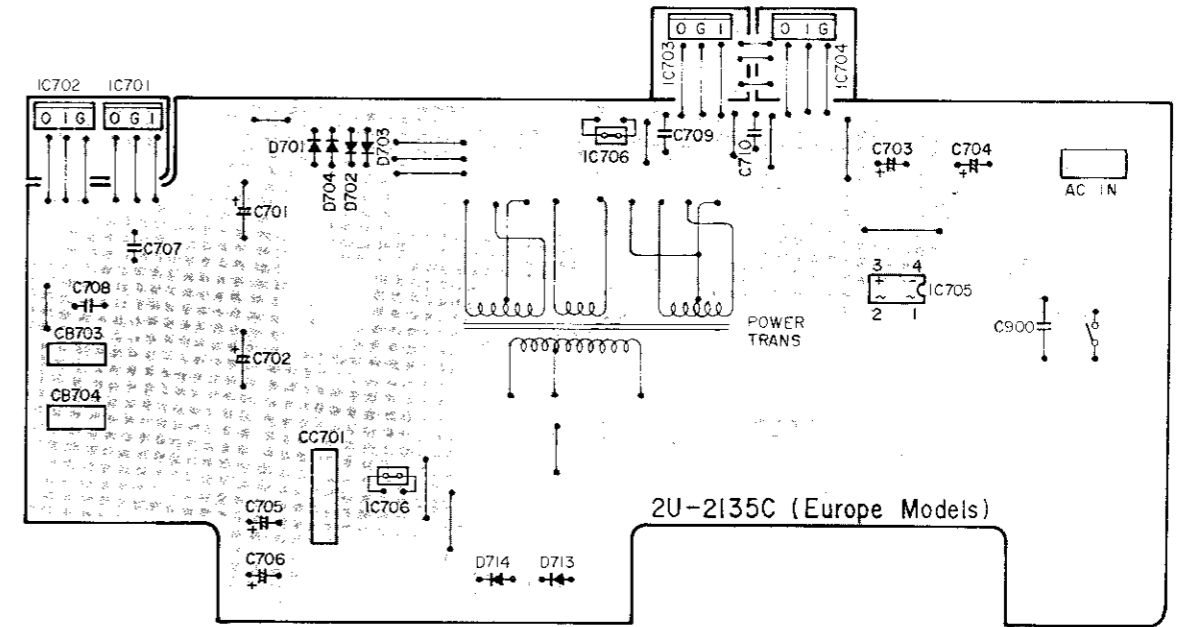

2U-2135A POWER SUPPLY UNIT (U.S.A. & Canada models)

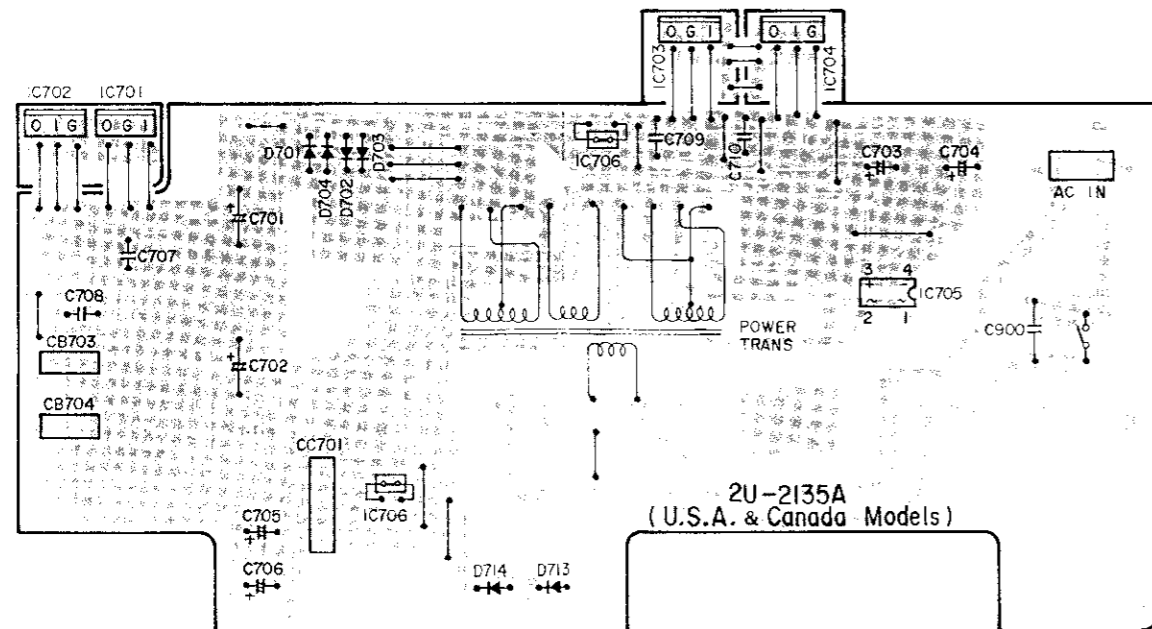

2U-2135D/E POWER SUPPLY UNIT (U.K. & Australia model)

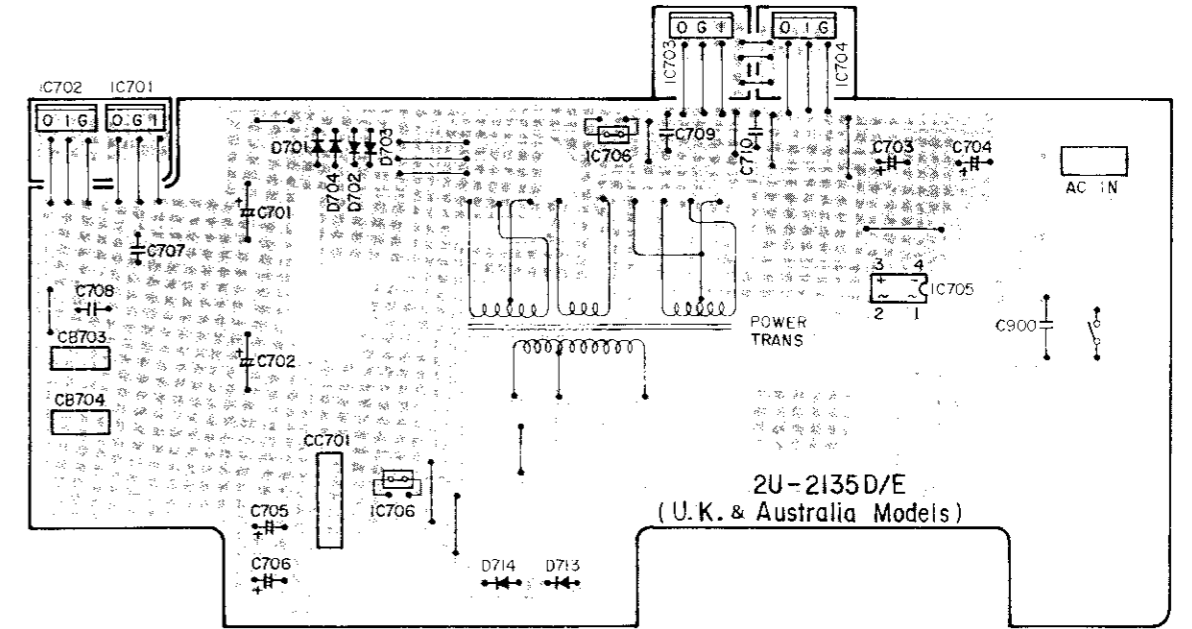

WIRING DIAGRAM

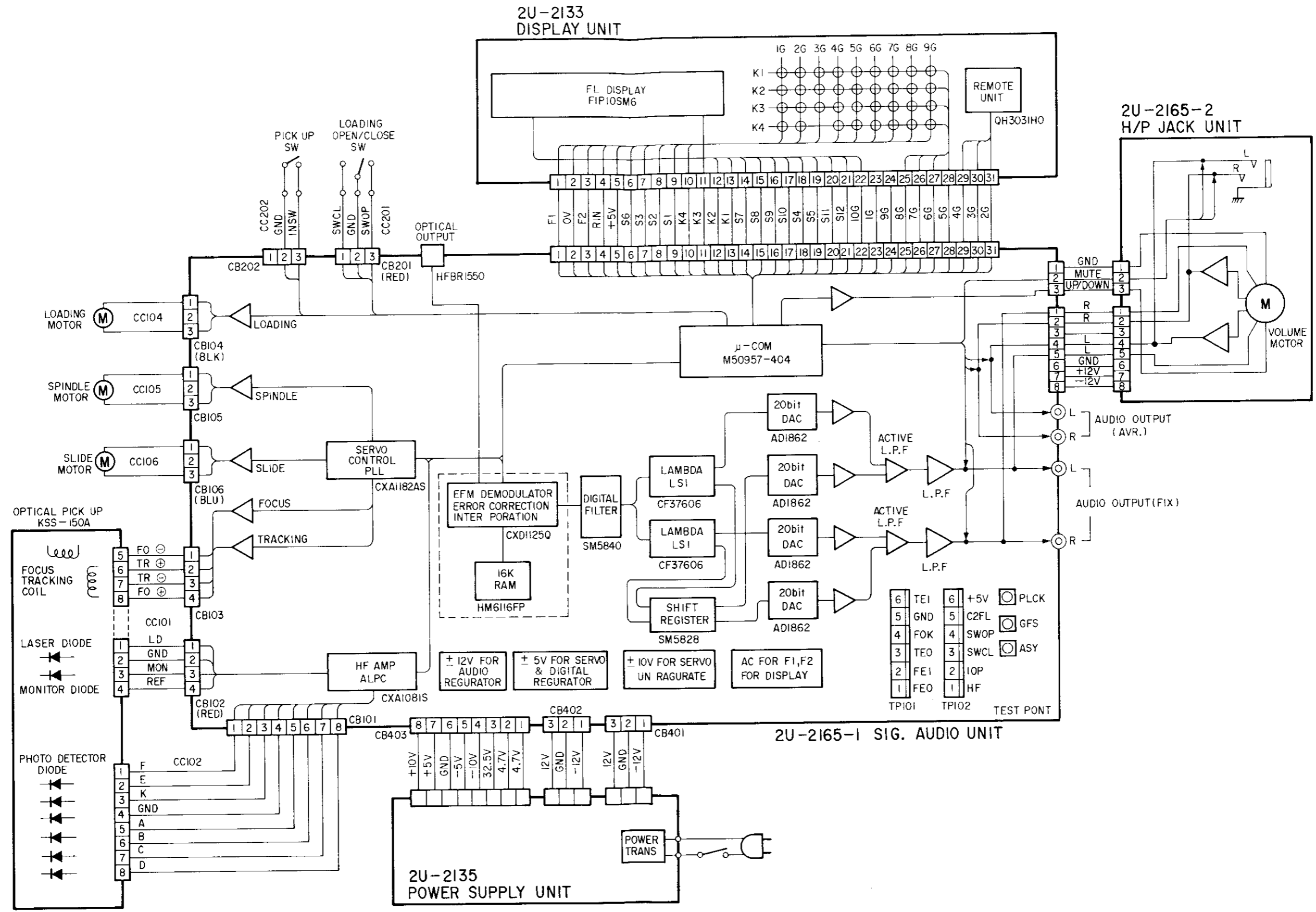

SEMICONDUCTORS

• IC's

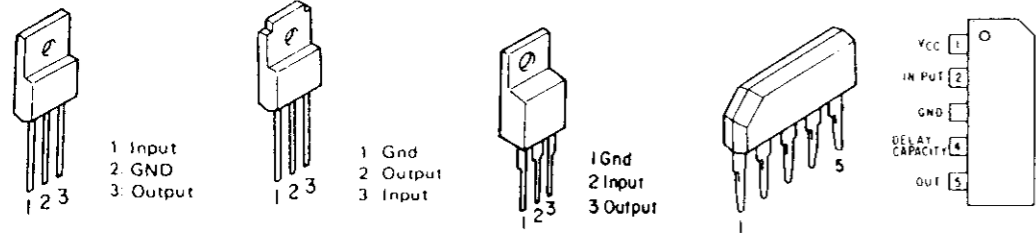

NJM7805FA

NJM79M05FA
NJM79M12FA

MC7812

M51953B

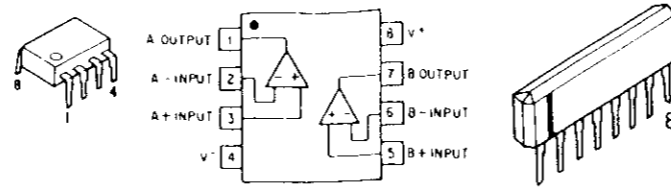

NJM4556D
μPC4570C
BA15218

M5218L

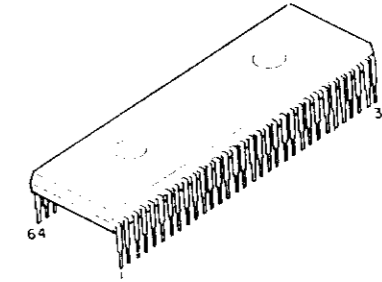
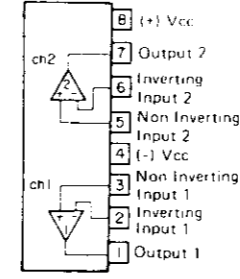

M5059-407SP

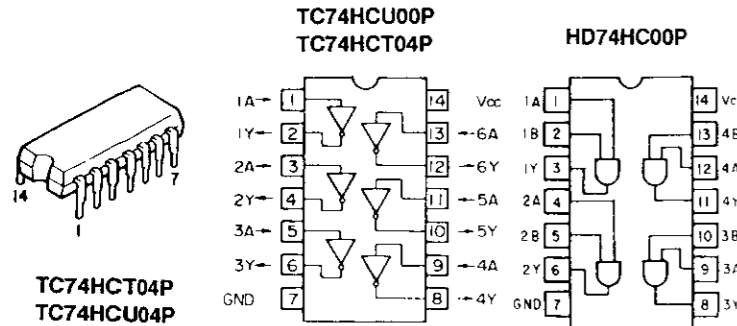
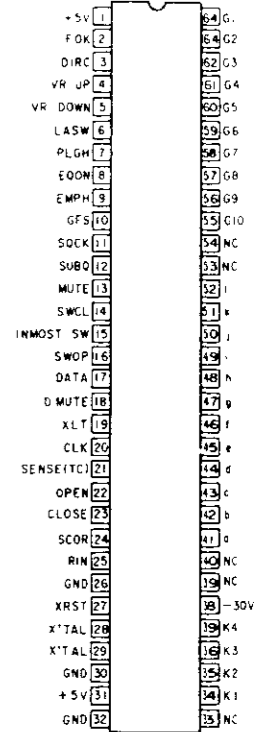

TC74HCT04P
TC74HCU04P
HD74HC00P
SN74LS624

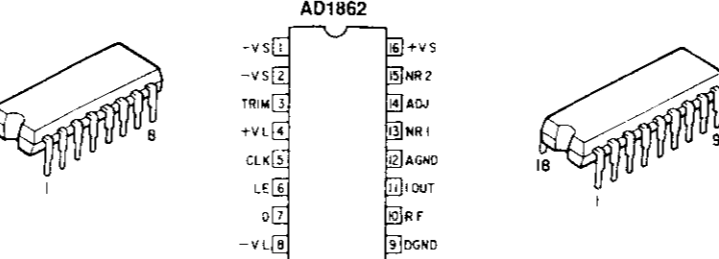

AD1862

AD1862

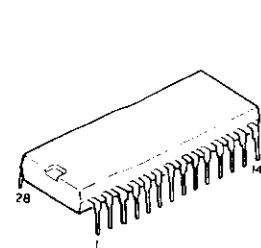
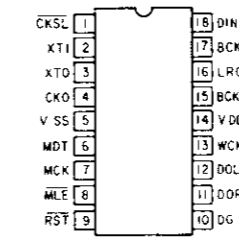

CF37606
SM-5828

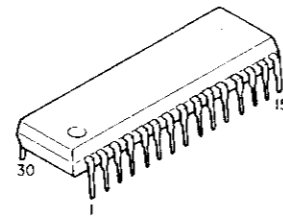
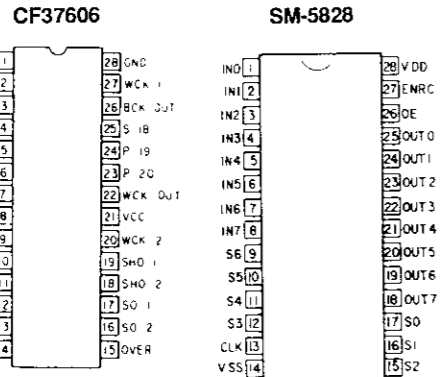

CXA1081S

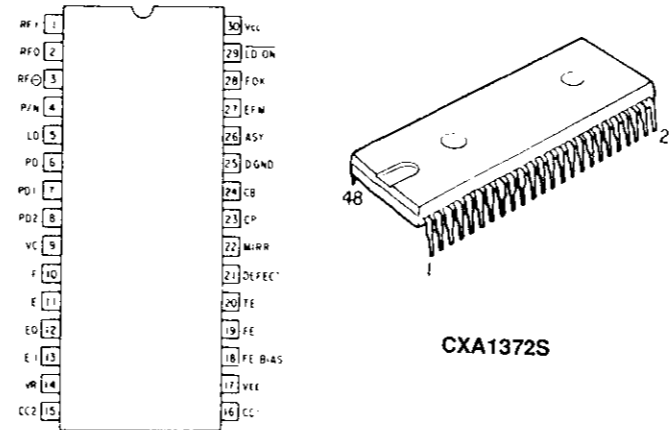

CXA1372S

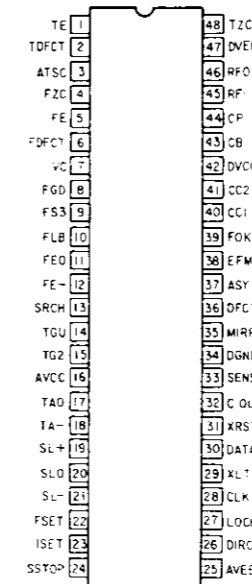

CXD2500Q

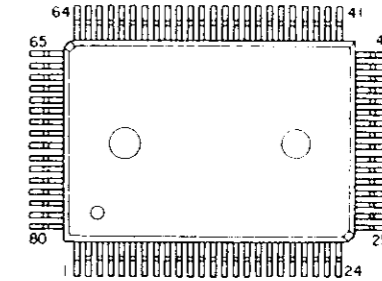

NJM78L05A

• IC PROTECTOR

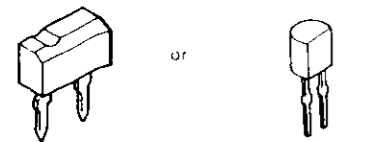

ICP-F15

ICP-N15

• TRANSISTORS

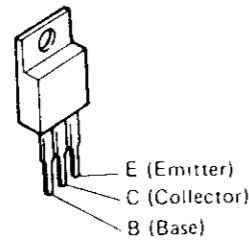

2SD1913



2SA933(Q)
2SC2878(A/B)
2SA1015(Y)
2SC1740(R/S)T-70



2SB562(C)
2SD468(C)

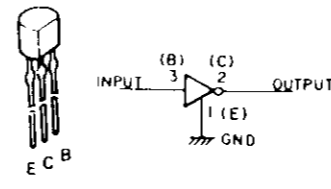

RN1202(10K-10K)NPN
RN2202(10K-10K)PNP

• DIODES

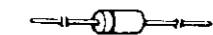

1S2076A
1SS270A
1SR35-200A

HZ7C-2
HZ33L-3

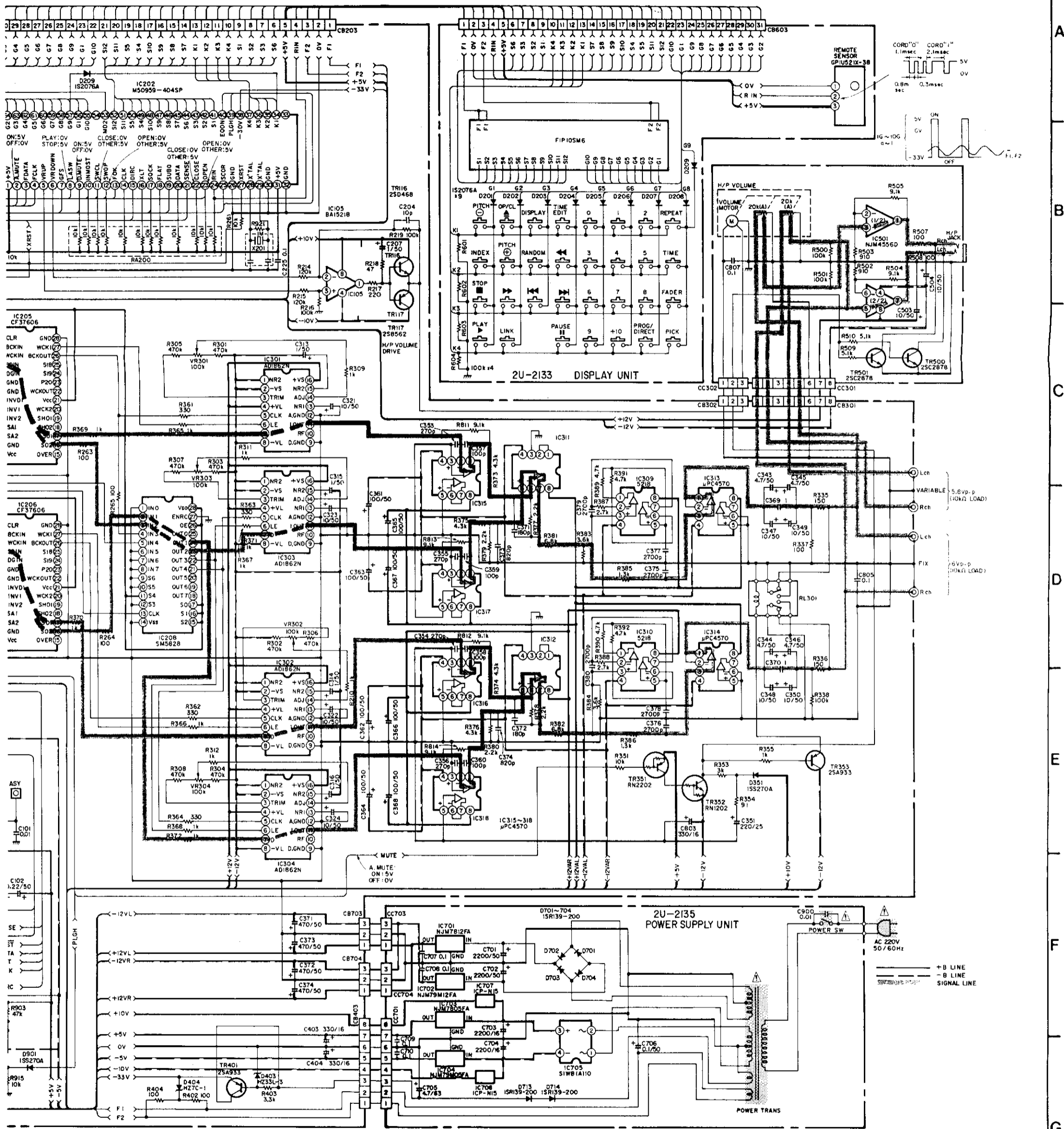

NOTES

ALL RESISTANCE VALUES IN OHM. k=1,000 OHM, M=1,000,000 OHM
 ALL CAPACITANCE VALUES IN MICRO FARAD. P=MICRO-MICRO FARAD
 EACH VOLTAGE AND CURRENT ARE MEASURED AT NO SIGNAL INPUT CONDITION.
 CIRCUIT AND PARTS ARE SUBJECT TO CHANGE WITHOUT PRIOR NOTICE.

A
B
C
D
E
F
G
H