

DENON

Hi-Fi Component

SERVICE MANUAL

MODEL DCD-S10

MODEL DCD-3000

STEREO CD PLAYER



DCD-S10



DCD-3000



— TABLE OF CONTENTS —

OPERATING INSTRUCTIONS	2-9
SPECIFICATIONS	10
DISASSEMBLY	11
ADJUSTMENT	12-15
HEAT RUN MODE FUNCTION	16
JUDGMENT STANDARDS FOR OPTICAL PICK-UP REPLACEMENT	16-20
PARTS LIST OF P.W.BOARD	21-27
IC TERMINAL FUNCTION	28-31
SEMICONDUCTORS	32-35
EXPLODED VIEW (DCD-S10 Europe, U.S.A. & Canada Models)	36
PARTS LIST OF EXPLODED VIEW	37, 38
EXPLODED VIEW (DCD-S10 Asia Model)	39
EXPLODED VIEW (DCD-3000 Europe, U.S.A. & Canada and Multi-Voltage Models)	40
PARTS LIST OF EXPLODED VIEW	41
PARTS LIST OF FG-76/77 MECHANISM UNIT	42
EXPLODED VIEW OF FG-76/77 MECHANISM UNIT	42
P.W.BOARD UNIT ASSY	43-45
WIRING DIAGRAM	46
SCHEMATIC DIAGRAM-1/3, 2/3, 3/3	47-49

NIPPON COLUMBIA CO., LTD.

IMPORTANT TO SAFETY

WARNING:

TO PREVENT FIRE OR SHOCK HAZARD, DO NOT EXPOSE THIS APPLIANCE TO RAIN OR MOISTURE.

CAUTION:

1. Handle the power supply cord carefully. Do not damage or deform the power supply cord. If it is damaged or abraded, it may cause electrical shock or malfunction when used. When removing from wall outlet, be sure to remove by holding the plug attachment and not by pulling the cord.
2. Do not open the top cover. In order to prevent electric shock, do not open the top cover, if problem occurs, contact your DENON DEALER.
3. Do not place anything inside. Do not place metal objects or small objects inside the CD player. Electric shock or malfunction may result.

Please record and retain the Model name and serial number of your set shown on the rating label.
Model No. CD-20(S10300) Serial No.



CAUTION: TO REDUCE THE RISK OF ELECTRIC SHOCK, DO NOT REMOVE COVER (OR BACK). NO USER SERVICEABLE PARTS INSIDE. REFER SERVICING TO QUALIFIED SERVICE PERSONNEL.

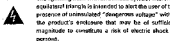

This lightning flash with attached symbol within an equilateral triangle is intended to alert the user of the presence of unshielded "dangerous voltage" within the product's enclosure that may be of sufficient magnitude to constitute a risk of electric shock to persons.



The exclamation point within an equilateral triangle is intended to alert the user of the presence of important operating and maintenance (servicing) instructions in the literature accompanying this appliance.

NOTE:

This CD player uses the semiconductor laser. To allow you to enjoy music in a better operation, it is recommended to use inside a room of 15°C (59°F) to 35°C (95°F).

CAUTION:

USE OF CONTROLS OR ADJUSTMENTS OR PERFORMANCE OF PROCEDURES OTHER THAN THOSE SPECIFIED HEREIN MAY RESULT IN HAZARDOUS RADIATION EXPOSURE.

THE COMPACT DISC PLAYER SHOULD NOT BE ADJUSTED OR REPAIRED BY ANYONE EXCEPT PROPERLY QUALIFIED SERVICE PERSONNEL.

NOTE:

This unit may cause interference to radio and television reception if it is not operated in strict accordance with the OPERATING INSTRUCTIONS.

This unit complies with Class B computing device rules in accordance with the specifications in Subpart J of Part 15 of the FCC Rules, which are designed to provide reasonable protection against such interference in a residential installation. If the unit does cause interference to any radio or television reception, try to reduce it by one or more of the following means:

- a) Turn the other unit to improve reception
- b) Move the unit
- c) Move the unit away from other sets
- d) Plug this unit respectively into a different AC outlet

* This is extra in accordance with Section 15.108 of the FCC Rules.

* FOR U.S.A. & CANADA MODEL ONLY

CAUTION

TO PREVENT ELECTRIC SHOCK DO NOT USE THIS POLARIZED PLUG WITH AN EXTENSION CORD, RECEPTACLE, OR OTHER OUTLET UNLESS THE SLICES CAN BE FULLY INSERTED TO PREVENT SLICE EXPOSURE.

* POUR LES MODELES AMERICAINS ET CANADIENS UNiquement

ATTENTION







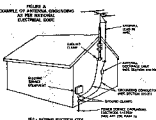

POUR PREVENIR LES CHOCS ELECTRIQUES NE PAS UTILISER CETTE FICHE POLARISEE AVEC UN PROLONGATEUR UNE PRISE DE COURANT EN UNE AUTRE SORTIE DE COURANT, SAUF SI LES LAMES PERMETTENT ETRE INSEREES A FOND SANS EN LAISSER AUCUNE PARTIE A DECOUVERT.

SAFETY INSTRUCTIONS

1. Read Instructions - All the safety and operating instructions should be read before the appliance is operated.
2. Retain Instructions - The safety and operating instructions should be retained for future reference.
3. Heed Warnings - All warnings on the appliance and in the operating instructions should be adhered to.
4. Follow Instructions - All operating and use instructions should be followed.
5. Water and Moisture - The appliance should not be used near water - for example, near a bathtub, washbasin, kitchen sink, laundry tub, in a wet basement, or near a swimming pool, and the like.
6. Cords and Strands - The appliance should be used only with a cord or stand that is recommended by the manufacturer.
- 6A. An appliance and cart combination should be moved with care. Quick stops, excessive force, and uneven surfaces may cause the appliance and cart combination to overturn.
7. Wall or Ceiling Mounting - The appliance should be mounted to a wall or ceiling only as recommended by the manufacturer.
8. Ventilation - The appliance should be situated so that its location or position does not interfere with its proper ventilation. For example, the appliance should not be situated on a bed, sofa, rug, or similar surface that may block the ventilation opening; or placed in a built-in installation, such as a bookcase or cabinet that may impede the flow of air through the ventilation openings.
9. Heat - The appliance should be situated away from heat sources such as radiators, heat registers, stoves, or other appliances (including amplifiers) that produce heat.
10. Power Sources - The appliance should be connected to a power supply only of the type described in the operating instructions or as marked on the appliance.
11. Grounding or Polarization - Precautions should be taken so that the grounding or polarization means of an appliance is not defeated.
12. Power-Cord Protection - Power-supply cords should be routed so that they are not likely to be walked on or pinched by items placed upon or against them, paying particular attention to cords at plugs, convenience receptacles, and the point where they exit from the appliance.
14. Cleaning - The appliance should be cleaned only as recommended by the manufacturer.
15. Power Lines - An outdoor antenna should be located away from power lines.
16. Outdoor Antenna Grounding - If an outside antenna is connected to the receiver, be sure the antenna system is grounded so as to provide some protection against voltage surges and built-up static charges. Article 810 of the National Electrical Code, ANSI/NFPA 70, provides information with regard to proper grounding of the mast and supporting structure, grounding of the lead-in wire to an antenna-discharge unit, size of grounding conductors, location of antenna-discharge unit, connection to grounding electrodes, and requirements for the grounding electrode. See Figure A.
17. Noise Periods - The power cord of the appliance should be unplugged from the outlet when left unused for a long period of time.
18. Object and Liquid Entry - Care should be taken so that objects do not fall and liquids are not spilled into the enclosure through openings.
19. Damage Requiring Service - The appliance should be serviced by qualified service personnel when:
 - A. The power-supply cord or the plug has been damaged; or
 - B. Objects have fallen, or liquid has been spilled into the appliance; or
 - C. The appliance has been exposed to rain; or
 - D. The appliance does not appear to operate normally or exhibits a marked change in performance; or
 - E. The appliance has been dropped, or the enclosure damaged.
20. Servicing - The user should not attempt to service the appliance beyond that described in the operating instructions. All other servicing should be referred to qualified service personnel.



NOTE ON USE/OBSERVATIONS RELATIVES A L'UTILISATION/NOTAS SOBRE EL USO

 <ul style="list-style-type: none"> • Avoid high temperatures. Allow for sufficient heat dispersion when installed on a rack. • Éviter des températures élevées. Tenir compte d'une dispersion de chaleur suffisante lors de l'installation sur une étagère. • Evite altas temperaturas. Permítele la suficiente dispersión del calor cuando esté instalado en la consola. 	 <ul style="list-style-type: none"> • Keep the set free from moisture, water, and dust. • Protéger l'appareil contre l'humidité, l'eau et la poussière. • Mantenga el equipo libre de humedad, agua y polvo. 	 <ul style="list-style-type: none"> • Do not let foreign objects in the set. • Ne pas laisser des objets étrangers dans l'appareil. • No deje objetos extraños dentro del equipo.
 <ul style="list-style-type: none"> • Handle the power cord carefully. Hold the plug when unplugging the cord. • Manipuler le cordon d'alimentation avec précaution. Tenir la prise lors du débranchement du cordon. • Maneje el cordón de energía con cuidado. Sostenga el enchufe cuando desconecte el cordón de energía. 	 <ul style="list-style-type: none"> • Unplug the power cord when not using the set for long periods of time. • Débrancher le cordon d'alimentation lorsque l'appareil n'est pas utilisé pendant de longues périodes. • Desconecta el cordón de energía cuando no utilice el equipo por mucho tiempo. 	 <ul style="list-style-type: none"> • Do not let insects, worms, and termites come in contact with the set. • Ne pas mettre en contact des insectes, du vermine et un termites avec l'appareil. • No permita el contacto de insectos, gusanos y d'inyentes con el equipo.
 <ul style="list-style-type: none"> • Do not obstruct the ventilation holes. • Ne pas obstruer les trous d'aération. • No obstuya los orificios de ventilación. 	 <p>*[For sets with ventilation holes]</p> <ul style="list-style-type: none"> • Do not obstruct the ventilation holes. • Ne pas obstruer les trous d'aération. • No obstuya los orificios de ventilación. 	 <ul style="list-style-type: none"> • Never disassemble or modify the set in any way. • Ne jamais démonter ou modifier l'appareil d'une manière ou d'une autre. • Nunca desarme o modifique el equipo de ninguna manera.

Thank you for purchasing this DENON Compact Disc Player. Please read the operating instructions thoroughly in order to acquaint yourself with the CD player and achieve maximum satisfaction from it.

FEATURES

The DCD-S103000 is a CD player equipped with DENON's unique advanced super-linear converter which eliminates loss of sound quality in the PCM playback section, plus carefully selected parts that reproduce all the sounds of the studio or hall where the compact disc was recorded with high performance and rich master expression.

(1) Utilize signal reproduction using a newly developed ALPHA processor

1. High speed interpolation by the newly developed ALPHA processor recovers the data below the USB (least significant bit) lost upon recording to provide smooth waveform reproduction.
2. The original signals, including such unusual waveforms as impulse response, can also be reproduced with the ringing.
3. The effects of ALPHA processing are particularly noticeable at low levels, such as when music gently fades out or gradually emerges from total silence.

(2) Real 20 bit D.A.C.

The DCD-S103000 uses a new "S.L.I.C." (super linear converter) circuit in effect eliminating zero cross distortion, the main cause of loss of sound quality in the PCM playback section. Together with a real 20 bit digital/analog converter with excellent resolution, it greatly improves music reproducibility, especially at low volumes. In addition, two digital/analog converters are used for each channel, and the S-DAC incorporating further refinement and improves resolution to recreate sound fields with rich musical expression.

(3) Brassy power source
The DCD-S103000 uses a large transformer with independent coils for the digital servo circuitry and audio circuitry. In conjunction with a high capacity smooth capacitor, this offers power with room to spare.

— TABLE OF CONTENTS —

FEATURES	5
NAMES AND FUNCTIONS OF PARTS	6, 7
CONNECTOR	8
OPENING AND CLOSING THE DISC HOLDER AND LOADING A BIRD	9
NORMAL CD PLAYBACK	9
ADVANCED CD PLAYBACK	10-14
TIMER-CONTROLLED PLAYBACK	10
THE COMPACT DISC	10
INSTALLATION PRECAUTIONS	15
TROUBLESHOOTING	15
PLAYBACK USING THE REMOTE-CONTROL UNIT	16, 17
SPECIFICATIONS	18

Please check to make sure the following items are included with the main set in the cartons:

- | | |
|--|---|
| (1) Operating Instructions | 1 |
| (2) Connection Cord | 1 |
| (3) Remote Control Unit (RC-205 (ICD-S100)) | 1 |
| RC-352 (ICD-3000) | 1 |
| (4) RIP-PA Dry Cell Battery | 2 |
| (5) AC Power Cord (Multi-Voltage model only) | 1 |

• Line Voltage Selection (for multiple voltage model only)

- The desired voltage may be set with the VOLTAGE SELECTOR knob on the rear panel, using a screwdriver.
- Do not twist the VOLTAGE SELECTOR knob with excessive force as this may cause damage.
- If the VOLTAGE SELECTOR knob does not turn smoothly, please contact a qualified serviceman.



CONNECTION

(1) Connections to the Output Jacks (FIXED and VARIABLE)

Using the included pin cords, connect the left (L) and right (R) output jacks (FIXED and VARIABLE) on the DCD-S103000 to the left (L) and right (R) CD, AUX, or TAPE PLAY input jacks on an amplifier. There are two types of output jacks. The input is variable for the VARIABLE jacks, and fixed for the FIXED jacks. If you want to be able to control the output level on the DCD-S103000, use the VARIABLE jacks.

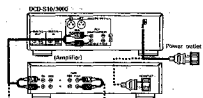

(2) Connections to the Digital Optical Output Jack (DIPITAL)

Use an optical fiber cable to connect the digital optical output jack on the DCD-S103000 to the optical input jack on a digital processor or DVA unit.

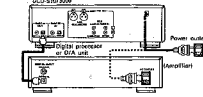

(3) Connections to the Digital Input Jack (DIGITAL)

Use a 75 Ω (ohm) pin cord to connect the digital input jack (DIGITAL) of the DCD-S103000 to the digital input jack (DIGITAL) of a digital processor or DVA unit, available in stores.

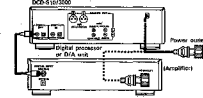

(4) Connections to the Digital Input Jack (OPTICAL)

Use an optical fiber cable to connect the digital optical input jack on the DCD-S103000 to the optical output jack on a digital processor or DVA.

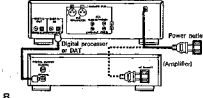

(5) Connections to the Digital Input Jack (COAXIAL)

Use a 75 Ω (ohm) pin cord to connect the digital input jack (COAXIAL) of the DCD-S103000 to the digital output jack (COAXIAL) on a digital processor or DVA.

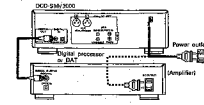

(6) Connections to the Analog Output Jack (BALANCE)

Connect as shown on the diagram using a Canon connector (SLR type) cord, available in stores.
• Canon connector signal layout

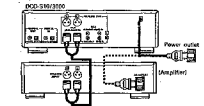
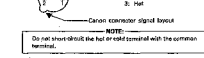

Connection Precautions

- Before proceeding with connections or disconnections of cables and power cords, be sure to turn all systems completely off.
- Ensure that all cables are connected properly to the L (left) and R (right) jacks.
- Insert plugs fully into the terminals.
- Connect the output jacks to the amplifier CD, AUX or TAPE PLAY input jacks.

OPENING AND CLOSING THE DISC HOLDER AND LOADING A DISC

Opening and closing the disc holder (This operation only works while the power is on.)

1. Press the power switch (POWER) to turn on the power.
2. Press the operation button 1 (OPEN/CLOSE).

How to load a disc

- Make sure the disc holder is completely open.
- Hold the disc by the edges and place it on the disc tray. (Do not touch the signal surface, i.e. the shiny side.)
- When using 12 cm diameter discs, make sure the outer edge matches the tray guide circumference (Fig. 1), and when using CD singles (8 cm diameter) match the outer edge with the lower tray guide circumference (Fig. 2).
- Press the open/close button 1 (OPEN/CLOSE) to close the disc holder.
- When the disc holder is closed, the disc is read and after a few seconds the number of tracks and total playing time are displayed on the TRACK NO. and TIME displays, respectively.
- When the disc holder is open and a disc is held, you may also press the play (PLAY) button to show the disc holder. If the play button (PLAY) is pressed, playback will start immediately upon the disc contents having been read.

Fig. 1 Tray guide for 12 cm disc



Fig. 2

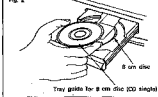

Caution:

- If your finger should get caught in the disc holder when it closes, press the open/close button 1 (OPEN/CLOSE).
- Do not place any foreign objects on the disc tray, and do not place more than one disc on the tray at a time. Otherwise malfunction may occur.
- Do not push in the disc tray forcefully when the power is off as this may cause malfunction and damage the CD player.

NORMAL CD PLAYBACK

(1) Starting Playback



1. Turn the power switch on and load the disc.
2. Press the play button (PLAY).
- The number of the track currently playing, the index number, and the elapsed time, etc., are displayed.

(2) Stopping Playback



1. Press the stop button (STOP).
- The stop mode is set automatically once all tracks on the disc are played.

NOTE:

- If an disc is loaded or if the disc is loaded automatically, the track numbers, index, and time displays will all read zero, and the error indicator will light.

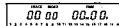

- If the information at the innermost side of the disc cannot be read properly due to dirt or scratches, the display will be as shown below, and the number of tracks and remaining time per track will not be displayed. Also, the search operation may take longer than usual.

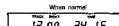

When data cannot be read properly

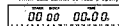

ADVANCED CD PLAYBACK

1. Playing a Specific Track

Direct Search
(Remote control only)

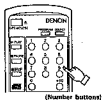

(Number buttons)

- Use the number buttons and the +10 button to input the number of the desired track. For example, to play the fourth track press **[4]**, and to after the 13th track press **[3]**, **[3]**, and **[0]**. The beginning of the track is found and playback starts.

2. Moving to Following Tracks

Automatic Search



Press the automatic search forward button **[FF]**.

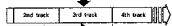

- Press the automatic search forward button **[FF]**.
- If the automatic search forward button **[FF]** is pressed again during the search operation, the pickup moves on to the next track, etc.

3. Returning to the Beginning of the Current Track

Automatic Search



Press the automatic search reverse button **[RR]**.

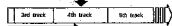

- Press the automatic search reverse button **[RR]**.
- If the automatic search reverse button **[RR]** is pressed again during the search operation, the pickup returns on to the previous track, etc.

4. Finding Sections Within a Track

Index Search
(Remote control only)

- Use this function to start playback from certain sections within a track divided by index numbers.

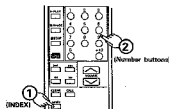

(INDEX)

(Number buttons)

- Press the **INDEX** button. "I" appears at the TRACK NO. display.
- Use the number buttons to specify the track number. "I" now appears at the INDEX display; input the desired index number. Playback starts from there. For example, to start listening from index number 2 on track 3, press **INDEX**, **3** and **2**.

Indexes

- Indexes are numbers which are assigned to sections within a track. Check the disc's explanatory notes for the index numbers.
- If you make an index search for an index number that is not on the disc, playback will start from the last index number on the track.

5. Playing Specific Tracks in a Specific Order

Programmed Play

- With this function, you can choose any of the tracks on the disc and program them to play in any order.
- Programming is possible with the disc holder open.
- Up to 20 tracks can be programmed.
- The programmed tracks are shown on the selector.

(1) Programming

(Remote control only)

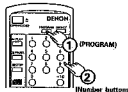

(PROGRAM)

(Number buttons)

- The **PROGRAM** indicator lights when the program button **[PROGRAM]** is pressed. Next, use the number buttons and the +10 button to program the tracks.

To program tracks 3, 12, and 7, for example, press **[PROGRAM]**, **[0]**, **[3]**, **[1]**, and **[0]**.

The track number lights on the selector each time a track is programmed. The number of tracks programmed is displayed at the track display, and the total playing time for the programmed tracks is indicated at the time display. After the tracks are programmed, the total number of programmed tracks is displayed at the track number display, and the total playing time for the programmed tracks is indicated at the time display.

(2) Overriding the Programmed Tracks

(Remote control only)



(CALL)

- Press the **CALL** button. The programmed tracks are displayed in order on the TRACK NO. display each time the **CALL** button is pressed.

(3) Playing the Programmed Tracks



(PLAY)

- Press the **(PLAY)** button to play the tracks in the programmed order.

(4) Correcting Programs

(Remote control only)

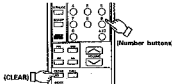

(CLEAN)

(Number buttons)

- To correct a programmed track, first press the **CLEAN** button, then program the correct track.
- The last track programmed is replaced with the correct track.
- To alter a track in the middle of the program, use the **CALL** button to call out that track, then press the **CLEAN** button to clear it from the program.

(5) Clearing the Entire Program

- Press the **DIRECT** button to clear the entire program. The entire program can also be cleared by pressing the **OPEN/CLOSE** button.
- If the **DIRECT** button is pressed during programmed playback, the program mode is direct and normal playback continues from that track on.

NOTE

- If the programming operation is performed in the play or pause mode, the correct track is programmed as the first track in the program. Other programs can be added, but the number of programmed tracks and playing time will not be displayed.
- Direct search is not possible during programmed playback. Pressing the number buttons adds tracks to the end of the program.
- Programming is not possible when the disc holder is open. A track number greater than the number of tracks on the disc can be set in the program, but it will automatically be cleared from the program before playback starts.
- The remaining time per track can only be displayed for the first 20 tracks on the disc.
- The total program time and remaining program time as well will not be displayed if tracks numbers greater than 20 are programmed.

6. Playing All Tracks Repeatedly

(Remote control only)

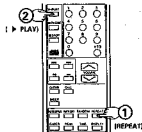

(REPEAT)

- Press the **REPEAT** button. The **REPEAT** indicator lights.
- The operation is the same whether button **[REPEAT]** or **[REPEAT]** is pressed first.
- The one-track-repeat mode is set if the **REPEAT** button is pressed again during repeat playback.
- The direct-repeat mode is set even if the **REPEAT** button is pressed during playback.
- To cancel the repeat mode, press the **REPEAT** button twice.
- If the **REPEAT** button is pressed during programmed playback, the tracks are repeated in the programmed order.

1 Playing a Single Track Repeatedly **Disc Track Repeat**
(Remote control only)

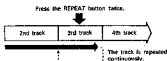
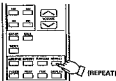

- Press this button when you hear a track you want to play repeatedly.
- Press the REPEAT button twice during playback. The REPEAT indicator lights, and if you are at least number 20th track, that number appears on the calculator display and that track is played repeatedly.
- For track numbers 21 and above, the track number is not displayed on the calculator display but the one-track repeat mode will function.
- If the REPEAT button is pressed twice in the stop mode, track number 1 appears on the calculator display and one-track repeat is possible. Press the PLAY button to start playback.
- Press the REPEAT button once again to cancel the one-track repeat mode. The display and playback return to normal.

2 Stopping Instantly During Playback **Pause**
(Remote control only)

- Playback can be stopped momentarily but resumed from the same point.

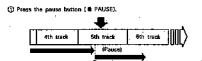

- Press the pause button (II PAUSE).

- Press the play button (I PLAY) or the pause button (II PAUSE) or the power button (III PAUSE).

3 Finding a Track While Listening **Manual Search**
(Remote control only)

- You can skip through the disc while listening at high speed. This function comes in handy for finding a certain part in the middle of a long track and starting playback from there.
- Once you find the desired position using the manual search operation, release the manual search forward button (III >>>) or manual search reverse button (II <<<) to start normal playback.

(I) Manual Search Forward

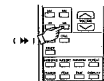

Hold in the manual search forward button (III >>>)

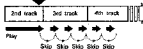

- During playback, press and hold in the manual search forward button (III >>>) to skip through the disc while listening at high speed.
- The number of the track being skipped through the index, number, and the elapsed time for that track are indicated on the display window.
- In the skip mode, the disc rotates at about three times the speed as during the play mode, but no sound is heard.
- When the end of the last track is reached while pressing the manual search forward button (III >>>), "2" appears on the display window and the manual search operation is stopped.
- To reverse playback, press the manual search reverse button (II <<<) to do another operation once the "2" disappears from the display.

(2) Manual Search Reverse

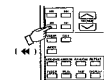

Hold in the manual search reverse button (II <<<)

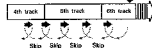

- During playback, press and hold in the manual search reverse button (II <<<) to skip through the disc while listening at high speed.
- The display is the same as during the manual search forward operation.
- In the skip mode, the disc rotates at about three times the speed as during the play mode, but no sound is heard.
- When the beginning of the first track is reached while pressing the manual search reverse button (II <<<), "C" appears on the display window and the manual search operation is stopped.
- To resume playback, press the manual search forward button (III >>>) then do another operation once the "C" disappears from the display.

(3) Inserting Blanks Between Tracks **Auto Space**
(Remote control only)

- This function inserts blank space between tracks, making editing easier.

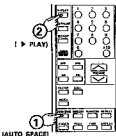

- The AUTO SPACE indicator lights when the auto space button is pressed.
- Press the play button (I PLAY) to start playback. When the end of a track is reached, a blank space of approximately 4 seconds is inserted before the beginning of the next track.
- Press the auto space button again to turn the auto space function off.

(4) Pausing At the Beginning of a Track **Manual Auto Searching**
(Remote control only)

- Pressing at the beginning of a track found with the direct search operation comes in handy for searching tracks.

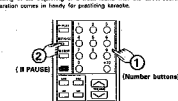

- Use the number buttons to set the desired track.
- Press the power button (III PAUSE).
- To start playback, press either the play button (I PLAY) or the pause button (II PAUSE).

(2) Program Search **Program Search**
(Remote control only)

- Press the power button (III PAUSE) after programming tracks. The beginning of the first track in the program is found and the disc is played there.

(3) Playing Tracks in Random Order **Random Playback**
(Remote control only)

- All of the tracks recorded on the disc can be played once in random order.



- When the random button (RANDOM) is pressed, the RANDOM indicator lights and random playback starts automatically.
- If the random button (RANDOM) is pressed when tracks are programmed, only the programmed tracks are played in random.
- If the random button (RANDOM) is pressed when the repeat function is set, all tracks will be played through once in random order. After which all tracks will be played through again in different order, and so on.
- During the search operation, the track numbers from the disc to the last track on the disc are displayed in rapid succession on the track number display, so you cannot tell what track is going to be played next until playback begins.

- The total remaining time is not displayed during the random mode.
- The auto seek mode is cancelled if the random button (RANDOM) is pressed during the random mode.

(4) Edit Recording on Disc A **Edit Function**
End of the Tape

- The auto edit function (AUTO EDIT) [Selects certain] (I) The auto edit function automatically divides the track on the compact disc into sides A and B, with the duration of the beginning of a track in each side as the disc's total playing time is divided as close as possible by one half.

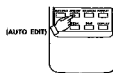

- When the AUTO EDIT button is pressed in the stop condition, the total play time of side A (the first half) and the track numbers for the program are displayed for about 5 seconds. Then, the side B total time information is similarly displayed after which the player automatically pauses at the beginning of the first track of side A. END and PROGRAM will be lit on the display at this time.
- Pressing the play button (I PLAY) or the pause button (II PAUSE) will start the play mode. When side A has finished playing, the player will pause at the beginning of the first track on side B.
- Pressing the play button (I PLAY) or the power button (III PAUSE) again will start the play mode. When side B has finished playing, the player automatically stop.

① Fading Out or Fading In at the

Desired Location: **Fade Function**
(Manual control only)

(1) Fading out and fading in is possible at the desired position during play.

Manual Fade
(Manual control only)

② Fade In

When the fade button (FADEIN) is pressed during play, fade out will be automatically for about 8 seconds. FADEIN will light up during the operation and 1 sec. will flash. When fade out is completed the player will automatically pause.

(2) Fade In
When the fade button (FADEIN) is pressed from the pause mode, the player will start playing and fade in will be possible for about 8 seconds. FADEIN will light up during the operation and (PAUSE) will flash.

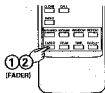

(2) Set the Fade Out Time to Advance (TIME FADE)

(Remote control only)

(1) When the fade button (FADEIN) is pressed in the stop mode, the FADE indicator (FADE) will light up. TIME will appear as -M-5, and the player will wait for the input of the fade out time.

(2) Input the fade out time with the 0-9 numeric buttons.

(3) Pressing the play button (▶ PLAY) will start the play time and the FADE indicator (FADE) will light up.

(4) The (▶) indication will start flashing 3 seconds before the specified fade out time and then the fade out will begin. The fade out will end at the specified time and the player will automatically pause.

The time fade function will be cancelled if an auto search or manual search is performed during playback.

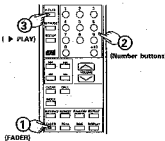

② To Search for the Peak Level

Peak Search
(Remote control only)

• The player searches for the peak position and plays a few seconds either side of the point repeatedly. This is convenient for making recording adjustments on the tape recorder.



(1) When the peak search button (PEAK) is pressed in the stop mode, the PEAK indicator will flash and the player will search for the portion having the peak level.

(2) After the search, the PEAK indicator lights up and a few seconds either side of the peak level point are played back repeatedly. This is convenient for making recording adjustments on the tape recorder.

(3) To cancel the peak search, press the stop (■ STOP) button.

(4) When the play button (▶ PLAY) or the pause button (⏸ PAUSE) is pressed during peak search, or while playing the peak portion back repeatedly, the player will go to the beginning of the first track the first track of the program for program advance, or the track that was first indicated in the time advance and begin playback from there if the play button was pressed or enter the pause mode if the pause button was pressed.

NOTE:

• The peak search function reads the level of the disc from the beginning of the disc to the end at a fixed interval and regards the maximum value that was read as the peak.

• Peak search takes a little time for disc search.

• The peak position may change each time the disc is read and there may be a slight difference in the actual peak level, but since this difference only so slight there will be no adverse effects on the adjustment of the recording level.

• The time fade function is cancelled when the peak search operation is performed. To use the time fade function, set to the stop mode then reset the function.

• Besides other than the operation button (▶ PLAY), (⏸ PAUSE), (■ STOP) button (▶ PLAY), pause button (⏸ PAUSE), and stop (■ STOP) button will use function during peak search or repeat play of the peak portion.

TIMER-CONTROLLED PLAYBACK

■ Operation

1. Turn on the power of all system components.
2. Set the input selector on the amplifier to correspond to the inputs the CD player is connected to.
3. Make sure a disc has been loaded in the disc holder.
4. Check the time on the timer and then set the desired turn-on time.
5. Turn the audio driver ON.
6. Power is turned off automatically in all components connected to the timer.
7. When the preset turn-on time is reached, power is turned on in the system components, and CD playback starts from the first track.

■ Connection

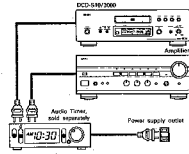

INSTALLATION PRECAUTIONS

The CD player uses a microprocessor for controlling internal electronic circuits. In the event that the player is used while a radio by tuner or TV is turned on, although optimum interference could occur either in the sound from the tuner or the picture of the TV. To avoid this, please take the following precautions:

- Keep the CD player as far away from the tuner or TV as is possible.
- Keep the power cable and connecting cable of the CD player separate from the antenna wires of the tuner and TV.
- Interference is particularly likely to occur when an indoor antenna or a 300 Ω twin feeder cable is used. Thus, use of an outdoor antenna and 75 Ω twin coaxial cable is strongly recommended.

TROUBLESHOOTING

If the CD player does not seem to be functioning properly, check the following:

- Disc holder does not open or close.
 - Is the power on?
 - Is the disc inserted correctly?
- When a disc is loaded, **CHANGES** is displayed.
 - Is the disc loaded properly? See page 9
 - When the play button (▶ PLAY) is pressed, playback does not start.
 - Is the disc dirty or scratched? See page 15
- There is no sound, or it is fluctuating.
 - Is the output level properly connected to the amplifier? See page 6
 - Have the amplifier controls been set correctly?
- Volume is low.
 - Is volume setting level volume buttons on remote control set correctly? See page 17

THE COMPACT DISC

1. Precautions on handling compact discs

- Do not allow fingerprints, oil or dust on the surface of the compact disc. If the signal surface is dirty, wipe it off with a soft, dry cloth. Wipe in circular motions from the center out.
- Do not use water, benzene, thinner, record sprays, electrostatic proof sprays, or alcohol-treated cloths to clean discs.
- Always use care when handling discs to prevent damaging the surface, in particular when removing a disc from the case and returning it.
- Do not bend compact discs.
- Do not apply heat to compact discs.
- Do not damage the hole in the center of the disc.
- Do not write on the disc and do not scratch any labels.
- Condensation will form on the disc surface if it is brought into a warm room from a cold area, such as outdoors during winter. Wait until the condensation disappears. Never dry discs with hair-dryers, etc.

2. Precautions on storage

- After playing a disc, always return it to its case.
- Keep discs in the case when they are not to be played. This will protect them from dust and dirt and prolong their service life.
- Do not store discs in the following places:
 - 1) Places exposed to direct sunlight for a considerable time.
 - 2) Places subject to accumulation of dust or high humidity.
 - 3) Places exposed to high temperatures, such as close to heating outlets.



300 Ohm feeder cable 75 Ohm coaxial cable

A specific position of the disc will not play.

• Is the disc dirty or scratched? See page 15

Programmed playback does not work.

• Have programming been properly done? See pages 10, 11 and 17

Incorrect operation when buttons on the remote control are pressed.

• Is the remote control lock being operated by the laser from the CD player? See page 16

• Are there obstructions blocking the ray?

• Is the remote control sensor exposed to strong light?

• Are the batteries exhausted?

PLAYBACK USING THE REMOTE CONTROL UNIT

The necessary RC-253/RC-252 remote control unit can be used to control the CD player from a convenient distance.

(1) Inserting the dry cell batteries

- Remove the battery cover on the back of the remote control unit.



- Insert two R6P (standard size AA) dry cell batteries with correct polarity as indicated inside the battery compartment.



- Replace the battery cover.



Notes on the Batteries

- The remote control unit uses standard size AA dry cell batteries.
- The batteries will need to be replaced approximately once a year. Replacement may be necessary earlier depending on how much the remote control unit is used.
- If, in less than a year from the time new batteries were inserted, the remote control fails to operate the CD player from a near-by position, it is time to recharge the batteries.
- Insert the batteries properly, following the polarity diagram inside the battery compartment. In other words make sure (+) and (-) terminals are properly aligned.
- Batteries are prone to damage and bulging. Therefore:
 - Do not combine new batteries with used ones.
 - Do not combine different types of batteries.
 - Do not jamper opposite poles of the batteries, except them to hear, break them open nor deposit of dust in open fire.
- If the remote control unit is not to be used for a long period of time, remove the batteries from the unit.
- If the batteries have leaked, remove any traces of battery fluid from the battery compartment, wiping thoroughly with a dry cloth. Then insert new batteries.

(2) Directions for Use

- Consult the remote control unit while pointing it towards the remote control sensor on the CD player face below.

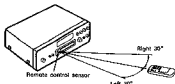

When a remote control signal is received, the remote control indicator on front of the CD player lights briefly.

- The remote control unit can be used at a distance up to 3 meters in a straight line from the CD player. This distance decreases if there are obstructions blocking the signal path or when the remote control unit is operated at an angle from the remote control sensor.
- The buttons on the remote control unit have identical functions with those on the CD player.
- However, the following functions cannot be remote controlled: Power ON/OFF.

Caution as Use

- Do not press the operation buttons on the main unit and on the remote control unit simultaneously, as this will result in malfunction.
- The remote control unit may not operate properly if the remote control sensor is exposed to direct sunlight or strong artificial lighting, or if there is an object between the remote control unit and the remote control sensor.

REMOTE CONTROL UNIT RC-253/RC-252

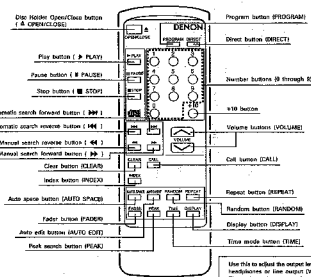

Setting to the Program Mode

- For program search, press the PROGRAM button more than the number buttons (0 through 9 and -10).
- The remote control unit is normally set to the direct mode.

Program button (PROGRAM)

Direct button (DIRECT)

Number buttons (0 through 9)

VIB button

Volume button (VOLUME)

Call button (CALL)

Repeat button (REPEAT)

Random button (RANDOM)

Display button (DISPLAY)

Time mode button (TIME)

Use this to adjust the output level (VOLUME) of the headphones or line output (VARIABLE). The volume increases when the +1 button is pressed, decreases when the -1 button is pressed.

Display Button (DISPLAY)

- Press this button to change the brightness of the display.
- Press once to make the display 2/3 as bright as normal.
- Press again to make the display 1/3 as bright as normal.
- Press once again to turn the entire display off during playback and all but the track number off to any other mode.

Direct Search

- Normally, direct search is possible simply by pressing the desired number button.
- Program Search (During playback, the track which is currently playing is programmed as the 1st track.) Press the PROGRAM button, then press the number buttons. For example, to program tracks number 3, 11, and 5, press PROGRAM → 3 → 11 and 1 → 5.
- To cancel the program, press the DIRECT button.

Inputting the Track Numbers

- For track numbers below 9, simply press the corresponding button. For track numbers of 10 and greater, press the +10 then the number buttons. For example, for track number 22 press +10 twice then 2.

Volume

- The volume control on the unit will operate when the volume buttons are pressed. The volume can be checked by looking at the position of the control.

SPECIFICATIONS

AUDIO

No. of Channels:	2 channels
Frequency Response:	2 ~ 20,000 Hz
Dynamic Range:	100 dB
Signal-to-noise Ratio:	115 dB
Harmonic Distortion:	0.0018% (1 kHz)
Separation:	110 dB (1 kHz)
Wow & Flutter:	Below measurable limit: (±0.001% W, peak)
Output Voltage:	FIXED 2.0 V VARIABLE 0~2.0 V
DISCS	Compact Disc format

GENERAL CHARACTERISTICS

Power Supply:	Voltage and frequency are shown on rating label.
Power Consumption:	22 W
Dimensions:	434 (W) x 135 (H) x 340 (D) mm (17-3/32" x (5-5/16)" x (13-25/64") DCD-S10 10.0 kg (22 lbs 5oz) DCD-3000 8.0 kg (17 lbs 64oz)
Weight:	

FUNCTIONS AND DISPLAY

Functions:	Direct selection, automatic search, programmed playback, repeat playback, manual search, auto space, time mode, auto edit, index search, fader, peak search.
Display:	Track number, time, music calendar, and engaged modes
Others:	Headphones jack
REMOTE CONTROL UNIT	DCD-S10 RC-253 DCD-3000 RC-252
Remote Control System:	Infrared pulse system
Power Supply:	3 V DC; two R6P (standard size AA) dry cell batteries
External Dimensions:	60 (W) x 177 (H) x 18 (D) mm (2-23/64" x (6-31/32") x (45/64")
Weight:	120 g (26 oz) (including batteries)

* Design and specifications are subject to change without notice in the course of product improvement.

DISASSEMBLY

1. Top Cover

Remove 2 screws from rear side and 4 screws from both sides. Remove 4 upper screws and detach the Top Cover as show as arrow.

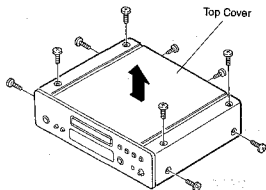

2. Front Panel

Pull out Loader Panel, remove 3 upper screws and 2 below screws, then detach the Front Panel as show as arrow.

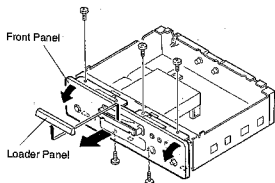

3. Bottom Cover

Remove 12 screws from bottom side, and detach Bottom Cover.

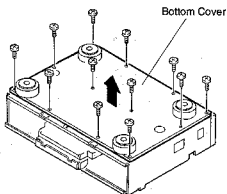

4. Mechanism Unit

Remove 4 screws and detach the Cover, then remove 4 screws and detach the Mechanism Unit as show as arrow.

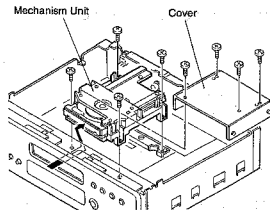

5. Clamper

Remove 4 screws and detach the Clamper.

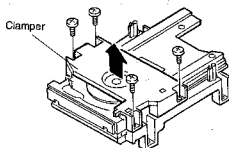

ADJUSTMENT

A microcomputer employed in this unit has a service program built-in so as to perform each servo confirmation easier with the operation buttons.

Also, the unit adopted with digital servo makes focus gain and tracking gain adjustments in automatic manner.

1. Actuating the Service Program

- Close the disc holder and turn OFF the power switch.
- Short-circuit Pin ⑥ of TP102(SWOP) and Pin ②(GND) of PWB(Main Unit).
Note: Do not touch the other pins.
- Turn ON the power switch.
(Service program actuates and the display shows TRACK No. 01)

(Caution)

- When service program actuates, the operation buttons will not function normal operation mode.
- Open the loader and load the adjustment disc.

2. Operational Function at a Time Service Program Actuation

Button Operation	Function	Description
▲ OPEN/CLOSE	Opens/closes disc holder.	<ul style="list-style-type: none"> Open/close operation should be performed while disc fun is in stop. The other keys should be operated after open/close operation is finished.
■ STOP	Stops system operation.	<ul style="list-style-type: none"> TRACK No. display becomes 01. Press it when adjustment is completed or attempting readjustment.
▶ PLAY	Focus servo actuates and disc runs.	<ul style="list-style-type: none"> Press it for tracking adjustment. When completed action, TRACK No. display becomes 02.
▶▶	Actuates focus servo, tracking servo, slide servo and spindle servo.	<ul style="list-style-type: none"> When PLAY button is pressed, tracking servo and slide servo actuate. When completed action, TRACK No. display becomes 03.
EXT. INPUT	Displays a result of automatic focus gain adjustment.	<ul style="list-style-type: none"> After completed PAUSE button action, pressing Button 1 of 10-key indicates a result of automatic focus gain adjustment. After action is completed, Display shows: TRACK INDEX TIME 03 1- 11.111/15 TIME display shows the value of automatic adjustment Displays: 0 1:27₅ - 00:00₁₅ or EE:00₁₅
◀◀	Displays a result of automatic tracking gain adjustment.	<ul style="list-style-type: none"> After completed PAUSE button action, pressing Button 2 of 10-key indicates a result of automatic tracking gain adjustment. After action is completed, Display shows: TRACK INDEX TIME 03 2- 11.111/15 TIME display shows the value of automatic adjustment. Displays: 0 1:27₅ - 00:00₁₅ or EE:02₅
Other Buttons	Unable to obtain normal function.	<ul style="list-style-type: none"> Never attempt to operate the buttons other than the above. If the buttons are erroneously pressed, promptly turn OFF the power switch.

(Caution)

- During the service program is in operation, do not use remote control.

3. Confirming Method

- (1) Required Measuring Equipment and Implement
- Dual-trace oscilloscope
 - Test disc: CA-1094 "Yasuko TOMITA" or CO-76143 "W.A. Mozart"
- (2) Check Point

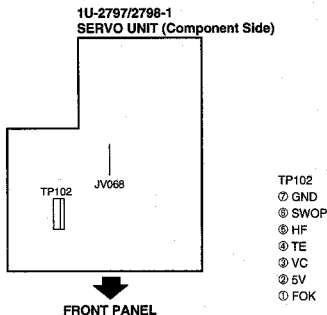

Note: About the difference of test point between Analog Servo (DCD815, etc.) and Digital Servo (DCD-S10/3000).

Analog Servo			Digital Servo
TP101	TP102		TP102
⑥ TEI	⑤ 5V		⑦ GND
⑤ VC	⑤ NC	➔	⑥ SWOP
④ FOK	④ SWOP		⑤ HF
③ TEO	③ SWCL		④ TE
② FEI	② GND		③ VC
① FEO	① HF		② 5V
			① FOK

As described above, test points of CD player have changed from this model (DCD-S10/3000), when replacement is required for pick-up according to the pick-up replacement standard, please use the test points as follows.

Analog Servo		Digital Servo
FOK (Pin4 of TP101)	➔	FOK (Pin1 of TP102)
FEO (Pin1 of TP101)	➔	FE (JV068)
TEO (Pin3 of TP101)	➔	TE (Pin4 of TP102)
HF (Pin1 of TP102)	➔	HF (Pin5 of TP102)
VC (Pin5 of TP101)	➔	VC (Pin3 of TP102)

(3) Confirming Procedure

- Actuate the service program.
- Check the value of automatic focus gain adjustment.
- Check the value of automatic tracking gain adjustment.
- Check for tracking offset.
- Execute the service program and return the mode to normal operation (turn ON the power switch in normal manner).
- Check for HF level.

(4) Confirming Focus Gain

Confirm the following items.

- Press **▶▶** button. (TRACK No. indication **03**)
- Press **EXT. INPUT** button. (INDEX No. indication **1-**)
- Check for automatic adjustment value.
Automatic adjustment value: 01M27S ~ 00M81S (Test disc: CA-1094)
01M27S ~ 00M77S (Test disc: CO-76143)

Note: As there may have a possibility of abnormality in pick-up when adjustment value is less than EE_M01S or 00M80S (CA-1094), 00M76S (CO-76143), execute the confirmation for pick-up according to pick-up replacement standard.

If there is no abnormality in pick-up as described in pick-up replacement standard notes, no problem will occur for disc playback even though the automatic adjustment value is less than EE_M01S or 00M80S (CA-1094), 00M76S (CO-76143).

(5) Confirming Tracking Gain

Confirm the following items.

- Press **▶▶** button. (TRACK No. indication **03**)
- Press **◀◀** button. (INDEX No. indication **2-**)
- Check for automatic adjustment value.
Automatic adjustment value: 01M27S ~ 00M35S (Test disc: CA-1094)
01M27S ~ 00M31S (Test disc: CO-76143)



Note: As there may have a possibility of abnormality in pick-up when adjustment value is less than EE_M02S or 00M34S (CA-1094), 00M30S (CO-76143), execute the confirmation for pick-up according to pick-up replacement standard.

If there is no abnormality in pick-up as described in pick-up replacement standard notes, no problem will occur for disc playback even though the automatic adjustment value is less than EE_M01S or 00M34S (CA-1094), 00M30S (CO-76143).

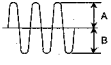
(6) Tracking offset (E/F Balance)

Oscilloscope			Check	Step
V	H	(Oscilloscope)		
0.1V/div	1-2 ms/div	 $\frac{A - B}{A + B} < 20\%$		<ol style="list-style-type: none"> Push ▲ OPEN/CLOSE and load disc holder reference disk. Push ▲ OPEN/CLOSE and close disc holder. Push ▶ PLAY to turn disc. (Displays track number 02) Short (+)(-) of oscilloscope and check the base line. Confirm that upper and lower amplitude of the waveform is symmetric against 0V.

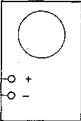
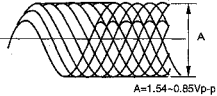
(7) HF level

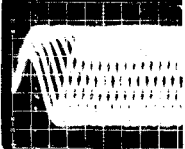
Oscilloscope		Check	Step
Connection			
<div style="display: flex; justify-content: space-around; align-items: center;"> <div style="border: 1px solid black; padding: 5px; text-align: center;"> 1U-2797/2798-1 Servo Unit TP102-Ⓞ (HF) ○ TP102-Ⓞ (VC) ○ </div> <div style="border: 1px solid black; padding: 5px; text-align: center;"> Probe 10 : 1 </div> <div style="border: 1px solid black; padding: 5px; text-align: center;"> Oscilloscope  ○ + ○ - </div> </div>			
V	H	(Oscilloscope)	
50mV/div or 20mV/div	0.2μs/div or 0.5μs/div	 $A=1.54\sim 0.85V_{p-p}$	<ol style="list-style-type: none"> 1. Push  (Displays track number 03) 2. Check HF level of oscilloscope. 3. Confirm that the waveform is in good shape. (∅ pattern in center must be able to discriminate clearly.)
<ul style="list-style-type: none"> • Set input mode to ALTERNATE or CHOPPER. 			

HEAT RUN MODE FUNCTION

Heat Run Mode

(1) To activate

While hold pushing PLAY and **⏮** keys simultaneously, turn the unit power on. The remote control sensor indicator will light to show that the unit is shifted in Heat Run mode.

Be sure to load the disc previously.

Press the disc holder open/close button (**▲** OPEN/CLOSE) to cancel Heat Run mode.

★ This mode functions only for a disc with 21 pieces of music or more. For a disc with 20 pieces of music or lesser, please do not use.

(2) Operation

During the Heat Run mode to shift the unit in Play mode makes the unit replays from the first music after opens the loader once and re-closes it when finish playing the last track (comes into lead out).

Hereafter, operates open/close of loader, servo on, reading of TOC, and playing repeatedly, and repeats playing the two tracks; the first and the last ones.

(3) Error Message

When the system error occurs while in Heat Run mode, the following error message will display on the Track No. indicator and stops operation.

1. E1

At the time of Focus Servo does not activate.

2. E2

When unable to detect synchronous pattern however the disc is in rotating. (GFS does not drive.)

3. E3

No synchronous pattern can be detected while in Play mode. (No GFS drives.)

4. E4

When TOC is unreadable in despite of servo is activated.

5. E5

In case of loader malfunctions. (Unable to turn on the switch.)

6. E6

The inner circle switch of Pick-up does not turn off.

7. E7

The inner circle switch of Pick-up does not turn on.

★ The number of operation up to the stop will be displayed on the minute and second portion of the indicator.

JUDGMENT STANDARDS FOR OPTICAL PICK-UP REPLACEMENT

1. PICK-UP REPLACEMENT

The pick-up (PU) replacement must be executed on checking the following 4 items and found the abnormality in the PU. Also, refer to following pages.

(1) Judgment by confirming of Focus Search.

(Cause of PU abnormality: Focus search does not function from pick-up laser)

(2) Judgment by Changing of PU due to Focus Error Signal V_{FE}.

(Cause of PU abnormality: No proper emission of focus error signal (S-curve) V_{FE})

(3) Judgment by Changing of PU due to Tracking Error Signal V_{TE}.

(Cause of PU abnormality: No proper emission of tracking error signal (Traverse wave) V_{TE})

(4) Judgment by Changing of PU due to HF level V_{HF}

(Cause of PU abnormality: No proper emission of HF wave)

2. ABOUT USING DISK

Using Yasuko TOMITA disc (disc No. CA-1094) or w. A. Mozart (disc No. CO-76143)

3. PICK-UP REPLACEMENT OF OTHER CAUSE

If it happens case of another PU change except for over checking items, please execute PU replacement.

1. Judgement by Confirming of Focus Search (Check for focus searching of PU Lens)

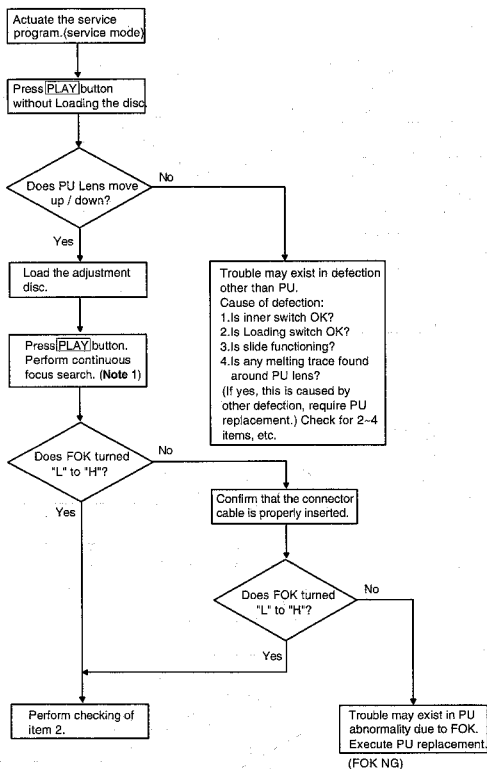

Note 1: Press [PLAY] button continuously in FOK measure.

2. Judgement by Changing of PU due to Focus Error signal (S-curve) VFE (check for proper S-curve)

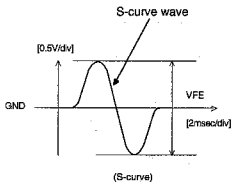
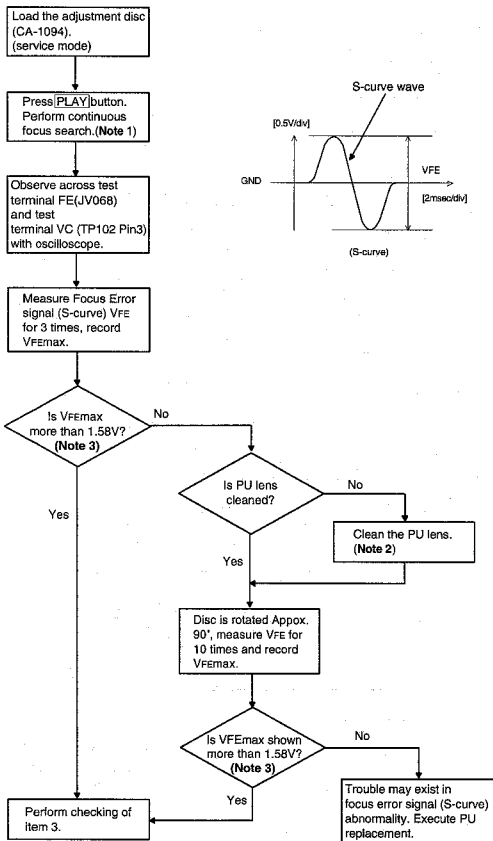

Note 1: Press **[PLAY]** button continuously in VFE measure.

Note 2: Clean the lens with-moistened cleaning paper without applying an excessive force to the lens.

Note 3: When using the Test disc CO-76143 value are 1.67V.

3. Judgement by changing of PU due to Tracking Error Signal VTE (check for proper Traverse wave)

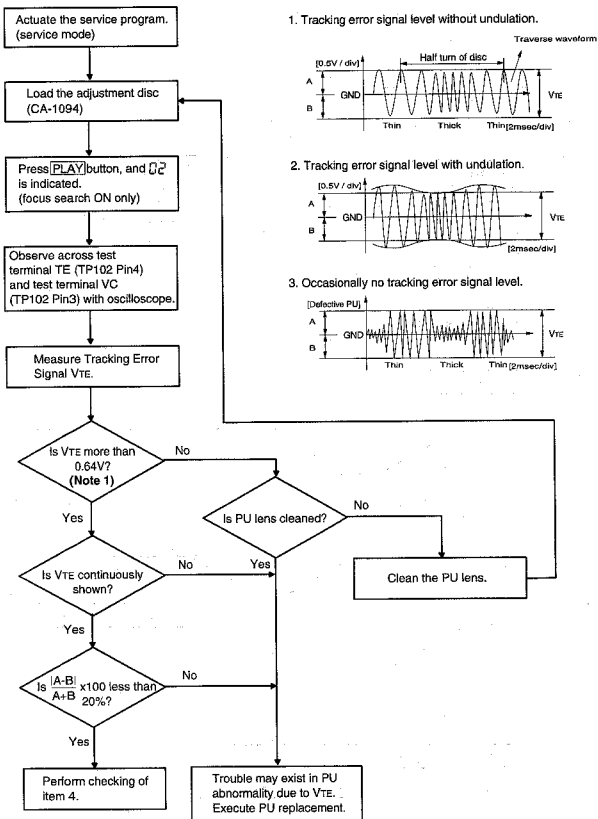

Note 1: When using the Test disc CO-76143 value are 0.70V.

4. Judgement by changing of PU due to HF level V_{HF} (check for proper HF wave)

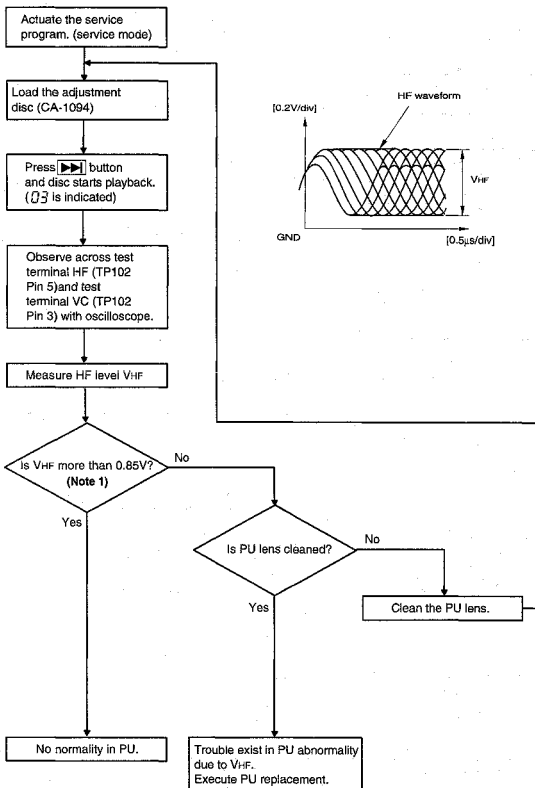

NOTE FOR PARTS LIST

- Part indicated with the mark * * are not always in stock and possibly to take a long period of time for supplying, or in some case supplying of part may be refused.
- When ordering of part, clearly indicate *1* and *1* (1) to avoid mis-supplying.
- Ordering part without stating its part number can not be supplied.
- Part indicated with the mark *★* is not illustrated in the exploded view.
- Not including Carbon Film $\pm 5\%$, 1/4W Type in the P.W.Board parts list. (Refer to the Schematic Diagram for those parts.)

WARNING:

Parts marked with this symbol  have critical characteristics.
Use ONLY replacement parts recommended by the manufacturer.

● Resistors

Ex:	RN	14K	2E	182	G	FR	Others
	Type	Shape and performance	Power	Resistance	Allowable error		
RD	Carbon	2B	1/6W	F	$\pm 1\%$	P	Pulse-resistant type
RC	Composition	2E	1/4W	D	$\pm 2\%$	NB	Low noise type
RS	Metal oxide film	2H	1/2W	J	$\pm 5\%$	NB	Non-burning type
RW	Winding	3A	1W	K	$\pm 10\%$	FR	Fuse-resistor
RI	Metal film	3D	2W	M	$\pm 20\%$	F	Lead wire forming
RIK	Metal structure	3F	3W				
		3H	5W				

● Resistance

$1 \quad \underline{0} \quad \underline{2} \Rightarrow 1500 \text{ ohm} = 1.5 \text{ k}\Omega$
Indicates number of zeros after effective number.
2-digit effective number.

• Units: ohm

$1 \quad \underline{R} \quad \underline{2} \Rightarrow 1.2 \text{ ohm}$
1-digit effective number.
2-digit effective number, decimal point indicated by R.

• Units: ohm

● Capacitors

Ex:	CE	D4W	1H	2R2	M	BP	Others
	Type	Shape	Dielectric and performance	Capacity	Allowable error		
CE	Aluminum foil electrolyte	0J	6.3V	F	$\pm 1\%$	HG	High stability type
CA	Aluminum oxide electrolyte	1A	10V	G	$\pm 2\%$	BP	Non-polar type
CS	Tantalum electrolyte	1C	18V	J	$\pm 5\%$	HR	Ripple-resistant type
OD	Film	1E	25V	K	$\pm 10\%$	DL	For charge and discharge
OK	Ceramic	1V	35V	M	$\pm 20\%$	HF	For assuring high frequency
OC	Ceramic	1H	50V	Z	$\pm 80\%$	U	UL part
CP	Oil	2A	100V		-30%	C	CBA part
CM	Misc.	3B	125V	P	$\pm 100\%$	W	UL-CBA type
CF	Metallized	2C	180V		-0%	F	Lead wire forming
CH	Metallized	2D	200V	D	$\pm 0.25\mu\text{F}$		
		2E	250V	O	$\pm 0.5\mu\text{F}$		
		2H	500V	A	Others		
		2J	630V				

● Capacity (electrolyte only)

$2 \quad \underline{2} \quad \underline{2} \Rightarrow 2200\mu\text{F}$
Indicates number of zeros after effective number.
2-digit effective number.

• Units: μF

$2 \quad \underline{R} \quad \underline{2} \Rightarrow 2.2\mu\text{F}$
1-digit effective number.
2-digit effective number, decimal point indicated by R.

• Units: μF

● Capacity (except electrolyte)

$2 \quad \underline{2} \quad \underline{2} \Rightarrow 2200\text{pF} = 0.0022\mu\text{F}$
(More than 2) — Indicates number of zeros after effective number.
2-digit effective number.

• Units: μF

$2 \quad \underline{2} \quad \underline{1} \Rightarrow 220\text{pF}$
(0 or 1) — Indicates number of zeros after effective number.
2-digit effective number.

• Units: μF

• When the dielectric strength is indicated in AC, "AC" is included after the dielectric strength value.

PARTS LIST OF P. W. BOARD

1U-2798 DIGITAL SERVO UNIT

(1U-2798: DCD-3000, DCD-S10 Europe Model)

(1U-2798D: DCD-3000, DCD-S10, U.S.A. & Canada Models)

(1U-2798B: DCD-3000 Multi-Voltage model)

Ref. No.	Part No.	Part Name	Remarks	Ref. No.	Part No.	Part Name	Remarks
SEMICONDUCTORS GROUP							
IC101	262 1879 003	IC CXD2515Q		R118	247 0009 901	Chip Resistor 4.7k Ω hm 1/10W	RM73B-472J
IC102	263 0909 906	IC BA6392FP		R120	247 0009 901	Chip Resistor 4.7k Ω hm 1/10W	RM73B-472J
IC103	263 0565 007	IC BA15218		R121	247 0011 944	Chip Resistor 47k Ω hm 1/10W	RM73B-473J
IC104	262 0910 002	IC YM3623B		R122	247 0009 956	Chip Resistor 7.5k Ω hm 1/10W	RM73B-752J
IC105	263 0565 007	IC BA15218		R123	247 0008 999	Chip Resistor 4.3k Ω hm 1/10W	RM73B-432J
IC110,111	262 1641 901	IC HD74HC157FP		R124	247 0005 989	Chip Resistor 220k Ω hm 1/10W	RM73B-221J
IC201	262 2111 003	IC M38173M6-292FP		R126	247 0018 906	Chip Resistor 0 Ω hm 1/10W	RM73B-0R0K
IC202	262 1265 002	IC TC74HCU04P		R127	247 0018 906	Chip Resistor 0 Ω hm 1/10W	RM73B-0R0K
IC300	262 1869 000	IC SM5845AF		R128	247 0008 960	Chip Resistor 3.3k Ω hm 1/10W	RM73B-332J
IC350	263 0615 902	IC BA15218F		R129	247 0007 974	Chip Resistor 1.3k Ω hm 1/10W	RM73B-132J
IC400	263 0516 001	IC NJM7812FA	Regulator +12V	R130	247 0014 967	Chip Resistor 1M Ω hm 1/10W	RM73B-105J
IC401	263 0539 004	IC NJM79M12FA	Regulator -12V	R131	247 0012 927	Chip Resistor 100k Ω hm 1/10W	RM73B-104J
IC402	263 0793 002	IC NJM7805FA(S)	Regulator +5V	R132	247 0009 998	Chip Resistor 11k Ω hm 1/10W	RM73B-113J
IC403	263 0809 006	IC NJM7805FA(S)	Regulator +5V	R133	247 0008 960	Chip Resistor 3.3k Ω hm 1/10W	RM73B-332J
IC406,407	268 0074 904	IC Protector ICP-N20		R135	247 0008 960	Chip Resistor 3.3k Ω hm 1/10W	RM73B-332J
IC409	263 0652 907	IC PST529C		R136	247 0007 945	Chip Resistor 1k Ω hm 1/10W	RM73B-102J
TR101	274 0036 905	Transistor 2SD468(C)		R138	247 0008 998	Chip Resistor 11k Ω hm 1/10W	RM73B-113J
TR102	272 0025 907	Transistor 2SB562(C)		R144,145	247 0012 943	Chip Resistor 120k Ω hm 1/10W	RM73B-124J
TR103	269 0026 900	Transistor RN2202(10K-10K)	Built in Resistor	R146	247 0005 989	Chip Resistor 220k Ω hm 1/10W	RM73B-221J
TR111	274 0036 905	Transistor 2SD468(C)		R147	247 0010 929	Chip Resistor 13k Ω hm 1/10W	RM73B-153J
TR112	272 0025 907	Transistor 2SB562(C)		R148	247 0010 916	Chip Resistor 13k Ω hm 1/10W	RM73B-133J
TR119	272 0025 907	Transistor 2SB562(C)		R149	244 2051 949	Metal oxide film 1 ohm 10W (Non-burning type)	RS1483A100R10B5(S)
TR120	274 0036 905	Transistor 2SD468(C)		R151	247 0009 956	Chip Resistor 7.5k Ω hm 1/10W	RM73B-752J
TR350	273 0303 910	Transistor 2SC1740S(S)		R161	247 0012 985	Chip Resistor 180k Ω hm 1/10W	RM73B-184J
TR401	272 0025 907	Transistor 2SB562(C)		R162	247 0011 999	Chip Resistor 75k Ω hm 1/10W	RM73B-753J
TR402,403	269 0025 901	Transistor RN1202(10K-10K)	Built in Resistor	R182	247 0003 949	Chip Resistor 220hm 1/10W	RM73B-220J
D101,102	276 0432 903	Diode 1S2270A		R202	247 0007 945	Chip Resistor 1k Ω hm 1/10W	RM73B-102J
D107	276 0432 903	Diode 1S2270A		R206,207	247 0007 945	Chip Resistor 1k Ω hm 1/10W	RM73B-102J
D203	276 0432 903	Diode 1S2270A		R209	247 0004 977	Chip Resistor 75ohm 1/10W	RM73B-750J
D402,403	276 0553 905	Diode 1SR35-200A		R214,215	247 0012 943	Chip Resistor 120k Ω hm 1/10W	RM73B-124J
D404	276 0466 908	Zener Diode HZ57C-1	7V	R216	247 0012 927	Chip Resistor 100k Ω hm 1/10W	RM73B-104J
D405	276 0484 906	Zener Diode HZ533-1	33V	R217	247 0005 989	Chip Resistor 220ohm 1/10W	RM73B-221J
D410-417	276 0553 905	Diode 1SR35-200A		R218	247 0004 922	Chip Resistor 470hm 1/10W	RM73B-470J
RESISTORS GROUP (Not Included Carbon Film $\pm 5\%$ 1/4W)							
R001,002	247 0018 905	Chip Resistor 0 Ω hm 1/10W	RM73B-0R0K	R219	247 0012 927	Chip Resistor 100k Ω hm 1/10W	RM73B-104J
R003,004	247 0009 914	Chip Resistor 5.1k Ω hm 1/10W	RM73B-512J	R225	247 0004 977	Chip Resistor 75ohm 1/10W	RM73B-750J
R005,006	247 0018 905	Chip Resistor 0 Ω hm 1/10W	RM73B-0R0K	R300-302	247 0007 945	Chip Resistor 1k Ω hm 1/10W	RM73B-102J
R007	247 0009 914	Chip Resistor 5.1k Ω hm 1/10W	RM73B-512J	R350-355	247 0008 985	Chip Resistor 10k Ω hm 1/10W	RM73B-103J
R101-103	247 0009 985	Chip Resistor 10k Ω hm 1/10W	RM73B-103J	R356	244 2043 937	Metal oxide film 10 ohm 10W (Non-burning type)	RS1483A100R10B5(S)
R109	247 0011 902	Chip Resistor 33k Ω hm 1/10W	RM73B-333J	R357	247 0008 915	Chip Resistor 2k Ω hm 1/10W	RM73B-202J
R114	247 0005 976	Chip Resistor 200ohm 1/10W	RM73B-201J	R358	247 0013 984	Chip Resistor 470k Ω hm 1/10W	RM73B-474J
R115	247 0003 949	Chip Resistor 22ohm 1/10W	RM73B-220J	R359	247 0009 956	Chip Resistor 7.5k Ω hm 1/10W	RM73B-752J
R116	247 0012 956	Chip Resistor 130k Ω hm 1/10W	RM73B-134J	R360	247 0009 985	Chip Resistor 10k Ω hm 1/10W	RM73B-103J
				R361	247 0010 987	Chip Resistor 27k Ω hm 1/10W	RM73B-273J
				R362	247 0014 967	Chip Resistor 1M Ω hm 1/10W	RM73B-105J
				R363	247 0013 913	Chip Resistor 240k Ω hm 1/10W	RM73B-244J
				R365-368	247 0014 967	Chip Resistor 1M Ω hm 1/10W	RM73B-105J

Ref. No.	Part No.	Part Name	Remarks	Ref. No.	Part No.	Part Name	Remarks
R406	247 0009 965	Chip Resistor 10kohm 1/10W	RM73B-103J	C405	257 0014 935	Ceramic(Chip) 0.1 μ F/25V	CK73F1E104Z
R407	247 0014 967	Chip Resistor 1Mohm 1/10W	RM73B-105J	C405,407	254 4319 792	Electrolytic 4700 μ F/25V	CE04W1E472MC(ASF)
R409	247 0005 989	Chip Resistor 220ohm 1/10W	RM73B-221J	C409	254 4367 906	Electrolytic 47 μ F/63V	CE04W1J470M(ASF)
R411	247 0006 962	Chip Resistor 470ohm 1/10W	RM73B-471J	C413,414	254 4313 989	Electrolytic 33 μ F/50V	CE04W1H330M(ASF)
R412	247 0009 914	Chip Resistor 5.1kohm 1/10W	RM73B-512J	C416	257 0003 988	Ceramic(Chip) 47pF/50V	CC73L1H470J
R413	247 0006 962	Chip Resistor 470ohm 1/10W	RM73B-471J	C423	257 0014 935	Ceramic(Chip) 0.1 μ F/25V	CK73F1E104Z
R415	247 0014 967	Chip Resistor 1Mohm 1/10W	RM73B-105J	C424	257 0009 966	Ceramic(Chip) 0.0047 μ F/50V	CK73B1H472K
R416	247 0007 945	Chip Resistor 1kohm 1/10W	RM73B-102J	C425,426	257 0002 921	Ceramic(Chip) 10pF/50V	CC73L1H100D
R420	247 0009 965	Chip Resistor 10kohm 1/10W	RM73B-103J	C427	256 1035 091	Ceramic 1 μ F/50V	CF93A1H105J
R423,424	247 0009 965	Chip Resistor 10kohm 1/10W	RM73B-103J	C440,441	257 0014 935	Ceramic(Chip) 0.1 μ F/25V	CK73F1E104Z
R431	247 0009 965	Chip Resistor 10kohm 1/10W	RM73B-103J	C442	257 0012 986	Ceramic(Chip) 0.01 μ F/50V	CK73F1H103Z
R440,441	247 0009 965	Chip Resistor 10kohm 1/10W	RM73B-103J	C443-448	257 0014 935	Ceramic(Chip) 0.1 μ F/25V	CK73F1E104Z
R442	247 0012 927	Chip Resistor 100kohm 1/10W	RM73B-104J	C463	257 0007 900	Ceramic(Chip) 0.001 μ F/50V	CC73L1H102J
R443	247 0009 965	Chip Resistor 10kohm 1/10W	RM73B-103J	C475,476	253 9039 906	Ceramic 0.1 μ F/25V	CK45-1E104Z
R445	247 0007 945	Chip Resistor 1kohm 1/10W	RM73B-102J	OTHER PARTS			
R460-463	247 0007 945	Chip Resistor 1kohm 1/10W	RM73B-102J	X101	399 0165 007	Crystal Resonator	(16.9344MHz) 1
R483	247 0009 914	Chip Resistor 5.1kohm 1/10W	RM73B-512J	X200	399 0165 007	Crystal Resonator	(16.9344MHz) 1
R484	247 0005 905	Chip Resistor 100ohm 1/10W	RM73B-101J	PT300	231 8063 009	:Pulse Trans	1
R705	247 0007 945	Chip Resistor 1kohm 1/10W	RM73B-102J	JK001,302	204 8178 028	1P Pin Jack	2
R491,492	244-2043 940	Metal Dials 2.2kohm 1W	RS1HBA2221NBS(S)	SW/BV			
CAPACITORS GROUP				U18,19	212 1118 503	Voltage Selector	Mult. Voltage only
C101	257 0014 935	Ceramic(Chip) 0.1 μ F/25V	CK73F1E104Z	U304	269 0097 007	Optical Connector (IN)	(GP1F32R) 1
C103	254 4356 713	Electrolytic 100 μ F/50V	CE04W1H010M(ARS)	U305	269 0098 006	Optical Connector (OUT)	(GP1F32T) 1
C105	257 0014 935	Ceramic(Chip) 0.1 μ F/25V	CK73F1E104Z	CB101	205 0321 014	5P Connector Base (RED)	1
C106	254 4254 938	Electrolytic 47 μ F/16V	CE04W1C470M(SME)	CB102	205 0343 058	5P Connector Base (KR-PH)	1
C107-109	257 0004 961	Ceramic(Chip) 100pF/50V	CC73L1H101J	CB103	205 0892 004	12P FFC Connector Base (P=1)	1
C112	254 4254 925	Electrolytic 33 μ F/16V	CE04W1C330M(SME)	CB201	205 0736 063	35P FFC Connector Base	1
C119	257 0009 940	Ceramic(Chip) 0.0033 μ F/50V	CK73B1H332K	CB202	205 0343 032	3P Connector Base (KR-PH)	1
C120	257 0014 935	Ceramic(Chip) 0.1 μ F/25V	CK73F1E104Z	CB401	205 0711 061	15P TBG Connector Base	1
C121	257 0011 941	Ceramic(Chip) 0.022 μ F/25V	CK73B1E223K	CB412	205 0233 087	8P EH Connector Base	1
C122	257 0005 944	Ceramic(Chip) 220pF/50V	CC73L1H221J	CB414,415	205 0653 036	3P VH Connector Base	2
C124	257 0006 969	Ceramic(Chip) 680pF/50V	CC73L1H681J	CB501	205 0233 087	8P EH Connector Base	1
C125	257 0010 997	Ceramic(Chip) 0.056 μ F/50V	CK73B1H563K	CB900	205 0581 001	2P VH Connector Base	1
C126	257 0007 942	Ceramic(Chip) 0.0015 μ F/50V	CC73L1H152J	CB903	205 0581 001	2P VH Connector Base	1
C127	257 0005 944	Ceramic(Chip) 220pF/50V	CC73L1H221J	CB903	204 2745 004	7P PH Connector Cord	1
C128	257 0011 909	Ceramic(Chip) 0.01 μ F/25V	CK73B1E103K	TP102	205 0190 078	7P NH Connector Base	1
C131	257 0011 909	Ceramic(Chip) 0.01 μ F/25V	CK73B1E103K	417 0476 036	Radiator	for IC400, 403	2
C132,133	257 0002 921	Ceramic(Chip) 10pF/50V	CC73L1H100D	471 3304 015	Blind Screw 3x8	4	
C135	257 0009 937	Ceramic(Chip) 0.0027 μ F/50V	CK73B1H272K	417 0476 010	Radiator	for IC401, 402	2
C141	254 4258 905	Electrolytic 4.7 μ F/35V	CE04W1V4R7M(SME)	412 2160 028	Common Plate	1	
C174	257 0014 935	Ceramic(Chip) 0.1 μ F/25V	CK73F1E104Z	461 0415 007	Rubber Sheet	3	
C204	257 0002 921	Ceramic(Chip) 10pF/50V	CC73L1H100D	415 0366 043	UL Tube (#2) Clear	1	
C207	254 4260 948	Electrolytic 1 μ F/50V	CE04W1H010M(SME)	461 0767 001	Rubber Sheet	1	
C301	257 0014 935	Ceramic(Chip) 0.1 μ F/25V	CK73F1E104Z				
C350	257 0011 909	Ceramic(Chip) 0.01 μ F/25V	CK73B1E103K				
C351	257 0004 961	Ceramic(Chip) 100pF/50V	CC73L1H101J				
C352-354	257 0014 935	Ceramic(Chip) 0.1 μ F/25V	CK73F1E104Z				
C401,402	254 4356 771	Electrolytic 3300 μ F/50V	CE04W1H332M(ARS)				
C403,404	254 4313 989	Electrolytic 33 μ F/50V	CE04W1H3330M(ASF)				

1U-2797M DIGITAL SERVO UNIT ASS'Y (DCD-S10 Asia model only)

Ref. No.	Part No.	Part Name	Remarks	Ref. No.	Part No.	Part Name	Remarks
SEMICONDUCTORS GROUP							
IC101	262 1879 003	IC CXD2515Q		R122	247 0009 956	Chip Resistor 7.5kohm 1/10W	RM73B-752J
IC102	263 0909 906	IC BA6392FP		R123	247 0009 999	Chip Resistor 4.3kohm 1/10W	RM73B-432J
IC103	263 0565 007	IC BA1521B		R124	247 0005 989	Chip Resistor 220ohm 1/10W	RM73B-221K
IC104	262 0910 002	IC YM3623B		R126	247 0018 905	Chip Resistor 0ohm 1/10W	RM73B-0R0K
IC105	263 0565 007	IC BA1521B		R127	247 0011 915	Chip Resistor 96kohm 1/10W	RM73B-963J
IC110,111	262 1641 901	IC HD74HC157FP		R128	247 0009 960	Chip Resistor 3.3kohm 1/10W	RM73B-332J
JC201	262 2111 003	IC M38173M6-292FP		R129	247 0007 974	Chip Resistor 1.3kohm 1/10W	RM73B-132J
IC202	262 1265 002	IC TC74HCJ04P		R130	247 0014 967	Chip Resistor 1Mohm 1/10W	RM73B-105J
IC300	262 1869 000	IC SM5845AF		R131	247 0012 927	Chip Resistor 100kohm 1/10W	RM73B-104J
IC350	263 0615 902	IC BA1521BF		R132	247 0009 998	Chip Resistor 11kohm 1/10W	RM73B-113J
IC400	263 0516 001	IC NJM7812FA	Regulator +12V	R133	247 0008 960	Chip Resistor 3.3kohm 1/10W	RM73B-332J
IC401	263 0539 004	IC NJM79M12FA	Regulator -12V	R136	247 0007 945	Chip Resistor 1kohm 1/10W	RM73B-102J
IC402	263 0793 002	IC NJM7806FA(S)	Regulator +6V	R138	247 0009 996	Chip Resistor 11kohm 1/10W	RM73B-113J
IC403	263 0809 006	IC NJM7805FA(S)	Regulator +5V	R144,145	247 0012 943	Chip Resistor 120kohm 1/10W	RM73B-124J
IC406,407	268 0074 904	IC Protector ICP-N20		R146	247 0005 989	Chip Resistor 220ohm 1/10W	RM73B-221K
IC409	263 0652 907	IC P5T529C		R147	247 0010 929	Chip Resistor 15kohm 1/10W	RM73B-153J
TR101	274 0036 906	Transistor 2SD468(C)		R148	247 0010 916	Chip Resistor 13kohm 1/10W	RM73B-133J
TR102	272 0025 907	Transistor 2SB562(C)		R149	244 2051 945	Metal oxide film 1 ohm 1/10W (Non-burning type)	RS1485A100NBS(S)
TR103	269 0026 900	Transistor RN2202(10K-10K)	Built In Resistor	R151	247 0009 956	Chip Resistor 7.5kohm 1/10W	RM73B-752J
TR111	274 0036 905	Transistor 2SD468(C)		R161	247 0012 985	Chip Resistor 160kohm 1/10W	RM73B-164J
TR112	272 0025 907	Transistor 2SB562(C)		R162	247 0011 999	Chip Resistor 75kohm 1/10W	RM73B-753J
TR119	272 0025 907	Transistor 2SB562(C)		R192	247 0003 949	Chip Resistor 22ohm 1/10W	RM73B-220J
TR120	274 0036 905	Transistor 2SD468(C)		R202	247 0007 945	Chip Resistor 1kohm 1/10W	RM73B-102J
TR350	273 0303 910	Transistor 2SC1740(S)		R205,207	247 0007 945	Chip Resistor 1kohm 1/10W	RM73B-102J
TR401	272 0025 907	Transistor 2SB562(C)		R209	247 0004 977	Chip Resistor 75ohm 1/10W	RM73B-750J
TR402,403	269 0025 901	Transistor RN1202(10K-10K)	Built In Resistor	R214,215	247 0012 943	Chip Resistor 120kohm 1/10W	RM73B-124J
D101,102	276 0432 903	Diode 1SS270A		R216	247 0012 927	Chip Resistor 100kohm 1/10W	RM73B-104J
D107	276 0432 903	Diode 1SS270A		R217	247 0005 989	Chip Resistor 220ohm 1/10W	RM73B-221J
D203	276 0432 903	Diode 1SS270A		R218	247 0004 922	Chip Resistor 47ohm 1/10W	RM73B-470J
D402,403	276 0553 905	Diode 1SR35-200A		R219	247 0012 927	Chip Resistor 100kohm 1/10W	RM73B-104J
D404	276 0468 906	Zener Diode HZ57C-1	7V	R225	247 0004 977	Chip Resistor 75ohm 1/10W	RM73B-750J
D405	276 0484 906	Zener Diode HZ533-1	33V	R300-302	247 0007 945	Chip Resistor 1kohm 1/10W	RM73B-102J
D410-421	276 0553 905	Diode 1SR35-200A		R350-355	247 0009 985	Chip Resistor 10kohm 1/10W	RM73B-103J
RESISTORS GROUP (Not Included Carbon Film ±5% 1/4W)							
R001,002	247 0018 905	Chip Resistor 0ohm 1/10W	RM73B-0R0K	R356	244 2041 945	Metal oxide film 10 ohm 1/10W (Non-burning type)	RS1485A100NBS(S)
R003,004	247 0009 914	Chip Resistor 5.1kohm 1/10W	RM73B-512J	R357	247 0008 915	Chip Resistor 2kohm 1/10W	RM73B-202J
R005,006	247 0018 905	Chip Resistor 0ohm 1/10W	RM73B-0R0K	R358	247 0013 984	Chip Resistor 470kohm 1/10W	RM73B-474J
R007	247 0009 914	Chip Resistor 5.1kohm 1/10W	RM73B-512J	R359	247 0009 956	Chip Resistor 7.5kohm 1/10W	RM73B-752J
R101-103	247 0009 985	Chip Resistor 10kohm 1/10W	RM73B-103J	R360	247 0009 985	Chip Resistor 10kohm 1/10W	RM73B-103J
R109	247 0011 902	Chip Resistor 33kohm 1/10W	RM73B-333J	R361	247 0010 987	Chip Resistor 27kohm 1/10W	RM73B-273J
R114	247 0005 976	Chip Resistor 200ohm 1/10W	RM73B-201J	R362	247 0014 967	Chip Resistor 1Mohm 1/10W	RM73B-105J
R115	247 0003 949	Chip Resistor 22ohm 1/10W	RM73B-220J	R363	247 0013 913	Chip Resistor 240Kohm 1/10W	RM73B-244J
R116	247 0012 956	Chip Resistor 130kohm 1/10W	RM73B-134J	R365-368	247 0014 967	Chip Resistor 1Mohm 1/10W	RM73B-105J
R118	247 0009 901	Chip Resistor 4.7kohm 1/10W	RM73B-472J	R406	247 0009 985	Chip Resistor 10kohm 1/10W	RM73B-103J
R120	247 0009 901	Chip Resistor 4.7kohm 1/10W	RM73B-472J	R407	247 0014 967	Chip Resistor 1Mohm 1/10W	RM73B-105J
R121	247 0011 944	Chip Resistor 47kohm 1/10W	RM73B-473J	R409	247 0005 989	Chip Resistor 220ohm 1/10W	RM73B-221J
				R411	247 0006 962	Chip Resistor 47ohm 1/10W	RM73B-471J
				R412	247 0009 914	Chip Resistor 5.1kohm 1/10W	RM73B-512J
				R413	247 0006 982	Chip Resistor 470ohm 1/10W	RM73B-471J

Ref. No.	Part No.	Part Name	Remarks	Ref. No.	Part No.	Part Name	Remarks	
R415	247 0014 987	Chip Resistor 1Mohm 1/10W	RM73B-105J	C423	257 0014 935	Ceramic(Chip) 0.1μF/25V	CK73F1E104Z	
R416	247 0007 945	Chip Resistor 1kohm 1/10W	RM73B-102J	C424	257 0009 966	Ceramic(Chip) 0.0047μF/50V	CK73B1H472K	
R420	247 0009 985	Chip Resistor 10kohm 1/10W	RM73B-103J	C425,426	257 0002 921	Ceramic(Chip) 10pF/50V	CC73L1H100D	
R423,424	247 0009 985	Chip Resistor 10kohm 1/10W	RM73B-103J	C427	256 1035 091	Ceramic 1μF/50V	CF93A1H105J	
R431	247 0009 985	Chip Resistor 10kohm 1/10W	RM73B-103J	C431,432	254 4446 720	Electrolytic 2.2μF/50V	CE04W1H29MC(ARSAG)	
R440,441	247 0009 985	Chip Resistor 10kohm 1/10W	RM73B-103J	C440	257 0014 935	Ceramic(Chip) 0.1μF/25V	CK73F1E104Z	
R442	247 0012 927	Chip Resistor 100kohm 1/10W	RM73B-104J	C441,442	256 6167 000	Polystyrol 0.01μF/125V	CO09S2B103K(B)	
R443	247 0009 985	Chip Resistor 10kohm 1/10W	RM73B-103J	C443-448	257 0014 935	Ceramic(Chip) 0.1μF/25V	CK73F1E104Z	
R445	247 0007 945	Chip Resistor 1kohm 1/10W	RM73B-102J	C463	257 0007 900	Ceramic(Chip) 0.001μF/50V	CC73L1H102J	
R460-463	247 0007 945	Chip Resistor 1kohm 1/10W	RM73B-102J	C491	255 4235 934	Film 0.01μF/100V	CQ93P2A103J(NHf)	
R483	247 0009 914	Chip Resistor 5.1kohm 1/10W	RM73B-512J					
R484	247 0005 905	Chip Resistor 100ohm 1/10W	RM73B-101J					
R705	247 0007 945	Chip Resistor 1kohm 1/10W	RM73B-102J					
R491,492	244 2043 940	Metal Oxide 2.2kohm 1W	RS4MB3A222J(BS)(S)					
CAPACITORS GROUP				OTHER PARTS				Qty
C101	257 0014 935	Ceramic(Chip) 0.1μF/25V	CK73F1E104Z	X101	399 0165 007	Crystal Resonator	(16.934MHz)	1
C103	254 4486 706	Electrolytic 1000μF/6.3V	CE04WJ0102MC(ARD)	X200	399 0165 007	Crystal Resonator	(16.934MHz)	1
C105	257 0014 935	Ceramic(Chip) 0.1μF/25V	CK73F1E104Z	PT300	231 8063 009	Pulse Trans		1
C106	254 4254 938	Electrolytic 47μF/16V	CE04W1C470M(SME)	JK301,302	204 8178 028	1P Pin Jack		2
C107-108	257 0004 961	Ceramic(Chip) 100pF/50V	CC73L1H101J	U304	269 0097 007	Optical Connector (IN)	(GP1F32F)	1
C112	254 4254 925	Electrolytic 33μF/16V	CE04W1C330M(SME)	U305	269 0098 006	Optical Connector (OUT)	(GP1F32T)	1
C119	257 0009 940	Ceramic(Chip) 0.0033μF/50V	CK73B1H332K	CB101	205 0321 054	5P Connector Base (RED)		1
C120	257 0014 935	Ceramic(Chip) 0.1μF/25V	CK73F1E104Z	CB102	205 0343 058	5P Connector Base (KR-PH)		1
C121	257 0011 941	Ceramic(Chip) 0.022μF/25V	CK73B1E223K	CB103	205 0892 004	12P FFC Connector Base (P=)		1
C122	257 0005 944	Ceramic(Chip) 220pF/50V	CC73L1H221J	CB201	205 0736 063	35P FFC Connector Base		1
C124	257 0006 969	Ceramic(Chip) 680pF/50V	CC73L1H681J	CB202	205 0343 032	3P Connector Base (KR-PH)		1
C125	257 0010 997	Ceramic(Chip) 0.056μF/50V	CK73B1H563K	CB401	205 0711 091	15P TBG Connector Base		1
C126	257 0007 942	Ceramic(Chip) 0.0015μF/50V	CC73L1H152J	CB410	205 0190 036	3P/NH Connector Base		1
C127	257 0005 944	Ceramic(Chip) 220pF/50V	CC73L1H221J	CB411	205 0190 005	6P NH Connector Base		1
C128	257 0011 909	Ceramic(Chip) 0.01μF/25V	CK73B1E103K	CB412	205 0233 087	8P EH Connector Base		1
C131	257 0011 909	Ceramic(Chip) 0.01μF/25V	CK73B1E103K	CB414,415	205 0653 036	3P VH Connector Base		2
C132,133	257 0002 921	Ceramic(Chip) 10pF/50V	CC73L1H100D	CB501	205 0233 087	8P EH Connector Base		1
C135	257 0009 937	Ceramic(Chip) 0.0027μF/50V	CK73B1H272K	CB800	205 0606 025	2P Wrapping Terminal		1
C141	254 4258 905	Electrolytic 4.7μF/35V	CE04W1V47M(SME)	CB801,802	205 0581 001	2P VH Connector Base		2
C174	257 0014 935	Ceramic(Chip) 0.1μF/25V	CK73F1E104Z	CB803	205 0581 001	2P VH Connector Base		1
C204	257 0002 921	Ceramic(Chip) 10pF/50V	CC73L1H100D		204 2745 004	7P PH Connector Cord		1
C207	254 4260 948	Electrolytic 1μF/50V	CE04W1H010M(SME)	TP102	205 0190 078	7P NH Connector Base		1
C301	257 0014 935	Ceramic(Chip) 0.1μF/25V	CK73F1E104Z		417 0476 010	Radiator	for IC400,403	2
C350	257 0011 909	Ceramic(Chip) 0.01μF/25V	CK73B1E103K		471 3304 015	Bind Screw 3x8		4
C351	257 0004 961	Ceramic(Chip) 100pF/50V	CC73L1H101J		417 0476 036	Radiator	for IC401,402	2
C352-354	257 0014 935	Ceramic(Chip) 0.1μF/25V	CK73F1E104Z		412 2160 031	Common Plate (CU 0.8)		1
C401,402	254 4356 771	Electrolytic 3300μF/50V	CE04W1H332M(CARS)		461 0415 007	Rubber Sheet		5
C403,404	254 4356 742	Electrolytic 4700μF/50V	CE04W1H471(A)RS)		415 0366 043	UL TUBE (φ2) Clear		1
C405	257 0014 935	Ceramic(Chip) 0.1μF/25V	CK73F1E104Z		461 0767 001	Rubber Sheet		1
C406,407	254 4319 792	Electrolytic 4700μF/25V	CE04W1E472MC(ASF)					
C409	254 4367 906	Electrolytic 47μF/63V	CE04W1J470M(ASF)					
C413,414	254 4313 989	Electrolytic 33μF/50V	CE04W1H330M(ASF)					
C416	257 0003 988	Ceramic(Chip) 47pF/50V	CC73L1H470J					
C420,421	256 1054 001	Metalized 0.1μF/50V	CF93B1H105K(GSG)					

1U-2796 AUDIO UNIT ASS'Y
(1U-2796: DCD-3000 Europe, U.S.A. & Canada and Multi-Voltage Models)
(1U-2796A: DCD-S10 Europe, U.S.A. & Canada models)
(1U-2796M: DCD-S10 Asia Model.)

Ref. No.	Part No.	Part Name	Remarks	Ref. No.	Part No.	Part Name	Remarks
SEMICONDUCTORS GROUP				CAPACITORS GROUP			
IC301-304	262 1837 016	IC :PCM1702P-J		C057	253 9039 906	Ceramic 0.1 μ F/25V	CK45-1E104Z
IC309.310	263 0655 007	IC BA15218		C321-324	254 4356 027	Electrolytic 22 μ F/50V	CE04W1H220M(ARS)
IC309.310	263 0960 006	*IC OP275GP	Asia model only	C325-332	254 4313 918	Electrolytic 10 μ F/50V	CE04W1H100M(ASF)
IC311-318	262 0864 006	IC μ PC4570C		C333-340	254 4356 713	Electrolytic 100 μ F/50V	CE04W1H101MC(ARS)
IC311.312	263 0836 008	IC SSM2139	Asia model only	C343-346	254 4356 742	Electrolytic 470 μ F/50V	CE04W1H471(ARS)
IC313.314	263 0360 008	:ICNE5532	Asia model only	C347-350	254 4347 052	Electrolytic 2.2 μ F/50V	CE04W1H2R2M(ARSA)
IC315-318	263 0205 008	IC NJM2041DD	Asia model only				
IC355.356	263 0432 907	IC NJM79L05A	Regulator +5V	C351	254 4256 852	Electrolytic 220 μ F/25V	CE04W1E221M(SME)
IC357.358	263 0722 905	IC NJM79L05A	Regulator -5V	C351	254 4488 704	Electrolytic 220 μ F/25V	CE04W1E221MC(ARD)
IC501	263 0995 004	IC NJM4556AD		C353-356	255 4235 921	Film 270pF/100V	DCD-S10 Asia only
IC801	499 0254 004	Remote Sensor GPIU571		C353-356	255 6175 047	Polystyrol 270pF/125V	CQ09S2A271J(NH)
IC901.902	263 0655 007	IC BA15218					CQ09S2B271KF(B)
							DCD-S10 Asia only
TR351	269 0026 900	Transistor RN2202 (10K-10K)	Built in Resistor	C357-360	255 4235 918	Film 100pF/100V	CQ09P2A101J(NH)
TR352	269 0025 901	Transistor RN1202 (10K-10K)	Built in Resistor	C357-360	255 6175 034	Polystyrol 100pF/125V	CQ09S2B101KF(B)
TR353	269 0026 900	Transistor RN2202 (10K-10K)	Built in Resistor				DCD-S10 Asia only
TR500.501	273 0253 918	Transistor 25C2878 (A/B)		C371.372	255 4232 911	Film 180pF/100V	CQ09P2A181J(NH)
TR801.802	269 0025 901	Transistor RN1202 (10K-10K)	Built in Resistor	C371.372	255 6175 016	Polystyrol 80pF/125V	CQ09S2B181KF(B)
TR804	269 0025 901	Transistor RN1202 (10K-10K)	Built in Resistor				DCD-S10 Asia only
TR901-909	273 0253 918	Transistor 25C2878 (A/B)		C373.374	255 4232 908	Film 820pF/100V	CQ09P2A821J(NH)
				C373.374	255 6175 021	Polystyrol 820pF/125V	CQ09S2B821KF(B)
							DCD-S10 Asia only
D351-354	276 0432 903	Diode 1SS270A		C375-380	255 4237 903	Film 0.0027 μ F/100V	CQ09P2A102J(NH)
D805-807	276 0432 903	Diode 1SS270A		C375.380	255 6175 005	Polystyrol 0.0027 μ F/125V	CQ09S2B272KF(B)
D818.819	276 0432 903	Diode 1SS270A					DCD-S10 Asia only
LD801.802	393 9416 906	LED SEL-2810R		C381-388	254 4356 713	Electrolytic 100 μ F/50V	CE04W1H101MC(ARS)
LD804	393 9419 905	LED SEL-2810D		C389.390	255 6167 000	Polystyrol 0.01 μ F/125V	CQ09S2B103K(SA)
							DCD-S10 Asia only
RESISTORS GROUP (All carbon film resistor is DCD-S10 Asia model only.)				C391.392	256 1045 007	Metalized 1 μ F/63V	CF93B1J105K(SA)
							(DCD-S10 only)
R335.336	241 2471 962	Carbon Film 10kohm 1/4W	RD14B2E100J(PSNB)	C503	254 4254 776	Electrolytic 470 μ F/16V	CE04W1C471MC(SME)
R337.338	241 2427 923	Carbon Film 100kohm 1/4W	RD14B2E104J(PSNB)	C503	254 4487 705	Electrolytic 470 μ F/16V	CE04W1C471MC(ARD)
R351	241 2424 984	Carbon Film 10kohm 1/4W	RD14B2E103J(PSNB)				(DCD-S10 Asia only)
R353	241 2423 956	Carbon Film 3kohm 1/4W	RD14B2E302J(PSNB)	C504	254 4254 792	Electrolytic 2200 μ F/16V	CE04W1C222MC(SME)
R354	241 2419 999	Carbon Film 91ohm 1/4W	RD14B2E91J(PSNB)	C504	254 4452 714	Electrolytic 2200 μ F/16V	CE04W1C222MC(ASF)
R355	241 2422 944	Carbon Film 11kohm 1/4W	RD14B2E102J(PSNB)				(DCD-S10 Asia only)
R361-364	241 2421 929	Carbon Film 330ohm 1/4W	RD14B2E331J(PSNB)	C807	253 9036 909	Ceramic 0.1 μ F/25V	CK45-1E104Z
R365-372	241 2422 944	Carbon Film 11kohm 1/4W	RD14B2E102J(PSNB)	C800	253 9034 903	Ceramic 0.01μF/50V/40C	CK45-1E104Z
R373-376	241 2423 972	Carbon Film 3.6kohm 1/4W	RD14B2E362J(PSNB)				
R377-380	241 2423 927	Carbon Film 2.2kohm 1/4W	RD14B2E222J(PSNB)	C901-904	254 4356 739	Electrolytic 47 μ F/50V	CE04W1H470MC(ARS)
R381.382	241 2424 942	Carbon Film 6.8kohm 1/4W	RD14B2E682J(PSNB)	C905-908	255 4232 924	Film 39pF/100V	CQ09P2A390J(NH)
R383.384	241 2423 972	Carbon Film 3.6kohm 1/4W	RD14B2E362J(PSNB)	C909-912	255 4232 937	Film 0.001 μ F/100V	CQ09P2A102J(NH)
R385.386	241 2422 973	Carbon Film 1.3kohm 1/4W	RD14B2E132J(PSNB)				
R387.388	241 2423 943	Carbon Film 2.7kohm 1/4W	RD14B2E272J(PSNB)				
R389-392	241 2424 900	Carbon Film 4.7kohm 1/4W	RD14B2E472J(PSNB)	OTHER PARTS		Qty	
R811-814	241 2424 942	Carbon Film 6.8kohm 1/4W	RD14B2E682J(PSNB)	RLS01	214 0127 003	Relay (RY-12W)	2
R815	241 2418 945	Carbon Film 22ohm 1/4W	RD14B2E220J(PSNB)				
R816	241 2415 919	Carbon Film 47ohm 1/4W	RD14B2E470J(PSNB)	RLS800	212 0131 009	Power Switch (TV-S)	1
R999.999	241 2427 923	Carbon Film 100kohm 1/4W	RD14B2E104J(PSNB)		212 5004 907	Tact Switch	7
VR300	211 0544 111	Variable Resistor 20Kohm	V1620V20FA203M	JK403.404	204 9406 017	1P Pin Jack	2

1U-2836A SERVO AMP UNIT ASS'Y
(This unit is common in all models and
Ser. No. 501 **** and after.)

Ref. No.	Part No.	Part Name	Remarks	Q'ty
JK405	204 8285 009	4P RCA Pin Jack (EMI)	Except DCD-S10 Asia	1
PJ301	204 8322 007	Head Phone Jack		1
FL801	363 4095 007	FL Tube	(FIP10SM6)	1
CB301	204 2447 014	8P PH-SAN Shield Cord		1
CB400	205 0711 061	15P TBG Connector Base		1
CB401,402	205 0581 001	2P VH Connector Base	DCD-S10	2
CB404,405	205 0653 036	3P VH Connector Base	Asia only	2
CB406	205 0343 061	6P Connector Base (KR-PH)		1
CB805	205 0736 083	35P PFC Connector Base		1
CB900	205 0581 001	2P VH Connector Base		1
CC301	205 0343 087	8P Connector Base (KR-PH)		1
CC302	203 4650 039	3P PH-SAN Connector Cord		1
CN901	205 0343 061	6P Connector Base (KR-PH)		1
CN902,903	205 0428 009	3P Cannon Connector		2
	415 0299 000	Condenser Cover	for C900	1

Ref. No.	Part No.	Part Name	Remarks
SEMICONDUCTORS GROUP			
IC901	263 0565 007	IC BA15218	
TR901	269 0025 901	Transistor RN1202	Built in resistor
RESISTORS GROUP (Not Included Carbon Film ±5% 1/4W type. Refer to the Schematic diagram for those parts.)			
CAPACITORS GROUP			
C901	253 2293 834	Ceramic Cap. 100pF/50V	CK45B1H101K
C902	256 1035 907	Metallized Cap. 0.18μF/50V	CF93A1H184J
OTHER GROUP			
		(P.W. board)	(1)
CB901	205 0343 074	7P Conn. Base (KR-PH)	1
	001 0018 082	Vinyl Wire	L=40 1
	001 0164 020	Vinyl Wire	L=140 1

IC TERMINAL FUNCTION

CXD2515Q (IC101)

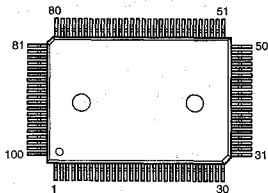

CXD2515Q Terminal Function

Pin No.	Symbol	I/O	Terminal Function
1	SRON	O	Sted drive output.
2	SRDR	O	Sted drive output.
3	SFON	O	Sted drive output.
4	TFDR	O	Tracking drive output.
5	TRON	O	Tracking drive output.
6	TRDR	O	Tracking drive output.
7	TFON	O	Tracking drive output.
8	FFDR	O	Focus drive output.
9	FRON	O	Focus drive output.
10	FRDR	O	Focus drive output.
11	FFON	O	Focus drive output.
12	VCOO	O	Oscillation circuit output for analog EFM PLL.
13	VCOI	I	Oscillation circuit input for analog EFM PLL. f _{LOCK} =6.8436MHz.
14	TEST	I	Test terminal, normally GND.
15	V _{SS}	—	Digital GND.
16	TES2	I	Test terminal, normally GND.
17	TES3	I	Test terminal, normally GND.
18	PDO	O	Charge pump output for analog EFM PLL.
19	VPCO	O	PLL charge pump output for variable pitch.
20	VCKI	I	Clock input from external VCO for variable pitch. f _{CENTER} =16.9344MHz.
21	AV _{DD}	—	Analog power supply.
22	IGEN	I	Current source reference resistor connecting terminal for OP amplifier.
23	AV _{SS}	—	Analog GND.
24	ADII	I	A/D converter input terminal.
25	ADIO	O	OP amplifier output terminal.
26	RFDC	I	RF signal input. Input range 2.15~5.0V (at V _{DD} =AV _{DD} =5.0V).
27	TE	I	Tracking error signal input. Input range 2.5V±1.0V (at V _{DD} =AV _{DD} =5.0V).
28	SE	I	Sted error signal input. Input range 2.5V±1.0V (at V _{DD} =AV _{DD} =5.0V).
29	FE	I	Focus error signal input. Input range 2.5V±1.0V (at V _{DD} =AV _{DD} =5.0V).
30	VC	I	Mid-point voltage input terminal.
31	FILO	O	Filter output for master PLL.
32	FILI	I	Filter input for master PLL.
33	PCO	O	Charge pump output for master PLL.
34	CLTV	I	VCO control voltage input for master.
35	AV _{SS}	—	Analog GND.
36	RFAC	I	EFM signal input.
37	BIAS	I	Asymmetry circuit constant current input.
38	ASYI	I	Asymmetry compare voltage input.
39	ASYO	O	EFM full swing output. (LeV _{SS} , H=V _{DD}).
40	AV _{DD}	—	Analog power supply.

Pin No.	Symbol	I/O	Terminal Function
41	Vcc	—	Digital power supply.
42	ASVE	I	Asymmetry circuit ON/OFF (L=OFF, H=ON).
43	PSSL	I	Audio data output mode shifting input. L to serial output, H to parallel output.
44	WDCK	O	48-bit slot D/A interface. Word clock f=2Fs.
45	LRCK	O	48-bit slot D/A interface. LR clock f=Fs.
46	DA16	O	DA16 output at PSSL=1. Serial data of 48-bit slot at PSSL=0.
47	DA15	O	DA15 output at PSSL=1. Bit clock of 48-bit slot at PSSL=0.
48	DA14	O	DA14 output at PSSL=1. Serial data of 64-bit slot at PSSL=0.
49	DA13	O	DA13 output at PSSL=1. Bit clock of 64-bit slot at PSSL=0.
50	DA12	O	DA12 output at PSSL=1. LR clock of 64-bit slot at PSSL=0.
51	DA11	O	DA11 output at PSSL=1. GTOP output at PSSL=0.
52	DA10	O	DA10 output at PSSL=1. XUGF output at PSSL=0.
53	DA09	O	DA09 output at PSSL=1. XPCLK output at PSSL=0.
54	DA08	O	DA08 output at PSSL=1. GFS output at PSSL=0.
55	DA07	O	DA07 output at PSSL=1. RFCK output at PSSL=0.
56	DA06	O	DA06 output at PSSL=1. C2PO output at PSSL=0.
57	DA05	O	DA05 output at PSSL=1. XRAOF output at PSSL=0.
58	DA04	O	DA04 output at PSSL=1. MNT3 output at PSSL=0.
59	DA03	O	DA03 output at PSSL=1. MNT2 output at PSSL=0.
60	DA02	O	DA02 output at PSSL=1. MNT1 output at PSSL=0.
61	DA01	O	DA01 output at PSSL=1. MNT0 output at PSSL=0.
62	XTAI	I	XTai oscillation circuit input. 16.9344MHz or 33.8688MHz input.
63	XTAO	O	XTai oscillation circuit output.
64	XTSL	I	XTai selection input terminal. L at X'tai for 16.9344MHz, at 33.8688MHz turns to H.
65	Vss	—	Digital GND.
66	FST1	I	2/3 divided input of terminals 62 and 63.
67	FST0	O	2/3 divided input of terminals 62 and 63. Unvarying by variable pitch.
68	C4M	O	4.2366MHz output. Simultaneously varies when variable pitched.
69	C16M	O	16.9344MHz output. Simultaneously varies when variable pitched.
70	MD2	I	Digital-out ON/OFF control terminal (L=OFF, H=ON).
71	DOUT	O	Digital-out output terminal.
72	EMPH	O	Emphasis mode output of playback disc (L at without emphasis, H at emphasized).
73	WFCK	O	WFCK output.
74	SCDR	O	Subcode sync output terminal (H at detecting either one of SO or SI subcode sync).
75	SBSO	O	Serial output of sub P-W.
76	EXCK	I	Clock input for SBSO read out.
77	SQSO	O	SubQ 80-bit output. PCM peak data, level data 16-bit output.
78	SQCK	I	Clock input for SQSO read out.
79	MUTE	I	Mute shifting terminal (H to mute).
80	SENS	O	SENS output. Outputs to CPU.
81	XRST	I	System reset (L to reset).
82	DIRC	I	Used for at-track jump.
83	SCLK	I	Clock for SENS serial data reading.
84	DFSW	I	DFCT shifting terminal (H to DFCT countermeasure circuit OFF).
85	ATSK	I	Anti-shock terminal.
86	DATA	I	Serial data input from CPU.
87	XLAT	I	Latch input from CPU.
88	CLOCK	I	Serial data transfer clock input from CPU.
89	COUT	O	Number of track count signal output.
90	Vcc	—	Digital power supply.
91	MIRR	O	Mirror signal output.
92	DFCT	O	Defect signal output.
93	FOK	O	Focus OK output.
94	FSW	O	Output filter shifting output of spindle motor.
95	MON	O	ON/OFF control output of spindle motor.
96	MDP	O	Servo control of spindle motor.
97	MDS	O	Servo control of spindle motor.
98	LOCK	O	Sampling GFS with 460Hz and outputs H at GFS is H. Outputs L when continuously 8 times L.
99	SSTP	I	Terminal for inner most circle detection signal of disc.
100	SFDR	O	Sled drive output.

M38173M6-292FP (IC201)

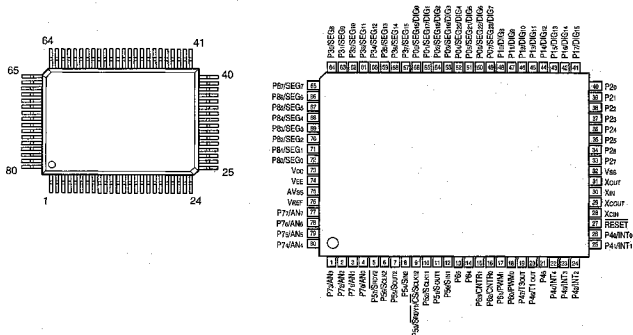

M38173M6-292FP Terminal Function

Pin No.	Terminal Name	Symbol	I/O	TY	OP	AC	IN	Terminal Function
1	P73	DMUTE	O	A	—	H	H	Digital mute signal (H: ON, L: OFF).
2	P72	AMUTE	O	A	—	H	H	Analog mute signal (H: ON, L: OFF).
3	P71	VRUP	O	A	—	L	H	Electrical-drive variable resistor up output.
4	P70	VRDN	O	A	—	L	H	Electrical-drive variable resistor down output.
5	P57	INVERT	O	B	—	L	H	Audio inverting output (L: negative, H: positive)
6	P56	FDATA	O	B	—	—	H	Data for NPC SM5845 control.
7	P55	CLK	O	B	—	—	H	Clock for NPC SM5845 control.
8	P54	FLAT	O	B	—	L	H	Latch for NPC SM5845 control.
9	P53	INMOST	I	B	—	L	(H)	INMOST SW inner circle detection switch.
10	P52	SQCK	O	B	—	—	H	SUB code Q data reading clock.
11	P51	MODEL	I	B	—	—	H	H: DCD 3000, L: DCD1015
12	P50	SUBQ	I	B	—	H	(H)	SUB code Q data input.
13	P65	DIRC	O	A	—	L	H	DIRC output (CXA1372).
14	P64	FOK	I	A	—	H	(H)	FOK input (CXA1372).
15	P63	GFS	I	A	—	H	(H)	GFS input (CXA1372).
16	P62	SENSE	I	A	—	H	(H)	Sense input (CXA1372, CXA2515).
17	P61	CLK	O	A	—	—	H	Control clock output (CXA1372, CXD2515).
18	P60	DATA	O	A	—	—	H	Control data output (CXA1372, CXD2515).
19	P47	XLT	O	A	—	L	H	Control latch output (CXA1372, CXD2515).
20	P46	LASW	O	A	—	H	L	Laser drive signal.
21	P45	SCLK	O	A	—	—	L	SUB setting value read clock output.
22	P44	STEP	O	A	—	—	—	Electron variable resistor gain setting clock output.
23	P43	E. VR. UP	—	A	—	—	H	Electron variable resistor up output.
24	P42	E. VR. DOWN	O	A	—	—	H	Electron variable resistor down output.
25	P41/INT1	SCOR	I	A	—	L	(H)	Interrupt from SUB code.

I/O: I/O
 TY: Type
 OP: Option
 AC: Action
 IN: Initialize

Type: A: Standard
 B: N-ch Open drain
 C: P-ch Open drain (high voltage proof)

Pin No.	Terminal Name	Symbol	I/O	TY	OP	AC	IN	Terminal Function
26	P4QINT0	RIN	I	A	---	L	(H)	Interrupt from remote control.
27	RESET	RST	I	---	---	L	---	Reset signal input.
28	XCIN	LROCK	I	---	---	---	---	SUB clock input for LROCK.
29	XCOUJ	NC	O	---	---	---	---	Open.
30	XIN	XIN	I	---	---	---	---	XTAL 4.23 MHz.
31	XOUT	XOUT	O	---	---	---	---	XTAL 4.23 MHz.
32	VSS	GND	I	---	---	---	---	GND
33	P27	MAINS	O	A	---	H	H	Alpha 1 ON/OFF H: ON, L: OFF.
34	P26	SHFTN	O	A	---	L	H	Bit shift ON/OFF H: OFF, L: ON.
35	P25	ADEEN	O	A	---	L	H	Alpha 2 ON/OFF H: OFF, L: ON.
36	P24	AGCNTL	O	A	---	H	L	Auto gain control, H: auto adjustment.
37	P23	OPEN	O	A	---	L	H	Loader open signal.
38	P22	CLOSE	O	A	---	L	H	Loader close signal.
39	P21	MD2	O	A	---	H	H	Digital out ON/OFF signal, H: ON.
40	P20	CD/AUX	O	A	---	---	---	DA input source selection output, H: AUX, L: CD.
41	P17	G2	O	C	PD	H	L	Grid terminal (display indication).
42	P16	G3	O	C	PD	H	L	Grid terminal (display indication).
43	P15	G4	O	C	PD	H	L	Grid terminal (display indication).
44	P14	G5	O	C	PD	H	L	Grid terminal (display indication).
45	P13	G6	O	C	PD	H	L	Grid terminal (display indication).
46	P12	G7	O	C	PD	H	L	Grid terminal (display indication).
47	P11	G8	O	C	PD	H	L	Grid terminal (display indication).
48	P10	G9	O	C	PD	H	L	Grid terminal (display indication).
49	P07	G1	O	C	PD	H	L	Grid terminal (display indication).
50	P08	G10	O	C	PD	H	L	Grid terminal (display indication).
51	P05	FOCUS	O	C	PD	L	H	Focus error offset, L: Focus search.
52	P04	l	O	C	PD	H	L	Segment terminal (display indication).
53	P03	k	O	C	PD	H	L	Segment terminal (display indication).
54	P02	j	O	C	PD	H	L	Segment terminal (display indication).
55	P01	i	O	C	PD	H	L	Segment terminal (display indication).
56	P00	a	O	C	PD	H	L	Segment terminal (display indication).
57	P37	b	O	C	PD	H	L	Segment terminal (display indication).
58	P36	f	O	C	PD	H	L	Segment terminal (display indication).
59	P35	g	O	C	PD	H	L	Segment terminal (display indication).
60	P34	e	O	C	PD	H	L	Segment terminal (display indication).
61	P33	d	O	C	PD	H	L	Segment terminal (display indication).
62	P32	h	O	C	PD	H	L	Segment terminal (display indication).
63	P31	c	O	C	PD	H	L	Segment terminal (display indication).
64	P30	OPTICAL	O	C	---	---	L	Optical output, H: OPT, L: COAX.
65	P87	SER2	I	C	---	---	---	Digital input for Is detection input 2.
66	P86	SER1	I	C	---	---	---	Digital input for Is detection input 1.
67	P85	ERR	I	C	---	---	---	Digital input for error input.
68	P84	DEP	I	C	---	---	---	Digital input for emphasis ON/OFF input.
69	P83	K4	I	C	---	H	(H)	Key input 4
70	P82	K3	I	C	---	H	(H)	Key input 3
71	P81	K2	I	C	---	H	(H)	Key input 2
72	P80	K1	I	C	---	H	(H)	Key input 1
73	VCC	+5V	I	---	---	---	---	+5V
74	VEE	-30V	I	---	---	---	---	Power supply for FIP drive
75	AVSS	GND	I	---	---	---	---	GND
76	VREF	+5V	I	---	---	---	---	+5V
77	P77	OPT LED	O	A	---	H	L	Optical LED drive output.
78	P76	COAX LED	O	A	---	H	L	COAX LED drive output.
79	P75	SWCL	I	A	---	L	(L)	Close detection switch.
80	P74	SWOP	I	A	---	L	(L)	Open detection switch.

PCM1702P-J (IC301-304)

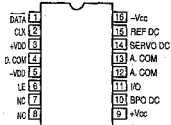
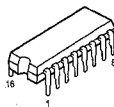

BA15218
(IC103, 105, 309, 310, 901)
OP275GP (IC309, 310)
SSM2139 (IC311, 312)
NE5532 (IC313, 314)

DCD-S10
Asia model only



NJM2041DD (IC315-318) DCD-S10 Asia model only
NJM4556AD (IC501)
 μ PC4570C (IC311-318)



BA15218F (IC350)



NJM7812FA (IC400)

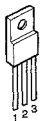

1: Input
2: GND
3: Output

NJM79M12FA (IC401)

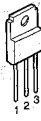

1: GND
2: Output
3: Input

NJM7805FA (S) (IC403)
NJM7806FA (S) (IC402)

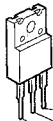

1: Output
2: GND
3: Input

SM5845-AF (IC300)

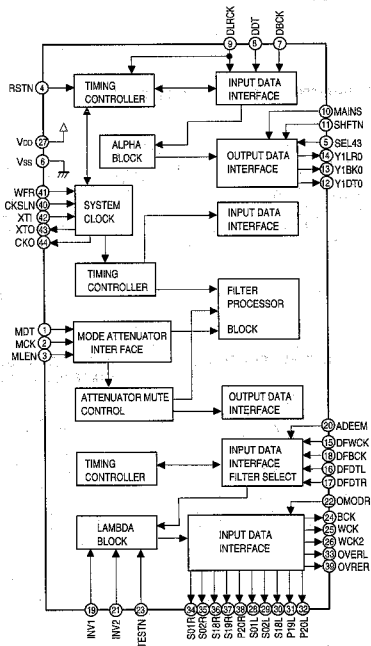
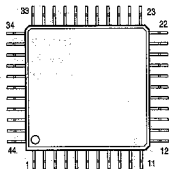

NJM78L05A
(IC355, 356)

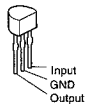

PST529C
(IC409)

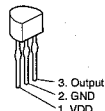

NJM79L05A
(IC357, 358)

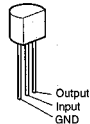

● **IC PROTECTOR**
ICP-N20 (IC406, 407)

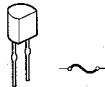

● **OTHER**

GP1U571 (Remote Control Receiver)
(IC801)



1. Vcc
2. Output
3. GND
4. Case Fin
5. Case Fin

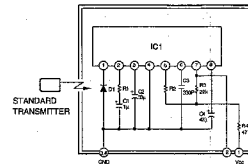

- IC1 : CX20106A Chip
- D1 : PIN Photodiode Chip
- C1,C2,C4 : Aluminum Electrolytic Capacitor
- C3 : SL Characteristic ±5%
- R1 : Gain control resistor
- R2 : fo control resistor (Using ±1%)
- R (Other than above items) : ±5%

● **TRANSISTORS**

RN1202 (10K-10K) NPN Type
RN2202 (10K-10K) PNP Type
(BUILT IN RESISTOR)

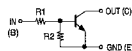
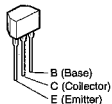

	R1	R2
RN1202	10kohm	10kohm

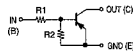

	R1	R2
RN2202	10kohm	10kohm

2SB562 (C)
2SC2878 (A/B)
2SD468 (C)

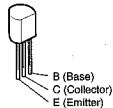

2SC1740S (S)

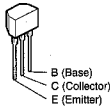

● **DIODES**

HZS7C-1
HZS33-1



1SS270A



1SR35-200A

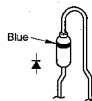

SEL2810R (Red)
SEL2810D (Amber)

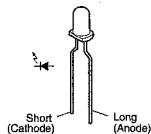

EXPLODED VIEW (DCD-S10 Europe, U.S.A. & Canada Models)

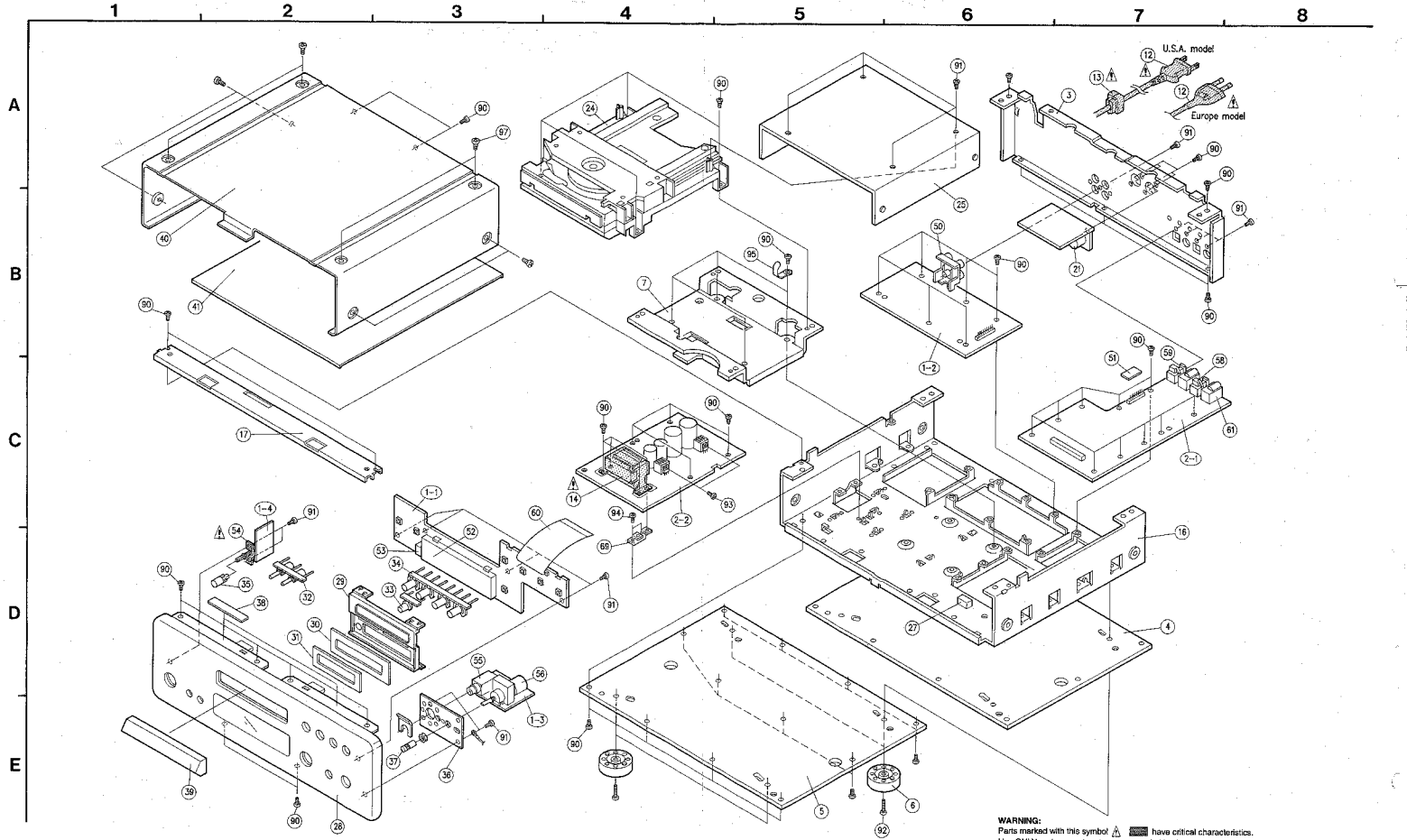

WARNING:
 Parts marked with this symbol  have critical characteristics.
 Use ONLY replacement parts recommended by the manufacturer.

(DCD-S10 Asia Model)

Ref. No.	Part No	Part Name	Remarks	Qty	Ref. No.	Part No	Part Name	Remarks	Qty
1	1U-2798 M	Audio P.W.B. Assy		1s	62	1U-2836 A	Servo Amp. P.W.B. Assy		1s
1-1	—	Display Unit		(1)	★ 63	214 0127 003	Relay (RY-12W)	RL301	1
1-2	—	Audio Unit		(1)	★ 64	513 1606 006	Power Trans Label (A)		1
1-3	—	Head Phone Unit		(1)	★ 65	513 1607 005	Power Trans Label (B)		1
1-4	—	Power Switch Unit		(1)	★ 66	125 0078 001	Squara Washer		2
1-5	—	Balance Out Unit		(1)	★ 67	513 2289 043	Rating Sheet		1
2	1U-2797 M	Digital Servo P.W.B. Assy		1s	★ 68	513 1220 000	Caution Label	Bottom Cover	1
2-1	—	Servo Unit		(1)	★ 69	412 3956 008	Trans Bracket		1
2-2	—	Power Supply Unit		(1)					
3	105 1170 001	Rear Panel		1	90	473 8034 001	Screw 3x8 CBTS(B)-CU		48
4	105 1152 100	Inside Bottom		1	91	473 7518 104	Screw 3x10 CBTS(P)-CU		18
5	105 1151 211	Bottom Cover		1	92	473 7007 026	Screw 4x16 CBTS(S)-B	Black	4
6	104 0267 006	Foot Assy		4	93	473 7508 017	Screw 3x10 CBTS(S)-B	Black	6
7	412 2843 400	Mecha Fix Bracket		1	94	473 7002 021	Screw 3x8 CBTS(S)-B	Black	2
8	129 0214 003	Bass Rubber (l)		1	95	445 0048 016	Cord Holder	L=50	2
9	129 0215 002	Bass Rubber (s)		1	96	—	—		
10	412 3992 101	Pin Jack Damper		1	97	471 6043 008	Special Screw		8
11	129 0212 005	Foot Damper		4	98	471 3830 000	Screw 3x6 CBS-CU		4
14	233 6171 003	Power Trans (Audio)		1					
15	233 6172 008	Power Trans (Digital)		1					
16	411 1317 219	Chassis		1					
17	411 1318 014	Front Angle		1					
18	—	—		1					
20	203 3962 003	AC Inlet		1	151	505 0131 076	Cabinet Cover		1
21	205 0428 009	3P Cannon Connector	CN902,903	2	152	504 0092 060	Styrene Paper	For AC Cord	1
22	129 0213 004	Trans Damper		2	153	503 9275 102	Cushion		2
23	412 3957 007	Trans Plate		2	154	501 1860 056	Carton Case		1
24	337 0041 000	CD Mecha Unit (FG-77)		1	155	GEN 3032 -3	Envelop Sub. Assy		1s
25	412 3866 108	Mecha Cover		1	155-1	505 0036 030	Poly Cover		(1)
26	441 1706 007	Mecha Cover Damper		2	155-2	511 2721 007	Operating Instructions (3)		(1)
27	461 0889 015	Cushion (T:15)		1	155-3	511 2722 006	Operating Instructions		(1)
28	144 2426 100	Front Panel Assy		1	155-4	204 8121 004	: 2P Pin Cord		(1)
29	146 1542 216	FL Holder		1	155-5	399 0263 006	Remote Control Unit	RC-253	(1)
30	143 0919 207	Window		1	155-6	202 0644 002	AC Plug Adaptor		(1)
31	144 2450 000	Display Frame		1	155-7	205 2130 000	AC Cord W/Con & Plug		(1)
32	113 1708 102	Input Button Assy		1	155-8	511 2773 000	Notice Sheet		(1)
33	113 1709 004	OP/CL Button Assy		1	156	513 9111 001	Color Label (Gold)		2
34	113 1710 006	Function Button Assy		1					
35	113 9303 101	Power Button Assy		1					
36	412 3935 003	Headphone Bracket		1					
37	113 1713 100	Headphone Button Assy		1					
38	129 0140 151	Rubber Sheet	T: 2.0	2					
39	144 2436 150	Loader Panel Assy		1					
40	102 3048 000	Top Cover		1					
41	441 1709 006	Top Cover Damper		1					
50	204 9801 006	1p Pin Jack		2					
51	205 0711 091	15P TBG-S Connector	CB400, 401	2					
52	393 4095 007	E.L. Tube FIP10SM6	FL801	1					
53	499 0264 004	Remocen Sensor GP1U571	IC801	1					
54	213 1101 006	Power Switch	SW1900	1					
55	204 8322 007	Headphone Jack	PJ301	1					
56	211 0544 111	Variable Resistor 20kohm	VR300	1					
57	204 8406 017	1P Pin Jack	JK403,404	2					
58	269 0098 006	Optical Connector (GP1F32T)	Out U305	1					
59	269 0097 007	Optical connector (GP1F32R)	In U304	1					
60	009 0090 033	35P FFC Cable	L=145	1					
61	204 8178 028	1P Pin Jack	JK301,302	2					

PACKING & ACCESSORIES (not Included EXPLODED VIEW)

Ref. No.	Part No	Part Name	Remarks	Qty
151	505 0131 076	Cabinet Cover		1
152	504 0092 060	Styrene Paper	For AC Cord	1
153	503 9275 102	Cushion		2
154	501 1860 056	Carton Case		1
155	GEN 3032 -3	Envelop Sub. Assy		1s
155-1	505 0036 030	Poly Cover		(1)
155-2	511 2721 007	Operating Instructions (3)		(1)
155-3	511 2722 006	Operating Instructions		(1)
155-4	204 8121 004	: 2P Pin Cord		(1)
155-5	399 0263 006	Remote Control Unit	RC-253	(1)
155-6	202 0644 002	AC Plug Adaptor		(1)
155-7	205 2130 000	AC Cord W/Con & Plug		(1)
155-8	511 2773 000	Notice Sheet		(1)
156	513 9111 001	Color Label (Gold)		2

PARTS LIST OF EXPLODED VIEW (DCD-S10 Europe, U.S.A. & Canada Models)

Ref. No.	Part No	Part Name	Remarks	Q'ty	Ref. No.	Part No	Part Name	Remarks	Q'ty
1	1U-2796 A	Audio P.W.B. Ass'y		1s	54	212 1101 006	Power Switch (T)-5	SW200	1
1-1	—	Display Unit		(1)	55	204 8322 007	Headphone Jack	PJ301	1
1-2	—	Audio Unit		(1)	56	211 0544 111	Variable Resistor 20kohm	VR300	1
1-3	—	Head Phone Unit		(1)	57	—	—	—	1
1-4	—	Power Switch Unit		(1)	58	269 0098 006	Optical Connector (GP1F32T)	Out U305	1
1-5	—	Balance Out Unit		(1)	59	269 0097 007	Optical connector (GP1F32R)	In U304	1
2	1U-2798	Digital Servo P.W.B. Ass'y	Europe model	1s	60	009 0090 033	35P FFC Cable	L-145	1
	1U-2798 D	Digital Servo P.W.B. Ass'y	U.S.A. & Canada models	1s	61	204 8178 028	1P Pin Jack	JK301,302	2
2-1	—	Servo Unit		(1)	62	1U-2836 A	Servo Amp. P.W.B. Ass'y		1s
2-2	—	Power Supply Unit		(1)	63	214 0127 003	Relay (RY-12W)	RL301	1
3	105 1150 128	Rear Panel		1	64	513 1381 004	Manufac. Date Label	U.S.A. & Canada models only	1
4	105 1152 100	Inside Bottom		1	65	513 0772 009	UL Label	U.S.A. & Canada models only	1
5	105 1151 208	Bottom Cover		1	66	LL-6442 8	CSA Label	U.S.A. & Canada models only	1
6	104 9044 000	Font Ass'y		4	67	513 2337 015	Rating Sheet	Europe model	1
7	412 2843 400	Mecha Bracket Ass'y		1		513 2301 038	Rating Sheet	U.S.A. & Canada models only	1
8	—	—		—	68	513 1220 000	Caution Label		1
9	—	—		—	69	412 3956 008	Trans Bracket		1
10	—	—		—	70	122 0196 007	Sheet (Double Circle)		2
11	—	—		—	71	513 2141 007	Caution Label	U.S.A. & Canada models only	1
12	206 2089 106	AC Cord	Europe model	1	72	513 2055 002	Laser Caution	Europe model only	1
12	206 2110 004	AC Cord	U.S.A. & Canada models	1	73	513 0985 003	Inst. Label	Europe model only	1
13	445 0066 008	Cord Bush		1	74	412 3989 004	SEMKO Bracket	Europe model only	1
14	203 8628 006	Power Trans	U.S.A. & Canada models	1	90	473 7002 021	Screw 3x8 CBTS(S)-B	Black	57
14	253 8151 816	Power Trans	Europe model	1	91	473 7508 017	Screw 3x10 CBTS(P)-B	Black	17
16	411 1317 219	Chests		1	92	473 7007 013	Screw 4x10 CBTS(S)-B	Black	4
17	411 1318 014	Front Angle		1	93	471 3304 015	Screw 3x8 CBS-Z		4
18	—	—		—	94	473 7005 073	Screw 3x5 CBTS(S)-Z		4
19	—	—		—	95	445 0048 016	Cord Holder	L=50	2
20	—	—		—	96	—	—		—
21	205 0428 009	3P Cannon Connector	CN802,903	2	97	471 9043 008	Special Screw		8
22	—	—		—	PACKING & ACCESSORIES (not included EXPLODED VIEW)				
23	—	—		—	151	505 0131 078	Cabinet Cover		1
24	337 0041 000	CD Mecha Unit (FG-77)		1	152	504 0092 060	Styrene Paper	For AC Cord	1
25	412 2866 108	Mecha Cover		1	153	503 9275 102	Cushion		2
26	—	—		—	154	501 1860 027	Carton Case		1
27	461 0889 015	Cushion (T-15)		1	155	515 0690 006	DEL Warranty Home	U.S.A., Canada only	1
28	144 2428 100	Front Panel Ass'y		1	156	517 0102 040	UPC Label	U.S.A., Canada only	1
29	146 1542 216	FL Holder		1	157	GEN 3032	Envelope Sub. Ass'y	Europe model	1s
30	143 0919 207	Window		1		GEN 3032-6	Envelope Sub. Ass'y	U.S.A. & Canada models	1s
31	144 2450 000	Display Frame		1	157-1	505 0038 030	Poly Cover		1
32	113 1708 102	Input Button Ass'y		1	157-2	511 2718 007	Operating Instructions (5)	Europe, U.K. only	1
33	113 1709 004	OP/CL Button Ass'y		1	157-3	511 2721 007	Operating Instructions (3)		1
34	113 1710 006	Function Button Ass'y		1	157-4	204 8121 004	:2P Pin Cord		1
35	113 9303 101	Power Button Ass'y		1	157-5	399 0283 006	Remote Control Unit	RC-253	1
36	412 3935 003	Headphone Bracket		1	158	513 9111 001	Color Label (Gold)		2
37	113 1713 100	Headphone Button Ass'y		1	159	513 8253 025	Approval Mark	Europe model only	1
38	129 0140 151	Rubber Sheet	T: 2.0	2					
39	144 2436 150	Loader Panel Ass'y		1					
40	102 9048 000	Top Cover		1					
41	441 1709 006	Top Cover Damper		1					
50	204 8295 009	4P PCA Pin Jack	JK405	1					
51	205 0711 091	15P TBG-S Connector	CB400,401	2					
52	393 4095 007	F.L. Tube FIP10SM6	FL601	1					
53	499 0264 004	Remocon Sensor GP1U571	IC801	1					

NOTE: (Gold) in the Remarks column refers to models with Gold front panels.

EXPLODED VIEW (DCD-S10 Asia Model)

1 2 3 4 5 6 7 8

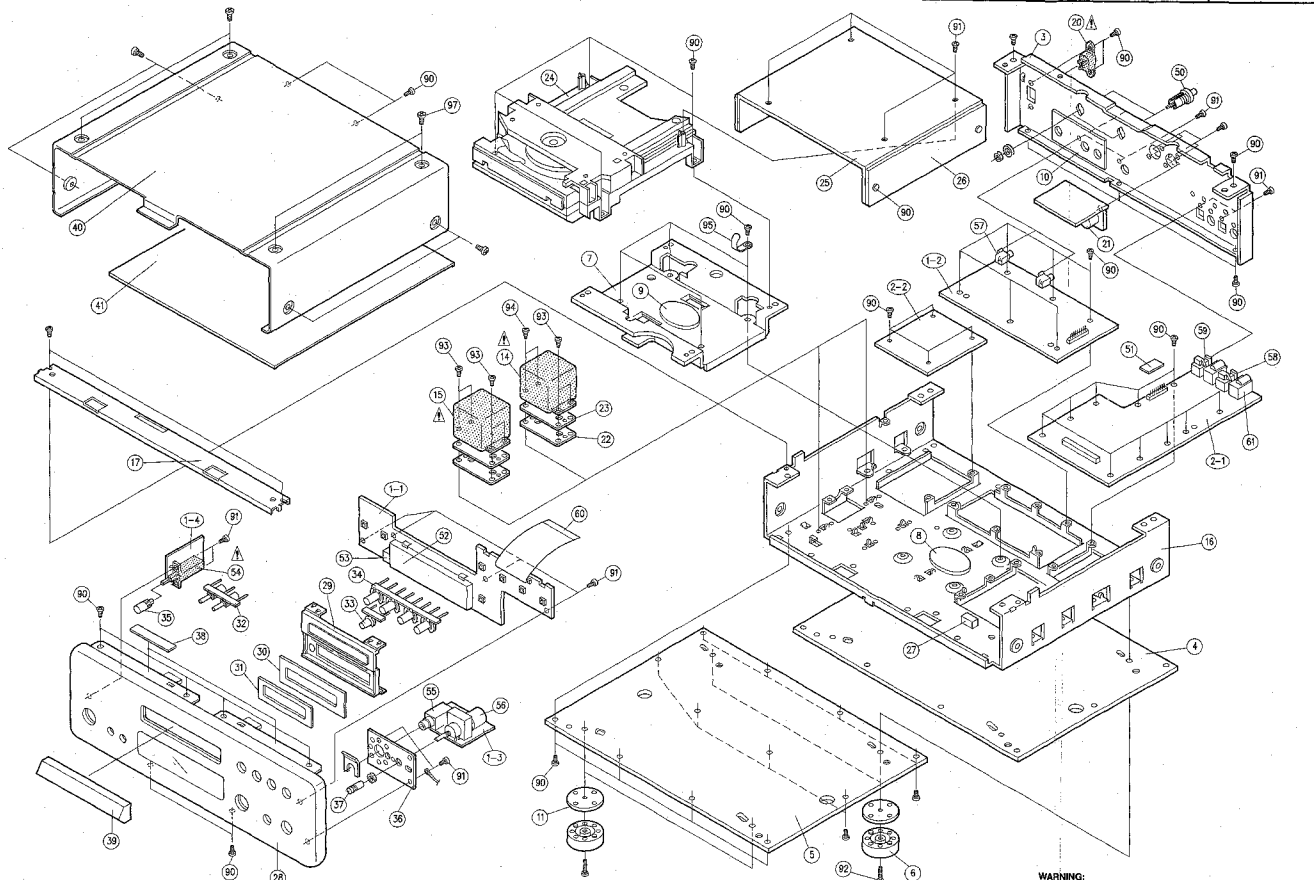

A
B
C
D
E

WARNING:
Parts marked with this symbol  have critical characteristics.
Use ONLY replacement parts recommended by the manufacturer.

EXPLODED VIEW (DCD-3000 Europe, U.S.A. and Canada and Multi-Voltage Models)

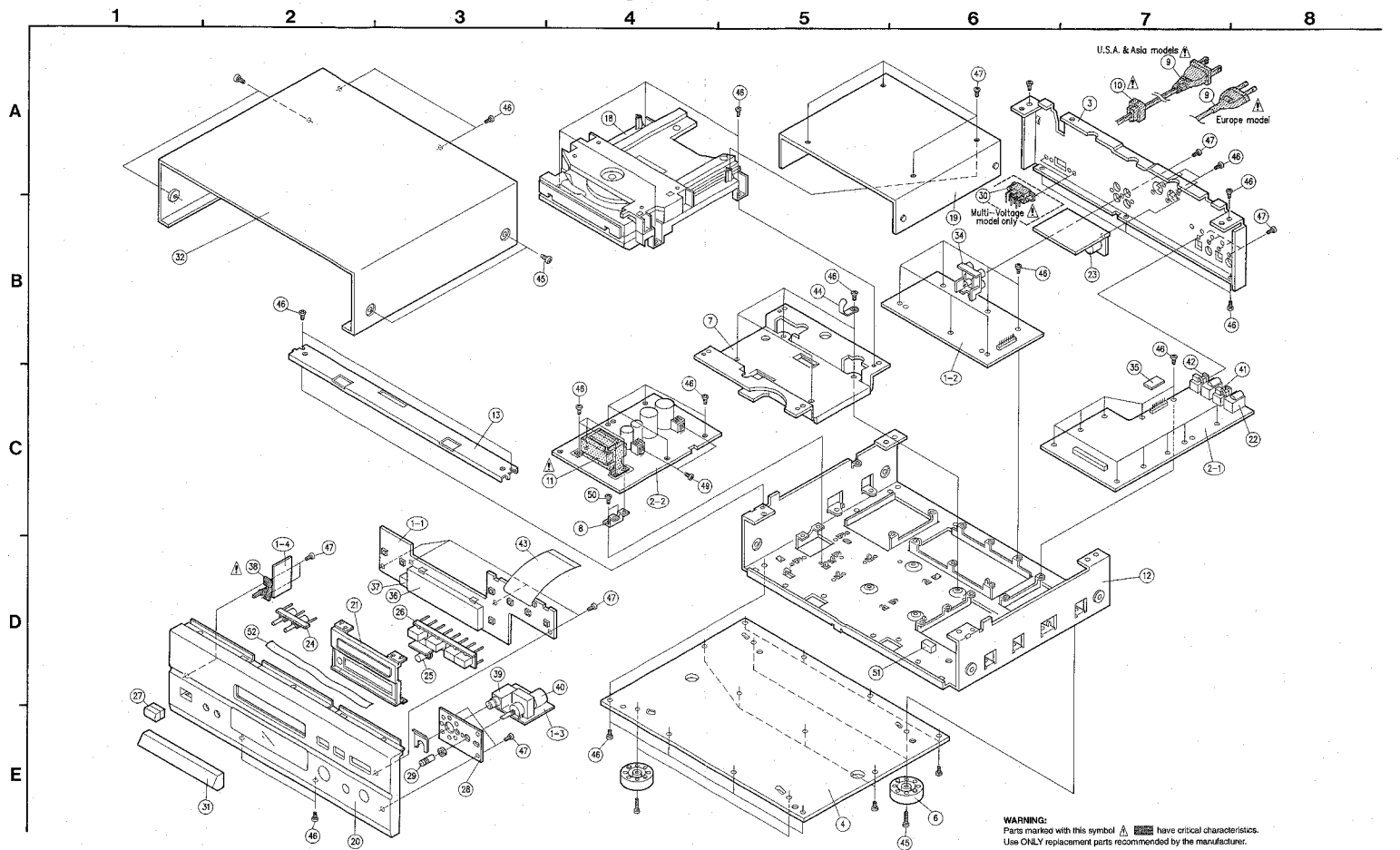

WARNING:
Parts marked with this symbol  have critical characteristics.
Use ONLY replacement parts recommended by the manufacturer.

PARTS LIST OF EXPLODED VIEW

(Model DCD-3000 EUROPE, U.S.A. & Canada, and Multi-Voltage Models)

Ref. No.	Part No	Part Name	Remarks	Q'ty	Ref. No.	Part No	Part Name	Remarks	Q'ty
1	1U-2796	Audio P.W.B. Assy		1s	45	473 7007 000	Screw 4-8 CBTS (S)-B	Black	8
1-1	—	Display Unit		(1)	46	473 7002 021	Screw 3-8 CBTS (S)-B	Black	50
1-2	—	Audio Unit		(1)	47	473 7508 017	Screw 3-10 CBTS (P)-B	Black	17
1-3	—	Head Phone Unit		(1)	49	471 3304 015	Screw 3-8 CBS-Z		4
1-4	—	Power Switch Unit		(1)	50	473 7005 073	Screw 3-6 CBTS (S)-Z		4
1-5	—	Balance Out Unit	Multi-Voltage model	(1)	51	481 0889 002	Cushion (7-10)		1
2	1U-2798	Digital Servo P.W.B. Assy	Europe model	1s	52	122 0167 113	Top Cover Spacer		1
2-1	1U-2798D	Digital Servo P.W.B. Assy	U.S.A. & Canada models	1s	* 53	110 2538 A	Servo Amp. P.W.B. Assy		1s
2-2	1U-2798S	Digital Servo P.W.B. Assy	Multi-Voltage model	1s	* 54	214 0127 003	Relay (RY-12W)	RL301	1
3	105 1150 131	Rear Panel	Multi-Voltage model	1	* 55	125 0077 002	Spacer	10x160	1
3	105 1150 102	Rear Panel	Europe, U.S.A. and Canada models	1	* 56	129 0222 008	Rubber Spacer	T4	1
4	105 1152 100	Inside Bottom		1	* 57	122 0196 007	Sheet		2
6	104 0180 112	Foot Assy		4	* 100	513 2065 002	Laser Caution Label	Europe, U.S.A. and Canada models	1
7	412 2812 402	Mecha Fix Bracket		1	* 101	513 1220 000	Caution Label		1
8	412 3868 008	Trana Bracket		1	* 102	513 2301 041	Ratfing Sheet	U.S.A. model	1
9	209 8099 106	AC Cord	Multi-Voltage model	1		513 2337 002	Ratfing Sheet	Europe model	1
9	209 2110 004	AC Cord	U.S.A. & Canada models	1		513 2374 007	Ratfing Sheet	Multi-Voltage model	1
9	209 8099 106	AC Cord	Europe model	1	* 103	513 2141 007	Caution Label	U.S.A. & Canada models	1
10	445 3955 085	Cart Sheet		1	* 104	513 0772 006	UL Label	U.S.A. & Canada models	1
11	263 9167 016	Power Trans	Europe model	1	* 105	LL-6442 6	CSA Label	U.S.A. & Canada models	1
11	153 2682 006	Power Trans	U.S.A. & Canada models	1	* 106	513 1381 004	Manufac. Date Label	U.S.A. & Canada models	1
11	233 8152 019	Power Trans	Multi-Voltage model	1	* 107	513 1286 002	Fuse Caution Label	U.S.A. & Canada models	1
12	411 1317 206	Chassis		1	* 108	513 0985 003	Inst. Label	Europe, Multi-Voltage models	1
13	411 1318 001	Front Angle		1	* 109	513 8253 025	Approval Mark	Europe model	1
18	337 0039 009	CD Mecha Unit (FG-76)		1	* 110	515 8030 040	Presel Label 230V	Multi-Voltage model	1
19	412 3866 111	Mecha Cover		1					
20	144 2426 102	Front Panel Assy		1					
21	146 1542 203	FL Holder		1					
22	204 8178 026	1p Pin Jack	JK301,302	2					
23	205 0428 008	3P Cannon Connector	CN602,603	2					
24	113 1705 008	Input Button Assy		1	PACKING & ACCESSORIES (not included EXPLODED VIEW)				
25	113 1705 024	OP/CL Button Assy		1	151	535 0151 076	Cabinet Cover		1
26	113 1706 007	Function Button Assy		1	152	534 0082 060	Styrene Paper	For AC Cord	1
27	113 1705 000	Power Button Assy		1	153	503 9275 102	Question		2
28	412 3935 003	Headphone Bracket		1	154	501 1860 001	Carton Case		1
28	113 1713 113	Headphone Button Assy		1	155	515 0690 006	DEL Warranty Home	U.S.A.,Canada only	1
29	510 1116 002	Relay/Solenoid	SV929	1	156	517 0102 037	UPC Label	U.S.A.,Canada only	1
31	144 2436 105	Loader Panel Assy		1	157	GEN 3032 -	Envelope Sub. Assy	Europe model	1s
32	102 0559 009	Top Cover		1	GEN 3032 -2	Envelope Sub. Assy	U.S.A. & Canada models	1s	
34	204 8265 009	4P RCA Pin Jack	JK405	1	GEN 3032 -3	Envelope Sub. Assy	Multi-Voltage model	1s	
35	205 0711 091	15P TBG-S Connector	CB400,401	2	*157-1	505 0038 030	Poly Cover		(1)
36	393 4085 007	FL Tube FIP105M6	FL801	1	157-2	511 2719 007	Operating Instructions(5)	Europe,U.K. only	(1)
37	499 0284 004	Remocon Sensor GP1U571	IC801	1	157-3	511 2721 007	Operating Instructions(3)		(1)
38	212 1101 006	Power Switch	SV900	1	157-4	511 2722 006	Operating Instructions	Multi-Voltage only	(1)
39	204 8322 007	Headphone Jack		1	158-5	204 8121 004	:2P Pin Cord		(1)
40	211 0544 111	Variable Resistor 20kohm		1	158-6	989 0280 009	:Remote Control Unit	RC-252	(1)
41	269 0698 006	Optical Connector (GP1F32T)	Out U305	1	157-7	-	Dry Battery	R06P/AA/UM-3	(2)
42	269 0697 007	Optical Connector (GP1F32P)	In U304	1	201 3901	206 0002 004	AC Plug Adaptor	1AEP-K030EP-1506E	1
43	009 0690 033	3SP PFC Cable	L=145	1					
44	445 0048 016	Cord Holder	L=50	2					

NOTE: (304) in the Remarks column refers to models with Gold front panel.

PARTS LIST OF FG-76/77 MECHANISM UNIT

FG-76 Part No. 337 0039 009 for DCD-3000

FG-77 Part No. 338 0041 000 for DCD-S10

Ref. No.	Part No.	Part Name	Remarks	Q'ty
2	9KA 90H0 06	FS Fixing Screw		1
3	9KA 90H0 05	Feed Shaft		1
7	9KA 90G0 17	Drive Gear (A)		1
8	9KA 90G0 18	Drive Gear (B)		1
9	909 0151 009	Laser P.U		1
12	9KS 01W1 47	Last Switch		1
13	9KA 85P0 09	Motor P.W.B.		1
15	009 0051 001	12P FFC Cable		1
16	443 1053 006	FFC Bush		1
17	9KA 82G2 53	SSB-PH Connector Base		1
18	9KM 2050 04	Screw 2x4 (Sems)		2
19	411 1319 301	Mecha. Chassis		1
20	9KA 85G0 20	Mecha. Frame (FG70)		1
21	431 0363 219	Loader 76	model DCD-3000	1
22	431 0363 205	Loader 77	model DCD-S10	1
22	412 3943 202	Clamper Holder		1
23	9KA 4G00 5A	UD Plate Gear (FG70)		1
24	421 0710 203	Clamper (F)		1
25	9KA 85G0 07	Ratay Gear (A)		1
26	9KA 4G00 6A	Ratay Gear (B)		1
27	9KA 85G0 09	Ratay Gear (C)		1
28	9KA 85G0 10	Gear Bolt (F)		1
29	9KA 85G0 30	Damper (FG40)		4
30	9KA 85P0 07	Clamper Plate (F)		1
31	9KA 85H0 01	Screw (F)		4
32	9KA 85P0 05	Motor P.W.B. (FG-70)		1
34	9KA 82G0 57	Magnet		1
35	9KA 92H0 01	Special Screw 3x8		2
36	9KB 30B0 08	Screw 3x8 Balind		6
37	9KM 26BK 04	Screw 2.6x4 Balind		2
39	9KA 82G3 08	SSB-PH (Red)		1
40	9KA 85G0 27	CNVZ (FG70)		1
41	9KS 01W1 48	OP/CL Switche (SSS-12)		1
42	9KA 85S0 04	Spring (D)		2
43	9KA 85S0 02	Spring (B)		1
44	9KA 85S0 03	Spring (C)		1
45	9KA 85G0 33	Gear Guide		1
46	424 0246 109	Loader Gear		1
47	412 3944 308	Holder		1
48	431 0384 001	Slide Shaft		1
50	9KH 30PK 08	Screw 3x8 CPS		1
52	9KB 30PK 10	Screw 3x10 Balind		1
60	9KA 85A0 14	Spindle Motor Assy		1s
81	9KA 85A0 08	Feed Motor Assy		1s
82	9KA 85A0 05	Loading Motor Assy		1s

EXPLODED VIEW OF FG-76/77 MECHANISM UNIT

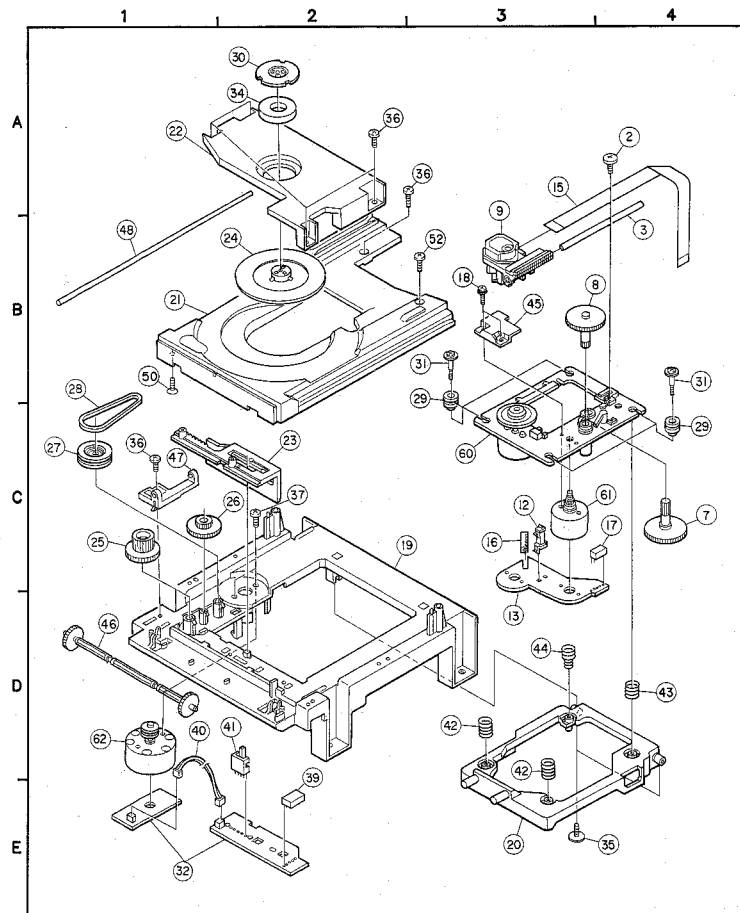

P.W. BOARD UNIT ASS'Y

1 2 3 4 5 6 7 8

1U-2796 AUDIO UNIT

1U-2796 DCD-3000 Europe, U.S.A. & Canada and Multi-Voltage Models

1U-2796A DCD-S10 Europe, U.S.A. & Canada Models

1U-2796M DCD-S10 Asia Model

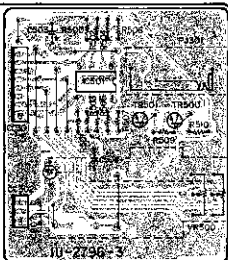
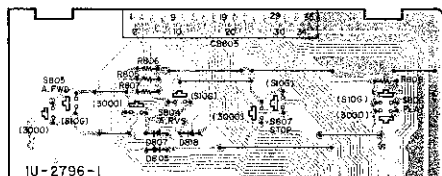
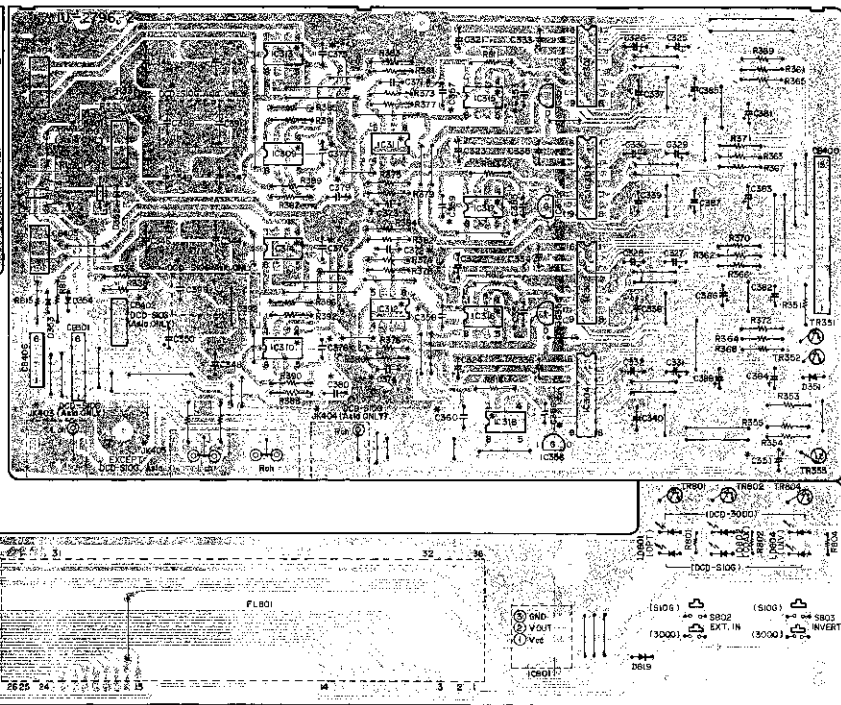
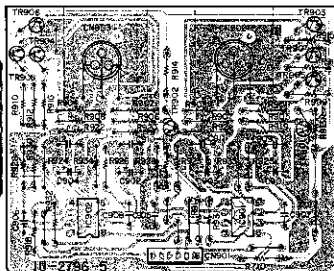
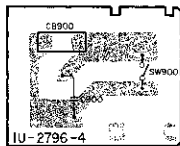

#	Unit No.	IC26-010	IC31-012	IC31-014	IC31-018	CS1	CS3-356	CS7-360	CS71-072	CS71-074	CS75-366	CS8-396	CS9-092	CS03	CS04	JK103-024	JK105	CB101-102	R355-999
DCD-3000	Europe	1U-2796	µPC4370C	µPC4570C	µPC4570C	220V/25V (SME)	270V/100V (SME)	100V/100V Film	180V/100V Film	180V/100V Film	5.0V/1.00V Film	—	—	4.7V/10V (SME)	220V/10V (SME)	—	4P Pin Jack	—	Carbon Film
	U.S.A. & Canada	1U-2796	µPC4370C	µPC4570C	µPC4570C	220V/25V (SME)	270V/100V (SME)	100V/100V Film	180V/100V Film	180V/100V Film	5.0V/1.00V Film	—	—	4.7V/10V (SME)	220V/10V (SME)	—	4P Pin Jack	—	Carbon Film
	Multi-Voltage	1U-2796	µPC4570C	µPC4570C	µPC4570C	220V/25V (SME)	270V/100V Film	100V/100V Film	180V/100V Film	180V/100V Film	5.0V/1.00V Film	—	—	4.7V/10V (SME)	220V/10V (SME)	—	4P Pin Jack	—	Carbon Film
DCD-S10	Europe	1U-2796A	µPC4370C	µPC4570C	µPC4570C	220V/25V (SME)	270V/100V (SME)	100V/100V Film	180V/100V Film	180V/100V Film	5.0V/1.00V Film	—	1.0V/5V	4.7V/10V (SME)	220V/10V (SME)	—	4P Pin Jack	—	Carbon Film
	U.S.A. & Canada	1U-2796A	µPC4370C	µPC4570C	µPC4570C	220V/25V (SME)	270V/100V (SME)	100V/100V Film	180V/100V Film	180V/100V Film	5.0V/1.00V Film	—	1.0V/5V	4.7V/10V (SME)	220V/10V (SME)	—	4P Pin Jack	—	Carbon Film
	Asia Model	1U-2796M	OP07G09	SM87129	NE5219	220V/25V (SME)	270V/100V (SME)	100V/100V Polymer	180V/100V Polymer	180V/100V Polymer	5.0V/1.00V Polymer	—	1.0V/5V	4.7V/10V (SME)	220V/10V (SME)	—	4P Pin Jack	—	Carbon Film Con Base 1 (TR355)

A
B
C
D
E

1 2 3 4 5 6 7 8

1U-2797 DIGITAL SERVO UNIT (DCD-S10 Asia Model only)

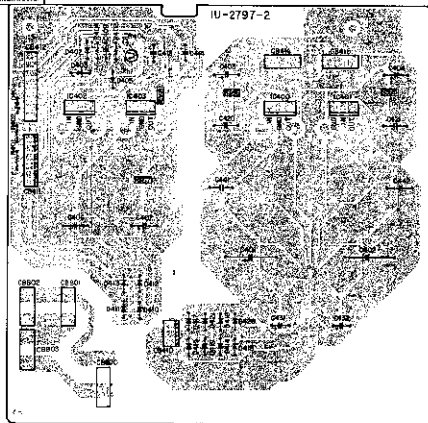
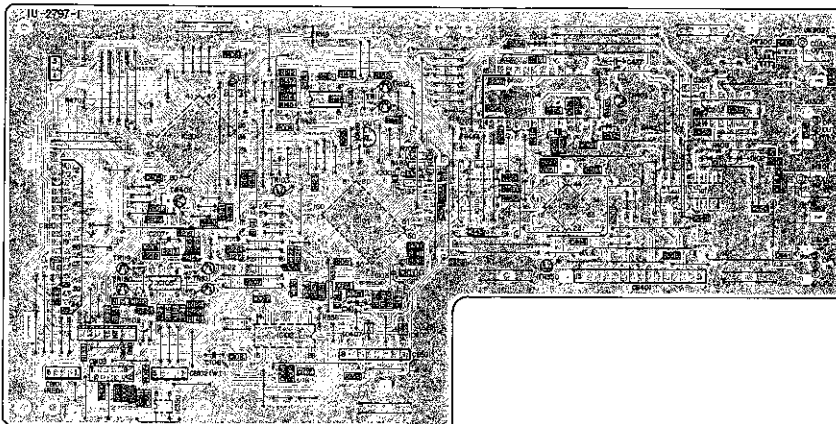

A

B

C

D

E

1 2 3 4 5 6 7 8

1U-2798 DIGITAL SERVO UNIT

1U-2798 DCD-3000, DCD-S10 Europe Models
 1U-2798D DCD-3000, DCD-S10 U.S.A. & Canada Models
 1U-2798B DCD-3000 Multi-Voltage Model

	Unit No.	SW982
DCD-S10	Europe	1U-2798
	U.S.A. & Canada	1U-2798D
DCD-3000	Europe	1U-2798
	U.S.A. & Canada	1U-2798D
	Multi-voltage	1U-2798B

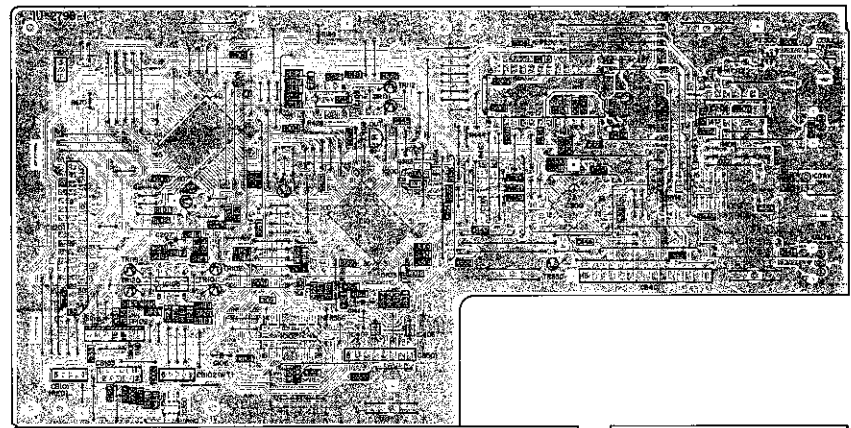

1U-2836A SERVO AMP UNIT

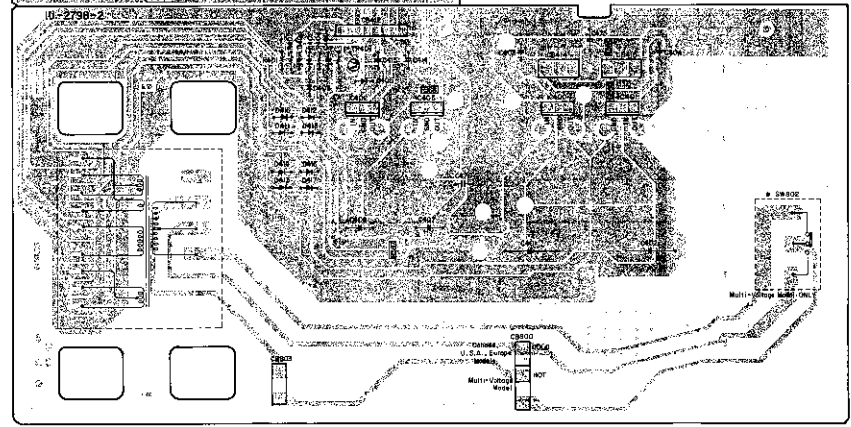
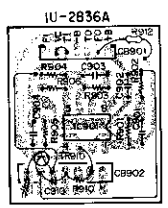

A
B
C
D
E

WIRING DIAGRAM

1 2 3 4 5 6 7 8

A

		UNIT NO.		
		AUDIO/DISPLAY UNIT	DIGITAL/SERVO UNIT	SERVO AMP UNIT
DCD-S10	Asia	1U-2796M	1U-2797M	1U-2836A
	Europe	1U-2796A	1U-2798	1U-2836A
	U.S.A. & Canada	1U-2796A	1U-2798D	1U-2836A
DCD-3000	Multi-Voltage	1U-2796	1U-2798B	1U-2836A
	Europe	1U-2796	1U-2798	1U-2836A
	U.S.A. & Canada	1U-2796	1U-2798D	1U-2836A

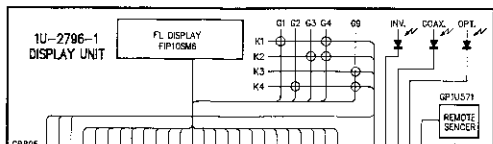

B

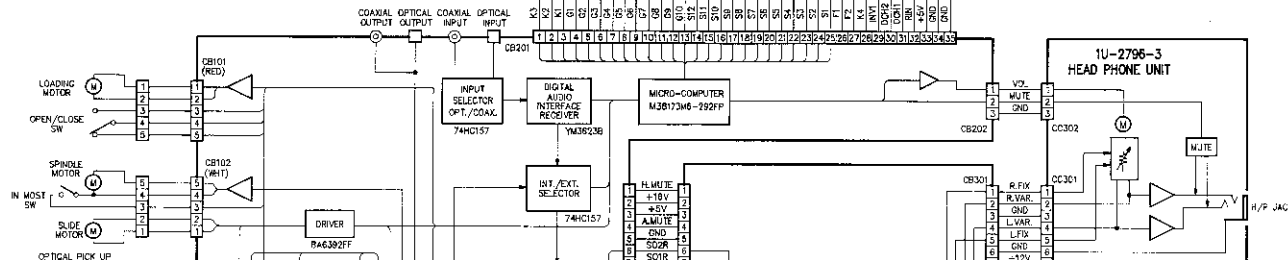

C

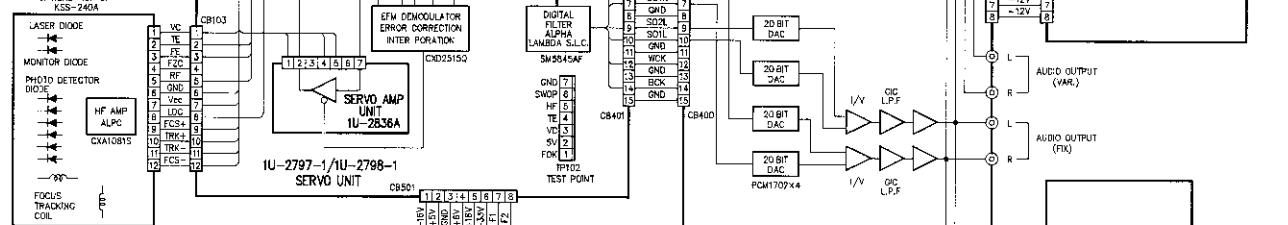

D

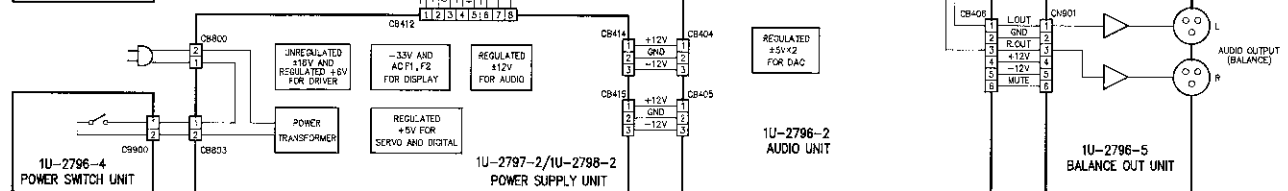

E

4 5 6 7 8 9 10 11

FIG. 2769-1 (28X)

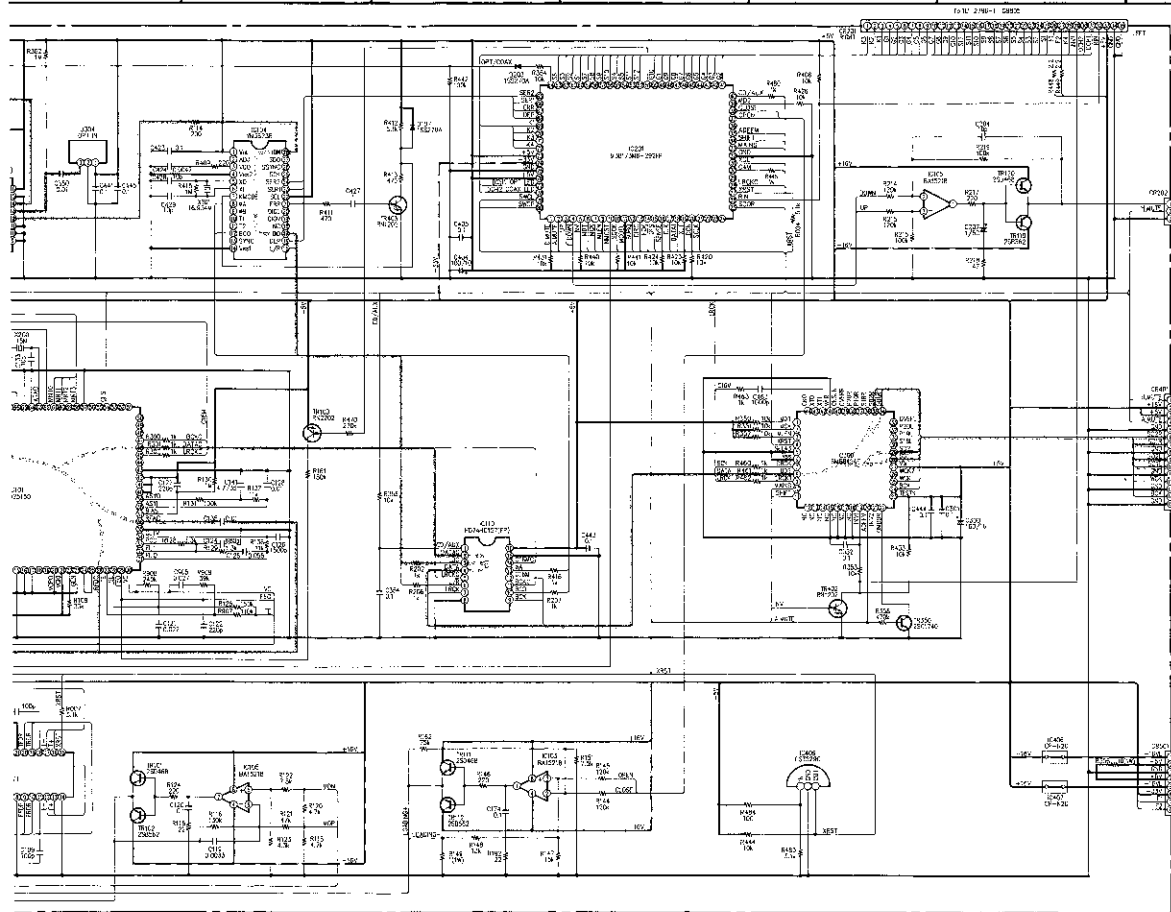

NOTES
 ALL RESISTANCE VALUES IN OHM = 1,000 OHM,
 M = 1,000,000 OHM
 ALL CAPACITANCE VALUES IN MICRO FARAD,
 P = PICO-MICRO FARAD
 EACH VOLTAGE AND CURRENT ARE MEASURED AT
 NO SIGNAL INPUT CONDITION.
 CIRCUIT AND PARTS ARE SUBJECT TO CHANGE
 WITHOUT PRIOR NOTICE.

WARNING:
 Parts marked with this symbol  have critical characteristics.
 Use ONLY replacement parts recommended by the manufacturer.

CAUTION:
 Before returning the unit to the customer, make sure you make other (1) a leakage current check: 0.50 uA line to chassis resistance check. If the leakage current exceeds 0.5 milliamperes, or if the resistance from chassis to either side of the power cord is less than 240 kohms, the unit is defective.

WARNING:
 DO NOT return the unit to the customer until the problem is located and corrected.

A
 B
 C
 D
 E

SCHEMATIC DIAGRAM-2/3

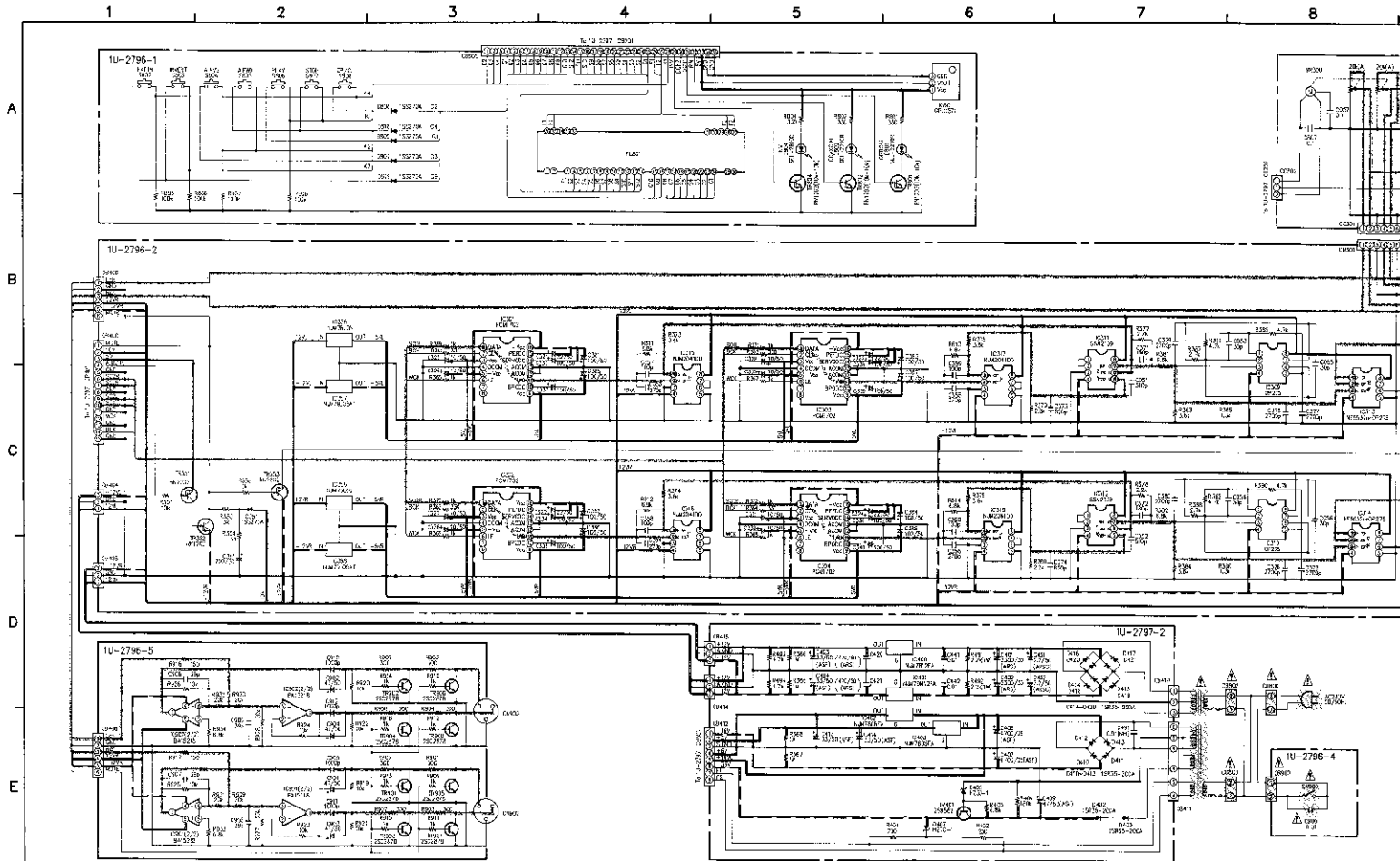

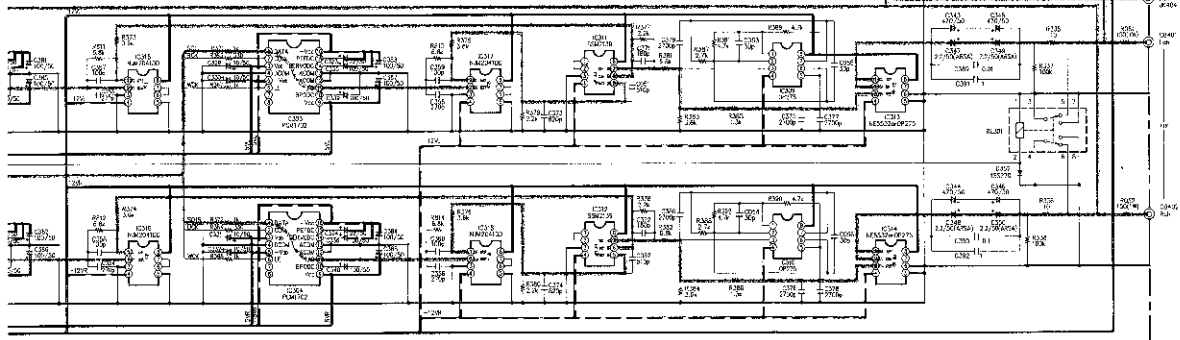
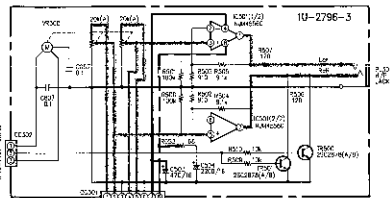
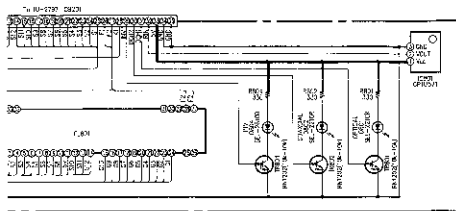



NOTES
ALL RESISTANCE VALUES IN OHM \times 1,000 OHM,
MAY 100,000 OHM

ALL CAPACITANCE VALUES IN MICRO-FARAD.
P=MICRO-MICRO-FARAD

EACH VOLTAGE AND CURRENT ARE MEASURED AT
NO SIGNAL INPUT CONDITION.

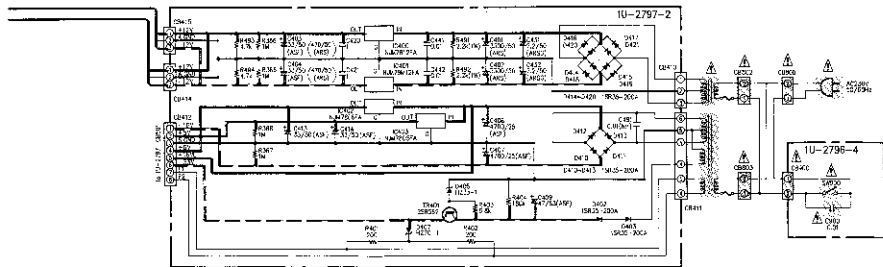
CIRCUIT AND PARTS ARE SUBJECT TO CHANGE
WITHOUT PRIOR NOTICE



WARNING:
Parts marked with this symbol  have critical characteristics. Use ONLY replacement parts recommended by the manufacturer.

CAUTION:
Before returning the unit to the customer, make sure you make either (1) a leakage current check or (2) a line to chassis resistance check. If the leakage current exceeds 0.5 millamps, or if the resistance from chassis to either side of the power cord is less than 250 kilohms, the unit is defective.

WARNING:
DO NOT return the unit to the customer until the problem is located and corrected.

— 10 LINE
- - - 5 LINE
- - - - 500M. LINE

4 5 6 7 8 9 10 11

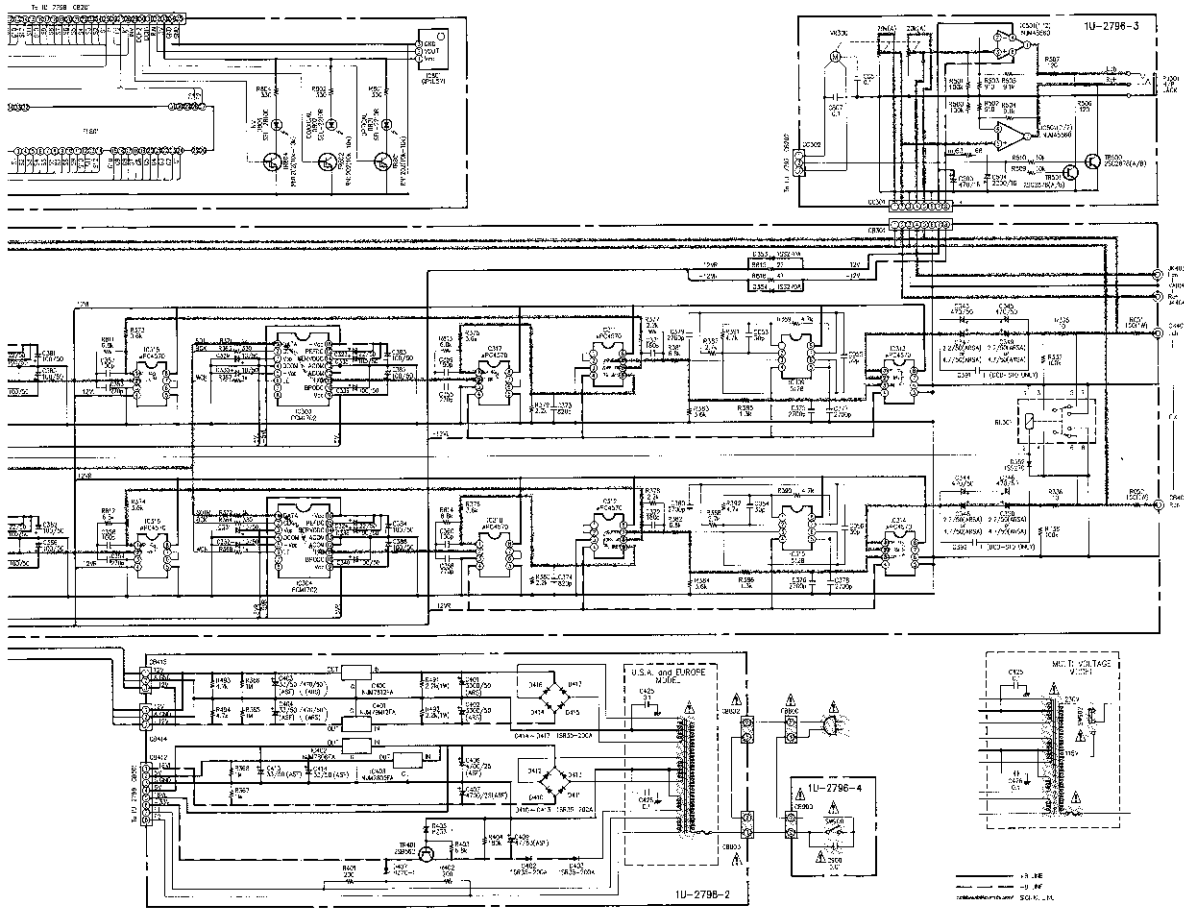

NOTES
 ALL RESIS (ANCE VALUES IN OHM, K-1,000 OHM, M-1,000,000 OHM)
 ALL CAPACITANCE VALUES IN MICRO FARAD
 P=MICRO-MICRO FARAD
 EACH VOLTAGE AND CURRENT ARE MEASURED AT NO SIGNAL INPUT CONDITION.
 CIRCUIT AND PARTS ARE SUBJECT TO CHANGE WITHOUT PRIOR NOTICE

WARNING:
 Parts marked with this symbol  have critical characteristics. Use ONLY replacement parts recommended by the manufacturer.

CAUTION:
 Before returning the unit to the customer, make sure you make either (1) a leakage current check or (2) a line to chassis resistance check. If the leakage current exceeds 0.5 mAamps, or if the response from chassis to either side of the power cord is less than 240 kilohms, the unit is defective.

WARNING:
 DO NOT return the unit to the customer until the problem is located and corrected.

A
 B
 C
 D
 E