

DENON

Hi-Fi Component



V05702

SERVICE MANUAL

MODEL DCM-420

MODEL DCM-320

STEREO CD PLAYER

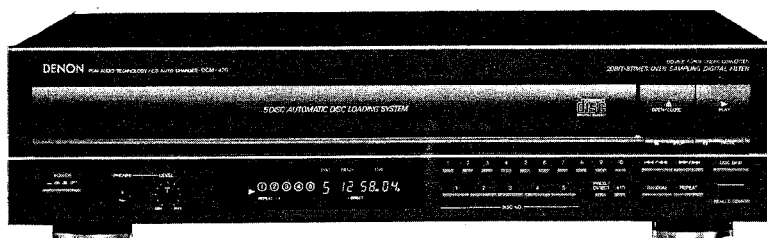

(Photo: DCM-420)

— TABLE OF CONTENTS —

OPERATING INSTRUCTIONS (DCM-420)	2~7
OPERATING INSTRUCTIONS (DCM-320)	8~14
SPECIFICATIONS	15
NOTE FOR HANDLING OF LASER PICK-UP	16, 17
DISASSEMBLY	18
ADJUSTMENT	19~22
HEAT RUN MODE FUNCTION	23
IC TERMINAL FUNCTION	24~27
NOTE ON PARTS LIST	28
PARTS LIST OF P.W.BOARD	29~30
PARTS LIST OF MECHANISM UNIT	31
EXPLODED VIEW OF MECHANISM UNIT	31
EXPLODED VIEW	32
PARTS LIST OF EXPLODED VIEW	33
PARTS LIST OF PACKING & ACCESSORIES	33
P.W.BOARD	34, 35
WIRING DIAGRAM	36
SEMICONDUCTORS	37, 38
SCHEMATIC DIAGRAM	39

NIPPON COLUMBIA CO., LTD.

DENON

STEREO CD PLAYER DCM-420 OPERATING INSTRUCTIONS

Thank you for purchasing the DENON compact disc player. Read the Operating Instructions thoroughly, and operate this player properly.

— TABLE OF CONTENTS —

FEATURES	3
CAUTIONS DURING USE	3
NAMES OF PARTS AND THEIR FUNCTIONS	4-6
OPENING AND CLOSING THE DRAWER AND LOADING A DISC	6
CONNECTIONS	7
NORMAL PLAY	7
OTHER PLAY METHODS	8-11
INSTALLATION PRECAUTIONS	12
PLAY USING THE REMOTE CONTROL UNIT	12, 13

In addition to the CD Player unit, please check to make sure the following items are included in the packing box.

- (1) Operating Instructions 1
- (2) Warranty Card 1
- (3) Connection Cards 1
- (4) Remote Control Unit RC-238 1
- (5) R6 (AA size) Dry Batteries 2

IMPORTANT (CANADIAN MODEL ONLY)

This digital apparatus does not exceed the Class B limits for radio noise emissions from digital apparatus set out in the Radio Interference Regulations of the Canadian Department of Communication.

CLASS 1 LASER PRODUCT
LUOKAN 1 LASERLAITE
KLASS 1 LASERAPPARAT

ADVARSEL: USYNLIG LASERSTRÅLING VED ÅBNING
UNDGA UDSÆTTELSE FOR STRÅLING.

VAROITUS: LAITTEEN KÄYTTÄMINEN MUULLA KUIN TÄSSÄ
KÄYTTÖOHJEESSA MAINITULLA TAVALLA SAATTAA
ALISTATA KÄYTTÄJÄN TURVALLISUUSLUOKAN 1
YLIITÄVÄLLE NÄKYMÄTTÖMÄLLE LASERISÄTEILYLLE.

VARNING: OM APPARATEN ANVÄNDS PÅ ANNAT SÄTT ÄN I DENNA
BRUKSANVISNING SPECIFICERATS KAN ANVÄNDAREN
UTSÄTTAS FÖR OSYNLIG LASERSTRÅLING, SOM
ÖVERSKRIDER GRÄNSEN FÖR LASERKLASS 1.

CAUTIONS DURING USE

- This compact disc player is capable of playing discs which have the mark at right.
- During track selection, during search and when the player sustains a strong impact, the disc's rotational speed changes greatly, causing a small noise to be emitted. This is not a malfunction of the player.
- If the CD player is operated while an FM or AM broadcast is being received, there may be noise in the FM or AM reception. Please switch the power to the CD player off at such times.
- The DCM-420 has a broad dynamic range. Please exercise caution when turning up the volume on the amplifier in cases when the playback volume is low. If the volume is turned up too high, it could damage the speakers.
- Do not use any discs but exclusive audio discs with this CD player.

FEATURES

The DCM-420 is a 5 discs carousel type CD changer which includes an exclusive Denon Super Linear Converter which eliminates sound quality deterioration in the PCM audio system in order to reproduce the exact sound captured in the studio or at the live performance recorded on the compact disc. In addition to components rigorously selected for their high performance and excellent audio quality to recapture the original sound in full.

- (1) **Double Super Linear Converter**
DENON's unique method to prevent zero cross distortion, the major cause of reductions in sound quality in the PCM playback system, is used in both of the independent D/A converters for the left and right channels, providing sound fields with rich musical expression.
- (2) **High Performance Digital Filter**
8 times oversampling with noise sniping high precision digital filter has been adopted for the DCM-420. This helps the unit achieve outstanding linear phase characteristics.
- (3) **Newly developed carousel-type changer mechanism included**
This mechanism can house five discs, and while one disc is playing the remaining four discs can be changed. In addition, the carousel can be rotated either clockwise or counterclockwise, so searching between discs is fast.
- (4) **Disc level file function**
This function is for storing in the memory the desired variable output levels for different discs. The level for up to 100 discs can be stored, and the memory is backed up even when the power is turned off. This function is effective for playing different discs at different levels.
- (5) **Playback of 8 cm (3-inch) CDs**
8 cm (3-inch) CDs can be played.
- (6) **Digital Output (Coaxial)**
The data on the compact disc is output in digital form, so playback is possible with an external digital processor or D/A unit.

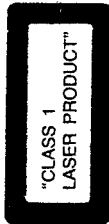

- Placing this player or its connection cords near a TV or other audio device could cause a humming sound to be emitted. If this occurs, relocate the player or reroute the connection cords.
- Be sure to remove the disc from the player before moving it. The disc could be damaged if left in the player while it is being moved.
- Do not place any object in the tray in the position where the disc is loaded, or open and close the tray with anything inside. Foreign objects in the tray could damage the play mechanism.
- Do not move the player from a cold place to a warm place suddenly. If the player is cold when brought into a warm room, condensation could form, preventing proper operation of the player. If condensation does form on the player when it is brought into a warm room, wait at least 30 minutes before use.

NAMES OF PARTS AND THEIR FUNCTIONS

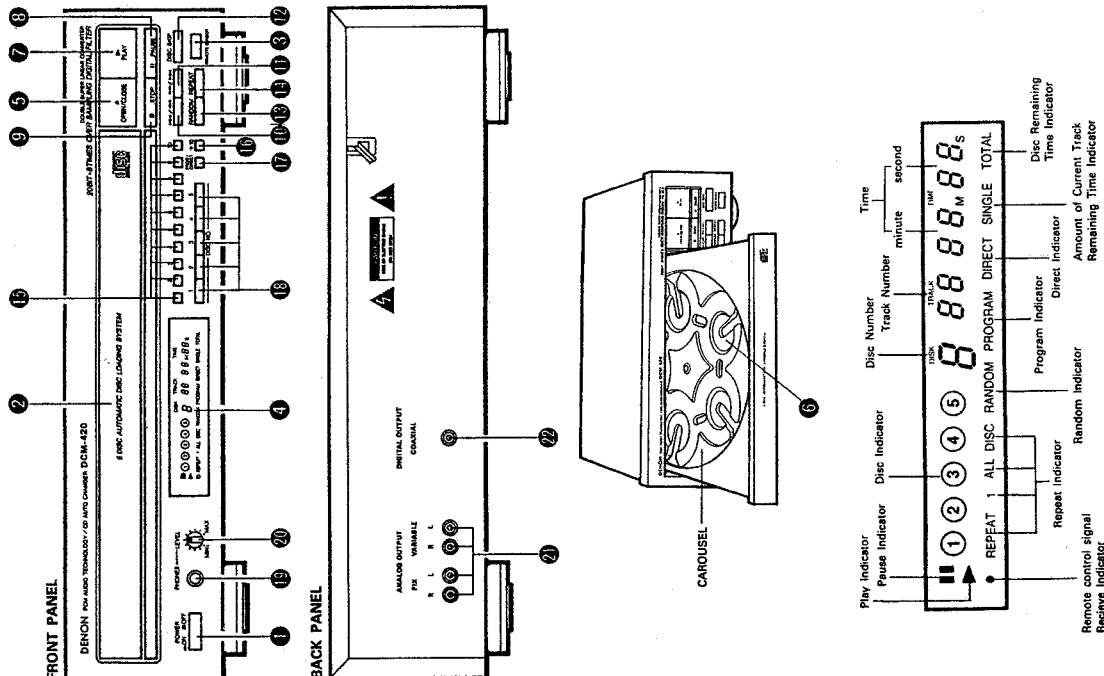

- 1 Power Switch (POWER)**
 - Press this button to switch on the power.
 - When the power is turned off, the unit is set to the standby mode.
 - If the power is turned off during playback or while the disc information is displayed on the time display, several seconds after the power is turned back on, the number of the disc appears on the disc number display, the total number of tracks on that disc is displayed on the track number display, and the total time is displayed on the time display, and approximately 1 second later playback starts.
- 2 Loading drawer**
 - Discs can be loaded and unloaded when this drawer is open. Do not force the drawer closed by hand.
- 3 Remote Control Receptor (REMOTE SENSOR)**
 - This receptor receives infrared signals from the wireless remote control unit.
 - Aim the wireless remote control unit (RC-238) at this receptor window when operating it.
- 4 Display Window**
 - The Disc No., Track No., playing time and other information are displayed in the display window.
- 5 Open/Close Button (▲ OPEN/CLOSE)**
 - Press this button when opening.
 - The drawer is opened toward the front.
 - Press the button again to close the drawer.
- 6 Disc trays (1 ~ 5)**
 - One disc per tray can be loaded.
- 7 Play Button (▶ PLAY)**
 - Press this button to play a disc.
 - The [▶] indicator lights up when the button is pressed, the number of the disc and the track being played is displayed by the Disc Number and Track No. indicator, and the amount of elapsed time for the current track is displayed on the time indicator.
 - The [▶] indicator goes off after playing of the final track of the final disc is finished and the player stops.
- 8 Pause Button (|| PAUSE)**
 - Press this button to stop play temporarily.
 - Pressing the Pause button during play stops play temporarily. The [▶] indicator goes off and the [||] indicator lights up.
 - To cancel the Pause state, press either the Play button [▶] or press the Pause button [||] a second time.
- 9 Stop Button (■ STOP)**
 - Press this button to stop play.
- 10 Automatic/Manual Search Reverse Button (◀/▶)**
 - Press this button to return the pickup to the beginning of the present track. Press again to return to other tracks.
 - By pressing the button a number of times, the pickup will move back the corresponding number of tracks.
 - Keep on pressing this button for more than 0.5 seconds during playback for fast reverse search. As long as the button is kept pressed, music signals are played back faster than normal.
 - Keep on pressing this button for more than 0.5 seconds when the pause mode is engaged, you can quickly reverse the pickup to a desired position, three times faster compared to manual reverse search during playback. During this time, no sound is heard.
- 11 Automatic/Manual Search Forward Button (▶/▶)**
 - Press this button to move the pickup forward to the beginning of the next track. Press again to move ahead to other tracks.
 - By pressing the button a number of times, the pickup will advance the corresponding number of tracks.
 - Keep on pressing this button for more than 0.5 seconds during playback for fast forward search. As long as the button is kept pressed, music signals are played back faster than normal.
 - Keep on pressing this button for more than 0.5 seconds when the pause mode is engaged, you can quickly forward the pickup to a desired position, three times faster compared to manual forward search during playback. During this time, no sound is heard.
- 12 Disc skip button (DISC SKIP)**
 - Each time this button is pressed, the carousal will rotate in a clockwise direction to the next tray position. This allows for loading or unloading of discs.
 - This button is also used to select the next disc; in the normal play continuously.
- 13 Random Button (RANDOM)**
 - Press this button to begin random play.
 - Pressing this button during stop, and press play button to full automatic random play.
 - Pressing this button during playing of a program starts random play of the tracks in the program. (See page 10, item 9.)
- 14 Repeat Button (REPEAT)**
 - Press this button for repeated playback. The [REPEAT] indicator appears on the display. The following three types of repeat modes are available:
 - When pressed once, the [REPEAT] and [▶] indicators light and the track currently playing is repeated.
 - When pressed again, the [REPEAT] and [▶] indicators light and all the tracks on the disc currently playing are repeated.
 - When pressed again, the [REPEAT] and [▶] indicators light and all the discs currently set on the tray are repeated.
 - When pressed again, the [REPEAT] and [▶] indicators turn off and the repeat mode is cancelled.
 The repeat function can also be used during programmed and manual playback, but in this case only, the all repeat ([ALL DISC] indicator) mode is available. (Refer to Page 9 item 9.)
- 15 Track Number Buttons (1 ~ 10)**
 - Press these buttons when making direct track selections or when entering tracks in program memory.
 - For example, when making a direct track selection, press the 3 button when desiring to play track 3. The player will then begin playing track [3]. When desiring to play track 12, press [12], then [2]. When making a program, press the Program/Direct button [▶] to enter the Program Mode.
- 16 +10 Button (+10)**
 - Press this button when selecting a track with a number greater than 11.
 - Use this button in combination with the number buttons [▶] for example, when selecting track number 15, press [▶], then [5].
 - To select track number 32, press [▶], [3], [2], then [2].

CONNECTIONS

- (1) **Connecting the Output Terminal (FIX-VARIABLE)**
- Connect one end of the connection cord supplied with the CD Player to the output terminals (FIX-VARIABLE) left (L) and right (R) of the CD Player, and the other end to the CD, AUX or TAPE PLAY input terminals, left (L) and right (R), of the amplifier.

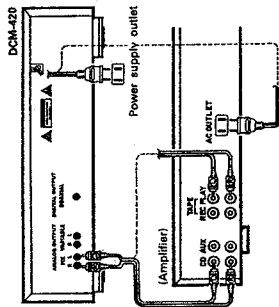

- (2) **Connecting the Digital Output Jack (COAXIAL)**
- Use a 75-ohm pin cord to connect the digital output jack (COAXIAL) of the DCM-420 to the digital input jack (COAXIAL) on a digital processor or D/A unit, available in stores.

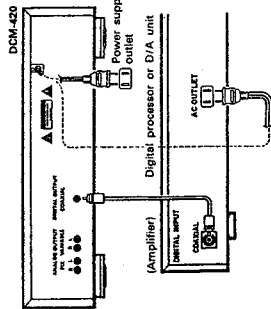

- Connection Precautions**
- Before proceeding with connections or disconnections of cables and power cords, be sure to turn all system components off.
 - Ensure that all cables are connected properly to the L (left) and R (right) jacks.
 - Insert plugs fully into the terminals.
 - Connect the output jacks to the amplifier CD, AUX or TAPE PLAY input jacks.

Output Terminal (FIX-VARIABLE)

- Connect the connection cords from these terminals to the amplifier's input terminals. (See page 7 for connections.)
- Digital Output Jack (COAXIAL)**
- This jack outputs digital data.
 - We recommend using a 75-ohm pin cord (available in stores) for connections.

Note:

- Do not stop the carousel by hand when it is turning. If this is done, the microprocessor erroneously determines the disc number and the disc can be damaged.

OPENING AND CLOSING THE DRAWER AND LOADING A DISC

Opening and closing the drawer (This operation only works while the power is on.)

- Press the power switch (POWER) to turn on the power.
- Press the open/close button (OPEN/CLOSE).

How to load a disc:

- Make sure the drawer is completely open.
- Hold the disc by the edges and place it on the disc tray. Do not touch the signal surface, i.e., the glossy side.
- Set the disc properly in the tray according to its size. Set 8cm discs in the center hole.
- Set 12cm discs in the outer hole.
- When the drawer is opened during the stop mode, discs can be loaded in the disc 1 to disc 4 trays. If the DISC SKIP button is pressed, the carousel turns and a disc can be loaded in the disc 5 tray.
- When the drawer is opened during the play mode, it is possible to load and unload discs in all of the disc trays other than the one whose disc is currently playing. In this case, the DISC SKIP button will not operate.
- Press the open/close button (OPEN/CLOSE) to close the drawer.

Caution:

- The player will not operate properly and the disc may even be damaged if it is not set correctly.
- If your finger should get caught in the drawer when it closes, press the open/close button (OPEN/CLOSE), and do not place more than one disc on the tray at a time. Otherwise malfunction may occur.
- Do not push in the disc tray manually when the power is off as this may cause malfunction and damage the CD player.
- Do not touch the carousel while it is turning. Also, do not turn the carousel by hand when it is stopped. Doing so could damage it.
- Do not insert disc where indicated by arrow. This could damage the internal mechanism in the unit.

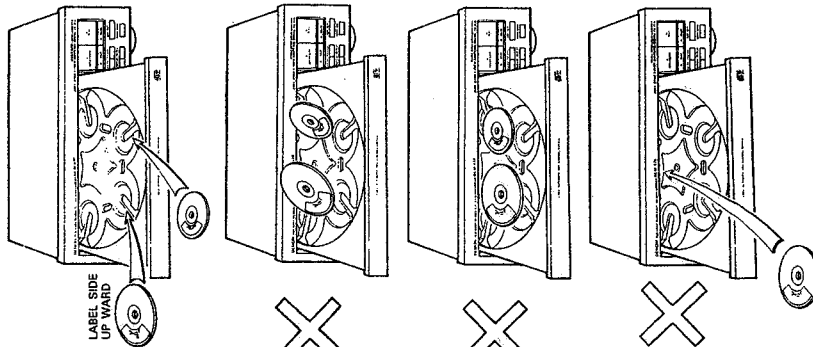

NORMAL PLAY

Follow the steps below to get an understanding of the disc play procedure.

(1) **Starting Playback**

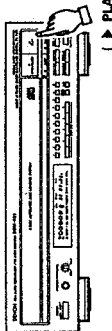

- Turn the power switch on and press the open/close (OPEN/CLOSE) button to open the drawer.
- Set the disc to be played in the tray on left side.
- Press the play button (▶).
- The disc number, track number and elapsed time, etc., for the disc currently playing, appear on the display window.
- If the open/close (OPEN/CLOSE) button is pressed while a disc is playing, playback continues, but the drawer opens and four discs can be replaced.
- Press the open/close (OPEN/CLOSE) button again to close the drawer.

(2) **Stopping Playback**

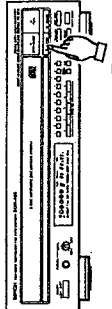

- Press the stop button (■) to stop playback.
- To replace discs, press the open/close (OPEN/CLOSE) button. The disc which was playing switches over to the left side and the drawer opens.

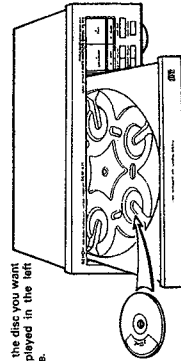

- Set the disc you want to played in the left side.

Program/Direct Button (PROG/DIRECT)

- Pressing this button selects between program memory and direct track selection.

Disc Number Buttons (1 ~ 5)

- Press these buttons to specify which disc you want to play.

Headphone Jack (PHONES)

- Insert the jack of the headphones when desiring to listen to a disc privately. (Headphones are sold separately.)

Volume Adjustment Knob (LEVEL)

- Use this knob to adjust the output level (volume) for the headphones.

OTHER PLAY METHODS

In addition to normal play, the following methods can be used when playing a disc.

1 To Play the Desired Disc and Desired Track **Direct Selection**

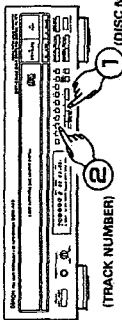

- 1 Press the button for the number of the desired disc (1 to 5).
- 2 Next, press the number of the desired track (1 to 10 and +10 buttons).

- Input the number of the track you would like to play with the 10 keys. If you would like to play the 4th track on the 3rd disc, press [3] for the Disc Number, then [4] for the Track Number. If you would like to play the 12th track on the 5th disc, press [5] for the Disc Number and [12] and [2] for the Track Number. Play will begin from the number of the disc and the track input.

2 To Move to the Next Disc During Playback **Disc Skip**

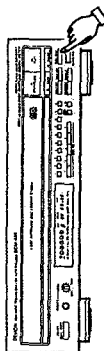

- 1 Press the disc skip button. The carousel in the drawer turns and the disc on the next tray is played. For example, if disc number 3 was playing, the disc switches to disc number 4, and if disc number 5 was playing, the disc switches to disc number 1.
- 2 In addition, when the Disc Skip - button on the RC-238 remote control unit is pressed, the carousel turns in the opposite direction and the previous disc is played.

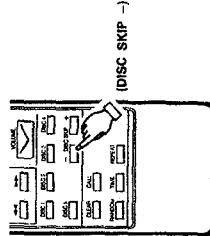

3 To Move to the Next Track during Play **Automatic Search**

Press the Automatic/Manual search forward button (▶▶) for less than 0.5 seconds during playback.

- The pickup will advance to the beginning of the next track and playback will continue. Pressing the button several times will forward the pickup the corresponding number tracks.

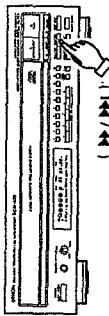

Press the ▶▶ button

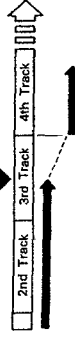

4 During Random or Program operation, player moves to the beginning of the next random or program track selection.

5 To return to the beginning of the track now being played **Automatic Search**

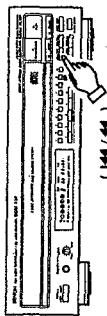

Press the Automatic/Manual search reverse button (◀◀) for less than 0.5 seconds during playback.

- The pickup will return to the beginning of the current track and playback will continue. Pressing the button several times will return the pickup the corresponding number tracks.

Press the ◀◀ button



6 To Play the Desired Discs and the Desired Tracks in the Desired Order **Program Selection**

- You can play certain tracks on the loaded discs in any order.
- Tracks on a disc not loaded can also be programmed, but if you try to play that disc, the microprocessor detects that it is not loaded and the following disc is played automatically.
- Up to 20 tracks can be set in a program.
- A program can be made for a single entire disc.

(1) Programming

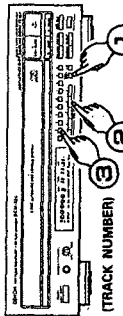

(DISC NUMBER) (PROGRAM/DIRECT)

- Pressing the Program (PROGRAM/DIRECT) button causes the [PROGRAM] indicator to light up. Select the disc, track in the program using the Disc Number buttons and the Track Number buttons and [▶▶] button. For example, if you would like to hear the 3rd track of the 2nd disc and the 12th track of the 5th disc, press [PROGRAM/DIRECT], Disc Number [2], Track Number [3], Disc Number [5], then Track Number [12]. It is not necessary to specify the disc if all the tracks in the program are from the same disc.
- If all the tracks are being selected from the same disc, all the tracks on a particular disc can be played, such as from the 1st track of the 3rd disc, all tracks of the 5th disc and the 5th track of the 5th disc.
- In this case, press [PROGRAM/DIRECT], Disc Number [3], Track Number [1], Disc Number [5], then Disc Number [5], Track Number [5].

(2) To Check the Programmed Tracks

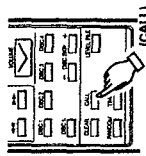

- Press the call button on the RC-238 wireless remote control unit. The contents of the program are displayed in order one item at a time each time the Call button is pressed.

(3) To Play a Program

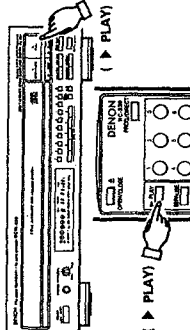

- Press the Play (▶▶) button to play the programmed selections in the order in which they were programmed.

- (4) To Erase all the Contents of a Program**
- Pressing the PROG/DIRECT button once more erases the entire program. Pressing the open/close (▶) OPEN/CLOSE button also erases the contents of a program.
 - Pressing the PROG/DIRECT button while a program is being played cancels the program. Play will then be continuous to the end of the disc currently being played, after which the player will stop automatically.

Cautions

- If a program is run during playing of a track or from the Pause state, the track which is currently being played becomes the 1st track in the program.
- Additional tracks can be added to the program, but the player will not display the number of tracks in the program or the playing time.
- Direct selection cannot be done while a program is being played. Inputting the track number of a desired track with the Track Number buttons adds the input track to the end of the program.
- When programming, do not program a track number which is not recorded on the disc. If such a number is programmed by mistake, the player ignores the program.
- The CLEAR button on remote control unit RC-238 cannot be used to clear the program. This button is only for disc level files.

5 To Repeat Play of All Tracks **Repeat Play**

- Press the Repeat (REPEAT) button. The [REPEAT] indicator will light up.
- Steps 1 and 2 can be done in any order, with the same results.

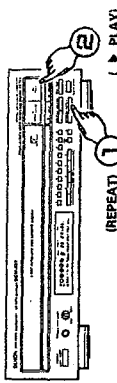

- When the repeat button is pressed once, the [REPEAT] and [DISC] indicators light. In this mode, the track currently playing is repeated.

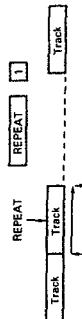

- If the repeat button is pressed again, the [REPEAT] and [DISC] indicators light, and the disc currently playing is repeated.

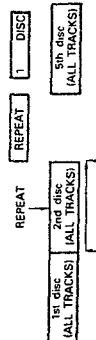

- If the repeat button is pressed again, the [REPEAT] and [ALL DISC] indicators light, and all the discs currently loaded are repeated.

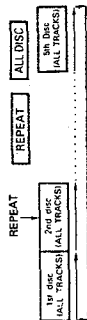

- Pressing the Repeat (REPEAT) button during play will also cause the player to repeat play (of all tracks).
- To cancel repeat play, press the Repeat (REPEAT) button once more.
- Pressing the Repeat (REPEAT) button while a program is being played will cause the tracks in the program to be played again in order.
- Pressing the Repeat (REPEAT) button during Random play will cause the tracks to be played again at random.

Letting the Player Select the Order of Play (Random Play)

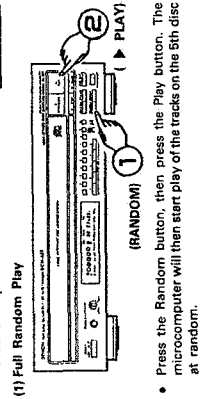

- Press the Random button, then press the Play button. The microcomputer will then start play of the tracks on the 5th disc at random.

Program Random Play

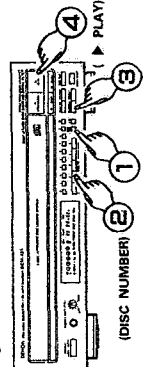

- After pressing the PROG/DIRECT button and inputting a program (See item 8 on page 8), press the Random button, then the Play button. The microcomputer will then select tracks from the program at random and play them.

Disc Sequential Random Play

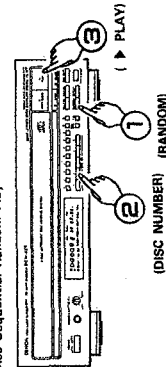

- Press the Random button. Next press the Disc Number buttons for the discs to be played, in the desired order, then press the Play button. The microcomputer will then select tracks from the specified discs to be played at random, in the order in which the discs were selected.
- Up to 5 discs can be selected, and the same disc can be selected, two or more times. Disc sequential random play is cancelled when play ends.

(4) To Cancel Random Play

- Pressing the Random button once more cancels the Random function. Play will then proceed from the track currently being played to the end of the last track on the disc, then stop. Pressing the open/close (OPEN/CLOSE) button also cancels the Random function.

Cautions

- Pressing the Random button during normal play starts full random play.
- Pressing the Random button during Program play starts random play of the tracks in the program, including the tracks which have already been played.
- During random play, the player may display the number of disc which is not loaded in the tray, in such a case, the player will read the disc information, then reset automatically to correct. This is not a malfunction.

To Stop Play Temporarily (Pause)

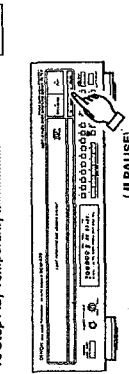

- Pressing the Pause button during play stops play at that point. Pressing the Pause button once more starts play again from the same point.

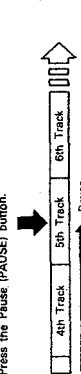

- Press the Play (▶) button or the Pause (II PAUSE) button.
- Press the Play (▶) button or the Pause (II PAUSE) button to start play.

Audible quick search (Manual Search)

- Using this function, you can cue to a desired point within a track, either in the forward or reverse direction.
- Release the automatic/manual search button (◀/▶) or (▶/▶) when the desired point has been reached. Normal playback then continues.

Manual Search Forward

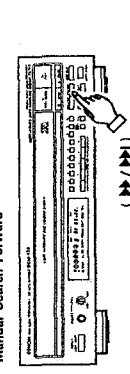

- Keep on pressing the automatic/manual search forward button (▶/▶) for more than 0.5 seconds during playback. Playback of the track is sped up.
- As a reference, the current track number and elapsed playback time within the track are displayed.
- Manual search forward is approximately three times faster when engaged during the pause state compared to playback. In this case, no sound is heard however.
- If the automatic/manual search forward button (▶/▶) is kept pressed after the end of the final track on the disc is reached, (DJ) is displayed and manual search stops. To return to another point, press the automatic/manual search reverse button (◀/◀) until (J) disappears.

Manual Search in Reverse

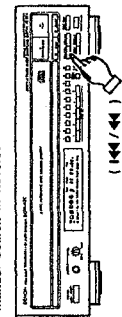

- Keep on pressing the automatic/manual search reverse button (◀/◀) for more than 0.5 seconds during playback. Reverse playback of the track is sped up.
- As a reference, the current track number and elapsed playback time within the track are displayed.
- Manual search in reverse is approximately three times faster when engaged during the pause state compared to playback. In this case, no sound is heard however.
- If the automatic/manual search reverse button (◀/◀) is kept pressed after the beginning of the first track on the disc is reached, (CT) is displayed and manual search stops. To return to another point, press the automatic/manual search forward button (▶/▶) until (CT) disappears.

To Cue and Stop Play (Pause)

- Cueing by Direct Selection
- Cueing by direct selection, then entering the Pause state, is convenient for practicing vocals with background music.

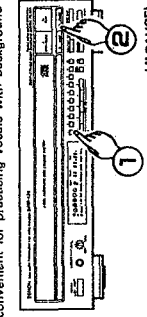

- Press the Track Number buttons to set the number of the desired track.
- Press the Pause (II PAUSE) button.
- To start play, press the Play (▶) button or the Pause (II PAUSE) button.

Cueing by Program Selection

- After setting the desired track selections in a program, press the Pause (II PAUSE) button. The player will advance to the beginning of the 1st track in program memory and wait in the Pause state.

Storing the desired variable output level for different discs (Disc Level File)

- This function is for storing in the memory the desired variable output level for different discs, and is effective for playing different discs at different levels.
- Use the RC-238 remote control unit to set the variable output to the desired level, then press the LEVEL FILE key on the RC-238 remote control unit to store the output level for that disc in the memory. When this is done, "FILE" is displayed on the TIME display for approximately 1 second, after which the volume level is displayed for approximately 1 second.
- The next time that disc is loaded, the variable output is automatically set at the level stored in the memory. When a disc whose variable output level has been stored is loaded, the volume level is displayed on the TIME display for approximately 2 seconds after the disc is loaded.

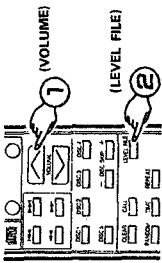

- Clearing levels in the memory
- Load the disc whose level you want to clear. Press the LEVEL FILE button on the RC-238 remote control unit, and while "FILE" is being displayed on the TIME display press the CLEAR button. "CLEAR" is displayed for approximately 1 second, and the level for that disc is cleared from the memory.

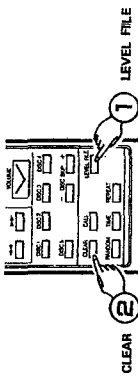

- Disc level file capacity
- The variable output level for up to 100 discs can be stored in the memory. Once disc levels are set for 100 discs, if a new disc is loaded and the LEVEL FILE button is pressed as in step (1) above, "FULL" is displayed for approximately 1 second to indicate that no more levels can be stored.
- To store the level for a new disc, first clear the level for a disc which has previously been stored in the memory.

CAUTION

- Note that when listening with the variable output level turned low, if you change the disc and the level for the new disc stored in the memory is high, the volume will increase when the new disc starts playing.
- To prevent sudden increases in volume, the volume increases gradually if the difference in level between the two discs is 15 steps (approximately 22.5 dB) or greater.

NOTE

- The volume is displayed on the TIME display, with "-" displayed in the minutes section (M) and the level displayed in the seconds section (S). 0 is the maximum level, -90 the minimum, with one step equivalent to approximately 1.5 dB.
- If the remote control unit is lost, hold in the DISC 2 button and press the STOP button (■) in the stop mode to set the variable output level to the maximum (0 dB).

INSTALLATION PRECAUTIONS

The CD player uses a microcomputer for controlling internal electronic circuits. In the event that the player is used while a nearby tuner or TV is turned on, although unlikely, interference could occur either in the sound from the tuner or the picture of the TV. To avoid this, please take the following precautions.

- Keep the CD player as far away from the tuner or TV set as possible.
- Keep the power cable and connecting cable of the CD player separate from the antenna wires of the tuner and TV.
- Interference is particularly likely to occur when an indoor antenna or a 300-ohm feeder cable is used. Thus, use of an outdoor antenna and 75-ohm coaxial cable is strongly recommended.

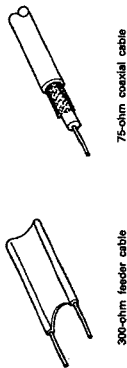

PLAY USING THE REMOTE CONTROL UNIT

The DCM-420 CD Player can be controlled from across the room using the accessory Remote Control Unit RC-238.

(1) Inserting the Dry Battery

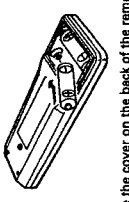
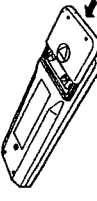
1. Remove the cover on the back of the remote control unit.
 
2. Insert 2 R6P (AA size) dry batteries. Check the polarity indications inside the case for correct insertion.
 
3. Replace the cover on the back of the remote control unit.
 

Caution Concerning Dry Batteries

- Use only R6P (AA size) dry batteries in the remote control unit.
- Depending on the frequency of use, the dry batteries should be replaced approximately once per year.
- If the remote control unit fails to control the CD Player, even before a year has passed, replace the dry batteries with new ones.
- Be sure to follow polarity indications inside the case of the remote control unit, inserting the + end and - end of each battery in the directions indicated.
- Batteries may become damaged or leak under the following conditions:
 - Using new batteries together with old ones.
 - Using different types of batteries together.
 - Do not short batteries, take them apart, subject them to heat, or throw them into a fire.
- When the remote control unit is not used for a long period of time, remove the dry batteries.
- If fluid leaks from the batteries, be sure to wipe up all battery fluid inside the battery case and replace the batteries with new ones.

(2) Using the Remote Control Unit

- Aim the remote control unit toward the light receptor in the front of the CD Player, as shown in the drawing below.
- The remote control unit can be used up to a distance of 8 meters in a straight line from the CD Player. However, this distance will be shortened if there is some obstruction between the remote control unit and the light receptor, or if the beam of light is slanted.

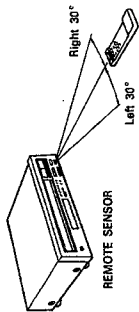

- The remote control unit has the same functions as the main unit, but the following operations cannot be done.
 1. Switching the power on and off.
 2. Adjusting headphones volume.

Caution During Use

- Do not press the operating buttons on the main unit and the remote control unit at the same time. This could cause a malfunction.
- Operation of the remote control unit will be hindered if a strong light from the sun or a light fixture is shining on the REMOTE SENSOR, or if there is an obstruction between the remote control unit and the CD player unit.

REMOTE CONTROL UNIT RC-238

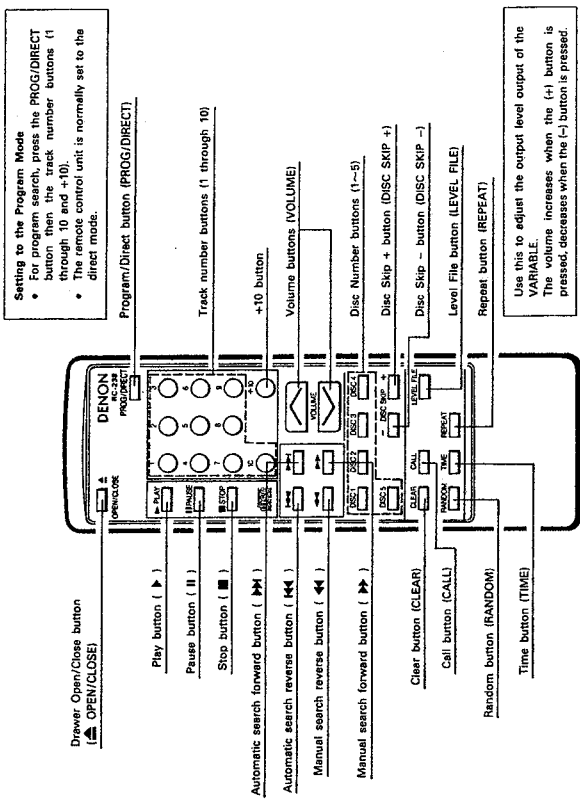

Setting to the Program Mode

- For program search, press the PROG/DIRECT button then the track number buttons (1 through 10 and +10).
- The remote control unit is normally set to the direct mode.

Use this to adjust the output level of the AMPLIFIER. The volume increases when the (+) button is pressed, decreases when the (-) button is pressed.

- **Direct Selection**
Normally, direct search is possible simply by pressing the desired number buttons.
- **Program Selection (During playback, the track which is currently playing is programmed as the 1st track.)**
Press the PROG/DIRECT button, then press the number buttons.
For example, to program tracks number 3, 11, and 5, press PROG/DIRECT → 3 → +10 and 1 → 5.
To cancel the program, press the PROG/DIRECT button.
- **Skipping Discs**
The Disc Skip button (DISC SKIP +, -) will not function in the random and program modes.
During disc sequential random playback, when the Disc Skip + button is pressed, the following disc is played in random order.
- **Volume**
The output level of the VARIABLE output terminal can be changed.
When the volume button is pressed, "V" appears in the TIME M (minutes) section of the display window and the level appears in the S (seconds) section. The volume can be changed between a maximum of "0" and a minimum of "-50" in 50 steps, by approximately 1.5 dB per step.
- **Inputting the Track Numbers**
For track numbers below 9, simply press the corresponding button. For track numbers of 10 and greater, press the +10 button.
For example, for track number 22, press +10 twice then 2.
- **Volume**
The volume control on the unit will operate when the volume buttons are pressed. The volume can be checked by looking at the position of the control.
- **Time**
The Time indicator indicates the amount of elapsed time for the track currently being played, the amount of time remaining for the current track, and the amount of time remaining for all tracks yet to be played.
Normally, the amount of elapsed time for the current track is displayed. Pressing this button once causes the [SINGLE] indicator to light up, displaying the amount of time remaining for the current track. Pressing the button once more turns the [SINGLE] indicator off and causes the [TOTAL] indicator to light up, displaying the time remaining for all tracks yet to be played on the disc. Pressing the button once again turns the [TOTAL] indicator off and causes the indicator to display the elapsed time for the current track.
During playback, the total remaining time is the remaining time for the disc. For programmed playback, the remaining time for the program is only displayed when the programmed tracks are all on the same disc.
In the case of 21st and subsequent tracks, the time remaining for one track is displayed "----". When 21st and subsequent tracks is programmed, the time remaining for all tracks is displayed "----".
"----" is displayed when tracks on more than one disc are programmed.

DENON

STEREO CD PLAYER DCM-320 OPERATING INSTRUCTIONS

Thank you for purchasing the DENON compact disc player. Read the Operating Instructions thoroughly, and operate this player properly.

— TABLE OF CONTENTS —

FEATURES	3
CAUTIONS DURING USE	3
NAMES OF PARTS AND THEIR FUNCTIONS	4, 5
OPENING AND CLOSING THE DRAWER AND LOADING A DISC	6
CONNECTIONS	7
NORMAL PLAY	7
OTHER PLAY METHODS	8-11
INSTALLATION PRECAUTIONS	12
PLAY USING THE REMOTE CONTROL UNIT	12, 13
COMPACT DISCS	14
TROUBLE? CHECK THE PLAYER TO FIND WHAT'S WRONG	14

In addition to the CD Player unit, please check to make sure the following items are included in the packing box.

- (1) Operating Instructions
- (2) Warranty Card
- (3) Connection Cards
- (4) Remote Control Unit RC-237
- (5) R6P (AA size) Dry batteries

IMPORTANT (CANADIAN MODEL ONLY)

This digital apparatus does not exceed the Class B limits for radio noise emissions from digital apparatus set out in the Radio Interference Regulations of the Canadian Department of Communication.

CLASS 1 LASER PRODUCT LUOKAN 1 LASERLAITE KLASS 1 LASERAPPARAT

ADVARSEL: USYNLIG LASERSTRÅLING VED ÅBNING.
UNDGÅ UDSÆTTELSE FOR STRÅLING.

VAROITUS: LAITTEEN KÄYTTÄMINEN MUULLA KUIN TÄSSÄ
KÄYTTÖOHJEESA MAINITULLA TAVALLA SAATAAN
ALITISTAA KÄYTTÄJÄN TURVALLISUUSLUOKAN 1
YLIITÄVÄLLE NÄKYMÄTTÖMÄLLE LASERSÄTEILYLLE.

WARNING: OM APPARATEN ANVÄNDS PÅ ANNAT SÄTT ÄN I DENNA
BRUKSANVISNING SPECIFICERATS, KAN ANVÄNDAREN
UTSÄTTAS FÖR ÖSYNLIG LASERSTRÅLING, SOM
ÖVERSKRIDER GRÄNSEN FÖR LASERKLASS 1.

CAUTIONS DURING USE

- This compact disc player is capable of playing discs which have the mark at right.
- During track selection, during search and when the player sustains a strong impact, the disc's rotational speed changes greatly, causing a small noise to be emitted. This is not a malfunction of the player.
- If the CD player is operated while an FM or AM broadcast is being received, there may be noise in the FM or AM reception. Please switch the power to the CD player off at such times.
- The DCM-320 has a broad dynamic range. Please exercise caution when turning up the volume on the amplifier in cases when the playback volume is low. If the volume is turned up too high, it could damage the speakers.
- Do not use any discs but exclusive audio discs with this CD player.

FEATURES

The DCM-320 is a 5-disc carousel type CD changer which includes an exclusive Denon Super Linear Converter which eliminates sound quality deterioration in the PCM audio system in order to reproduce the exact sound captured in the studio or at the live performance recorded on the compact disc. In addition to components rigorously selected for their high performance and excellent audio quality to recapture the original sound in full.

- (1) **Double Super Linear Converter**
DENON's unique method to prevent zero cross distortion, the major cause of reductions in sound quality in the PCM playback system, is used in both of the independent D/A converters for the left and right channels, providing sound fields with rich musical expression.
- (2) **High Performance Digital Filter**
8 times oversampling with noise shaping high precision digital filter has been adopted for the DCM-320. This helps the unit achieve outstanding linear phase characteristics.
- (3) **Newly developed carousel-type changer mechanism** included
This mechanism can house five discs, and while one disc is playing the remaining four discs can be changed. In addition, the carousel can be rotated either clockwise or counterclockwise, so searching between discs is fast.
- (4) **Playback of 8 cm (3-inch) CD's**
8 cm (3-inch) CD's can be played.

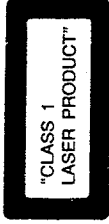

- Placing this player or its connection cords near a TV or other audio device could cause a humming sound to be emitted. If this occurs, relocate the player or reroute the connection cords.
- Be sure to remove the disc from the player before moving it. The disc could be damaged if left in the player while it is being moved.
- Do not place any object in the tray in the position where the disc is loaded, or open and close the tray with anything inside. Foreign objects in the tray could damage the play mechanism.
- Do not move the player from a cold place to a warm room suddenly. If the player is cold when brought into a warm room, condensation could form, preventing proper operation of the player. If condensation does form on the player when it is brought into a warm room, wait at least 30 minutes before use.

NAMES OF PARTS AND THEIR FUNCTIONS

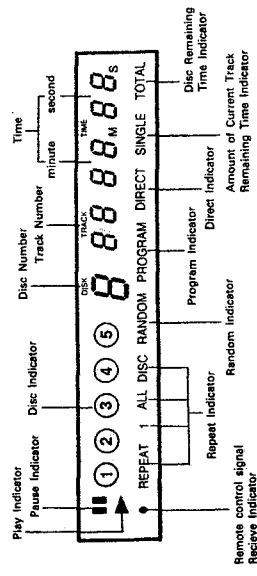
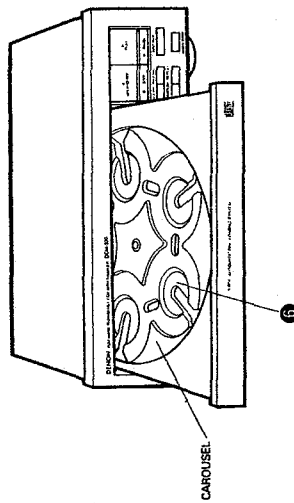
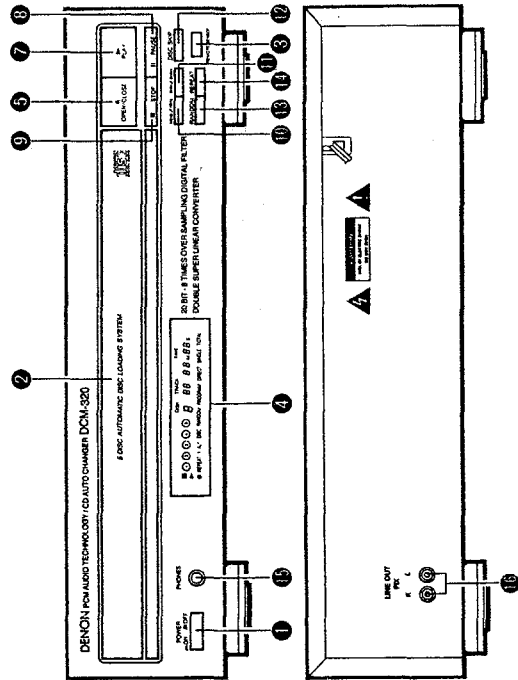

- 1 **Power Switch (POWER)**
 - Press this button to switch on the power.
 - When the power is turned off, the unit is set to the standby mode.
 - If the power is turned off during playback or while the disc information is displayed on the time display, several seconds after the power is turned back on, the number of the disc appears on the disc number display, the total number of tracks on that disc is displayed on the track number display, and the total time is displayed on the time display, and approximately 1 second later, playback starts.
- 2 **Loading drawer**
 - Discs can be loaded and unloaded when this drawer is open. Do not force the drawer closed by hand.
- 3 **Remote Control Receptor (REMOTE SENSOR)**
 - This receptor receives infrared signals from the wireless remote control unit.
 - Aim the wireless remote control unit (RC-237) at this receptor window when operating it.
- 4 **Display Window**
 - The Disc No., Track No., playing time and other information are displayed in the display window.
- 5 **Open/Close Button (▲ OPEN/CLOSE)**
 - Press this button when opening.
 - The drawer is opened toward the front.
 - Press the button again to close the drawer.
- 6 **Disc trays (1 ~ 5)**
 - One disc per tray can be loaded.
- 7 **Play Button (▶ PLAY)**
 - Press this button to play a disc.
 - The [▶] indicator lights up when the button is pressed, the number of the disc and the track being played is displayed by the Disc Number and Track No. indicator, and the amount of elapsed time for the current track is displayed by the Time indicator.
 - The [▶] indicator goes off after playing of the final track of the final disc is finished and the player stops.
- 8 **Pause Button (|| PAUSE)**
 - Press this button to stop play temporarily.
 - Pressing the Pause button during play stops play temporarily. The [▶] indicator goes off and the [||] indicator lights up.
 - To cancel the Pause state, press either the Play button or press the Pause button a second time.
- 9 **Stop Button (■ STOP)**
 - Press this button to stop play.
- 10 **Automatic/Manual Search Reverse Button (◀/▶/◀)**
 - Press this button to return the pickup to the beginning of the present track. Press again to return to other tracks.
 - By pressing the button a number of times, the pickup will move back the corresponding number of tracks.
 - Keep on pressing this button for more than 0.5 seconds during playback for fast reverse search. As long as the button is kept pressed, music signals are played back faster than normal.
 - Keep on pressing this button for more than 0.5 seconds when the pause mode is engaged, you can quickly reverse the pickup to a desired position, three times faster compared to manual reverse search during playback. During this time, no sound is heard.
- 11 **Automatic/Manual Search Forward Button (▶/▶/▶)**
 - Press this button to move the pickup forward to the beginning of the next track. Press again to move ahead to other tracks.
 - By pressing the button a number of times, the pickup will advance the corresponding number of tracks.
 - Keep on pressing this button for more than 0.5 seconds during playback for fast forward search. As long as the button is kept pressed, music signals are played back faster than normal.
 - Keep on pressing this button for more than 0.5 seconds when the pause mode is engaged, you can quickly forward the pickup to a desired position, three times faster compared to manual forward search during playback. During this time, no sound is heard.
- 12 **Disc skip button (DISC SKIP)**
 - Each time this button is pressed, the carousel will rotate in a clockwise direction to the next tray position. This allows for loading or unloading of discs.
 - This button is also used to select the next disc, in the normal play continuously.
- 13 **Random Button (RANDOM)**
 - Press this button to begin random play.
 - Pressing this button during stop, and press play button play to full automatic random play.
 - Pressing this button during playing of a program starts random play of the tracks in the program. (See page 10, item 6.)
- 14 **Repeat Button (REPEAT)**
 - Press this button for repeated playback. The [REPEAT] indicator appears on the display. The following three types of repeat modes are available:
 - When pressed once, the [REPEAT] and [▶] indicators light and the track currently playing is repeated.
 - When pressed again, the [REPEAT] and [DISC] indicators light and all the tracks on the disc currently playing are repeated.
 - When pressed again, the [REPEAT] and [ALLDISC] indicators light and all the discs currently set on the tray are repeated.
 - When pressed again, the [REPEAT] and [ALLDISC] indicators turn off and the repeat mode is cancelled.
 The repeat function can also be used during programmed and random playback, but in this case only the all repeat ([ALLDISC] indicator) modes are available. (Refer to page 9, item 6.)
- 15 **Headphone Jack (PHONES)**
 - Insert the jack of the headphones when desiring to listen to a disc privately. (Headphones are sold separately.)
- 16 **Output Terminal (FIX)**
 - Connect the connection cords from these terminals to the amplifier's input terminals. (See page 7 for connections.)

Note:

- Do not stop the carousel by hand when it is turning, if this is done, the microprocessor erroneously determines the disc number, and the disc can be damaged.

OPENING AND CLOSING THE DRAWER AND LOADING A DISC

Opening and closing the drawer (This operation only works while the power is on.)

1. Press the power switch (POWER) to turn on the power.
2. Press the open/close button (▲ OPEN/CLOSE).

How to load a disc

- Make sure the drawer is completely open.
- Hold the disc by the edges and place it on the disc tray. (Do not touch the signal surface, i.e., the glossy side).
- Set the disc properly in the tray according to its size.
- Set 8cm discs in the center hole.
- Set 12cm discs in the outer hole.
- When the drawer is opened during the stop mode, discs can be loaded in the disc 1 to disc 4 trays. If the DISC SKIP button is pressed, the carousel turns and a disc can be loaded in the disc 5 tray.
- When the drawer is opened during the play mode, it is possible to load and unload discs in all of the disc trays other than the one whose disc is currently playing. In this case, the DISC SKIP button will not operate.
- Press the open/close button (▲ OPEN/CLOSE) to close the drawer.

Caution:

- The player will not operate properly and the disc may even be damaged if it is not set correctly.
- If your finger should get caught in the drawer when it closes, press the open/close button (▲ OPEN/CLOSE).
- Do not place any foreign objects on the disc tray, and do not place more than one disc on the tray at a time. Otherwise malfunction may occur.
- Do not push in the disc tray manually when the power is off as this may cause malfunction and damage the CD player.
- Do not touch the carousel while it is turning. Also, do not turn the carousel by hand when it is stopped. Doing so could damage it.

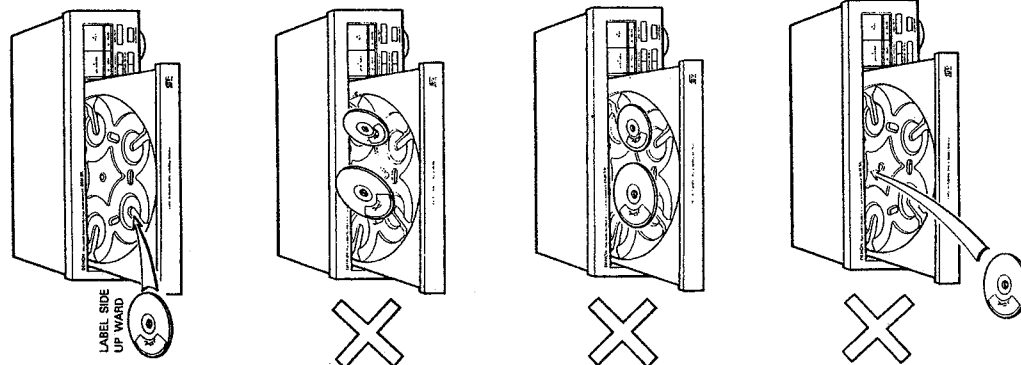

- Do not insert disc where indicated by arrow.
- This could damage the internal mechanism in the unit.

CONNECTIONS

- (1) Connecting the Output Terminal (FX)
 - Connect one end of the connection cord supplied with the CD Player to the output terminals (FX), left (L) and right (R) of the CD Player, and the other end to the CD, AUX or TAPE PLAY input terminals, left (L) and right (R), of the amplifier.

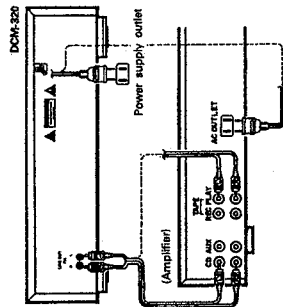

Connection Precautions

- Before proceeding with connections or disconnections of cables and power cords, be sure to turn all system components off.
- Ensure that all cables are connected properly to the L (left) and R (right) jacks.
- Insert plugs fully into the terminals.
- Connect the output jacks to the amplifier CD, AUX or TAPE PLAY input jacks.

NORMAL PLAY

Follow the steps below to get an understanding of the disc play procedure.

(1) Starting Playback

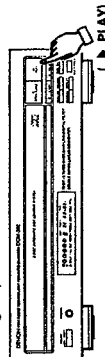

1. Turn the power switch on and press the open/close (▲ OPEN/CLOSE) button to open the drawer.
 2. Set the disc to be played in the tray on left side.
 3. Press the play button (▶).
 4. The drawer closes and the disc just loaded is played.
 5. The disc number, track number and elapsed time, etc., for the disc currently playing appear on the display window.
 6. If the open/close (▲ OPEN/CLOSE) button is pressed while a disc is playing, playback continues, but the drawer opens and four discs can be replaced.
- Press the open/close (▲ OPEN/CLOSE) button again to close the drawer.

(2) Stopping Playback

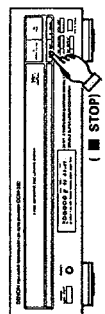

1. Press the stop button (■) to stop playback.
2. To replace discs, press the open/close (▲ OPEN/CLOSE) button. The disc which was playing switches over to the left side and the drawer opens.

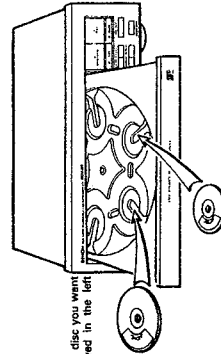

- Set the disc you want to played in the left side.

OTHER PLAY METHODS

In addition to normal play, the following methods can be used when playing a disc.

- 1 To Play the Desired Disc and Desired Track [DIRECT SELECT] (Remote control only)

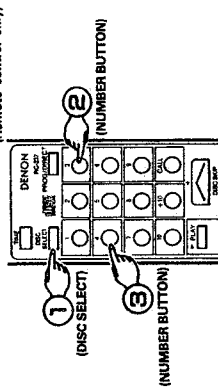

1. Press the DISC SELECT button.
 2. Use the number buttons (1 to 5) to select the number of the disc to be played.
 3. Next, use the number buttons (1 to 10 and +10) to select the number of the track to be played.
- For example, to play the 4th track on the 3rd disc: Press [DISC SELECT] [3] and [4].
 - To play the 12th track on the 5th disc: Press [DISC SELECT] [5], [+10] and [2].
- Playback begins from the number of the disc and track selected.

- 2 To Move to the Next Disc During Playback [DISC SKIP]

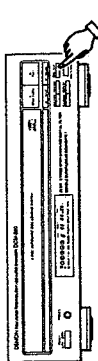

- 1 Press the disc skip button. The carousel in the drawer turns and the disc on the next tray is played.
- For example, if disc number 3 was playing, the disc switches to disc number 4, and if disc number 5 was playing, the disc switches to disc number 1.
- 2 In addition, when the Disc Skip - button on the RC-237 remote control unit is pressed, the carousel turns in the opposite direction and the previous disc is played.

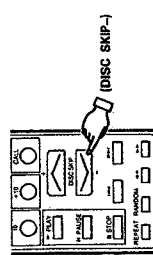

- 3 To Move to the Next Track during Play [AUTOMATIC SEARCH]

Press the Automatic/Manual search forward button (▶▶▶) for less than 0.5 seconds during playback.

- The pickup will advance to the beginning of the next track and playback will continue. Pressing the button several times will forward the pickup the corresponding number tracks.

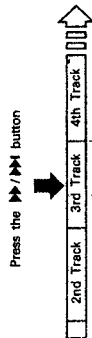
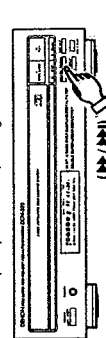

- 4 During Random or Program operation, player moves to the beginning of the next program or program track selection.

- 5 To return to the beginning of the track now being played [AUTOMATIC SEARCH]

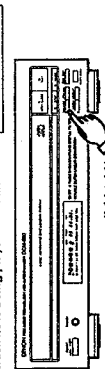

Press the Automatic/Manual search reverse button (◀◀◀) for less than 0.5 seconds during playback.

- The pickup will return to the beginning of the current track and playback will continue. Pressing the button several times will return the pickup the corresponding number tracks.

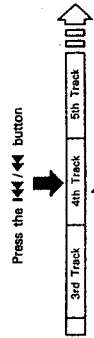

- 6 To Play the Desired Discs and the Desired Tracks in the Desired Order [PROGRAM SELECTION] (Remote control only)

- You can play certain tracks on the loaded discs in any order.
- Tracks on a disc not loaded can also be programmed, but if you try to play that disc, the microprocessor detects that it is not loaded and the following disc is played automatically.
- Up to 20 tracks can be set in a program.
- A program can be made for a single entire disc.

(1) Programming

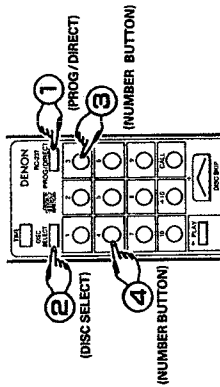

- Press the PROG/DIRECT button. The [PROGRAM] indicator lights. Use the DISC SELECT, number and +10 buttons to select the disc to be programmed.

For example, to program the 3rd track on the 2nd disc and the 12 track on the 5th disc, press [PROG/DIRECT], [DISC SELECT], [2], [3], [DISC SELECT], [5], [+10] and [2].

If all the tracks are being selected from the same disc, all the tracks on a particular disc can be played, such as from the 1st track of the 3rd disc, all tracks of the 5th disc and the 6th track of the 5th disc.

In this case, press [PROG/DIRECT], [DISC SELECT], [3], [1], [DISC SELECT], [5], [DISC SELECT], [5] and [6].

- 2 To Check the Programmed Tracks

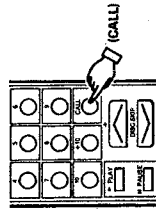

- Press the call button on the RC-237 wireless remote control unit. The contents of the program are displayed in order one item at a time each time the Call button is pressed.

- 3 To Play a Program

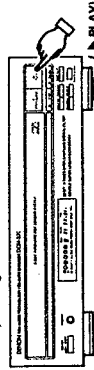

- Press the Play (▶) button to play the programmed selections in the order in which they were programmed.

- 4 To Erase all the Contents of a Program
- Pressing the PROG/DIRECT button once more erases the entire program. Pressing the open/close (▲) OPEN/CLOSE button also erases the contents of a program.
- Pressing the PROG/DIRECT button while a program is being played cancels the program. Play will then be continuous to the end of the disc currently being played, after which the player will stop automatically.

Caution

- If a program is run during playing of a track or from the Pause state, the track which is currently being played becomes the 1st track in the program.
- Additional tracks can be added to the program, but the player will not display the number of tracks in the program or the playing time.
- Direct selection cannot be done while a program is being played. Inputting the track number of a desired track with the Track Number buttons adds the input track to the end of the program.
- When programming, do not program a track number which is not recorded on the disc. If such a number is programmed by mistake, the player ignores the program.

- 5 To Repeat Play of All Tracks

- Press the Repeat (REPEAT) button. The [REPEAT] indicator will light up.
- Steps ① and ② can be done in any order, with the same results.



- When the repeat button is pressed once, the [REPEAT] and [DISC] indicators light. In this mode, the track currently playing is repeated.

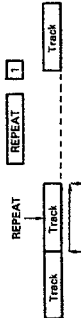

- If the repeat button is pressed again, the [REPEAT] and [DISC] indicators light, and the disc currently playing is repeated.

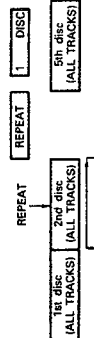

- If the repeat button is pressed again, the [REPEAT] and [ALL DISC] indicators light, and all the discs currently loaded are repeated.

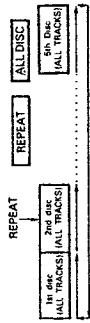

- Pressing the Repeat (REPEAT) button during play will also cause the player to repeat play (of all tracks).
- To cancel repeat play, press the Repeat (REPEAT) button once more.
- Pressing the Repeat (REPEAT) button while a program is being played will cause the tracks in the program to be played again in order.
- Pressing the Repeat (REPEAT) button during Random play will cause the tracks to be played again at random.

⑦ Letting the Player Select the Order of Play [Random Play]

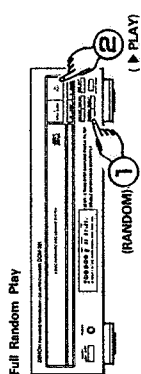

- Press the Random button, then press the Play button. The microcomputer will then start play of the tracks on the 5th disc at random.

⑧ Program Random Play (Remote control only)

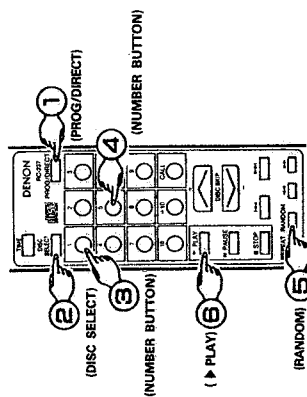

- After pressing the PROG/DIRECT button and inputting a program (See item 8 on page 8) press the Random button, then the Play button. The microcomputer will then select tracks from the program at random and play them.

③ Disc Sequential Random Play (Remote control only)

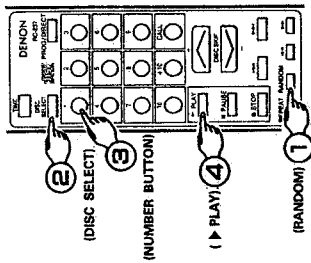

- Press the Random button. Next press the Disc Number buttons for the discs to be played, in the desired order, then press the Play button. The microcomputer will then select tracks from the specified discs to be played at random, in the order in which the discs were selected. Up to 5 discs can be selected, and the same disc can be selected two or more times. Disc sequential random play is cancelled when play ends.

- ④ To Cancel Random Play
 - Pressing the Random button once more cancels the Random function. Play will then proceed from the track currently being played to the end of the last track on the disc, then stop.
 - Pressing the open/close (OPEN/CLOSE) button also cancels the Random function.

Cautions

- Pressing the Random button during normal play starts full random play.
- Pressing the Random button during Program play starts random play of the tracks in the program, including the tracks which have already been played.
- During random play, the player may display the number of disc which is not loaded in the tray. In such a case, the player will read the disc information, then reset automatically to correct. This is not a malfunction.

⑨ To Stop Play Temporarily [Pause]

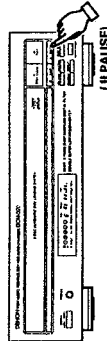

- Pressing the Pause button during play stops play at that point. Pressing the Pause button once more starts play again from the same point.
- Press the Pause (PAUSE) button.

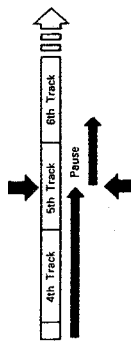

- 2. Press the Play (▶ PLAY) button or the Pause (⏸ PAUSE) button, then start play.
- Press the Play (▶ PLAY) button or the Pause (⏸ PAUSE) button to start play.

⑥ Audible quick search [Manual Search]

- Using this function, you can cue to a desired point within a track, either in the forward or reverse direction.
- Release the automatic/manual search button (⏮/⏪ or ⏩/⏭) when the desired point has been reached. Normal playback then continues.

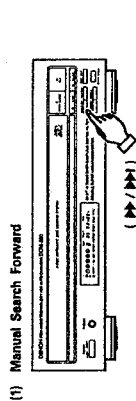

- ① Manual Search Forward
 - 1. Keep on pressing the automatic/manual search forward button (▶▶/▶▶) for more than 0.5 seconds during playback. Playback of the track is sped up.
 - As a reference, the current track number and elapsed playback time within the track are displayed.
 - Manual search forward is approximately three times faster when engaged during the pause state compared to playback. In this case, no sound is heard however.
 - If the automatic/manual search forward button (▶▶/▶▶) is kept pressed after the end of the final track on the disc is reached, (2) is displayed and manual search stops. To return to another point, press the automatic/manual search reverse button (⏪/⏩) until (2) disappears.

② Manual Search in Reverse

- 1. Keep on pressing the automatic/manual search reverse button (⏪/⏩) for more than 0.5 seconds during playback. Reverse playback of the track is sped up.
- As a reference, the current track number and elapsed playback time within the track are displayed.
- Manual search in reverse is approximately three times faster when engaged during the pause state compared to playback. In this case, no sound is heard however.
- If the automatic/manual search reverse button (⏪/⏩) is kept pressed after the beginning of the first track on the disc is reached, (C) is displayed and manual search stops. To return to another point, press the automatic/manual search forward button (▶▶/▶▶) until (C) disappears.

⑩ To Cue and Stop Play [Pause] (Remote control only)

- ① Cueing by Direct Selection
 - Cueing by direct selection, then entering the Pause state, is convenient for practicing vocals with background music.

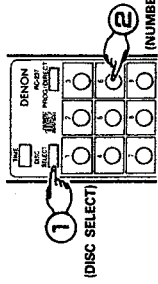

- 1. Press the Track Number buttons to set the number of the desired track.
- 2. Press the Pause (⏸ PAUSE) button.
 - To start play, press the Play (▶ PLAY) button or the Pause (⏸ PAUSE) button.

- ② Cueing by Program Selection
 - After setting the desired track selections in a program, press the Pause (⏸ PAUSE) button. The player will advance to the beginning of the 1st track in program memory and wait in the Pause state.

INSTALLATION PRECAUTIONS

The CD player uses a microcomputer for controlling internal electronic circuits. In the event that the player is used while a nearby tuner or TV is turned on, although unlikely, interference could occur either in the sound from the tuner or the picture of the TV. To avoid this, please take the following precautions.

- Keep the CD player as far away from the tuner or TV set as possible.
- Keep the power cable and connecting cable of the CD player separate from the antenna wires of the tuner and TV.
- Interference is particularly likely to occur when an indoor antenna or a 300-ohm feeder cable is used. Thus, use of an outdoor antenna and 75-ohm coaxial cable is strongly recommended.



75-ohm coaxial cable



300-ohm feeder cable

PLAY USING THE REMOTE CONTROL UNIT

The DCM-320 CD Player can be controlled from across the room using the accessory Remote Control Unit RC-237.

(1) Inserting the Dry Battery

1. Remove the cover on the back of the remote control unit.

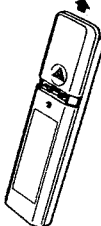

2. Insert 2 R6P (AA size) dry batteries. Check the polarity indications inside the case for correct insertion.

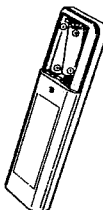

3. Replace the cover on the back of the remote control unit.

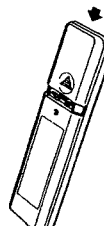

Caution Concerning Dry Batteries

- Use only R6P (AA size) dry batteries in the remote control unit.
- Depending on the frequency of use, the dry batteries should be replaced approximately once per year.
- If the remote control unit fails to control the CD Player, even before a year has passed, replace the dry batteries with new ones.
- Be sure to follow polarity indications inside the case of the battery control unit, inserting the + end and - end of each battery in the directions indicated.
- Batteries may become damaged or leak under the following conditions:
 - Using new batteries together with old ones.
 - Using different types of batteries together.
 - Do not short batteries, take them apart, subject them to heat or throw them into a fire.
- When the remote control unit is not used for a long period of time, remove the dry batteries.
- If fluid leaks from the batteries, be sure to wipe up all battery fluid inside the battery case and replace the batteries with new ones.

(2) Using the Remote Control Unit

- Aim the remote control unit toward the light receptor in the front of the CD Player, as shown in the drawing below.
- The remote control unit can be used up to a distance of 8 meters in a straight line from the CD Player. However, this distance will be shortened if there is some obstruction between the remote control unit and the light receptor, or if the beam of light is slanted.

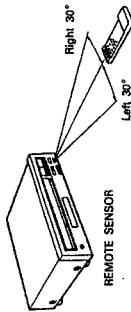

- The remote control unit has the same functions as the main unit, but the following operations cannot be done.
 1. Switching the power on and off.
 2. Adjusting headphone volume.

Caution During Use

- Do not press the operating buttons on the main unit and the remote control unit at the same time. This could cause a malfunction.
- Operation of the remote control unit will be hindered if a strong light from the sun or a light fixture is shining on the REMOTE SENSOR, or if there is an obstruction between the remote control unit and the CD player unit.

REMOTE CONTROL UNIT RC-237

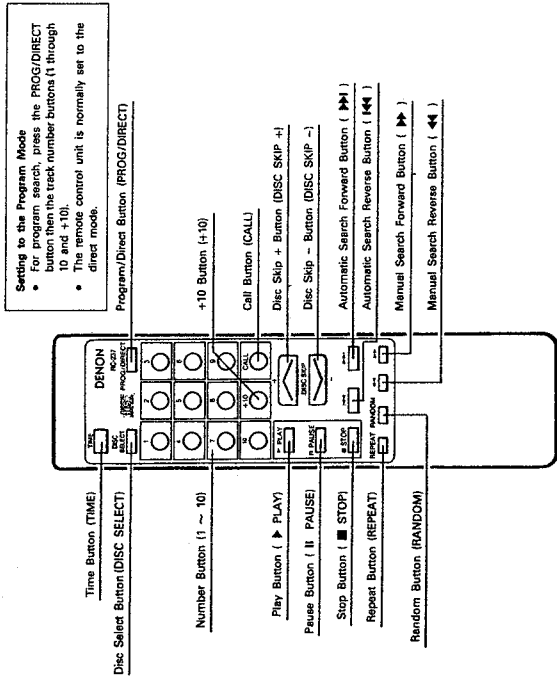

Setting to the Program Mode

- For program search, press the PROG/DIRECT button then the track number buttons (1 through 10 and +10).
- The remote control unit is normally set to the direct mode.

- **Disc Selection**
Use the DISC SELECT and number buttons to select the number of the disc to be played.
"_" appears on the disc number section of the display for 2 seconds when the DISC SELECT button is pressed. Press the number button corresponding to the number of the disc to be played while "._" is displayed to select the disc number. Track numbers are selected if the number buttons are pressed while "._" is not displayed on the disc number section of the display.
- **Direct Selection**
Normally, direct search is possible simply by pressing the desired number buttons.
- **Skipping Discs**
The Disc-Skip button (DISC SKIP +, -) will not function in the random and program modes. During disc sequential random playback, when the Disc Skip + button is pressed, the following disc is played in random order.
- **Program Selection (During playback, the track which is currently playing is programmed at the 1st track.)**
Press the PROG/DIRECT button then press the number buttons. For example, to program tracks number 3, 11, and 5, press PROG/DIRECT → 3 → +10 and 1 → 5.
To cancel the program, press the PROG/DIRECT button.
For track numbers below 9, simply press the corresponding button. For track numbers of 10 and greater, press the +10 then the number buttons.
For example, for track number 22, press +10 twice then 2.

The Time indicator indicates the amount of elapsed time for the track currently being played, the amount of time remaining for the current track and the amount of time remaining for all tracks yet to be played. Normally, the amount of elapsed time for the current track is displayed. Pressing this button once causes the [SINGLE] indicator to light up, displaying the amount of time remaining for the current track. Pressing the button once more turns the [SINGLE] indicator off and causes the [TOTAL] indicator to light up, displaying the time remaining for all tracks yet to be played on the disc. Pressing the button once again turns the [TOTAL] indicator off and causes the indicator to display the elapsed time for the current track. During playback, the total remaining time is the remaining time for the disc. For programmed playback, the remaining time for the program is only displayed when the programmed tracks are all on the same disc. In the case of 21st and subsequent tracks, the time remaining for one track is displayed "._.". When 21st and subsequent tracks is programmed, the time remaining for all tracks is displayed "._.". "._." is displayed when tracks on more than one disc are programmed.

COMPACT DISCS

1. **Cautions in Handling Compact Discs**
 - Do not get fingerprints, oil, dirt or other substances on the compact disc. If the disc becomes dirty, wipe it off with a dry, soft cloth. DENON AMC-20/21 CD Cleaner is recommended.
 - Do not clean compact discs with benzene, paint thinner, water, record spray, anti-static agent, silicon cloth or similar substances.
 - Take particular care to prevent scratches to the back side of the compact disc when removing it from the case and when inserting it in its case.
 - Do not bend compact discs.
 - Do not apply to compact discs.
 - Do not attempt to enlarge the center hole of the disc.
 - Do not write on the label (printed) side of the disc with a ball point pen or pencil.
 - Bringing a CD into a warm room from a cold place could cause moisture to condense on the disc surface. Do not attempt to dry the disc with a hair dryer, etc.
2. **Storage of Compact Discs**
 - After play, be sure to remove the disc from the player.
 - To prevent dust, scratches, deformation, etc., be sure to store compact discs in their case.
 - Do not store compact discs in the following locations.
 1. Places where direct sunlight strikes for long periods of time.
 2. Places with a high humidity or a lot of dust.
 3. Places reached by heat from a heater or similar appliance.

TROUBLE? CHECK THE PLAYER TO FIND WHAT'S WRONG

- Even when it appears that there is trouble, check the following points carefully.
- The drawer won't open/close when the Open/Close button is pressed.
 - Is the Power switch on?
 - After a disc is loaded (0 00 00, 00) is displayed in the display window.
 - Is the disc loaded correctly? See page 6, 7.
 - Play does not begin when the Play button is pressed.
 - Is the disc dirty or scratched? See page 14.
 - There is no sound, or the sound is distorted.
 - Is the output cord connected correctly to the amplifier? See page 7.
 - Does the sound return to normal when the amplifier's knobs are adjusted or the proper input device is selected?
 - The player won't go to the place specified in the search.
 - Is the disc dirty or scratched? See page 14.
 - A program cannot be played and run it correct? See page 8, 9.
 - Is the method used to make a program and run it correct? See page 8, 9.
 - The player won't operate correctly when the remote control unit is used.
 - Are the dry batteries in the remote control unit dead? See page 12.
 - Is the remote control unit located too far from the CD Player unit? See page 12.

SPECIFICATIONS

	<u>DCM-420</u>	<u>DCM-320</u>
AUDIO		
No. of Channels:	2 channels	
Frequency Response:	4 ~ 20,000 Hz	
Dynamic Range:	97 dB	96dB
Signal-to-Noise Ratio:	106 dB	102 dB
Harmonic Distortion:	0.003% (1 kHz)	0.006% (1kHz)
Separation:	100 dB (1 kHz)	98dB (1kHz)
Wow & Flutter:	Less than the measuring (+0.001% W. peak)	
Output Voltage:	FIX. 2.0 V, VARIABLE 0 ~ 2.0 V	FIX. 2.0 V
DISC USED		
	Audio compact discs 12cm (5in) and 8cm (3in) are used	
GENERAL CHARACTERISTICS		
Power Supply:	50/60 Hz, Voltage is shown on rating label.	
Power Consumption:	11W	
External Dimensions:	434 (W)× 114 (H) × 388 (D) mm (17-3/32 × 4-17/32 × 15-9/32 inches)	
Weight:	5.9 kg	5.7 kg
FUNCTIONS AND DISPLAY		
Functions:	Five discs can be used. Direct track selection Program selection, Random play, etc.	
Display:	Disc number, Track number, time (min., sec.), Play, Pause, Repeat, Random, etc.	
Others:	Headphones jack (Level Variable)	
REMOTE CONTROL UNIT		
	RC-238	RC-237
Remote Control Method:	Infrared pulse system	
Power Supply:	3 V DC; two R6P (standard size AA) dry cell batteries	
External Dimensions:	60 (W)× 177 (H)× 18 (D)mm (2-23/64 × 6-31/32 × 18-45/64 inches)	48 (W) × 177 (H)× 18 (D) mm (1-57/64 × 6-31/32 × 18-45/64 inches)
Weight:	100 g (including batteries)	
SUPPLIED ACCESSORIES		
	Pin-plug connection cord	

* Design and specifications are subject to change without notice in the course of product improvement.

NOTE FOR HANDLING OF LASER PICK-UP
DESCRIPTION OF THE COMPONENTS

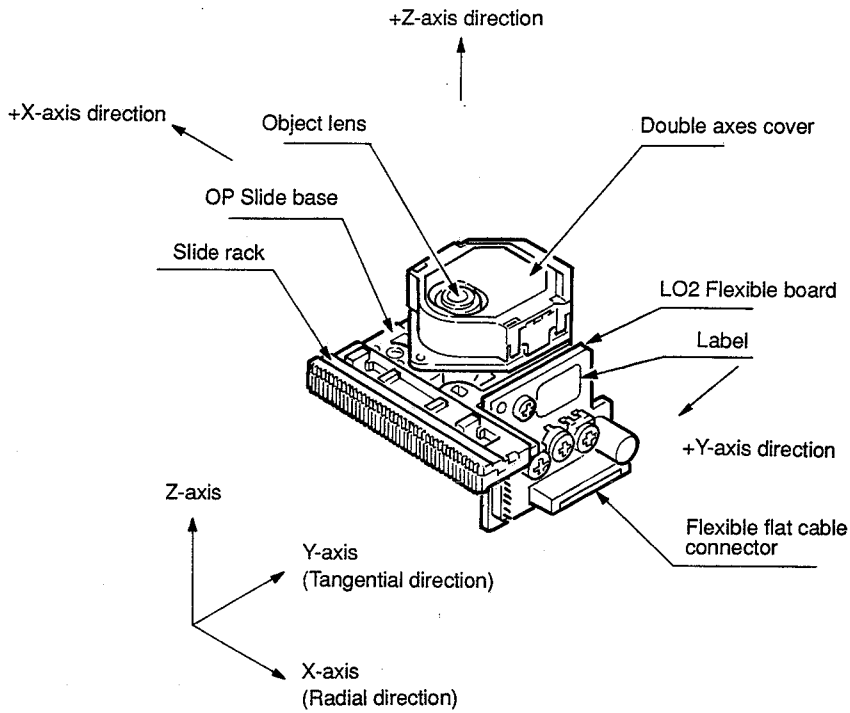

Label

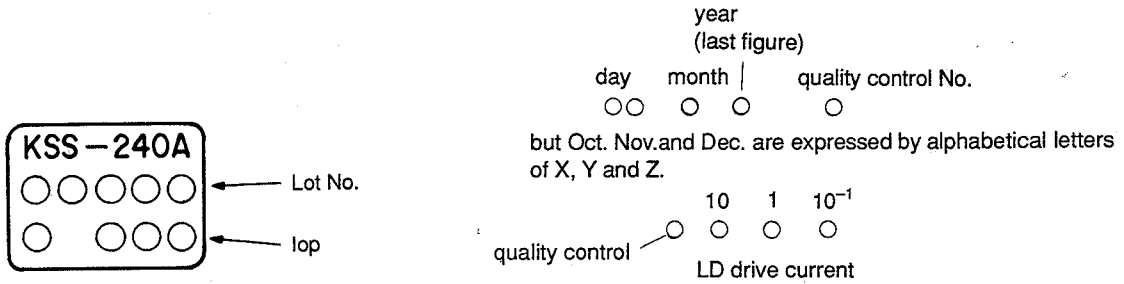

The expressed unit is by mA, with omission of the decimal point as for example, 56.5mA will be expressed as 565, but the head of English letter means the control in the manufacturing plant.

PIN CONNECTOR

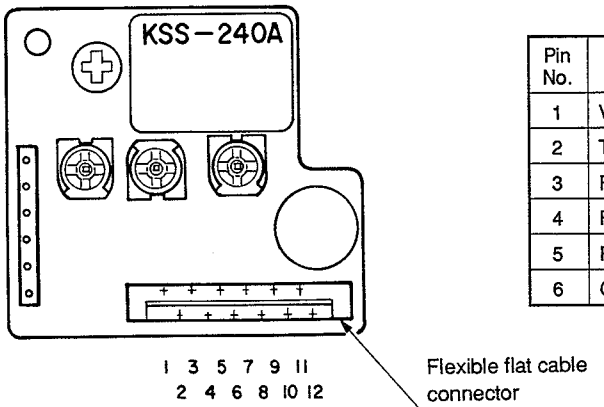

Pin No.	Description	Input/Output	Pin No.	Description	Input/Output
1	VC (+2.5V)	OUT	7	Vcc (+5V)	IN
2	TE (TRK ER signal)	OUT	8	LDC (LD Control)	IN
3	FE (FCS ER signal)	OUT	9	FCS+ (Double axes)	IN
4	FZC (FZC signal)	OUT	10	TRK+ (Double axes)	IN
5	RF (RF signal)	OUT	11	TRK- (Double axes)	IN
6	GND	IN	12	FCS- (Double axes)	IN

Caution for Handling the Laser Pick-up

The laser pick-up KSS-240A is assembled and precisely adjusted using a sophisticated manufacturing process in our plant. Do not disassemble or attempt to readjust it. Please keep the following instructions carefully in handling pick-up.

1. Handle with Care

- (1) Storage
Do not store the pick-up in dusty, high-temperature or high-humidity environments.
- (2) Please take care for preventing from shock by falling down or careless handling.

2. Laser Diode (LD)

- (1) Protect your eyes
The laser beam may damage the human eye, since the intensity of the focused spot may reach 7×10^3 W/cm² even if the intensity at the objective lens is 400 μ W maximum. As the light beam spreads after focused through the objective lens, it does not effect you in the place as far as more than 30 cms. However, do not look at the laser light beam either through the objective lens directly nor another lens or a mirror.
- (2) Poison of As
Since the LD chip contains As (Arsenic), as GaAs + GaAlAs, as known as the poison, although the poison is relatively weak, in comparing with others, e.g. As₂O₃, AsCl₃ etc., and the amount is small, avoid putting the chip in acid or an alkali solution, heating it over 200°C or putting it into your mouth.
- (3) Avoid surge current or electrostatic discharge
The LD may be damaged or deteriorated by its own strong light if a large current is supplied to it, even if only a short pulse.
Make sure that there is no surge current in the LD driving circuit by switches or else. Be careful to handle pick-up as it may be damaged in a moment by human electrostatic discharge. The pins of the LD are short-circuited by solder for protection during shipment.
For safety handling of an LD, grounding the human body, measuring equipments and jig is strongly recommended. And still it is further desirable to make use of mat on the platform and floor for handling the LD.
To open the short circuit, remove the soldering quickly with a soldering iron whose metal part is grounded.
The temperature of the soldering iron should be less than 320°C (30W).

3. Actuator

- (1) The performance of the actuator may be effected if magnetic material is located nearby, since the actuator has a strong magnetic circuit. Do not permit dust to enter through the clearance of the cover.
- (2) Cleaning the lens
It may change the specifications by attaching dust or ash on the objective lens. Clean the lens with a cleaning paper dampened with a little water, not pressing lens with so much strength by the cleaning paper.

4. Metal Bearing

As the metal bearing of Cu-compound sintered alloy is impregnated with FROIL946P (*Part No. 529 0054 007), never fail to supply the bushing with the same lubricant at the time of replacing the pick-up.

5. Handling

Please handle the laser pick-up with holding the side base (rosin molded part).

When either a part of human body or some other things may happen to touch directly with the circuit part of P.W.Board, it may cause deterioration, take careful attention in handling this base.

6. Deterioration

As KSS-240 comprises built-in RF Amp and APC circuit, it resists stronger against external electrostatic damages than the former typed pickup. However, there is possibility of pickup distortion in the following cases.

- (1) Low HF level, or with great numbers of jitters.
- (2) Tracking offset (EF Balance) is out of order (Refer to "Confirmation Method of Adjustment " for confirmation on (1) and (2)).

DISASSEMBLY

● Top Cover

Remove 4 screws from both sides and 1 screw from Rear Panel and slide Top Cover slightly background (approx. 5mm) and pull it up.

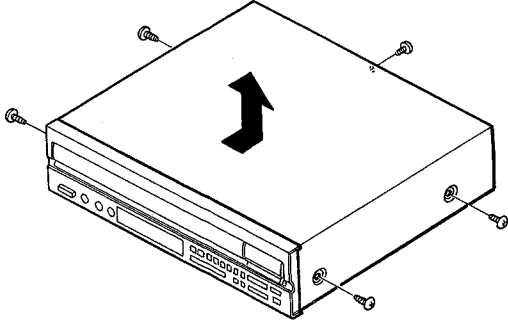

● PU Mechanism

After removing rear panel, remove 1 screw.

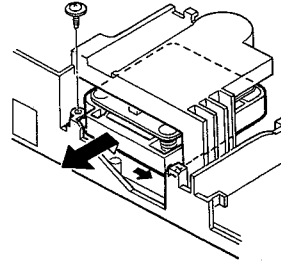

● Front Panel

1. Remove 3 hooks from bottom surface of unit.
2. Remove screws fixing front bracket and detach sub-panel from hook of the front bracket.

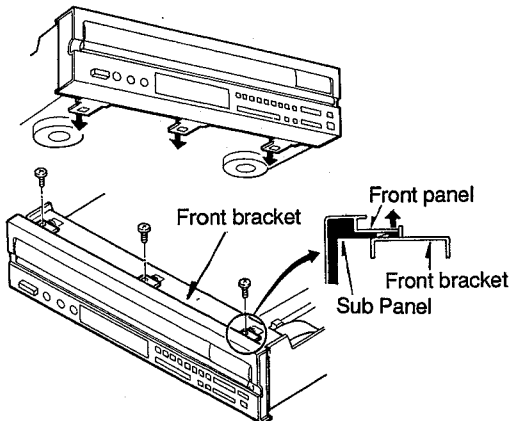

● Bottom Cover

1. Remove 3 screws fixing foot and 1 screw fixing bottom cover and 3 screws fixing rear panel, 6 in total. (These screws are P-tight type). Do not remove screws marked with ★. (This screw is S-tight type)

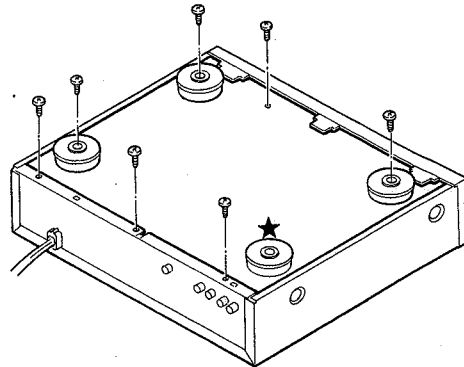

● Loader Frame Ass'y

1. Remove hooks of loader frame, and pull out 2 loader brackets from right and left sides.
2. Pull the loader frame assembly frontward.

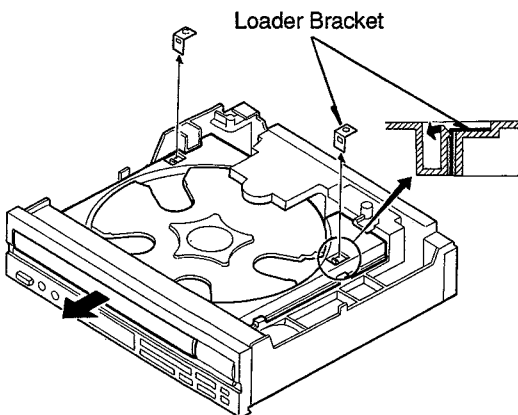

2. ① Slide the bottom cover backward (approx. 5mm) and when it touches the rear panel in end, ② lift up front portion of the bottom cover and pull it.

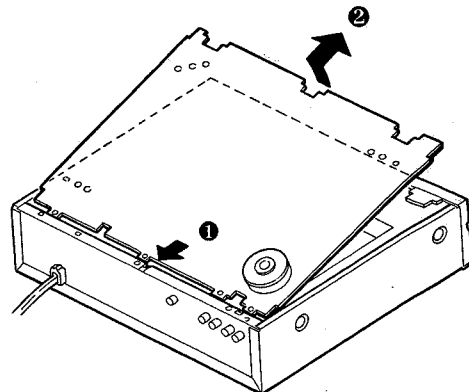

ADJUSTMENT

Microcomputer built in the unit, comprises service program to facilitate servo adjustment by pushing operation button.

1. Start service program

- (1) Turn power switch OFF.
- (2) Shortcircuit J184 (SWOP) and J185 (SWCL) of TP102 on P.W.B. (Main Unit)
(Caution) Do not touch other jumper wires.
- (3) Turn power switch ON.
(Service program starts, and displays track number 01)

(Caution)

- When service program started normal operation of buttons will be defeated.

2. Service program function • Make sure a disc has been loaded in the NO.1 disc tray.

Button	Function	Description
▲ OPEN/CLOSE	Opens or closes the disc holder.	<ul style="list-style-type: none"> ● Opens or closes only when disc is stopped. ● Operate other keys after open or close.
■ STOP	Stops system function.	<ul style="list-style-type: none"> ● Displays track number 01. ● Push when adjustment completed, or do it again.
▶ PLAY	Starts focus servo and disc turns.	<ul style="list-style-type: none"> ● Push when adjust tracking offset. ● When completed, displays track number 02.
⏸ PAUSE	Starts focus servo, tracking servo, slide servo, spindle servo.	<ul style="list-style-type: none"> ● When PAUSE button is pushed, starts tracking servo and slide servo. ● When completed, track number 03.
Other button	No normal operation.	<ul style="list-style-type: none"> ● Do not operate buttons other than above. ● If misoperated, immediately turn power switch OFF.

(Caution)

- Do not use remote control during service program mode.

3. Adjustment

(1) Location

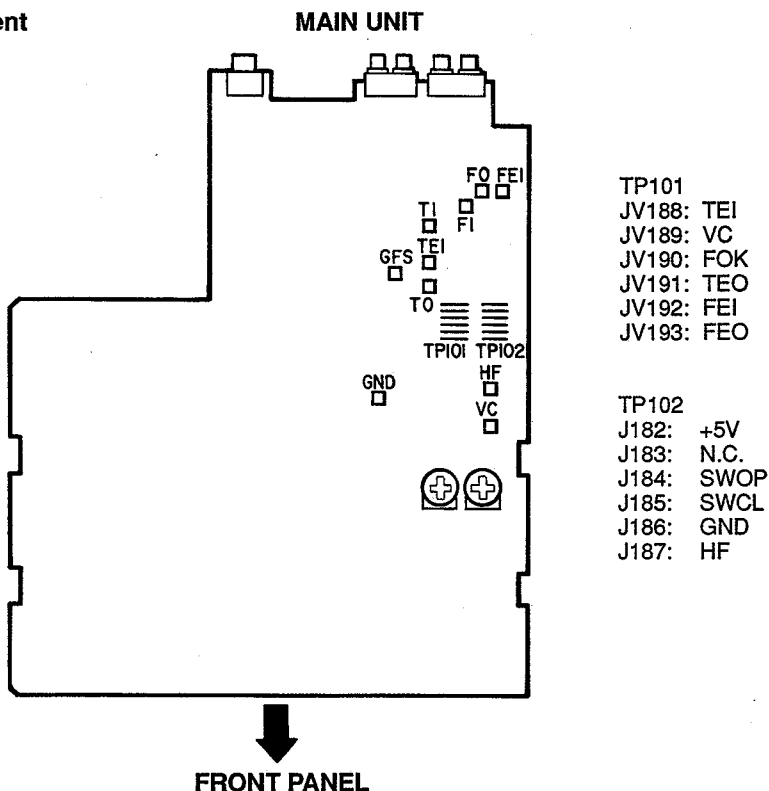

(Caution)

- When playing back in state of open top cover, there may be possibility of playback failure due to light entering into disc detection sensor.
In such case, shield the light by hand or others so that the light does not come into sensor.

(2) Necessary equipment for adjustment

1. Dual trace oscilloscope
2. Reference disc (CA-1094) 富田靖子
3. Oscillator (10 Hz ~ 10 kHz, 0 ~ 3 Vp-p)
4. Frequency counter (readable more than 5 KHz)

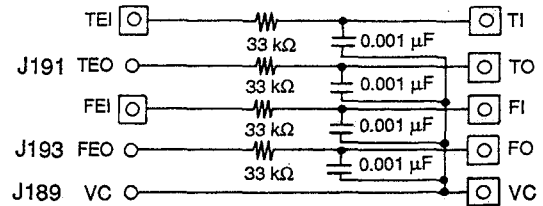

" □ " is Terminal Pin on Main Unit.

(Filter for measurement in Main Unit)

(3) Preset

1.	Start service program.	
2.	Preset VR101, 102 as per right figure.	<p>VR101 (F-GAIN) 12 O'clock</p> <p>VR102 (T-GAIN) 12 O'clock</p>
3.	Step.	<p>1. Focus gain (VR101)</p> <p>2. Tracking gain (VR102)</p>

4. Focus gain

Connection

Oscillator	Counter	Oscilloscope	Adjust	Check	Step
930 Hz 4 Vp-p (±0.1 V)	930 Hz	V H	(Volume) VR101	(Oscilloscope)	<ol style="list-style-type: none"> 1. Push PAUSE (Displays track number 03) 2. Connect oscillator. 3. Set oscillator to 930 Hz/4 Vp-p. 4. Switch oscilloscope input to X-Y mode. 5. Adjust VR101 [F-GAIN] to symmetrize Lissajous figures to X-Y axes.
		<ul style="list-style-type: none"> ● DC range ● X-Y mode 		<p>Y axis</p> <p style="text-align: right;">X axis</p> <p style="text-align: center;">Phase 90°</p> <p>Waveform not right</p> <p>Y axis</p> <p style="text-align: right;">X axis</p>	

5. Tracking gain

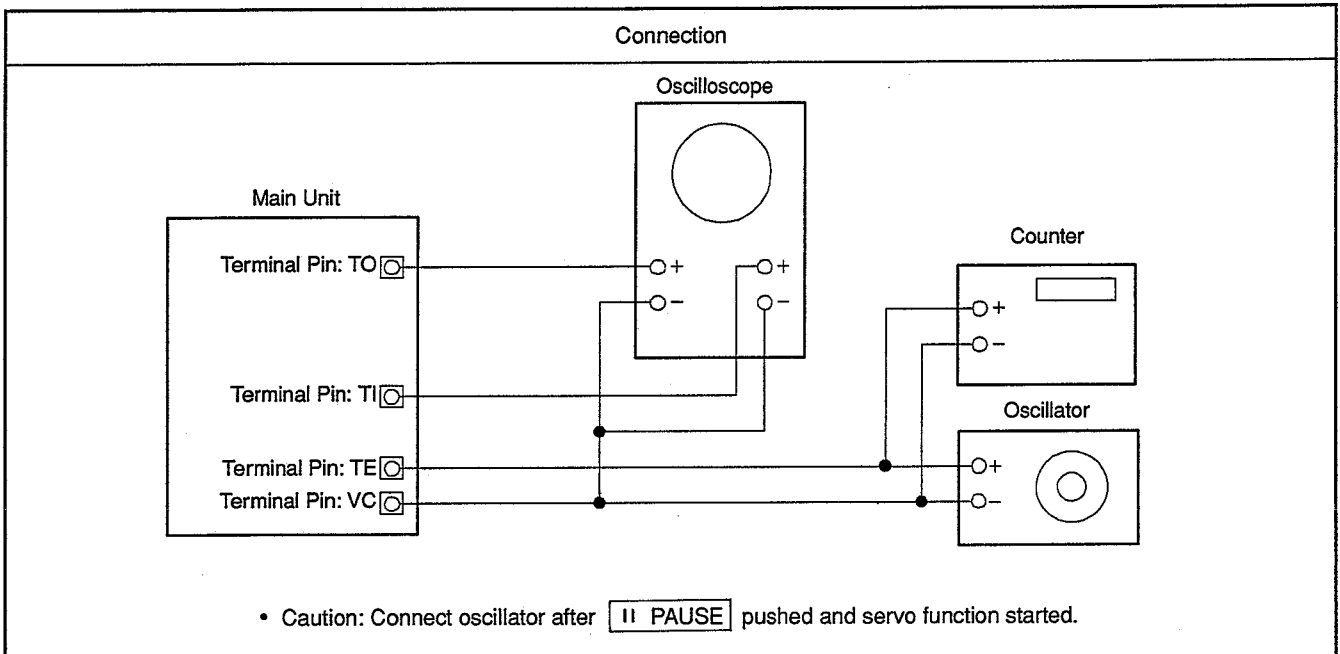

Oscillator	Counter	Oscilloscope	Adjust	Check	Step		
<ul style="list-style-type: none"> ● 2.9 kHz (±120 Hz) ● 1.5 Vp-p (±0.1V) 	2.9 kHz (±120 Hz)	<table border="1" style="width: 100%; border-collapse: collapse;"> <tr> <td style="text-align: center;">V</td> <td style="text-align: center;">H</td> </tr> </table> <ul style="list-style-type: none"> ● DC range ● X-Y mode 	V	H	VR102 (Volume)	(Oscilloscope) Y axis X axis Phase 90° Waveform not right X axis Y axis	<ol style="list-style-type: none"> 1. Push II PAUSE . (Displays track number 03) 2. Connect oscillator. 3. Set oscillator to 2.9 kHz/1.5 Vp-p. 4. Switch oscilloscope input to X-Y mode. 5. Adjust VR102 [T-GAIN] to symmetrize Lissajous figures to X-Y axes.
V	H						

6. Tracking offset (E/F Balance)

Connection			
Oscilloscope		Check	Step
V	H	(Oscilloscope)	<ol style="list-style-type: none"> 1. Push ▲ OPEN/CLOSE and load disc holder reference disk. 2. Push ▲ OPEN/CLOSE and close disc holder. 3. Push ▶ PLAY to turn disc. (Displays track number 02) 4. Short (+)(-) of oscilloscope and check the base line. 5. Confirm that upper and lower amplitude of the waveform is symmetric against 0V.
0.1v/div	1~2 ms/div	$\frac{A - B}{A + B} < 20\%$	

7. HF level

Connection			
Oscilloscope		Check	Step
V	H	(Oscilloscope)	<ol style="list-style-type: none"> 1. Push PAUSE. (Displays track number 03) 2. Check HF level of oscilloscope. 3. Confirm that the waveform is in good shape. (◇ pattern in center must be able to discriminate clearly.)
50mv/div or 20mV/div	0.2μ/div or 0.5μ/div	$A = 1.2 + 0.3V_{p-p}$	
<ul style="list-style-type: none"> • Set input mode to ALTERNATE or CHOPPER. 			

HEAT RUN MODE FUNCTION

Heat Run Mode

1) To activate

While hold pushing RANDOM, REPEAT, DISC SKIP keys simultaneously, turn the unit power on. The remote control sensor indicator will light to show that the unit is shifted in Heat Run mode.

Be sure to load the disc previously.

Press the disc holder open/close button (▲ OPEN/CLOSE) to cancel Heat Run mode.

★ This mode functions only for a disc with 21 pieces of music or more. For a disc with 20 pieces of music or lesser, please do not use.

2) Operation

During the Heat Run mode to shift the unit in Play mode makes the unit replays from the first music after opens the loader once and re-closes it when finish playing the last track (comes into lead out).

Hereafter, operates open/close of loader, servo on, reading of TOC, and playing repeatedly, and repeats playing the two tracks; the first and the last ones.

3) Error Message

When the system error occurs while in Heat Run mode, the following error message will display on the Track No. indicator and stops operation.

1. E1

At the time of Focus Servo does not activate.

2. E2

When unable to detect synchronous pattern however the disc is in rotating. (GFS does not drive.)

3. E3

No synchronous pattern can be detected while in Play mode. (No GFS drives.)

4. E4

When TOC is unreadable in despite of servo is activated.

5. E5

In case of loader malfunctions. (Unable to turn on the switch.)

6. E6

The inner circle switch of Pick-up does not turn off.

7. E7

The inner circle switch of Pick-up does not turn on.

8. E10

Improper function of Pick-up base UP/ DOWN.

9. E11

Improper function of disc Select.

★ The number of operation up to the stop will be displayed on the minute and second portion of the indicator.

IC TERMINAL FUNCTION LIST

CXD2500AQ Terminal Function

Terminal No.	Symbol	I/O		Terminal Function
1	FOK	I		Input terminal for OK focussing. Use for Servo-autosequencer.
2	FSW	O	Z,0	Output to shift time constant of output filter for spindle motor.
3	MON	O	1,0	ON/OFF control output for spindle motor.
4	MDP	O	1,Z,0	Servo control for spindle motor.
5	MDS	O	1,Z,0	Servo control for spindle motor.
6	LOCK	O	1,0	Sampling GFS by 460 Hz and if it is "H", delivers "H"; if it is continuously "L" 8 times, delivers "L".
7	NC		—	
8	VCOO	O	1,0	Oscillation current output for analog EFM PLL.
9	VCOI	I		Oscillation current output for analog EFM PLL. f LOCK=8.6436MHz.
10	TEST	I		TEST output. Normally GND.
11	PDO	O	1,Z,0	Charge pump output for analog EFM PLL.
12	Vss			GND.
13	NC		—	
14	NC		—	
15	NC		—	
16	VPCO	O	1,Z,0	Charge pump output for variable pitch PLL.
17	VCKI	O		Clock input from external VCO for variable pitch. fc center=16.9344MHz.
18	FILO	O	Analog	Filter output for master PLL. (slave=digital PLL)
19	FILI	I		Filter input for master PLL.
20	PCO	O	1,Z,0	Charge pump output for master PLL.
21	AVss			Analog GND.
22	CLTV	I		Control voltage input for master VCO.
23	AVDD			Analog power supply (+5V).
24	RF	I		EFM signal input.
25	BIAS	I		Constant-current input for Asymmetry circuit.
26	ASYI	I		Compare voltage input for Asymmetry.
27	ASYO	O	1,0	Full swing output for EFM. (L=Vss, H=VDD).
28	ASYE	I		L: Asymmetry circuit → OFF. H: Asymmetry circuit → ON.
29	NC		—	
30	PSSL	I		Input to shift output mode of audio data. Serial output at L; parallel output at H.
31	WDCK	O	1,0	D/A Interface for 48 bit slot. Word-clock f=2 Fs.
32	LRCK	O	1,0	D/A Interface for 48 bit slot. LR-clock f= Fs.
33	VDD			Power supply (+5V).
34	DA16	O	1,0	At PSSL=1 for DA16 (MBS) output; PSSL=0 for serial data of 48 bit slot. (2s'COMP, MSB first).
35	DA15	O	1,0	At PSSL=1 for DA15 output; PSSL=0 for bit clock of 48 bit slot.
36	DA14	O	1,0	At PSSL=1 for DA14 output; PSSL=0 for serial data of 64 bit slot. (2s'COMP, LSB first).
37	DA13	O	1,0	At PSSL=1 for DA13 output; PSSL=0 for bit clock of 64 bit slot.
38	DA12	O	1,0	At PSSL=1 for DA12 output; PSSL=0 for LR clock of 64 bit slot.
39	DA11	O	1,0	At PSSL=1 for DA11 output; PSSL=0 for GTOP output.
40	DA10	O	1,0	At PSSL=1 for DA10 output; PSSL=0 for XUGF output.
41	DA09	O	1,0	At PSSL=1 for DA09 output; PSSL=0 for XPLCK output.
42	DA08	O	1,0	At PSSL=1 for DA08 output; PSSL=0 for GFS output.
43	DA07	O	1,0	At PSSL=1 for DA07 output; PSSL=0 for RFCK output.
44	DA06	O	1,0	At PSSL=1 for DA06 output; PSSL=0 for C2PO output.
45	DA05	O	1,0	At PSSL=1 for DA05 output; PSSL=0 for XRAOF output.
46	DA04	O	1,0	At PSSL=1 for DA04 output; PSSL=0 for MNT3 output.
47	DA03	O	1,0	At PSSL=1 for DA03 output; PSSL=0 for MNT2 output.
48	DA02	O	1,0	At PSSL=1 for DA02 output; PSSL=0 for MNT1 output.
49	DA01	O	1,0	At PSSL=1 for DA01 output; PSSL=0 for MNT0 output.
50	APTR	O	1,0	Control output for aperture compensation. In H for R-ch.
51	APTL	O	1,0	Control output for aperture compensation. In H for L-ch.

Terminal No.	Symbol	I/O	Terminal Function
52	Vss		GND.
53	XTAI	I	X'tal oscillation circuit input. By selecting of mode, f=16.9344MHz or 33.8688MHz.
54	XTAO	O 1,0	X'tal oscillation circuit input. f=16.9344MHz.
55	XTSL	I	Selection input terminal of X'tal. "L" for X'tal 16.9344MHz; H for 33.8688MHz.
56	FSTT	O 1,0	2/3 Dividing output of 53 and 54 terminal. No change by variable pitch.
57	C4M	O 1,0	4.2336MHz output. When variable pitched, simultaneously changes.
58	C16M	O 1,0	16.9344MHz output. When variable pitched, simultaneously changes.
59	MD2	I	Digital-out ON/OFF control. ON at H; OFF at L.
60	DOUT	O 1,0	Digital-out output terminal.
61	EMPH	O 1,0	When playback disc emphasized, outputs H; otherwise outputs L.
62	WFCK	O 1,0	WFCK (Write Flame Clock) output.
63	SCOR	O 1,0	Output of subcode sync. S0+S1. H output when either one detected.
64	SBSO	O 1,0	Serial output of Sub P~W.
65	EXCK	I	Clock input for SBSO read-out.
66	SQSO	O 1,0	Output for Sub Q 80 bits and PCM peak level 16 bits.
67	SQCK	I	Clock input for SQSO read-out.
68	MUTE	I	Mute at H; remove mute at L.
69	SENS	— 1,Z,0	SENS output. Outputs to CPU.
70	XRST	I	System reset input. Resets at "L".
71	DATA	I	Input of serial data from CPU.
72	XLAT	I	Input for latch from CPU. Latches serial data at release.
73	Vdd		Power supply (+5V).
74	CLOCK	I	Serial data transfer clock input from CPU.
75	SEIN	I	SENS input from SSP.
76	CNIN	I	Input of tracking pulse.
77	DATO	O 1,0	Serial data output to SSP.
78	XLTO	O 1,0	Serial data latch output to SSP.
79	CLKO	O 1,0	Serial data transfer clock output to SSP.
80	MIRR	I	Mirror signal input. Use for track jump for over 128 tracks, using autosequencer.

CXD2500AQ

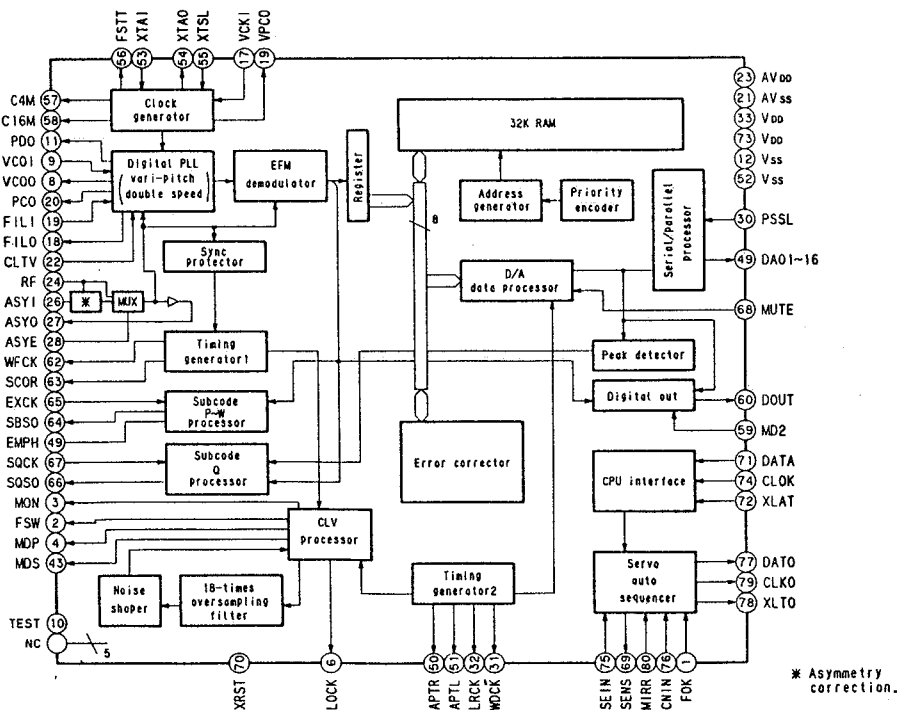

CXA1372S Terminal Function

Terminal No.	Symbol	I/O	Terminal Function
1	TE	I	Tracking error signal input terminal.
2	TDFCT	I	Capacitor connecting terminal for time constant at the time of defect.
3	ATSC	I	Input terminal of ATSC detecting window comparator.
4	FZC	I	Input terminal of focus zero-cross comparator.
5	FE	I	Focus error signal input terminal.
6	FDFCT	I	Capacitor connecting terminal for time constant at the time of defect.
7	Vc	I	Mid-point voltage input terminal.
8	FGD	I	In case of reducing higher range gain of focus servo, connect a capacitor between this terminal and terminal number (9).
9	FS3	I	Shifts higher range gain of focus servo by FS3 ON/OFF.
10	FLB	I	Terminal for external time constant to increase lower range of focus servo.
11	FEO	O	Focus drive output.
12	FE-	I	Reverse input terminal for focus amplifier.
13	SRCH	I	Terminal for external time constant to make focus search waveform.
14	TGU	I	Terminal for external time constant to shift higher range gain of tracking.
15	TG2	I	Terminal for external time constant to shift higher range gain of tracking.
17	TAO	O	Tracking drive output.
18	TA-	I	Reverse input terminal for tracking amplifier.
19	SL+	I	Non-reverse input terminal for sled amplifier.
20	SLO	O	Sled drive output.
21	SL-	I	Reverse input terminal for sled amplifier.
22	FSET	I	Terminal to compensate peak in focus/tracking phase.
23	ISET	I	Delivers a current to set the height of focus search, track jump, and sled kick.
24	SSTOP	I	Terminal for limit switch ON/OFF to detect disc innermost circle.
26	DIRC	I	Terminal is used at the time of 1 track jump. A 47 kohm pull up resistor is included.
27	LOCK	I	Reckless drive protection circuit of sled; activates at "L". A 47k ohm pull up resistor is included.
28	CLK	I	Serial data transfer clock input from CPU.
29	XLT	I	Latch input from CPU.
30	DATA	I	Serial data input from CPU.
31	XRST	I	Reset input terminal. Resets at "L".
32	C.OUT	O	Terminal to output signal for track number count.
33	SENS	O	Terminal to output FZC, AS, TZC, SSTOP by command from CPU.
35	MIRR	O	Output terminal for MIRR comparator.
36	DFCT	O	Output terminal for DEFECT comparator.
37	ASY	I	Input terminal for auto-symmetric control.
38	EFM	O	Output terminal for EFM comparator.
39	FOK	O	Output terminal for focus OK (FOK) comparator.
40	CC1	O	DEFECT bottom hold output terminal.
41	CC2	I	Input terminal to input DEFECT bottom hold output by capacitance combination.
43	CB	I	Capacitor connecting terminal for DEFECT bottom hold.
44	CP	I	MIRR hold capacitor connecting terminal. A non-reverse input terminal for MIRR comparator.
45	RFI	I	Input terminal to input RF summing amplifier output by capacitance combination.
46	RFO	O	Output terminal for RF summing amplifier. Check point for eye pattern.
48	TZC	I	Tracking zero-cross comparator input terminal.

CXA1372S

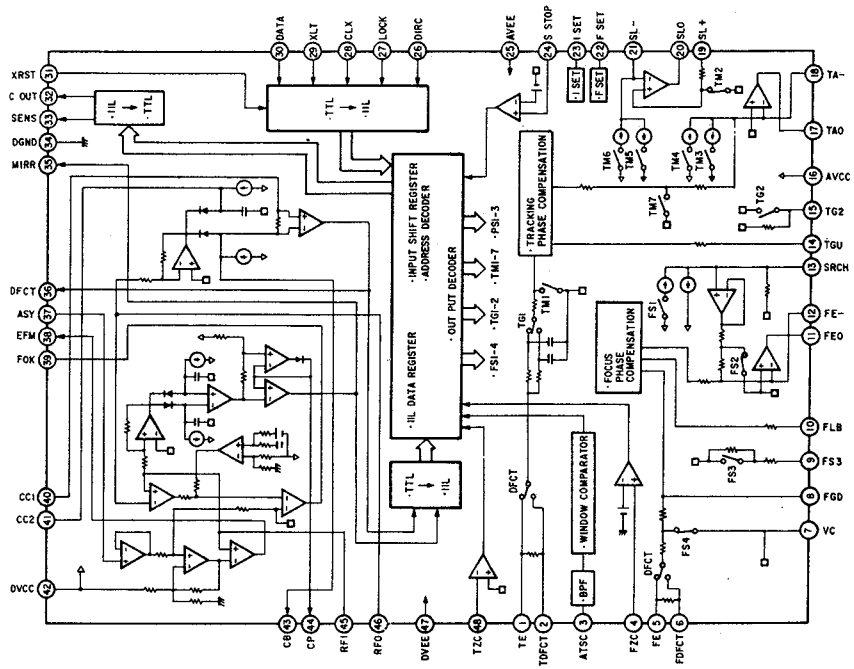

NOTE ON PARTS LIST

- Part indicated with the mark "⊙" are not always in stock and possibly to take a long period of time for supplying, or in some case supplying of part may be refused.
- When ordering of part, clearly indicate "1" and "1" (i) to avoid mis-supplying.
- Ordering part without stating its part number can not be supplied.
- Part indicated with the mark "★" is not illustrated in the exploded view.

WARNING:

Parts marked with this symbol  have critical characteristics.
Use ONLY replacement parts recommended by the manufacturer.

● **Resistors**

Ex.: RN 14K 2E 182 G FR
 Type Shape and performance Power Resistance Allowable error Others

RD : Carbon	2B : 1/8W	F : ±1%	P : Pulse-resistant type
RC : Fixed	2E : 1/4W	G : ±2%	NL : Low noise type
RS : Metallic film	2H : 1/2W	J : ±5%	NB : Non-burning type
RW : Winding	3A : 1W	K : ±10%	FR : Fuse resistor
RN : Metal film	3D : 2W	M : ±20%	F : Lead wire forming
RK : Metal mixture	3F : 3W		
	3H : 5W		

★ Resistance
 1 8 2 ⇒ 1800Ω = 1.8kΩ
 ————— Indicates number of zeros after effective number
 ————— 2-digit effective number, decimal point indicated by R.
 • Units: Ω

● **Capacitors**

Ex.: CE 04W 1H 2R2 M BP
 Type Shape and performance Dielectric strength Capacity Allowable error Others

CE : Aluminum foil electrolyte	0J : 6.3V	F : ±1%	HS : High stability type
CA : Aluminum solid electrolyte	1A : 10V	G : ±2%	BP : Non-polar type
CS : Tantalum electrolyte	1C : 16V	J : ±5%	HR : Ripple-resistant type
CQ : Film	1E : 25V	K : ±10%	DL : For charge and discharge
CK : Ceramic	1V : 35V	M : ±20%	HF : For assuring high frequency
CC : Ceramic	1H : 50V	Z : +80%	U : UL part
CP : Oil	2A : 100V	-20%	C : CSA part
CM : Mica	2B : 125V	P : +100%	W : UL-CSA type
CF : Metallized	2C : 160V	-0%	F : Lead wire forming
CH : Metallized	2D : 200V	C : ±0.25pF	
	2E : 250V	D : ±0.5pF	
	2H : 500V	= : Others	
	2J : 630V		

★ Capacity
 2 R 2 ⇒ 2.2 μF
 ————— 1-digit effective number, decimal point indicated by R.
 ————— 2-digit effective number, decimal point indicated by R.

- Units: μF, (for P, pF (μμF))
- When the dielectric strength is indicated in AC, "AC" is included after the dielectric strength value.

**PARTS LIST OF P.W. BOARD
(2U-2296/2296A) MAIN UNIT**

Ref. No.	Part No.	Part Name	Remarks
SEMICONDUCTOR GROUP			
IC102	262 1305 001	IC CXA1372S	
IC103-106	263 0565 007	IC BA15218	
IC201	262 1509 001	IC M50959-449SP	
IC202	262 1514 009	IC CXD2500AQ	
IC203	262 1510 003	IC UPD6254CX	(DCM420 only)
IC205	262 1265 002	IC TC74HU04AP	(DCM420 only)
IC300	262 1450 008	IC SM5840CP	
IC302,303	262 1409 004	IC PCM61P-L	
IC501	263 0693 005	IC M5290P	
IC502-505	268 0073 905	IC Protector ICP-N15T	
IC705-707	263 0565 007	IC BA15218	
IC708	262 0640 000	IC MN6632A	(DCM420 only)
TR101	272 0025 907	Transistor 2SB562(C)TF	
TR102	274 0036 905	Transistor 2SD468(C)TF	
TR103	272 0025 907	Transistor 2SB562(C)TF	
TR104	274 0036 905	Transistor 2SD468(C)TF	
TR105	272 0025 907	Transistor 2SB562(C)TF	
TR106	274 0036 905	Transistor 2SD468(C)TF	
TR107	272 0025 907	Transistor 2SB562(C)TF	
TR181	274 0036 905	Transistor 2SD468(C)TF	
TR181	274 0136 009	Transistor 2SD1913	
TR182	272 0025 907	Transistor 2SB562(C)TF	
TR183	274 0036 905	Transistor 2SD468(C)TF	
TR184	272 0025 907	Transistor 2SB562(C)TF	
TR185	274 0036 905	Transistor 2SD468(C)TF	
TR190	269 0040 902	Digital Tr. DTC144ES(47K-47K)	
TR501	274 0136 009	Transistor 2SD1913	
TR502	272 0093 007	Transistor 2SB1274	
TR503	271 0101 925	Transistor 2SA933(Q)T-70	
TR702	269 0014 909	Digital Tr. DTA124XS(22K-47K)	
TR703	269 0020 906	Digital Tr. DTC114ES(10K-10K)	
TR704	271 0101 925	Transistor 2SA933(Q)T-70	
TR706-709	274 0160 907	Transistor 2SD12144STPU	
TR950	271 0192 905	Transistor 2SA933S(S)	
D201-203	276 0049 914	Diode 1S2076A TE	
D204-209	276 0432 903	Diode 1SS270A TE	
D501-506	276 0550 908	Diode 1SR139-200T-62	
D507	276 0481 912	Zener Diode HZS24-2TD	
D508	276 0465 912	Zener Diode HZS7B-2TD	
D701	276 0432 903	Diode 1SS270A TE	
D950-952	276 0432 903	Diode 1SS270A	
RESISTOR GROUP			
VR101,102	211 6077 912	Adjust 20K ohm	V06PB203
VR300,301	211 6077 938	Adjust 100K ohm	V06PB104
CAPACITOR GROUP			
C103	255 1206 908	Film 0.0033 μ F/50V	CQ93M1H332JT
C104	253 1179 990	Ceramic 560pF/50V	CK45B1H561KT
C107	256 1034 937	Metallized 0.047 μ F/50V	CF93A1H473JT
C108	255 1204 900	Film 0.0022 μ F/50V	CQ93M1H222JT
C109,110	256 1034 979	Metallized 0.1 μ F/50V	CF93A1H104JT
C111,112	256 1034 979	Metallized 0.1 μ F/50V	CF93A1H104JT

Ref. No.	Part No.	Part Name	Remarks
C113	254 4337 910	Electrolytic 6.8 μ F/50V	CE04W1H6R8MT
C114	256 1035 910	Metallized 0.22 μ F/50V	CF93A1H224JT
C115	253 9036 909	Ceramic 0.1 μ F/25V	CK45-1E104ZT
C116	255 1212 905	Film 0.01 μ F/50V	CQ93M1H103JT
C118,119	253 1180 921	Ceramic 0.001 μ F/50V	CK45B1H102KT
C120	253 1181 904	Ceramic 0.01 μ F/50V	CK45F1H103ZT
C121	253 1181 904	Ceramic 0.01 μ F/50V	CK45F1H103ZT
C122,123	254 4260 919	Electrolytic 0.22 μ F/50V	CE04W1HR22MT
C124	255 1212 905	Film 0.01 μ F/50V	CQ93M1H103JT
C125	256 1034 911	Metallized 0.033 μ F/50V	CF93A1H333JT
C126	253 1181 904	Ceramic 0.01 μ F/50V	CK45F1H103ZT
C127	255 1206 908	Film 0.0033 μ F/50V	CQ93M1H332JT
C128	255 1205 909	Film 0.01 μ F/50V	CQ93M1H103T
C129	255 1209 905	Film 0.0056 μ F/50V	CQ93M1H562JT
C131	255 1212 905	Film 0.01 μ F/50V	CQ93M1H103JT
C132	253 1179 929	Ceramic 150pF/50V	CK45B1H151KT
C133	253 4536 970	Ceramic 20pF/50V	CC45SL1H200JT
C135	254 3055 918	Electrolytic 10 μ F/35V Bipolar	CE04D1V100MBPT
C136	253 4443 908	Ceramic 200pF/50V	CC45SL1H201JT
C138	253 9036 909	Ceramic 0.1 μ F/25V	CK45-1E104ZT
C139	253 4537 979	Ceramic 51pF/50V	CC45SL1H510JT
C142	253 4537 979	Ceramic 51pF/50V	CC45SL1H510JT
C160,161	253 1180 921	Ceramic 0.001 μ F/50V	CK45B1H102KT
C162,163	253 1180 921	Ceramic 0.001 μ F/50V	CK45B1H102KT
C175	256 1034 979	Metallized 0.1 μ F/50V	CF93A1H104JT
C176	253 1181 904	Ceramic 0.01 μ F/50V	CK45F1H103ZT
C180	253 4536 941	Ceramic 15pF/50V	CC45SL1H150JT
C181	253 4538 910	Ceramic 75pF/50V	CC45SL1H750JT
C182	253 4536 941	Ceramic 15pF/50V	CC45SL1H150JT
C200	253 4538 949	Ceramic 100pF/50V	CC45SL1H101JT
C201	253 9036 909	Ceramic 0.1 μ F/25V	CK45-1E104ZT
C202	253 1181 904	Ceramic 0.01 μ F/50V	CK45F1H103ZT
C203	253 1181 904	Ceramic 0.01 μ F/50V	CK45F1H103ZT
C210	256 1034 937	Metallized 0.047 μ F/50V	CF93A1H473JT
C211	253 1180 947	Ceramic 0.0015 μ F/50V	CK45B1H152KT
C212	253 9036 909	Ceramic 0.1 μ F/25V	CK45-1E104ZT
C223,224	253 4535 955	Ceramic 5pF/50V	CC45SL1H050CT
C253	254 4254 954	Electrolytic 220 μ F/16V	CE04W1C221MT
C302,303	253 1180 905	Ceramic 680pF/50V	CK45B1H681KT
C304,305	253 1121 906	Ceramic 0.0056 μ F/50V	CK45B1H562KT
C306	253 1179 961	Ceramic 330pF/50V	CK45B1H331KT
C310	253 1181 904	Ceramic 0.01 μ F/50V	CK45F1H103ZT
C311	253 1181 904	Ceramic 0.01 μ F/50V	CK45F1H103ZT
C312	253 1181 904	Ceramic 0.01 μ F/50V	CK45F1H103ZT
C501	254 4254 792	Electrolytic 2200 μ F/16V	CE04W1C222MC
C502	254 4255 717	Electrolytic 4700 μ F/16V	CE04W1C472MC
C503,504	254 4254 954	Electrolytic 220 μ F/16V	CE04W1C221MT
C505	254 4260 964	Electrolytic 3.3 μ F/50V	CE04W1H3R3MT
C507	254 4261 918	Electrolytic 47 μ F/50V	CE04W1H470MT
C508	254 4261 921	Electrolytic 100 μ F/50V	CE04W1H101MT
C509,510	254 4261 905	Electrolytic 33 μ F/50V	CE04W1H330MT
C511	254 4260 964	Electrolytic 3.3 μ F/50V	CE04W1H3R3MT
C704	254 4254 954	Electrolytic 220 μ F/16V	CE04W1C221MT
C708,709	253 4537 924	Ceramic 33pF/50V	CC45SL1H330JT
C710-713	254 4254 909	Electrolytic 10 μ F/16V	CE04W1C100MT
C714,715	254 4254 909	Electrolytic 10 μ F/16V	CE04W1C100MT
C720,721	254 4254 909	Electrolytic 10 μ F/16V	CE04W1C100MT

**PARTS LIST OF P.W. BOARD
(2U-2297/2297A) DISPLAY UNIT**

Ref. No.	Part No.	Part Name	Remarks
C730	253 9036 909	Ceramic 0.1μF/25V	CK45=1E104ZT
C731	254 4254 925	Electrolytic 33μF/16V	CE04W1C330MT
C733	253 1181 904	Ceramic 0.01μF/50V	CK45F1H103ZT
C900	253 9036 909	Ceramic 0.1μF/25V	CK45=1E104ZT
C910	254 3056 917	Electrolytic 1μF/50V	CE04D010MBP
C911	253 1180 921	Ceramic 0.001μF/50V	CK45B1H102KT
C950	254 4254 909	Electrolytic 10μF/16V	CE04W1C100MT

Ref. No.	Part No.	Part Name	Remarks
SEMICONDUCTOR GROUP			
TR600,601	274 0160 907	Trasistor 2SD2144STPU	
D601-608	276 0432 903	Diode 1SS270A TE	

Ref. No.	Part No.	Part Name	Remarks
CAPACITOR GROUP			
C600,601	253 1181 904	Ceramic 0.01μF/50V	CK45F1H103ZT

OTHER PARTS

X200	399 0036 013	X'tal (16.9344MHz)	(DCM-420)
X200	399 0115 002	CSA16.93MX	(DCM-320)
	231 8063 009	PULSE TRANS	(DCM-420 only)
	204 8373 001	2P PIN JACK	OUT (FIX, AVR)
	204 8356 002	1P PIN JACK	OUT (COAXIAL) (DCM-420 only)
CB101	205 0683 006	FFC CONN. BASE (12P)	
CB102	205 0343 058	5P CONN. BASE (KR-PH)	
CB103	205 0406 063	6P CONN. BASE (KR-PH)	
CB104	205 0543 036	3P CONN. BASE (YEL)	
CB105	205 0406 034	3P CONN. BASE (KR-PH)	
CB106	205 0343 032	3P CONN. BASE (KR-PH)	
CB107	205 0321 038	3P CONN. BASE (RED)	
CB108	205 0323 036	3P CONN. BASE (BLK)	
CB200	205 0491 010	31P FFC CONN. BASE	
CB501	205 0434 061	6P CONN. BASE (KR-PH)	
	205 0581 001	2P VH CONN. BASE	AC POWER
CC103	204 0359 007	6P-3P. 4P PH-PH CORD	ROULET
CC106	203 4805 033	3P PH-SAN CONN. CORD	CLAMP SW
CC107	203 4805 020	3P PH-SAN CONN. CORD	LOAD IN SW
CC108	203 4810 002	3P PH-SAN CONN. CORD	DISC SENSOR
	204 0349 004	6P PH-SAN CONN. CORD	POWER
⚠	233 5907 009	POWER TRANSFORMER(EU)	U.S.A. Canada
⚠	233 5908 008	POWER TRANSFORMER(E2)	Europe U.K.
⚠	233 5909 007	POWER TRANSFORMER(E1)	Multi Voltage
⚠	212 4698 008	Voltage Selector (D)	Multi Voltage
	278 0010 004	GL450 (OR IMAGE)	
	417 0297 105	HEAT SINK	
	212 1072 009	DETECT SW (SSCF21)	
	278 0009 002	PT491F (OR IMAGE)	

OTHER PARTS

	212 4699 900	TACT SWITCH	
	212 1039 000	1P PUSH SWITCH	POWER
	393 4107 005	FL TUBE (FIP 9CDM7)	
	499 0150 008	REMOTE SENSOR (SBX1610-52)	
	204 8364 007	HEAD PHONE JACK	
	205 0491 010	31P FFC CONN. BASE	
	205 0330 061	7P MQ CONN. BASE	
	205 0483 073	7P MQ-ST CONN. BASE	
FC601	009 0063 002	31P FFC CABLE	
	278 0006 005	PHOTO INT	
	233 0172 002	POWER MOTOR	ROULET (DCM-420 only)
	211 0684 000	V1420P22FC102	
	205 0342 032	3P CONN. BASE (KR-PH)	
	205 0355 046	4P KR CONN. BASE (L)	
	203 0422 054	1P CONTACT ASS'Y	

EXPLODED VIEW OF MECHANISM UNIT

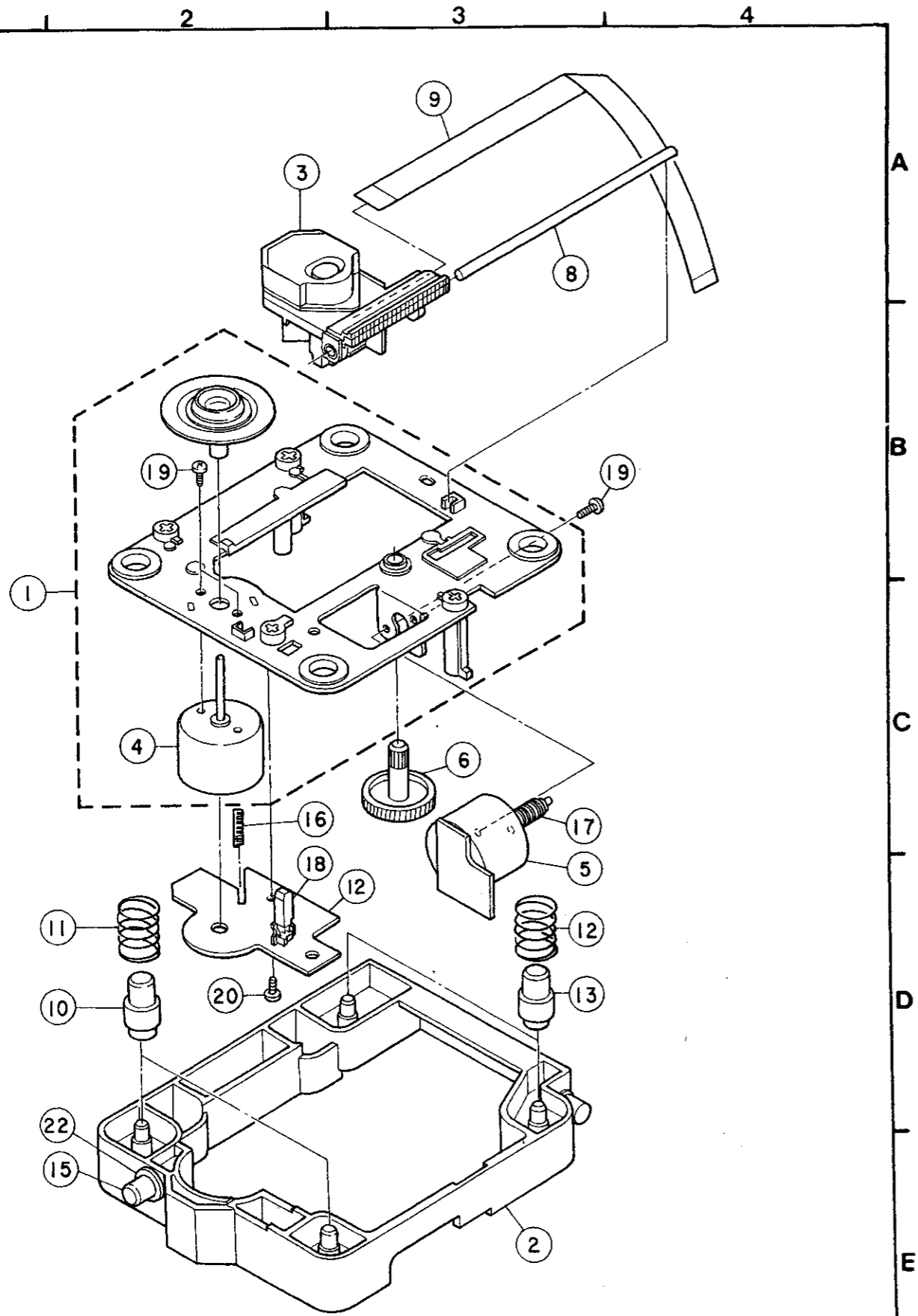

PARTS LIST OF MECHANISM EXPLODED VIEW (FG-30)

Ref. No.	Part No.	Part Name	Remarks
1	GEN 1636	SPINDLE MOTOR SUB ASS'Y	
2	GEN 1408	MECHA. FRAME SUB ASS'Y	
3	499 0191 009	LASER P.U	(KSS-240A)
5	GEN 1397	SLIDE MOTOR SUB ASS'Y	
6	424 0164 003	HELICAL GEAR	
8	443 1094 005	P.U SHAFT	
9	009 0051 001	12P. FFC	
10	462 0078 104	DAMPER	
11	463 0583 100	SPRING (F)	
12	461 0661 000	SPRING F. (R)	
12	2U- 2298	MOTOR SWITCH UNIT	
13	462 0078 117	DAMPER	
15	443 1036 005	MECHA. GUIDE PIN	
16	443 1093 006	FFC CLAMPER	
17	424 0128 007	SLIDE MOTOR	
18	212 6013 005	INNER SWITCH (PU)	
19	471 3801 039	2x3 CBS-Z SCREW	
20	473 7505 010	2.6x6 CBTS(P)-Z SCREW	
22		WASHER	

EXPLODED VIEW

1 2 3 4 5 6 7 8

A
B
C
D
E

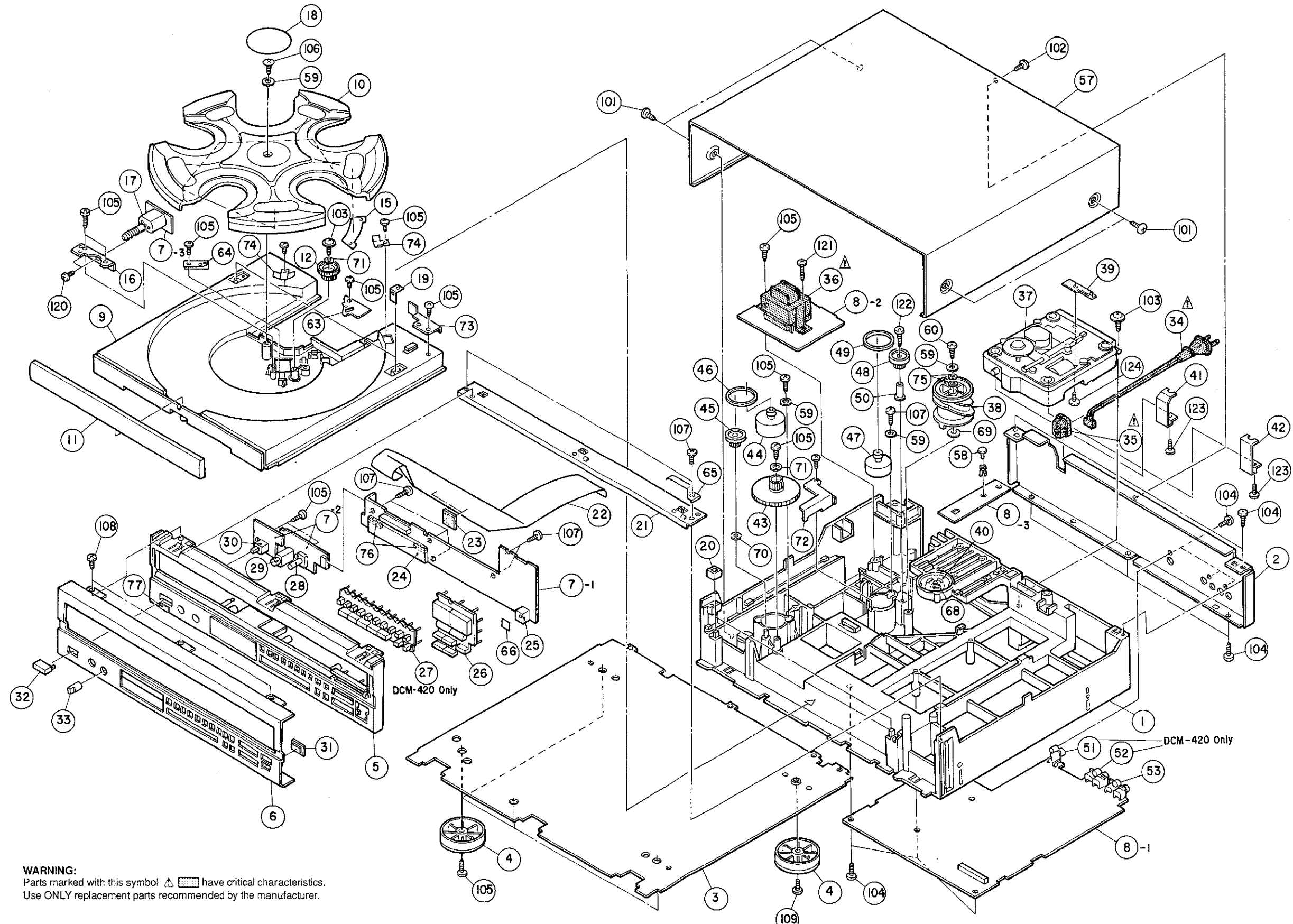

WARNING:
 Parts marked with this symbol  have critical characteristics.
 Use **ONLY** replacement parts recommended by the manufacturer.

PARTS LIST OF EXPLODED VIEW (DCM-420/320)

Ref. No.	Part No.	Part Name	Remarks
⊙ 1	103 1483 404	MECHA. CHASSIS	
⊙ 2	105 0988 100	REAR PANEL	(DCM-420) U.S.A.
⊙	105 0988 142	REAR PANEL	(DCM-420) Canada
⊙	105 0988 155	REAR PANEL	(DCM-420) Europe U.K.
⊙	105 0988 113	REAR PANEL	(DCM-420) Asia (Multi. Voltage)
⊙	105 0988 126	REAR PANEL	(DCM-320) U.S.A.
⊙	105 0988 168	REAR PANEL	(DCM-320) Canada
⊙	105 0988 171	REAR PANEL	(DCM-320) Europe U.K.
⊙	105 0988 139	REAR PANEL	(DCM-320) Asia (Multi. Voltage)
⊙ 3	105 0989 400	BOTTOM COVER	
4	104 0208 007	FOOT ASS'Y	
⊙ 5	103 1487 303	SUB PANEL ASS'Y	
⊙ 6	144 2137 006	FRONT PANEL	(DCM-420)
⊙	146 1307 008	FRONT PANEL	(DCM-320)
⊙	2U-2297	DISPLAY UNIT	(DCM-420)
⊙	2U-2297 A	DISPLAY UNIT	(DCM-320)
⊙ 7-1		DISPLAY UNIT	
⊙ 7-2		HEADPHONE UNIT	
⊙ 7-3		ROULETTE MOTOR UNIT	
⊙ 8	2U-2296	P.W.B. UNIT	(DCM-420)
⊙	2U-2296 A	P.W.B. UNIT	(DCM-320)
⊙ 8-1		MAIN UNIT	
⊙ 8-2		POWER TRANS. UNIT	
⊙ 8-3		ROULETTE SENSOR UNIT	
⊙ 9	431 0313 108	LOADER FRAME	
⊙ 10	421 0593 109	ROULETTE	
11	146 1297 008	LOADER PANEL	
12	424 0174 103	HERICAL GEAR	
⊙ 15	461 0689 008	HIMERON SHEET	
⊙ 16	412 3349 107	MOTOR BRACKET	
17	GEN 1682	ROULETTE MOTOR SUB ASS'Y	
⊙ 19	412 3350 109	LOADER BRACKET	
⊙ 20	461 0659 009	LOADER STOPPER	
⊙ 21	412 3348 108	FRONT BRACKET	
22	009 0063 002	31P FFC CABLE	
24	393 4107 005	FL TUBE (FIP 9CDM7)	
25	499 0150 008	REMOTE SENSOR (SBX1610-52)	
26	113 1462 202	FUNCTION KNOB	
27	113 1461 009	SERIES KNOB	(DCM-420 Only)
28	211 0684 000	VOLUME (V1420P22FC102)	
29	204 8364 007	HEADPHONE JACK	
30	212 1039 000	1P PUSH SWITCH	POWER
⊙ 31	143 0504 007	REMOTE SENSOR WINDOW	
32	113 1357 207	POWER SWITCH KNOB	
33	112 0645 108	HEADPHONE KNOB	
△ 34	206 2086 002	AC CORD WITH CONNECTOR	U.S.A. Canada
△	206 2089 009	AC CORD WITH CONNECTOR	Europe
△	206 2090 001	AC CORD WITH CONNECTOR	U.K.
△	206 2088 000	AC CORD WITH CONNECTOR	Asia (Multi. Voltage)
△ 35	445 0056 008	CORD BUSH	
△ 36	233 5907 009	POWER TRANSFORMER	U.S.A. Canada
△	233 5908 008	POWER TRANSFORMER	Europe U.K.
△	233 5909 007	POWER TRANSFORMER	Asia (Multi. Voltage)
37	FG-30	CD MECHA. UNIT	
38	424 0172 105	CLAMPING CAM	

Ref. No.	Part No.	Part Name	Remarks
⊙ 39	421 3447 009	REAR BRACKET	
40	GEN 1395	CLAMP FERRO SUB ASS'Y	
⊙ 41	412 3441 018	FG BRACKET (2)	
⊙ 42	421 3441 005	FG BRACKET	
43	424 0173 104	LOADING GEAR	
44	GEN 1680	LOADING MOTOR SUB ASS'T	
45	424 0130 011	PULLEY GEAR	
46	423 0061 006	BELT	
47	GEN 1678	CLAMP MOTOR SUB ASS'Y	
48	424 0130 008	PULLEY GEAR	
49	423 0061 006	BELT	
⊙ 50	443 1161 006	COLLAR	
51	204 8356 002	1P PIN JACK (DCM-420 Only)	
52	204 8373 001	2P PIN JACK (DCM-420 Only)	
53	204 8373 001	2P PIN JACK	
56	424 0093 116	WORM GEAR ASS'Y	
⊙ 57	102 0479 005	TOP COVER	
58	477 0096 007	PUSH RIVET	
59	475 1005 017	4W WASHER	
60	473 7501 014	3x14 CBTS(P)-Z SCREW	
⊙ 63	412 3442 004	BLIND PLATE	
⊙ 64	461 0690 000	MOTOR SPRING	
⊙ 65	412 3400 004	EARTH PLATE	
⊙ 66	143 0568 001	FILTER	
⊙ 67	421 0574 306	CLAMPER PRESS	
⊙ 68	441 1404 000	SPACER	(See *)
69	441 1401 016	WASHER	(See *)
70	441 1401 003	WASHER	
71	441 1401 045	WASHER	
⊙ 72	412 3446 000	CAM STOPPER	
⊙ 73	412 3449 007	LOADER (R) BRACKET	
⊙ 74	441 1402 002	ROULETTE STOPPER	
75	475 1003 006	3W WASHER	(See *)
⊙ 76	461 0580 000	RUBBER PAD	
⊙ 77	122 0154 007	HIMERON SHEET	
101	473 7509 016	4x10 CBTS(P)-B SCREW	
102	473 7015 018	3x8 CBTS(S)-B SCREW	
103	477 0262 006	SPECIAL SCREW	
104	473 7508 017	3x10 CBTS(P)-B SCREW	
106	473 7512 016	3x12 CFTS(P)-B SCREW	
108	473 7002 021	3x8 CBTS(S)-B SCREW	
109	473 7002 018	3x8 CBTS(S)-Z SCREW	
120	471 8301 039	2x3 CBS-Z SCREW	
121	473 7500 060	3x18 CBTS(P) SCREW	
122	473 7508 059	3x20 CBTS(P)-B SCREW	
123	473 7500 015	3x8 CBTS(P)-Z SCREW	
124	471 3303 016	3x6 CBS-Z SCREW	

WARNING:

- Parts marked with △ and/shading have special characteristics important to safety. Be sure to use the specified parts for replacement.
- Part indicated with the mark ⊙ are not always in stock and possibly to take a long period of time for supplying, or in some case supplying of part may be refused.
- * DCM420: Serial No. 1061505031 (only for Mecha. Chassis No. 103 1483 307) and after → not used. (Mecha. Chassis No. 103 1483 404-)
- * DCM320: Serial No. 1061506001 (only for Mecha. Chassis No. 103 1483 307) and after → not used. (Mecha. Chassis No. 103 1483 404-).

PARTS LIST OF PACKING & ACCESSORIES (DCM-420)

Ref. No.	Part No.	Part Name	Remarks	Q'ty
	504 0092 060	STYRENE PAPER	AC CORD	1
	505 0102 089	STYRENE PAPER		1
	503 0970 008	CUSHION		2
	501 1543 001	CARTON CASE		1
	505 8006 019	ENVELOPE		1
	511 2193 004	INST. MANUAL (1)	U.S.A. U.K. Multi. Voltage	1
	511 2194 003	INST. MANUAL (8)	Canada Europe	1
	203 6305 007	2P PIN CORD		1
	499 0211 002	REMOTE CONTROLLER	RC-238	1
△	203 3667 007	PLUG ADAPTER	Multi. Voltage Models Only	1

PARTS LIST OF PACKING & ACCESSORIES (DCM-320)

Ref. No.	Part No.	Part Name	Remarks	Q'ty
	504 0092 060	STYRENE PAPER	AC CORD	1
	505 0102 089	STYRENE PAPER		1
	503 0970 008	CUSHION		2
	501 1543 014	CARTON CASE		1
	505 8006 019	ENVELOPE		1
	511 2205 002	INST. MANUAL (1)	U.S.A. U.K. Multi. Voltage	1
	511 2206 001	INST. MANUAL (8)	Canada Europe	1
	203 6305 007	2P PIN CORD		1
	499 0214 009	REMOTE CONTROLLER	RC-237	1
△	203 3667 007	PLUG ADAPTER	Multi. Voltage Models Only	1

P.W.BOARD
2U-2296 MAIN UNIT

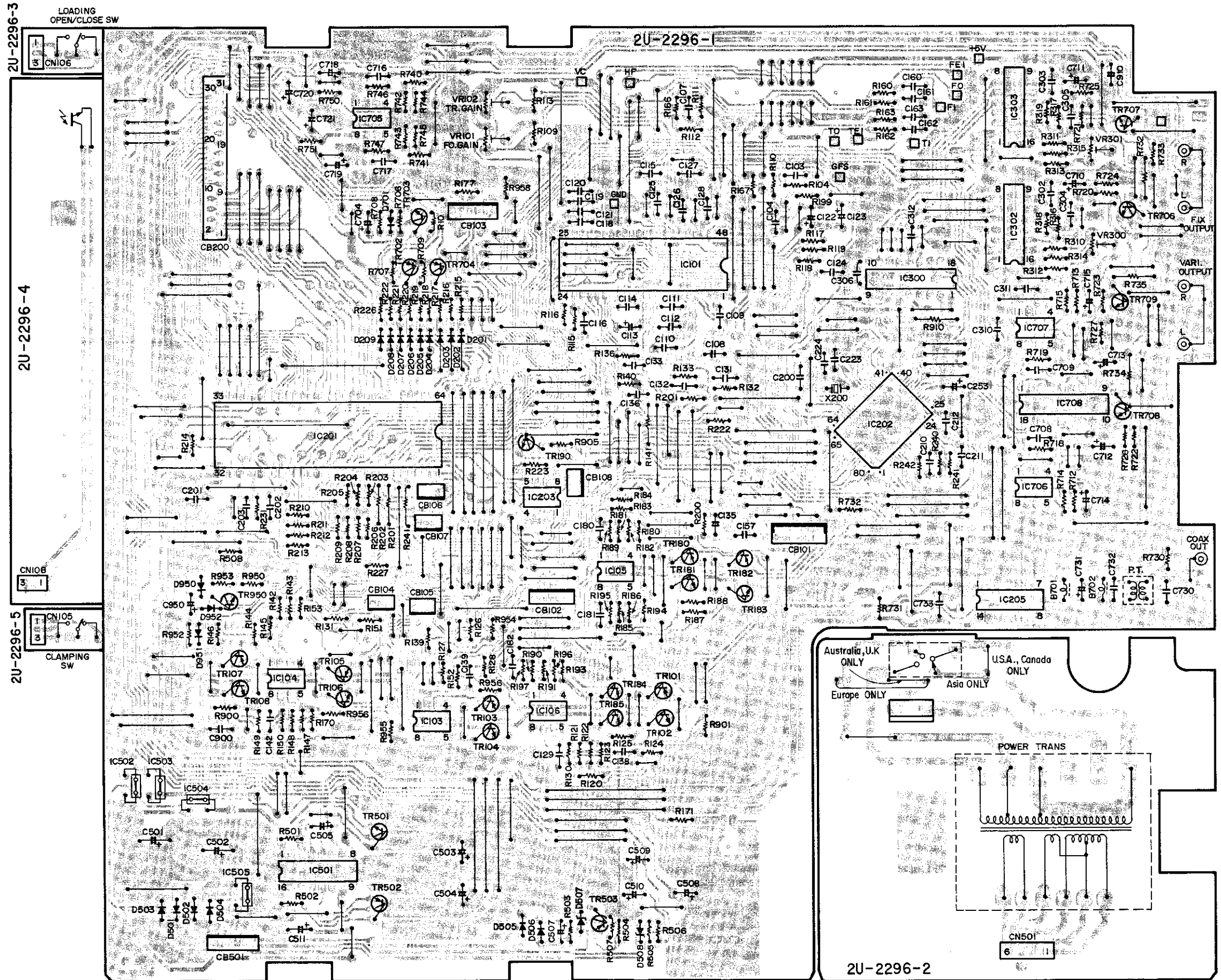

2U-2297 DISPLAY UNIT

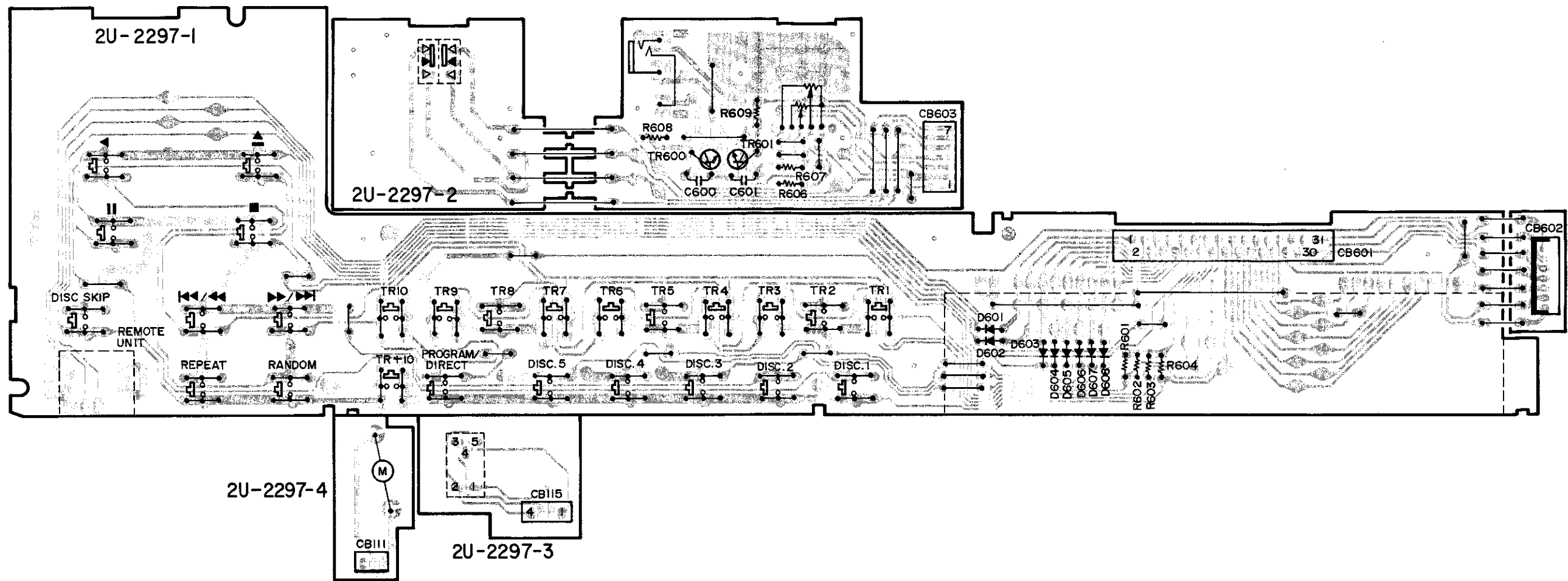

WIRING DIAGRAM

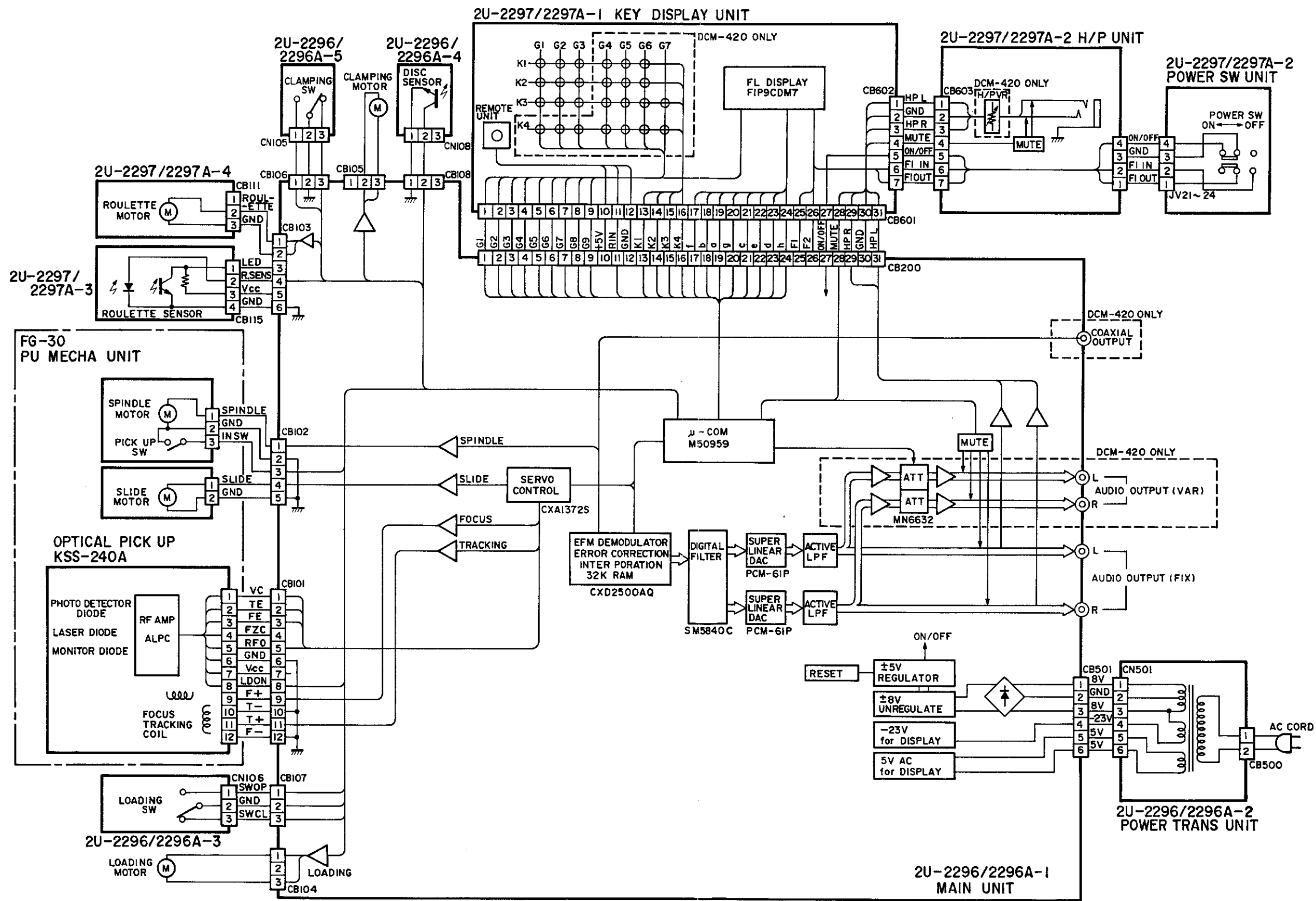

SEMICONDUCTORS

● IC's

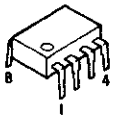

BA15218

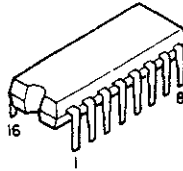
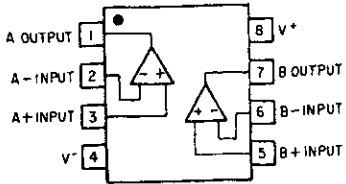

PCM61P-L
M5290P

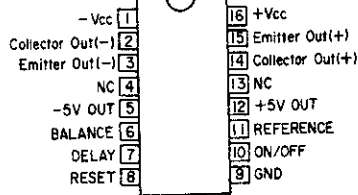

M5290P

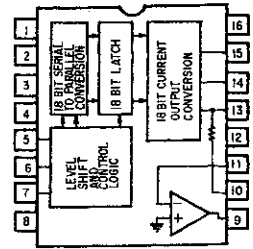

PCM61P-L

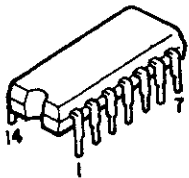

TC74HCU04AP

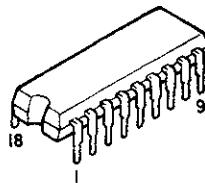
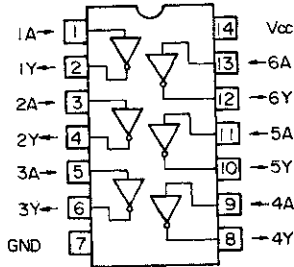

SM5840CP

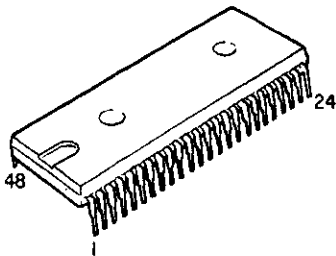
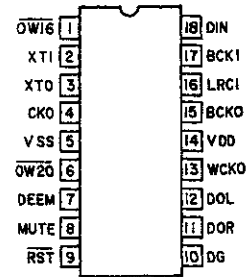

CXA1372S

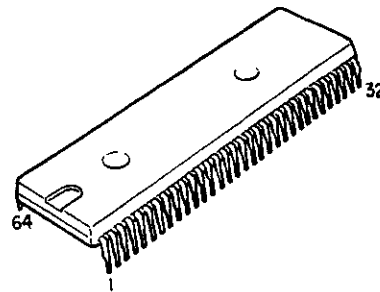
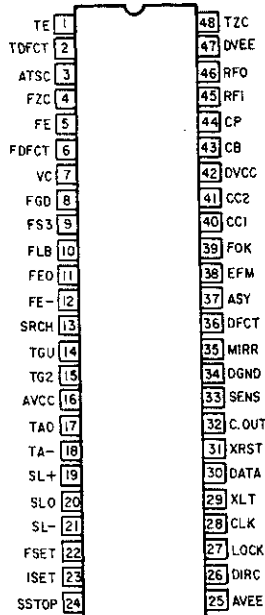

M50959

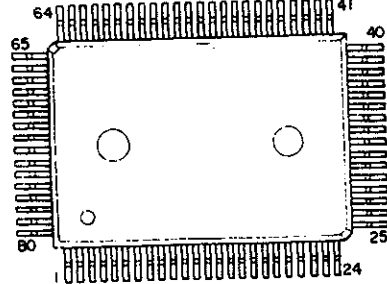

CXD2500AQ

● IC PROTECTOR

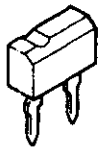

ICP-F15

or



ICP-N15

● DIODES



- 1S2076A
- 1SS270A
- 1SR139



- HZS7B-2
- HZS24-2

● TRANSISTORS

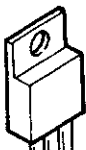

- E (Emitter)
- C (Collector)
- B (Base)

- 2SD1913
- 2SB1274



- E C B

- 2SA933(Q)
- 2SD2144



- E C B

- 2SB562
- 2SD468(C)



- E C B

- RN1202(10K-10K)NPN
- DTA124XS(22K-47K)

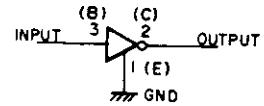

SCHEMATIC DIAGRAM

1

2

3

4

5

6

IC	IC703	IC104 IC103	IC202	IC106	IC300	IC101
Transistor	TR108 TR107 TR104 TR103 TR185 TR184	TR106 TR105 TR102 TR101 TR183 TR182	TR950	TR181 TR180	TR190	
Diode (Including LED)			D952	D951 D950		D201 D202

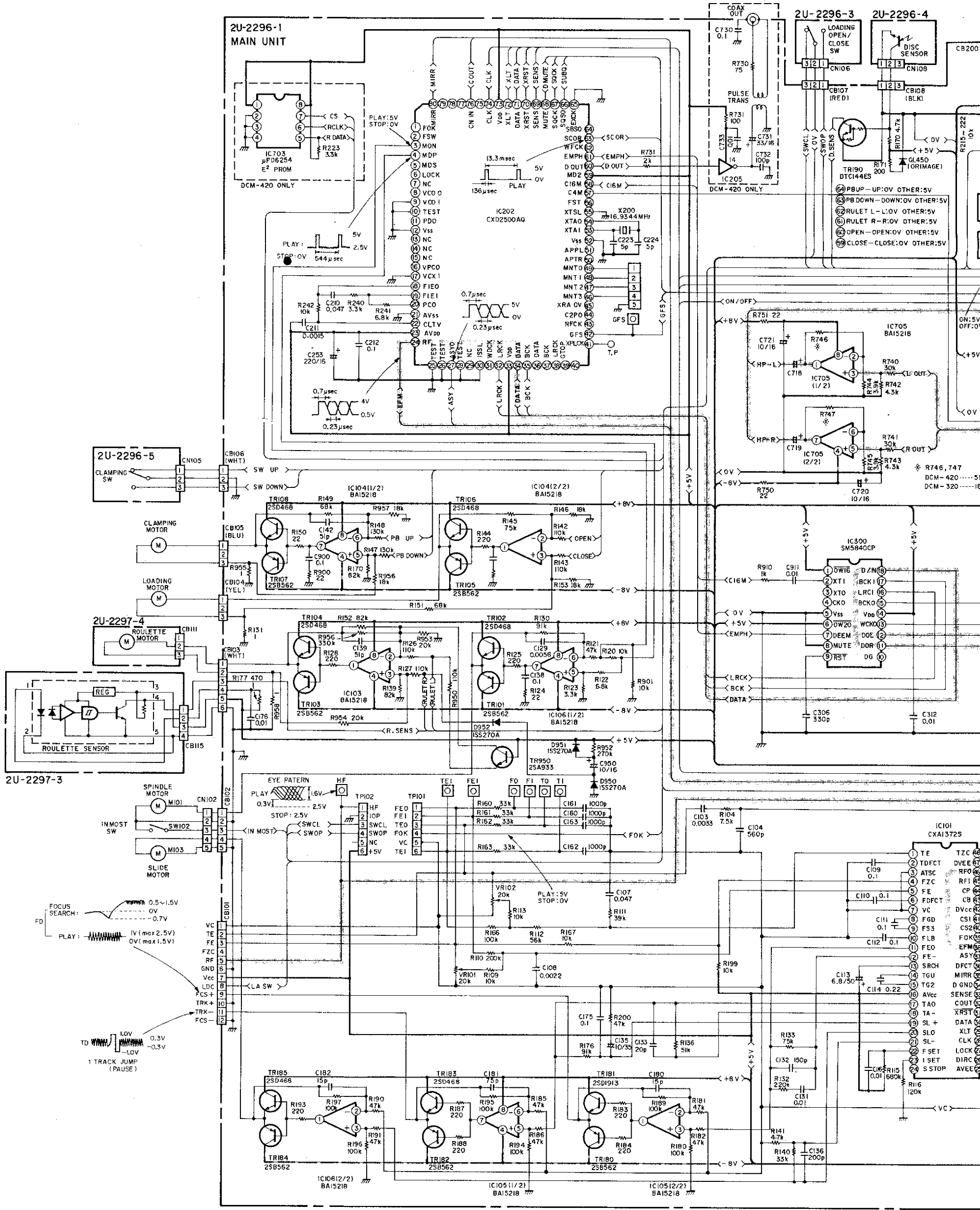

6 7 8 9 10 11

IC101 IC302 IC303 IC501 IC504 IC505 IC706 IC707 IC708

TR501 TR503 TR502 TR501 TR502 TR704 TR706 TR707 TR708 TR709 TR702 TR703 TR600 TR601

D201 D202 D203 D204 D205 D206 D207 D208 D209 D506 D505 D507 D508 D501 D502 D503 D504 D701

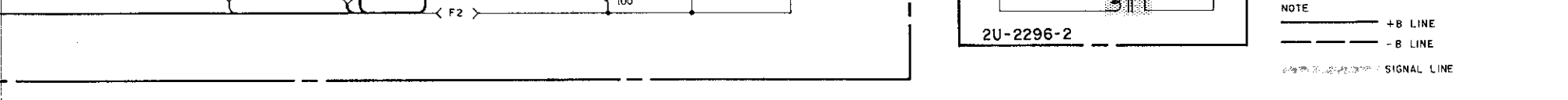
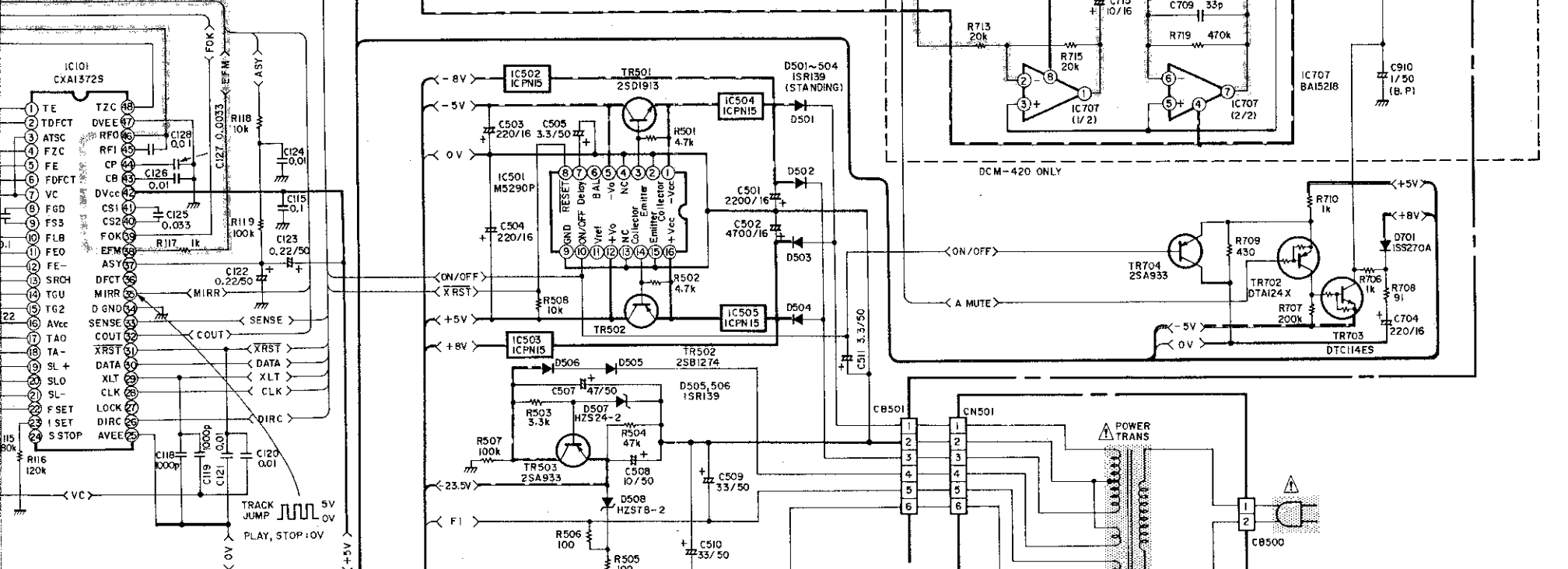
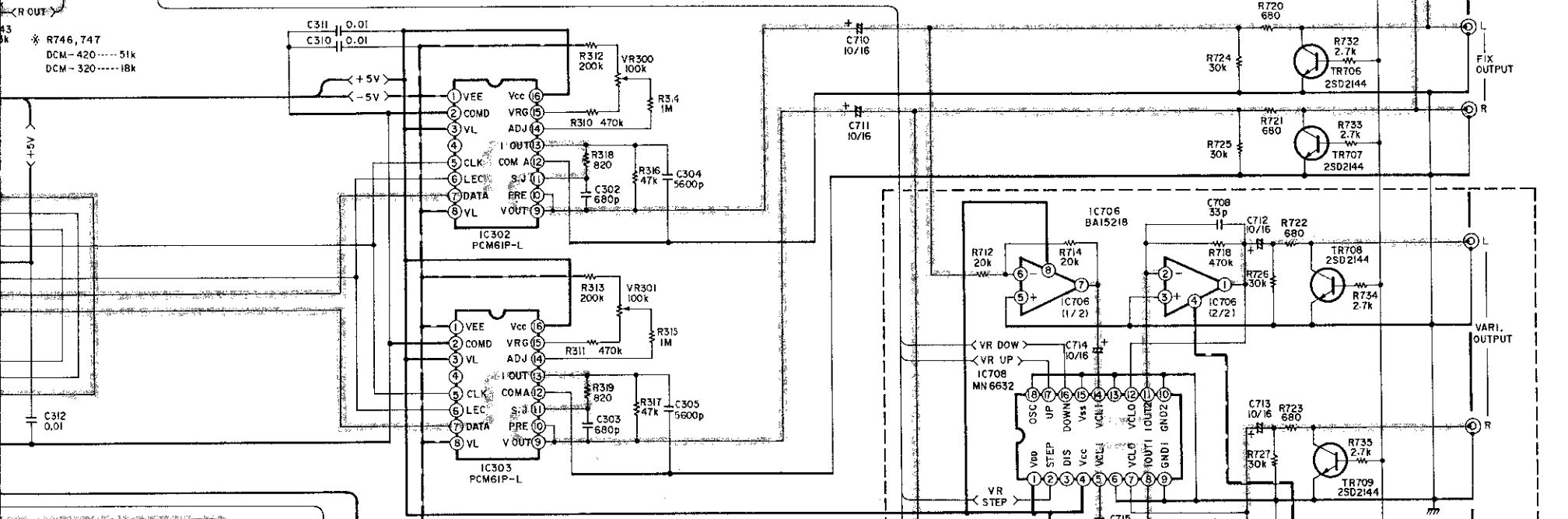
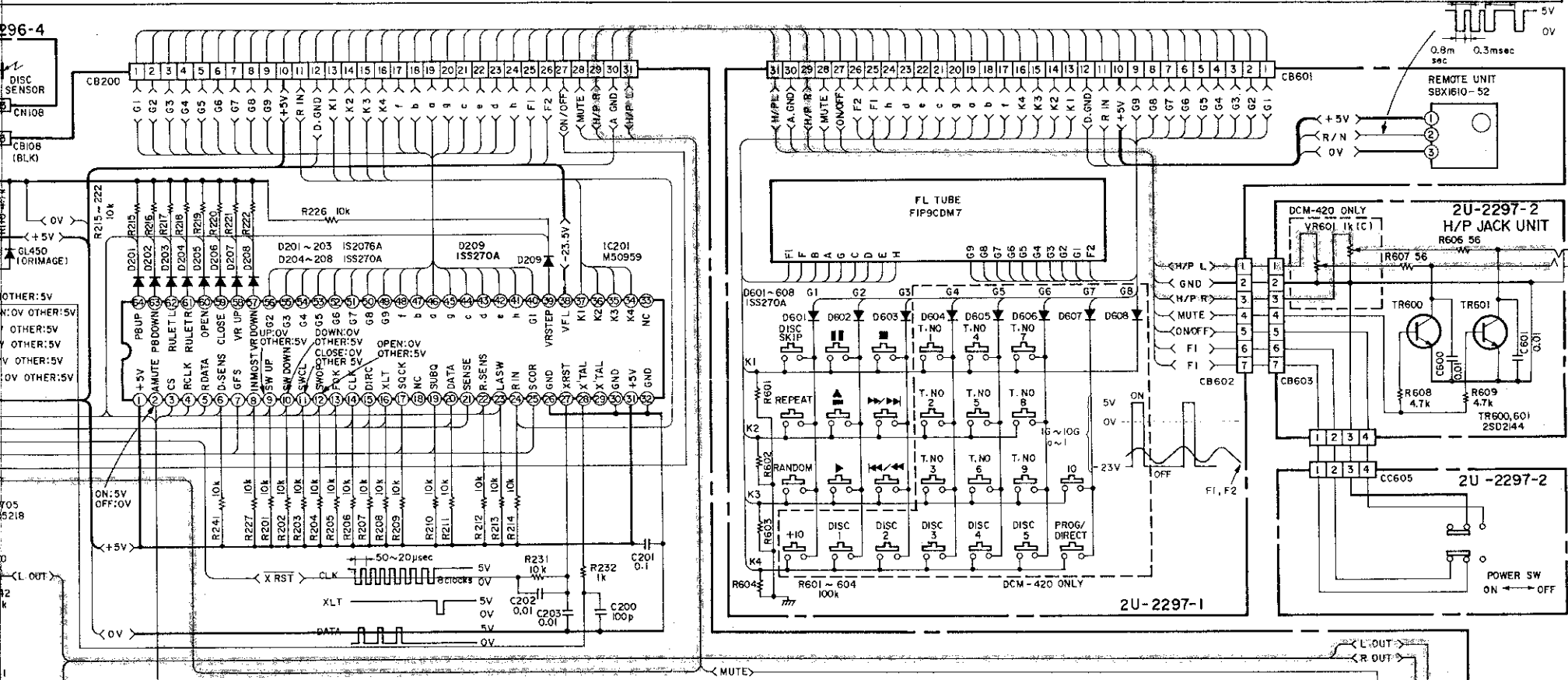

NOTE

— +B LINE

— -B LINE

— SIGNAL LINE

A B C D E F G H