

DENON

Hi-Fi Component

SERVICE MANUAL

MODEL DCM-440

MODEL DCM-340

STEREO CD PLAYER

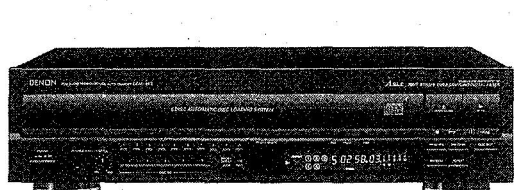

DCM-440

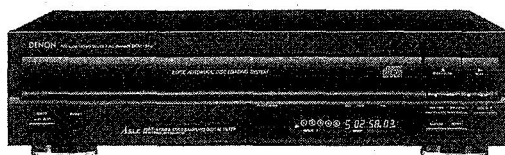

DCM-340

— TABLE OF CONTENTS —

OPERATING INSTRUCTIONS	2 ~ 10
SPECIFICATIONS	11
NOTE FOR HANDLING OF LASER PICK-UP	12,13
DISASSEMBLY	14
ADJUSTMENT	15 ~ 18
HEAT RUN MODE FUNCTION	19
SEMICONDUCTORS	20 ~ 25
NOTE ON PARTS LIST	26
PARTS LIST OF P.W.BOARD	27,28
EXPLODED VIEW OF MECHANISM UNIT	29
PARTS LIST OF MECHANISM UNIT	29
EXPLODED VIEW	30
PARTS LIST OF EXPLODED VIEW	31
PARTS LIST OF PACKING & ACCESSORIES	31
P.W.BOARD	32,33
WIRING DIAGRAM	34
SCHEMATIC DIAGRAM	35,36

NIPPON COLUMBIA CO., LTD.

IMPORTANT TO SAFETY

WARNING: TO PREVENT FIRE OR SHOCK HAZARD, DO NOT EXPOSE THIS APPLIANCE TO RAIN OR MOISTURE.

CAUTION:

- 1. Handle the power supply cord carefully. Do not damage or deform the power supply cord. If it is damaged or deformed, it may cause electric shock or malfunction when used. When detaching from wall outlet, be sure to remove by holding the plug attachment and not by pulling the cord.
2. Do not open the top cover. In order to prevent electric shock, do not open the top cover. If problems occur, contact your DENON dealer.
3. Do not place anything inside. Do not place metal objects or spill liquid inside the CD player. Electric shock or malfunction may result.

Please, record and retain the Model name and serial number of your set shown on the rating label. Model No. DCM-440/340 Serial No.

CAUTION RISK OF ELECTRIC SHOCK DO NOT OPEN. CAUTION: TO REDUCE THE RISK OF ELECTRIC SHOCK, DO NOT REMOVE COVER (OR BACK). NO USER SERVICEABLE PARTS INSIDE. REFER SERVICING TO QUALIFIED SERVICE PERSONNEL. The lightning flash with arrowhead symbol within an equilateral triangle is intended to alert the user to the presence of uninsulated "dangerous voltages" within the product's enclosure that may be of sufficient magnitude to constitute a risk of electric shock to persons. The exclamation point within an equilateral triangle is intended to alert the user to the presence of important operating and maintenance (servicing) instructions in the literature accompanying the appliance.

IMPORTANT (BRITISH MODEL ONLY) The wires in this mains lead are coloured in accordance with the following code: Blue: Neutral Brown: Live The colours of the wires in the mains lead of this apparatus may not correspond with the coloured markings identifying the terminals in your plug proceed as follows. The wire which is coloured blue must be connected to the terminal which is marked with the letter N or coloured black. The wire which is coloured brown must be connected to the terminal which is marked with the letter L or coloured red.

NOTE: This CD player uses the semiconductor laser. To allow you to enjoy music at a stable operation, it is recommended to use this in a room of 10°C (50°F) - 35°C (95°F).

LABELS (for U.S.A. model only)

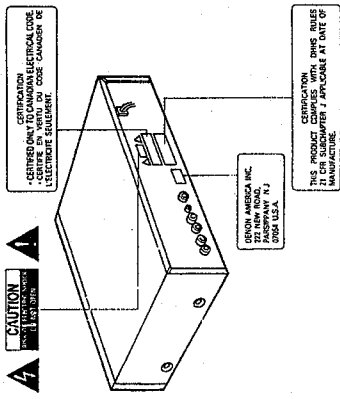

CAUTION: USE OF CONTROLS OR ADJUSTMENTS OR PERFORMANCE OF PROCEDURES OTHER THAN THOSE SPECIFIED HEREIN MAY RESULT IN HAZARDOUS RADIATION EXPOSURE. THE COMPACT DISC PLAYER SHOULD NOT BE ADJUSTED OR REPAIRED BY ANYONE EXCEPT PROPERLY QUALIFIED SERVICE PERSONNEL.

NOTE: This unit may cause interference to radio and television reception if you do not operate it in strict accordance with this OPERATING INSTRUCTIONS. This unit complies with Class B computing device rules in accordance with the specifications in Sub-part J or Part 15 of the FCC Rules, which are designed to provide reasonable protection against such interference in a residential installation. If the unit does cause interference to any radio or television reception, try to reduce it by one or more of the following means: a) Turn the other unit to improve reception b) Move this unit c) Move the other unit away from others d) Plug this unit respectively into a different AC outlet

FOR U.S.A. & CANADA MODEL ONLY CAUTION TO PREVENT ELECTRIC SHOCK DO NOT USE THIS (POLARIZED) PLUG WITH AN EXTENSION CORD, RECEPTACLE OR OTHER OUTLET UNLESS THE BLADES CAN BE FULLY INSERTED TO PREVENT BLADE EXPOSURE.



POUR LES MODELES AMERICAINS ET CANADIENS ATTENTION POUR PREVENIR LES CHOCES ELECTRIQUES NE PAS UTILISER CETTE FICHE POLARISEE AVEC UN PROLONGATEUR OU RECEPTACLE AUTRE QUE CELUI QUI PERMETTE LE COUPLAGE SANS LAISSER AUCUNE PARTIE A DECOUVERT.

SAFETY INSTRUCTIONS

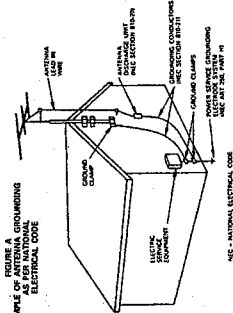
- 1. Read Instructions - All the safety and operating instructions should be read before the appliance is operated.
2. Retain Instructions - The safety and operating instructions should be retained for future reference.
3. Heed Warnings - All warnings on the appliance and in the operating instructions should be adhered to.
4. Follow Instructions - All operating and use instructions should be followed.
5. Water and Moisture - The appliance should not be used near water - for example, near a bathtub, washbowl, kitchen sink, laundry tub, in a wet basement, or near a swimming pool, and the like.
6. Carts and Stands - The appliance should be used only with a cart or stand that is recommended by the manufacturer.
6A. An appliance and cart combination should be moved with care. Quick stops, excessive force, and uneven surfaces may cause the appliance and cart combination to overturn.
7. Wall or Ceiling Mounting - The appliance should be mounted to a wall or ceiling only as recommended by the manufacturer.
8. Ventilation - The appliance should be situated so that its location or position does not interfere with its proper ventilation. For example, the appliance should not be situated on a bed, sofa, rug, or similar surfaces that may block the ventilation openings; or placed in a built-in installation, such as a bookcase or cabinet that may impede the flow of air through the ventilation openings.
9. Heat - The appliance should be situated away from heat sources such as radiators, heat registers, stoves, or other appliances (including amplifiers) that produce heat.
10. Power Sources - The appliance should be connected to a power supply only of the type described in the operating instructions or as marked on the appliance.
11. Grounding or Polarization - Precautions should be taken so that the grounding or polarization means of an appliance is not defeated.

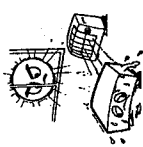
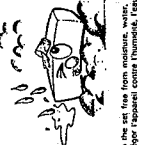

NOTE ON USE/OBSERVATIONS RELATIVES A L'UTILISATION/NOTAS SOBRE EL USO

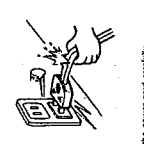
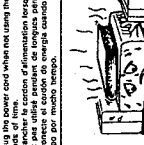
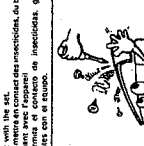
 <ul style="list-style-type: none"> • Avoid skin temperature. • Allow for sufficient heat dissipation when installed on a shelf. • Refer to the instructions for the correct use of the device. • Avoid excessive heat. • Avoid excessive humidity. 	 <ul style="list-style-type: none"> • Keep the set free from moisture, water, and dust. • Protéger l'appareil contre l'humidité, l'eau et la poussière. • Maintenir le matériel libre de l'humidité, de l'eau et de la poussière. 	 <ul style="list-style-type: none"> • Do not let foreign objects in the set. • Ne pas laisser des objets étrangers dans l'appareil. • No other objects around during use.
 <ul style="list-style-type: none"> • Handle the device with care. • Hold the plug when unplugging the cord. • Avoid excessive heat. • Avoid excessive humidity. • Avoid excessive dust. • Avoid excessive vibration. 	 <ul style="list-style-type: none"> • Do not clean the device with water. • Do not clean the device with alcohol. • Do not clean the device with any other liquid. • Do not clean the device with any other material. 	 <ul style="list-style-type: none"> • Do not let in moisture, humidity, and other items in contact with the set. • Ne pas laisser de l'humidité, de l'eau, de la poussière ou d'autres objets étrangers dans l'appareil. • Éviter l'humidité, l'eau, la poussière, l'air et d'autres objets étrangers.

Line Voltage Selection (for multiple voltage model only)

- The desired voltage may be set with the VOLTAGE SELECTOR knob on the rear panel, using a screwdriver.
- Do not twist the VOLTAGE SELECTOR knob with excessive force as this may cause damage.
- If the VOLTAGE SELECTOR knob does not turn smoothly, please contact a qualified serviceman.



Thank you for purchasing the DENON compact disc player. Read the Operating Instructions thoroughly, and operate this player properly.

- TABLE OF CONTENTS -

FEATURES 5

CAUTIONS DURING USE 5

NAMES OF PARTS AND THEIR FUNCTIONS 6-8

OPENING AND CLOSING THE DRAWER AND LOADING A DISC 8

CONNECTIONS 9, 10

NORMAL PLAY 10-15

OTHER PLAY METHODS 16

INSTALLATION PRECAUTIONS 16-18

PLAY USING THE REMOTE CONTROL UNIT 19

COMPACT DISCS 19

TROUBLE CHECK THE PLAYER TO FIND WHAT'S WRONG 19

SPECIFICATIONS 19

In addition to the CD Player unit, please check to make sure the following items are included in the packing box.

(1) Operating Instructions 1

(2) Connection Cards 1

(3) Remote Control Unit RC-248 (DCM-440) RC-248 (DCM-340) 1

(4) RRG (AAA size) Dry batteries (RC-248) 2

RRP (AA size) Dry batteries (RC-248) 2

IMPORTANT (CANADIAN MODEL ONLY)

This digital apparatus does not exceed the Class B limits for radio noise emissions from digital apparatus set out in the Radio Interference Regulations of the Canadian Department of Communication.

FEATURES

The DCM-440 and DCM-340 are CD players equipped with Denon's unique A.S.L.C. (Advanced Super Linear Converter) for eliminating sound quality deterioration in the PCM playback system in order to faithfully recreate the sound field of live halls or studios where compact discs are recorded. These models use carefully selected parts to provide high performance and sound field recreation with rich musical expression.

- Advanced Super Linear Converter**
The use of Denon's unique system for preventing zero cross distortion, the main cause of deterioration of the sound field quality in the PCM playback system, provides for sound field recreation with rich musical expression.
- High performance digital filter**
The DCM-440/340 uses high precision 20-bit 8-times oversampling digital filter.
- Simple Playback of 8cm CD Singles**
8cm CD singles can be played without using an adaptor.
- Programming of up to 20 tracks**
All of the tracks on a CD can be programmed to play in any order. Programming in units of discs (all tracks on a disc) is also possible.
- Newly developed carousel-type changer mechanism included**
This mechanism can house five discs, and while one disc is playing the remaining four discs can be changed. In addition, the carousel can be rotated either clockwise or counterclockwise, so searching between discs is fast.
- Wireless Remote Control Accessory**
In addition to general operations such as Play, Stop and Pause, this remote control unit enables direct selection, direct programming, and other functions. Use of the remote control unit adds greatly to the operating ease of the DCM-440/340, enhancing its outstanding features.
- Favorite Track File (F.T. FILE)** (DCM-440 only)
This function stores your favorite tracks for each of the discs. Using a deletion method, this function deletes up to 6 tracks on 1 disc, providing storage for up to 100 discs. Storage is retained even after the power is switched off.
- Synchronized Recording Function** (DCM-440 only)
Connect the SYNCHRO jack with a DENON cassette deck which is equipped with a SYNCHRO jack, then make a synchronized recording.

CAUTIONS DURING USE

- This compact disc player is capable of playing discs which have the mark at right.
- During track selection, during search and when the player sustains a strong impact, the disc's rotational speed changes greatly, causing a small noise to be emitted. This is not a malfunction of the player.
- If the CD player is operated while an FM or AM broadcast is being received, there may be noise in the FM or AM reception. Please switch the power to the CD player off at such times.
- The DCM-440/340 has a broad dynamic range. Please exercise caution when turning up the volume on the amplifier in cases when the playback volume is low. If the volume is turned up too high, it could damage the speakers.
- Do not use any discs but exclusive audio discs with this CD player.
- Placing this player or its connection cords near a TV or other audio device could cause a humming sound to be emitted. If this occurs, relocate the player or reroute the connection cords.
- Be sure to remove the disc from the player before moving it. The disc could be damaged if left in the player while it is being moved.
- Do not place any object in the tray in the position where the disc is loaded, or open and close the tray with anything inside. Foreign objects in the tray could damage the play mechanism.
- Do not move the player from a cold place to a warm place suddenly. If the player is cold when brought into a warm room, condensation could form, preventing proper operation of the player. If condensation does form on the player when it is brought into a warm room, wait at least 30 minutes before use.



NAMES OF PARTS AND THEIR FUNCTIONS

FRONT PANEL

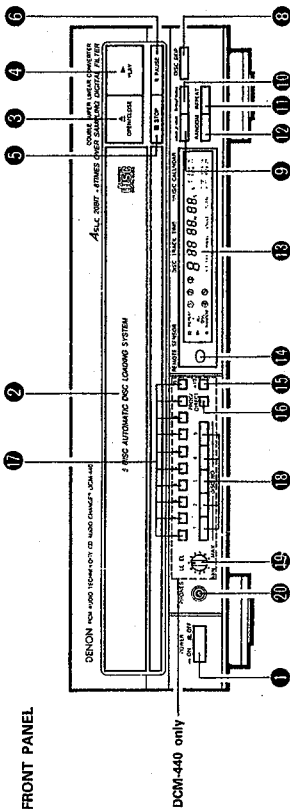

REAR PANEL

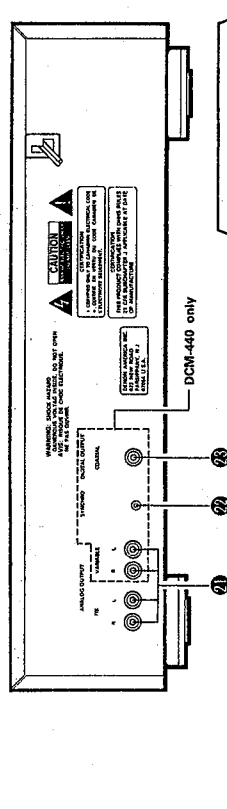

DCM-440 DISPLAY

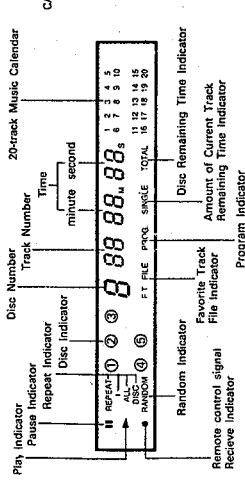

DCM-340 DISPLAY

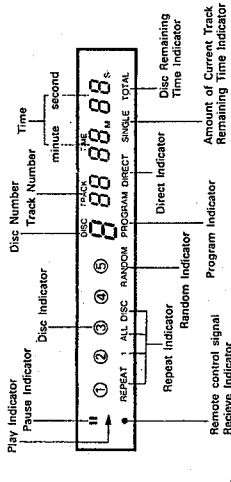

- 1 Power Switch (POWER)**
 - Press this button to switch on the power.
 - When the power is turned off, the unit is set to the standby mode.
 - If the power is turned off during playback or while the disc information is displayed on the time display, several seconds after the power is turned back on, the number of the disc appears on the disc number display, the track number display, and the total time is displayed on the track number display, and the total time is displayed on the time display, and approximately 1 second later playback starts.
- 2 Loading drawer**
 - Discs can be loaded and unloaded when this drawer is open. Do not force the drawer closed by hand.
- 3 Open/Close Button (▲ OPEN/CLOSE)**
 - Press this button when opening.
 - The drawer is opened toward the front.
 - Press the button again to close the drawer.
- 4 Play Button (▶ PLAY)**
 - Press this button to play a disc.
 - The [▶] indicator lights up when the button is pressed, the number of the disc and the track being played is displayed by the Disc Number and Track No. indicator, and the amount of elapsed time for the current track is displayed by the Time indicator.
 - The [▶] indicator goes off after playing of the final track of the final disc is finished and the player stops.
- 5 Stop Button (■ STOP)**
 - Press this button to stop play.
- 6 Pause Button (⏸ PAUSE)**
 - Press this button to stop play temporarily.
 - Pressing the Pause button during play stops play temporarily. The [⏸] indicator goes off and the [▶] indicator lights up.
 - To cancel the Pause state, press either the Play button [▶] or press the Pause button [⏸] a second time.
- 7 Disc trays (1 ~ 5)**
 - One disc per tray can be loaded.
- 8 Disc skip button (DISC SKIP)**
 - Each time this button is pressed, the carousel will rotate in a clockwise direction to the next tray position. This allows for loading or unloading of discs.
 - This button is also used to select the next disc, in the normal play continuously.
- 9 Automatic/Manual Search Reverse Button (◀▶/◀)**
 - Press this button to return the pickup to the beginning of the present track. Press again to return to other tracks.
 - By pressing the button a number of times, the pickup will move back the corresponding number of tracks.
 - Keep on pressing this button for more than 0.5 seconds during playback for fast reverse search. As long as the button is kept pressed, music signals are played back faster than normal.
 - Keep on pressing this button for more than 0.5 seconds when the pause mode is engaged, you can quickly reverse the pickup to a desired position, three times faster compared to manual reverse search during playback. During this time, no sound is heard.
- 10 Automatic/Manual Search Forward Button (▶/▶▶)**
 - Press this button to move the pickup forward to the beginning of the next track. Press again to move ahead to other tracks.
 - By pressing the button a number of times, the pickup will advance the corresponding number of tracks.
 - Keep on pressing this button for more than 0.5 seconds during playback for fast forward search. As long as the button is kept pressed, music signals are played back faster than normal.
 - Keep on pressing this button for more than 0.5 seconds when the pause mode is engaged, you can quickly forward the pickup to a desired position, three times faster compared to manual forward search during playback. During this time, no sound is heard.
- 11 Repeat Button (REPEAT)**
 - Press this button for repeated playback. The [REPEAT] indicator appears on the display. The following three types of repeat modes are available:
 - When pressed once, the [REPEAT] and [▶] indicators light and the track currently playing is repeated.
 - When pressed again, the [REPEAT] and [▶] indicators light and all the tracks on the disc currently playing are repeated.
 - When pressed again, the [REPEAT] and [▶] indicators light and all the discs currently set on the tray are repeated.
 - When pressed again, the [REPEAT] and [▶] indicators turn off and the repeat mode is cancelled. The repeat function can also be used during program and random playback, but in this case only the all repeat ([ALL DISC] indicator) modes are available. (Refer to Page 12 item 9.)
- 12 Random Button (RANDOM)**
 - Press this button to begin random play.
 - Pressing this button during stop, and press play button to play to full automatic random play.
 - Pressing this button during playing of a program starts random play of the tracks in the program. (See page 12, item 9.)
- 13 Display Window**
 - The Disc No., Track No., playing time and other information are displayed in the display window.
- 14 Remote Control Receptor (REMOTE SENSOR)**
 - This receptor receives infrared signals from the wireless remote control unit.
 - Aim the wireless remote control unit at this receptor window when operating it.
- 15 +10 Button (-;10)**
 - (DCM-440 only)
 - Press this button when selecting a track with a number greater than 11.
 - Use this button in combination with the number buttons [1] to [9]. For example, when selecting track number 15, press [1] + [10], then [5].
 - To select track number 32, press [1] + [10], [10], then [2].
- 16 Program/Direct Button (PROG/DIRECT)**
 - (DCM-440 only)
 - Pressing this button selects between program memory and direct track selection.

CONNECTIONS

- (1) **Connecting the Output Terminal**
 - Connect one end of the connection cord supplied with the CD Player, to the output terminals, left (L) and right (R) of the CD Player, and the other end to the CD, AUX or TAPE PLAY input terminals, left (L) and right (R), of the amplifier.
- (3) **Connecting the Digital Output Jack (COAXIAL) (DCM-440 only)**
 - Use a 75-ohm pin cord to connect the digital output jack (COAXIAL) of the DCM-440 to the digital input jack (COAXIAL) on a digital processor or D/A unit, available in stores.

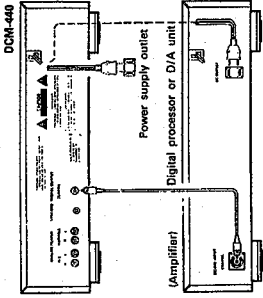
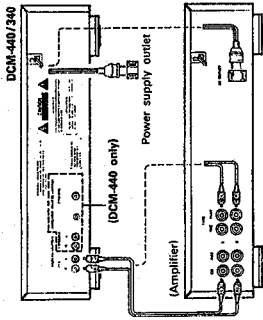

- (17) **Track Number Buttons (1 ~ 10) (DCM-440 only)**
 - Press these buttons when making direct track selections or when entering tracks in program memory. For example, when making a direct track selection, press the [1] button when desiring to play track 3. The player will then begin playing track 3. When desiring to play track 12, press [12], then [2]. When making a program, press the Program/Direct button [P] to enter the Program Mode.
- (18) **Disc Number Buttons (DISC NO.) (1 ~ 5) (DCM-440 only)**
 - Press these buttons to specify which disc you want to play.
- (19) **Volume Adjustment Knob (LEVEL) (DCM-440 only)**
 - Use this knob to adjust the output level (volume) for the headphones.
- (20) **Headphone Jack (PHONES)**
 - Insert the jack of the headphones when desiring to listen to a disc privately. (Headphones are sold separately.)

Note:

- Do not stop the carousel by hand when it is turning. If this is done, the microprocessor erroneously determines the disc number and the disc can be damaged.

OPENING AND CLOSING THE DRAWER AND LOADING A DISC

Opening and closing the drawer (This operation only works while the power is on.)

1. Press the power switch [POWER] to turn on the power.
2. Press the open/close button [OPEN/CLOSE].

How to load a disc

- Make sure the drawer is completely open.
- Hold the disc by the edges and place it on the disc tray. (Do not touch the signal surface, i.e., the glossy side.)
- Set the disc properly in the tray according to its size.
- Set 8cm discs in the center hole.
- Set 12cm discs in the outer hole.
- When the drawer is opened during the stop mode, discs can be loaded in the disc 1 to disc 4 trays. If the DISC SKIP button is pressed, the carousel turns and a disc can be loaded in the disc 5 tray.
- When the drawer is opened during the play mode, it is possible to load and unload discs in all of the disc trays other than the one whose disc is currently playing. In this case, the DISC SKIP button will not operate.
- Press the open/close button [OPEN/CLOSE] to close the drawer.

Caution:

- The player will not operate properly and the disc may even be damaged if it is not set correctly.
- If your finger should get caught in the drawer when it closes, press the open/close button [OPEN/CLOSE].
- Do not place any foreign objects on the disc tray, and do not place more than one disc on the tray at a time. Otherwise malfunction may occur.
- Do not push in the disc tray manually when the power is off as this may cause malfunction and damage the CD player.
- Do not touch the carousel while it is turning. Also, do not turn the carousel by hand when it is stopped. Doing so could damage it.
- Do not insert disc where indicated by arrow. This could damage the internal mechanism in the unit.

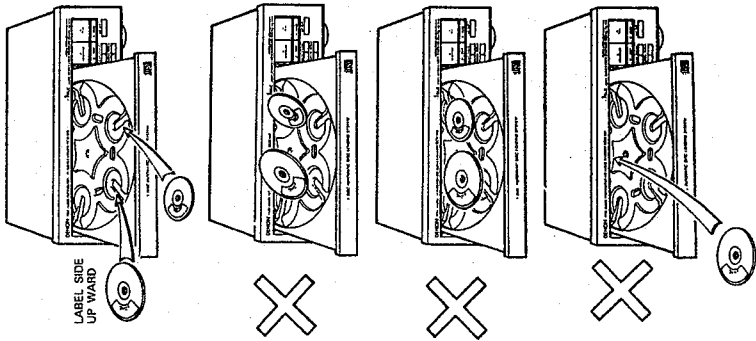

- (2) **SYNCHRO-Jack Connections (DCM-440 only)**
 - Connect the SYNCHRO jack with a DENON cassette deck which is equipped with a SYNCHRO jack then make a synchronized recording. Use the connection cord supplied with the cassette deck.
 - To make use of this function, also connect the output jacks and make the settings so that a recording can be made from the CD player to the cassette deck.

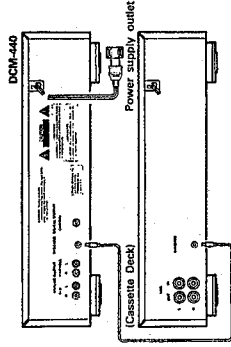

NORMAL PLAY

Follow the steps below to get an understanding of the disc play procedure.

- (1) **Starting Playback**
 1. Turn the power switch on and press the open/close [OPEN/CLOSE] button to open the drawer.
 2. Set the disc to be played in the tray on left side.
 3. Press the play button [▶].
 4. The drawer closes and the disc just loaded is played.
 5. The disc number, track number and elapsed time, etc., for the disc currently playing appear on the display window.
 6. If the open/close [OPEN/CLOSE] button is pressed while a disc is playing, playback continues, but the drawer opens and four discs can be replaced.

Press the open/close [OPEN/CLOSE] button again to close the drawer.

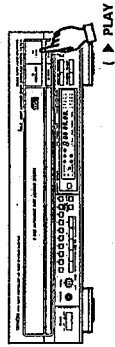

(2) Stopping Playback

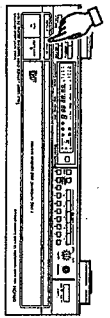

1. Press the stop button (■) to stop playback.
2. To replace discs, press the open/close (⏏) OPEN/CLOSE button. The disc which was playing switches over to the left side and the drawer opens.

OTHER PLAY METHODS

In addition to normal play, the following methods can be used when playing a disc.

- 1 To Play the Desired Disc and Desired Track

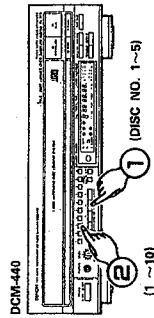

- 1 Press the button for the number of the desired disc (1 to 5).
 - 2 Next, press the number of the desired track (1 to 10 and +10 buttons).
- Track Number buttons: You would like to play with the track on the 3rd disc, press [3] for the Disc Number, then [4] for the track Number; you would like to play the 12th track on the 5th disc, press [5] for the Disc Number and [12] for the Track Number. Play will begin from the number of the disc and the track input.

DCM-340 (Remote control only)

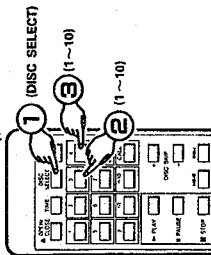

1. Press the DISC SELECT button.
 2. Use the number buttons (1 to 5) to select the number of the disc to be played.
 3. Next, use the number buttons (1 to 10 and +10) to select the number of the track to be played.
- For example, to play the 4th track on the 3rd disc: Press [DISC SELECT], [3] and [4].
 - To play the 12th track on the 5th disc: Press [DISC SELECT], [5], [12] and [2].
- Playback begins from the number of the disc and track selected.

(3) To Move to the Next Track during Play

Press the Automatic/Manual search forward button (▶▶▶) for less than 0.5 seconds during playback.

- The pickup will advance to the beginning of the next track and playback will continue. Pressing the button several times will forward the pickup the corresponding number tracks.

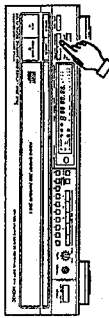

Press the ▶▶▶ button

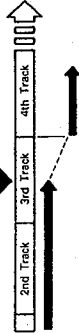

- During Random or Program operation, player moves to the beginning of the next random or program track selection.

(4) To return to the beginning of the track now being played

Press the Automatic Search

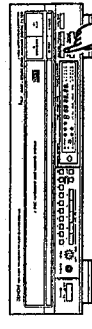

Press the Automatic/Manual search reverse button (◀◀◀) for less than 0.5 seconds during playback.

- The pickup will return to the beginning of the current track and playback will continue. Pressing the button several times will return the pickup the corresponding number tracks.

Press the ◀◀◀ button

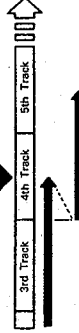

(5) To Play the Desired Discs and Desired Tracks in the Program Order

- You can play certain tracks on the loaded discs in any order.
- Tracks on a disc not loaded can also be programmed, but if you try to play that disc, the microprocessor detects that it is not loaded and the following disc is played automatically.
- Up to 20 tracks can be set in a program.
- A program can be made for a single entire disc.

(1) Programming DCM-440

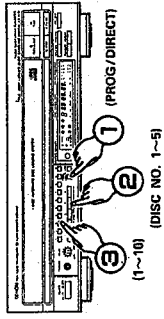

DCM-340 (Remote control only)

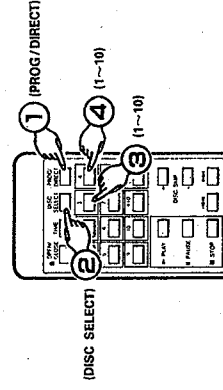

- Pressing the Program (PROG/DIRECT) button causes the Program indicator to light up. Select the disc, track in the program using the Disc Number buttons and the Track Number buttons and [10] button. For example, if you would like to hear the 3rd track of the 2nd disc and the 12th track of the 5th disc, press [PROG/DIRECT], Disc Number [2], Track Number [3], Disc Number [5], then Track Number [12]. It is not necessary to specify the disc if all the tracks in the program are from the same disc.
- If all the tracks are being selected from the same disc, all the tracks on a particular disc can be played, such as from the 1st track of the 3rd disc, all tracks of the 5th disc and the 5th track of the 5th disc.
- In this case, press [PROG/DIRECT], Disc Number [3], Track Number [1], Disc Number [5], then Disc Number [5], Track Number [5].

(2) To Check the Programmed Tracks (Remote control only)

RC-245

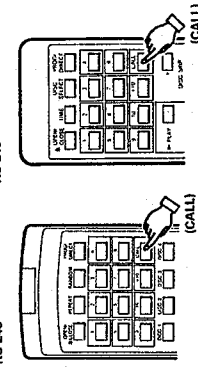

- Press the call button on the wireless remote control unit. The contents of the program are displayed in order one item at a time each time the Call button is pressed.

- Set the disc you want to played in the left side.

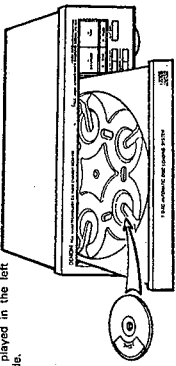

(2) To Move to the Next Disc During Playback

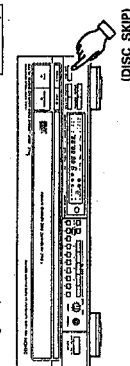

- 1 Press the disc skip button. The carousel in the drawer turns and the disc on the next tray is played.
- 2 For example, if disc number 2 was playing, the disc switches to disc number 4, and if disc number 5 was playing, the disc switches to disc number 1.
- 3 In addition, when the Disc Skip - button on the remote control unit is pressed, the carousel turns in the opposite direction and the previous disc is played.

RC-246

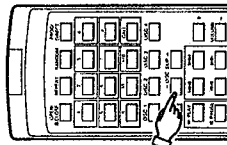

(DISC SKIP -)

RC-245

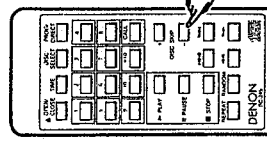

(DISC SKIP -)

- (4) To Cancel Random Play
- Pressing the Random button once more cancels the Random function. Play will then proceed from the track currently being played to the end of the last track on the disc, then stop. Pressing the open/close (OPEN/CLOSE) button also cancels the Random function.
- Cautions**
- Pressing the Random button during normal play starts full random play.
 - Pressing the Random button during Program play starts random play of the tracks in the program, including the tracks which have already been played.
 - During random play, the player may display the number of disc which is not loaded in the tray. In such a case, the player will read the disc information, then reset automatically to correct. This is not a malfunction.

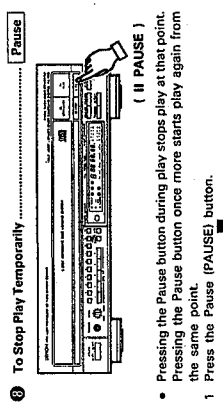
- (5) To Stop Play Temporarily
- 
- (II PAUSE)
- Pressing the Pause button during play stops play at that point. Pressing the Pause button once more starts play again from the same point.
- Press the Pause (PAUSE) button.

- Press the Play (▶) button or the Pause (II PAUSE) button.
- Press the Play (▶) button or the Pause (II PAUSE) button to start play.

- (6) Audible quick search
- Manual Search
- Using this function, you can cue to a desired point within a track, either in the forward or reverse direction.
 - Release the automatic/manual search button (M/◀ or ▶/M) when the desired point has been reached. Normal playback then continues.

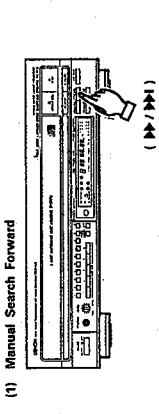
- (1) Manual Search Forward
- 

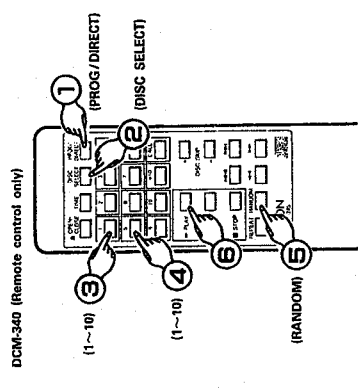

- After pressing the PROG/DIRECT button and inputting a program (See item 6 on page 11), press the Random button, then the Play button. The microcomputer will then select tracks from the program at random and play them.

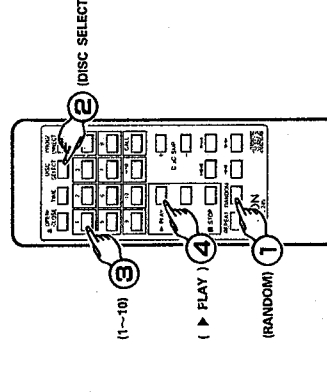
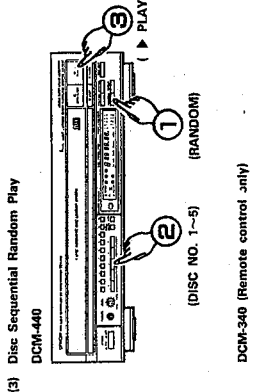

- Press the Random button. Next press the Disc Number buttons for the discs to be played, in the desired order, then press the Play button. The microcomputer will then select tracks from the specified discs to be played at random, in the order in which the discs were selected. Up to 5 discs can be selected, and the same disc can be selected two or more times. Disc sequential random play is cancelled when play ends.

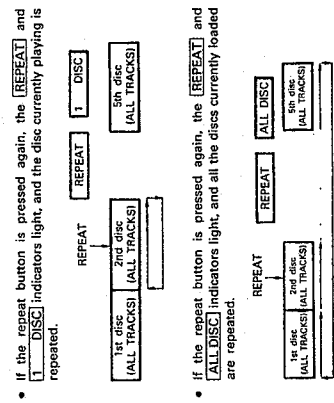

- If the repeat button is pressed again, the REPEAT and DISC indicators light, and the disc currently playing is repeated.
- If the repeat button is pressed again, the REPEAT and ALL DISC indicators light, and all the discs currently loaded are repeated.

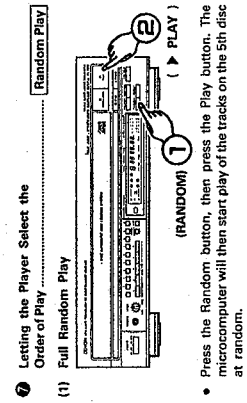

- Pressing the Repeat (REPEAT) button during play will also cause the player to repeat play (of all tracks).
- To cancel repeat play, press the Repeat (REPEAT) button once more.
- Pressing the Repeat (REPEAT) button while a program is being played will cause the tracks in the program to be played again in order.
- Pressing the Repeat (REPEAT) button during Random play will cause the tracks to be played again at random.

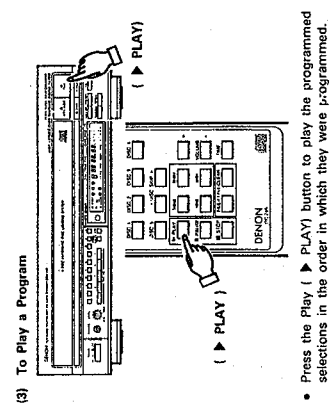
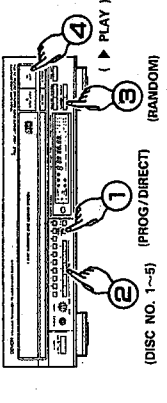

- Press the Play (▶) button to play the programmed selections in the order in which they were programmed.

- (4) To clear the entire program
- Pressing the PROG/DIRECT button once more erases the entire program. Pressing the open/close (OPEN/CLOSE) button also erases the contents of a program.
 - Pressing the PROG/DIRECT button while a program is being played cancels the program. Play will then be continuous to the end of the disc currently being played, after which the player will stop automatically.
- Cautions**
- If a program is run during playing of a track or from the Pause state, the track which is currently being played becomes the 1st track in the program.
 - Additional tracks can be added to the program, but the player will not display the number of tracks in the program or the playing time.
 - Direct selection cannot be done while a program is being played. Inputting the track number of a desired track with the Track Number buttons adds the input track to the end of the program.
 - When programming, do not program a track number which is not recorded on the disc. If such a number is programmed by mistake, the player ignores the program.
 - The CLEAR button on remote control unit RC-246 cannot be used to clear the program. This button is only for F.T. FILE. (DCM-440 only)

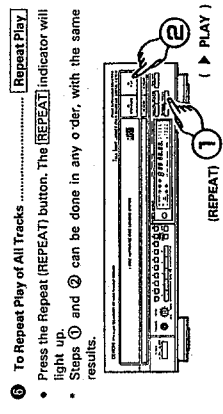

- Press the Repeat (REPEAT) button. The REPEAT indicator will light up.
- Steps 1 and 2 can be done in any order, with the same results.
- When the repeat button is pressed once, the REPEAT and 1 indicators light. In this mode, the track currently playing is repeated.

17 Synchronized Recording Function
Synchronized Recording Function

- Connecting the SYNCHRO jack with a DENON cassette deck which is equipped with a SYNCHRO jack will allow synchronized recordings to be made.
- To use this function, be sure to connect the SYNCHRO jacks as well as the input terminal (LINE OUT). (See Page 9 for connections.) Then, insert a disc.
- With the CD player in the stop or pause condition, starting a synchronized recording at the cassette deck side will automatically cause the CD player to start playing. (This is synchronized play.)
- The remote control indicator of the display will blink during synchronized play.

NOTE

- Synchronized play is also possible in the program mode.
- The repeat mode is cancelled when synchronized play is started.
- Except for the STOP button and OPEN/CLOSE button, the buttons will not operate during synchronized play.
- For further details, see the owner's manual for the cassette deck that has been connected.
- In the play condition, even if you start a synchronized recording at the cassette deck side, CD player will not synchronize with the cassette deck and the cassette deck becomes synchronized pause condition.
- In this case push the STOP button of the cassette deck, set the CD player in the stop or pause condition and start a synchronized recording at the cassette deck side again.

(2) Programmed Play

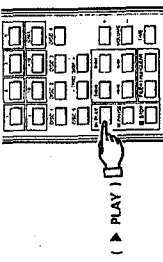

- Pressing the **▶ PLAY** button will call the files for each of the discs to be played, then play the disc, skipping the programmed tracks.

(3) To delete the programs recorded to the file

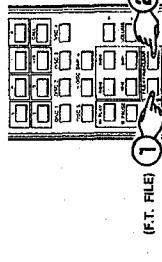

- Press the FILE button and press the CLEAR button while "FILE" is being displayed on the time display.
- "CLEAR" will be displayed on the time display for about 1 second and the program of that disc will be deleted from the file.

(4) Contents of the F.T. File

- Up to 100 discs can be recorded to the F.T. file.
- When 100 discs have been recorded, if a new disc is loaded, the program cannot be recorded by pressing the FILE button after track selection according to the operation of Step (1). This procedure will result in "FULL" being displayed on the time display for about 1 second.
- When the program of a new disc is recorded to the file, first delete the file that has already been recorded using the operation of Step (3).

(5) To Cancel the F.T. FILE Mode

- Pressing the program/direct button (PROG/DIRECT) and OPEN/CLOSE button cancels the F.T. FILE mode and sets the direct mode.

CAUTION

- Pressing the Number button and the **▶▶▶** button during play provides direct track selection.
- When track selection has not been made, all recorded tracks are played.
- Can be used only when the drawer is closed.
- The remaining time display of the track is limited to the 1st through 20th tracks of the disc.
- For discs with 21 or more tracks recorded, the total time at the end of programming and the program remaining time are not displayed.
- After the program track selection, changing to a separate disc before recording to the file will result in program cancellation.
- Program calling is not possible with the CALL button in the F.T. FILE mode.
- Random play is possible in the F.T. FILE mode. In this case, disc sequential random using the F.T. FILE is set.
- When in the random mode, the F.T. FILE mode cannot be set even when the FILE button is pressed. It is also not possible to store or erase files. Set the F.T. FILE mode, program, then press the RANDOM button.

1. Press the Track Number buttons to set the number of the desired track.

- Press the Pause (|| PAUSE) button.
- To start play, press the Play (▶ PLAY) button or the Pause (|| PAUSE) button.

(2) Cueing by Program Selection

- After setting the desired track selections in a program, press the Pause (|| PAUSE) button. The player will advance to the beginning of the 1st track in program memory and wait in the Pause state.

1 Stores your favorite tracks for each of the discs

Favorite Track File (F.T. FILE)

- Permits programming of the tracks you do not wish to listen to from among the tracks recorded on the disc, then skips these tracks when the disc is played.
- When these tracks are recorded to the file, the program is automatically called by setting the F.T. FILE mode, even after the disc has been changed and the power switched off.
- Up to 6 tracks can be programmed within 1 disc.
- Up to 100 discs can be recorded to file.
- The program contents are displayed on a calendar.

(1) Disc programming and recording to file

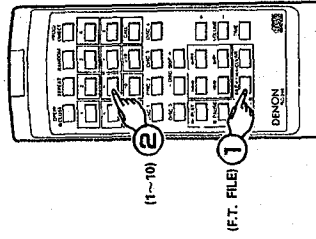

Pressing the FILE button in the stopped condition will light up F.T. FILE.

- Select the tracks to be programmed using the Track Number button and the **▶▶▶** button.
- For example, to program the 3rd, 12th, and 7th tracks, press **FILE**, **3**, **▶▶▶**, **12**, **▶▶▶**, **7**, and **▶▶▶**.
- Each time a track is specified, that track number is deleted in the calendar. The total number of tracks to be played is displayed under TRACK No. and the total play time is displayed under TIME.
- When recording the program to file, after selecting the program, press the FILE button. "FILE" will be displayed on the time display for about 1 second.

1. Keep on pressing the automatic/manual search forward button (▶▶▶) for more than 0.5 seconds during playback.

- Playback of the track is sped up.
- As a reference, the current track number and elapsed playback time within the track are displayed.
- Manual search forward is approximately three times faster when engaged during the pause state compared to playback. In this case, no sound is heard however.
- If the automatic/manual search forward button (▶▶▶) is kept pressed after the end of the final track on the disc is reached, (JJ) is displayed and manual search stops. To return to another point, press the automatic/manual search reverse button (◀◀◀) until (JJ) disappears.

(2) Manual Search in Reverse

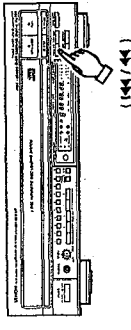

1. Keep on pressing the automatic/manual search reverse button (◀◀◀) for more than 0.5 seconds during playback.

- Reverse playback of the track is sped up.
- As a reference, the current track number and elapsed playback time within the track are displayed.
- Manual search in reverse is approximately three times faster when engaged during the pause state compared to playback. In this case, no sound is heard however.
- If the automatic/manual search reverse button (◀◀◀) is kept pressed after the beginning of the first track on the disc is reached, (CC) is displayed and manual search stops. To return to another point, press the automatic/manual search forward button (▶▶▶) until (CC) disappears.

1 To Cue and Stop Play

- Cueing by Direct Selection
- Cueing by direct selection, then entering the Pause state, is convenient for predicting vocals with background music.

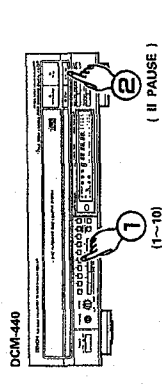

DCM-340 (Remote control only)

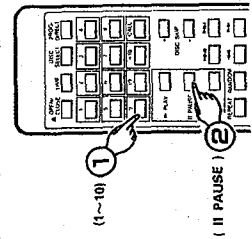

REMOTE CONTROL UNIT RC-246 (DCM-440)

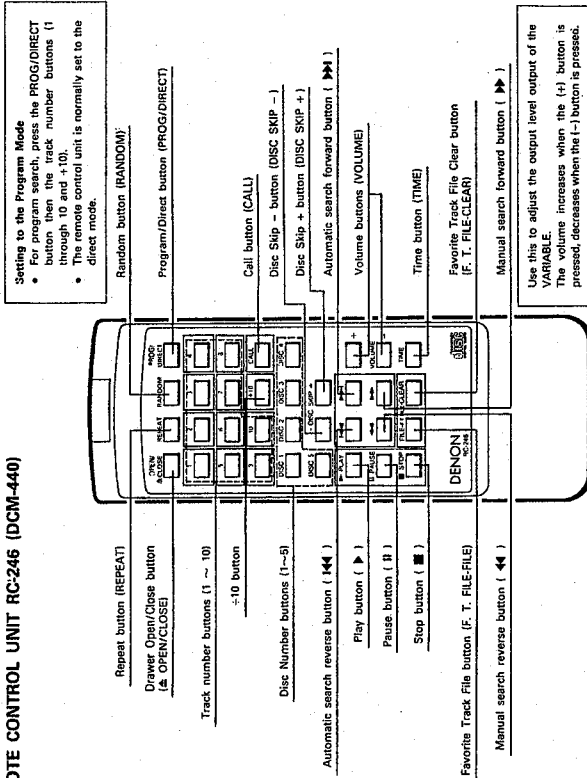

Setting to the Program Mode

- For program search, press the PROG/DIRECT button then the track number buttons (1 through 10 and +10).
- The remote control unit is normally set to the direct mode.

Use this to adjust the output level of the VARIABLE. The volume increases when the (+) button is pressed, decreases when the (-) button is pressed.

- Direct Selection**
Normally, direct search is possible simply by pressing the desired number buttons.
Program Selection (During playback, the track which is currently playing is programmed as the 1st track.)
Press the PROG/DIRECT button, then press the number buttons.
For example, to program tracks number 2, 11, and 5, press PROG/DIRECT → 3 → +10 and → 5.
- Shipping Discs**
The Disc Skip button (DISC SKIP +, -) will not function in the random and program modes.
During disc sequential random playback, when the Disc Skip + button is pressed, the following disc is played in random order.
- Volume**
The output level of the VARIABLE output terminal can be changed.
When the volume button is pressed, "V" appears in the TIME/M (minutes) section of the display window and the level appears in the S (seconds) section. The volume can be changed between a maximum of "0" and a minimum of "-50" in 50 steps, by approximately 1.5 dB per step.
- Time**
The Time indicator indicates the amount of elapsed time for the track currently being played, the amount of time remaining for the current track and the amount of time remaining for all tracks yet to be played.
Normally, the amount of elapsed time for the current track is displayed. Pressing this button once causes the [SINGLE] indicator to light up, displaying the amount of time remaining for the current track. Pressing the button once more turns the [SINGLE] indicator off and causes the [TOTAL] indicator to light up, displaying the time remaining for all tracks yet to be played on the disc. Pressing the button once again turns the [TOTAL] indicator off and causes the indicator to display the elapsed time for the current track.
During playback, the total remaining time is the remaining time for the disc. For programmed playback, the remaining time for the program is only displayed when the programmed tracks are all on the same disc.
In the case of 21st and subsequent tracks, the time remaining for one track is displayed "----". When 21st and subsequent tracks is programmed, the time remaining for all tracks is displayed "-----".
"-----" is displayed when tracks on more than one disc are programmed.
- Inputting the Track Numbers**
For track numbers below 10, simply press the corresponding button. For track numbers of 11 and greater, press the +10 then the number buttons.
For example, for track number 22 press +10 twice then 2.
- Volume**
The volume control on the unit will operate when the volume buttons are pressed. The volume can be checked by looking at the position of the control.

INSTALLATION PRECAUTIONS

The CD player uses a microcomputer for controlling internal electronic circuits. In the event that the player is used while a near-by tuner or TV is turned on, although unlikely, interference could occur either in the sound from the tuner or the picture of the TV. To avoid this, please take the following precautions.

- Keep the CD player as far away from the tuner or TV set as possible.
- Keep the power cable and connecting cable of the CD player separate from the antenna wires of the tuner and TV.
- Interference is particularly likely to occur when an indoor antenna or a 300-ohm feeder cable is used. Thus, use of an outdoor antenna and 75-ohm coaxial cable is strongly recommended.

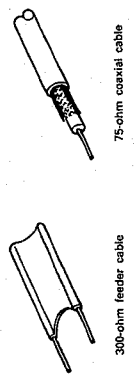

PLAY USING THE REMOTE CONTROL UNIT

The DCM-440/340 CD Player can be controlled from across the room using the accessory Remote Control Unit.

- Inserting the Dry Battery**
 - Remove the cover on the back of the remote control unit.
RC-246 (DCM-440)
 - Insert two R03 (AAA size) batteries in the RC-246 (DCM-440), two R6P (AA size) batteries in the RC-245 (DCM-340), following the indications on the battery compartment.
 - Replace the cover on the back of the remote control unit.

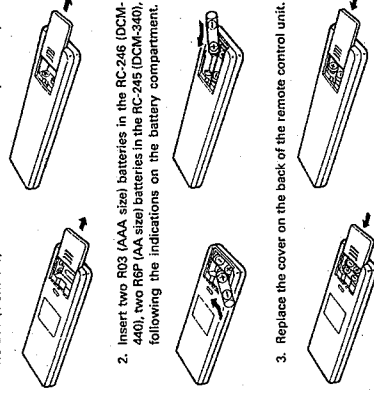

Cautions Concerning Dry Batteries

- Use R03 batteries in the RC-246 remote control unit, R6P batteries in the RC-245 remote control unit.
- Depending on the frequency of use, the dry batteries should be replaced approximately once per year.
- If the remote control unit fails to control the CD Player, even before a year has passed, replace the dry batteries with new ones.

Using the Remote Control Unit

- Aim the remote control unit toward the light receptor in the front of the CD Player, as shown in the drawing below. The remote control unit can be used up to a distance of 8 meters in a straight line from the CD Player. However, this distance will be shortened if there is some obstruction between the remote control unit and the light receptor, or if the beam of light is slanted.

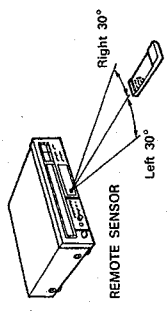

- The remote control unit has the same functions as the main unit, but the following operations cannot be done.
 - Switching the power on and off.
 - Adjusting headphone volume.

Cautions During Use

- Do not press the operating buttons on the main unit and the remote control unit at the same time. This could cause a malfunction.
- Operation of the remote control unit will be hindered if a strong light from the sun or a light fixture is shining on the REMOTE SENSOR, or if there is an obstruction between the remote control unit and the CD player unit.

REMOTE CONTROL UNIT RC-245 (DCM-340)

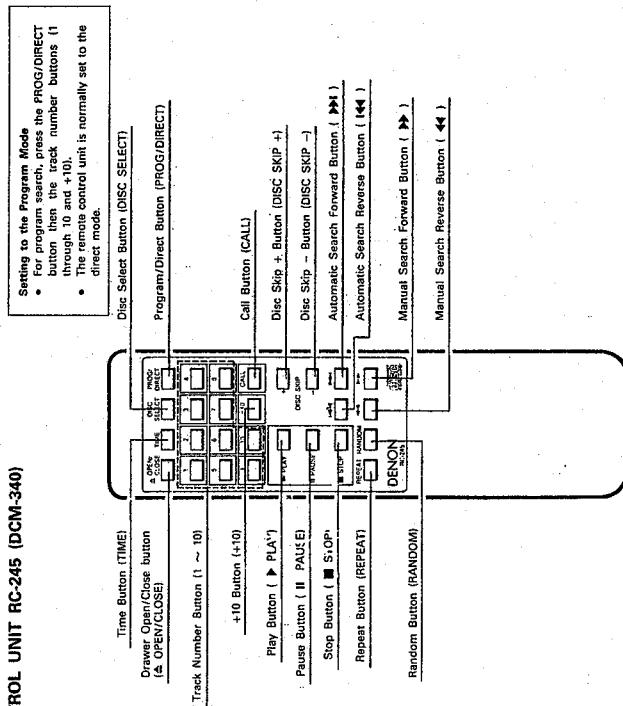

- Disc Selection**
 Use the DISC SELECT and number buttons to select the number of the disc to be played.
 "..." appears on the disc number section of the display for 2 seconds when the DISC SELECT button is pressed. Press the number button corresponding to the number of the disc to be played while "..." is displayed to select the disc number. Track numbers are selected if the number buttons are pressed while "..." is not displayed on the disc number section of the display.
- Direct Selection**
 Normally, direct search is possible simply by pressing the desired number buttons.
- Skiping Discs**
 The Disc Skip button (DISC SKIP +) will not function in the random and program modes.
 During disc sequential random playback, when the Disc Skip + button is pressed, the following disc is played in random order.
- Program Selection** (During playback, the track which is currently playing is programmed as the 1st track.)
 Press the PROG/DIRECT button, then press the number buttons.
 For example, to program tracks number 3, 11, and 5, press PROG/DIRECT → 3 → 11 → 5.
 To cancel the program, press the PROG/DIRECT button.
 For track numbers below 10, simply press the corresponding number buttons.
 For track numbers of 11 and greater, press the +10 button. For example, for track number 22, press +10 twice then 2.
- The Time Indicator** indicates the amount of elapsed time for the track currently being played, the amount of time remaining for the current track and the amount of time remaining for all tracks yet to be played.
 Normally, the amount of elapsed time for the current track is displayed by the [SKIP] indicator. Pressing this button causes the [SKIP] indicator to light up, displaying the amount of time remaining for the current track. Pressing the button once more turns the [SKIP] indicator off and causes the [TOTAL] indicator to light up, displaying the time remaining for all tracks yet to be played on the disc. Pressing the button once again turns the [TOTAL] indicator off and causes the indicator to display the elapsed time for the current track.
 During playback, the total remaining time is the remaining time for the disc. For programmed playback, the remaining time for the program is only displayed when the programmed tracks are all on the same disc.
 In the case of 21st and subsequent tracks, the time remaining for one track is displayed "..." When 21st and subsequent tracks is programmed, the time remaining for all tracks is displayed "..."
 "..." is displayed when tracks on more than one disc are programmed.

COMPACT DISCS

- Cautions in Handling Compact Discs**
 - Do not get fingerprints, oil, dirt or other substances on the compact disc. If the disc becomes dirty, wipe it off with a dry, soft cloth. DENON AMC-20/21 CD Cleaner is recommended.
 - Do not clean compact discs with benzene, paint thinner, water, record spray, anti-static agent, silicon cloth or similar substances.
 - Take particular care to prevent scratches to the back side of the compact disc when removing it from the case and when inserting it in its case.
 - Do not bend compact discs.
 - Do not apply to compact discs.
 - Do not attempt to enlarge the center hole of the disc.
 - Do not write on the label (printed) side of the disc with a ball point pen or pencil.
 - Bringing a CD into a warm room from a cold place could cause moisture to condense on the disc surface. Do not attempt to dry the disc with a hair dryer, etc.
- Storage of Compact Discs**
 - After play, be sure to remove the disc from the player.
 - To prevent dust, scratches, deformation, etc., be sure to store compact discs in their case.
 - Do not store compact discs in the following locations or time.
 - Places where direct sunlight strikes for long periods of time.
 - Places with a high humidity or a lot of dust.
 - Places reached by heat from a heater or similar appliances.

TROUBLE? CHECK THE PLAYER TO FIND WHAT'S WRONG

- Even when it appears that there is trouble, check the following points carefully.
- The drawer won't open/close when the Open/Close button is pressed.
- Is the Power switch on? See page 9.
 - After a disc is loaded (0 00 00h, 00h), is displayed in the display window?
 - Is the disc loaded correctly? See page 8, 10, 19.
 - Play does not begin when the Play button is pressed.
 - Is the disc dirty or scratched? See page 19.
 - There is no sound, or the sound is distorted.
 - Is the output cord connected correctly to the amplifier? See page 9.
 - Does the sound return to normal when the amplifier's knobs are adjusted or the proper input device is selected? See page 9.

SPECIFICATIONS

AUDIO	
Number of Channels	2 Channels
Frequency Characteristics	~20,000 Hz
Dynamic Range	98 dB
S/N Ratio	106 dB
High Frequency Distortion	0.003% (1kHz)
Separation	100 dB (1kHz)
Wow and Flutter	Less than the measuring (-0.001% W, peak)
Output Voltage	2.0 V, Variable 0 ~ 2.0V
DISC USED	Audio compact discs are used
OVERALL	12 cm (5 in) and 8 cm (3 in)
Power Supply	50/60 Hz, Voltage is shown on rating label
Power Consumption	11 W
External Dimensions	424 (W) x 114 (H) x 398 (D) mm (17-3/32" x 4-17/32" x 15-9/32")
Weight	5.7 kg (13 lbs.) 5.7 kg (13 lbs)

FUNCTIONS AND DISPLAY	
Functions	Five discs can be used, Direct Track Selection, Program Selection, Random Play, etc.
Displays	Disc No., Track No., Time (min., sec.), Play, Pause, Repeat, Random, etc.
Other	Headphone Jack
REMOTE CONTROL UNIT RC-245 (DCM-440)	Level Variable (DCM-440)
Remote Control Method	Infrared Pulse system
Power Supply	3 V DC Two R03 (standard SIZE AAA)
External Dimensions	60 (W) x 160 (H) x 18 (D) mm (2-3/8" x 6-1/8" x 3/8")
Weight	100g (approx. 3.5 oz) (includes batteries)
REMOTE CONTROL UNIT RC-245 (DCM-340)	
Remote Control Method	Infrared Pulse system
Power Supply	3 V DC Two R03 (standard SIZE AA)
External Dimensions	50 (W) x 175 (H) x 18 (D) mm (1-31/32" x 6-57/64" x 45/64")
Weight	100g (approx. 3.5 oz) (includes batteries)

* Design and specifications are subject to change without notice in the course of product improvement.

SPECIFICATIONS

	DCM-440	DCM-340	FUNCTIONS AND DISPLAY	
AUDIO			Functions	Five discs can be used, Direct Track Selection, Program Selection, Random Play, etc.
Number of Channels	2 Channels		Displays	Disc.No., Track No., Time (min., sec.), Play, Pause, Repeat, Random, etc.
Frequency Characteristics	4 ~ 20,000 Hz		Other	Headphone Jack (Level Variable) (DCM-440)
Dynamic Range	98 dB	98 dB	REMOTE CONTROL UNIT RC-246 (DCM-440)	
S N Ratio	107 dB	106 dB	Remote Control Method	Infrared Pulse system
High Frequency Distortion	0.003% (1kHz)	0.003%	Power Supply	3 V DC Two R03 (standard SIZE AAA)
Separation	100 dB (1kHz)	98 dB	External Dimensions	60 (W) × 160 (H) × 16 (D) mm (2-23/64" × 6-19/64" × 5/8")
Wow and Flutter	Less than the measuring (+ 0.001% W. peak)		Weight	100g (approx. 3 oz) (Includes batteries)
Output Voltage	2.0 V, Variable 0 ~ 2.0V		REMOTE CONTROL UNIT RC-245 (DCM-340)	
DISC USED	Audio compact discs are used 12 cm (5 in) and 8 cm (3 in)		Remote Control Method	Infrared Pulse system
OVERALL			Power Supply	3 V DC Two R6P (standard SIZE AA)
Power Supply	50/60 Hz, Voltage is shown on rating label.		External Dimensions	50 (W) × 175 (H) × 18 (D) mm (1-31/32" × 6-57/64" × 45/64")
Power Consumption	11 W		Weight	100g (approx. 3 oz) (Includes batteries)
External Dimensions	434 (W) × 114 (H) × 388 (D) mm (17-3/32" × 4-17/32" × 15-9/32")			
Weight	5.7 kg (13 lbs.)	5.7 kg (13 lbs)		

* Design and specifications are subject to change without notice in the course of product improvement.

ADVARSEL : USYNLIG LASERSTRÅLING VED ÅBNING, NÅR SIKKERHEDSAFBRYDERE ER UDE AF FUNKTION. UNDGÅ UDSAETTEELSE FOR STRÅLING.

VARO! AVATTAESSA JA SUOJALUKITUS OHITETTAESSA OLET ALTTIINA NÄKYMÄTTÖMÄLLE LASERSÄTEILYLLE. ÄLÄ KATSO SÄTEESEEN.

WARNING – OSYNLIG LASERRSTRÅLNING NÅR DENNA DEL ÄR ÖPPNAD OCH SPÄRREN ÄR URKOPPLAD. BETRakta EJ STRÅLEN.

**NOTE FOR HANDLING OF LASER PICK-UP
DESCRIPTION OF THE COMPONENTS**

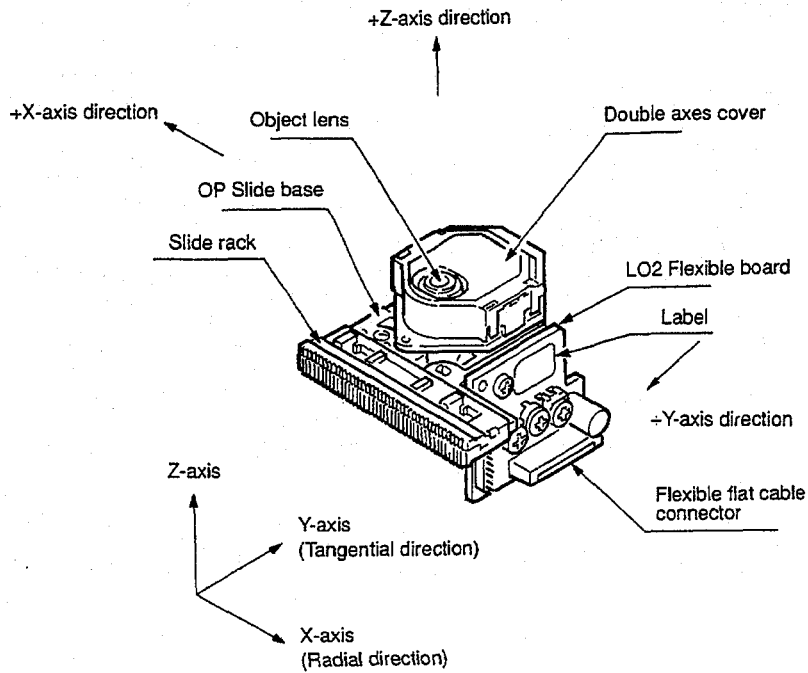

Label

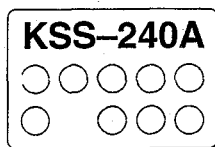

Lot No.
LD drive current

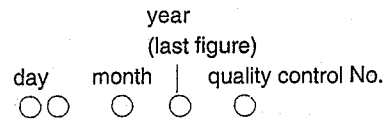

but Oct. Nov. and Dec. are expressed by alphabetical letters of X, Y and Z.

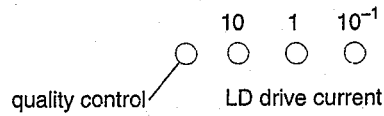

The expressed unit is by mA, with omission of the decimal point as for example, 56.5mA will be expressed as 565, but the head of English letter means the control in the manufacturing plant.

PIN CONNECTOR

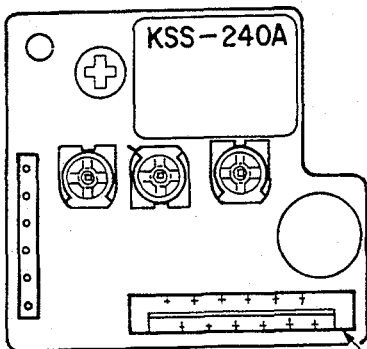

1 3 5 7 9 11
2 4 6 8 10 12

Flexible flat cable connector

Pin No.	Description	Input/Output	Pin No.	Description	Input/Output
1	VC (+2.5V)	OUT	7	Vcc (+5V)	IN
2	TE (TRK ER signal)	OUT	8	LDC (LD Control)	IN
3	FE (FCS ER signal)	OUT	9	FCS+ (Double axes)	IN
4	FZC (FZC signal)	OUT	10	TRK+ (Double axes)	IN
5	RF (RF signal)	OUT	11	TRK- (Double axes)	IN
6	GND	IN	12	FCS- (Double axes)	IN

Caution for Handling the Laser Pick-up

The laser pick-up KSS-240A is assembled and precisely adjusted using a sophisticated manufacturing process in our plant. Do not disassemble or attempt to readjust it. Please keep the following instructions carefully in handling pick-up.

1. Handle with Care

- (1) Storage
Do not store the pick-up in dusty, high-temperature or high-humidity environments.
- (2) Please take care for preventing from shock by falling down or careless handling.

2. Laser Diode (LD)

- (1) Protect your eyes
The laser beam may damage the human eye, since the intensity of the focused spot may reach $7 \times 10^3 \text{ W/cm}^2$ even if the intensity at the objective lens is 400 μW maximum. As the light beam spreads after focused through the objective lens, it does not effect you in the place as far as more than 30 cms. However, do not look at the laser light beam either through the objective lens directly nor another lens or a mirror.
- (2) Poison of As
Since the LD chip contains As (Arsenic), as GaAs + GaAlAs, as known as the poison, although the poison is relatively weak, in comparing with others, e.g. As₂O₃, AsCl₃ etc., and the amount is small, avoid putting the chip in acid or an alkali solution, heating it over 200°C or putting it into your mouth.
- (3) Avoid surge current or electrostatic discharge
The LD may be damaged or deteriorated by its own strong light if a large current is supplied to it, even if only a short pulse. Make sure that there is no surge current in the LD driving circuit by switches or else. Be careful to handle pick-up as it may be damaged in a moment by human electrostatic discharge. The pins of the LD are short-circuited by solder for protection during shipment.
For safety handling of an LD, grounding the human body, measuring equipments and jig is strongly recommended. And still it is further desirable to make use of mat on the platform and floor for handling the LD.
To open the short circuit, remove the soldering quickly with a soldering iron whose metal part is grounded.
The temperature of the soldering iron should be less than 320°C (30W).

3. Actuator

- (1) The performance of the actuator may be effected if magnetic material is located nearby, since the actuator has a strong magnetic circuit. Do not permit dust to enter through the clearance of the cover.
- (2) Cleaning the lens
It may change the specifications by attaching dust or ash on the objective lens. Clean the lens with a cleaning paper dampened with a little water, not pressing lens with so much strength by the cleaning paper.

4. Metal Bearing

As the metal bearing of Cu-compound sintered alloy is impregnated with FROIL946P (*Part No. 529 0054 007), never fail to supply the bushing with the same lubricant at the time of replacing the pick-up.

5. Handling

Please handle the laser pick-up with holding the side base (rosin molded part).

When either a part of human body or some other things may happen to touch directly with the circuit part of P.W.Board, it may cause deterioration, take careful attention in handling this base.

6. Deterioration

As KSS-240A comprises built-in RF Amp and APC circuit, it resists stronger against external electrostatic damages than the former typed pickup. However, there is possibility of pickup distortion in the following cases.

- (1) Low HF level, or with great numbers of jitters.
- (2) Tracking offset (EF Balance) is out of order (Refer to "Confirmation Method of Adjustment" for confirmation on (1) and (2)).

DISASSEMBLY

● **Top Cover**

Remove 4 screws from both sides and 1 screw from Rear Panel and slide Top Cover slightly background (approx. 5mm) and pull it up.

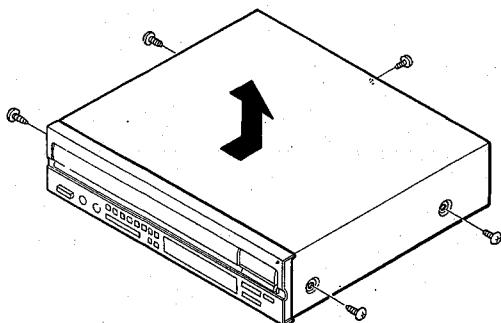

● **PU Mechanism**

After removing rear panel, remove 1 screw.

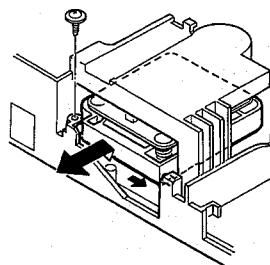

● **Front Panel**

1. Remove 3 hooks from bottom surface of unit.
2. Remove screws fixing front bracket and detach subpanel from hook of the front bracket.

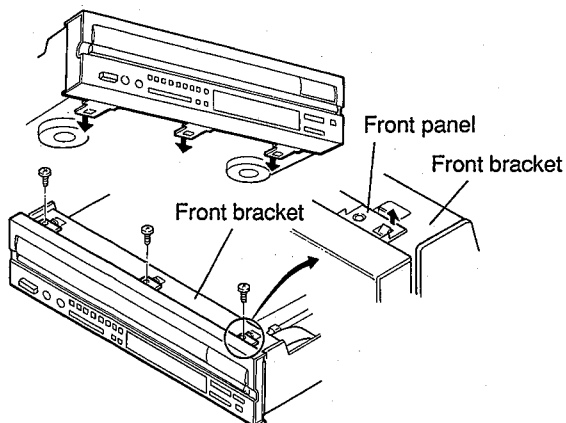

● **Bottom Cover**

1. Remove 3 screws fixing foot and 5 screw fixing bottom cover and 3 screws fixing rear panel, 10 in total. (These screws are P-tight type)
Do not remove screws marked with ★. (This screw is S-tight type)

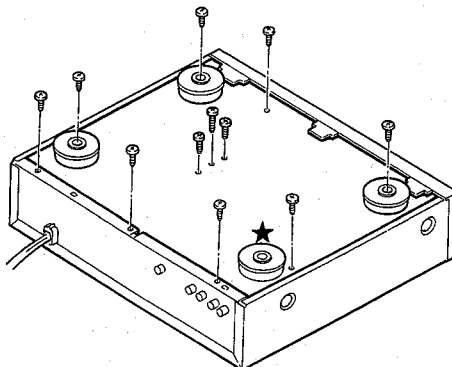

● **Loader Frame Ass'y**

1. Remove hooks of loader frame, and pull out 2 loader brackets from right and left sides.
2. Pull the loader frame assembly frontward.

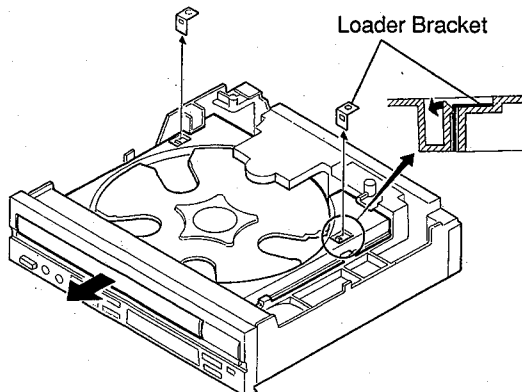

2. ① Slide the bottom cover backward (approx. 5mm) and when it touches the rear panel in end, ② lift up front portion of the bottom cover and pull it.

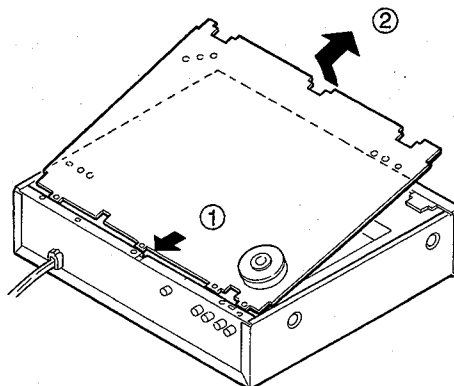

ADJUSTMENT

Microcomputer built in the unit, comprises service program to facilitate servo adjustment by pushing operation button.

1. Start service program

- (1) Turn power switch OFF.
- (2) Shortcircuit ④ pin (SWOP) and ③ pin (SWCL) of TP102 on P.W.B. (Main Unit)
(Caution) Do not touch other pins.
- (3) Turn power switch ON.
(Service program starts, and displays track number 01)

(Caution)

- When service program started normal operation of buttons will be defeated.

2. Service program function • Make sure a disc has been loaded in the NO.1 disc tray.

Button	Function	Description
▲ OPEN/CLOSE	Opens or closes the disc holder.	<ul style="list-style-type: none"> • Opens or closes only when disc is stopped. • Operate other keys after open or close.
■ STOP	Stops system function.	<ul style="list-style-type: none"> • Displays track number 01. • Push when adjustment completed, or do it again.
▶ PLAY	Starts focus servo and disc turns.	<ul style="list-style-type: none"> • Push when adjust tracking offset. • When completed, displays track number 02.
PAUSE	Starts focus servo, tracking servo, slide servo, spindle servo.	<ul style="list-style-type: none"> • When PAUSE button is pushed, starts tracking servo and slide servo. • When completed, track number 03.
Other button	No normal operation.	<ul style="list-style-type: none"> • Do not operate buttons other than above. • If misoperated, immediately turn power switch OFF.

(Caution)

- Do not use remote control during service program mode.

3. Adjustment

(1) Location

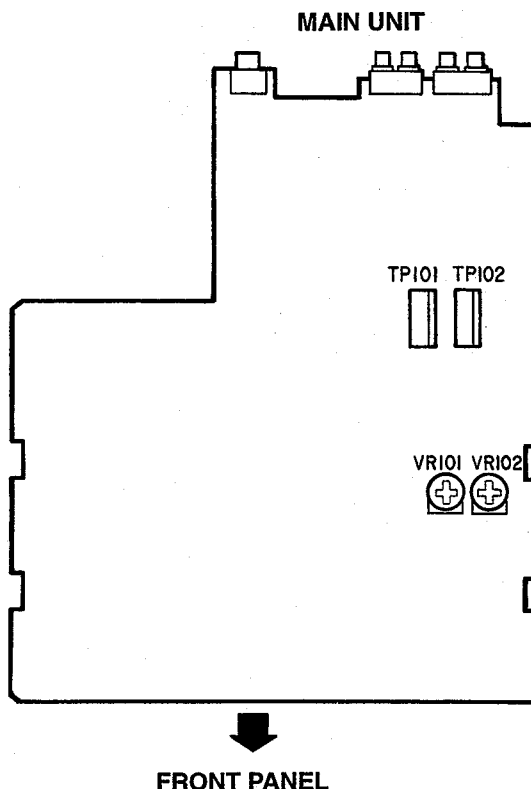

(Caution)

- When playing back in state of open top cover, there may be possibility of playback failure due to light entering into disc detection sensor. In such case, shield the light by hand or others so that the light does not come into sensor.

TP101	TP102
⑥ TEI	⑥ +5V
⑤ VC	⑤ NC
④ FOK	④ SWOP
③ TEO	③ SWCL
② FEI	② GND
① FEO	① HF

(2) Necessary equipment for adjustment

1. Dual trace oscilloscope
2. Reference disc (CA-1094)
3. Oscillator (10 Hz ~ 10 kHz, 0 ~ 3 Vp-p)
4. Frequency counter (readable more than 5 KHz)
5. Filter for measurement

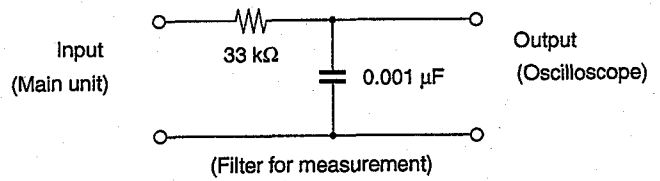

(3) Preset

1.	Start service program.							
2.	Preset VR101, 102 as per right figure.	<table style="width: 100%; border-collapse: collapse;"> <tr> <td style="width: 30%;">VR101 (F-GAIN)</td> <td style="width: 20%; text-align: center;"></td> <td style="width: 50%; text-align: right;">6 O'clock</td> </tr> <tr> <td>VR102 (F-GAIN)</td> <td style="text-align: center;"></td> <td style="text-align: right;">6 O'clock</td> </tr> </table>	VR101 (F-GAIN)		6 O'clock	VR102 (F-GAIN)		6 O'clock
VR101 (F-GAIN)		6 O'clock						
VR102 (F-GAIN)		6 O'clock						
3.	Step.	<ol style="list-style-type: none"> 1. Focus gain (VR101) 2. Tracking gain (VR102) 3. Tracking offset recheck 4. HF Level recheck 						

4. Focus gain

Connection							
Oscillator	Counter	Oscilloscope	Adjust	Check	Step		
930 Hz 2 Vp-p (±0.1 V)	930 Hz	<table border="1" style="width: 100%; border-collapse: collapse;"> <tr> <td style="width: 50%;">V</td> <td style="width: 50%;">H</td> </tr> </table> <ul style="list-style-type: none"> ● DC range ● X-Y mode 	V	H	VR101	(Oscilloscope) Y axis X axis Phase 90° Waveform not right Y axis X axis	<ol style="list-style-type: none"> 1. Push PAUSE. (Displays track number 03) 2. Connect oscillator. 3. Set oscillator to 930 Hz/2 Vp-p. 4. Switch oscilloscope input to X-Y mode. 5. Adjust VR101 [F-GAIN] to symmetrize Lissajous figures to X-Y axes.
V	H						

5. Tracking gain

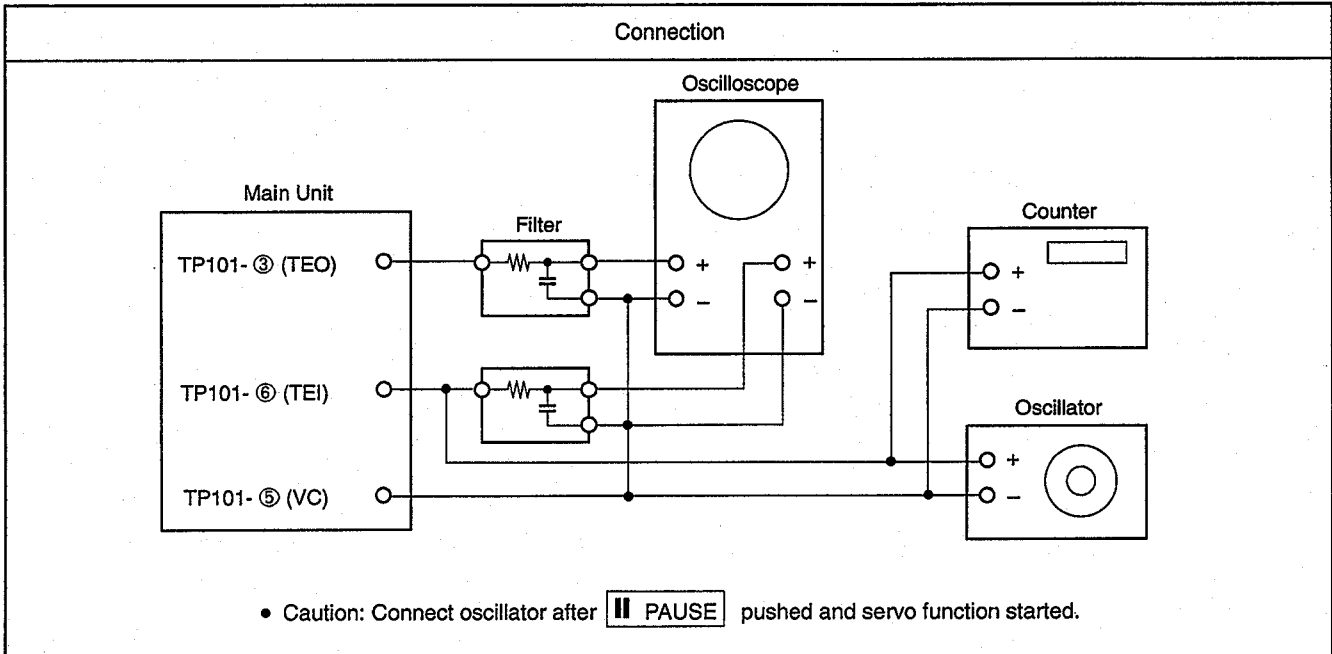

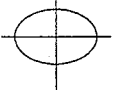
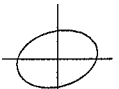
Oscillator	Counter	Oscilloscope		Adjust (Volume)	Check (Oscilloscope)	Step
		V	H			
<ul style="list-style-type: none"> ● 2.7 kHz (±120 Hz) ● 0.8 Vp-p (±0.1V) 	2.7 kHz (±120 Hz)	<ul style="list-style-type: none"> ● DC range ● X-Y mode 		VR102	Y axis  X axis Phase 90° Waveform not right Y axis  X axis	<ol style="list-style-type: none"> 1. Push PAUSE. (Displays track number 03) 2. Connect oscillator. 3. Set oscillator to 2.7 kHz/0.8 Vp-p. 4. Switch oscilloscope input to X-Y mode. 5. Adjust VR102 [T-GAIN] to symmetrize Lissajous figures to X-Y axes.

6. Tracking offset (E/F Balance)

Connection			
Oscilloscope		Check	Step
V	H	(Oscilloscope)	<ol style="list-style-type: none"> 1. Push ▲ OPEN/CLOSE and load disc holder reference disk. 2. Push ▲ OPEN/CLOSE and close disc holder. 3. Push ▶ PLAY to turn disc. (Displays track number 02) 4. Short (+)(-) of oscilloscope and check the base line. 5. Confirm that upper and lower amplitude of the waveform is symmetric against 0V.
0.1v/div	1-2 ms/div		



7. HF level

Connection			
Oscilloscope		Check	Step
V	H	(Oscilloscope)	<ol style="list-style-type: none"> 1. Push PAUSE. (Displays track number 03) 2. Check HF level of oscilloscope. 3. Confirm that the waveform is in good shape. (◊ pattern in center must be able to discriminate clearly.)
50mv/div or 20mV/div	0.2μ/div or 0.5μ/div	 	
		<ul style="list-style-type: none"> • Set input mode to ALTERNATE or CHOPPER. 	

HEAT RUN MODE FUNCTION

Heat Run Mode

1) To activate

While hold pushing PAUSE (), STOP (), buttons simultaneously, turn the unit power on. The remote control sensor indicator will light to show that the unit is shifted in Heat Run mode.

Be sure to load the disc previously.

Press the disc holder open/close button ( OPEN/CLOSE) to cancel Heat Run mode.

★ This mode functions only for a disc with 21 pieces of music or more. For a disc with 20 pieces of music or lesser, please do not use.

2) Operation

During the Heat Run mode to shift the unit in Play mode makes the unit replays from the first music after opens the loader once and re-closes it when finish playing the last track (comes into lead out).

Hereafter, operates open/close of loader, servo on, reading of TOC, and playing repeatedly, and repeats playing the two tracks; the first and the last ones.

3) Error Message

When the system error occurs while in Heat Run mode, the following error message will display on the Track No. indicator and stops operation.

1. E1

At the time of Focus Servo does not activate.

2. E2

When unable to detect synchronous pattern however the disc is in rotating. (GFS does not drive.)

3. E3

No synchronous pattern can be detected while in Play mode. (No GFS drives.)

4. E4

When TOC is unreadable in despite of servo is activated.

5. E5

In case of loader malfunctions. (Unable to turn on the switch.)

6. E6

The inner circle switch of Pick-up does not turn off.

7. E7

The inner circle switch of Pick-up does not turn on.

8. E10

Improper function of Pick-up base UP/ DOWN.

9. E11

Improper function of disc Select.

★ The number of operation up to the stop will be displayed on the minute and second portion of the indicator.





(Note)

Initializing of IC703 (NM24C08)

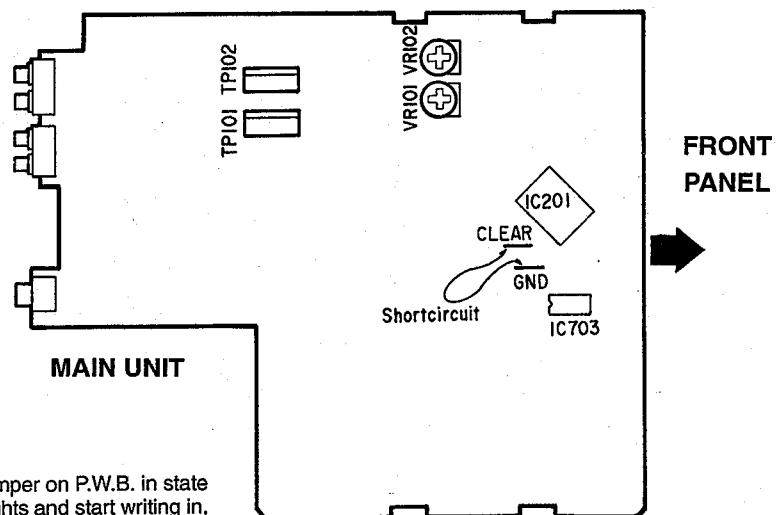
[Only for DCM-440]

* In case initializing is necessary due to replacement of IC703, initialize IC703 following to the undermentioned procedure.



When momentary shortcircuit "CLEAR" and "GND" of Jumper on P.W.B. in state of stop position, PLAY () and PAUSE () indicator lights and start writing in, when PLAY () and PAUSE () indicators are put out after few seconds, the initializing of IC703 is completed.

SEMICONDUCTORS

● IC's

CXD2500BQ Terminal Function

Terminal No.	Symbol	I/O		Terminal Function
1	FOK	I		Input terminal for OK focusing. Use for Servo-autosequencer.
2	FSW	O	Z,0	Output to shift time constant of output filter for spindle motor.
3	MON	O	1,0	ON/OFF control output for spindle motor.
4	MDP	O	1,Z,0	Servo control for spindle motor.
5	MDS	O	1,Z,0	Servo control for spindle motor.
6	LOCK	O	1,0	Sampling GFS by 460 Hz and if it is "H", delivers "H" ; if it is continuously "L" 8 times, delivers "L".
7	NC		—	
8	VCOO	O	1,0	Oscillation current output for analog EFM PLL.
9	VCOI	I		Oscillation current output for analog EFM PLL. f LOCK=8.6436MHz.
10	TEST	I		TEST output. Normally GND.
11	PDO	O	1,Z,0	Charge pump output for analog EFM PLL.
12	Vss			GND.
13	NC		—	
14	NC		—	
15	NC		—	
16	VPCO	O	1,Z,0	Charge pump output for variable pitch PLL.
17	VCKI	O		Clock input from external VCO for variable pitch. fc center=16.9344MHz.
18	FILO	O	Analog	Filter output for master PLL. (slave=digital PLL)
19	FILI	I		Filter input for master PLL.
20	PCO	O	1,Z,0	Charge pump output for master PLL.
21	AVss			Analog GND.
22	CLTV	I		Control voltage input for master VCO.
23	AVDD			Analog power supply (+5V).
24	RF	I		EFM signal input.
25	BIAS	I		Constant-current input for Asymmetry circuit.
26	ASYI	I		Comparator voltage input for Asymmetry.
27	ASYO	O	1,0	Full swing output for EFM. (L=Vss, H=VDD).
28	ASYE	I		L: Asymmetry circuit → OFF. H: Asymmetry circuit → ON.
29	NC		—	
30	PSSL	I		Input to shift output mode of audio data. Serial output at L; parallel output at H.
31	WDCK	O	1,0	D/A Interface for 48 bit slot. Word-clock f=2 Fs.
32	LRCK	O	1,0	D/A Interface for 48 bit slot. LR-clock f= Fs.
33	VDD			Power supply (+5V).
34	DA16	O	1,0	At PSSL=1 for DA16 (MSB) output; PSSL=0 for serial data of 48 bit slot. (2s'COMP, MSB first).
35	DA15	O	1,0	At PSSL=1 for DA15 output; PSSL=0 for bit clock of 48 bit slot.
36	DA14	O	1,0	At PSSL=1 for DA14 output; PSSL=0 for serial data of 64 bit slot. (2s'COMP, LSB first).
37	DA13	O	1,0	At PSSL=1 for DA13 output; PSSL=0 for bit clock of 64 bit slot.
38	DA12	O	1,0	At PSSL=1 for DA12 output; PSSL=0 for LR clock of 64 bit slot.
39	DA11	O	1,0	At PSSL=1 for DA11 output; PSSL=0 for GTOP output.
40	DA10	O	1,0	At PSSL=1 for DA10 output; PSSL=0 for XUGF output.
41	DA09	O	1,0	At PSSL=1 for DA09 output; PSSL=0 for XPLCK output.
42	DA08	O	1,0	At PSSL=1 for DA08 output; PSSL=0 for GFS output.
43	DA07	O	1,0	At PSSL=1 for DA07 output; PSSL=0 for RFCK output.
44	DA06	O	1,0	At PSSL=1 for DA06 output; PSSL=0 for C2PO output.
45	DA05	O	1,0	At PSSL=1 for DA05 output; PSSL=0 for XRAOF output.
46	DA04	O	1,0	At PSSL=1 for DA04 output; PSSL=0 for MNT3 output.
47	DA03	O	1,0	At PSSL=1 for DA03 output; PSSL=0 for MNT2 output.
48	DA02	O	1,0	At PSSL=1 for DA02 output; PSSL=0 for MNT1 output.
49	DA01	O	1,0	At PSSL=1 for DA01 output; PSSL=0 for MNT0 output.
50	APTR	O	1,0	Control output for aperture compensation. In H for R-ch.
51	APTL	O	1,0	Control output for aperture compensation. In H for L-ch.

Terminal No.	Symbol	I/O	Terminal Function
52	Vss		GND.
53	XTAI	I	X'tal oscillation circuit input. By selecting of mode, f=16.9344MHz or 33.8688MHz.
54	XTAO	O 1,0	X'tal oscillation circuit input. f=16.9344MHz.
55	XTSL	I	Selection input terminal of X'tal. "L" for X'tal 16.9344MHz; "H" for 33.8688MHz.
56	FSTT	O 1,0	2/3 Dividing output of 53 and 54 terminal. No change by variable pitch.
57	C4M	O 1,0	4.2336MHz output. When variable pitched, simultaneously changes.
58	C16M	O 1,0	16.9344MHz output. When variable pitched, simultaneously changes.
59	MD2	I	Digital-out ON/OFF control. ON at H; OFF at L.
60	DOUT	O 1,0	Digital-out output terminal.
61	EMPH	O 1,0	When playback disc emphasized, outputs H; otherwise outputs L.
62	WFCK	O 1,0	WFCK (Write Flame Clock) output.
63	SCOR	O 1,0	Output of subcode sync. S0+S1. H output when either one detected.
64	SBSO	O 1,0	Serial output of Sub P-W.
65	EXCK	I	Clock input for SBSO read-out.
66	SQSO	O 1,0	Output for Sub Q 80 bits and PCM peak level 16 bits.
67	SQCK	I	Clock input for SQSO read-out.
68	MUTE	I	Mute at H; remove mute at L.
69	SENS	— 1,Z,0	SENS output. Outputs to CPU.
70	XRST	I	System reset input. Resets at "L".
71	DATA	I	Input of serial data from CPU.
72	XLAT	I	Input for latch from CPU. Latches serial data at release.
73	Vdd		Power supply (+5V).
74	CLOCK	I	Serial data transfer clock input from CPU.
75	SEIN	I	SENS input from SSP.
76	CNIN	I	Input of tracking pulse.
77	DATO	O 1,0	Serial data output to SSP.
78	XLTO	O 1,0	Serial data latch output to SSP.
79	CLKO	O 1,0	Serial data transfer clock output to SSP.
80	MIRR	I	Mirror signal input. Use for track jump for over 128 tracks, using autosequencer.

CXD2500BQ

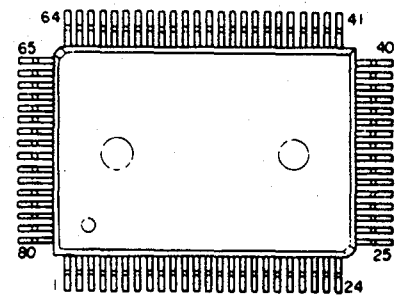
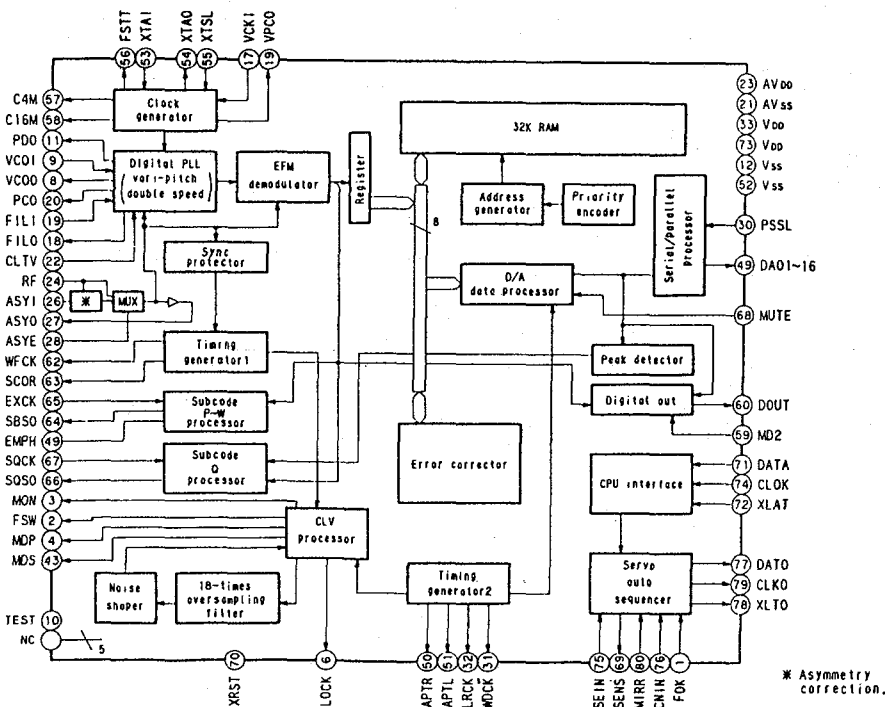

CXA1372S Terminal Function

Terminal No.	Symbol	I/O	Terminal Function
1	TE	I	Tracking error signal input terminal.
2	TDFCT	I	Capacitor connecting terminal for time constant at the time of defect.
3	ATSC	I	Input terminal of ATSC detecting window comparator.
4	FZC	I	Input terminal of focus zero-cross comparator.
5	FE	I	Focus error signal input terminal.
6	FDFCT	I	Capacitor connecting terminal for time constant at the time of defect.
7	Vc	I	Mid-point voltage input terminal.
8	FGD	I	In case of reducing higher range gain of focus servo, connect a capacitor between this terminal and terminal number (9).
9	FS3	I	Shifts higher range gain of focus servo by FS3 ON/OFF.
10	FLB	I	Terminal for external time constant to increase lower range of focus servo.
11	FEO	O	Focus drive output.
12	FE-	I	Reverse input terminal for focus amplifier.
13	SRCH	I	Terminal for external time constant to make focus search waveform.
14	TGU	I	Terminal for external time constant to shift higher range gain of tracking.
15	TG2	I	Terminal for external time constant to shift higher range gain of tracking.
17	TAO	O	Tracking drive output.
18	TA-	I	Reverse input terminal for tracking amplifier.
19	SL+	I	Non-reverse input terminal for sled amplifier.
20	SLO	O	Sled drive output.
21	SL-	I	Reverse input terminal for sled amplifier.
22	FSET	I	Terminal to compensate peak in focus/tracking phase.
23	ISET	I	Delivers a current to set the height of focus search, track jump, and sled kick.
24	SSTOP	I	Terminal for limit switch ON/OFF to detect disc innermost circle.
26	DIRC	I	Terminal is used at the time of 1 track jump. A 47 kohm pull up resistor is included.
27	LOCK	I	Reckless drive protection circuit of sled; activates at "L". A 47k ohm pull up resistor is included.
28	CLK	I	Serial data transfer clock input from CPU.
29	XLT	I	Latch input from CPU.
30	DATA	I	Serial data input from CPU.
31	XRST	I	Reset input terminal. Resets at "L".
32	C.OUT	O	Terminal to output signal for track number count.
33	SENS	O	Terminal to output FZC, AS, TZC, SSTOP by command from CPU.
35	MIRR	O	Output terminal for MIRR comparator.
36	DFCT	O	Output terminal for DEFECT comparator.
37	ASY	I	Input terminal for auto-symmetric control.
38	EFM	O	Output terminal for EFM comparator.
39	FOK	O	Output terminal for focus OK (FOK) comparator.
40	CC1	O	DEFECT bottom hold output terminal.
41	CC2	I	Input terminal to input DEFECT bottom hold output by capacitance combination.
43	CB	I	Capacitor connecting terminal for DEFECT bottom hold.
44	CP	I	MIRR hold capacitor connecting terminal. A non-reverse input terminal for MIRR comparator.
45	RFI	I	Input terminal to input RF summing amplifier output by capacitance combination.
46	RFO	O	Output terminal for RF summing amplifier. Check point for eye pattern.
48	TZC	I	Tracking zero-cross comparator input terminal.

CXA1372S

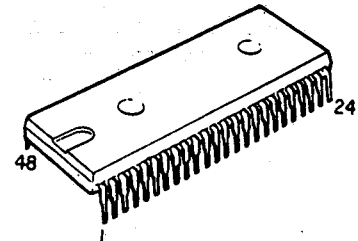
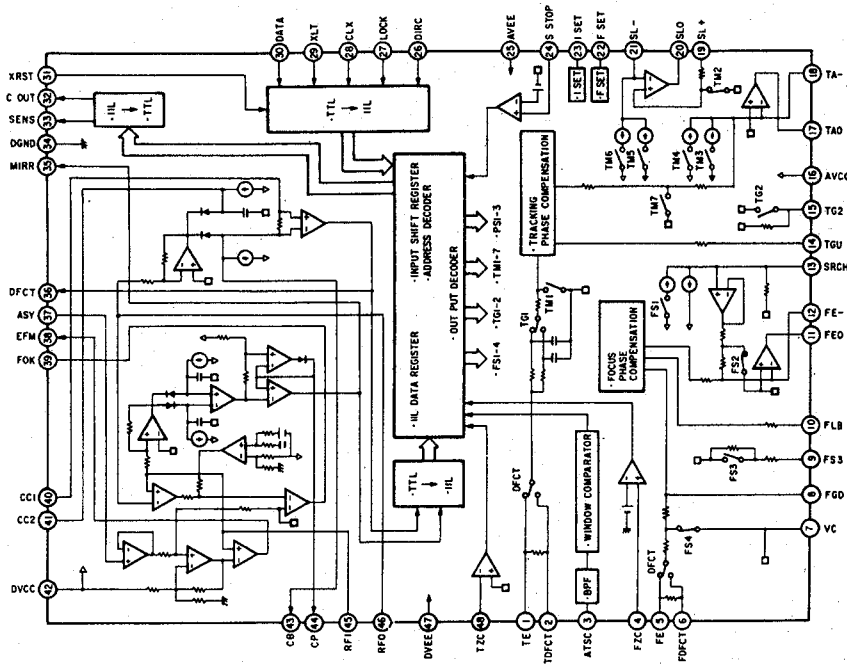

PCM-1700L Terminal Function

Terminal No.	Symbol	Function	Terminal No.	Symbol	Function
1	-Vcc	Analog Negative Supply.	15	LEC	Latch Enable Control Input
2	SERVO DC(L)	Servo Filter (L-ch)	16	DATA (R)	Data Input (R-ch)
3	MSB ADJ (L)	MSB Adjust (L-ch)	17	D. GND	Digital Ground
4	NC	No connection	18	NC	No Connection
5	BPO DC (L)	Offset Filter (L-ch)	19	Vout (R)	Voltage Output (R-ch)
6	Iout (L)	Current Output (L-ch)	20	S.J (R)	Summing Junction (R-ch)
7	A. GND	Analog Ground	21	A. GND	Analog Ground
8	S. J(L)	Summing Junction (L-ch)	22	Iout (R)	Current Output (R-ch)
9	Vout(L)	Voltage Output (L-ch)	23	BPO DC (R)	Offset Filter (R-ch)
10	NC	No connection	24	MSB ADJ (R)	MSB Adjust (R-ch)
11	+Vdd	Digital Positive Supply	25	SERVO DC (R)	Servo Filter (R-ch)
12	DATA (L)	Data Input (L-ch)	26	Vpot	V trim
13	CLOCK	Clock Input	27	+Vcc	Analog Positive Supply
14	-Vdd	Digital Negative Supply	28	D. GND	Digital Ground

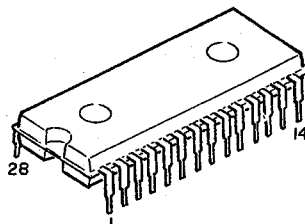

UPD78043GF-019

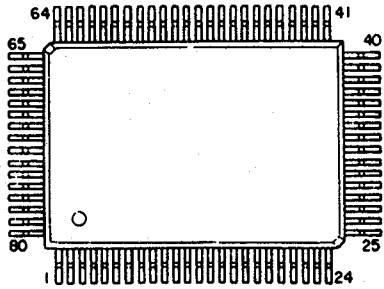

BA15218
TL4558P-B

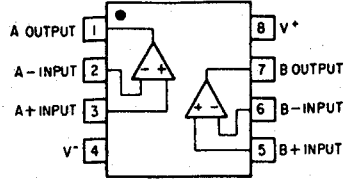
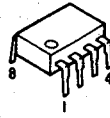

NM24C08N

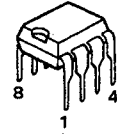

TC74HCU04AP

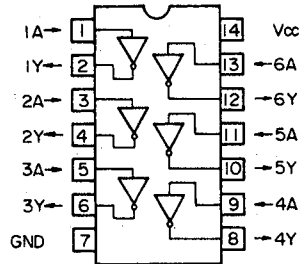
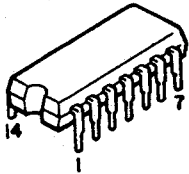

M5290P

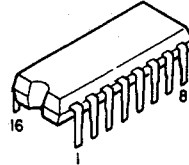

SM5841BP
MN6632A

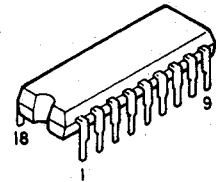

● IC PROTECTOR

ICP-N15

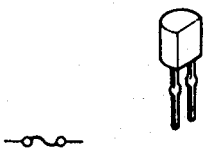

● TRANSISTOR

2SD1913
2SB1274

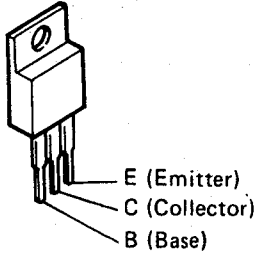

2SA933(S)
2SD2144



2SB562(C)
2SD468(C)



DTC-144ES(47k-47k)
DTC-114ES(10k-10k)
DTA-124XS(22k-47k)

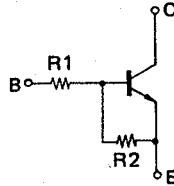
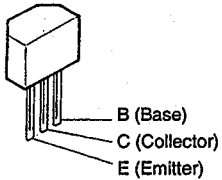

DTA-124XS (22k-47k)

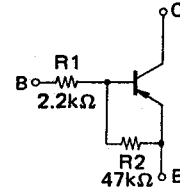

	R1	R2
DTC-144ES (47k-47k)	47kΩ	47kΩ
DTC-114ES (10k-10k)	10kΩ	10kΩ

● DIODES

1S2076A
1SS270A
1SR139

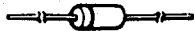

HZS7B-1
HZS30-1



1A3-I



NOTE FOR PARTS LIST

- Part indicated with the mark "◎" are not always in stock and possibly to take a long period of time for supplying, or in some case supplying of part may be refused.
- When ordering of part, clearly indicate "1" and "I" (I) to avoid mis-supplying.
- Ordering part without stating its part number can not be supplied.
- Part indicated with the mark "★" is not illustrated in the exploded view.
- Not including Carbon Film ±5%, 1/4W Type in the P.W.Board parts list. (Refer to the Schematic Diagram for those parts.)

WARNING:

Parts marked with this symbol   have critical characteristics.
Use ONLY replacement parts recommended by the manufacturer.

● **Resistors**

Ex.: FN	14K	2E	182	G	FR
Type	Shape and performance	Power	Resistance	Allowable error	Others
RD : Carbon RC : Composition RS : Metal oxide film RW : Winding RN : Metal film RK : Metal mixture	2B : 1/8W 2E : 1/4W 2H : 1/2W 3A : 1W 3D : 2W 3F : 3W 3H : 5W	F : ±1% G : ±2% J : ±5% K : ±10% M : ±20%	P : Pulse-resistant type NL : Low noise type NB : Non-burning type FR : Fuse-resistor F : Lead wire forming		

* **Resistance**

1 8 2 ⇒ 1800 ohm = 1.8 kohm
Indicates number of zeros after effective number.
2-digit effective number.
• Units: ohm

1 R 2 ⇒ 1.2 ohm
1-digit effective number.
2-digit effective number, decimal point indicated by R.
• Units: ohm

* **Capacity (electrolyte only)**

2 2 2 ⇒ 2200µF
Indicates number of zeros after effective number.
2-digit effective number.

• Units: µF.
2 R 2 ⇒ 2.2µF
1-digit effective number.
2-digit effective number, decimal point indicated by R.
• Units: µF.

● **Capacitors**

Ex.: CE	04W	1H	2R2	M	BP
Type	Shape and performance	Dielectric strength	Capacity	Allowable error	Others
CE : Aluminum foil electrolytic CA : Aluminum solid electrolytic CS : Tantalum electrolytic CO : Film CK : Ceramic	1H : 50V 2A : 100V 2B : 125V 2C : 160V 2D : 200V 2E : 250V 2H : 500V 2J : 630V	0J : 6.3V 1A : 10V	F : ±1% G : ±2% J : ±5% K : ±10% M : ±20%	Z : +80% -20% P : +100% -0% C : ±0.25pF D : ±0.5pF = : Others	HS : High stability type BP : Non-polar type HR : Ripple-resistant type DL : For charge and discharge frequency HF : For assuring high frequency U : UL part C : CSA part W : UL-CSA type F : Lead wire forming

* **Capacity (except electrolyte)**

2 2 2 ⇒ 2200µF = 0.0022µF
(More than 2) Indicates number of zeros after effective number.
2-digit effective number.

• Units: µF.
2 2 1 ⇒ 220PF
(0 or 1) Indicates number of zeros after effective number.
2-digit effective number.

• Units: PF.
• When the dielectric strength is indicated in AC, "AC" is included after the dielectric strength value.

PARTS LIST OF P.W. BOARD
(3U-2574/2574A) MAIN UNIT

Ref. No.	Part No.	Part Name	Remarks	Ref. No.	Part No.	Part Name	Remarks
SEMICONDUCTORS GROUP				CAPACITORS GROUP			
IC101	262 1305 001	IC CXA1372S		C103	255 1206 908	Film 0.0033 μ F/50V	QQ93M1H332JT
IC103-106	263 0223 006	IC TL4558P-B		C104	253 1179 990	Ceramic 560pF/50V	CK45B1H561KT
IC201	262 1807 101	Micro Computer UPD78043GF-029		C107	255 1217 900	Film 0.027 μ F/50V	QQ93M1H273JT
IC202	262 1819 005	IC CXD2500BQ		C108	255 1204 900	Film 0.0022 μ F/50V	QQ93M1H222JT
IC205	262 1265 002	IC TC74HCU04AP	DCM-440 Only	C109-112	256 1034 979	Metallized 0.1 μ F/50V	CF93A1H104JT
IC300	262 1761 001	IC SM5841BP		C113	254 4337 910	Electrolytic 6.8 μ F/50V	CE04W1H6R8MT
IC302	262 1805 006	IC PCM-1700L		C114	256 1035 910	Metallized 0.22 μ F/50V	CF93A1H224JT
IC501	263 0693 005	IC M5290P		C115	253 9036 909	Ceramic 0.1 μ F/25V	CK45=1E104ZT
IC502,503	268 0073 905	IC Protector ICP-N15T		C116	255 1212 905	Film 0.01 μ F/50V	QQ93M1H103JT
IC703	262 1806 005	IC NM24C08N	DCM-440 Only	C117	253 9036 909	Ceramic 0.1 μ F/25V	CK45=1E104ZT
IC705	263 0223 006	IC TL4558P-B		C118,119	253 1180 921	Ceramic 0.001 μ F/50V	CK45B1H102KT
IC706,707	263 0565 007	IC BA15218	DCM-440 Only	C120,121	253 1181 904	Ceramic 0.01 μ F/50V	CK45F1H103ZT
IC708	262 0640 000	IC MN6632A	DCM-440 Only	C122,123	254 4260 919	Electrolytic 0.22 μ F/50V	CE04W1HR22MT
TR101	272 0025 907	Transistor 2SB562(C) F		C124	255 1212 905	Film 0.01 μ F/50V	CF93A1H103JT
TR102	274 0036 905	Transistor 2SD468(C)TF		C125	256 1034 911	Metallized 0.033 μ F/50V	CF93A1H333JT
TR103	272 0025 907	Transistor 2SB562(C)TF		C126	255 1212 905	Film 0.01 μ F/50V	QQ93M1H103JT
TR104	274 0036 905	Transistor 2SD468(C)TF		C127	255 1206 908	Film 0.0033 μ F/50V	QQ93M1H332JT
TR105	272 0025 907	Transistor 2SB562(C)TF		C128	255 1212 905	Film 0.01 μ F/50V	QQ93M1H103JT
TR106	274 0036 905	Transistor 2SD468(C)TF		C129	255 1208 906	Film 0.0047 μ F/50V	QQ93M1H472JT
TR107	272 0025 907	Transistor 2SB562(C)TF		C131	255 1209 905	Film 0.0056 μ F/50V	QQ93M1H562JT
TR108	274 0036 905	Transistor 2SD468(C)TF		C132	253 4538 910	Ceramic 75pF/50V	CC45SL1H750JT
TR180	272 0025 907	Transistor 2SB562(C)TF		C133	253 4536 909	Ceramic 10pF/50V	CC45SL1H100DT
TR181	274 0136 009	Transistor 2SD1913		C134	253 4538 923	Ceramic 82pF/50V	CC45SL1H820JT
TR182	272 0025 907	Transistor 2SB562(C)TF		C135	254 3055 918	Electrolytic 10 μ F/35V Bipolar	CE04D1V100MBPT
TR183	274 0036 905	Transistor 2SD468(C)TF		C138	253 9036 909	Ceramic 0.1 μ F/25V	CK45=1E104ZT
TR184	272 0025 907	Transistor 2SB562(C)TF		C139	253 4537 979	Ceramic 51pF/50V	CC45SL1H510JT
TR185	274 0036 905	Transistor 2SD468(C)TF		C142	253 4537 979	Ceramic 51pF/50V	CC45SL1H510JT
TR190	269 0040 902	Transisto DTC 144ES(47K-47K)	Built in Resistor	C170,171	254 4254 938	Electrolytic 47 μ F/16V	CE04W1C470MT
TR191	278 0009 002	Transistor PT491F		C173	254 4254 938	Electrolytic 47 μ F/16V	CE04W1C470MT
TR201,202	269 0020 906	Transistor DTC114ES(10K-10K)	Built in Resistor DCM-440 Only	C175	256 1034 979	Metallized 0.1 μ F/50V	CF93A1H104JT
TR501	274 0136 009	Transistor 2SD1913		C176	253 1181 904	Ceramic 0.01 μ F/50V	CK45F1H103ZT
TR502	272 0093 007	Transistor 2SB1274		C180	253 4536 941	Ceramic 15pF/50V	CC45SL1H150JT
TR503	271 0192 905	Transistor 2SA933S(S)TP		C181	253 4538 910	Ceramic 75pF/50V	CC45SL1H750JT
TR702	269 0014 909	Transistor DTA124XS(22K-47K)	Built in Resistor	C182	253 4536 941	Ceramic 15pF/50V	CC45SL1H150JT
TR703	269 0020 906	Transistor DTC114ES(10K-10K)	Built in Resistor	C201	253 9036 909	Ceramic 0.1 μ F/25V	CK45=1E104ZT
TR704	271 0192 905	Transistor 2SA933S(S)TP		C202,203	253 1181 904	Ceramic 0.01 μ F/50V	CK45F1H103ZT
TR706-709	274 0160 907	Transistor 2SD2144STPU		C204	253 9036 909	Ceramic 0.1 μ F/25V	CK45=1E104ZT
D101	278 0010 004	LED(infrared rays) GL450		C210	256 1034 937	Metallized 0.047 μ F/50V	CF93A1H473JT
D201,202	276 0462 902	Zener Diode HZS6B-1TD	DCM-440 Only	C211	253 1180 947	Ceramic 0.0015 μ F/50V	CK45B1H152KT
D501-506	276 0613 900	Diode 1A3-I		C212	253 9036 909	Ceramic 0.1 μ F/25V	CK45=1E104ZT
D507	276 0483 907	Zener Diode HZS30-1TD	DCM-440	C223,224	253 4535 955	Ceramic 5pF/50V	CC45SL1H050CT
D507	276 0481 909	Zener Diode HZS24-1TD	DCM-340	C253	254 4254 954	Electrolytic 220 μ F/16V	CE04W1C221MT
D508	276 0465 909	Zener Diode HZS7B-1TD		C302-305	253 1180 905	Ceramic 680pF/50V	CK45B1H681KT
D701	276 0432 903	Diode 1SS270A TE		C310-312	253 1181 904	Ceramic 0.01 μ F/50V	CK45F1H103ZT
RESISTORS GROUP (not included Carbon Film \pm 5% 1/4W type)				C350,351	253 1122 905	Ceramic 0.0068 μ F/50V	CK45B1H682KT
VR101,102	211 6077 954	Adjust 22Kohm	V06PB223	C352-357	253 1181 904	Ceramic 0.01 μ F/50V	CK45F1H103ZT
VR300,301	211 6077 938	Adjust 100Kohm	V06PB104	C501	254 4254 792	Electrolytic 2200 μ F/16V	CE04W1C222MC
				C502	254 4255 717	Electrolytic 4700 μ F/16V	CE04W1C472MC
				C503	254 4254 954	Electrolytic 220 μ F/16V	CE04W1C221MT
				C504	254 4254 967	Electrolytic 330 μ F/16V	CE04W1C331MT
				C505	254 4260 964	Electrolytic 3.3 μ F/50V	CE04W1H3R3MT
				C507	254 4262 946	Electrolytic 47 μ F/63V	CE04W1J470MT
				C508	254 4261 921	Electrolytic 100 μ F/50V	CE04W1H101MT
				C509,510	254 4258 934	Electrolytic 33 μ F/35V	CE04W1V330MT
				C511	254 4260 964	Electrolytic 3.3 μ F/50V	CE04W1H3R3MT
				C704	254 4254 954	Electrolytic 220 μ F/16V	CE04W1C221MT

**PARTS LIST OF P.W. BOARD
(3U-2575A/2576) DISPLAY UNIT**

Ref. No.	Part No.	Part Name	Remarks
C706	253 4537 924	Ceramic 33pF/50V	CC45SL1H330JT
C709	253 4537 924	Ceramic 33pF/50V	CC45SL1H330JT
C710-715	254 4254 909	Electrolytic 10µF/16V	CE04W1C100MT
C720,721	254 4254 909	Electrolytic 10µF/16V	CE04W1C100MT
C730	253 9036 909	Ceramic 0.1µF/25V	CK45=1E104ZT
C731	254 4254 925	Electrolytic 33µF/16V	CE04W1C330MT
C732	253 4538 949	Ceramic 100pF/50V	CC45SL1H101JT
C733	253 1181 904	Ceramic 0.01µF/50V	CK45F1H103ZT
C900	253 9036 909	Ceramic 0.1µF/25V	CK45=1E104ZT
C910	254 3056 917	Electrolytic 1µF/50V Bipolar	CE04D1H010MBPT
C911	253 1181 904	Ceramic 0.01µF/50V	CK45F1H103ZT

OTHER PARTS

X200	399 0036 013	Crystal Oscillator(16.9344MHz)	DCM-440
X200	399 0200 904	Ceramic Oscillator	DCM-340
		(CSA16.93MX)	
X201	399 0111 006	Ceramic Oscillator	
		(CST4.23MGW040)	
PT700	231 8063 009	Pulse Trans	DCM-440 Only
JK701	204 8356 002	1P Pin Jack	DCM-440 Only
JK702,703	204 8373 001	2P Pin Jack	
JK704	204 8416 007	Mini Jack	DCM-440 Only
SW100-191	212 1072 009	Detect Switch (SSCF21)	
CB101	205 0683 006	FFC Conn.Base (12P)	
CB102	205 0343 058	5P Conn. Base(KR-PH)	
CB103	205 0406 063	6P Conn. Base(KR-PH)	
CB104	205 0543 036	3P Conn Base (YEL)	
CB105	205 0406 034	3P Conn. Base(KR-PH)	
CB106	205 0343 032	3P Conn. Base(KR-PH)	
CB107	205 0321 038	3P Conn.Base (RED)	
CB108	205 0323 036	3P Conn.Base (BLK)	
CB200	205 0736 063	35P FFC Conn.Base	DCM-440
CB200	205 0736 034	29P FFC Conn.Base (9603)	DCM-340
CB500	205 0581 001	2P VH Conn. Base	
CB501	205 0343 061	6P Conn. Base(KR-PH)	
CC103	204 0359 007	6P-3P,4P PH-PH Cord	
CN106	203 4805 033	3P PH-SAN Conn. Cord	
CN107	203 4805 020	3P PH-SAN Conn. Cord	
CN108	203 4810 002	3P PH-SAN Conn. Cord	
CN501	204 0371 001	6P KR-DA Conn. Cord	
TP101,102	205 0190 065	6P NH Conn. Base	

⚠	233 5941 010	Power Transformer (DCM-440)	U.S.A. Canada
⚠	233 6063 007	Power Transformer (DCM-440)	Europe
⚠	233 6061 009	Power Transformer (DCM-440)	Multi. Voltage
⚠	233 5907 012	Power Transformer (DCM-340)	U.S.A. Canada
⚠	233 6062 008	Power Transformer (DCM-340)	Europe
⚠	233 5909 007	Power Transformer (DCM-340)	Multi. Voltage
⚠	212 4698 008	Voltage Selector(D)	Multi. Voltage Models Only

Ref. No.	Part No.	Part Name	Remarks
SEMICONDUCTOR GROUP			
TR600,601	274 0160 907	Transistor	2SD2144STPU
D102	278 0006 005	Photo Interrupter	

CAPACITORS GROUP

C601-605	253 1180 921	Ceramic 0.001µF/50V	CK45F1H102ZT
C606,607	253 1181 904	Ceramic 0.01µF/50V	CK45F1H103ZT
C608	253 9036 909	Ceramic 0.1µF/25V	CK45=1E104ZT

OTHER PARTS

SW600	212 1039 000	1P Push Switch	
SW601-626	212 5604 907	Light Touch Switch	
FL600	393 4132 009	FL Tube (FIP8RM6)	DCM-440
FL600	393 4107 005	FL Tube (FIP9CDM7)	DCM-340
RM601	499 0150 008	REMOTE SENSOR (SBX1610-52)	DCM-440
RM601	499 0264 004	REMOTE SENSOR (GP1U571)	DCM-340
JK601	204 8364 007	HEAD PHONE JACK	
CN200	205 0736 063	35P FFC Conn.Base	DCM-440
CN200	205 0736 034	29P FFC Conn.Base (9603)	DCM-340
CB111	205 0343 032	3P Conn.Base (KR-PH)	
CB115	205 0355 046	4P KR Conn.Base (L)	
CB602	205 0343 074	7P Conn.Base (KR-PH)	
CB603	205 0355 075	7P KR Conn.Base (L)	
	009 0090 004	35P FFC Cable	DCM-440
	009 0089 002	29P FFC Cable	DCM-340
	217 0172 002	Roulette Motor	

EXPLODED VIEW OF MECHANISM UNIT

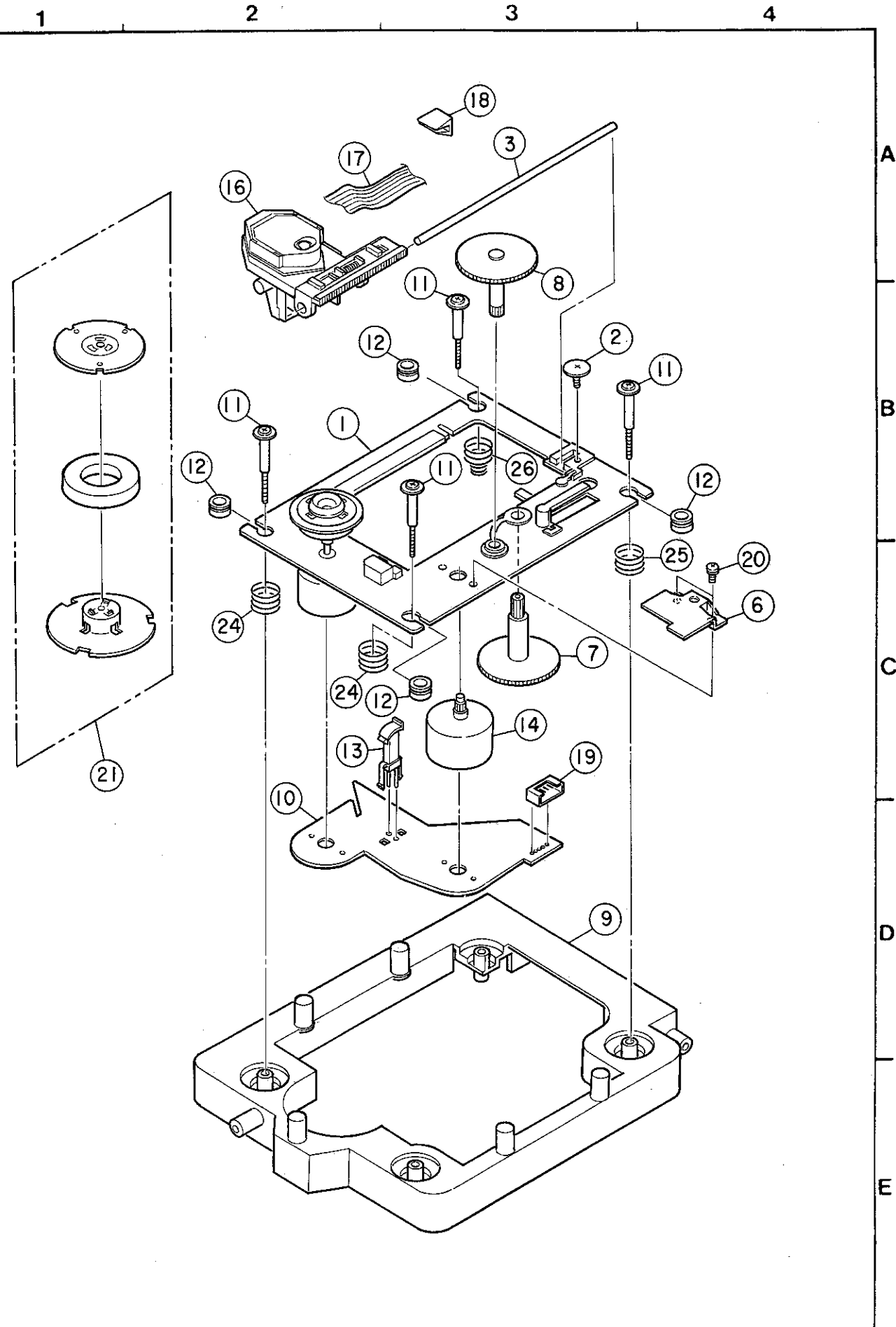

MECHANISM UNIT (FG-40)

Ref. No.	Part No.	Part Name	Remarks
1	9KA 85A0 03	SPINDLE MOTOR ASS'Y	
2	9KA 90H0 06	FEED SHAFT FIX SCREW	
3	9KA 90H0 05	FEED SHAFT	
7	9KA 85G0 17	GEAR (A)	
8	9KA 85G0 18	GEAR (B)	
9	9KA 85G0 16	FRAME	
10	9KA 85P0 04	P.W.B.	
11	9KA 85H0 01	SCREW F	
12	9KA 85G0 13	DAMPER F	
13	9KS 01W1 47	SWITCH	LSA-1121EAU
14	9KA 85A0 04	SLIDE MOTOR ASS'Y	
16	499 0191 009	LASER P.U	KSS-240A
17	009 0051 014	FFC	FFC-240
18	443 1093 006	FFC BUSH	
19	9KA 85G2 53	5P CONN.BASE	S5B-PH
20	9KM 20S0 03	M2 x 3 TAMS SCREW	
21	9KA 85A0 02	CLAMPER	
24	9KA 85S0 01	SPRING (A)	
25	9KA 85S0 02	SPRING (B)	
26	9KA 85S0 03	SPRING (C)	

EXPLODED VIEW

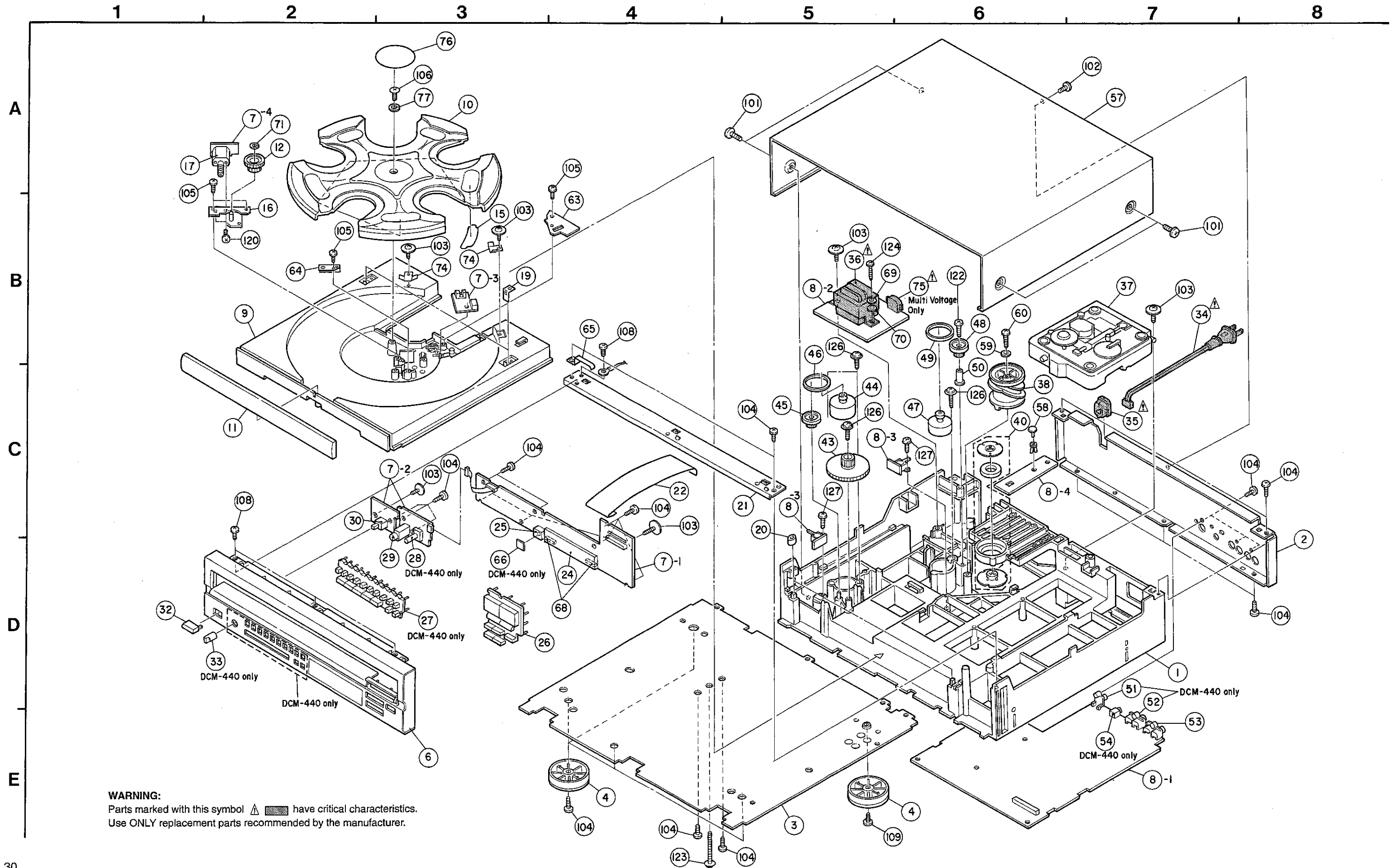

PARTS LIST OF EXPLODED VIEW (DCM-440/340)

Ref. No.	Part No.	Part Name	Remarks
1	103 1608 001	MECHA. CHASSIS	
2	105 9223 028	REAR PANEL(E3)	(DCM-440)U.S.A. Canada
2	105 1094 006	REAR PANEL(E2)	(DCM-440)Europe
2	105 1094 022	REAR PANEL(EP2)	(DCM-440)Multi.Voltage
2	105 9223 002	REAR PANEL(E3)	(DCM-340)U.S.A. Canada
2	105 1094 019	REAR PANEL(E2)	(DCM-340)Europe
2	105 0988 333	REAR PANEL(EP2)	(DCM-340)Multi.Voltage
3	105 0989 507	BOTTOM COVER	
4	104 0208 201	FOOT ASS'Y	
6	146 1445 106	FRONT PANEL ASS'Y	(DCM-440) U.S.A.,Canada
6	146 1445 122	FRONT PANEL ASS'Y	Multi.Voltage, Europe
6	146 1445 119	FRONT PANEL ASS'Y	(DCM-340) U.S.A.,Canada
6	146 1445 135	FRONT PANEL ASS'Y	Multi.Voltage, Europe
7	3U- 2576	DISPLAY UNIT	(DCM-440)
7	3U- 2575 A	DISPLAY UNIT	(DCM-340)
7-1		DISPLAY UNIT	
7-2		HEAD PHONE UNIT	
7-3		ROULETTE SENSOR UNIT	
7-4		ROULETTE MOTOR UNIT	
8	3U- 2574	P.W.B. UNIT	(DCM-440) U.S.A., Canada
8	3U- 2574 B	P.W.B. UNIT	(DCM-440) Europe
8	3U- 2574 D	P.W.B. UNIT	(DCM-440) Multi.Voltage
8	3U- 2574 A	P.W.B. UNIT	(DCM-340) U.S.A., Canada
8	3U- 2574 C	P.W.B. UNIT	(DCM-340) Europe
8	3U- 2574 E	P.W.B. UNIT	(DCM-340) Multi.Voltage
8-1		MAIN UNIT	
8-2		POWER TRANS. UNIT	
8-3		LOADING SW. UNIT	
8-4		DISC SENSOR UNIT	
9	431 0313 603	CLAMPING SW. UNIT	
10	421 0593 400	ROULETTE	
11	146 1297 008	LOADER PANEL	
12	424 0174 404	HELICAL GEAR	
15	461 0689 008	HIMERON SHEET	
16	412 3484 208	GEAR BRACKET ASS'Y	
17	GEN 1682	ROULETTE MOTOR SUB ASS'Y	
19	412 3350 109	LOADER BRACKET	
20	461 0659 009	LOADER STOPPER	
21	412 3348 205	FRONT BRACKET	
22	009 0090 004	35P FFC CABLE	(DCM-440)
22	009 0089 002	29P FFC CABLE	(DCM-340)
24	393 4132 009	FL TUBE (FIP 8RM6)	(DCM-440)
24	393 4107 005	FL TUBE (FIP 9CDM7)	(DCM-340)
25	499 0150 008	REMOTE SENSOR (SBX1610-52)	(DCM-440)
25	499 0264 004	REMOTE SENSOR(GP1U571)	(DCM-340)
26	113 1462 202	FUNCTION KNOB	
27	113 1461 009	SERIES KNOB	(DCM-440)
28	211 0661 010	VARIABLE RESISTOR (V0920P30FC202)	(DCM-440 Only)
29	204 8364 007	HEAD PHONE JACK	
30	212 1039 000	1P PUSH SWITCH	
32	113 1357 207	POWER SWITCH KNOB	
33	112 0645 108	HEAD PHONE KNOB	(DCM-440 Only)
34	206 2110 004	AC CORD WITH CONNECTOR	U.S.A. Canada
34	206 2089 106	AC CORD WITH CONNECTOR	Europe
34	206 2088 000	AC CORD WITH CONNECTOR	Multi.Voltage
35	445 0056 008	CORD BUSH	

Ref. No.	Part No.	Part Name	Remarks
35	233 5941 010	POWER TRANSFORMER	(DCM-440)U.S.A. Canada
35	233 5963 007	POWER TRANSFORMER	(DCM-440)Europe
35	233 6061 009	POWER TRANSFORMER	(DCM-440)Multi.Voltage
35	233 5907 012	POWER TRANSFORMER	(DCM-340)U.S.A. Canada
35	233 6062 008	POWER TRANSFORMER	(DCM-340)Europe
35	233 5909 007	POWER TRANSFORMER	(DCM-340)Multi.Voltage
37	FG-40	CD MECHA. UNIT	
38	424 0172 202	CLAMPING CAM	
40	9KA 85A0 02	CLAMPER	
43	424 0173 104	LOADING GEAR	
44	GEN 1680	LOADING MOTOR SUB ASS'Y	
45	424 0130 011	PULLEY GEAR	
46	423 0061 006	BELT	
47	GEN 1678	CLAMP MOTOR SUB ASS'Y	
48	424 0130 008	PULLEY GEAR	
49	423 0061 006	BELT	
50	443 1161 006	COLLAR	
51	204 8356 002	1P PIN JACK	(DCM-440 Only)
52	204 8373 001	2P PIN JACK	(DCM-440 Only)
53	204 8373 001	2P PIN JACK	
54	204 8416 007	MINI JACK	
56	424 0093 226	WORM GEAR ASS'Y	
57	102 0479 005	TOP COVER	
58	477 0096 007	PUSH RIVET	
59	475 1005 017	4W WASHER	
60	473 7501 014	3x14 CBTS(P)-Z SCREW	
63	412 3499 002	BLIND PLATE	
64	461 0690 107	MOTOR SPRING	
65	412 3400 004	EARTH PLATE	
66	143 0568 001	FILTER	
68	461 0580 000	SPACER	
69	475 1106 042	WASHER	
70	475 3100 004	4TWA NI	
71	475 1157 017	SLIT WASHER T0.5	
74	441 1402 112	ROULETTE STOPPER	
75	212 4698 008	VOLTAGE SELECTOR	Multi.Voltage Only
76	125 0070 009	BLIND SHEET-V	
77	475 1160 004	WASHER	
101	473 7509 016	4x10 CBTS(P)-B SCREW	
102	473 7015 018	3x8 CBTS(S)-B SCREW	
103	477 0262 006	SPECIAL SCREW	
104	473 7508 017	3x10 CBTS(P)-B SCREW	
106	473 7512 016	3x12 CFTS(P)-B SCREW	
108	473 7002 021	3x8 CBTS(S)-B SCREW	
109	473 7002 018	3x8 CBTS(S)-Z SCREW	
120	471 8301 039	2x3 CBS-Z SCREW	
122	473 7508 059	3x20 CBTS(P)-B SCREW	
123	473 0840 064	3x30 CPTS(B)ZN	
124	473 7501 030	3x20 CBTS(P)-Z	

WARNING :

- Parts marked with Δ and/shading have special characteristics important to safety. Be sure to use the specified parts for replacement.
- Parts indicated with the mark \odot are not always in stock and possibly to take a long period of time for supplying, or in some case supplying of parts may be refused.

PACKING & ACCESSORIES (DCM-440)

Ref. No.	Part No.	Part Name	Remarks	Q'ty
\odot	505 0102 089	Styrene Paper	For set	1
\odot	504 0092 060	Styrene Paper	For AC cord	1
\odot	503 1023 116	Cushion		2
\odot	501 1612 055	Carton Case		1
\odot	505 8006 019	Envelope		1
\odot	511 2471 001	Instruction Manual	U.S.A. Canada	1
\odot	511 2524 000	Instruction Manual	Europe	1
\odot	515 0623 002	DAI Warranty Home	U.S.A. Canada Only	1
	203 2223 002	2P Pin Cord		1
	499 0266 002	Remote Control Unit(RC-246)		1

PACKING & ACCESSORIES (DCM-340)

Ref. No.	Part No.	Part Name	Remarks	Q'ty
\odot	505 0102 089	Styrene Paper	For set	1
\odot	504 0092 060	Styrene Paper	For AC cord	1
\odot	503 1023 116	Cushion		2
\odot	501 1612 068	Carton Case		1
\odot	505 8006 019	Envelope		1
\odot	511 2471 001	Instruction Manual	U.S.A. Canada	1
\odot	511 2524 000	Instruction Manual	Europe	1
\odot	515 0623 002	DAI Warranty Home	U.S.A. Canada Only	1
	203 2223 002	2P Pin Cord		1
	499 0265 003	Remote Control Unit(RC-245)		1

1 2 3 4 5 6 7 8

3U-2574 MAIN UNIT (DCM-440/340)

A
B
C
D
E

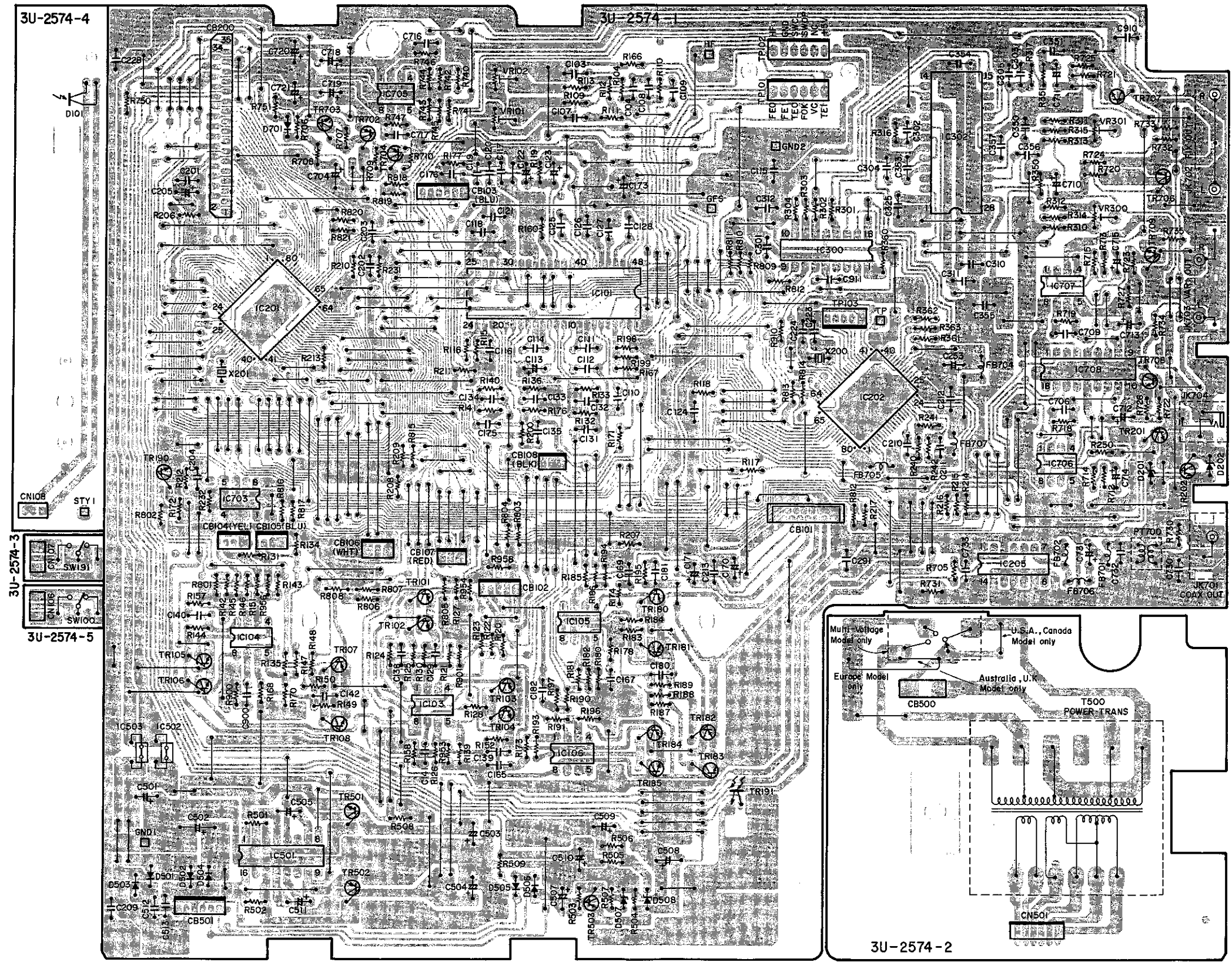

1 2 3 4 5 6 7 8

3U-2576 DISPLAY UNIT (DCM-440)

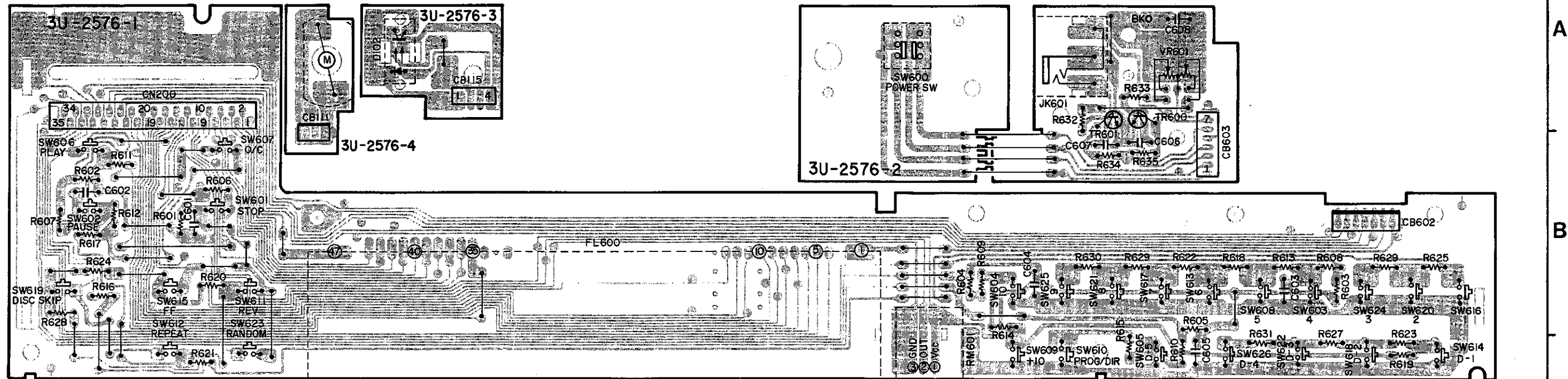

3U-2575 DISPLAY UNIT (DCM-340)

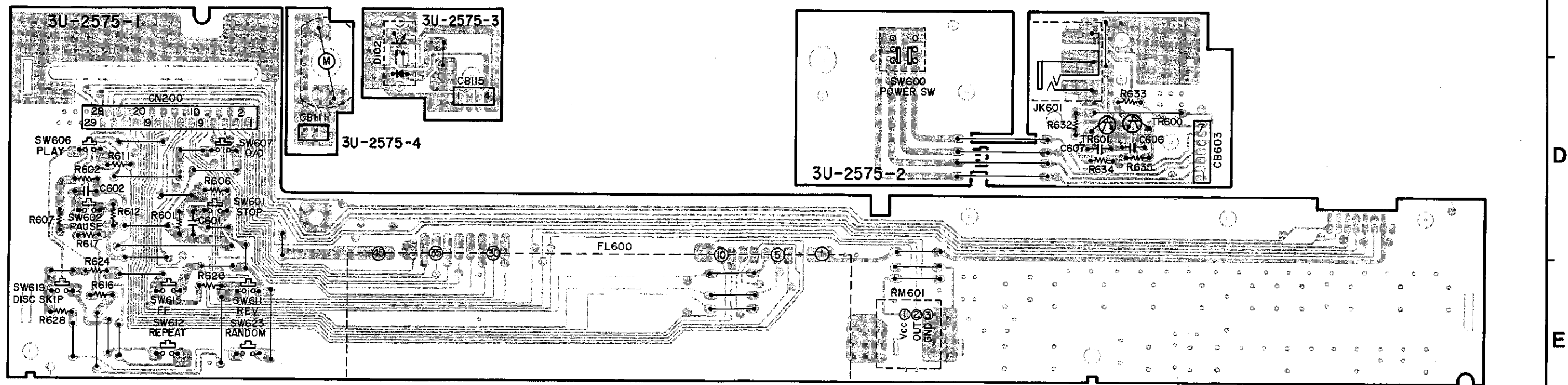

A
B
C
D
E

WIRING DIAGRAM

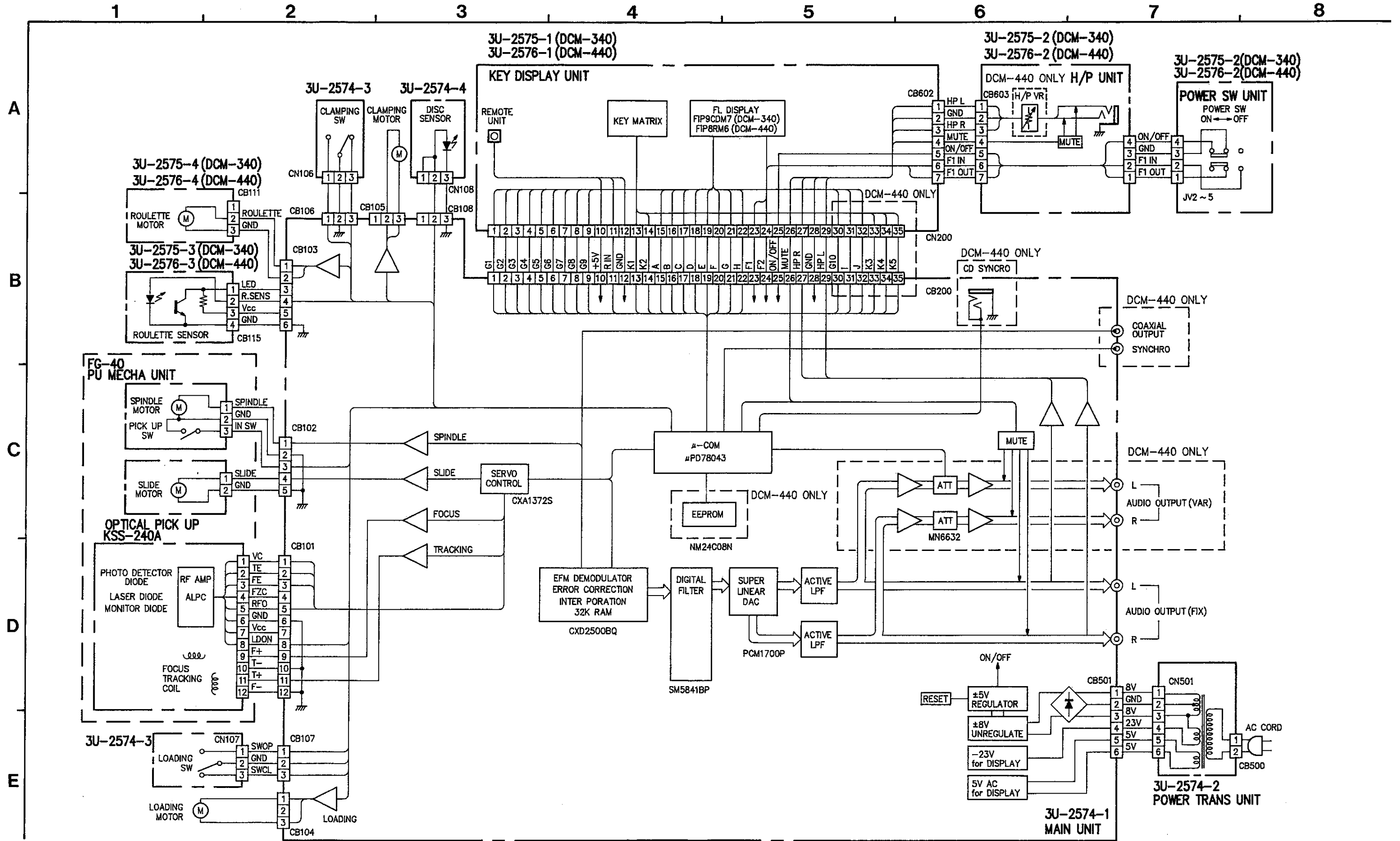

SCHEMATIC DIAGRAM [DCM-440]

1 2 3 4 5 6 7 8

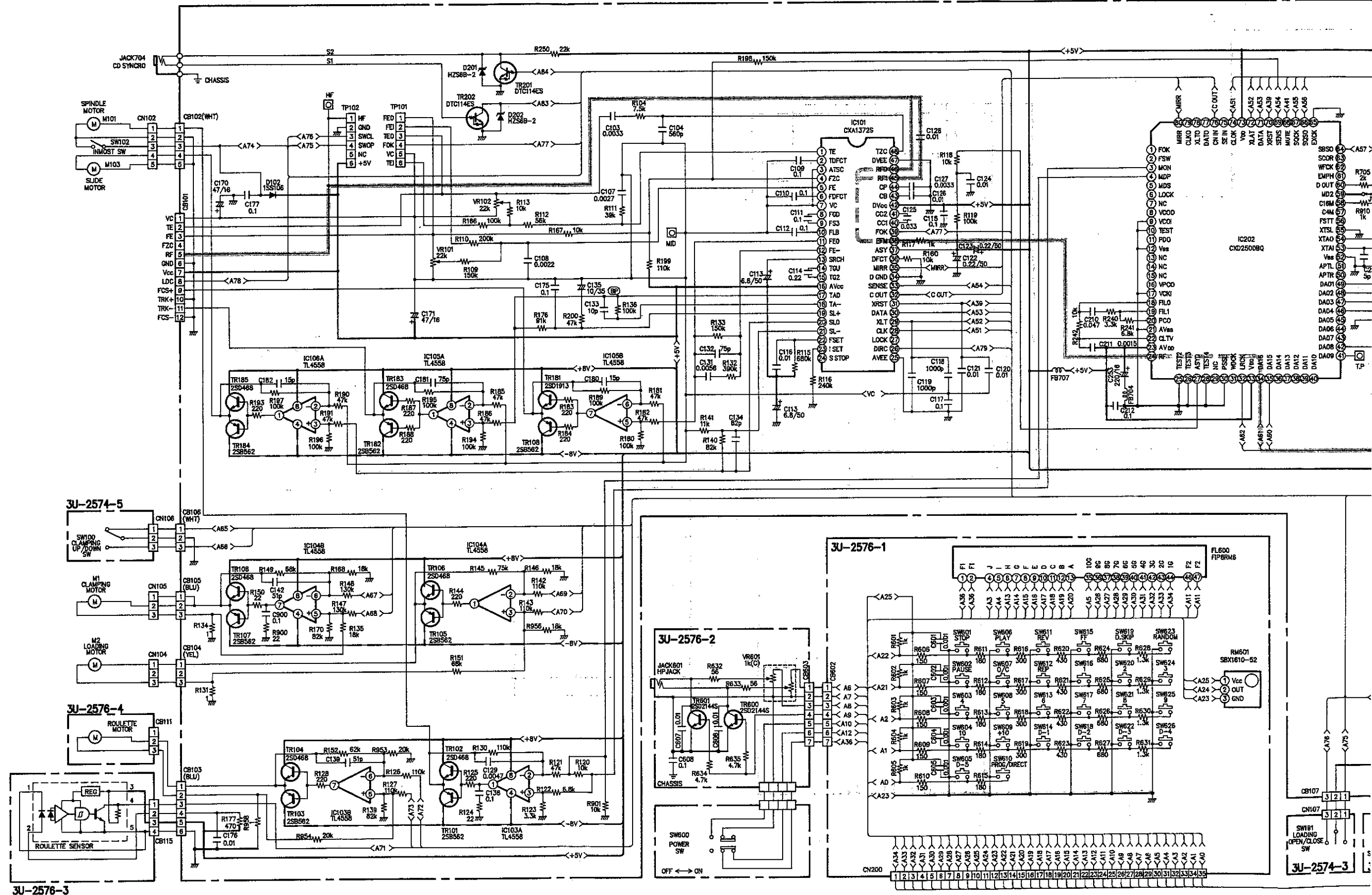

8 9 10 11 12 13 14 15

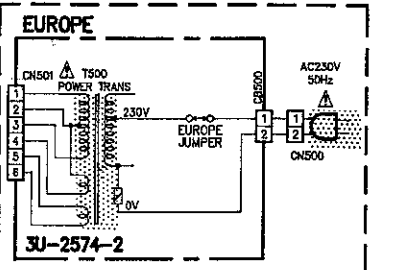
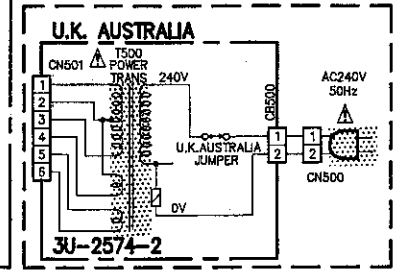
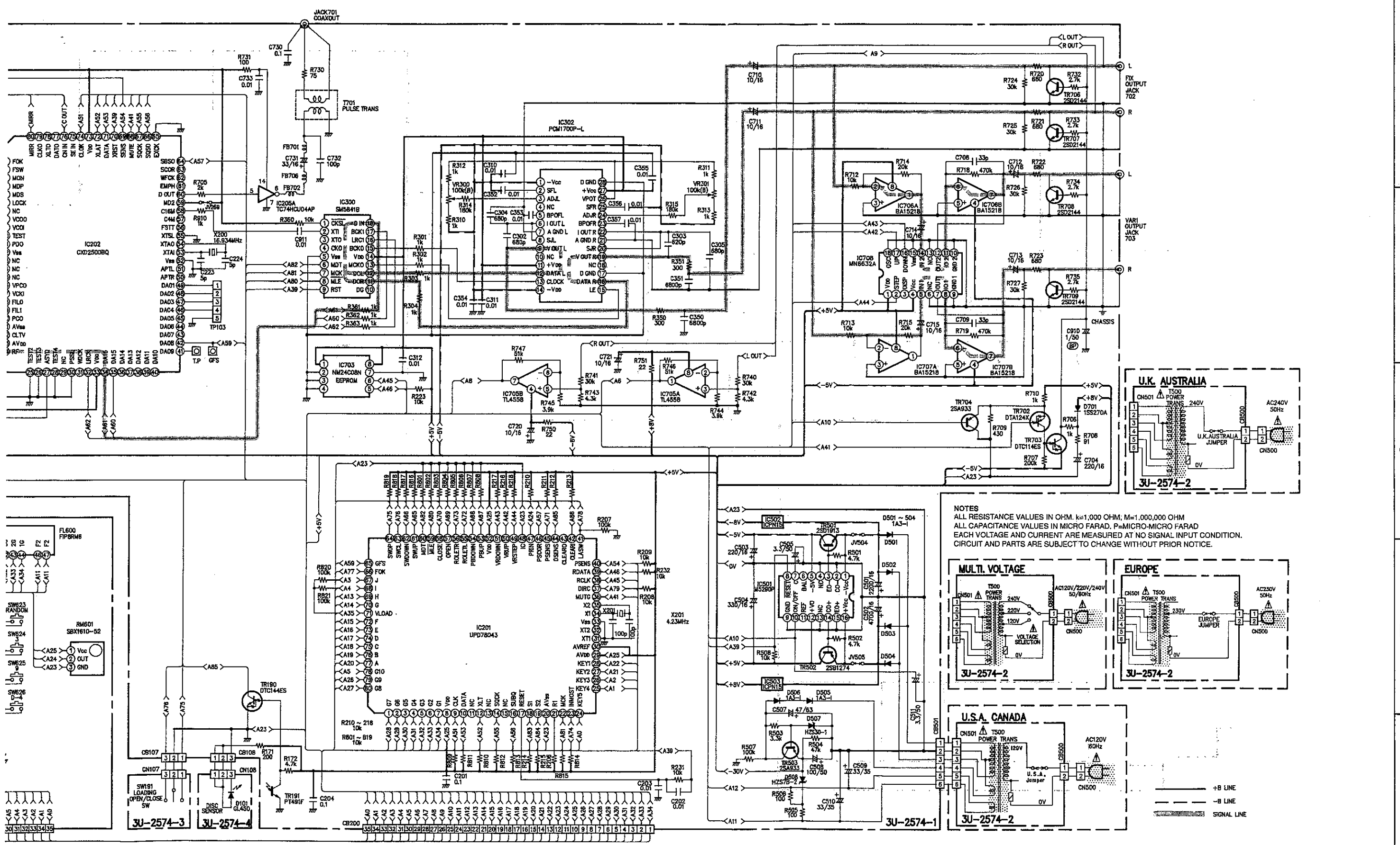

NOTES
 ALL RESISTANCE VALUES IN OHM, K=1,000 OHM, M=1,000,000 OHM
 ALL CAPACITANCE VALUES IN MICRO FARAD, P=MICRO-MICRO FARAD
 EACH VOLTAGE AND CURRENT ARE MEASURED AT NO SIGNAL INPUT CONDITION.
 CIRCUIT AND PARTS ARE SUBJECT TO CHANGE WITHOUT PRIOR NOTICE.

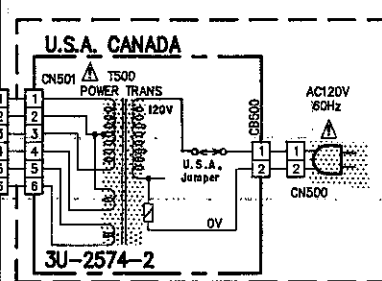
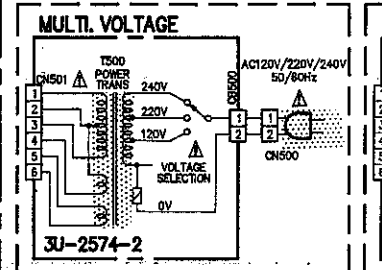

— +B LINE
 - - - -B LINE
 ——— SIGNAL LINE

A
B
C
D
E

SCHEMATIC DIAGRAM [DCM-340]

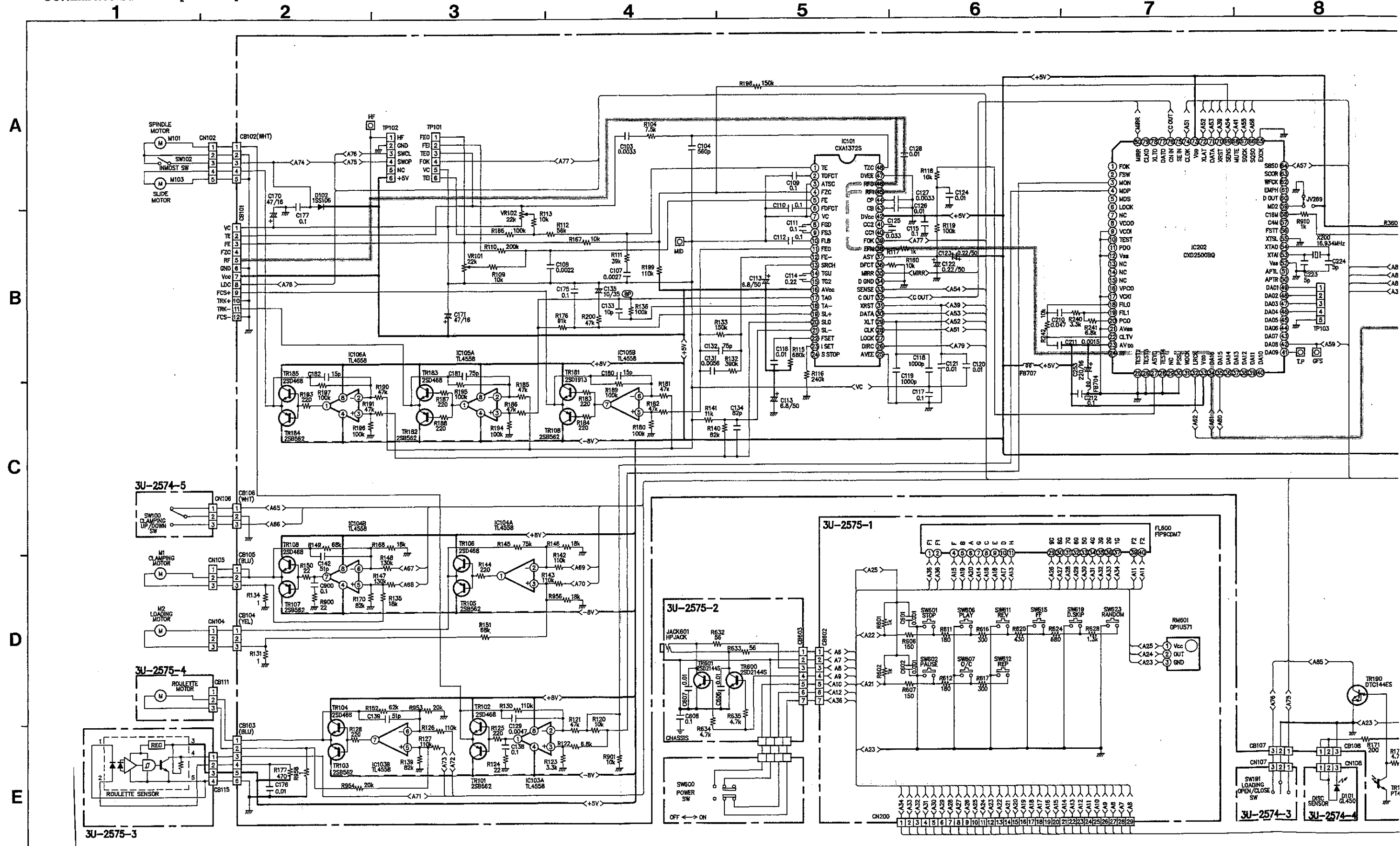

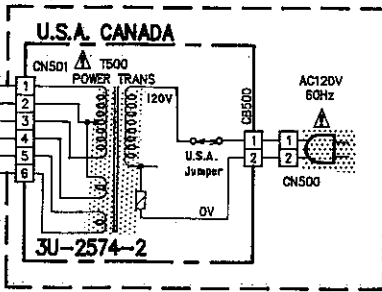
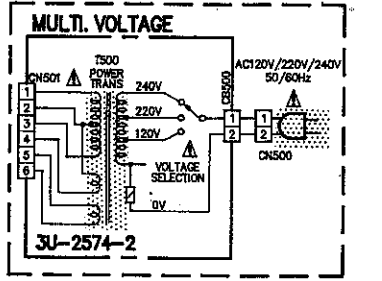
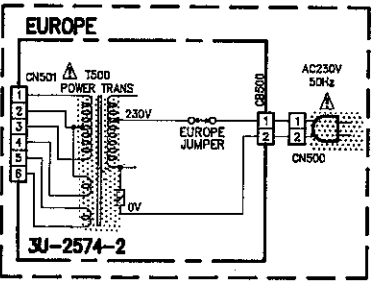
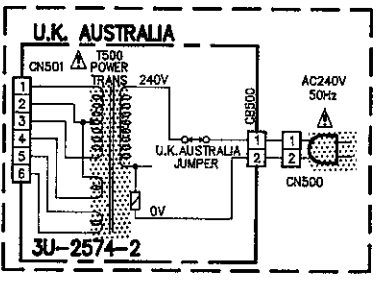
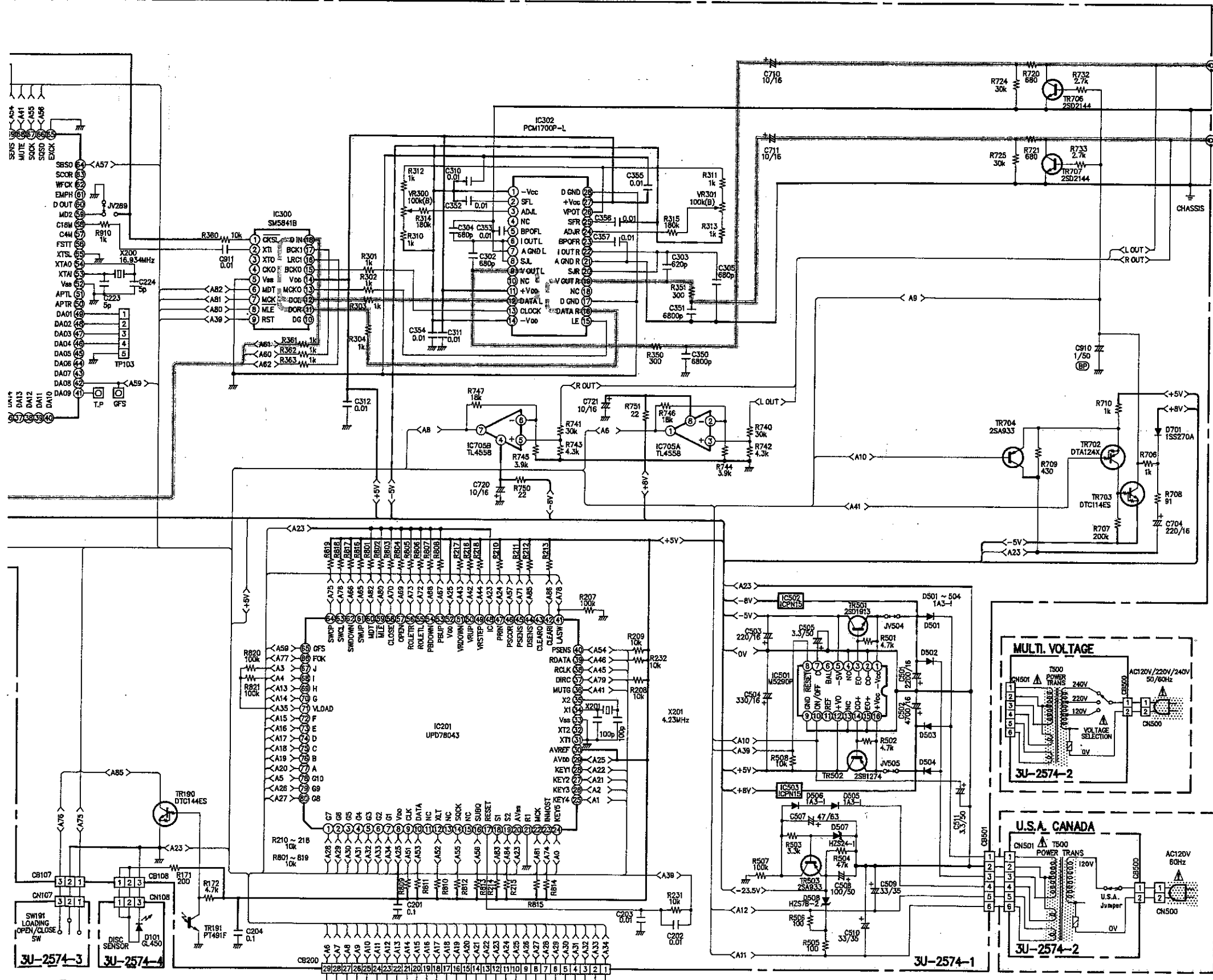

NOTES
 ALL RESISTANCE VALUES IN OHM, k=1,000 OHM, M=1,000,000 OHM
 ALL CAPACITANCE VALUES IN MICRO FARAD, P=MICRO-MICRO FARAD
 EACH VOLTAGE AND CURRENT ARE MEASURED AT NO SIGNAL INPUT CONDITION.
 CIRCUIT AND PARTS ARE SUBJECT TO CHANGE WITHOUT PRIOR NOTICE.

