

# DENON

Hi-Fi Component

## SERVICE MANUAL

### MODEL DCM-560

### MODEL DCM-460

#### STEREO CD PLAYER



DCM-560

DCM-460

#### — TABLE OF CONTENTS —

OPERATING INSTRUCTIONS .....	2 - 11
SPECIFICATIONS .....	11
NOTE FOR HANDLING OF LASER PICK-UP .....	12, 13
DISASSEMBLY .....	14
ADJUSTMENT .....	15 - 18
HEAT RUN MODE FUNCTION .....	18
SEMICONDUCTORS .....	20 - 21
NOTE ON PARTS LIST .....	21
PARTS LIST OF P.W.BOARD .....	26 - 27
PARTS LIST OF MECHANISM UNIT .....	31
EXPLODED VIEW OF MECHANISM UNIT .....	31
EXPLODED VIEW (DCM-560) .....	31
PARTS LIST OF EXPLODED VIEW (DCM-560) .....	31
PARTS LIST OF PACKING & ACCESSORIES (DCM-560) .....	31
EXPLODED VIEW (DCM-460) .....	31
PARTS LIST OF EXPLODED VIEW (DCM-460) .....	31
PARTS LIST OF PACKING & ACCESSORIES (DCM-460) .....	31
P.W.BOARD .....	36 - 38
WIRING DIAGRAM .....	39, 41
SCHEMATIC DIAGRAM .....	41, 42

## NIPPON COLUMBIA CO., LTD.

# SAFETY INSTRUCTIONS

1. Read Instructions - All the safety and operating instructions should be read before the appliance is operated.
2. Retain Instructions - The safety and operating instructions should be retained for future reference.
3. Read Warnings - All warnings on the appliance and in the operating instructions should be adhered to.
4. Follow Instructions - All operating and use instructions should be followed.
5. Water and Moisture - The appliance should not be used near water - for example, near a bathtub, washbowl, kitchen sink, laundry tub, in a wet basement, or near a swimming pool, and the like.
6. Carts and Stands - The appliance should be used only with a cart or stand that is recommended by the manufacturer.
- 6A. An appliance and cart combination should be moved with care. Quick stops, excessive force, and uneven surfaces may cause the appliance and cart combination to overturn.
7. Wall or Ceiling Mounting - The appliance should be mounted to a wall or ceiling only as recommended by the manufacturer.
8. Ventilation - The appliance should be situated so that its location or position does not interfere with its proper ventilation. For example, the appliance should not be situated on a bed, sofa, rug, or similar surface that may block the ventilation openings; or placed in a built-in installation, such as a bookcase or cabinet that may impede the flow of air through the ventilation openings.
9. Heat - The appliance should be situated away from heat sources such as radiators, heat registers, stoves, or other appliances (including amplifiers) that produce heat.
10. Power Sources - The appliance should be connected to a power supply only of the type described in the operating instructions or as marked on the appliance.
11. Grounding or Polarization - Precautions should be taken so that the grounding or polarization means of an appliance is not defeated.
12. Power-Cord Protection - Power-supply cords should be routed so that they are not likely to be walked on or pinched by items placed upon or against them, paying particular attention to cords at plugs, convenience receptacles, and the point where they exit from the appliance.
13. Cleaning - The appliance should be cleaned only as recommended by the manufacturer.
14. Power Lines - An outdoor antenna should be located away from power lines.
15. Outdoor Antenna Grounding - If an outside antenna is connected to the receiver, be sure the antenna system is grounded so as to provide some protection against lightning surges, and built-up static charges. Article 810 of the National Electrical Code, ANSI/NFPA 70, provides information with regard to proper grounding of the mast and supporting structure, grounding of the lead-in wire to an antenna-discharge unit, size of grounding conductors, location of antenna-discharge unit, connection to the grounding electrode, and requirements for the grounding electrode. See Figure A.
16. Nonuse Periods - The power cord of the appliance should be unplugged from the outlet when left unused for a long period of time.
17. Object and Liquid Entry - Care should be taken so that objects do not fall and liquids are not spilled into the enclosure through openings.
18. Damage Requiring Service - The appliance should be serviced by qualified service personnel when:
  - A. The power-supply cord or the plug has been damaged; or
  - B. Objects have fallen, or liquid has been spilled into the appliance; or
  - C. The appliance has been exposed to rain; or
  - D. The appliance does not appear to operate normally or exhibits a marked change in performance; or
  - E. The appliance has been dropped, or the enclosure damaged.
19. Servicing - The user should not attempt to service the appliance beyond that described in the operating instructions. All other servicing should be referred to qualified service personnel.

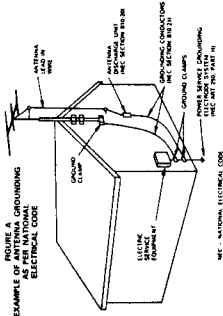

**NOTE:**  
This CD player uses the semiconductor laser. To allow you to enjoy music at a stable operation, it is recommended to use this in a room of 10°C (50°F) - 35°C (95°F).

**LABELS (for U.S.A. model only)**

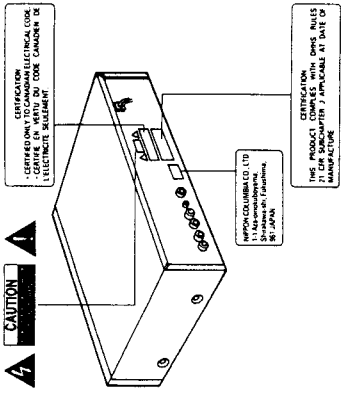

**CAUTION:**  
USE OF CONTROLS OR ADJUSTMENTS OR PERFORMANCE OF PROCEDURES OTHER THAN THOSE DESCRIBED HEREIN MAY RESULT IN HAZARDOUS RADIATION EXPOSURE.  
THE COMPACT DISC PLAYER SHOULD NOT BE ADJUSTED OR REPAIRED BY ANYONE EXCEPT PROPERLY QUALIFIED SERVICE PERSONNEL.

**NOTE:**  
This unit may cause interference to radio and television reception if you do not operate it in strict accordance with this OPERATING INSTRUCTIONS.  
This unit complies with Class B computing device rules in accordance with the specifications in Subpart 15 of Part 15 of the FCC Rules, which are designed to provide reasonable protection against such interference in a residential installation. If the unit does cause interference to any radio or television reception, try to reduce it by one or more of the following means:  
a) Turn the other unit to improve reception  
b) Move this unit  
c) Plug this unit, respectively into a different AC outlet  
d) Plug this unit, respectively into a different AC outlet

**FOR U.S.A. & CANADA MODEL ONLY**  
**CAUTION**  
TO PREVENT ELECTRIC SHOCK DO NOT USE THIS POLARIZED PLUG WITH AN EXTENSION CORD, RECEPTACLE OR OTHER OUTLET UNLESS THE BLADES CAN BE FULLY INSERTED TO PREVENT BLADE EXPOSURE.

**POUR LES MODELES AMERICAINS ET CANADIENS UNIQUEMENT**  
**ATTENTION**  
POUR PREVENIR LES CHOCS ELECTRIQUES NE PAS UTILISER CETTE FICHE POLARISEE AVEC UN PROLONGATEUR UNE PRISE DE COURANT OU UNE AUTRE SORTIE DE COURANT, SAUF SI LES LAMES PEUVENT ETRE INSEREES A FOND SANS EN LAISSER AUCUNE PARTIE A DECOUVERT.

**IMPORTANT TO SAFETY**

**WARNING:**  
TO PREVENT FIRE OR SHOCK HAZARD, DO NOT EXPOSE THIS APPLIANCE TO RAIN OR MOISTURE.

**CAUTION:**

1. Handle the power supply cord carefully. Do not damage or deform the power supply cord. If it is damaged or deformed, it may cause electric shock or malfunction when used. When removing from wall outlet, be sure to remove by holding the plug attachment and not by pulling the cord.
2. Do not open the top cover in order to prevent electric shock, do not open the top cover. If problems occur, contact your DENON dealer.
3. Do not place anything inside. Do not place metal objects or spill liquid inside the CD player. Electric shock or malfunction may result.

Please, record and retain the Model name and serial number of your set shown on the rating label  
Model No. DCM-560/460 Serial No.

**CAUTION**  
RISK OF ELECTRIC SHOCK  
DO NOT OPEN

**CAUTION: TO REDUCE THE RISK OF ELECTRIC SHOCK, DO NOT REMOVE COVER (OR BACK). NO USER SERVICEABLE PARTS INSIDE. REFER SERVICING TO QUALIFIED SERVICE PERSONNEL.**

The lightning flash with arrowhead symbol within an equilateral triangle is intended to alert the user to the presence of uninsulated "dangerous voltage" within the product's enclosure that may be of sufficient magnitude to constitute a risk of electric shock to persons.  
The exclamation point within an equilateral triangle is intended to alert the user to the presence of important operating and maintenance (servicing) instructions in the literature accompanying the appliance.

**IMPORTANT (BRITISH MODEL ONLY)**  
The wires in this mains lead are coloured in accordance with the following code:  
Blue: Neutral Brown: Live  
The colours of the wires in the mains lead of this apparatus may not correspond with the coloured markings identifying the terminals in your plug proceed as follows.  
The wire which is coloured blue must be connected to the terminal which is marked with the letter N or coloured black.  
The wire which is coloured brown must be connected to the terminal which is marked with the letter L or coloured red.

NOTE ON USE/OBSERVATIONS RELATIVES A L'UTILISATION/NOTAS SOBRE EL USO

<ul style="list-style-type: none"> <li>Avoid high temperatures.</li> <li>Allow for sufficient heat dissipation when installed on a surface.</li> <li>Enter the temperature directly on the display.</li> <li>Evite altas temperaturas.</li> <li>Permita suficiente disipación de calor cuando está instalado en la consola.</li> </ul>	<ul style="list-style-type: none"> <li>Keep the set free from moisture, water, and dust.</li> <li>Use a soft, lint-free cloth to clean the set.</li> <li>Maneja el equipo libre de humedad, agua y polvo.</li> </ul>	<ul style="list-style-type: none"> <li>Do not let foreign objects in the set.</li> <li>Do not use objects that may damage the set.</li> <li>No deje objetos extraños dentro del equipo.</li> </ul>
<ul style="list-style-type: none"> <li>Handle the power cord carefully.</li> <li>Do not touch the power cord when it is plugged into the wall.</li> <li>Evite tocar el cable cuando está conectado a la pared.</li> <li>Maneja el cable con cuidado.</li> <li>No toques el cable cuando está conectado a la pared.</li> </ul>	<ul style="list-style-type: none"> <li>Using the power cord when not using the set too long.</li> <li>Do not touch the power cord when it is plugged into the wall.</li> <li>Discontinue all cord use when the set is not in use.</li> <li>Evite usar el cable cuando no está en uso.</li> <li>Deje de usar el cable cuando el equipo no está en uso.</li> </ul>	<ul style="list-style-type: none"> <li>Do not let moisture, batteries, and other items in the set.</li> <li>Do not touch the power cord when it is plugged into the wall.</li> <li>No permita que humedad, baterías, u otros artículos entren en contacto con el equipo.</li> <li>No toque el cable cuando está conectado a la pared.</li> </ul>
<ul style="list-style-type: none"> <li>Never disassemble or modify the set in any way.</li> <li>Do not touch the power cord when it is plugged into the wall.</li> <li>Never disassemble or modify the set in any way.</li> <li>No desmonte ni modifique el equipo en ninguna manera.</li> <li>No toque el cable cuando está conectado a la pared.</li> </ul>	<ul style="list-style-type: none"> <li>Do not touch the power cord when it is plugged into the wall.</li> <li>Do not touch the power cord when it is plugged into the wall.</li> <li>No toque el cable cuando está conectado a la pared.</li> <li>No toque el cable cuando está conectado a la pared.</li> </ul>	<ul style="list-style-type: none"> <li>Do not touch the power cord when it is plugged into the wall.</li> <li>Do not touch the power cord when it is plugged into the wall.</li> <li>No toque el cable cuando está conectado a la pared.</li> <li>No toque el cable cuando está conectado a la pared.</li> </ul>

Line Voltage Selection (for multiple voltage model only)

- The desired voltage may be set with the VOLTAGE SELECTOR knob on the rear panel, using a screwdriver.
- Do not twist the VOLTAGE SELECTOR knob with excessive force as this may cause damage.
- If the VOLTAGE SELECTOR knob does not turn smoothly, please contact a qualified serviceman.

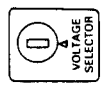

NUR FÜR EUROPÄISCHE MODELLE

Konformitätsklärung  
 Die DENON Electronic GmbH  
 Hakenstraße 32  
 40880 Ratingen

Erklärt als Hersteller/Importeur, daß das in dieser Bedienungsanleitung beschriebene Gerät den Technischen Vorschriften für Ton- und Fernseh-Rundfunkempfänger nach der Amtsblattverfügung 868/1989 (Amtsblatt des Bundesministers für Post und Telekommunikation vom 31. 9. 1989) entspricht.

Thank you for purchasing the DENON compact disc player. Read the Operating Instructions thoroughly, and operate this player properly.

TABLE OF CONTENTS

FEATURES ..... 5  
 CAUTIONS DURING USE ..... 5  
 NAMES OF PARTS AND THEIR FUNCTIONS ..... 6-9  
 CONNECTIONS ..... 6-9  
 OPENING AND CLOSING THE DRAWER AND LOADING A DISC ..... 9  
 NORMAL PLAY ..... 9  
 OTHER PLAY METHODS ..... 10-15  
 INSTALLATION PRECAUTIONS ..... 10-15  
 PLAY USING THE REMOTE CONTROL UNIT ..... 16-18  
 COMPACT DISCS ..... 16-18  
 TROUBLE CHECK: THE PLAYER TO FIND WHAT'S WRONG ..... 19  
 SPECIFICATIONS ..... 19

In addition to the CD Player unit, please check to make sure the following items are included in the packing box.

- Operating Instructions ..... 1
- Connection Cord: RC-238 (DCM-560) ..... 1
- Remote Control Unit: RC-248 (DCM-460) ..... 1
- RP3 (AAA size) Dry batteries (RC-248) ..... 2

IMPORTANT (CANADIAN MODEL ONLY)

This digital apparatus does not exceed the Class B limits for radio emissions from digital apparatus set out in the Radio Interference Regulations of the Canadian Department of Communications.

FEATURES

- The DCM-560 and DCM-460 are CD players equipped with DENON's unique A.S.L.C. (Advanced Super Linear Converter) for eliminating sound quality deterioration in the PCM playback system in order to faithfully recreate the sound field of live halls or studios where compact discs are recorded. These models use carefully selected parts to provide high performance and sound field recreation with rich musical expression.
- Ultimate signal reproduction using a newly developed ALPHA processed interpolation by the newly developed ALPHA processor recreates the data below the LSR (least significant bit) lost upon recording to provide smooth waveform reproduction.
  - The original signals, including such unusual waveforms as impulse response, can also be reproduced with no ringing.
  - The effects of ALPHA processing are particularly noticeable at low levels, such as when music gently fades out or gradually emerges from total silence.
  - Advanced remote control system for preventing zero cross distortion, the main cause of deterioration of the sound quality in the PCM playback system, provides for sound field recreation with rich musical expression.
  - High performance digital filter
  - The DCM-560/460 uses high precision 20-bit 8-times oversampling digital filters.
  - Programming of up to 20 tracks
  - All of the tracks on a CD can be programmed to play in any order, including in units of discs (all tracks on a disc) is also possible.
  - Newly developed carousel-type changer mechanism included
  - This mechanism can house five discs, and while one disc is playing the remaining four discs can be changed. In addition, the carousel can be rotated either clockwise or counterclockwise, so searching between discs is fast.
  - Wireless Remote Control Accessory
  - In addition to general operations such as Play, Stop and Pause, the remote control has other functions. Using the remote control unit adds greatly to the operating ease of the DCM-560/460, enhancing its outstanding features.
  - Favorite Track File (F.T. FILE)
  - This function stores your favorite tracks for each of the discs. Using a deletion method, this function deletes up to 6 tracks on 1 disc, providing storage for up to 100 discs. Storage is retained even after the power is switched off.
  - Cybernetized Recording Function
  - The Sync Lock function on a DENON cassette deck which is equipped with a SYNCHRO lock, then make a synchronized recording.

CAUTIONS DURING USE

- This compact disc player is capable of playing discs which have the mark at right.
- During track selection, during search and when the player sustains a strong impact, the disc's rotational speed changes greatly, causing a small noise to be emitted. This is not a malfunction of the player.
- If the CD player is operated while an FM or AM broadcast is being received, there may be noise in the FM or AM reception.
- The DCM-560/460 has a broad dynamic range. Please exercise caution when turning up the volume on the amplifier in cases when the playback volume is low. If the volume is turned up too high, it could damage the speakers.
- Do not use any discs but exclusive audio discs with this CD player.
- Placing this player or its connection cords near a TV or other audio device could cause a humming sound to be emitted. If this occurs, relocate the player or reroute the connection cords.
- Be sure to remove the disc from the player before moving it.
- The disc could be damaged if left in the player while it is being moved.
- Do not place any object in the tray in the position where the disc is loaded, or open and close the tray with anything inside. Foreign objects in the tray could damage the play mechanism.
- Do not move the player from a cold place to a warm place suddenly. If the player is cold when brought into a warm room, condensation could form, preventing proper operation of the player. If condensation does form on the player when it is brought into a warm room, wait at least 30 minutes before use.

NAMES OF PARTS AND THEIR FUNCTIONS

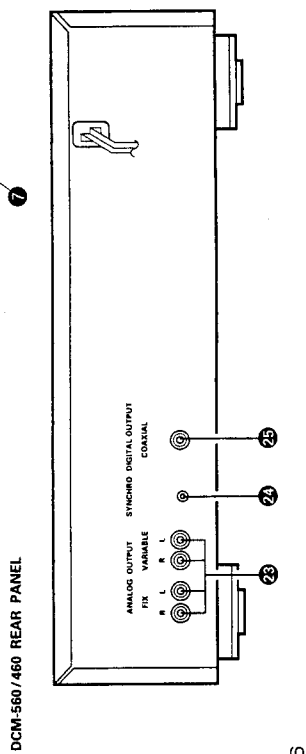
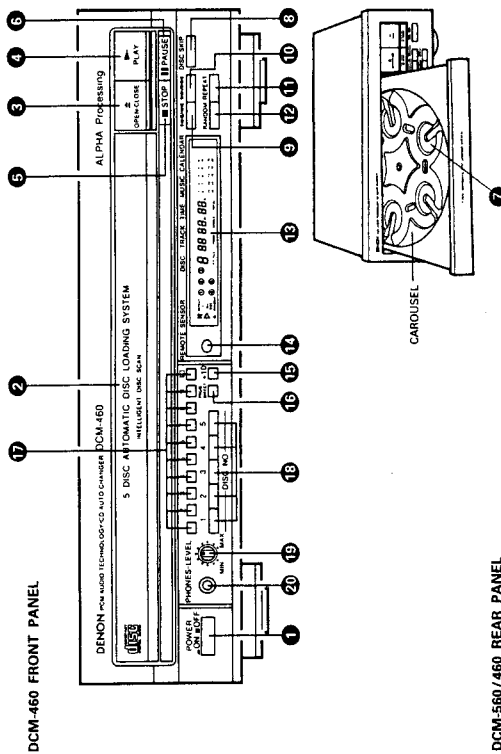
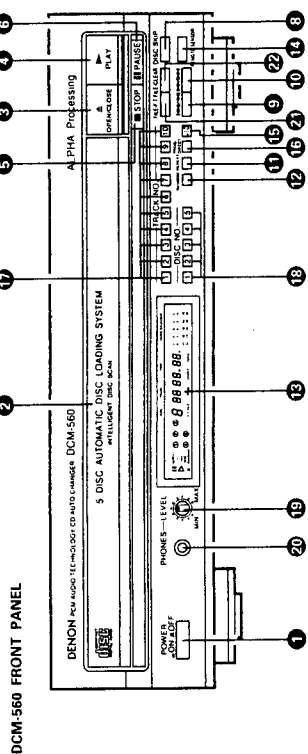

10 Automatic/Manual Search Forward Button

- Press this button to move the pickup forward to the beginning of the next track. Press again to move ahead to other tracks.
- By pressing the button a number of times, the pickup will advance the corresponding number of tracks.
- Keep on pressing this button for more than 0.5 seconds during playback for fast forward search. As long as the button is kept pressed, music signals are played back faster than normal.
- Keep on pressing this button for more than 0.5 seconds when the pause mode is engaged, you can quickly forward the pickup to a desired position, three times faster compared to manual forward search during playback. During this time, no sound is heard.

11 Repeat Button (REPEAT)

- Press this button for repeated playback. The [REPEAT] indicator appears on the display. The following three types of repeat modes are available:
  - When pressed once, the [REPEAT] and [1] indicators light and the track currently playing is repeated.
  - When pressed again, the [REPEAT] and [1] DISC indicators light and all the tracks on the disc currently playing are repeated.
  - When pressed again, the [REPEAT] and [ALL DISC] indicators light and all the discs currently set on the tray are repeated.
- When pressed again, the [REPEAT] and [ALL DISC] indicators turn off and the repeat mode is cancelled. The repeat function can also be used during programmed and random playback, but in this case only the all-repeat ([ALL DISC] indicator) modes are available. (Refer to Page 12, item 8.)

12 Random Button (RANDOM)

- Press this button to begin random play.
- Pressing this button during stop, and press play button to full automatic random play.
- Pressing this button during playing of a program starts random play of the tracks in the program. (See page 12, item 8.)

13 Display Window

- The Disc No., Track No., playing time and other information are displayed in the display window.

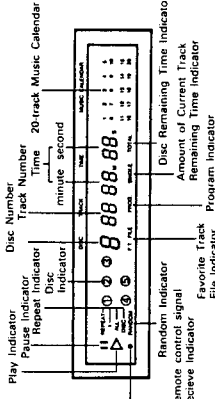

1 Power Switch (POWER)

- Press this button to switch on the power.
- When the power is turned off, the unit is set to the standby mode.
- If the power is turned off during playback or while the disc information is displayed on the time display, several seconds after the power is turned back on, the number of the disc appears on the disc number display, the total number of tracks on that disc is displayed on the track number display, and the total time is displayed on the time display, and approximately 1 second later playback starts.

2 Loading drawer

- Discs can be loaded and unloaded when this drawer is open. Do not force the drawer closed by hand.

3 Open/Close Button (OPEN/CLOSE)

- Press this button when opening.
- The drawer is opened toward the front.
- Press the button again to close the drawer.

4 Play Button (PLAY)

- Press this button to play a disc.
- The [PLAY] indicator lights up when the button is pressed, the number of the disc and the track being played is displayed by the Disc Number and Track No. indicator, and the amount of elapsed time for the current track is displayed by the Time indicator.
- The [PLAY] indicator goes off after playing of the final track of the final disc is finished and the player stops.

5 Stop Button (STOP)

- Press this button to stop play.

6 Pause Button (PAUSE)

- Press this button to stop play temporarily.
- Pressing the Pause button during play stops play temporarily. The [PAUSE] indicator goes off and the [PAUSE] indicator lights up.
- To cancel the Pause state, press either the Play button or press the Pause button a second time.

7 Disc trays (1 ~ 5)

- One disc per tray can be loaded.

8 Disc skip button (DISC SKIP)

- Each time this button is pressed, the carousel will rotate in a clockwise direction to the next tray position. This allows for loading or unloading of discs.
- This button is also used to select the next disc, in the normal play continuously.

9 Automatic/Manual Search Reverse Button

- Press this button to return the pickup to the beginning of the present track. Press again to return to other tracks.
- By pressing the button a number of times, the pickup will move back the corresponding number of tracks.
- Keep on pressing this button for more than 0.5 seconds during playback for fast reverse search. As long as the button is kept pressed, music signals are played back faster than normal.
- Keep on pressing this button for more than 0.5 seconds when the pause mode is engaged, you can quickly reverse the pickup to a desired position, three times faster compared to manual reverse search during playback. During this time, no sound is heard.

- 14 Remote Control Receptor (REMOTE SENSOR)
  - This receptor receives infrared signals from the wireless remote control unit.
  - Aim the wireless remote control unit at this receptor window when operating it.
- 15 +/-10 Button (+/-10)
  - Press this button when selecting a track with a number greater than 11.
  - Use this button in combination with the number buttons. For example, when selecting track number 15, press [+10], then [5].
  - To select track number 32, press [+10], [10], [+10], then [2].
- 16 Program/Direct Button (PROG/DIRECT)
  - Pressing this button selects between program memory and direct track selection.
- 17 Track Number Buttons (1 ~ 10)
  - Press these buttons when making direct track selections or when entering tracks in program memory.
  - For example, when making a direct track selection, press the [3] button when desiring to play track 3. The player will then begin playing track 3.
  - When desiring to play track 12, press [10], then [2].
  - When making a program, press the Program/Direct button [ ] to enter the Program Mode.
- 18 Disc Number Buttons (DISC NO.) (1 ~ 5)
  - Press these buttons to specify which disc you want to play.
- 19 Volume Adjustment Knob (LEVEL)
  - Use this knob to adjust the output level (volume) for the headphones.
  - Use this knob to adjust the output level (volume) for the headphones and line output (VARIABLE). (DCM-560 only)

- 20 Headphone Jack (PHONES)
  - Insert the jack of the headphones when desiring to listen to a disc privately. (Headphones are sold separately.)
- 21 Favorite Track File Button (F.T. FILE - FILE) (DCM-560 only)
  - Press when switching to the F.T. file mode and when storing the program of the F.T. file to the file. (Refer to page 14, item 6.)
- 22 Favorite Track File Clear Button (F.T. FILE - CLEAR) (DCM-560 only)
  - Press to delete the program of the F.T. file which is stored in the file. (Refer to page 14, item 6.)
- 23 Output Terminal
  - Connect the connection cords from these terminals to the amplifier's input terminals. (See page 6 for connections.)
- 24 SYNCHRO Jack (SYNCHRO)
  - To make a synchronized recording, this jack must be connected to the SYNCHRO jack of the deck with a connection cord. (See page 8 for connections.)
- 25 Digital Output Jack (COAXIAL)
  - This jack outputs digital data.
  - We recommend using a 75 Ohm pin cord (available in stores) for connections. (See page 9 for connections.)

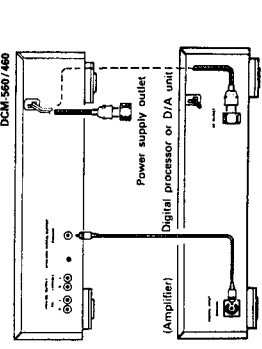

(3) Connecting the Digital Output Jack (COAXIAL)

Use a 75 Ohm pin cord to connect the digital output jack (COAXIAL) of the DCM-560/460 to the digital input jack (COAXIAL) on a digital processor or D/A unit, available in stores.

CONNECTIONS

- (1) Connecting the Output Terminal
  - Connect one end of the connection cord supplied with the CD Player to the output terminals, left (L) and right (R) of the CD Player, and the other end to the CD, AUX or TAPE PLAY input terminals, left (L) and right (R), of the amplifier.

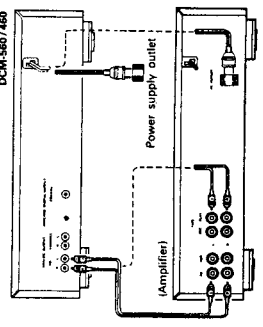

- (2) SYNCHRO Jack Connections
  - Connect the SYNCHRO jack with a DENON cassette deck which is equipped with a SYNCHRO jack, then make a synchronized recording. Use the connection cord supplied with the cassette deck.
  - To make use of this function, also connect the output jacks and make the settings so that a recording can be made from the CD player to the cassette deck.

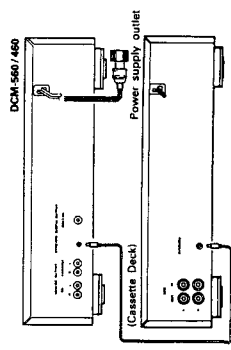

OPENING AND CLOSING THE DRAWER AND LOADING A DISC

- Opening and closing the drawer (This operation only works while the power is on.)
  1. Press the power switch (POWER) to turn on the power.
  2. Press the open/close button ( OPEN/CLOSE).

How to load a disc

- Make sure the drawer is completely open.
- Hold the disc by the edges and place it on the disc tray. (Do not touch the signal surface, i.e., the glossy side.)
- Set the disc properly in the tray according to its size.
  - Set 8cm discs in the center hole.
  - Set 12cm discs in the outer hole.
- When the drawer is opened during the stop mode, discs can be loaded in the disc 1 to disc 4 trays. If the DISC SKIP button is pressed, the carousel turns and a disc can be loaded in the disc 5 tray.
- When the drawer is opened during the play mode, it is possible to load and unload discs in all of the disc trays other than the one whose disc is currently playing. In this case, the DISC SKIP button will not operate.
- Press the open/close button ( OPEN/CLOSE) to close the drawer.

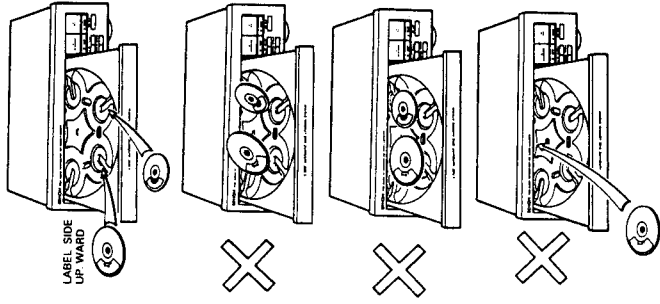

- Caution:
  - The player will not operate properly and the disc may even be damaged if it is not set correctly.
  - If your finger should get caught in the drawer when it closes, press the open/close button ( OPEN/CLOSE).
  - Do not place any foreign objects on the disc tray, and do not place more than one disc on the tray at a time. Otherwise malfunction may occur.
  - Do not push in the disc tray manually when the power is off as this may cause malfunction and damage the CD player.
  - Do not touch the carousel while it is turning. Also, do not turn the carousel by hand when it is stopped. Doing so could damage it.
  - Do not insert disc where indicated by arrow.
  - This could damage the internal mechanism in the unit.

**NORMAL PLAY**

Follow the steps below to get an understanding of the disc play procedure.

(1) Starting Playback

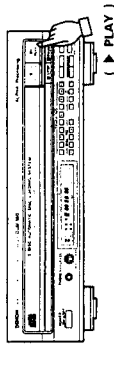

1. Turn the power switch on and press the open/close (▲) OPEN/CLOSE button to open the drawer.
2. Set the disc to be played in the tray on left side.
3. Press the play button (▶).
4. The drawer closes and the disc just loaded is played.
5. The disc number, track number and elapsed time, etc., for the disc currently playing appear on the display window.
6. If the open/close (▲) OPEN/CLOSE button is pressed while a disc is playing, playback continues, but the drawer opens and four discs can be replaced. Press the open/close (▲) OPEN/CLOSE button again to close the drawer.

(2) Stopping Playback

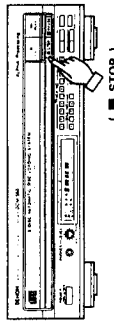

1. Press the stop button (■) to stop playback.
2. To replace discs, press the open/close (▲) OPEN/CLOSE button. The disc which was playing switches over to the left side and the drawer opens.



- Set the disc you want to played in the left side.

**OTHER PLAY METHODS**

In addition to normal play, the following methods can be used when playing a disc.

(1) To Play the Desired Disc and Desired Track

DCM-560

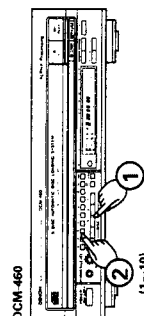
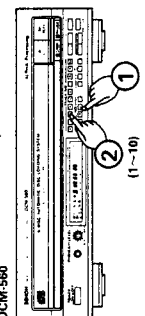

1. Press the button for the number of the desired disc (1 to 5).
  2. Next, press the number of the desired track (1 to 10 and +10 buttons).
- Input the number of the track you would like to play with the Track Number buttons. If you would like to play the 4th track on the 3rd disc, press [3] for the Disc Number, then [4] for the Track Number. If you would like to play the 12th track on the 5th disc, press [5] for the Disc Number and [+10] and [2] for the Track Number. Play will begin from the number of the disc and the track input.

(2) To Move to the Next Track during Play

Press the Automatic/Manual search forward button (▶▶/▶▶) for less than 0.5 seconds during playback.

- The pickup will advance to the beginning of the next track and playback will continue. Pressing the button several times will forward the pickup the corresponding number tracks.

DCM-560

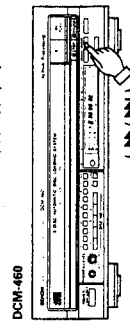
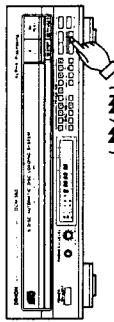

Press the ▶▶/▶▶ button

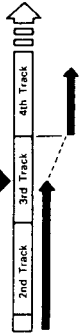

- During Random or Program operation, player moves to the beginning of the next random or program track selection.

(3) To return to the beginning of the track now being played

DCM-560

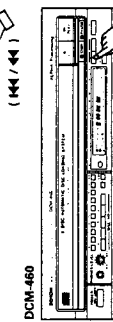
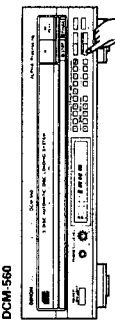

Press the Automatic/Manual search reverse button (◀◀/◀◀) for less than 0.5 seconds during playback.

- The pickup will return to the beginning of the current track and playback will continue. Pressing the button several times will return the pickup the corresponding number tracks.

Press the ◀◀/◀◀ button

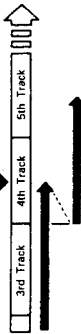

(4) To Play the Desired Discs and the Desired Tracks in the Desired Order

DCM-560

- You can play certain tracks on the loaded discs in any order.
- Tracks on a disc not loaded can also be programmed, but if you try to play that disc, the microprocessor detects that it is not loaded and the following disc is played automatically.
- Up to 20 tracks can be set in a program.
- A program can be made for a single entire disc.

(1) Programming

DCM-560

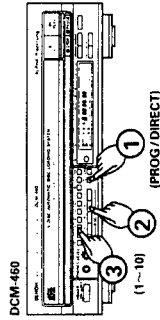
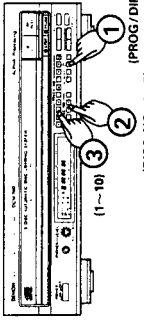

- Pressing the Program (PROG/DIRECT) button causes the Program indicator to light up. Select the disc, track in the program using the Disc Number buttons and the Track Number buttons and [10] button. For example, if you would like to hear the 3rd track of the 2nd disc and the 12th track of the 5th disc, press [PROG/DIRECT], Disc Number [2], Track Number [3], Disc Number [5], then Track Number [12]. If it is not necessary to specify the disc, if all the tracks in the program are from the same disc. If all the tracks on being selected from the same disc, all the tracks on a particular disc can be played, such as from the 1st track of the 3rd disc, all tracks of the 5th disc and the 5th track of the 5th disc. In this case, press [PROG/DIRECT], Disc Number [3], Track Number [1], Disc Number [5], then Disc Number [5], Track Number [5].

(2) To Check the Programmed Tracks

DCM-560

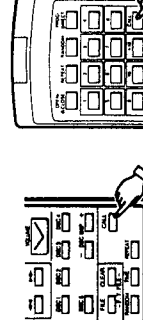

(CALL)

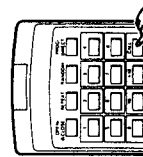

(CALL)

- Press the call button on the wireless remote control unit. The contents of the program are displayed in order one item at a time each time the Call button is pressed.

(3) To Play a Program

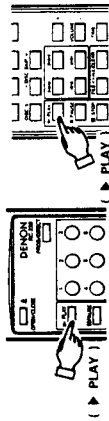
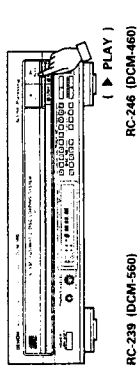

- Press the Play (▶) button to play the programmed selections in the order in which they were programmed.
- To clear the entire program
  - Pressing the PROG/DIRECT button once more erases the entire program. Pressing the open/close (▲) OPEN/CLOSE button also erases the contents of a program.
  - Pressing the PROG/DIRECT button while a program is being played cancels the program. Play will then be continuous to the end of the disc currently being played, after which the player will stop automatically.

**Cautions**

- If a program is run during playing of a track or from the Pause state, the track which is currently being played becomes the 1st track in the program.
- Additional tracks can be added to the program, but the player will not display the number of tracks in the program or the playing time.
- Direct selection cannot be done while a program is being played. Inputting the track number of a desired track with the Track Number buttons adds the input track to the end of the program.
- When programming, do not program a track number which is not recorded on the disc. If such a number is programmed by mistake, the player ignores the program.

- To Repeat Play of All Tracks
  - Press the Repeat (REPEAT) button. The REPEAT indicator will light up.
  - Steps ① and ② can be done in any order, with the same results.

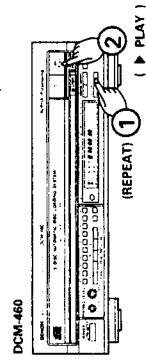
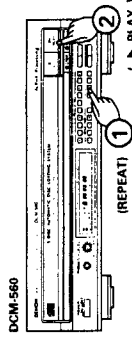

- When the repeat button is pressed once, the REPEAT and ① indicators light. In this mode, the track currently playing is repeated.

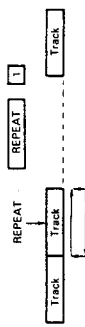

- If the repeat button is pressed again, the REPEAT and ① DISC indicators light, and the disc currently playing is repeated.

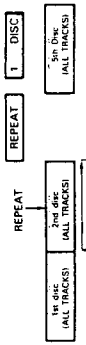

- If the repeat button is pressed again, the REPEAT and ① ALL DISC indicators light, and all the discs currently loaded are repeated.

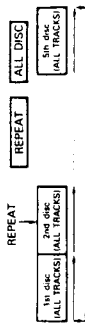

- Pressing the Repeat (REPEAT) button during play will also cause the player to repeat play (of all tracks).
- To cancel repeat play, press the Repeat (REPEAT) button once more.
- Pressing the Repeat (REPEAT) button while a program is being played will cause the tracks in the program to be played again in order.
- Pressing the Repeat (REPEAT) button during Random play will cause the tracks to be played again at random.

- Letting the Player Select the Order of Play
  - Full Random Play

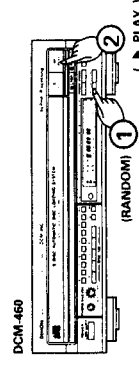
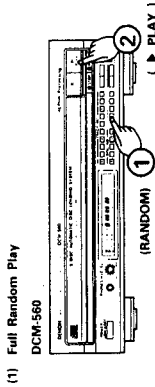

- Press the Random button, then press the Play button. The microcomputer will then start play of the tracks on the 5th disc at random.

(2) Program Random Play

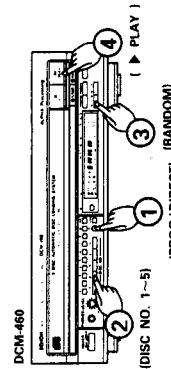
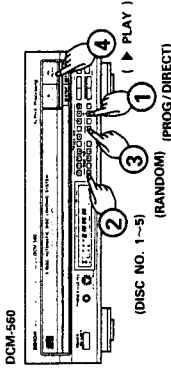

- After pressing the PROG/DIRECT button and inputting a program (See item ① on page 11), press the Random button, then the Play button. The microcomputer will then select tracks from the program at random and play them.

(3) Disc Sequential Random Play

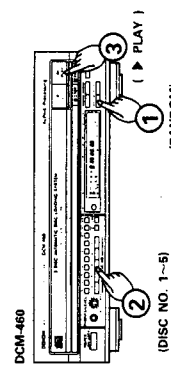
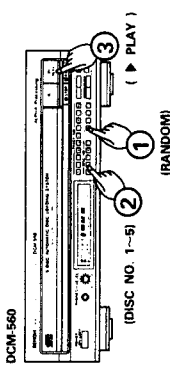

- Press the Random button. Next press the Disc Number buttons for the discs to be played, in the desired order, then press the Play button. The microcomputer will then select tracks from the specified discs to be played at random, in the order in which the discs were selected. Up to 5 discs can be selected, and the same disc can be selected, two or more times. Disc sequential random play is cancelled when play ends.

- To Cancel Random Play
  - Pressing the Random button once more cancels the Random function. Play will then proceed from the track currently being played to the end of the last track on the disc, then stop. Pressing the open/close (▲) OPEN/CLOSE button also cancels the Random function.

**Cautions**

- Pressing the Random button during normal play starts full random play.
- Pressing the Random button during Program play starts random play of the tracks in the program, including the tracks which have already been played.
- During random play, the player may display the number of disc which is not loaded in the tray. In such a case, the player will read the disc information, then reset automatically to correct. This is not a malfunction.

(2) To Stop Play Temporarily

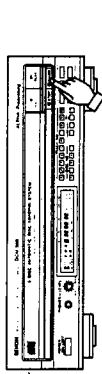

- Pressing the Pause button during play stops play at that point. Pressing the Pause button once more starts play again from the same point.
- Press the Pause (PAUSE) button.

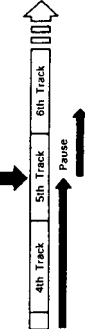

- Press the Play (▶) button or the Pauses (⏸) PAUSE button.
- Press the Play (▶) button or the Pauses (⏸) PAUSE button to start play.

(3) Audible quick search

- Using this function, you can cue to a desired point within a track, either in the forward or reverse direction.
- Release the automatic/manual search button (⏮/⏪ or ⏩/⏭) when the desired point has been reached. Normal playback then continues.

(1) Manual Search Forward

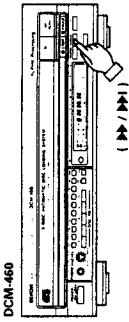
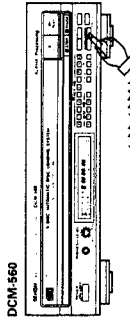

- Keep on pressing the automatic/manual search forward button (▶▶) for more than 0.5 seconds during playback. Playback of the track is speed up.
- As a reference, the current track number and elapsed playback time within the track are displayed.

- Manual search forward is approximately three times faster when engaged during the pause state compared to playback.
- If the automatic/manual search forward button (▶▶) is kept pressed after the end of the final track on the disc is reached, [3] is displayed and manual search stops. To return to another point, press the automatic/manual search reverse button (◀◀) until [3] disappears.

(2) Manual Search in Reverse

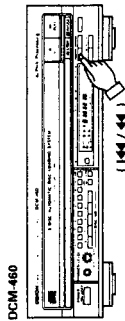
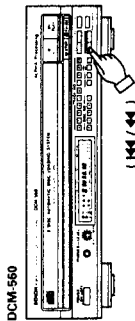

- Keep on pressing the automatic/manual search reverse button (◀◀) for more than 0.5 seconds during playback. Reverse playback of the track is speed up.
- As a reference, the current track number and elapsed playback time within the track are displayed.
- Manual search in reverse is approximately three times faster when engaged during the pause state compared to playback. In this case, no sound is heard however.
- If the automatic/manual search reverse button (◀◀) is kept pressed after the beginning of the first track on the disc is reached, [1C] is displayed and manual search stops. To return to another point, press the automatic/manual search forward button (▶▶) until [1C] disappears.

- (3) To Cue and Stop Play
- Cueing by Direct Selection
- Cueing by direct selection, then entering the Pause state, is convenient for practicing vocals with background music.

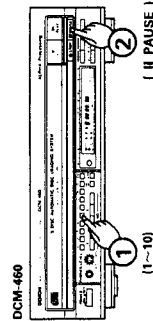
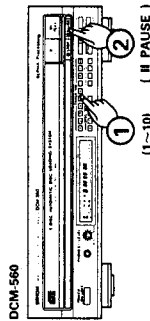

- Press the Track Number buttons to set the number of the desired track.
- To start play, press (H PAUSE) button.
- To start play, press the Play (▶ PLAY) button or the Pause (H PAUSE) button.

(2) Cueing by Program Selection

- After setting the desired track selections in a program, press the Pause (H PAUSE) button. The player will advance to the beginning of the 1st track in program memory and wait in the Pause state.

(3) Stores your favorite tracks for each of the discs

- Favorite Track File (F.T. FILE)
- Permits programming of the tracks you do not wish to listen to from among the tracks recorded on the disc; then skips these tracks when the disc is played.
- When these tracks are recorded to the file, the program is automatically called by setting the F.T. FILE mode, even after the disc has been changed and the power switched off.
- Up to 8 tracks can be programmed within 1 disc.
- Up to 100 discs can be recorded to file.
- The program contents are displayed on a calendar.

(1) Disc programming and recording to file

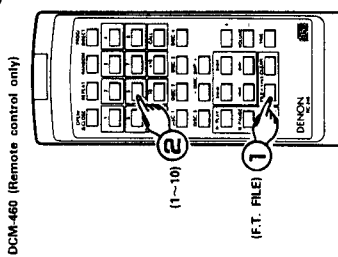
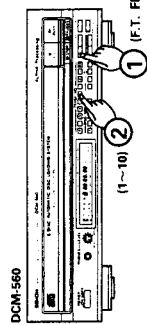

- Pressing the FILE button in the stopped condition will light up F.T. FILE. Select the tracks to be programmed using the Track Number button and the [10] button. For example, to program the 3rd, 12th, and 7th tracks, press [FILE], [3], [10], [2], and [7]. Each time a track is specified, that track number is deleted in the calendar. The total number of tracks to be played is displayed under TRACK No. and the total play time is displayed under TIME.
- When recording the program to file, after selecting the program, press the FILE button. "FILE" will be displayed on the time display for about 1 second.

(2) Programmed Play

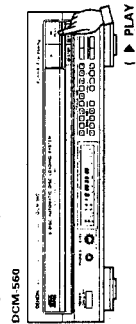

DCM-460 (Remote control only)

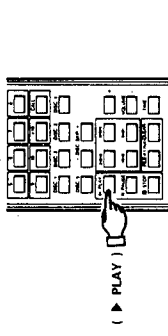

- Pressing the ▶ PLAY button will call the files for each of the discs to be played, then play the disc, skipping the programmed tracks.

(3) To delete the programs recorded to the file

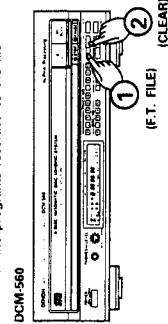

DCM-460 (Remote control only)

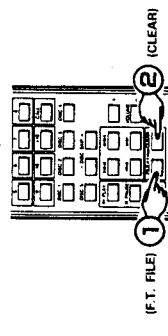

- Press the FILE button and press the CLEAR button while "FILE" is being displayed on the time display. "CLEAR" will be displayed on the time display for about 1 second and the program of that disc will be deleted from the file.

- Contents of the F.T. File
- Up to 100 discs can be recorded to the F.T. file. When 100 discs have been recorded, if a new disc is loaded, the program cannot be recorded by pressing the FILE button after track selection according to the operation of Step (1). This procedure will result in "FULL" being displayed on the time display for about 1 second.
  - When the program of a new disc is recorded to the file, first delete the file that has already been recorded using the operation of Step (3).

- To Cancel the F.T. FILE Mode
- DCM-460 (Remote control only)
  - Pressing the program/direct selection (PROGRAM DIRECT) and OPEN/CLOSE button cancels the F.T. FILE mode and sets the direct mode.

CAUTION

- Pressing the Number button and the [10] button during play provides direct track selection.
- When track selection has not been made, all recorded tracks are played.
- Can be used only when the drawer is closed.
- The remaining time display of the track is limited to the 1st through 20th tracks of the disc.
- For discs with 21 or more tracks recorded, the total time at the time of programming and the program remaining time are not displayed.
- After the program track selection, changing to a separate disc before recording to the file will result in program cancellation.
- Program calling is not possible with the CALL button in the F.T. FILE mode.
- Random play is possible in the F.T. FILE mode. In this case, disc sequential random using the F.T. FILE is set.
- When in the random mode, the F.T. FILE mode cannot be set even when the FILE button is pressed. It is also not possible to store or erase files. Set the F.T. FILE mode, program, then press the RANDOM button.

(2) Synchronized Recording Function

- Synchronized Recording Function
- Connecting the SYNCHRO jack with a DENON cassette deck which is equipped with a SYNCHRO jack will allow synchronized recording to be made.
- To use this function, be sure to connect the SYNCHRO jacks as well as the output terminal (LINE OUT). (See Page 8 for connections.) Then, insert a disc.
- With the CD player in the stop or pause condition, starting a synchronized recording at the cassette deck side will automatically cause the CD player to start playing. (This is synchronized play.)
- The remote control indicator of the display will blink during synchronized play.

NOTE

- Synchronized play is also possible in the program mode.
- The repeat mode is cancelled when synchronized play is started.
- Except for the STOP button and OPEN/CLOSE button, the buttons will not operate during synchronized play.
- For further details, see the owner's manual for the cassette deck that has been connected.
- In the play condition, even if you start a synchronized recording at the cassette deck side, CD player will not synchronize with the cassette deck and the cassette deck becomes synchronized pause condition.
- In this case push the STOP button of the cassette deck, set the CD player in the stop or pause condition and start a synchronized recording at the cassette deck side again.



REMOTE CONTROL UNIT RC-239 (DCM-560)

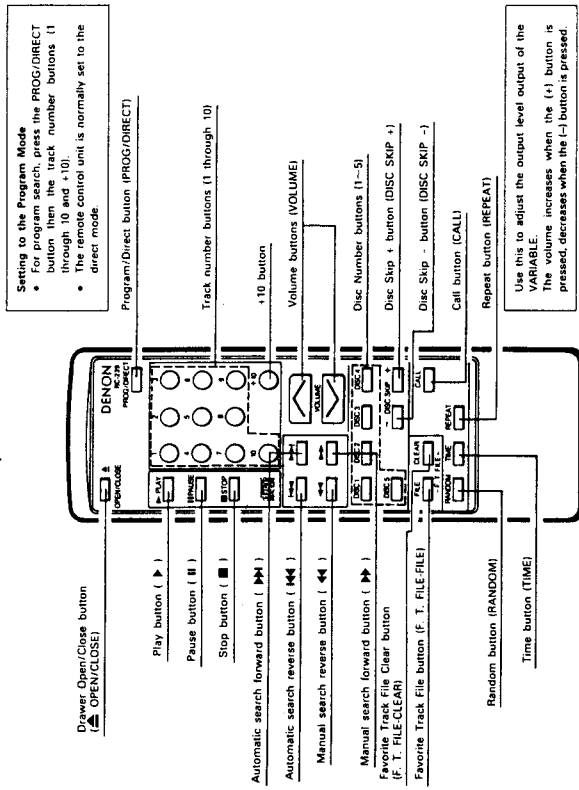

- Direct Selection**  
 Normally, direct search is possible simply by pressing the desired number buttons.
- Program Selection (During playback, the track which is currently playing is programmed as the 1st track.)**  
 Press the PROG/DIRECT button, then press the number buttons.
- Volume**  
 The volume control on the unit will operate when the volume buttons are pressed. The volume can be checked by looking at the position of the control.
- Imparting the Track Numbers**  
 For track numbers below 10, simply press the corresponding buttons. For track numbers of 11 and greater, press the +10 then the number buttons.
- Volume**  
 For example, for track number 22 press +10 twice then 2.
- Volume**  
 The volume control on the unit will operate when the volume buttons are pressed. The volume can be checked by looking at the position of the control.
- Use this to adjust the output level of the VARIABLE.**  
 The volume increases when the (+) button is pressed, decreases when the (-) button is pressed.
- Direct Selection**  
 Normally, direct search is possible simply by pressing the desired number buttons.
- Program Selection (During playback, the track which is currently playing is programmed as the 1st track.)**  
 Press the PROG/DIRECT button, then press the number buttons.
- Volume**  
 The volume control on the unit will operate when the volume buttons are pressed. The volume can be checked by looking at the position of the control.
- Skipping Discs**  
 To cancel the program, press the PROG/DIRECT button.
- Disc Skip button (DISC SKIP +, -)** will not function in the random and program modes.
- During disc sequential random playback, when the Disc Skip + button is pressed, the following disc is played in random order.**
- The Time indicator indicates the amount of elapsed time for the track currently being played, the amount of time remaining for the current track and the amount of time remaining for all tracks yet to be played.**
- Normally, the amount of elapsed time for the current track is displayed. Pressing the button once causes the [SINGLE] indicator to light up, displaying the amount of time remaining for the current track. Pressing the button once more turns the [SINGLE] indicator off and causes the [TOTAL] indicator to light up, displaying the time remaining for all tracks yet to be played on the disc. Pressing the button once again turns the [TOTAL] indicator off and causes the indicator to display the elapsed time for the current track.**
- During playback, the total remaining time is the remaining time for the disc. For programmed playback, the remaining time for the program is only displayed when the programmed tracks are all on the same disc.**
- In the case of 21st and subsequent tracks, the time remaining for one track is displayed "....". When 21st and subsequent tracks are programmed, the time remaining for all tracks is displayed "....".**
- "...." is displayed when tracks on more than one disc are programmed.**

INSTALLATION PRECAUTIONS

The CD player uses a microcomputer for controlling internal electronic circuits. In the event that the player is used while a near-by tuner or TV is turned on, although unlikely, interference could occur either in the sound from the tuner or the picture of the TV. To avoid this, please take the following precautions.

- Keep the CD player as far away from the tuner or TV set as possible.
- Keep the power cable and connecting cable of the CD player separate from the antenna wires of the tuner and TV.
- Interference is particularly likely to occur when an indoor antenna or a 300  $\Omega$ /ohm feeder cable is used. Thus, use of an outdoor antenna and 75  $\Omega$ /ohm coaxial cable is strongly recommended.

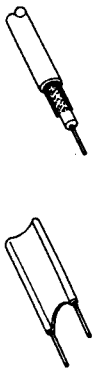

300  $\Omega$ /ohm feeder cable

75  $\Omega$ /ohm coaxial cable

PLAY USING THE REMOTE CONTROL UNIT

The DCM-560/460 CD Player can be controlled from across the room using the accessory Remote Control Unit.

- Inserting the Dry Battery**  
 1. Remove the cover on the back of the remote control unit. RC-239 (DCM-560)



2. Insert two R6P (AA size) batteries in the RC-239 (DCM-560), two R03 (AAA size) batteries in the RC-246 (DCM-460), following the indications on the battery compartment.

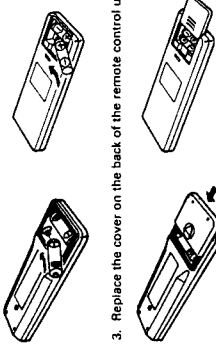

3. Replace the cover on the back of the remote control unit.



Caution Concerning Dry Batteries

- Use R6P batteries in the RC-239 remote control unit, R03 batteries in the RC-246 remote control unit.
- Depending on the frequency of use, the dry batteries should be replaced approximately once per year.
- If the remote control unit fails to control the CD Player, even before a year has passed, replace the dry batteries with new ones.

- Be sure to follow polarity indications inside the case of the remote control unit, inserting the + end and - end of each battery in the directions indicated.
- Batteries may become damaged or leak under the following conditions.
  - Using new batteries together with old ones.
  - Using different types of batteries together.
  - Do not short batteries, take them apart, subject them to heat or throw them into a fire.
  - When the remote control unit is not used for a long period of time, remove the dry batteries.
  - If fluid leaks from the batteries, be sure to wipe up all battery fluid inside the battery case and replace the batteries with new ones.

(2) Using the Remote Control Unit

- Aim the remote control unit toward the light receptor in the front of the CD Player, as shown in the drawing below.
- The remote control unit can be used up to a distance of 8 meters in a straight line from the CD Player. However, this distance will be shortened if there is some obstruction between the remote control unit and the light receptor, or if the beam of light is slanted.

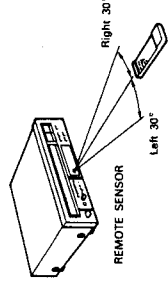

- The remote control unit has the same functions as the main unit, but the following operations cannot be done.
  - Switching the power on and off.
  - Adjusting headphone volume.

Caution During Use

- Do not press the operating buttons on the main unit and the remote control unit at the same time. This could cause a malfunction.
- Operation of the remote control unit will be hindered if a strong light from the sun or a light fixture is shining on the REMOTE SENSOR, or if there is an obstruction between the remote control unit and the CD player unit.

REMOTE CONTROL UNIT RC-246 (DCM-460)

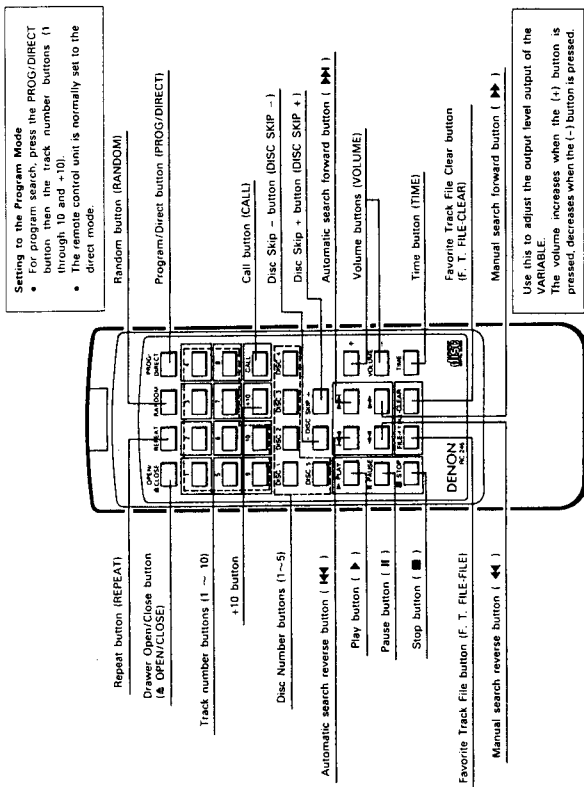

- Direct Selection**  
 Normally, direct search is possible simply by pressing the desired number buttons.
- Program Selection (During playback, the track which is currently playing is programmed as the 1st track.)**  
 Press the PROG/DIRECT button, then press the number buttons.  
 For example, to program tracks number 3, 11, and 5, press PROG/DIRECT → 3 → +10 and 1 → 5.  
 To cancel the program, press the PROG/DIRECT button.
- Skipping Discs**  
 The Disc Skip button (DISC SKIP +, -) will not function in the random and program modes.  
 During disc sequential random playback, when the Disc Skip + button is pressed, the following disc is played in random order.
- Volume**  
 The output level of the VARIABLE output terminal can be changed.  
 When the volume button is pressed, "..." appears in the TIME M (minutes) section of the display window and the level appears in the S (seconds) section. The volume can be changed between a maximum of "0" and a minimum of "-50" in 50 steps, by approximately 1.5 dB per step.
- The Time indicator indicates the amount of elapsed time for the track currently being played, the amount of time remaining for the current track and the amount of time remaining for all tracks yet to be played.  
 Normally, the amount of elapsed time for the current track is displayed. Pressing this button once causes the [SINGLE] indicator to light up, displaying the amount of time remaining for the current track. Pressing the button once more turns the [SINGLE] indicator off and causes the [TOTAL] indicator to light up, displaying the time remaining for all tracks yet to be played on the disc. Pressing the button once again turns the [TOTAL] indicator off and causes the indicator to display the elapsed time for the current track.
- During playback, the total remaining time is the remaining time for the disc. For programmed playback, the remaining time for the program is only displayed when the programmed tracks are all on the same disc.  
 In the case of 21st and subsequent tracks, the time remaining for one track is displayed ".....". When 21st and subsequent tracks is programmed, the time remaining for all tracks is displayed ".....".  
 "....." is displayed when tracks on more than one disc are programmed.

COMPACT DISCS

- Cautions in Handling Compact Discs**
  - Do not get fingerprints, oil, dirt or other substances on the compact disc. If the disc becomes dirty, wipe it off with a dry, soft cloth.
  - Do not clean compact discs with benzene, paint thinner, water, record spray, anti-static agent, silicon cloth or similar substances.
  - Take particular care to prevent scratches to the back side of the compact disc when removing it from the case and when inserting it in its case.
  - Do not bend compact discs.
  - Do not apply to compact discs.
  - Do not attempt to enlarge the center hole of the disc.
  - Do not write on the label (printed) side of the disc with a ball point pen or pencil.
  - Bringing a CD into a warm room from a cold place could cause moisture to condense on the disc surface. Do not attempt to dry the disc with a hair dryer, etc.
- Storage of Compact Discs**
  - After play, be sure to remove the disc from the player.
  - To prevent dust, scratches, deformation, etc., be sure to store compact discs in their case.
  - Do not store compact discs in the following locations.
    - Places where direct sunlight strikes for long periods of time.
    - Places with a high humidity or a lot of dust.
    - Places reached by heat from a heater or similar appliance.

TROUBLE? CHECK THE PLAYER TO FIND WHAT'S WRONG

- Even when it appears that there is trouble, check the following points carefully.
- The drawer won't open/close when the Open/Close button is pressed.
- Is the Power switch on? See page 9, 10, 19.
  - After a disc is loaded (00 00w 00c) is displayed in the display window. See page 11.
  - Is the disc loaded correctly? See page 9, 10, 19.
  - Play does not begin when the Play button is pressed. See page 19.
  - Is the disc dirty or scratched? See page 19.
  - There is no sound, or the sound is distorted. See page 8.
  - Is the output cord connected correctly to the amplifier? See page 8.
  - Does the sound return to normal when the amplifier's knobs are adjusted or the proper input device is selected? See page 16.
- The player won't go to the place specified in the search.
- Is the disc dirty or scratched? See page 19.
  - A program cannot be played. See page 19.
  - Is the method used to make a program and run it correct? See page 11.
- The player won't operate correctly when the remote control unit is used.
- Are the dry batteries in the remote control unit dead? See page 16.
  - Is the remote control unit located too far from the CD Player unit? See page 16.

## SPECIFICATIONS

<b>AUDIO</b>	<b>DCM-560</b>	<b>DCM-460</b>	<b>FUNCTIONS AND DISPLAY</b>	
<b>Number of Channels</b>	2 Channels		<b>Functions</b>	Five discs can be used, Direct Track Selection, Program Selection, Random Play, etc.
<b>Frequency Characteristics</b>	4 ~ 20,000 Hz		<b>Displays</b>	Disc No., Track No., Time (min., sec.), Play, Pause, Repeat, Random, etc.
<b>Dynamic Range</b>	100 dB	100 dB	<b>Other</b>	Headphone Jack (Level Variable)
<b>S N Ratio</b>	113 dB	110 dB	<b>REMOTE CONTROL UNIT RC-239 (DCM-560)</b>	
<b>High Frequency Distortion</b>	0.002% (1kHz)	0.0025%	<b>Remote Control Method</b>	Infrared Pulse system
<b>Separation</b>	102 dB (1kHz)	100 dB	<b>Power Supply</b>	3 V DC Two R6P (standard SIZE AA)
<b>Wow and Flutter</b>	Less than the measuring (+0.001% W. peak)		<b>External Dimensions</b>	60 (W) × 177 (H) × 18 (D) mm (2-23/64" × 6-31/32" × 45/64")
<b>Output Voltage</b>	2.0 V, Variable 0 ~ 2.0V		<b>Weight</b>	100g (approx. 3 oz) (Includes batteries)
<b>DISC USED</b>	Audio compact discs are used 12 cm (5 in) and 8 cm (3 in)		<b>REMOTE CONTROL UNIT RC-246 (DCM-460)</b>	
<b>OVERALL</b>			<b>Remote Control Method</b>	Infrared Pulse system
<b>Power Supply</b>	Show on rating label		<b>Power Supply</b>	3 V DC Two R03 (standard SIZE AAA)
<b>Power Consumption</b>	Show on rating label		<b>External Dimensions</b>	60 (W) × 160 (H) × 16 (D) mm (2-23/64" × 6-19/64" × 5/8")
<b>External Dimensions</b>	434 (W) × 114 (H) × 388 (D) mm (17-3/32" × 4-17/32" × 15-9/32")		<b>Weight</b>	100g (approx. 3 oz) (Includes batteries)
<b>Weight</b>	6.2 kg (13 lbs 13 oz)	5.7 kg (13 lbs)		

\* Design and specifications are subject to change without notice in the course of product improvement.

**ADVARSEL :** USYNLIG LASERSTRÅLING VED ÅBNING, NÅR SIKKERHEDSAFBRYDERE ER UDE AF FUNKTION.  
UNDGÅ UDSAETTELSE FOR STRÅLING.

**VARO!** AVATTAESSA JA SUOJALUKITUS OHITETTAESSA OLET ALTTIINA NÄKYMÄTTÖMÄLLE LASERSÄTEILYLLE. ÄLÄ KATSO SÄTEESEEN.

**VARNING –** OSYNLIG LASERSTRÅLNING NÅR DENNA DEL ÄR ÖPPNAD OCH SPÄRREN ÄR URKOPPLAD.  
BETRAKTA EJ STRÅLEN.

# NOTE FOR HANDLING OF LASER PICK-UP

## DESCRIPTION OF THE COMPONENTS

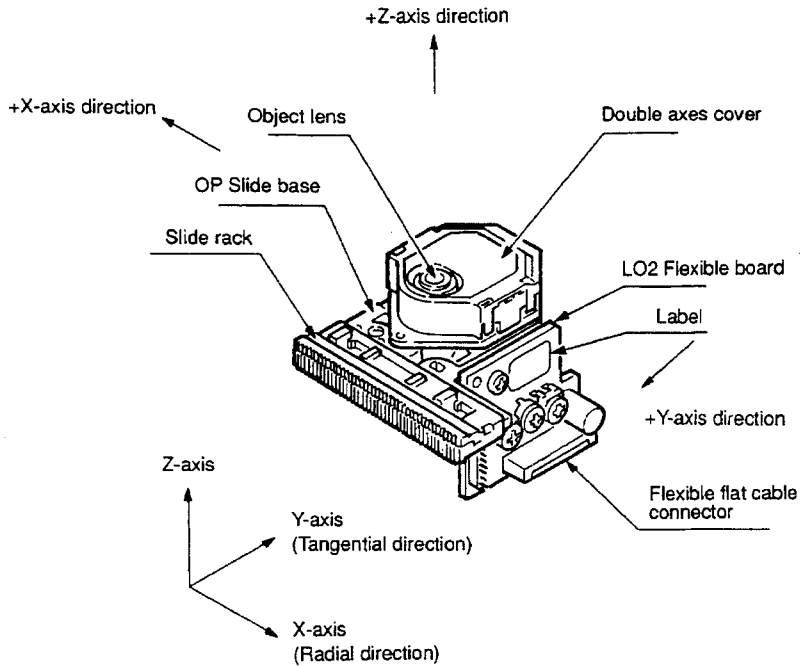

### LABEL

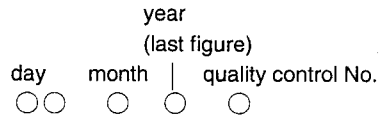
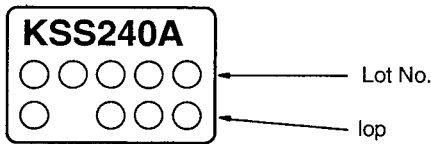

but Oct. Nov. and Dec. are expressed by alphabetical letters of X, Y and Z.

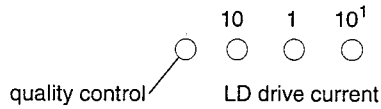

### PIN CONNECTOR

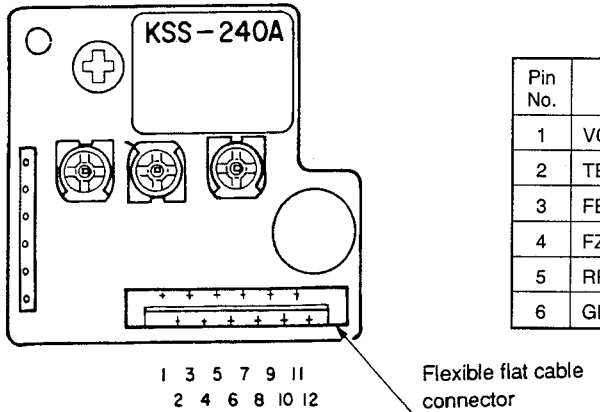

Pin No.	Description	Input/Output	Pin No.	Description	Input/Output
1	VC (+2.5V)	OUT	7	Vcc (+5V)	IN
2	TE (TRK ER signal)	OUT	8	LDC (LD Control)	IN
3	FE (FCS ER signal)	OUT	9	FCS+ (Double axes)	IN
4	FZC (FZC signal)	OUT	10	TRK+ (Double axes)	IN
5	RF (RF signal)	OUT	11	TRK- (Double axes)	IN
6	GND	IN	12	FCS- (Double axes)	IN

The expressed unit is by mA, with omission of the decimal point as for example, 56.5mA will be expressed as 565, but the head of English letter means the control in the manufacturing plant.

## Caution for Handling the Laser Pick-up

The laser pick-up KSS-240A is assembled and precisely adjusted using a sophisticated manufacturing process in our plant. Do not disassemble or attempt to readjust it. Please keep the following instructions carefully in handling pick-up.

### 1. Handle with Care

#### (1) Storage

Do not store the pick-up in dusty, high-temperature or high-humidity environments.

#### (2) Please take care for preventing from shock by falling down or careless handling.

### 2. Laser Diode (LD)

#### (1) Protect your eyes

The laser beam may damage the human eye, since the intensity of the focused spot may reach  $7 \times 10^3 \text{ W/cm}^2$  even if the intensity at the objective lens is 400  $\mu\text{W}$  maximum. As the light beam spreads after focused through the objective lens, it does not effect you in the place as far as more than 30 cms. However, do not look at the laser light beam either through the objective lens directly nor another lens or a mirror.

#### (2) Poison of As

Since the LD chip contains As (Arsenic), as GaAs + GaAlAs, as known as the poison, although the poison is relatively weak, in comparing with others, e.g.  $\text{As}_2\text{O}_3$ ,  $\text{AsCl}_3$  etc., and the amount is small, avoid putting the chip in acid or an alkali solution, heating it over  $200^\circ\text{C}$  or putting it into your mouth.

#### (3) Avoid surge current or electrostatic discharge

The LD may be damaged or deteriorated by its own strong light if a large current is supplied to it, even if only a short pulse.

Make sure that there is no surge current in the LD driving circuit by switches or else. Be careful to handle pick-up as it may be damaged in a moment by human electrostatic discharge. The pins of the LD are short-circuited by solder for protection during shipment.

For safety handling of an LD, grounding the human body, measuring equipments and jig is strongly recommended. And still it is further desirable to make use of mat on the platform and floor for handling the LD.

To open the short circuit, remove the soldering quickly with a soldering iron whose metal part is grounded.

The temperature of the soldering iron should be less than  $320^\circ\text{C}$  (30W).

### 3. Actuator

#### (1) The performance of the actuator may be effected if magnetic material is located nearby, since the actuator has a strong magnetic circuit. Do not permit dust to enter through the clearance of the cover.

#### (2) Cleaning the lens

It may change the specifications by attaching dust or ash on the objective lens. Clean the lens with a cleaning paper dampened with a little water, not pressing lens with so much strength by the cleaning paper.

### 4. Metal Bearing

As the metal bearing of Cu-compound sintered alloy is impregnated with FROIL946P (\*Part No. 529 0054 007), never fail to supply the bushing with the same lubricant at the time of replacing the pick-up.

### 5. Handling

Please handle the laser pick-up with holding the side base (rosin molded part).

When either a part of human body or some other things may happen to touch directly with the circuit part of P.W.Board, it may cause deterioration, take careful attention in handling this base.

### 6. Deterioration

As KSS-240A comprises built-in RF Amp and APC circuit, it resists stronger against external electrostatic damages than the former typed pickup. However, there is possibility of pickup distortion in the following cases.

#### (1) Low HF level, or with great numbers of jitters.

#### (2) Tracking offset (EF Balance) is out of order (Refer to "Confirmation Method of Adjustment" for confirmation on (1) and (2)).

## DISASSEMBLY

### ● Top Cover

Remove 4 screws from both sides and 1 screw from Rear Panel and slide Top Cover slightly background (approx. 5mm) and pull it up.

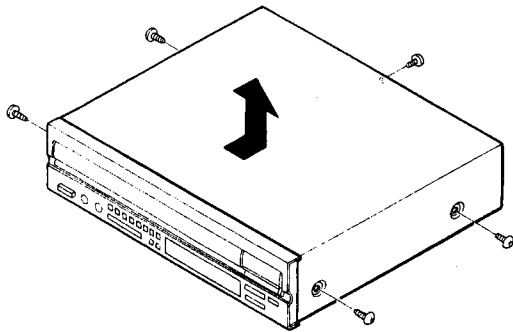

### ● PU Mechanism

After removing rear panel, remove 1 screw.

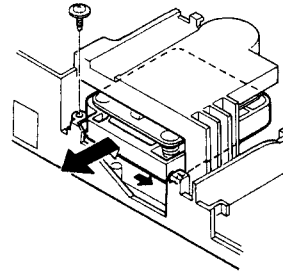

### ● Front Panel

1. Remove 3 hooks from bottom surface of unit.
2. Remove screws fixing front bracket and detach subpanel from hook of the front bracket.

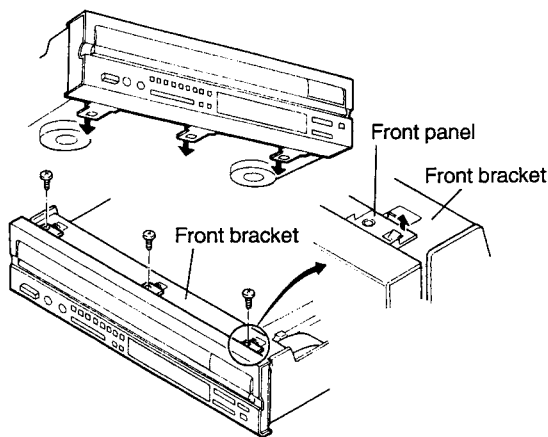

### ● Bottom Cover

1. Remove 3 screws fixing foot and 5 screw fixing bottom cover and 3 screws fixing rear panel, 10 in total. (These screws are P-tight type)  
Do not remove screws marked with ★. (This screw is S-tight type)

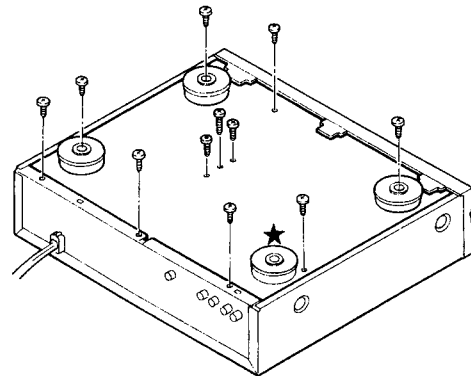

### ● Loader Frame Ass'y

1. Remove hooks of loader frame, and pull out 2 loader brackets from right and left sides.
2. Pull the loader frame assembly frontward.

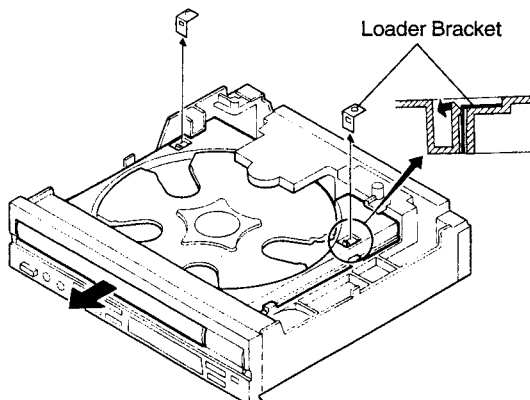

2. ① Slide the bottom cover backward (approx. 5mm) and when it touches the rear panel in end, ② lift up front portion of the bottom cover and pull it.

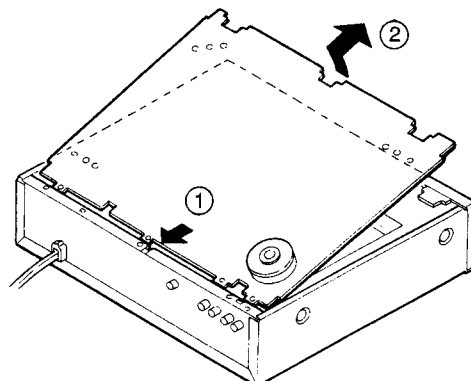

## ADJUSTMENT

Microcomputer built in the unit, comprises service program to facilitate servo adjustment by pushing operation button.

### 1. Start service program

- (1) Turn power switch OFF.
- (2) Shortcircuit ④ pin (SWOP) and ③ pin (SWCL) of TP102 on P.W.B. (Main Unit)  
(Caution) Do not touch other pins.
- (3) Turn power switch ON.  
(Service program starts, and displays track number 01)

(Caution)

- When service program started normal operation of buttons will be defeated.

### 2. Service program function

• Make sure a disc has been loaded in the NO.1 disc tray.

Button	Function	Description
▲ OPEN/CLOSE	Opens or closes the disc holder.	<ul style="list-style-type: none"> <li>● Opens or closes only when disc is stopped.</li> <li>● Operate other keys after open or close.</li> </ul>
■ STOP	Stops system function.	<ul style="list-style-type: none"> <li>● Displays track number 01.</li> <li>● Push when adjustment completed, or do it again.</li> </ul>
▶ PLAY	Starts focus servo and disc turns.	<ul style="list-style-type: none"> <li>● Push when adjust tracking offset.</li> <li>● When completed, displays track number 02.</li> </ul>
PAUSE	Starts focus servo, tracking servo, slide servo, spindle servo.	<ul style="list-style-type: none"> <li>● When PAUSE button is pushed, starts tracking servo and slide servo.</li> <li>● When completed, track number 03.</li> </ul>
Other button	No normal operation.	<ul style="list-style-type: none"> <li>● Do not operate buttons other than above.</li> <li>● If misoperated, immediately turn power switch OFF.</li> </ul>

(Caution)

- Do not use remote control during service program mode.

### 3. Adjustment

#### (1) Location

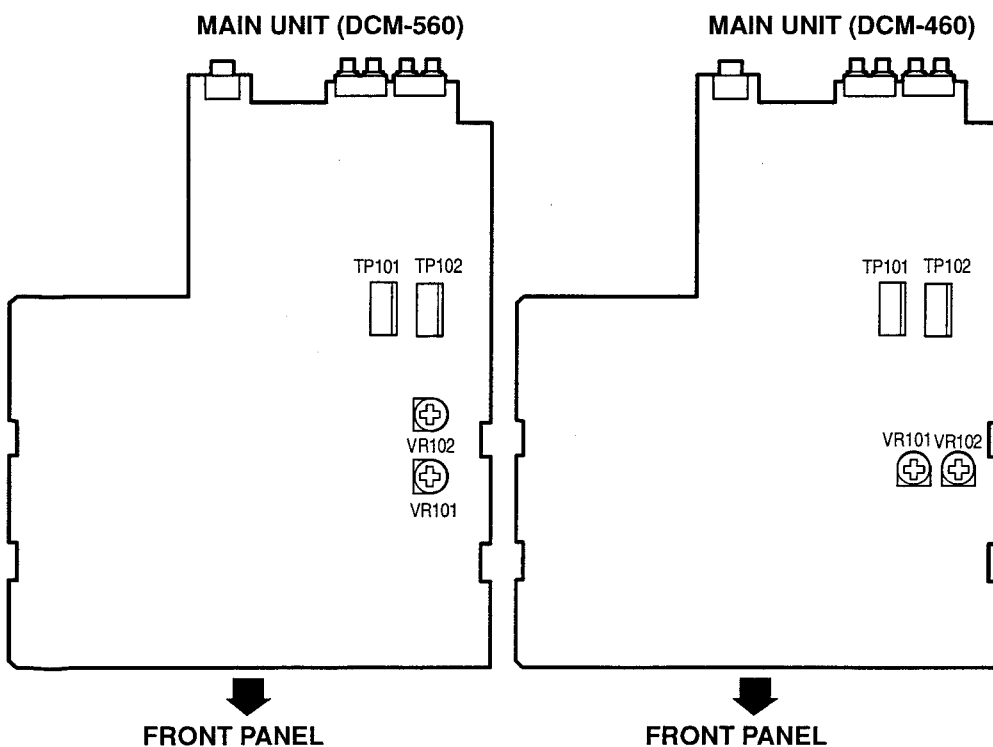

(Caution)

- When playing back in state of open top cover, there may be possibility of playback failure due to light entering into disc detection sensor. In such case, shield the light by hand or other so that the light does not come into sensor.

TP101

- ⑥ TEI
- ⑤ VC
- ④ FOK
- ③ TEO
- ② FEI
- ① FEO

TP102



- ⑥ +5V
- ⑤ VC
- ④ SWOP
- ③ SWCL
- ② SMD
- ① #F

**(2) Necessary equipment for adjustment**

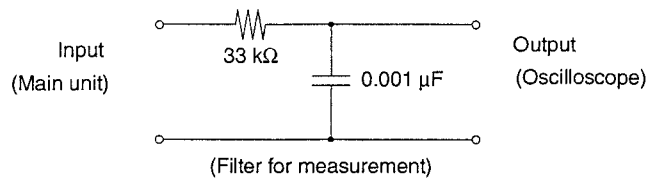
1. Dual trace oscilloscope
2. Reference disc (CA-1094)
3. Oscillator (10 Hz ~ 10 kHz, 0 ~ 3 Vp-p)
4. Frequency counter (readable more than 5 KHz)
5. Filter for measurement



**(3) Preset**

1.	Start service program.	
2.	Preset VR101, 102 as per right figure.	<div style="display: flex; flex-direction: column; align-items: flex-start;"> <div style="display: flex; align-items: center; margin-bottom: 10px;"> <div style="text-align: right; width: 60px;">VR101 (F-GAIN)</div> <div style="text-align: center; margin-right: 10px;">  </div> <div>W0J156 O'clock</div> </div> <div style="display: flex; align-items: center;"> <div style="text-align: right; width: 60px;">VR102 (F-GAIN)</div> <div style="text-align: center; margin-right: 10px;">  </div> <div>W0J156 O'clock</div> </div> </div>
3.	Step.	<ol style="list-style-type: none"> <li>1. Focus gain (VR101)</li> <li>2. Tracking gain (VR102)</li> <li>3. Tracking offset recheck</li> <li>4. HF Level recheck</li> </ol>

**4. Focus gain**

Connection

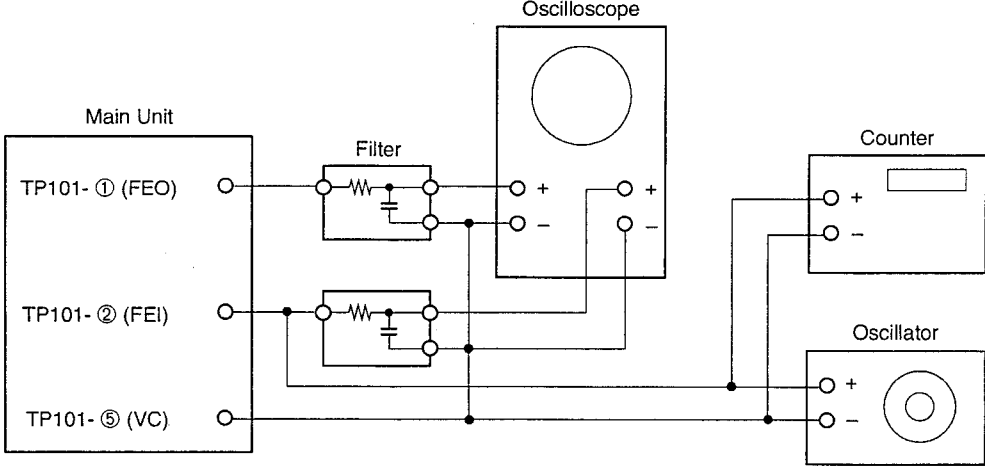

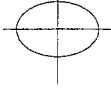
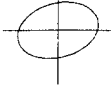

Oscillator	Counter	Oscilloscope	Adjust	Check	Step				
930 Hz 2 Vp-p (±0.1 V)	930 Hz	<table border="1" style="width: 100%; border-collapse: collapse;"> <tr> <td style="width: 50%; text-align: center;">V</td> <td style="width: 50%; text-align: center;">H</td> </tr> <tr> <td colspan="2" style="padding: 5px;"> <ul style="list-style-type: none"> <li>● DC range</li> <li>● X-Y mode</li> </ul> </td> </tr> </table>	V	H	<ul style="list-style-type: none"> <li>● DC range</li> <li>● X-Y mode</li> </ul>		VR101 (Volume)	(Oscilloscope)  Y axis  X axis  Phase 90° Waveform not right  Y axis  X axis	<ol style="list-style-type: none"> <li>1. Push <b>PAUSE</b>. (Displays track number <b>03</b>)</li> <li>2. Connect oscillator.</li> <li>3. Set oscillator to 930 Hz/2 Vp-p.</li> <li>4. Switch oscilloscope input to X-Y mode.</li> <li>5. Adjust VR101 [F-GAIN] to symmetrize Lissajous figures to X-Y axes.</li> </ol>
V	H								
<ul style="list-style-type: none"> <li>● DC range</li> <li>● X-Y mode</li> </ul>									

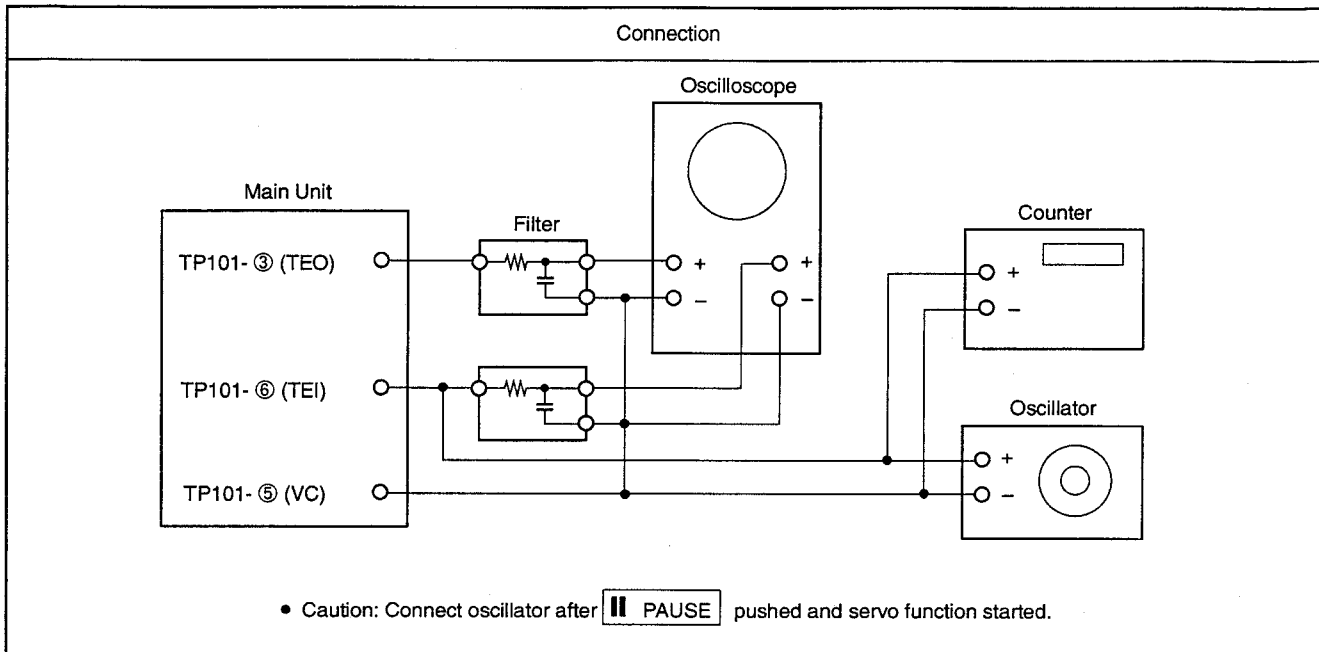

### 5. Tracking gain



Oscillator	Counter	Oscilloscope	Adjust	Check	Step				
<ul style="list-style-type: none"> <li>● 2.7 kHz (±120 Hz)</li> <li>● 0.8 Vp-p (±0.1V)</li> </ul>	2.7 kHz (±120 Hz)	<table border="1" style="width: 100%; border-collapse: collapse;"> <tr> <td style="width: 50%; text-align: center;">V</td> <td style="width: 50%; text-align: center;">H</td> </tr> <tr> <td colspan="2" style="text-align: center;"> <ul style="list-style-type: none"> <li>● DC range</li> <li>● X-Y mode</li> </ul> </td> </tr> </table>	V	H	<ul style="list-style-type: none"> <li>● DC range</li> <li>● X-Y mode</li> </ul>		VR102	(Oscilloscope)  Y axis  X axis Phase 90° Waveform not right Y axis  X axis	<ol style="list-style-type: none"> <li>1. Push <b>[ PAUSE ]</b>. (Displays track number <b>03</b> )</li> <li>2. Connect oscillator.</li> <li>3. Set oscillator to 2.7 kHz/0.8 Vp-p.</li> <li>4. Switch oscilloscope input to X-Y mode.</li> <li>5. Adjust VR102 [T-GAIN] to symmetrize Lissajous figures to X-Y axes.</li> </ol>
V	H								
<ul style="list-style-type: none"> <li>● DC range</li> <li>● X-Y mode</li> </ul>									

### 6. Tracking offset (E/F Balance)

Connection			
Oscilloscope		Check	Step
V	H	(Oscilloscope)	<ol style="list-style-type: none"> <li>1. Push <b>▲ OPEN/CLOSE</b> and load disc holder reference disk.</li> <li>2. Push <b>▲ OPEN/CLOSE</b> and close disc holder.</li> <li>3. Push <b>▶ PLAY</b> to turn disc. (Displays track number <b>02</b>)</li> <li>4. Short (+)(-) of oscilloscope and check the base line.</li> <li>5. Confirm that upper and lower amplitude of the waveform is symmetric against 0V.</li> </ol>
0.1v/div	1~2 ms/div	$\frac{A - B}{A + B} < 20\%$	

### 7. HF level

Connection			
Oscilloscope		Check	Step
V	H	(Oscilloscope)	<ol style="list-style-type: none"> <li>1. Push <b>   PAUSE</b>. (Displays track number <b>03</b>)</li> <li>2. Check HF level of oscilloscope.</li> <li>3. Confirm that the waveform is in good shape. (◇ pattern in center must be able to discriminate clearly.)</li> </ol>
50mv/div or 20mV/div	0.2μ/div or 0.5μ/div	$A = 1.36 \pm 0.2V_{p-p}$	
		<ul style="list-style-type: none"> <li>• Set input mode to ALTERNATE or CHOPPER.</li> </ul>	

## HEAT RUN MODE FUNCTION

### Heat Run Mode

#### 1) To activate

While hold pushing PAUSE (||), STOP (■), buttons simultaneously, turn the unit power on. The remote control sensor indicator will light to show that the unit is shifted in Heat Run mode.

Be sure to load the disc previously.

Press the disc holder open/close button (▲ OPEN/CLOSE) to cancel Heat Run mode.

★ This mode functions only for a disc with 21 pieces of music or more. For a disc with 20 pieces of music or lesser, please do not use.

#### 2) Operation

During the Heat Run mode to shift the unit in Play mode makes the unit replays from the first music after opens the loader once and re-closes it when finish playing the last track (comes into lead out).

Hereafter, operates open/close of loader, servo on, reading of TOC, and playing repeatedly, and repeats playing the two tracks; the first and the last ones.

#### 3) Error Message

When the system error occurs while in Heat Run mode, the following error message will display on the Track No. indicator and stops operation.

1. E1

At the time of Focus Servo does not activate.

2. E2

When unable to detect synchronous pattern however the disc is in rotating. (GFS does not drive.)

3. E3

No synchronous pattern can be detected while in Play mode. (No GFS drives.)

4. E4

When TOC is unreadable in despite of servo is activated.

5. E5

In case of loader malfunctions. (Unable to turn on the switch.)

6. E6

The inner circle switch of Pick-up does not turn off.

7. E7

The inner circle switch of Pick-up does not turn on.

8. E10

Improper function of Pick-up base UP/ DOWN.

9. E11

Improper function of disc Select.

★ The number of operation up to the stop will be displayed on the minute and second portion of the indicator.

#### (Note)

##### Initializing of IC703 (NM24C08)

\* In case initializing is necessary due to replacement of IC703, initialize IC703 following to the undermentioned procedure.

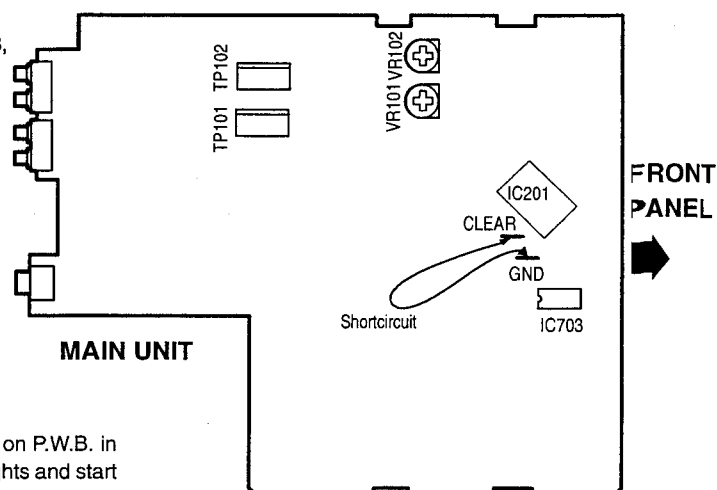

When momentary shortcircuit "CLEAR" and "GND" of Jumper on P.W.B. in state of stop position, PLAY (▶) and PAUSE (||) indicator lights and start writing in, when PLAY (▶) and PAUSE (||) indicators are put out after few seconds, the initializing of IC703 is completed.

# SEMICONDUCTORS

## ● IC's CXD2500BQ

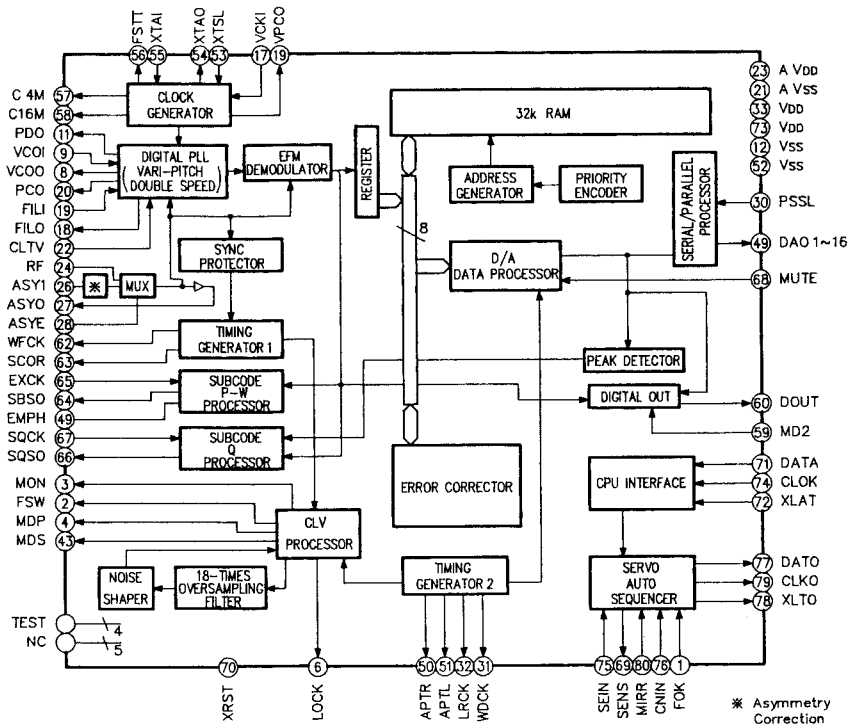
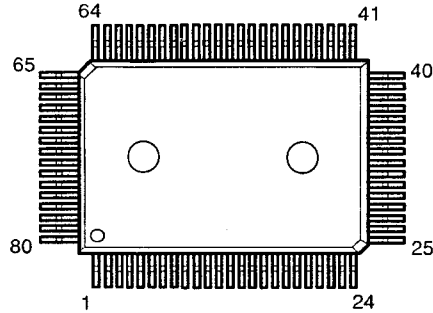

### CXD2500BQ Terminal Function

Terminal No.	Symbol	I/O	Terminal Function
1	FOK	I	Input terminal for OK focusing. Use for Servo-autosequencer.
2	FSW	O	Z,0 Output to shift time constant of output filter for spindle motor.
3	MON	O	1,0 ON/OFF control output for spindle motor.
4	MDP	O	1,Z,0 Servo control for spindle motor.
5	MDS	O	1,Z,0 Servo control for spindle motor.
6	LOCK	O	1,0 Sampling GFS by 460 Hz and if it is "H", delivers "H" ; if it is continuously "L" 8 times, delivers "L".
7	NC	—	
8	VCOO	O	1,0 Oscillation current output for analog EFM PLL.
9	VCOI	I	Oscillation current output for analog EFM PLL. f LOCK=8.6436MHz.
10	TEST	I	TEST output. Normally GND.
11	PDO	O	1,Z,0 Charge pump output for analog EFM PLL.
12	Vss		GND.
13	NC	—	
14	NC	—	
15	NC	—	
16	VPCO	O	1,Z,0 Charge pump output for variable pitch PLL.
17	VCKI	I	Clock input from external VCO for variable pitch. fc center=16.9344MHz.
18	FILO	O	Analog Filter output for master PLL. (slave=digital PLL)
19	FILI	I	Filter input for master PLL.
20	PCO	O	1,Z,0 Charge pump output for master PLL.
21	AVss		Analog GND.
22	CLTV	I	Control voltage input for master VCO.
23	AVDd		Analog power supply (+5V).
24	RF	I	EFM signal input.
25	BIAS	I	Constant-current input for Asymmetry circuit.
26	ASYI	I	Comparator voltage input for Asymmetry.
27	ASYO	O	1,0 Full swing output for EFM. (L=Vss, H=VDD).
28	ASYE	I	L: Asymmetry circuit → OFF. H: Asymmetry circuit → ON.
29	NC	—	
30	PSSL	I	Input to shift output mode of audio data. Serial output at L; parallel output at H.

Terminal No.	Symbol	I/O		Terminal Function
31	WDCK	O	1,0	D/A Interface for 48 bit slot. Word-clock $f=2 F_s$ .
32	LRCK	O	1,0	D/A Interface for 48 bit slot. LR-clock $f= F_s$ .
33	V <sub>DD</sub>			Power supply (+5V).
34	DA16	O	1,0	At PSSL=1 for DA16 (MBS) output; PSSL=0 for serial data of 48 bit slot. (2s'COMP, MSB first).
35	DA15	O	1,0	At PSSL=1 for DA15 output; PSSL=0 for bit clock of 48 bit slot.
36	DA14	O	1,0	At PSSL=1 for DA14 output; PSSL=0 for serial data of 64 bit slot. (2s'COMP, LSB first).
37	DA13	O	1,0	At PSSL=1 for DA13 output; PSSL=0 for bit clock of 64 bit slot.
38	DA12	O	1,0	At PSSL=1 for DA12 output; PSSL=0 for LR clock of 64 bit slot.
39	DA11	O	1,0	At PSSL=1 for DA11 output; PSSL=0 for G <sub>TOP</sub> output.
40	DA10	O	1,0	At PSSL=1 for DA10 output; PSSL=0 for XUGF output.
41	DA09	O	1,0	At PSSL=1 for DA09 output; PSSL=0 for XPLCK output.
42	DA08	O	1,0	At PSSL=1 for DA08 output; PSSL=0 for GFS output.
43	DA07	O	1,0	At PSSL=1 for DA07 output; PSSL=0 for RFCK output.
44	DA06	O	1,0	At PSSL=1 for DA06 output; PSSL=0 for C2PO output.
45	DA05	O	1,0	At PSSL=1 for DA05 output; PSSL=0 for XRAOF output.
46	DA04	O	1,0	At PSSL=1 for DA04 output; PSSL=0 for MNT3 output.
47	DA03	O	1,0	At PSSL=1 for DA03 output; PSSL=0 for MNT2 output.
48	DA02	O	1,0	At PSSL=1 for DA02 output; PSSL=0 for MNT1 output.
49	DA01	O	1,0	At PSSL=1 for DA01 output; PSSL=0 for MNT0 output.
50	APTR	O	1,0	Control output for aperture compensation. In H for R-ch.
51	APTL	O	1,0	Control output for aperture compensation. In H for L-ch.
52	V <sub>SS</sub>			GND.
53	X <sub>TAL</sub>	I		X'tal oscillation circuit input. By selecting of mode, $f=16.9344\text{MHz}$ or $33.8688\text{MHz}$ .
54	X <sub>TAO</sub>	O	1,0	X'tal oscillation circuit input. $f=16.9344\text{MHz}$ .
55	X <sub>TSL</sub>	I		Selection input terminal of X'tal. "L" for X'tal $16.9344\text{MHz}$ ; "H" for $33.8688\text{MHz}$ .
56	FSTT	O	1,0	2/3 Dividing output of 53 and 54 terminal. No change by variable pitch.
57	C4M	O	1,0	4.2336MHz output. When variable pitched, simultaneously changes.
58	C16M	O	1,0	16.9344MHz output. When variable pitched, simultaneously changes.
59	MD2	I		Digital-out ON/OFF control. ON at H; OFF at L.
60	DOUT	O	1,0	Digital-out output terminal.
61	EMPH	O	1,0	When playback disc emphasized, outputs H; otherwise outputs L.
62	WFCK	O	1,0	WFCK ( Write Flame Clock) output.
63	SCOR	O	1,0	Output of subcode sync. S0+S1. H output when either one detected.
64	SBSO	O	1,0	Serial output of Sub P-W.
65	EXCK	I		Clock input for SBSO read-out.
66	SQSO	O	1,0	Output for Sub Q 80 bits and PCM peak level 16 bits.
67	SQCK	I		Clock input for SQSO read-out.
68	MUTE	I		Mute at H; remove mute at L.
69	SENS	—	1,Z,0	SENS output. Outputs to CPU.
70	XRST	I		System reset input. Resets at "L".
71	DATA	I		Input of serial data from CPU.
72	XLAT	I		Input for latch from CPU. Latches serial data at release.
73	V <sub>DD</sub>			Power supply (+5V).
74	CLOCK	I		Serial data transfer clock input from CPU.
75	SEIN	I		SENS input from SSP.
76	CNIN	I		Input of tracking pulse.
77	DATO	O	1,0	Serial data output to SSP.
78	XLTO	O	1,0	Serial data latch output to SSP.
79	CLKO	O	1,0	Serial data transfer clock output to SSP.
80	MIRR	I		Mirror signal input. Use for track jump for over 128 tracks, using autosequencer.

CXA1372S

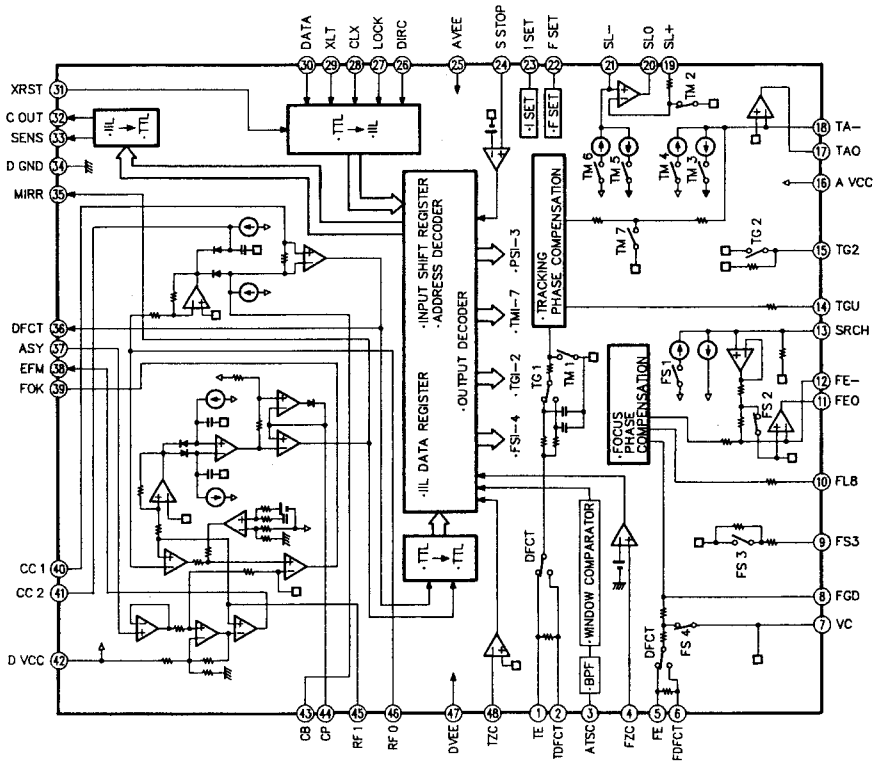
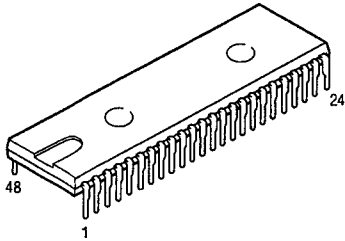

CXA1372S Terminal Function

Terminal No.	Symbol	I/O	Terminal Function
1	TE	I	Tracking error signal input terminal.
2	TDFCT	I	Capacitor connecting terminal for time constant at the time of defect.
3	ATSC	I	Input terminal of ATSC detecting window comparator.
4	FZC	I	Input terminal of focus zero-cross comparator.
5	FE	I	Focus error signal input terminal.
6	FDFCT	I	Capacitor connecting terminal for time constant at the time of defect.
7	Vc	I	Mid-point voltage input terminal.
8	FGD	I	In case of reducing higher range gain of focus servo, connect a capacitor between this terminal and terminal number (9).
9	FS3	I	Shifts higher range gain of focus servo by FS3 ON/OFF.
10	FLB	I	Terminal for external time constant to increase lower range of focus servo.
11	FEO	O	Focus drive output.
12	FE-	I	Reverse input terminal for focus amplifier.
13	SRCH	I	Terminal for external time constant to make focus search waveform.
14	TGU	I	Terminal for external time constant to shift higher range gain of tracking.
15	TG2	I	Terminal for external time constant to shift higher range gain of tracking.
17	TAO	O	Tracking drive output.
18	TA-	I	Reverse input terminal for tracking amplifier.
19	SL+	I	Non-reverse input terminal for sled amplifier.
20	SLO	O	Sled drive output.
21	SL-	I	Reverse input terminal for sled amplifier.
22	FSET	I	Terminal to compensate peak in focus/tracking phase.
23	ISET	I	Delivers a current to set the height of focus search, track jump, and sled kick.
24	SSTOP	I	Terminal for limit switch ON/OFF to detect disc innermost circle.
26	DIRC	I	Terminal is used at the time of 1 track jump. A 47 kohm pull up resistor is included.
27	LOCK	I	Reckless drive protection circuit of sled; activates at "L". A 47k ohm pull up resistor is included.
28	CLK	I	Serial data transfer clock input from CPU.
29	XLT	I	Latch input from CPU.
30	DATA	I	Serial data input from CPU.

Terminal No.	Symbol	I/O	Terminal Function
31	XRST	I	Reset input terminal. Resets at "L".
32	C.OUT	O	Terminal to output signal for track number count.
33	SENS	O	Terminal to output FZC, AS, TZC, SSTOP by command from CPU.
35	MIRR	O	Output terminal for MIRR comparator.
36	DFCT	O	Output terminal for DEFECT comparator.
37	ASY	I	Input terminal for auto-symmetric control.
38	EFM	O	Output terminal for EFM comparator.
39	FOK	O	Output terminal for focus OK (FOK) comparator.
40	CC1	O	DEFECT bottom hold output terminal.
41	CC2	I	Input terminal to input DEFECT bottom hold output by capacitance combination.
43	CB	I	Capacitor connecting terminal for DEFECT bottom hold.
44	CP	I	MIRR hold capacitor connecting terminal. A non-reverse input terminal for MIRR comparator.
45	RFI	I	Input terminal to input RF summing amplifier output by capacitance combination.
46	RFO	O	Output terminal for RF summing amplifier. Check point for eye pattern.
48	TZC	I	Tracking zero-cross comparator input terminal.

UPD78043GF-098-3B9

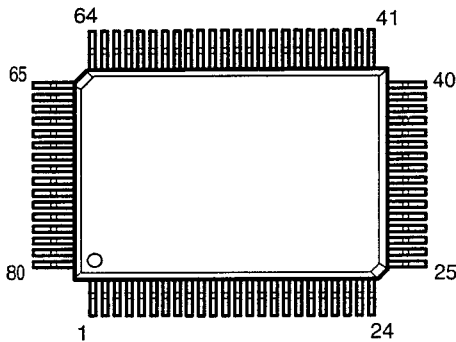

TC74HCU04AP

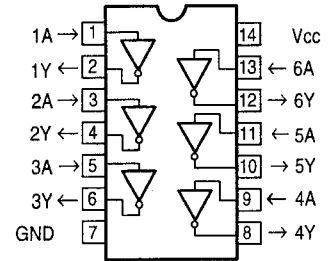
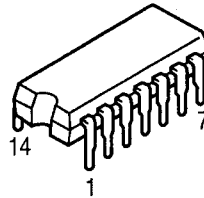

NJM2068DDC (IC201)  
NJM4558 (IC901)

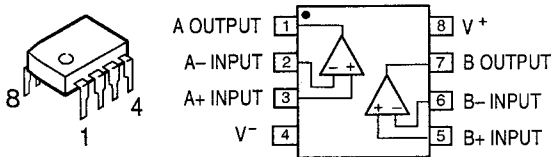

M5290P  
PCM-61P  
PCM-1702

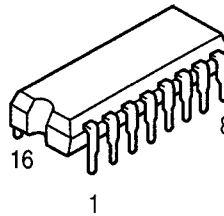

SM5841BP  
MN6632A

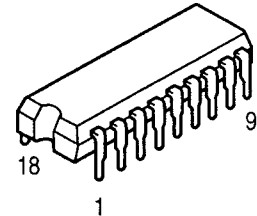

NM24C08N

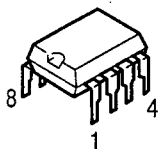

● IC PROTECTOR

ICP-N15

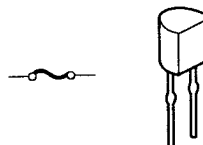

● TRANSISTORS

DTC124XS (22k-47k)  
 DTC-114ES (10k-10k)  
 DTC-144ES (47k-47k)

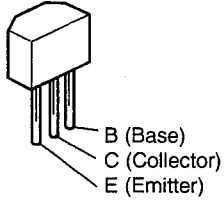

DTC124XS (22k-47k)

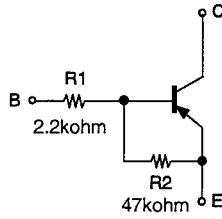

DTC-114ES (10k-10k)  
 DTC-144ES (47k-47k)

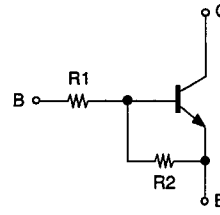

	R1	R2
DTC-114ES	10kohm	10kohm
DTC-144ES	47kohm	47kohm

2SD1274  
 2SD1913

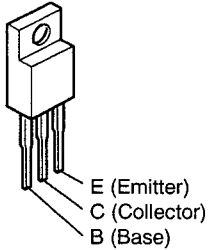

2SB562 (C)  
 2SD468 (C)

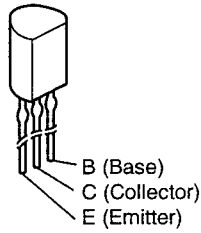

2SA933 (S)  
 2SD2144

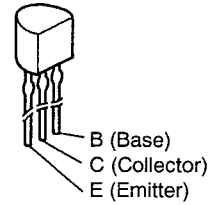

● DIODES

1S2076A  
 1SS270A

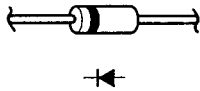

1A3-I

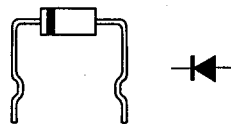

HZS7B-1  
 HZS30-1

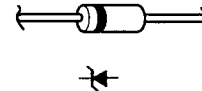



**NOTE FOR PARTS LIST**

- Part indicated with the mark "◎" are not always in stock and possibly to take a long period of time for supplying, or in some case supplying of part may be refused.
- When ordering of part, clearly indicate "1" and "I" (i) to avoid mis-supplying.
- Ordering part without stating its part number can not be supplied.
- Part indicated with the mark "★" is not illustrated in the exploded view.
- Not including Carbon Film ±5%, 1/4W Type in the P.W.Board parts list. (Refer to the Schematic Diagram for those parts.)

**WARNING:**

Parts marked with this symbol  have critical characteristics. Use ONLY replacement parts recommended by the manufacturer.

● **Resistors**

Ex.: RN 14K 2E 182 G FR

Type Shape and performance Power Resistance Allowable error Others

RD : Carbon	2B : 1/8W	F : ±1%	P : Pulse-resistant type
RC : Composition	2E : 1/4W	G : ±2%	NL : Low noise type
RS : Metal oxide film	2H : 1/2W	J : ±5%	NB : Non-burning type
RW : Winding	3A : 1W	K : ±10%	FR : Fuse-resistor
RN : Metal film	3D : 2W	M : ±20%	F : Lead wire forming
RK : Metal mixture	3F : 3W		
	3H : 5W		

\* **Resistance**

1 8 2 ⇒ 1800 ohm = 1.8 kohm  
 Indicates number of zeros after effective number.  
 2-digit effective number.

• Units: ohm

1 R 2 ⇒ 1.2 ohm  
 1-digit effective number.  
 2-digit effective number, decimal point indicated by R.

• Units: ohm

● **Capacitors**

Ex.: CE 04W 1H 2R2 M BP

Type Shape and performance Dielectric strength Capacity Allowable error Others

CE : Aluminum foil electrolytic	0J : 6.3V	F : ±1%	HS : High stability type
CA : Aluminum solid electrolytic	1A : 10V	G : ±2%	BP : Non-polar type
CS : Tantalum electrolytic	1C : 16V	J : ±5%	HR : Ripple-resistant type
CQ : Film	1E : 25V	K : ±10%	DL : For charge and discharge
CK : Ceramic	1V : 35V	M : ±20%	HF : For assuring high frequency
CC : Ceramic	1H : 50V	Z : +80%	U : UL part
CP : Oil	2A : 100V	-20%	C : CSA part
CM : Mica	2B : 125V	P : +100%	W : UL-CSA type
CF : Metallized	2C : 160V	-0%	F : Lead wire forming
CH : Metallized	2D : 200V	C : ±0.25pF	
	2E : 250V	D : ±0.5pF	
	2H : 500V	= : Others	
	2J : 630V		

\* **Capacity (electrolyte only)**

2 2 2 ⇒ 2200µF  
 Indicates number of zeros after effective number.  
 2-digit effective number.

• Units: µF.

2 R 2 ⇒ 2.2µF  
 1-digit effective number.  
 2-digit effective number, decimal point indicated by R.

• Units: µF.

\* **Capacity (except electrolyte)**

2 2 2 ⇒ 2200pF = 0.0022µF  
 (More than 2) — Indicates number of zeros after effective number.  
 2-digit effective number.

• Units: µF.

2 2 1 ⇒ 220pF  
 (0 or 1) — Indicates number of zeros after effective number.  
 2-digit effective number.

• Units: pF.

• When the dielectric strength is indicated in AC, "AC" is included after the dielectric strength value.

## PARTS LIST OF P.W. BOARD

### 1U-2787 MAIN UNIT (DCM-560)

Ref. No.	Part No.	Part Name	Remarks	Ref. No.	Part No.	Part Name	Remarks
<b>SEMICONDUCTORS GROUP</b>							
IC101	262 1305 001	IC CXA1372S		C107	256 1034 908	Metallized 0.027 $\mu$ F/50V	CF93A1H273JT
IC103-106	263 0565 007	IC BA15218		C108	255 1204 900	Film 0.0022 $\mu$ F/50V	CQ93M1H222JT
IC201	262 2068 004	Micro Computer UPD78043GF-098-3B9		C109-112	256 1034 979	Metallized 0.1 $\mu$ F/50V	CF93A1H104JT
IC202	262 1819 005	IC CXD2500BQ		C113	254 4337 910	Electrolytic 6.8 $\mu$ F/50V	CE04W1H6R8MT
IC203	262 1567 001	IC X24C08P		C114	256 1035 910	Metallized 0.22 $\mu$ F/50V	CF93A1H224JT
IC205	262 1265 002	IC TC74HCU04AP		C116	255 1212 905	Film 0.01 $\mu$ F/50V	CQ93M1H103JT
IC301	262 1869 000	IC SM5845AF		C117	253 9036 909	Ceramic 0.1 $\mu$ F/25V	CK45=1E104ZT
IC306,307	262 1837 016	IC PCM1702P-J		C118,119	253 1180 921	Ceramic 0.001 $\mu$ F/50V	CK45B1H102KT
IC308,309	262 0864 006	IC UPC4570C		C120,121	253 1181 904	Ceramic 0.01 $\mu$ F/50V	CK45B1H103ZT
IC501	263 0693 005	IC M5290P		C122,123	254 4260 919	Electrolytic 0.22 $\mu$ F/50V	CE04W1HR22MT
IC502-505	268 0073 905	IC Protector ICP-N15T		C124	255 1212 905	Film 0.01 $\mu$ F/50V	CQ93M1H103JT
TR101	272 0025 907	Transistor 2SB562(C)TF		C125	256 1034 911	Metallized 0.033 $\mu$ F/50V	CF93A1H333JT
TR102	274 0036 905	Transistor 2SD468(C)TF		C126	253 1212 905	Film 0.01 $\mu$ F/50V	CQ93M1H103JT
TR103	272 0025 907	Transistor 2SB562(C)TF		C127	255 1206 908	Film 0.0033 $\mu$ F/50V	CQ93M1H332JT
TR104	274 0036 905	Transistor 2SD468(C)TF		C128	255 1212 905	Film 0.01 $\mu$ F/50V	CQ93M1H103JT
TR105	272 0025 907	Transistor 2SB562(C)TF		C129	255 1208 906	Film 0.0047 $\mu$ F/50V	CQ93M1H472JT
TR106	274 0036 905	Transistor 2SD468(C)TF		C131	253 1209 905	Film 0.0056 $\mu$ F/50V	CQ93M1H562KT
TR107	272 0025 907	Transistor 2SB562(C)TF		C132	253 4538 910	Ceramic 75pF/50V	CC45SL1H750JT
TR108	274 0036 905	Transistor 2SD468(C)TF		C133	253 4536 909	Ceramic 10pF/50V	CC45SL1H100DT
TR127,128	274 0036 905	Transistor 2SD468(C)TF		C135	254 3055 918	Electrolytic 10 $\mu$ F/35V Bipolar	CE04D1V100MBPT
TR180	272 0025 907	Transistor 2SB562(C)TF		C136	253 4538 923	Ceramic 82pF/50V	CC45SL1H820JT
TR181	274 0136 009	Transistor 2SD1913		C138	253 9036 909	Ceramic 0.1 $\mu$ F/25V	CK45=1E104ZT
TR182	272 0025 907	Transistor 2SB562(C)TF		C139	253 4537 979	Ceramic 51pF/50V	CC45SL1H510JT
TR183	274 0036 905	Transistor 2SD468(C)TF		C142	253 4537 979	Ceramic 51pF/50V	CC45SL1H510JT
TR184	272 0025 907	Transistor 2SB562(C)TF		C148	253 9036 909	Ceramic 0.1 $\mu$ F/25V	CK45=1E104ZT
TR185	274 0036 905	Transistor 2SD468(C)TF		C126	253 1181 904	Ceramic 0.01 $\mu$ F/50V	CK45B1H103ZT
TR190	269 0040 902	Transistor DTC144ES(47K-47K)	Built in Resistor	C150	253 9036 909	Ceramic 0.1 $\mu$ F/25V	CK45=1E104ZT
TR191	278 0009 902	Transistor PT491F		C155	253 1181 904	Ceramic 0.01 $\mu$ F/50V	CK45F1H103ZT
TR201,202	269 0020 906	Transistor DTC114ES(10K-10K)	Built in Resistor	C170,171, 173	254 4254 938	Electrolytic 47 $\mu$ F/16V	CE04W1C470MT
TR501	274 0136 009	Transistor 2SD1913		C175	256 1034 979	Metallized 0.1 $\mu$ F/50V	CF93A1H104JT
TR502	272 0093 007	Transistor 2SB1274		C176	253 1181 904	Ceramic 0.01 $\mu$ F/50V	CK45B1H103ZT
TR503	271 0101 925	Transistor 2SA933(Q)T-70		C177	253 9036 909	Ceramic 0.1 $\mu$ F/25V	CK45=1E104ZT
TR702	269 0014 909	Transistor DTA124XS(22K-47K)	Built in Resistor	C180	253 4536 941	Ceramic 15pF/50V	CC45SL1H150JT
TR703	269 0020 906	Transistor DTC114ES(10K-10K)	Built in Resistor	C181	253 4538 910	Ceramic 75pF/50V	CC45SL1H750JT
TR704	271 0101 925	Transistor 2SA933(Q)T-70		C182	253 4536 941	Ceramic 15pF/50V	CC45SL1H150JT
TR706,707	274 0160 907	Transistor 2SD2144STPU		C201,202	253 9036 909	Ceramic 0.1 $\mu$ F/25V	CK45=1E104ZT
TR711	274 0036 905	Transistor 2SD468(C)TF		C203	253 1181 904	Ceramic 0.01 $\mu$ F/50V	CK45B1H103ZT
TR712	272 0025 907	Transistor 2SB562(C)TF		C204	253 9036 909	Ceramic 0.1 $\mu$ F/25V	CK45=1E104ZT
D101	278 0010 004	LED(infrared rays) GL450		C210	256 1034 937	Metallized 0.047 $\mu$ F/50V	CF93A1H473JT
D201,202	276 0462 902	Zener Diode HZS6B-1TD		C211	253 1180 947	Ceramic 0.0015 $\mu$ F/50V	CK45B1H152KT
D501-506	276 0613 900	Diode 1A3-I		C212	253 9036 909	Ceramic 0.1 $\mu$ F/25V	CK45=1E104ZT
D507	276 0483 907	Zener Diode HZS30-1TD		C223,224	253 4535 955	Ceramic 5pF/50V	CC45SL1H050CT
D508	276 0465 909	Zener Diode HZS7B-1TD		C253	254 4254 954	Electrolytic 220 $\mu$ F/16V	CE04W1C221MT
D509,510	276 0613 900	Diode 1A3-I		C301	253 9036 909	Ceramic 0.1 $\mu$ F/25V	CK45=1E104ZT
D701	276 0432 903	Diode 1SS270A TE		C304,305	253 1179 958	Ceramic 270pF/50V	CK45B1H271KT
<b>RESISTORS GROUP (not included Carbon Film <math>\pm</math>5% 1/4W type)</b>				C306,307	253 4538 949	Ceramic 100pF/50V	CC45SL1H101JT
VR101,102	211 6064 093	Adjust 22kohm	V06PB223	C308,309	255 4232 937	Film 0.001 $\mu$ F/100V	CQ93P2A102KT
VR302,303	211 6064 022	Adjust 100kohm	V06PB104	C310,311	255 4292 979	Film 200pF/100V	CQ93P2A201JT
<b>CAPACITORS GROUP</b>				C312-315	254 4260 980	Electrolytic 10 $\mu$ F/50V	CE04W1H100MT
C096,097	254 4260 935	Electrolytic 0.47 $\mu$ F/50V	CE04W1HR47MT	C316,317	235 0049 900	Electrolytic 10 $\mu$ F/50V(ARA)	CE04W1H100MT
C098,099	254 4260 993	Electrolytic 22 $\mu$ F/50V	CE04W1H220MT	C318,319	254 4260 980	Electrolytic 10 $\mu$ F/50V	CE04W1H100MT
C103	255 1206 908	Film 0.0033 $\mu$ F/50V	CQ93M1H332JT	C320-325	235 0049 900	Electrolytic 10 $\mu$ F/50V(ARA)	CE04W1H100MT
C104	253 1179 990	Ceramic 560pF/50V	CK45B1H561KT	C501	254 4254 792	Electrolytic 2200 $\mu$ F/16V	CE04W1C222MC
				C502	254 4255 717	Electrolytic 4700 $\mu$ F/16V	CE04W1C472MC
				C503,504	254 4254 954	Electrolytic 220 $\mu$ F/16V	CE04W1C221MT
				C505	254 4260 964	Electrolytic 3.3 $\mu$ F/50V	CE04W1H3R3MT
				C507	254 4262 946	Electrolytic 47 $\mu$ F/63V	CE04W1J470MT
				C508	254 4261 921	Electrolytic 100 $\mu$ F/50V	CE04W1H101MT

1U-2785 MAIN UNIT (DCM-460)

Ref. No.	Part No.	Part Name	Remarks
C509,510	254 4261 905	Electrolytic 33μF/50V	CE04W1H330MT
C511	254 4260 964	Electrolytic 3.3μF/50V	CE04W1H3R3MT
C701	254 4260 948	Electrolytic 1μF/50V	CE04W1H010MT
C703	253 9036 909	Ceramic 0.1μF/25V	CK45=1E104ZT
C704	253 4538 949	Ceramic 100pF/50V	CC45SL1H101JT
C710-713	253 1180 921	Ceramic 0.001μF/50V	CK45B1H102KT
C716,717	254 4254 941	Electrolytic 100μF/16V	CE04W1C101MT
C722,723	254 4254 909	Electrolytic 10μF/16V	CE04W1C100MT
C730	253 9036 909	Ceramic 0.1μF/25V	CK45=1E104ZT
C731	254 4254 925	Electrolytic 33μF/16V	CE04W1C330MT
C732	253 4538 949	Ceramic 100pF/50V	CC45SL1H101JT
C733	253 9036 909	Ceramic 0.1μF/25V	CK45=1E104ZT
C734	254 4254 954	Electrolytic 220μF/16V	CE04W1C221MT
C736	253 9036 909	Ceramic 0.1μF/25V	CK45=1E104ZT
C910	254 3056 917	Electrolytic 1μF/50V Bipolar	CE04D1H010MBPT
C911	253 1180 921	Ceramic 0.001μF/50V	CK45B1H102KT

OTHER PARTS

X200	399 0036 013	Crystal Resonator (16.9344MHz)	
X201	399 0111 006	Ceramic Resonator (CST 4.23MGW040)	
PT700	231 8063 009	Pulse Trans	
JK701	204 8356 002	1P Pin Jack	
JK702,703	204 8373 014	2P Pin Jack	
JK704	204 8416 007	Mini Jack	
L701,702,704-707	235 0049 900	Beads Inductor	
SW100,191	212 1072 009	Detect Switch (SSCF21)	
CB101	205 0683 006	FFC Conn.Base (12P)	
CB102	205 0343 058	5P Conn. Base(KR-PH)	
CB103	205 0406 063	6P Conn. Base(KR-PH)	
CB104	205 0543 036	3P Conn Base (YEL)	
CB105	205 0406 034	3P Conn. Base(KR-PH)	
CB106	205 0343 032	3P Conn. Base(KR-PH)	
CB107	205 0321 038	3P Conn.Base (RED)	
CB108	205 0323 036	3P Conn.Base (BLK)	
CB201	205 0491 010	31P FFC Conn.Base	
CB500	205 0581 001	2P VH Conn. Base	
CB501	205 0343 061	6P Conn. Base(KR-PH)	
CB701	205 0375 000	10P Conn. Base(KR-PH)	
CN106	203 4805 033	3P PH-SAN Conn. Cord	
CN107	203 4805 020	3P PH-SAN Conn. Cord	
CN108	203 4810 002	3P PH-SAN Conn. Cord	
CN501	204 0371 001	6P KR-DA Conn. Cord	
TP101,102	205 0190 065	6P NH Conn. Base	
△	233 5941 010	Power Transformer	U.S.A. Canada
△	233 5993 000	Power Transformer	Europe
△	233 6061 006	Power Transformer	Multi Voltage
△	212 4698 008	Voltage Selector(E)	Multi Voltage Models Only

Ref. No.	Part No.	Part Name	Remarks
<b>SEMICONDUCTORS GROUP</b>			
IC101	262 1305 001	IC CXA1372S	
IC103-106	263 0081 002	IC NJM4558D	
IC201	262 2068 004	Micro Computer UPD78043GF-098-3B9	
IC202	262 1819 005	IC CXD2500BQ	
IC205	262 1265 002	IC TC74HC004AP	
IC300	262 1869 000	IC SM5845AF	
IC302	262 1409 004	IC PCM61P-L	
IC501	263 0693 005	IC M5290P	
IC502,503	268 0073 905	IC Protector ICP-N15T	
IC703	262 1806 005	IC NM24C08N	
IC705	263 0081 002	IC NJM4558D	
IC706,707	263 0565 007	IC BA15218	
TR101	272 0025 907	Transistor 2SB562(C)TF	
TR102	274 0036 905	Transistor 2SD468(C)TF	
TR103	272 0025 907	Transistor 2SB562(C)TF	
TR104	274 0036 905	Transistor 2SD468(C)TF	
TR105	272 0025 907	Transistor 2SB562(C)TF	
TR106	274 0036 905	Transistor 2SD468(C)TF	
TR107	272 0025 907	Transistor 2SB562(C)TF	
TR108	274 0036 905	Transistor 2SD468(C)TF	
TR127,128	274 0036 905	Transistor 2SD468(C)TF	
TR180	272 0025 907	Transistor 2SB562(C)TF	
TR181	274 0136 009	Transistor 2SD1913	
TR182	272 0025 907	Transistor 2SB562(C)TF	
TR183	274 0036 905	Transistor 2SD468(C)TF	
TR184	272 0025 907	Transistor 2SB562(C)TF	
TR185	274 0036 905	Transistor 2SD468(C)TF	
TR190	269 0040 902	Transistor DTC144ES(47K-47K)	Built in Resistor
TR191	269 0009 002	Transistor PT491F	
TR201,202	269 0020 906	Transistor DTC114ES(10K-10K)	Built in Resistor
TR501	274 0136 009	Transistor 2SD1913	
TR502	272 0093 007	Transistor 2SB1274	
TR503	271 0192 905	Transistor 2SA933S(S)TP	
TR702	269 0014 909	Transistor DTA124XS(22K-47K)	Built in Resistor
TR703	269 0020 906	Transistor DTC114ES(10K-10K)	Built in Resistor
TR704	271 0192 905	Transistor 2SA933S(S)TP	
TR706-709	274 0160 907	Transistor 2SD2144STPU	
D101	278 0010 004	LED(infrared rays) GL450	
D102	276 0503 900	Diode 1SS198TE	
D201,202	276 0462 902	Zener Diode HZS6B-1TD	
D501-506	276 0613 900	Diode 1A3-I	
D507	276 0483 907	Zener Diode HZS30-1TD	
D508	276 0465 909	Zener Diode HZS7B-1TD	
D701	276 0432 903	Diode 1SS270A TE	
<b>RESISTORS GROUP (not included Carbon Film ±5% 1/4W type)</b>			
VR101,102	211 6064 093	Adjust 22kohm	V06PB2/3
VR300,301	211 6064 022	Adjust 100kohm	V06PB1/4
<b>CAPACITORS GROUP</b>			
C096,097	254 4260 935	Electrolytic 0.47μF/50V	CE04W1H R47MT
C098,099	254 4260 993	Electrolytic 22μF/50V	CE04W1H 220MT
C103	255 1206 908	Film 0.0033μF/50V	CQ93M1H 332JT

Ref. No.	Part No.	Part Name	Remarks	Ref. No.	Part No.	Part Name	Remarks
C104	253 1179 990	Ceramic 560pF/50V	CK45B1H561KT	C704	254 4254 954	Electrolytic 220µF/16V	CE04W1C221MT
C107	255 1217 900	Film 0.027µF/50V	CQ93M1H273JT	C706	253 4537 924	Ceramic 33pF/50V	CC45SL1H330JT
C108	255 1204 900	Film 0.0022µF/50V	CQ93M1H222JT	C709	253 4537 924	Ceramic 33pF/50V	CC45SL1H330JT
C109~112	256 1034 979	Metallized 0.1µF/50V	CF93A1H104JT	C710~715	254 4254 909	Electrolytic 10µF/16V	CE04W1C100MT
C113	254 4337 910	Electrolytic 6.8µF/50V	CE04W1H6R8MT	C720,721	254 4254 909	Electrolytic 10µF/16V	CE04W1C100MT
C114	256 1035 910	Metallized 0.22µF/50V	CF93A1H224JT	C730	253 9036 909	Ceramic 0.1µF/25V	CK45=1E104ZT
C115	253 9036 909	Ceramic 0.1µF/25V	CK45=1E104ZT	C731	254 4254 925	Electrolytic 33µF/16V	CE04W1C330MT
C116	255 1212 905	Film 0.01µF/50V	CQ93M1H103JT	C732	253 4538 949	Ceramic 100pF/50V	CC45SL1H101JT
C117	253 9036 909	Ceramic 0.1µF/25V	CK45=1E104ZT	C733	253 1181 904	Ceramic 0.01µF/50V	CK45B1H103ZT
C118,119	253 1180 921	Ceramic 0.001µF/50V	CK45B1H102KT	C900	253 9036 909	Ceramic 0.1µF/25V	CK45=1E104ZT
C120,121	253 1181 904	Ceramic 0.01µF/50V	CK45B1H103ZT	C910	254 3056 917	Electrolytic 1µF/50V Bipolar	CE04D1H010MBPT
C122,123	254 4260 919	Electrolytic 0.22µF/50V	CE04W1HR22MT	C911	253 1180 921	Ceramic 0.001µF/50V	CK45B1H102ZT
C124	255 1212 905	Film 0.01µF/50V	CQ93M1H103JT	C996~999	253 1180 921	Ceramic 0.001µF/50V	CK45B1H102KT
C125	256 1034 911	Metallized 0.033µF/50V	CF93A1H333JT	<b>OTHER PARTS</b>			
C126	255 1212 905	Film 0.01µF/50V	CQ93M1H103JT	X200	399 0036 013	Crystal Resonator(16.9344MHz)	
C127	255 1206 908	Film 0.0033µF/50V	CQ93M1H332JT	X201	399 0111 006	Ceramic Resonator (CST4.23MGW040)	
C128	255 1212 905	Film 0.01µF/50V	CQ93M1H103JT	L701,702	235 0049 900	Beads Inductor	
C129	255 1208 906	Film 0.0047µF/50V	CQ93M1H472JT	L704~707	235 0049 900	Beads Inductor	
C131	255 1209 905	Film 0.0056µF/50V	CQ93M1H562JT	PT700	231 8063 009	Pulse Trans	
C132	253 4538 910	Ceramic 75pF/50V	CC45SL1H750JT	JK701	204 8356 002	1P Pin Jack	
C133	253 4536 909	Ceramic 10pF/50V	CC45SL1H100DT	JK702,703	204 8373 001	2P Pin Jack	
C134	253 4538 923	Ceramic 82pF/50V	CC45SL1H820JT	JK704	204 8416 007	Mini Jack	
C135	254 3055 918	Electrolytic 10µF/35V Bipolar	CE04D1V100MBPT	SW100,191	212 1072 009	Detect Switch (SSCF21)	
C138	253 9036 909	Ceramic 0.1µF/25V	CK45=1E104ZT	CB101	205 0683 006	FFC Conn. Base (12P)	
C139	253 4537 979	Ceramic 51pF/50V	CC45SL1H510JT	CB102	205 0343 058	5P Conn. Base(KR-PH)	
C142	253 4537 979	Ceramic 51pF/50V	CC45SL1H510JT	CB103	205 0406 063	6P Conn. Base(KR-PH)	
C170,171	254 4254 938	Electrolytic 47µF/16V	CE04W1C470MT	CB104	205 0543 036	3P Conn. Base (YEL)	
C173	254 4254 938	Electrolytic 47µF/16V	CE04W1C470MT	CB105	205 0406 034	3P Conn. Base(KR-PH)	
C175	256 1034 979	Metallized 0.1µF/50V	CF93A1H104JT	CB106	205 0343 032	3P Conn. Base(KR-PH)	
C176	253 1181 904	Ceramic 0.01µF/50V	CK45B1H103ZT	CB107	205 0321 038	3P Conn. Base (RED)	
C177	253 9036 909	Ceramic 0.1µF/25V	CK45=1E104ZT	CB108	205 0323 036	3P Conn. Base (BLK)	
C180	253 4536 941	Ceramic 15pF/50V	CC45SL1H150JT	CB200	205 0736 063	35P FFC Conn. Base	
C181	253 4538 910	Ceramic 75pF/50V	CC45SL1H750JT	CB500	205 0581 001	2P VH Conn. Base	
C182	253 4536 941	Ceramic 15pF/50V	CC45SL1H150JT	CB501	205 0343 061	6P Conn. Base(KR-PH)	
C201	253 9036 909	Ceramic 0.1µF/25V	CK45=1E104ZT	CN106	203 4805 033	3P PH-SAN Conn. Cord	
C202,203	253 1181 904	Ceramic 0.01µF/50V	CK45B1H103ZT	CN107	203 4805 020	3P PH-SAN Conn. Cord	
C204	253 9036 909	Ceramic 0.1µF/25V	CK45=1E104ZT	CN108	203 4810 002	3P PH-SAN Conn. Cord	
C210	256 1034 937	Metallized 0.047µF/50V	CF93A1H473JT	CN501	204 0371 001	6P KR-DA Conn. Cord	
C211	253 1180 947	Ceramic 0.0015µF/50V	CK45B1H152KT	TP101,102	205 0190 065	6P NH Conn. Base	
C212	253 9036 909	Ceramic 0.1µF/25V	CK45=1E104ZT	△	233 5941 010	Power Transformer	U.S.A. Canada
C223,224	253 4535 955	Ceramic 5pF/50V	CC45SL1H050CT	△	233 6063 007	Power Transformer	Europe
C230	253 9036 909	Ceramic 0.1µF/25V	CK45=1E104ZT	△	233 6061 009	Power Transformer	Multi. Voltage
C253	254 4254 954	Electrolytic 220µF/16V	CE04W1C221MT	△	212 4698 008	Voltage Selector(D)	Multi. Voltage Models Only
C300,301	254 4254 954	Electrolytic 220µF/16V	CE04W1C221MT				
C302	253 9036 909	Ceramic 0.1µF/25V	CK45=1E104ZT				
C304	253 9036 909	Ceramic 0.1µF/25V	CK45=1E104ZT				
C306,307	253 1180 905	Ceramic 680pF/50V	CK45B1H681KT				
C308,309	253 1121 906	Ceramic 0.0056µF/50V	CK45B1H562KT				
C312,355	253 1181 904	Ceramic 0.01µF/50V	CK45B1H103ZT				
C501	254 4254 792	Electrolytic 2200µF/16V	CE04W1C222MC				
C502	254 4255 717	Electrolytic 4700µF/16V	CE04W1C472MC				
C503	254 4254 954	Electrolytic 220µF/16V	CE04W1C221MT				
C504	254 4254 967	Electrolytic 330µF/16V	CE04W1C331MT				
C505	254 4260 964	Electrolytic 3.3µF/50V	CE04W1H3R3MT				
C507	254 4262 946	Electrolytic 47µF/63V	CE04W1J470MT				
C508	254 4261 921	Electrolytic 100µF/50V	CE04W1H101MT				
C509,510	254 4258 934	Electrolytic 33µF/35V	CE04W1V330MT				
C511	254 4260 964	Electrolytic 3.3µF/50V	CE04W1H3R3MT				

## 1U-2788 DISPLAY UNIT (DCM-560)

Ref. No.	Part No.	Part Name	Remarks
<b>SEMICONDUCTOR GROUP</b>			
IC705	263 0565 007	IC BA15218	
D102	278 0006 005	Photo Interrupter	
<b>CAPACITORS GROUP</b>			
C601-605	253 1180 921	Ceramic 0.001 $\mu$ F/50V	CK45F1H102ZT
C702,703	253 1181 904	Ceramic 0.01 $\mu$ F/50V	CK45F1H103ZT
C705,706	253 4538 907	Ceramic 68PF/50V	CC45SL1H680JT
C720,721	254 4254 941	Electrolytic 100 $\mu$ F/16V	CE04W1C101MT
<b>OTHER PARTS</b>			
SW600	212 1039 000	1P Push Switch	
SW601-626	212 4388 004	Light Touch Switch	
FL600	393 4132 009	FL Tube (FIP8RM6)	
RM601	499 0150 008	REMOTE SENSOR (SBX1610-52)	
JK601	204 8364 007	HEAD PHONE JACK	
CN200	205 0491 010	31P FFC Conn.Base	
CB111	205 0343 032	3P Conn. Base (KR-PH)	
CB115	205 0355 046	4P KR Conn.Base (L)	
CB605	205 0343 045	4P Conn. Base (KR-PH)	
CB702	205 0375 000	10P Conn. Base (KR-PH)	
	009 0073 005	31P FFC Cable	
	217 0172 002	Roulette Motor	

## 3U-2576 DISPLAY UNIT (DCM-460)

Ref. No.	Part No.	Part Name	Remarks
<b>SEMICONDUCTOR GROUP</b>			
TR600,601	274 0160 907	Transistor 2SD2144STPU	
D102	278 0006 005	Photo Interrupter	
<b>CAPACITORS GROUP</b>			
C601-605	253 1180 921	Ceramic 0.001 $\mu$ F/50V	CK45F1H102ZT
C606,607	253 1181 904	Ceramic 0.01 $\mu$ F/50V	CK45F1H103ZT
C608	253 9036 909	Ceramic 0.1 $\mu$ F/25V	CK45=1E104ZT
<b>OTHER PARTS</b>			
SW600	212 1039 000	1P Push Switch	
SW601-626	212 4388 004	Light Touch Switch	
FL600	393 4132 009	FL Tube (FIP8RM6)	
RM601	499 0150 008	REMOTE SENSOR (SBX1610-52)	
JK601	204 8364 007	HEAD PHONE JACK	
CN200	205 0736 063	35P FFC Conn.Base	
CB111	205 0343 032	3P Conn.Base (KR-PH)	
CB115	205 0355 046	4P KR Conn.Base (L)	
CB602	205 0343 074	7P Conn.Base (KR-PH)	
CB603	205 0355 075	7P KR Conn.Base (L)	
	009 0090 004	35P FFC Cable	
	217 0172 002	Roulette Motor	

**PARTS LIST OF MECHANISM UNIT (FG-40)**

Ref. No.	Part No.	Part Name	Remarks
1	9KA 85A0 03	SPINDLE MOTOR ASS'Y	
2	9KA 90H0 06	FEED SHAFT FIX SCREW	
3	9KA 90H0 05	FEED SHAFT	
7	9KA 85G0 17	GEAR (A)	
8	9KA 85G0 18	GEAR (B)	
9	9KA 85G0 16	FRAME	
10	9KA 85P0 04	P.W.B.	
11	9KA 85H0 01	SCREW F	
12	9KA 85G0 13	DAMPER F	
13	9KS 01W1 47	SWITCH	LSA-1121EAU
14	9KA 85A0 04	SLIDE MOTOR ASS'Y	
16	499 0191 009	LASER P.U	KSS-240A
17	009 0051 014	FFC	FFC-240
18	443 1093 006	FFC BUSH	
19	9KA 85G2 53	5P CONN.BASE	S5B-PH
20	9KM 20S0 03	M2 x 3 TAMS SCREW	
21	9KA 85A0 02	CLAMPER	
24	9KA 85S0 01	SPRING (A)	
25	9KA 85S0 02	SPRING (B)	
26	9KA 85S0 03	SPRING (C)	

### EXPLODED VIEW OF MECHANISM UNIT

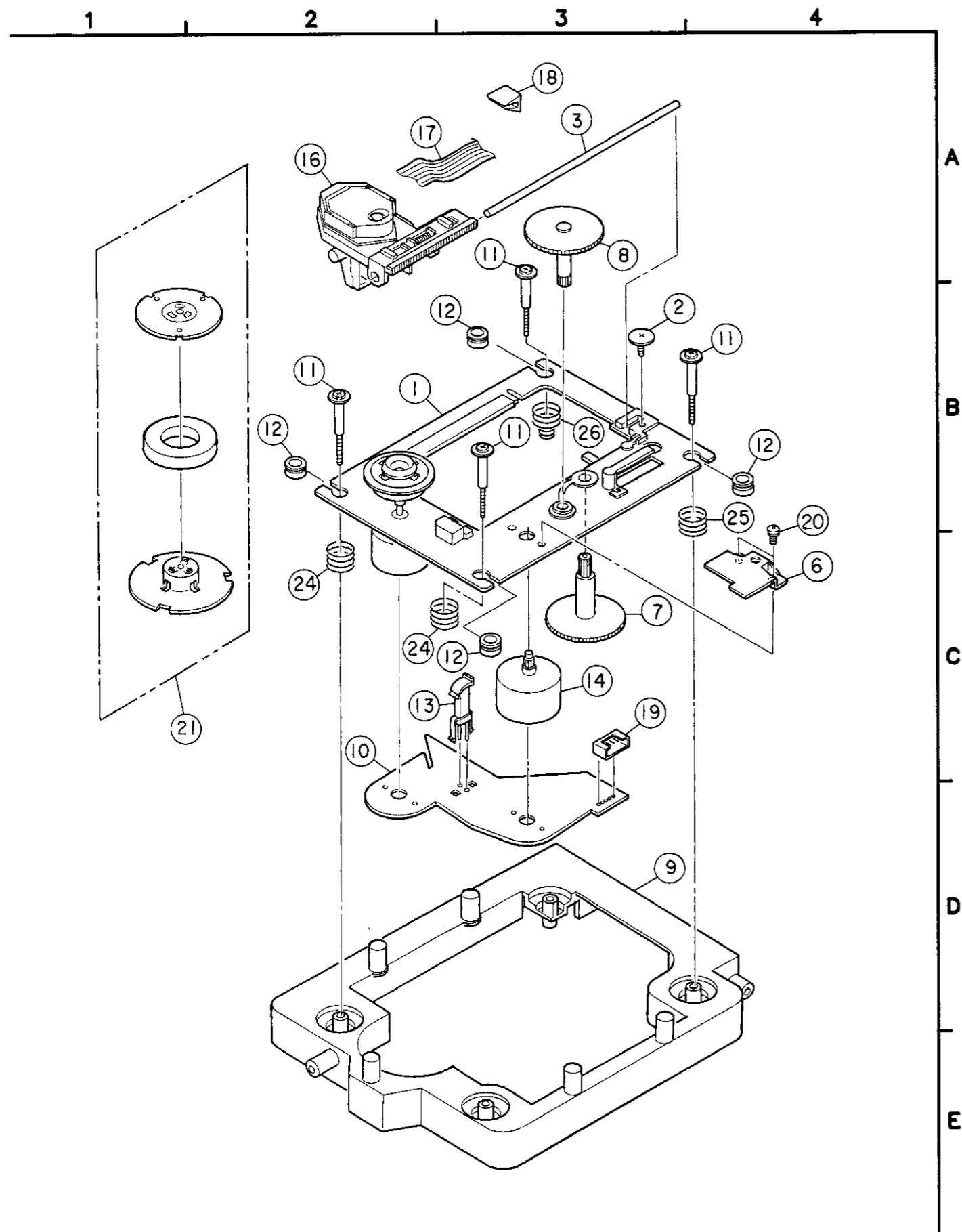

# EXPLODED VIEW (DCM-560)

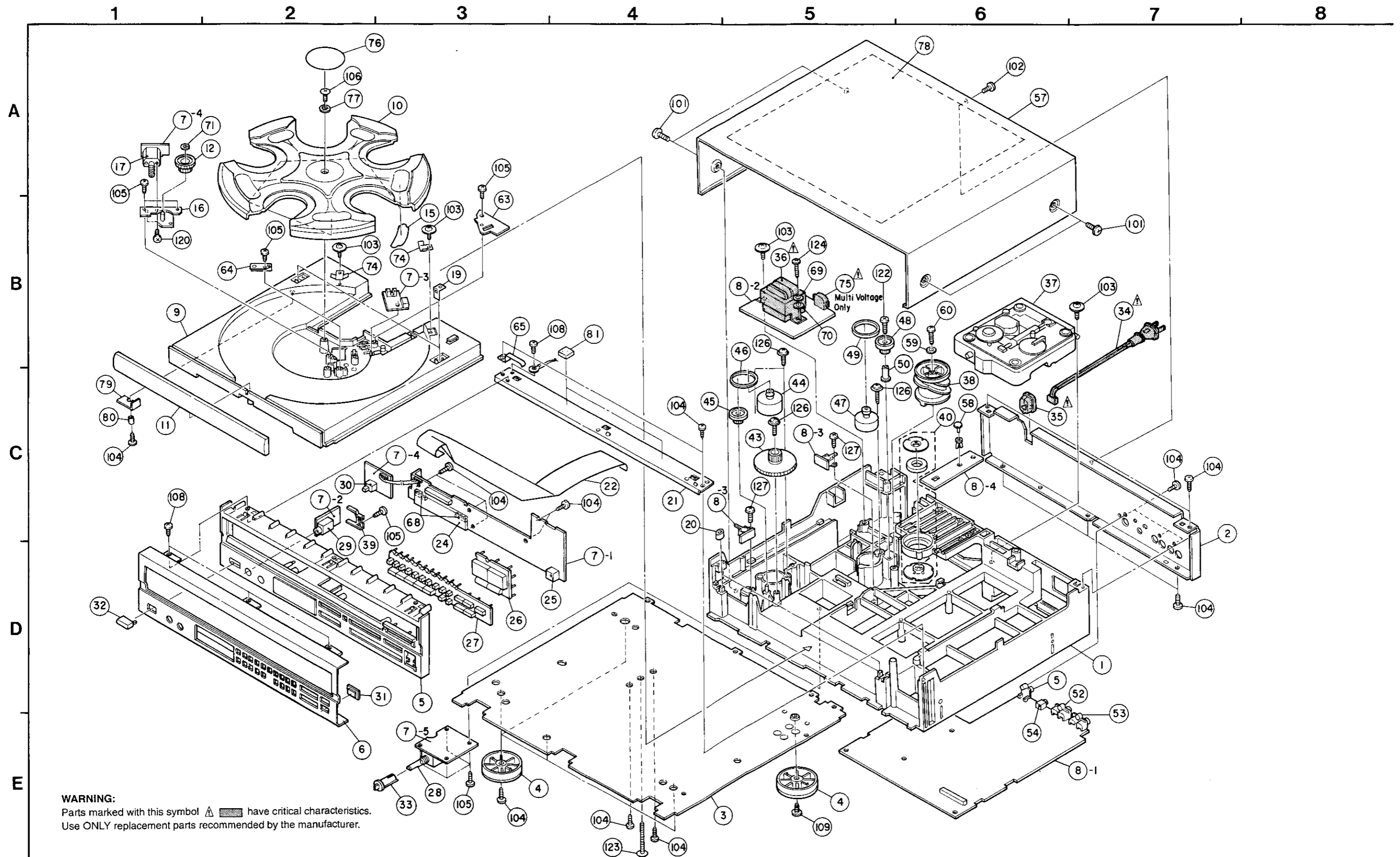



## PARTS LIST OF EXPLODED VIEW (DCM-560)

Ref. No.	Part No.	Part Name	Remarks
1	103 1608 001	MECHA. CHASSIS	
2	105 1094 035	REAR PANEL(E3)	U.S.A. Canada
2	105 1094 048	REAR PANEL(E2)	Europe
2	105 1094 051	REAR PANEL(E1)	Multi.Voltage
3	105 0989 510	BOTTOM COVER	
4	104 0208 201	FOOT ASS'Y	
5	105 1522 307	SUB FRONT PANEL ASS'Y	
6	144 2179 006	FRONT PANEL	
6	144 2179 116	FRONT PANEL	U.S.A.,Canada
7	1U-2788	DISPLAY UNIT ASS'Y	
7-1	—	DISPLAY UNIT	
7-2	—	HEAD PHONE UNIT	
7-3	—	ROULETTE SENSOR UNIT	
7-4	—	ROULETTE MOTOR UNIT	
7-5	—	VOLUME UNIT	
8	1U-2787	P.W.B. UNIT ASS'Y	U.S.A., Canada
8	1U-2787 B	P.W.B. UNIT ASS'Y	Europe
8	1U-2787 D	P.W.B. UNIT ASS'Y	Multi.Voltage
8-1	—	MAIN UNIT	
8-2	—	POWER TRANS. UNIT	
8-3	—	LOADING SW. UNIT	
8-4	—	DISC SENSOR UNIT	
9	431 0313 603	CLAMPING SW. UNIT	
10	421 0593 413	ROULETTE	
11	146 1297 008	LOADER PANEL	
12	424 0174 404	HELICAL GEAR	
15	461 0689 008	HIMERON SHEET	
16	412 3484 208	GEAR BRACKET ASS'Y	
17	GEN 1682	ROULETTE MOTOR SUB ASS'Y	
19	412 3350 109	LOADER BRACKET	
20	461 0659 009	LOADER STOPPER	
21	412 3348 205	FRONT BRACKET	
22	009 0063 002	31P FFC CABLE	
24	393 4132 009	FL TUBE (FIP 8RM6)	
25	499 0150 008	REMOTE SENSOR (SBX1610-52)	
26	113 1496 003	FUNCTION KNOB	
27	113 1497 015	SERIES KNOB	
28	211 0747 002	VARIABLE RESISTOR	
29	204 8341 004	HEAD PHONE JACK	
30	212 1039 000	1P PUSH SWITCH	
31	143 0504 007	REMOTE SENSOR WINDOW	
32	113 1357 207	POWER SWITCH KNOB	
33	112 0703 008	HEAD PHONE KNOB	
34	206 2110 004	AC CORD WITH CONNECTOR	U.S.A. Canada
34	206 2088 106	AC CORD WITH CONNECTOR	Europe
34	206 2088 000	AC CORD WITH CONNECTOR	Multi.Voltage
35	445 0056 008	CORD BUSH	
36	233 5941 010	POWER TRANSFORMER	U.S.A. Canada
36	233 6063 010	POWER TRANSFORMER	Europe
36	233 6061 012	POWER TRANSFORMER	Multi.Voltage
37	FG-40	CD MECHA. UNIT	
38	424 0172 202	CLAMPING CAM	
39	412 3371 007	SUPPORT BRACKET	
40	9KA 85A0 02	CLAMPER	
43	424 0173 104	LOADING GEAR	
44	GEN 1680	LOADING MOTOR SUB ASS'Y	
45	424 0130 011	PULLEY GEAR	
46	423 0061 006	BELT	
47	GEN 1678	CLAMP MOTOR SUB ASS'Y	
48	424 0130 008	PULLEY GEAR	
49	423 0061 006	BELT	
50	443 1161 006	COLLAR	
51	204 8356 002	1P PIN JACK	
52	204 8373 001	2P PIN JACK	
53	204 8373 001	2P PIN JACK	
54	204 8416 007	MINI JACK	
56	424 0093 226	WORM GEAR ASS'Y	
57	102 0479 102	TOP COVER	
58	477 0096 007	PUSH RIVET	
59	475 1005 017	4W WASHER	
60	473 7501 014	3x14 CBTS(P)-Z SCREW	
63	412 3499 002	BLIND PLATE	
64	461 0690 107	MOTOR SPRING	
65	412 3400 004	EARTH PLATE	
66	143 0568 001	FILTER	
68	461 0580 000	SPACER	
69	475 1106 042	WASHER	
70	475 3100 004	4TWA NI	
71	475 1157 017	SLIT WASHER T0.5	
74	441 1402 112	ROULETTE STOPPER	
75	212 4698 008	VOLTAGE SELECTOR	Multi.Voltage
76	125 0070 009	BLIND SHEET-V	
77	475 1160 004	WASHER	
78	441 1687 005	TOP PLATE	
79	412 3945 006	L. BRACKET	
80	443 1411 002	COLLAR	
81	461 0873 005	FRONT PAD	
101	473 7509 016	4x10 CBTS(P)-B SCREW	
102	473 7015 018	3x8 CBTS(S)-B SCREW	
103	477 0262 006	SPECIAL SCREW	
104	473 7508 017	3x10 CBTS(P)-B SCREW	
106	473 7512 016	3x12 CFTS(P)-B SCREW	
108	473 7002 021	3x8 CBTS(S)-B SCREW	
109	473 7002 018	3x8 CBTS(S)-Z SCREW	
120	471 8301 039	2x3 CBS-Z SCREW	
122	473 7508 059	3x20 CBTS(P)-B SCREW	
123	473 0840 064	3x30 CPTS(B)ZN	
124	473 7501 030	3x20 CBTS(P)-Z	

## WARNING :

Parts marked with "△" and/shading have special characteristics important to safety.

Be sure to use the specified parts for replacement.

Parts indicated with the mark "⊗" are not always in stock and possibly to take a long period of time for supplying, or in some case supplying of parts may be refused.

## PARTS LIST OF PACKING &amp; ACCESSORIES (DCM-560)

Ref. No.	Part No.	Part Name	Remarks	Q'ty
⊗	505 0102 089	Styrene Paper	For set	1
⊗	504 0092 060	Styrene Paper	For AC cord	1
⊗	503 1125 001	Cushion		2
⊗	501 1857 014	Carton Case		1
⊗	505 8006 019	Envelope		1
⊗	511 2703 003	Instruction Manual	U.S.A. Canada	1
⊗	511 2704 008	Instruction Manual	Europe	1
⊗	515 0690 006	DEL Warranty Home	U.S.A. Canada	1
	203 2360 004	2P Pin Cord		1
	499 0226 000	Remote Control Unit(RC-239)		1

EXPLODED VIEW (DCM-460)

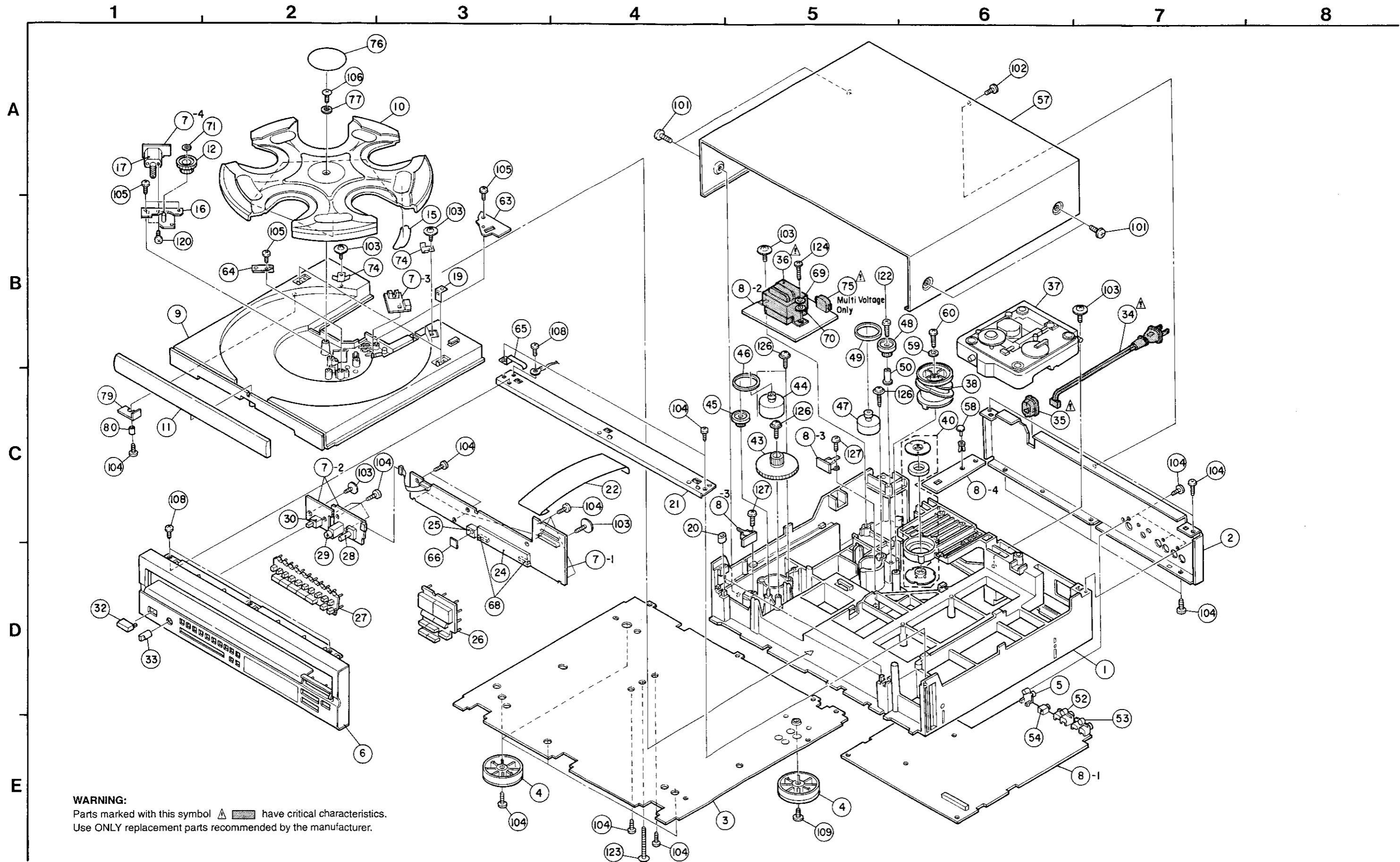

**WARNING:**  
 Parts marked with this symbol  have critical characteristics.  
 Use ONLY replacement parts recommended by the manufacturer.

## PARTS LIST OF EXPLODED VIEW (DCM-460)

Ref. No.	Part No.	Part Name	Remarks
1	103 1608 001	MECHA. CHASSIS	
2	105 1094 035	REAR PANEL(E3)	U.S.A. Canada
2	105 1094 048	REAR PANEL(E2)	Europe
2	105 1094 051	REAR PANEL(E1)	Multi.Voltage
3	105 0989 507	BOTTOM COVER	
4	104 0208 201	FOOT ASS'Y	
6	146 1445 245	FRONT PANEL ASS'Y	
7	3U- 2576	DISPLAY UNIT ASS'Y	
7-1	—	DISPLAY UNIT	
7-2	—	HEAD PHONE UNIT	
7-3	—	ROULETTE SENSOR UNIT	
7-4	—	ROULETTE MOTOR UNIT	
8	1U- 2785	P.W.B. UNIT ASS'Y	U.S.A., Canada
8	1U- 2785 B	P.W.B. UNIT ASS'Y	Europe
8	1U- 2785 D	P.W.B. UNIT ASS'Y	Multi.Voltage
8-1	—	MAIN UNIT	
8-2	—	POWER TRANS. UNIT	
8-3	—	LOADING SW. UNIT	
8-4	—	DISC SENSOR UNIT	
9	431 0313 603	CLAMPING SW. UNIT	
10	421 0593 400	ROULETTE	
11	146 1297 008	LOADER PANEL	
12	424 0174 404	HELICAL GEAR	
15	461 0689 008	HIMERON SHEET	
16	412 3484 208	GEAR BRACKET ASS'Y	
17	GEN 1682	ROULETTE MOTOR SUB ASS'Y	
19	412 3350 109	LOADER BRACKET	
20	461 0659 009	LOADER STOPPER	
21	412 3348 205	FRONT BRACKET	
22	009 0090 004	35P FFC CABLE	
24	393 4132 009	FL TUBE (FIP 8RM6)	
25	499 0150 008	REMOTE SENSOR (SBX1610-52)	
26	113 1462 215	FUNCTION KNOB	
27	113 1461 009	SERIES KNOB	
28	211 0661 010	VARIABLE RESISTOR (V0920P30FC202)	
29	204 8364 007	HEAD PHONE JACK	
30	212 1039 000	1P PUSH SWITCH	
32	113 1357 207	POWER SWITCH KNOB	
33	112 0645 108	HEAD PHONE KNOB	
34	206 2110 004	AC CORD WITH CONNECTOR	U.S.A. Canada
34	206 2089 106	AC CORD WITH CONNECTOR	Europe
34	206 2088 000	AC CORD WITH CONNECTOR	Multi.Voltage
35	445 0056 008	CORD BUSH	
36	233 5941 010	POWER TRANSFORMER	U.S.A. Canada
36	233 6063 010	POWER TRANSFORMER	Europe
36	233 6061 012	POWER TRANSFORMER	Multi.Voltage
37	FG-40	CD MECHA. UNIT	
38	424 0172 202	CLAMPING CAM	
40	9KA 85A0 02	CLAMPER	
43	424 0173 104	LOADING GEAR	
44	GEN 1680	LOADING MOTOR SUB ASS'Y	
45	424 0130 011	PULLEY GEAR	
46	423 0061 006	BELT	
47	GEN 1678	CLAMP MOTOR SUB ASS'Y	
48	424 0130 008	PULLEY GEAR	
49	423 0061 006	BELT	
50	443 1161 006	COLLAR	
51	204 8356 002	1P PIN JACK	
52	204 8373 001	2P PIN JACK	
53	204 8373 001	2P PIN JACK	
54	204 8416 007	MINI JACK	
56	424 0093 226	WORM GEAR ASS'Y	
57	102 0479 102	TOP COVER	
58	477 0096 007	PUSH RIVET	
59	475 1005 017	4W WASHER	
60	473 7501 014	3x14 CBTS(P)-Z SCREW	
63	412 3499 002	BLIND PLATE	
64	461 0690 107	MOTOR SPRING	
65	412 3400 004	EARTH PLATE	
66	143 0568 001	FILTER	
68	461 0580 000	SPACER	
69	475 1106 042	WASHER	
70	475 3100 004	4TWA NI	
71	475 1157 017	SLIT WASHER T0.5	
74	441 1402 112	ROULETTE STOPPER	
75	212 4696 006	VOLTAGE SELECTOR	Multi.Voltage
76	125 0070 009	BLIND SHEET-V	
77	475 1160 004	WASHER	
79	412 3945 006	L. BRACKET	
80	443 1411 002	COLLAR	
101	473 7509 016	4x10 CBTS(P)-B SCREW	
102	473 7015 018	3x8 CBTS(S)-B SCREW	
103	477 0262 006	SPECIAL SCREW	
104	473 7508 017	3x10 CBTS(P)-B SCREW	
106	473 7512 016	3x12 CFTS(P)-B SCREW	
108	473 7002 021	3x8 CBTS(S)-B SCREW	
109	473 7002 018	3x8 CBTS(S)-Z SCREW	
120	471 8301 039	2x3 CBS-Z SCREW	
122	473 7508 059	3x20 CBTS(P)-B SCREW	
123	473 0840 064	3x30 CPTS(B)ZN	
124	473 7501 030	3x20 CBTS(P)-Z	

## WARNING :

Parts marked with \*  $\Delta$  \* and/shading have special characteristics important to safety.

Be sure to use the specified parts for replacement.

Parts indicated with the mark \*  $\bullet$  \* are not always in stock and possibly to take a long period of time for supplying, or in some case supplying of parts may be refused.

## PARTS LIST OF PACKING &amp; ACCESSORIES (DCM-460)

Ref. No.	Part No.	Part Name	Remarks	Q'ty
$\bullet$	505 0102 089	Styrene Paper	For set	1
$\bullet$	504 0092 060	Styrene Paper	For AC cord	1
$\bullet$	503 1125 001	Cushion		2
$\bullet$	501 1857 014	Carton Case		1
$\bullet$	505 8006 019	Envelope		1
$\bullet$	511 2700 002	Instruction Manual	U.S.A. Canada	1
$\bullet$	511 2701 001	Instruction Manual	Europe	1
$\bullet$	515 0690 006	DEL Warranty Home	U.S.A. Canada	1
	203 2360 004	2P Pin Cord		1
	499 0266 002	Remote Control Unit(RC-246)		1

P.W.BOARD

1 2 3 4 5 6 7 8

1U-2787 MAIN UNIT (DCM-560)

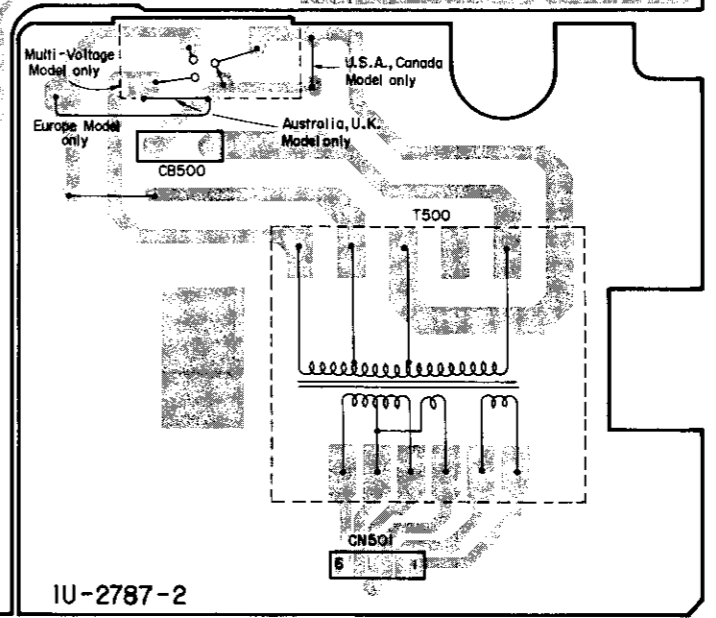
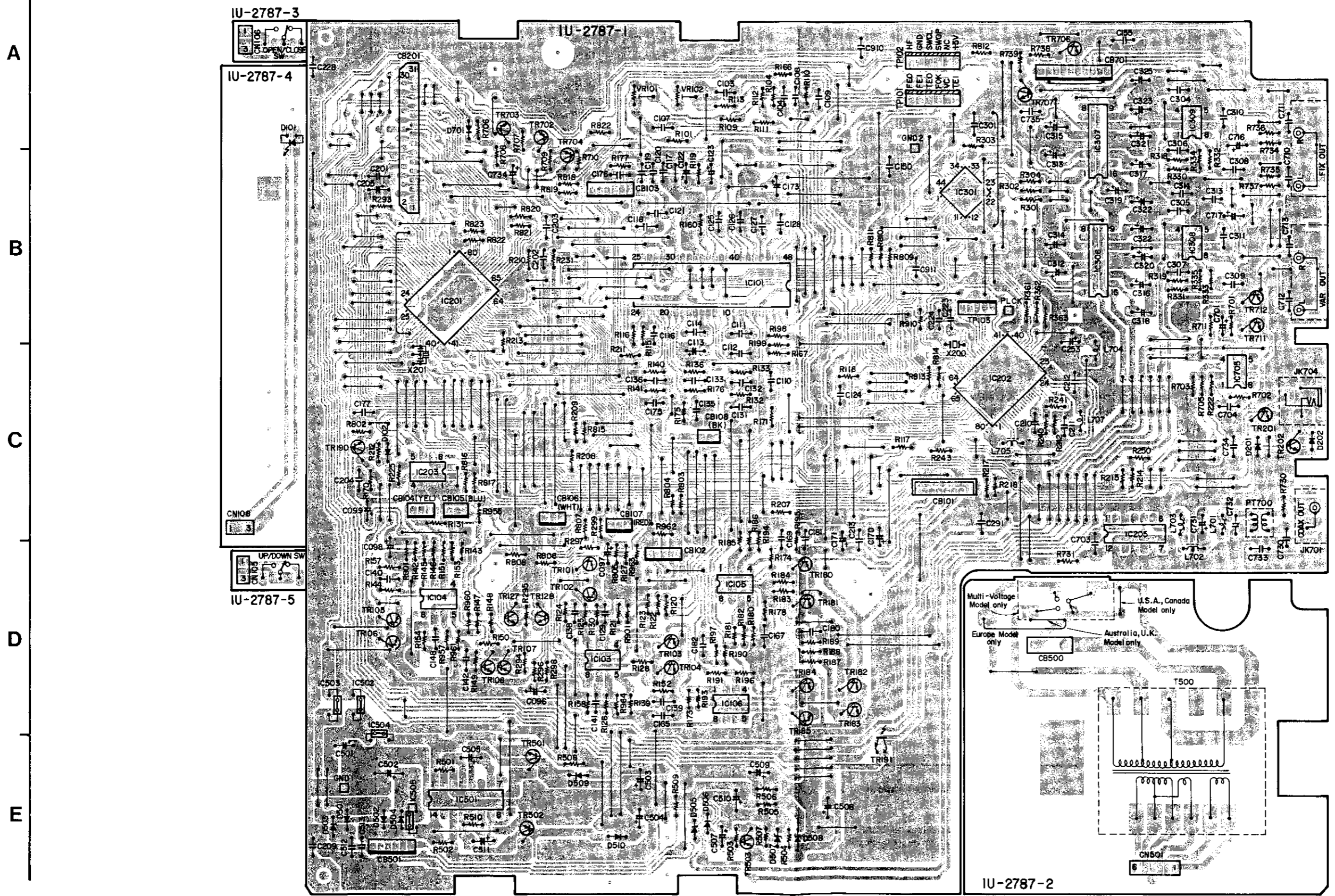

A  
B  
C  
D  
E



1 2 3 4 5 6 7 8

1U-2785 MAIN UNIT (DCM-460)

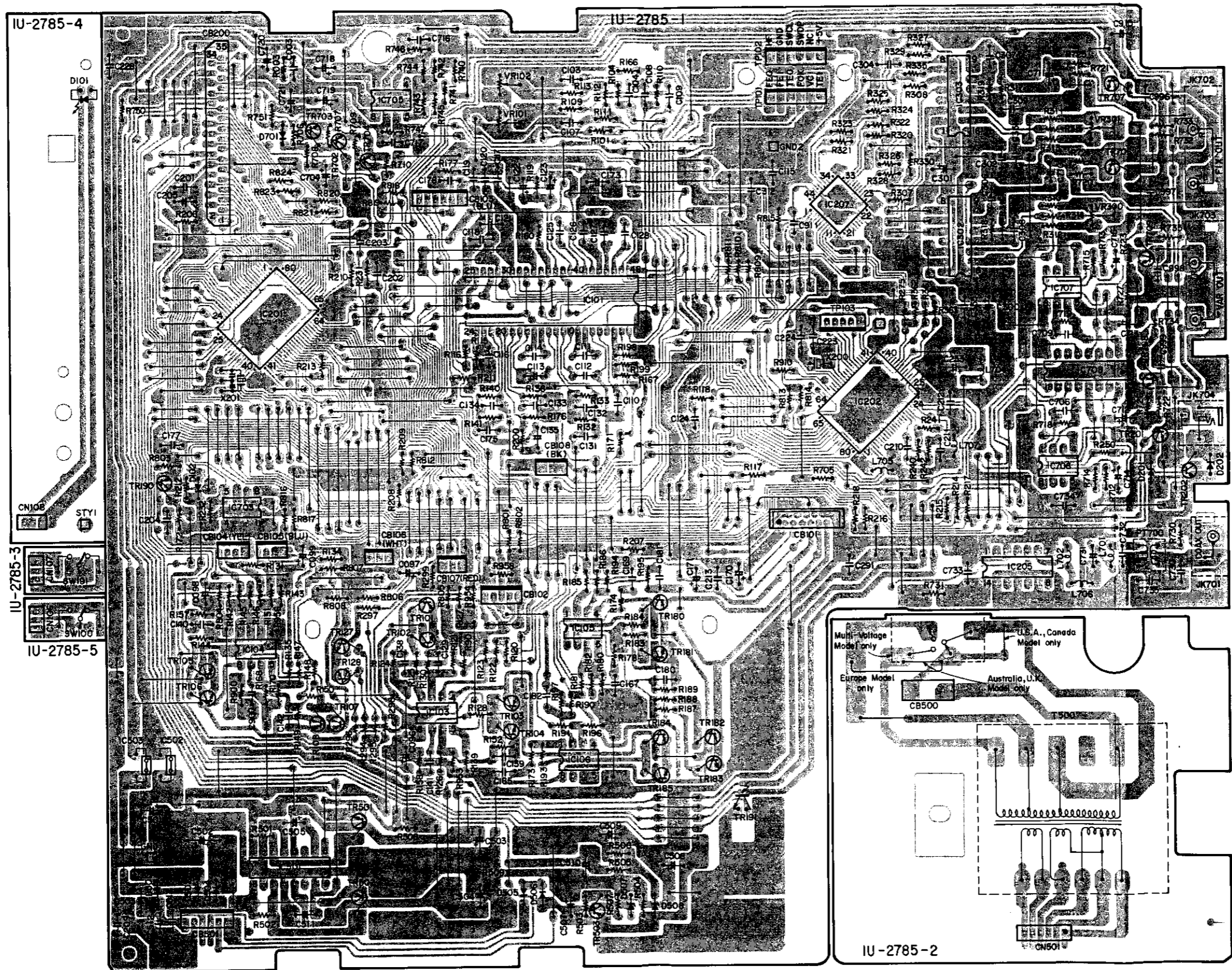

A  
B  
C  
D  
E

1 2 3 4 5 6 7 8

1U-2788 DISPLAY UNIT (DCM-560)

A

B

C

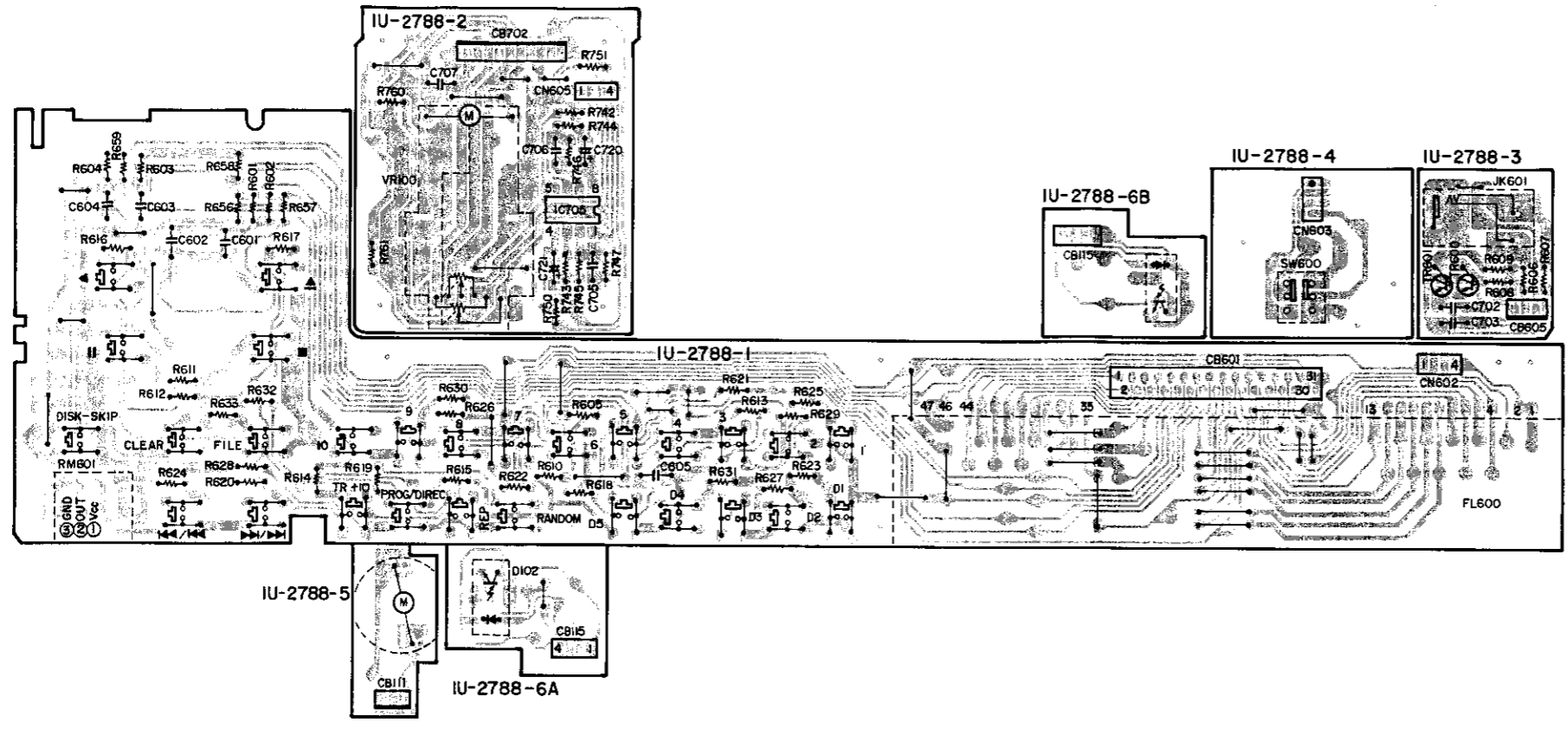

3U-2576 DISPLAY UNIT (DCM-460)

D

E

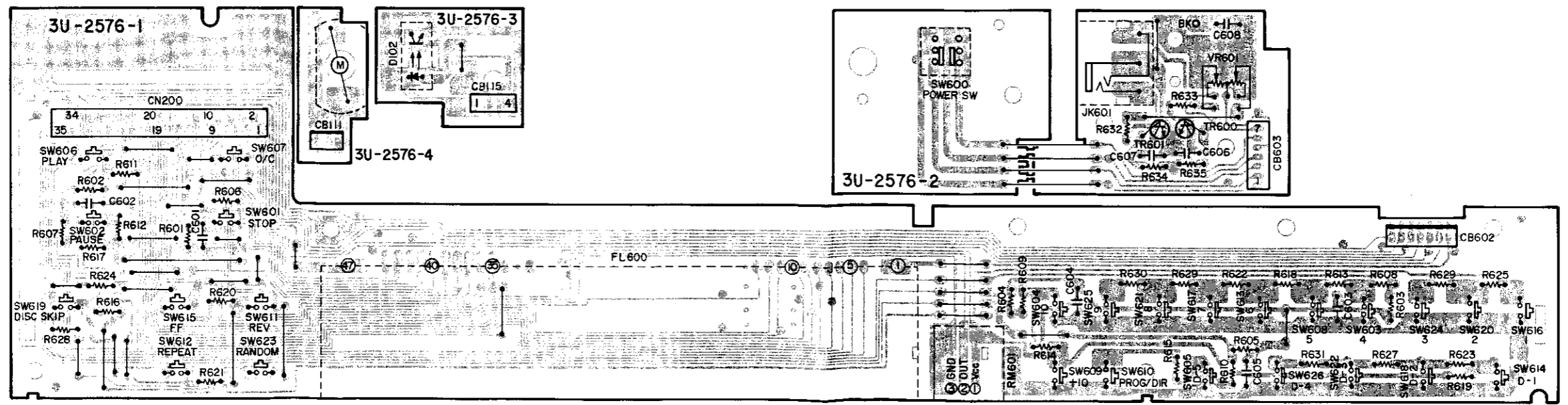

# WIRING DIAGRAM (DCM-560)

1                      2                      3                      4                      5                      6                      7                      8

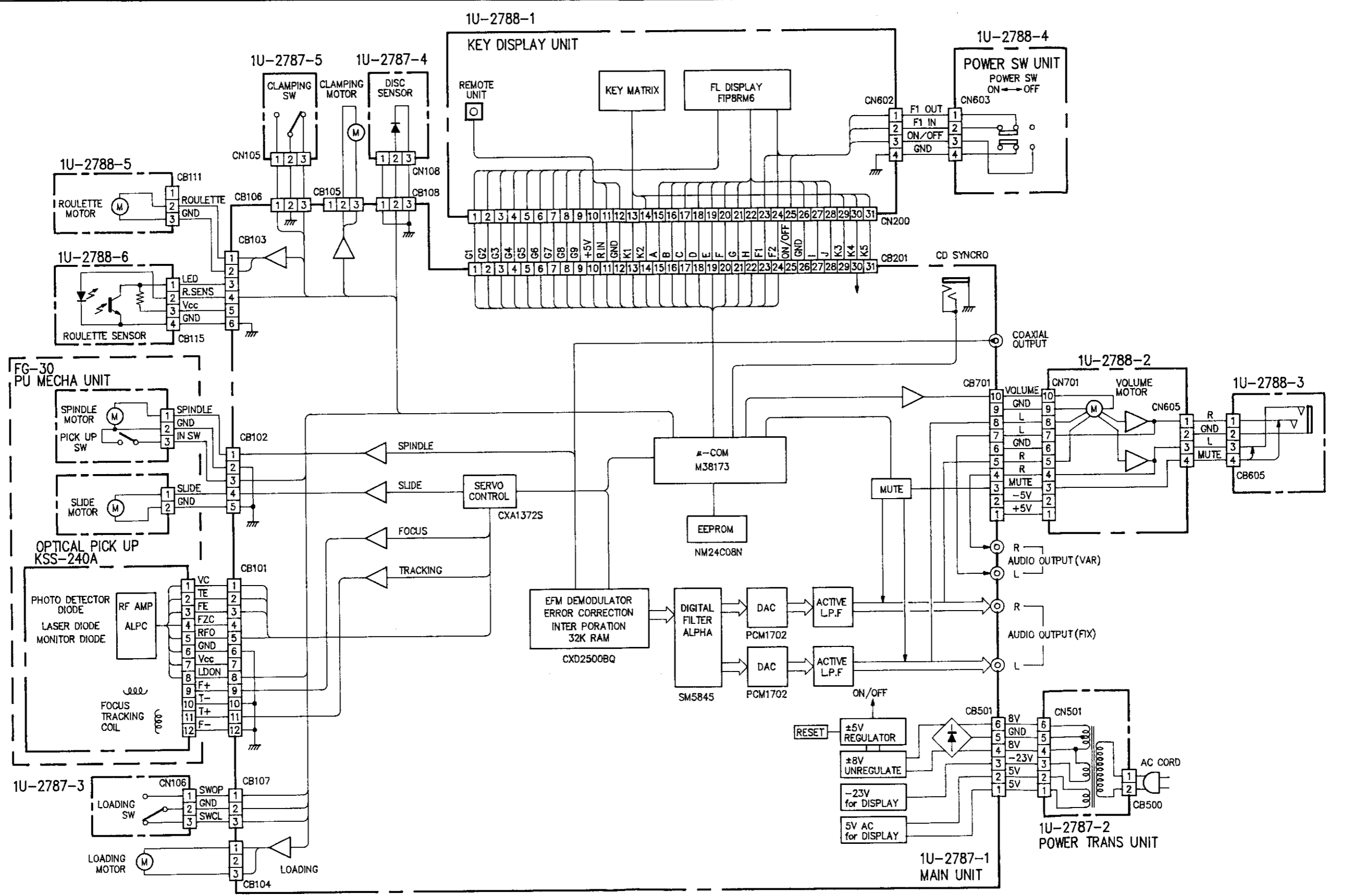

A  
B  
C  
D  
E

# WIRING DIAGRAM (DCM-460)

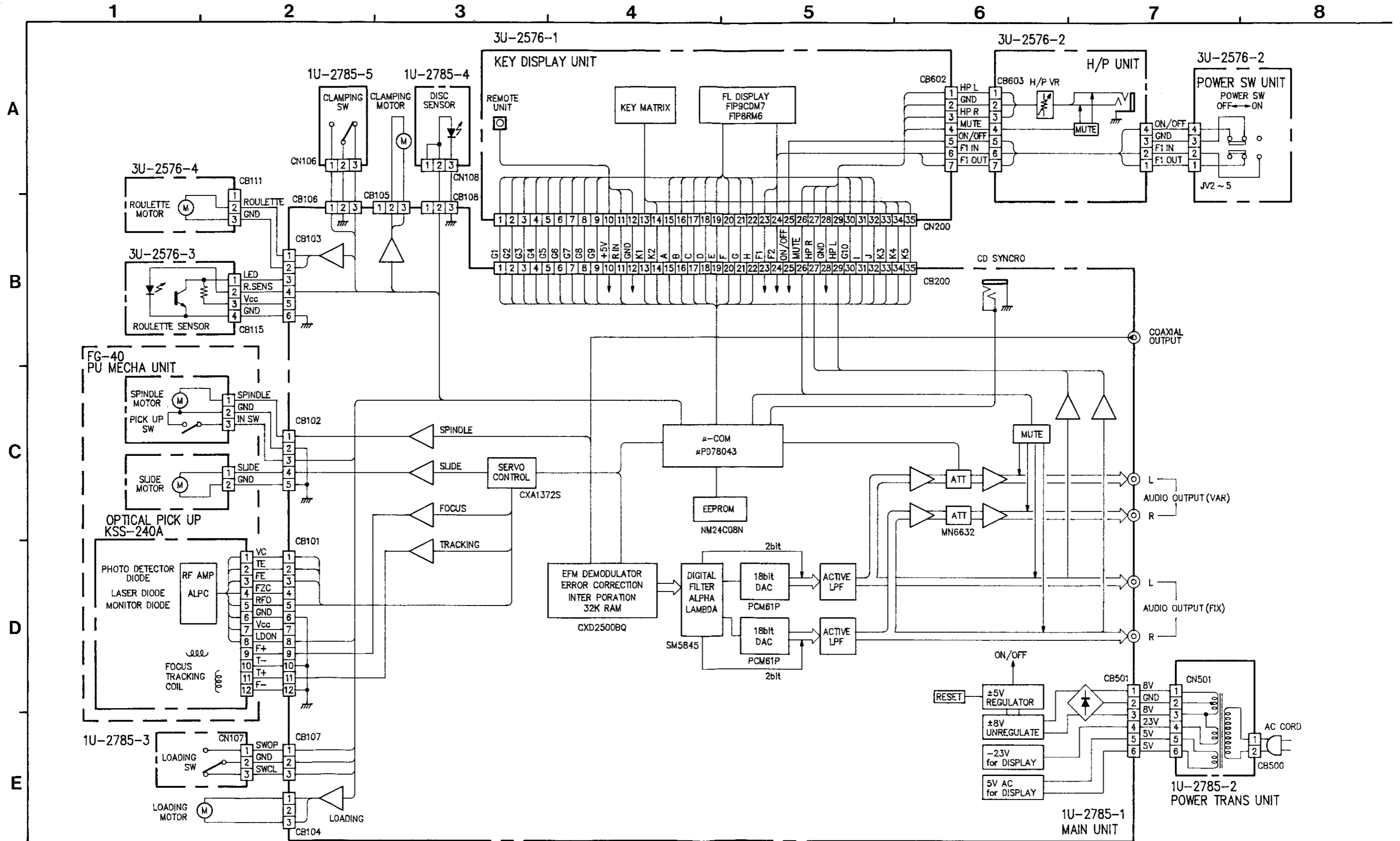



# SCHEMATIC DIAGRAM (DCM-560)

1                      2                      3                      4                      5                      6                      7                      8

IC	IC106 IC104	IC103	IC105	IC104	IC106	IC105	IC101	IC202	IC205	IC201
TRANSISTOR	TR185 TR184 TR108 TR107 TR104 TR103	TR183 TR182 TR106 TR105	TR102 TR101 TR128 TR127	TR181 TR180				TR190 TR191		
DIODE	D102									

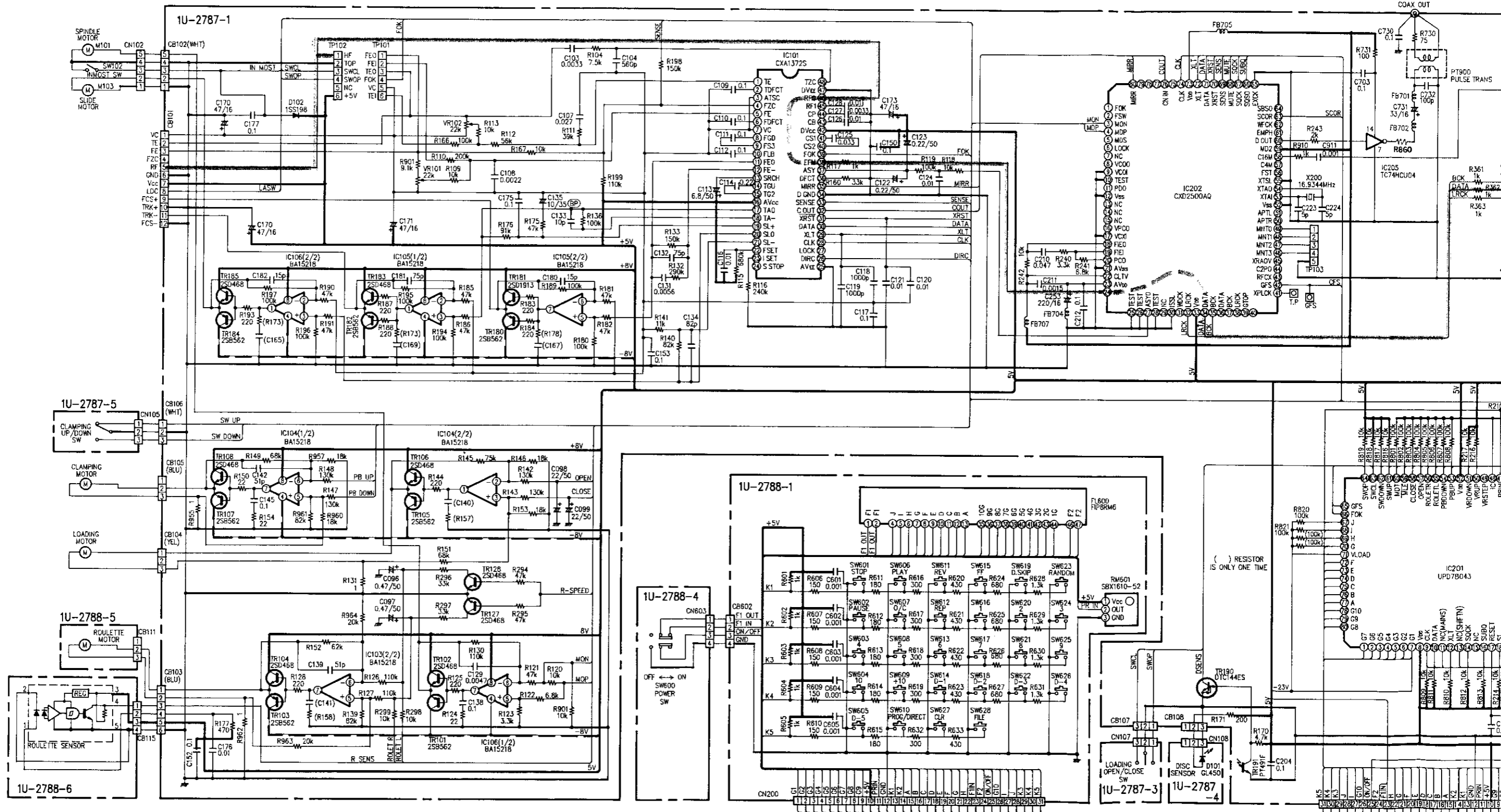

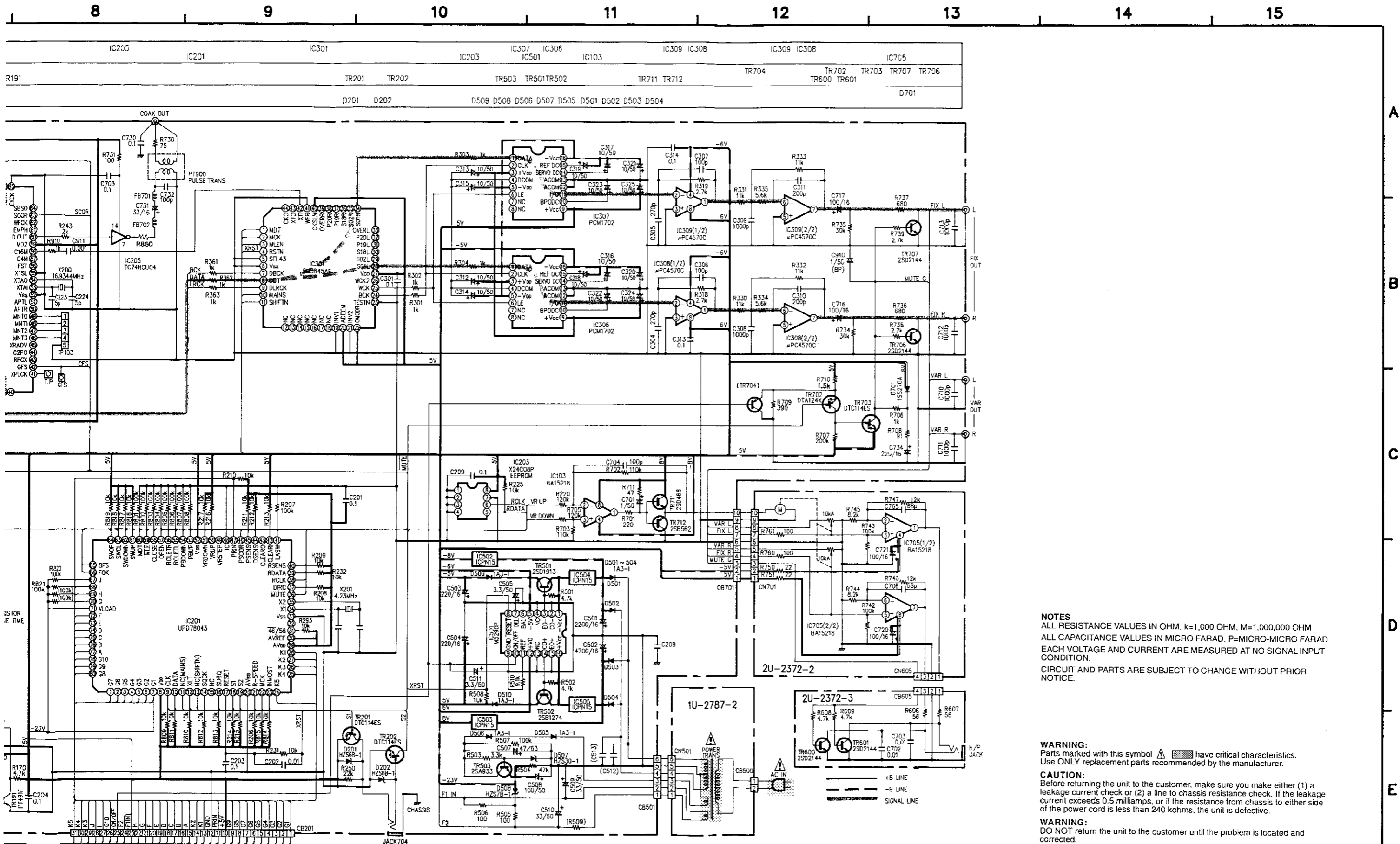

**NOTES**  
 ALL RESISTANCE VALUES IN OHM. k=1,000 OHM, M=1,000,000 OHM  
 ALL CAPACITANCE VALUES IN MICRO FARAD. P=MICRO-MICRO FARAD  
 EACH VOLTAGE AND CURRENT ARE MEASURED AT NO SIGNAL INPUT CONDITION.  
 CIRCUIT AND PARTS ARE SUBJECT TO CHANGE WITHOUT PRIOR NOTICE.

**WARNING:**  
 Parts marked with this symbol have critical characteristics. Use ONLY replacement parts recommended by the manufacturer.

**CAUTION:**  
 Before returning the unit to the customer, make sure you make either (1) a leakage current check or (2) a line to chassis resistance check. If the leakage current exceeds 0.5 milliamps, or if the resistance from chassis to either side of the power cord is less than 240 kohms, the unit is defective.

**WARNING:**  
 DO NOT return the unit to the customer until the problem is located and corrected.

**SCHEMATIC DIAGRAM (DCM-460)**

1 2 3 4 5 6 7 8

A

B

C

D

E

IC	IC106 IC104	IC103	IC105	IC104	IC103	IC105	IC101	IC203
TRANSISTOR	TR185 TR184 TR108 TR107 TR104 TR103	TR183 TR182 TR106 TR105 TR102 TR101 TR128 TR127	TR181 TR180					TR190
DIODE	D102							

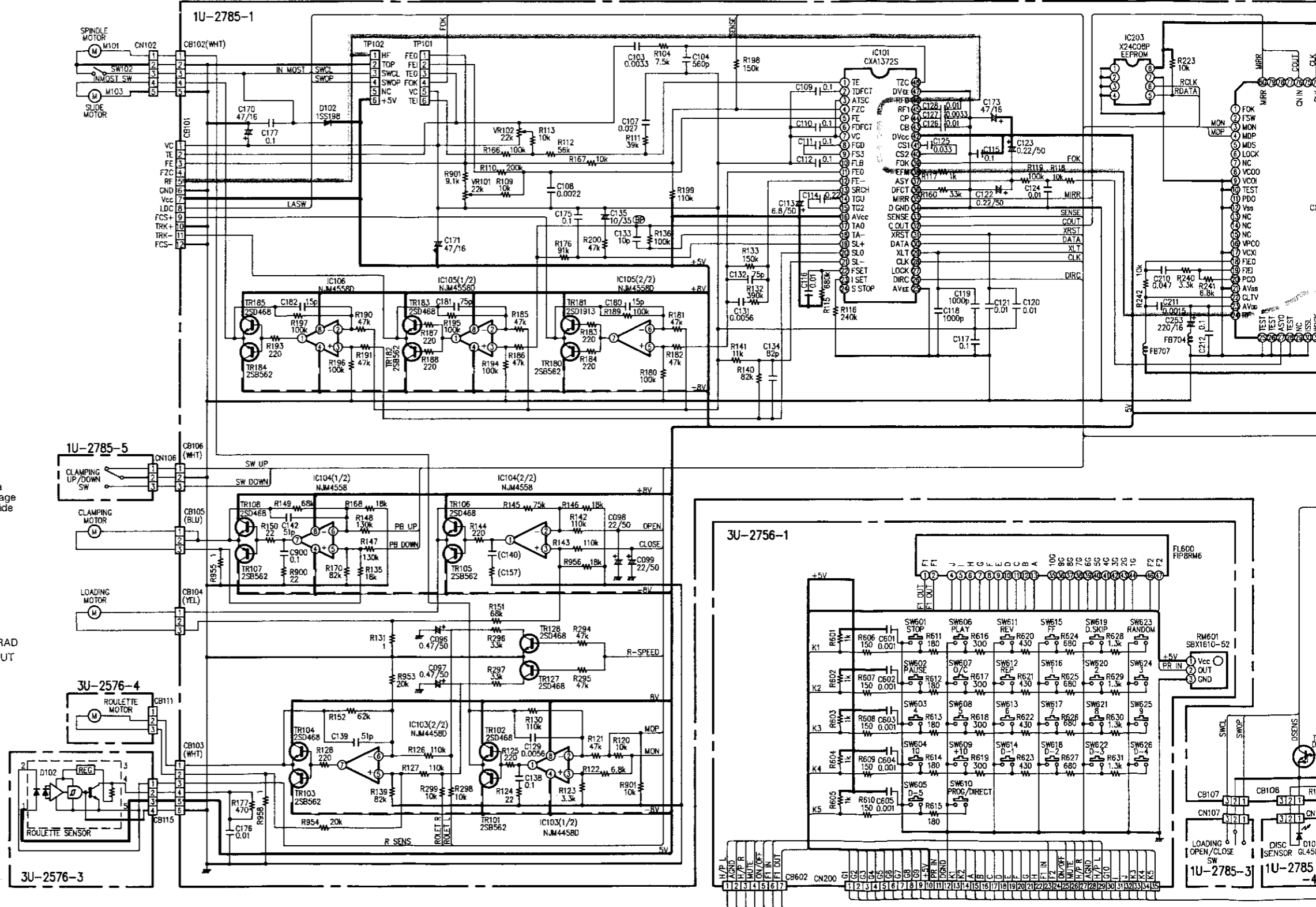

**WARNING:**  
Parts marked with this symbol have critical characteristics. Use ONLY replacement parts recommended by the manufacturer.

**CAUTION:**  
Before returning the unit to the customer, make sure you make either (1) a leakage current check or (2) a line to chassis resistance check. If the leakage current exceeds 0.5 milliamps, or if the resistance from chassis to either side of the power cord is less than 240 kohms, the unit is defective.

**WARNING:**  
DO NOT return the unit to the customer until the problem is located and corrected.

**NOTES**  
ALL RESISTANCE VALUES IN OHM. k=1,000 OHM, M=1,000,000 OHM  
ALL CAPACITANCE VALUES IN MICRO FARAD. P=MICRO-MICRO FARAD  
EACH VOLTAGE AND CURRENT ARE MEASURED AT NO SIGNAL INPUT CONDITION.  
CIRCUIT AND PARTS ARE SUBJECT TO CHANGE WITHOUT PRIOR NOTICE.

