

DENON

Hi-Fi AM-FM Stereo Receiver

SERVICE MANUAL

MODEL DRA-375RD

MODEL DRA-275RD/275R

AM-FM STEREO RECEIVER

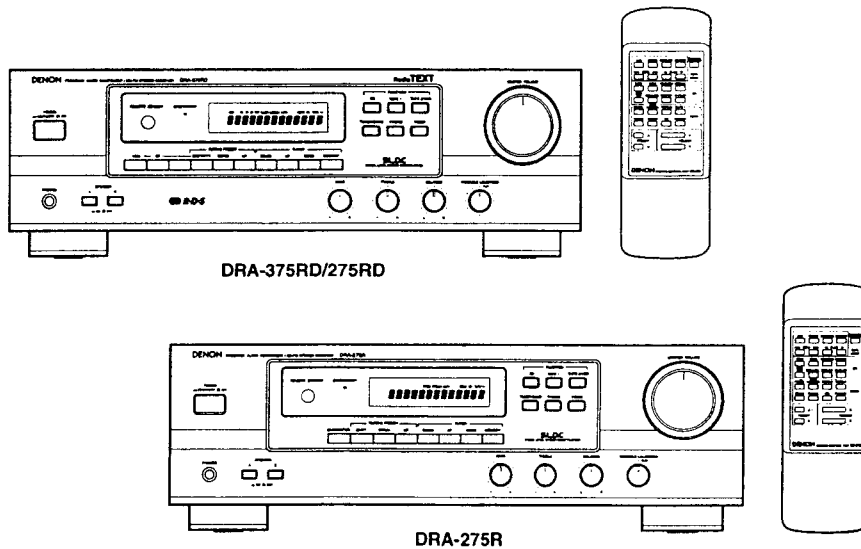

— TABLE OF CONTENTS —

OPERATING INSTRUCTIONS	3
DISASSEMBLY	10
WIRE ARRANGEMENT	11
METHOD OF ADJUSTMENT	12, 13
BLOCK LEVEL DIAGRAM	14
SEMICONDUCTORS	15-20
PRINTED WIRING BOARD PATTERNS	21-23
MAIN UNIT	21
DISPLAY UNIT	22
TUNER UNIT	23
NOTE FOR PARTS LIST	24
PRINTED WIRING BOARD PATTERNS	25-29
EXPLODED VIEW OF CHASSIS AND CABINET	30
PARTS LIST OF EXPLODED VIEW	31
WIRING DIAGRAM	32
SCHEMATIC DIAGRAM	33, 34

• Some illustration using in this service manual is slightly different from the actual set.

NIPPON COLUMBIA CO., LTD.

• SAFETY PRECAUTIONS



CAUTION

RISK OF ELECTRIC SHOCK

DO NOT OPEN



CAUTION: TO REDUCE THE RISK OF ELECTRIC SHOCK, DO NOT REMOVE COVER (OR BACK). NO USER SERVICEABLE PARTS INSIDE. REFER SERVICING TO QUALIFIED SERVICE PERSONNEL.



The lightning flash with arrowhead symbol, within an equilateral triangle, is intended to alert the user to the presence of uninsulated "dangerous voltage" within the product's enclosure that may be of sufficient magnitude to constitute a risk of electric shock to persons.



The exclamation point within an equilateral triangle is intended to alert the user to the presence of important operating and maintenance (servicing) instructions in the literature accompanying the appliance.

WARNING: TO REDUCE THE RISK OF FIRE OR ELECTRIC SHOCK, DO NOT EXPOSE THIS APPLIANCE TO RAIN OR MOISTURE.

• FOR U.S.A. & CANADA MODEL ONLY

CAUTION

TO PREVENT ELECTRIC SHOCK DO NOT USE THIS (POLARIZED) PLUG WITH AN EXTENSION CORD, RECEPTACLE OR OTHER OUTLET UNLESS THE BLADES CAN BE FULLY INSERTED TO PREVENT BLADE EXPOSURE.

• POUR LES MODELES AMERICAINS ET CANADIENS UNIQUEMENT

ATTENTION





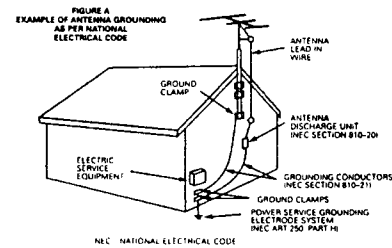

POUR PREVENIR LES CHOCS ELECTRIQUES NE PAS UTILISER CETTE FICHE POLARISEE AVEC UN PROLONGATEUR UNE PRISE DE COURANT OU UNE AUTRE SORTIE DE COURANT, SAUF SI LES LAMES PEUVENT ETRE INSEREES A FOND SANS EN LAISSER AUCUNE PARTIE A DECOUVERT.

SAFETY INSTRUCTIONS

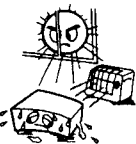
1. Read Instructions – All the safety and operating instructions should be read before the appliance is operated.
2. Retain Instructions – The safety and operating instructions should be retained for future reference.
3. Heed Warnings – All warnings on the appliance and in the operating instructions should be adhered to.
4. Follow Instructions – All operating and use instructions should be followed.
5. Water and Moisture – The appliance should not be used near water – for example, near a bathtub, washbowl, kitchen sink, laundry tub, in a wet basement, or near a swimming pool, and the like.
6. Carts and Stands – The appliance should be used only with a cart or stand that is recommended by the manufacturer.
- 6A. An appliance and cart combination should be moved with care. Quick stops, excessive force, and uneven surfaces may cause the appliance and cart combination to overturn.
7. Wall or Ceiling Mounting – The appliance should be mounted to a wall or ceiling only as recommended by the manufacturer.
8. Ventilation – The appliance should be situated so that its location or position does not interfere with its proper ventilation. For example, the appliance should not be situated on a bed, sofa, rug, or similar surface that may block the ventilation openings; or, placed in a built-in installation, such as a bookcase or cabinet that may impede the flow of air through the ventilation openings.
9. Heat – The appliance should be situated away from heat sources such as radiators, heat registers, stoves, or other appliances (including amplifiers) that produce heat.
10. Power Sources – The appliance should be connected to a power supply only of the type described in the operating instructions or as marked on the appliance.
11. Grounding or Polarization – Precautions should be taken so that the grounding or polarization means of an appliance is not defeated.
12. Power-Cord Protection – Power-supply cords should be routed so that they are not likely to be walked on or pinched by items placed upon or against them, paying particular attention to cords at plugs, convenience receptacles, and the point where they exit from the appliance.
14. Cleaning – The appliance should be cleaned only as recommended by the manufacturer.
15. Power Lines – An outdoor antenna should be located away from power lines.
16. Outdoor Antenna Grounding – If an outside antenna is connected to the receiver, be sure the antenna system is grounded so as to provide some protection against voltage surges and built-up static charges. Article 810 of the National Electrical Code, ANSI/NFPA 70, provides information with regard to proper grounding of the mast and supporting structure, grounding of the lead-in wire to an antenna-discharge unit, size of grounding conductors, location of antenna-discharge unit, connection to grounding electrodes, and requirements for the grounding electrode. See Figure A.
17. Nonuse Periods – The power cord of the appliance should be unplugged from the outlet when left unused for a long period of time.
18. Object and Liquid Entry – Care should be taken so that objects do not fall and liquids are not spilled into the enclosure through openings.
19. Damage Requiring Service – The appliance should be serviced by qualified service personnel when:
 - A. The power-supply cord or the plug has been damaged; or
 - B. Objects have fallen, or liquid has been spilled into the appliance; or
 - C. The appliance has been exposed to rain; or
 - D. The appliance does not appear to operate normally or exhibits a marked change in performance; or
 - E. The appliance has been dropped, or the enclosure damaged.
20. Servicing – The user should not attempt to service the appliance beyond that described in the operating instructions. All other servicing should be referred to qualified service personnel.

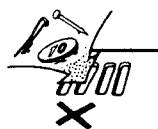
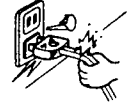
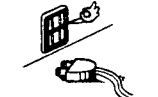

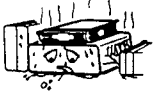
NOTE ON USE / OBSERVATIONS RELATIVES A L'UTILISATION / NOTAS SOBRE EL USO

 <ul style="list-style-type: none"> Avoid high temperatures. Allow for sufficient heat dispersion when installed on a rack. Éviter des températures élevées. Tenir compte d'une dispersion de chaleur suffisante lors de l'installation sur une étagère. Evite altas temperaturas. Permite la suficiente dispersión del calor cuando está instalado en la consola. 	 <ul style="list-style-type: none"> Keep the set free from moisture, water, and dust. Protéger l'appareil contre l'humidité, l'eau et la poussière. Mantenga el equipo libre de humedad, agua y polvo. 	 <ul style="list-style-type: none"> Do not let foreign objects in the set. Ne pas laisser des objets étrangers dans l'appareil. No deje objetos extraños dentro del equipo.
 <ul style="list-style-type: none"> Handle the power cord carefully. Hold the plug when unplugging the cord. Manipuler le cordon d'alimentation avec précaution. Tenir la prise lors du débranchement du cordon. Maneje el cordón de energía con cuidado. Sostenga al enchufe cuando desconecte el cordón de energía. 	 <ul style="list-style-type: none"> Unplug the power cord when not using the set for long periods of time. Débrancher le cordon d'alimentation lorsque l'appareil n'est pas utilisé pendant de longues périodes. Desconecte el cordón de energía cuando no utilice el equipo por mucho tiempo. 	 <ul style="list-style-type: none"> Do not let insecticides, benzene, and thinner come in contact with the set. Ne pas mettre en contact des insecticides, du benzène et un diluant avec l'appareil. No permita el contacto de insecticidas, gasolina y diluyentes con el equipo.
	 <ul style="list-style-type: none"> Do not obstruct the ventilation holes. Ne pas obstruer les trous d'aération. No obstruya los orificios de ventilación. 	 <ul style="list-style-type: none"> Never disassemble or modify the set in any way. Ne jamais démonter ou modifier l'appareil d'une manière ou d'une autre. Nunca desarme o modifique el equipo de ninguna manera.

PRECAUTIONS FOR INSTALLATION

- DRA-375RD/275R always install horizontally.
- For heat dispersal, leave at least 10 cm of space between the top, back and sides of this unit and the wall or other components.

PRECAUTIONS D'INSTALLATION

- Le DRA-375RD/275R doit toujours être installé horizontalement.
- Afin de disperser la chaleur, laisser un espace d'au moins 10 cm entre le haut, l'arrière et les côtés de cet appareil et le mur ou un autre composant.

PRECAUCIONES PARA LA INSTALACION

- Instale siempre el DRA-375RD/275R en posición horizontal.
- Para que el calor se disipe, deje por lo menos 10 cm de espacio entre las partes superior, posterior y laterales de esta unidad y la pared u otros componentes.

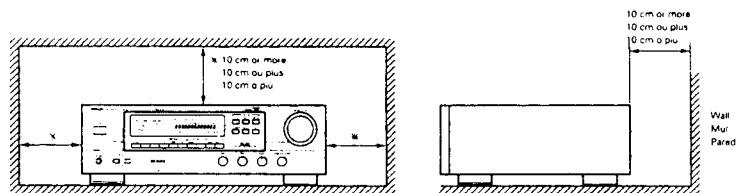

ENGLISH

— TABLE OF CONTENTS —

NAME AND FUNCTION OF PARTS	6-8
CONNECTIONS	9
SPEAKER CONNECTION	10
ANTENNA INSTALLATION	10
USING THE VARIOUS FUNCTIONS	11, 12
PLAYBACK USING THE REMOTE CONTROL	13, 14
TROUBLESHOOTING	15
SPECIFICATIONS	16

Please check to make sure the following items are included with the main unit in the carton:

(1) Operating Instructions	1
(2) AM Loop Antenna	1
(3) FM Indoor Antenna	1
(4) Remote Control Unit RC-812	1
(5) Batteries R6 (AA)	2

FRANCAIS

— TABLE DES MATIERES —

NOMÉCLATURE ET FONCTIONS	17-19
CONNEXIONS	20
CONNEXION D'ENCEINTE	21
INSTALLATION DE L'ANTENNE	21
UTILISATION DES DIVERSES FONCTIONS	22, 23
LECTURE UTILISANT LA TELECOMMANDE	24, 25
DEPANNAGE	26
SPECIFICATIONS	27

Veuillez contrôler que les articles suivants sont bien joints à l'appareil principal dans le carton:

(1) Mode d'emploi	1
(2) Antenne Cadre AM	1
(3) Antenne FM Interieure	1
(4) Télécommande RC-812	1
(5) Piles de format R6 (AA)	2

ESPAÑOL

— INDICE —

NOMBRE Y FUNCION DE LAS PARTES	28-30
CONEXIONES	31
CONEXION DE LOS ALTAVOCES	32
INSTALACION DE ANTENAS	32
USO DE LAS DIVERSAS FUNCIONES	33, 34
OPERACION A CONTROL REMOTO	35, 36
ANTES DE SOLICITAR REPARACIONES	37
ESPECIFICACIONES	38

Por favor verifique asegurandose de que los siguientes articulos son empacados en la caja pero separados de la unidad principal.

(1) Instrucciones de operacion	1
(2) Antena AM de Cuadro	1
(3) Antena FM Interior	1
(4) Unidad de control remoto RC-812	1
(5) Pilas secas R6 (AA)	2

NAME AND FUNCTION OF PARTS

FRONT PANEL

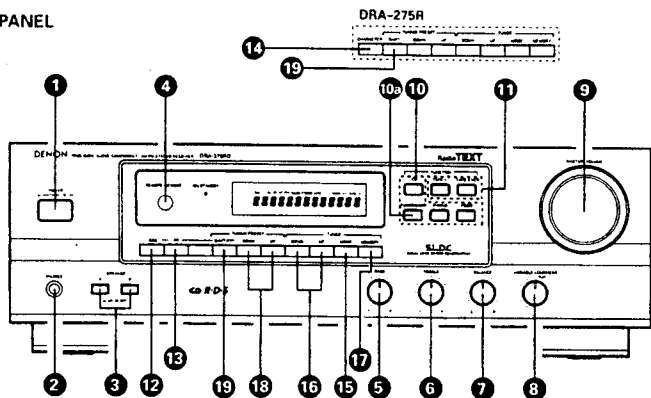

- 1 POWER (Power ON/OFF Switch)**
This switch turns the unit ON or OFF. There is a delay of a few seconds before the unit will operate after this power switch is turned ON. If the unit is turned OFF from the remote control, the unit will be in the STANDBY mode. When in the STANDBY mode, the unit can be turned ON with the power button on the remote control. If the unit will not be used for extended period, be sure to turn the unit OFF from the front panel power switch.
NOTE: This unit includes a STANDBY protection feature. This feature is designed to prevent accidental turn-on from the STANDBY mode in the event of a power failure. Should AC power be disconnected and then reconnected when the unit is in STANDBY mode, the unit will return to the STANDBY mode. To turn the unit ON from the STANDBY mode without the remote control, operate the front panel power switch twice. The unit will then operate normally.
- 2 PHONES (Headphones jack)**
Connect the headphones to the PHONES jacks. When listening with headphones privately, set A, B SPEAKER switches to the OFF position.
NOTE: To prevent hearing loss, do not raise the volume level excessively when using headphones.
- 3 SPEAKER (Speaker selector switches)**
These switches are used to engage speaker system A and B. No sound is heard through the speakers when both switches are set to the (OFF) position.
- 4 REMOTE SENSOR (Remote control sensor)**
This sensor receives the infra-red light transmitted from the wireless remote control unit.
For remote control, point the wireless remote control unit towards the sensor.
- 5 BASS (Bass control)**
Use this control to adjust the low-range response. When the control is set to the center position, the frequency characteristic curve below 1,000 Hz is flat. Turn the control clockwise to increase the bass response and counterclockwise to decrease it.
- 6 TREBLE (Treble control)**
Use this control to adjust the high-range response. When the control is set to the center position, the frequency characteristic curve above 1,000 Hz is flat. Turn the control clockwise to increase the treble response and counterclockwise to decrease it.

- 7 BALANCE (Balance control)**
Use this control to balance the volume levels between left and right channels. The volume levels in both channels are equal when the control is set to the center position.
- 8 VARIABLE LOUDNESS (Loudness control)**
At low volumes, the human ear is less sensitive to low (BASS) and high (TREBLE) frequencies. Use this control to compensate for this deficiency when listening at low volume levels. Turn this control counterclockwise until a natural balance of bass and treble sound has been restored.
- 9 MASTER VOLUME (Volume control)**
This knob is used to adjust the volume level of both channels. Turn the knob clockwise to raise the volume and counterclockwise to lower it.
- 10 FUNCTION (Input selector buttons)**
These buttons are used to select the audio input source.
 - PHONO: Press to play a record on a record player connected to the PHONO input jacks.
 - CD: Press to listen to a compact disc player or another component connected to the CD input jacks.
 - TUNER: Press to listen to FM or AM programs.
 - VIDEO: Use when playing back the audio from a Hi-Fi video, video disc player or other component connected to the VIDEO terminal.
 * If a function switch is pressed quickly, the function may not actually change and no signal may be heard from the speakers for an instant. To avoid this, be sure to press function switches carefully.
- 10b BAND (Band selector button)**
Press this button to select the FM or AM band, when the set is in TUNER function.
- 11 Tape selector (Tape selector/monitor buttons)**
TAPE-1: Press this button once, TAPE-1 indicator will light up and then you can play tape source on TAPE-1 terminal.
In this state you can copy TAPE-1 source to TAPE-2/VCR terminal.
TAPE-2/VCR: Press this button once, TAPE-2 indicator will light up and then you can play tape or video source of TAPE-2/VCR terminal.
Press again the button currently accessed, to play sources selected by input selector indicator goes out.

- 12 RDS button (DRA-375RD)**
This button is used for the RDS search (refer to page 11) and PTY search (refer to page 11), and TP search (refer to page 11) operations, and to input the station name. (refer to page 12)
- 13 RT (Radio Text) button (DRA-375RD)**
This button is used for displaying radio text messages. When this button is pressed while the station currently tuned in is offering a radio text message service, the message scrolls on the display. This mode turns on and off each time the button is pressed. (refer to page 11)
- 14 CHARACTER button (DRA-275R)**
This button is used to write station names. (refer to page 12)
- 15 MODE (Tuning mode button)**
This switches between auto and manual tuning.
Auto tuning: When the UP button (16) is pressed, the radio is tuned automatically to a higher frequency. Press the DOWN button (17) to tune to a lower frequency. Use this position to eliminate noise when no signals or weak signals are being received.
Manual tuning: In this position, the radio can be tuned manually. Reception is automatically manual when in the manual mode.
- 16 TUNER (Tuning up/down buttons)**
Use these to change the received frequency to a higher frequency (UP) or a lower frequency (DOWN).
When writing station names, use these buttons to select the letters. (refer to page 12)

- 17 MEMORY (Memory button)**
This switch is used to store the desired radio station to a memory.
 - **Presetting stations**
After pressing the MEMORY button, press the SHIFT/PTY button (the SHIFT button for the DRA-275R), then select the memory block. A to E. Now use the PRESET UP and DOWN buttons to specify the preset channel number. Press the MEMORY button again to store the station at the specified preset channel.
- 18 TUNING PRESET (Preset station buttons)**
These buttons are used for storing stations or recalling stations which have been preset. Using the SHIFT/PTY button (the SHIFT button for the DRA-275R) you can preset a total of 40 FM or AM stations into preset channels.
Once a radio has been memorized the same station can later be tuned in instantly simply by recalling the corresponding preset channel with PRESET UP or DOWN button.
- 19 SHIFT/PTY button (DRA-375RD)**
Use this button to select the memory blocks, A (1 to 8), B (1 to 8), C (1 to 8), D (1 to 8) or E (1 to 8).
For PTY search, use this button to select the program type. When writing station names, use this button to set the writing position.
- **SHIFT button (DRA-275R)**
Use this button to select the memory blocks, A (1 to 8), B (1 to 8), C (1 to 8), D (1 to 8) or E (1 to 8).

DISPLAY

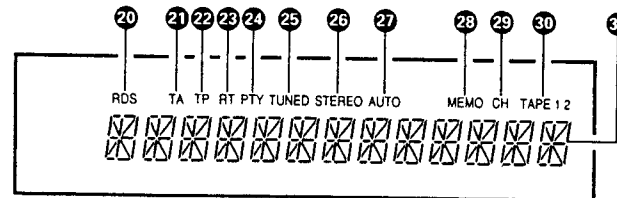

- 20 RDS indicator (DRA-375RD)**
This lights when receiving RDS broadcasts, and flashes during the RDS search operations.
- 21 TA (Traffic Announcement) indicator (DRA-375RD)**
This lights when receiving traffic announcements.
- 22 TP (Traffic Programme) indicator (DRA-375RD)**
This flashes during the TP search operation and lights when TP stations are tuned in.
- 23 RT indicator (DRA-375RD)**
This lights when the RT (Radio Text) button is pressed.
- 24 PTY indicator (DRA-375RD)**
This flashes during the PTY (Programme Type) search operation.
- 25 TUNED indicator**
This lights when a station is properly tuned in.
- 26 STEREO indicator**
This lights when receiving stereo broadcasts. It remains off when receiving AM broadcasts.

- 27 AUTO indicator**
This indicates the tuning mode. It lights in the auto mode, and remains off in the manual mode.
- 28 MEMO indicator**
This indicator flashes for approximately 10 seconds when the MEMORY button has been pressed and a station can be stored on a PRESET CHANNEL button.
This flashes continuously during the auto memory operation.
- 29 CH indicator**
This lights when the preset channel number and shift mode (A, B, C, D or E) are displayed.
- 30 TAPE-1 / TAPE-2 indicator**
The TAPE-1 indicator lights when the TAPE-1 source is selected with the tape selector buttons. The TAPE-2 indicator lights when the TAPE-2/VCR source is selected.
- 31 Multi function display**
This displays the frequency, station name, programme type, etc.

REAR PANEL

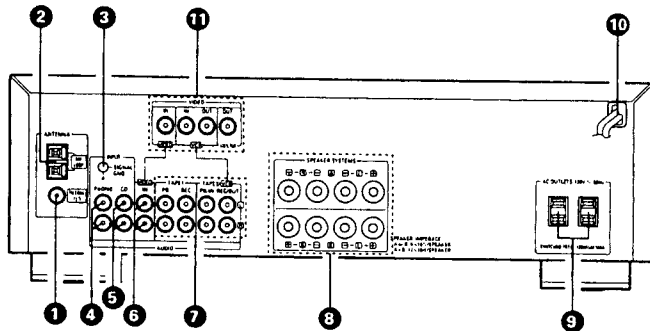

- 1 FM ANT (FM antenna terminals)**
75-Ω/ohms coaxial cable can be connected to this terminal. For antenna connecting procedure, refer to page 9 and 10.
- 2 AM ANT (AM antenna terminals)**
Connect the attached AM loop antenna. (Refer to page 9 and 10 for connections).
- 3 GND (Grounding terminal)**
The grounding wire of the turntable is connected here.
• Hum or noise may be generated if the grounding wire is not connected.
- 4 PHONO (Phono input terminals)**
The output cord of the turntable is connected here.
Since the input sensitivity of "PHONO" is extremely high, do not use the unit without the input pin cord. If used without this cord, the speakers may generate hum.
- 5 CD**
The output cord of the CD player is connected here.
- 6 VIDEO**
The audio outputs of VIDEO equipment, such as a VCR or Video Disc may be connected here.
- 7 TAPE-1, TAPE-2/VCR (Tape deck and/or VCR playback/recording terminal)**
Two tape decks or tape deck and VCR can be connected to these jacks for full-fledged playback, recording and tape dubbing operation.
- 8 SPEAKER SYSTEMS (Speaker terminals)**
Two pairs of speakers A and B can be connected to these terminals.

- 9 AC OUTLET (AC power outlets)**
This AC outlet is controlled by the power switch. Maximum capacity is 120 W.
- 10 AC CORD (Power cord)**
Connect this cord into the wall outlet.
- 11 VIDEO (Video input/output terminals)**
As a full-featured AV center, this receiver makes possible connection of a TV monitor, VCR and/or a video disc player (video) to these jacks.
 - ① Simulcast monitor
Select the desired audio source after selecting VIDEO function. You can monitor the selected audio source with the picture from the VIDEO input.
 - ② VCR monitor
When the TAPE-2/VCR is selected, you can only monitor the sound and picture from the TAPE-2/VCR input. Even you select the audio source after selecting TAPE-2/VCR, the sound and picture remains TAPE-2/VCR.
 - ③ Simulcast copy
If you select the audio source after selecting VIDEO function, you can record the selected audio and picture from VIDEO input into VCR.

CAUTION

Protective Circuit
This set is equipped with a high speed protective circuit. This circuit protects the internal circuitry from damage due to large currents flowing when the speaker jacks are not completely connected or when an output is generated by a short circuit.
This protective circuit's operation cuts off the output to the speakers. In such a case, be sure to turn the power to the set off and check the connections to the speakers. Then turn the power on again. After muting for several seconds, the set will operate normally.

NOTES

- This receiver has a full back-up system. When the power is turned on, the FUNCTION is set automatically to the last mode before the power was turned off.
- When using this receiver in close proximity to video equipment (TV, VCR, VDP, etc.) noise may be generated in AM broadcasts. To avoid this, keep the receiver as far away from other video components as possible, or place the AM loop antenna where noise is reduced. If the noise is not reduced, turn off the power of the video components when listening to AM broadcasts.

CONNECTIONS

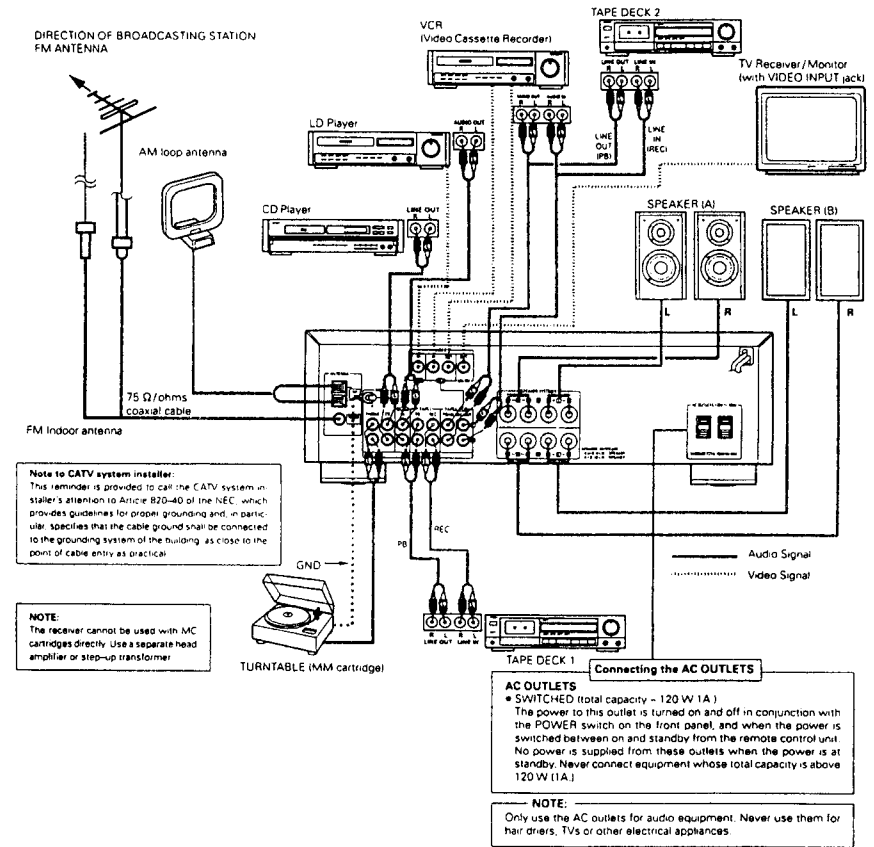

Note to CATV system installer:
This reminder is provided to call the CATV system installer's attention to Article 820-40 of the NEC, which provides guidelines for proper grounding and, in particular, specifies that the cable ground shall be connected to the grounding system of the building, as close to the point of cable entry as practical.

NOTE:
The receiver cannot be used with MC cartridges directly. Use a separate head amplifier or step-up transformer.

Connecting the AC OUTLETS
AC OUTLETS
• SWITCHED (total capacity - 120 W 1A.)
The power to this outlet is turned on and off in conjunction with the POWER switch on the front panel, and when the power is switched between on and standby from the remote control unit. No power is supplied from these outlets when the power is at standby. Never connect equipment whose total capacity is above 120 W (1A.)

NOTE:
Only use the AC outlets for audio equipment. Never use them for hair driers, TVs or other electrical appliances.

Notes on Connection

- Do not plug the power cord into the AC wall outlet until all connections have been completed.
- Make sure channels are correctly connected. Connect Left channels to Left channels and Right channels to Right channels. Follow the color markings of plugs and terminals to make sure mistakes are not made.
- Connect all pin-plugs securely, pushing them completely into the jacks. Incomplete connections will cause noise generation.
- Binding the connection cables to power cords, or running such cables close to power supply transformers will cause humming or noise, and should thus be avoided.

SPEAKER CONNECTION

Confirm polarity (+, -) and left and right channels (L, R). Connect the speaker pairs to the SPEAKER terminals A or B on the back panel. Connections must be made with power cord disconnected.

Preparing the cord

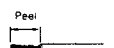
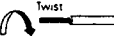
1. Peel off the sheath. 
2. Twist the wires. 

Connecting the front speaker terminals

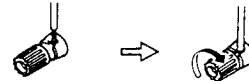
1. Loosen by turning counterclockwise. 
2. Insert the cord and tighten by turning clockwise. 

Connecting banana plugs

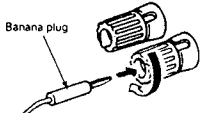

Turn clockwise to tighten, then insert the banana plug.

- **Speaker Impedance**
 - When speaker systems A and B are used separately, speakers with an impedance of from 8 to 16 Ω/ohms can be connected.
 - Be careful when using two pairs of speakers (A + B) at the same time, since use of speakers with an impedance outside the range of 12 to 16 Ω/ohms will lead to damage.
 - The protection circuit may operate or damage may occur when speakers with an impedance outside of the above range are used.

ANTENNA INSTALLATION

- **FM ANTENNA**
The supplied indoor FM antenna can be used inside wooden houses for receiving local FM stations and other strong FM signals. Stretch out the ends of the antenna and mount the antenna on the wall or ceiling where optimum reception is achieved. A indoor FM antennas may not consistently ensure stable reception due to environmental changes. In such cases, the indoor FM antenna should only be used temporarily until an outdoor FM antenna has been installed. When connecting an outdoor FM antenna, the use of 75 Ω/ohms coaxial cable (3C-2V, 5C-2V) is strongly recommended.

Note:
• Do not connect two FM antennas simultaneously.

- **AM LOOP ANTENNA**
Tune in an AM station, listen to the sound, then install the antenna in a position as far from the set as possible in which distortion and noise are minimum. Good reception of AM stations is not possible if the loop antenna is not connected or if it is touching metal objects.

USING THE VARIOUS FUNCTIONS

1. **Presetting stations in the memory**
The frequency and the name of the radio station (including names which you have input yourself), are also stored in the memory. In particular, the various RDS functions can be used effectively when RDS stations are stored in the memory.
How to preset the memory.
Press the MEMORY button (17). The "MEMO CH" indicator on the display flashes. Next, use SHIFT/PTY button (18) to select the memory block A, B, C, D or E. Now press the TUNING PRESET UP or DOWN button (16) to specify the preset channel number, and then press the MEMORY button (17) to store the station in the memory.
The preset channel numbers for the different memory blocks are as follows:
Memory block A 1 to 8
Memory block B 1 to 8
Memory block C 1 to 8
Memory block D 1 to 8
Memory block E 1 to 8
• The DRA-275R does not have a SHIFT/PTY button. Use the SHIFT button (18) instead.
2. **Auto Memory (FM only)**
The DRA-375RD/DRA-275R is equipped with an auto memory function. Connect the antenna, set it so that stations can be received, then hold in the MEMORY button and press the POWER button to turn the power on. Stations for which the auto tuning function operates are stored in the preset memory in the order A1 to AB, B1 to BB, and so on, through EB.
Channel A1 is tuned in after the auto memory operation is completed. Using this function makes it possible to find out the overall reception conditions of the receivable stations. The memory can be used effectively by recalling the channels in the preset memory and replacing stations whose reception is poor with stations whose reception is good, using the procedure described in 1) above.
3. **Recalling preset stations**
Use the SHIFT/PTY button (18) to select memory block A, B, C, D or E, then press the TUNING PRESET UP or DOWN button (16) to recall the station stored in the memory. If the TUNING PRESET UP or DOWN buttons are pressed without pressing the SHIFT/PTY button (18), the stations are recalled in the order A1 to AB, B1 to BB, and so on, through EB.
• The DRA-275R does not have a SHIFT/PTY button. Use the SHIFT button (18) instead.
4. **RDS search (for FM only) (DRA-375RD only)**
Use this function to automatically tune to stations offering Radio Data Service. This operation is also possible by pressing the TUNER button on the remote control unit once when the function is set to the TUNER mode.

Operation	Display
1. Press the RDS button (19) once.	RDS SEARCH ↓
2. Press the TUNING PRESET UP or DOWN button (16).	"RDS SEARCH" flashes on the display. (Preset memory channels A1 to EB are being searched.) If no RDS station is found with the above operation, all the reception bands are searched. The station name is displayed, when the RDS station is tuned. RDS search starts again.
3. Press the TUNER UP or DOWN button (15) again while the RDS mark is flashing.	If no other RDS station is found when all the frequencies are searched, "NO RDS" is displayed.

5. **PTY search (for FM only) (DRA-375RD only)**
Use this function to find stations broadcasting a designated type of programme type (PTY).
This operation is also possible by pressing the TUNER button on the remote control unit twice when the function is set to the TUNER mode. Next, press the PANEL button on the remote control unit, select the PTY category, then press the TUNING PRESET UP or DOWN buttons to start the PTY search function in the specified direction.

Operation	Display
1. Press the RDS button (19) twice.	PTY SEARCH ↓
2. Press the SHIFT/PTY button (18).	Programme type or PTY. Designated programme type (Always do this to designate the programme type if "PTY" is displayed in step 1.)
3. Press the TUNING PRESET UP or DOWN button (16).	"PTY SEARCH" flashes on the display. (Preset memory channels A1 to EB are being searched.) If there is no station broadcasting the designated programme type with the above operation, all the reception bands are searched. The station name is displayed after searching stops. PTY search starts again.
4. Press the TUNING PRESET UP or DOWN button again while the PTY mark is flashing.	If no other station broadcasting the designated programme type is found when all the frequencies are searched, "NO PROGRAMME" is displayed.

6. **TP search (for FM only) (DRA-375RD only)**
This function is used to find stations scheduled to broadcast traffic programmes (TP stations).
This operation is also possible by pressing the TUNER button on the remote control unit three times when the function is set to the TUNER mode.

Operation	Display
1. Press the RDS button (19) 3 times.	TP SEARCH ↓
2. Press the TUNING PRESET UP or DOWN button (16).	"TP SEARCH" flashes on the display. (Preset memory channels A1 to EB are being searched.) If no TP station is found with the above operation, all the reception bands are searched. The station name is displayed after searching stops. TP search starts again.
3. Press the TUNING PRESET UP or DOWN button again while the TP mark is flashing.	If no other TP station is found when all the frequencies are searched, "NO PROGRAMME" is displayed.

7. **RT (Radio Text) (for FM only) (DRA-375RD only)**
When the RT button (20) is pressed while the station currently tuned in is offering a radio text message service, the message scrolls on the display. (The RT indicator lights when the RT button is pressed.)

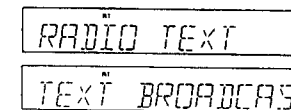

(If "NO TEXT DATA" is displayed if no radio text message is being broadcast.)

8. Writing station names

You can write in station names yourself (Up to 8 characters) (Refer to the table of characters on page 12)

- | Operation | Display |
|---|-------------------------|
| 1 Press the RDS button 4 times. | First space flashes |
| 2 Use the TUNER UP and DOWN buttons ⬆ to select the desired characters | First letter flashes |
| 3 Use the SHIFT/PTY button Ⓢ to move to the next place | Specified place flashes |
| 4 After writing the entire station name, store it in the memory (Refer to page 7) | |

- * The DRA-275R does not have an RDS button. Use the CHARACTER button **Ⓢ** instead.
- * The DRA-275R does not have a SHIFT/PTY button. Use the SHIFT button **Ⓢ** instead.

Each operation should be completed while the specified place is flashing

NOTE: This unit may not identify RDS stations as such if the paging station provides multiple RDS data. Tuning may not stop at such stations during the RDS search and PTY search operations.

RDS Emergency Alert

"ALERT" will flash on the display when the unit receives the Emergency Programme Type Code (PTY3) from an RDS station. This feature may not operate properly if the signal from the RDS station is too weak or is subjected to interference. It is not possible to select the "ALERT" display from the PTY search mode.

- * The following programme types (PTY) can be designated:

NEWS	News	SOFT	Soft
INFORMATION	Information	NOSTALGIA	Nostalgia
SPORTS	Sports	JAZZ	Jazz
TALK	Talk	CLASSICAL	Classical
ROCK	Rock	R + B	R & B
CLS ROCK	Classic Rock	SOFT R+B	Soft R & B
ADULT HITS	Adult Hits	LANGUAGE	Language
SOFT ROCK	Soft Rock	REL MUSIC	Religious Music
TOP 40	Top 40	REL TALK	Religious Talk
COUNTRY	Country	PERSONALITY	Personality
OLDBIES	Oldies	PUBLIC	Public

Table of characters

The characters are input in the order shown to the right. Use the TUNER UP/DOWN buttons **⬆** to select the desired characters.

A B C D E F G H I J K L M N O P Q R S T U V W X Y Z
0 1 2 3 4 5 6 7 8 9 () * + , - . : ; SPACE

9. Clearing station names

1. Recall the station name you want to clear.
2. Press the RDS button 4 times until the character at the first place flashes.
3. Then press the SHIFT/PTY button for at least 2 seconds. The current station name will then be cleared.

- * The DRA-275R does not have an RDS button. Use the CHARACTER button instead.
- * The DRA-275R does not have a SHIFT/PTY button. Use the SHIFT button instead.

Note: Station names MUST be stored in a preset memory to be retained. If the power is turned off, or if the band (AM/FM) is changed, the station name will be lost. Be sure to store the entered station name in a Preset Memory before changing the band or turning the power switch OFF.

RDS Emergency Alert Feature

The RDS Emergency Alert Feature is activated by a signal sent at the sole discretion of the RDS broadcaster. The RDS Emergency Alert Feature is included in this product for the convenience of the consumer, and is not intended to augment or replace the Official Emergency Broadcast System as administered by the Federal Communications Commission. For this reason, Nippon Columbia Co. and its Subsidiaries, including but not limited to DENON America, Inc. and DENON Canada, Inc., refuse all Warranties, claims of merchantability or fitness, or liabilities, whether incidental, consequential or otherwise, related to, either directly or indirectly, the operation or lack of operation of this feature. This exclusion applies to any and/or all Nippon Columbia Co. Products, whether present or future, that implement, in any form or variation, the RDS Emergency Alert Feature.

PLAYBACK USING THE REMOTE CONTROL

The accessory RC-812 remote control unit is used to control the RECEIVER from a distance.

(1) Inserting the dry cell batteries

1. Remove the rear cover on the remote control unit.

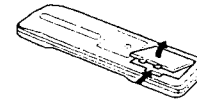

2. Insert two size "AA" (R6) dry cell batteries as shown in the diagram on the battery supply unit.

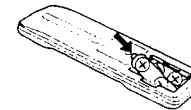

3. Close the rear cover.

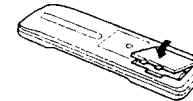

(2) Directions for use

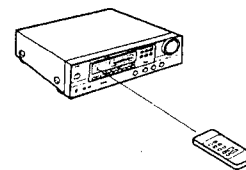

Notes on Use of the Batteries

- The remote control unit uses size "AA" (R6) dry cell batteries.
- The batteries will need to be replaced approximately once a year. This will depend upon how often the remote control is used.
- If, in less than a year from the time new batteries were inserted, the remote control fails to operate the receiver from a near-by position, it is time to replace the batteries.
- Insert the batteries properly, following the diagram on the remote control battery supply unit, and making sure to align the plus and minus sides of each battery.
- Batteries are prone to damage and leakage. Therefore:
 - Do not combine new batteries with used ones.
 - Do not combine different types of batteries.
 - Do not jumper the opposite poles of the batteries, expose them to heat or break them open, or put them into open fire.
- When the remote control is not to be used for a long period of time, remove the batteries from the unit.
- If the batteries have leaked, remove any battery fluid from the inside of the battery supply unit by wiping it out thoroughly, and insert new batteries.

- Operate the remote control unit while pointing it towards the remote control sensor on the receiver as shown in the diagram left.
- The remote control unit can be used at distances up to about 7 meters/20 feet in a straight line from the receiver. This distance will decrease if there are obstructions blocking the infra-red light transmission or if the remote control unit is not directed straight at the receiver.

Note on Operation

- Do not press the operating buttons on the receiver and the remote control unit at the same time. This will cause misoperation.
- Operation of the remote control unit will become less effective or erratic if the infrared remote control sensor on the receiver is exposed to strong light or if there are obstructions between the remote control unit and the sensor.
- In case you operate your VCR, TV or other components by remote control, do not operate buttons on two different remote control units at the same time. This will cause misoperation.

Besides being able to operate the DRA-375RD/275R receiver with this remote control unit, you can also operate a DENON cassette deck and CD player from this handy full-system remote control unit.

Remote Control Section
Full-system Remote Control Unit

The full-system remote control unit operates all major functions of the receiver such as function switching, volume control, and preset station selection. But that's not all! The same control pad can also control the major functions of a DENON CD player and cassette deck to create a remarkably ergonomic and versatile DENON system with all the quality sound reproduction that the devoted audiophile expects.

Remote Control Unit RC-812 supplied with DRA-375RD/275R

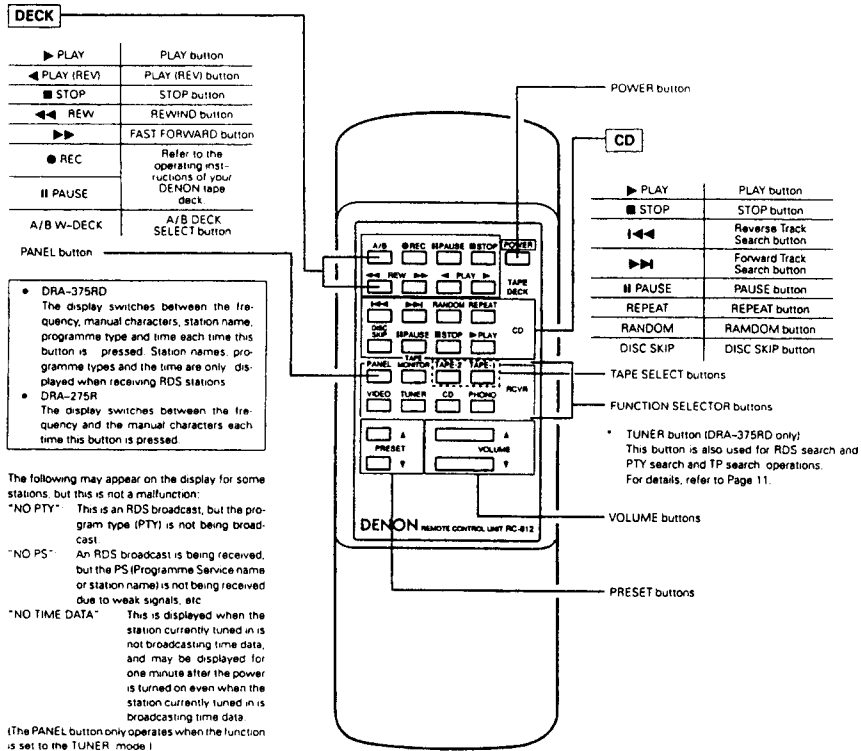

- The RC-812 Remote Control Unit can control CD players and cassette decks made by DENON.
- Note that operation may not be possible for some models.
- Buttons are conveniently separated into groups, each group controlling one specific component. The groups are RECEIVER, CD and DECK.

For details on operating other components, refer to the instruction manuals for the CD player and/or cassette deck.

CAUTION:

- If the power is turned off with the remote control unit, the receiver is switched to the power stand-by state. If you are to be absent for a long period of time, be sure to turn the power off using the POWER switch on the receiver.
- A part of 1st digit of fluorescent display light while the receiver is in the power stand-by state.
- You may experience erratic operation of the remote control unit if it is operated in fluorescent light and direct sunlight, in particular if this light strikes the remote control sensor on the receiver. However, this is not a malfunction, and if this should happen, protect the sensor against such light.

TROUBLESHOOTING

- Have all connections been made PROPERLY?
- Have you followed all operational instructions correctly?
- Are the speakers, turntable, and other components operating properly?

When your unit does not seem to be operating correctly, first check the items in the following table. If the symptom does not correspond to any of the problems as shown below, turn off the power sources immediately and contact your DENON dealer.

Problem	Cause	Remedy
FM AND AM RECEPTION		
Radio program can not be received	<ul style="list-style-type: none"> Antenna connection is wrong A signal strength is weak 	<ul style="list-style-type: none"> Check the connection Check the antenna installation
Noise is reproduced	<ul style="list-style-type: none"> A signal strength is weak Automobile ignition noise interferes with reception Other electrical equipment interferes with reception 	<ul style="list-style-type: none"> Install an outdoor antenna Keep the antenna away from the street Keep the equipment away from this set, or turn off the power of the other equipment
The preset frequencies are erased	<ul style="list-style-type: none"> The memory back-up term (about 1 month) passed 	<ul style="list-style-type: none"> Preset again
In automatic tuning, the frequency doesn't stop at the radio station	<ul style="list-style-type: none"> A signal strength is weak 	<ul style="list-style-type: none"> Use manual tuning
In automatic tuning, it stops at the one step lower or higher frequency than the radio station	<ul style="list-style-type: none"> Noise or strong signal strength is received 	<ul style="list-style-type: none"> Use manual tuning for optimum reception
PLAYBACK OF THE AUDIO EQUIPMENTS		
No sound is produced with power on	<ul style="list-style-type: none"> Input and speaker cords connection are wrong Speaker switch is off The FUNCTION buttons are in wrong position The protective circuit is operating The fuse has blown out The power switch was set to OFF the last time the power was turned off from the remote control unit 	<ul style="list-style-type: none"> Check the connection Turn on speaker switch Check these position Turn the power off once, check the connections to the speakers, then turn the power on again Ask your dealer, or the nearest DENON representative Set the power switch to ON, then turn the power on from the remote control unit. Or, push the power switch on the front panel twice.
Audible hum when playing records	<ul style="list-style-type: none"> The input and grounding cords connection of the turntable are wrong The cords connection of the cartridge are wrong The interference from the nearby TV or radio transmission antenna 	<ul style="list-style-type: none"> Check the connection Check the connection Ask your dealer, or the nearest DENON representative
Howling is produced when the volume control is turned up too high while playing records	<ul style="list-style-type: none"> The vibrations and sounds transmit from the speakers to the turntable 	<ul style="list-style-type: none"> Insulate the vibrations, or keep the speakers away from the turntable
Cracking noise is produced when playing records	<ul style="list-style-type: none"> The record is stained with the dust The stylus tip of the cartridge is stained with the dust The cartridge is defective 	<ul style="list-style-type: none"> Clean the record Clean the stylus tip Try the other cartridge

SPECIFICATIONS

AMPLIFIER SECTION

Continuous Power Output:	DRA-375RD: 60 watts per channel minimum RMS, both channels driven at 8 Ω /ohms from 20 Hz ~ 20 kHz no more than 0.05% total harmonic distortion. DRA-275R: 40 watts per channel minimum RMS, both channels driven at 8 Ω /ohms from 20 Hz ~ 20 kHz no more than 0.05% total harmonic distortion.
Power Bandwidth (IHF):	10 Hz ~ 40 kHz (T.H.D. 0.15% both channels driven into 8 Ω /ohms)
Total Harmonic Distortion:	0.03% (-3 dB at rated output, 8 Ω /ohms)
Frequency Response:	PHONO RIAA Standard Curve (Recording Output) MM 20 Hz ~ 20 kHz \pm 0.5 dB CD, VIDEO, 20 Hz ~ 50 kHz \pm 1.5 dB TAPE-1, (at 1W) TAPE-2/VCR
Input Sensitivity and Impedance:	PHONO MM 2.5 mV 47 k Ω /k ohms CD, VIDEO, 150 mV 47 k Ω /k ohms TAPE-1, TAPE-2/VCR
Maximum Input Level (at 1 kHz):	PHONO MM 180 mV
Signal to Noise Ratio (IHF-A):	PHONO MM 78 dB (at 5.0 mV input) CD, VIDEO, 95 dB TAPE-1, TAPE-2/VCR
Tone Controls:	BASS \pm 10 dB at 100 Hz TREBLE \pm 10 dB at 10 kHz
Loudness, Control Effect:	VARIABLE LOUDNESS 50 Hz/10 kHz, +10 dB/+5 dB

VIDEO SECTION

Input terminal:	VCR-IN, VIDEO 1 V _{p-p} /75 Ω /ohms
Output terminal:	VCR-OUT, MONITOR 1 V _{p-p} /75 Ω /ohms
Frequency response:	5 Hz ~ 6 MHz \pm 1.5 dB

TUNER SECTION

(FM) (note: μV at 75 Ω/ohms, 0 dBf = 1×10^{-15} W)	
Receiving Range:	87.50 ~ 108.00 MHz
Usable Sensitivity:	0.9 μ V (10.3 dBf)
50 dB Quieting Sensitivity:	MONO 1.6 μ V (15.3 dBf) STEREO 23 μ V (38.5 dBf)
Signal to Noise Ratio (IHF-A):	MONO 82 dB STEREO 78 dB
Total Harmonic Distortion (at 1 kHz):	MONO 0.1% STEREO 0.15%
Capture Ratio:	1.5 dB
Image Rejection:	42 dB
AM Suppression:	50 dB
Selectivity (\pm 400 kHz):	55 dB
Frequency Response:	30 Hz ~ 15 kHz \pm 0.5 dB
Stereo Separation (at 1 kHz):	40 dB
[AM]	
Receiving Range:	520 ~ 1710 kHz
Usable Sensitivity:	18 μ V
Signal to Noise Ratio:	55 dB

GENERAL

Power Supply:	AC 120V 60 Hz
Power Consumption:	2.6 A (DRA-375RD) 2.3 A (DRA-275R)
Dimensions:	434 mm (17-3/32")W \times 142 mm (5-19/32")H \times 315 mm (12-25/64")D (DRA-375RD) 434 mm (17-3/32")W \times 142 mm (5-19/32")H \times 315 mm (12-25/64")D (DRA-275R)
Weight:	6.6 kg (14 lbs 9 oz) (DRA-375RD) 5.8 kg (12 lbs 13 oz) (DRA-275R)

REMOTE CONTROL UNIT

Remote control system:	RC-812 Infrared pulse system
Power supply:	3V DC Two size "AA" (R6) dry cell batteries
External dimensions:	60 mm (2-23/64")W \times 175 mm (6-57/64")H \times 18 mm (45/64")D
Weight:	120 g (4 oz) (Includes batteries)

Design and specifications are subject to change without prior notice.

DISASSEMBLY

(To reassemble reverse disassembly)

● Top Cover

Remove 4 screws ① and 4 screws ② then detach the Top Cover as shown in the figure.

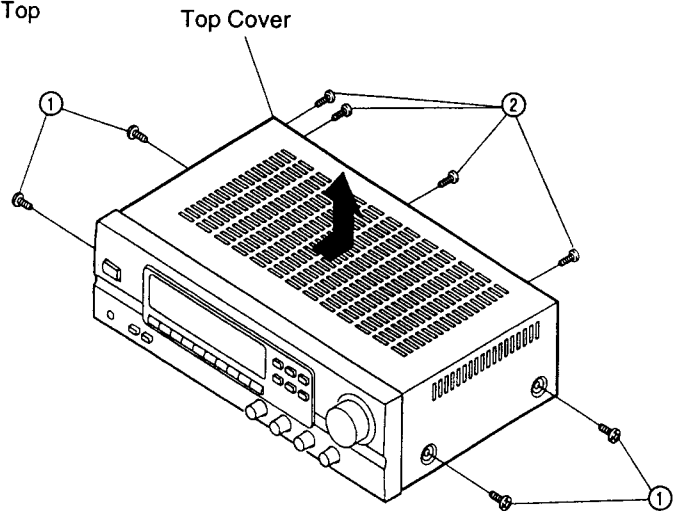

● Front Panel

- 1) Remove 2 screws ③ and 5 screws ④.
- 2) Pull out 5 knobs ⑤ and unfasten 5 nuts ⑥, and detach the Front Panel as shown in the arrow direction.

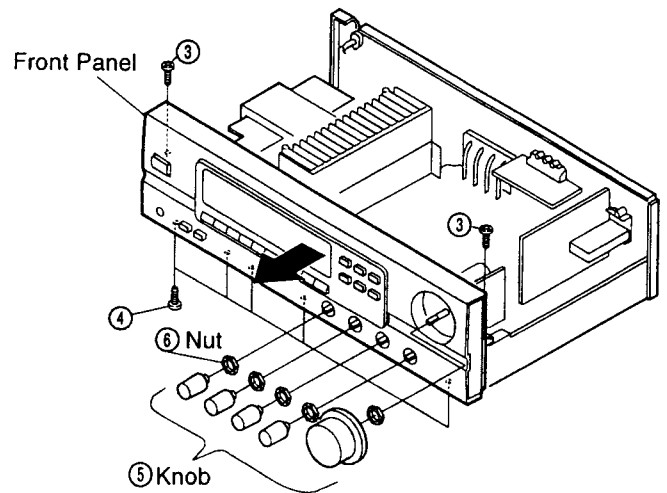

● Rear Panel

- 1) Pull out the cord bush ⑦, as shown in the arrow direction.
- 2) Remove 10 screws ⑧ and 7 screws ⑨, then detach the Rear Panel in the arrow direction.

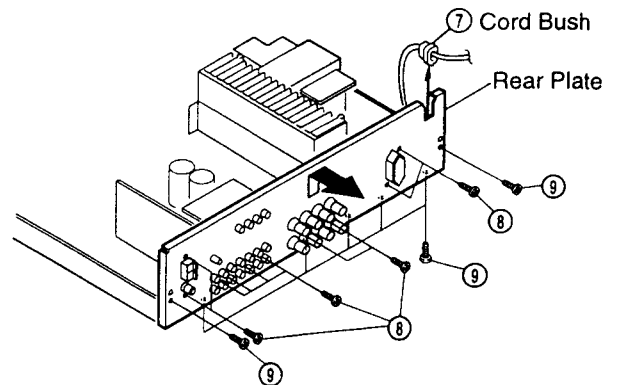

WIRE ARRANGEMENT

In case of wires require unclasping or loosening to move the location to perform adjustment or part replacement, be sure to rearrange them neatly to restore properly in the same location as they were originally placed, or causing to produce a noise may occasionally occur.

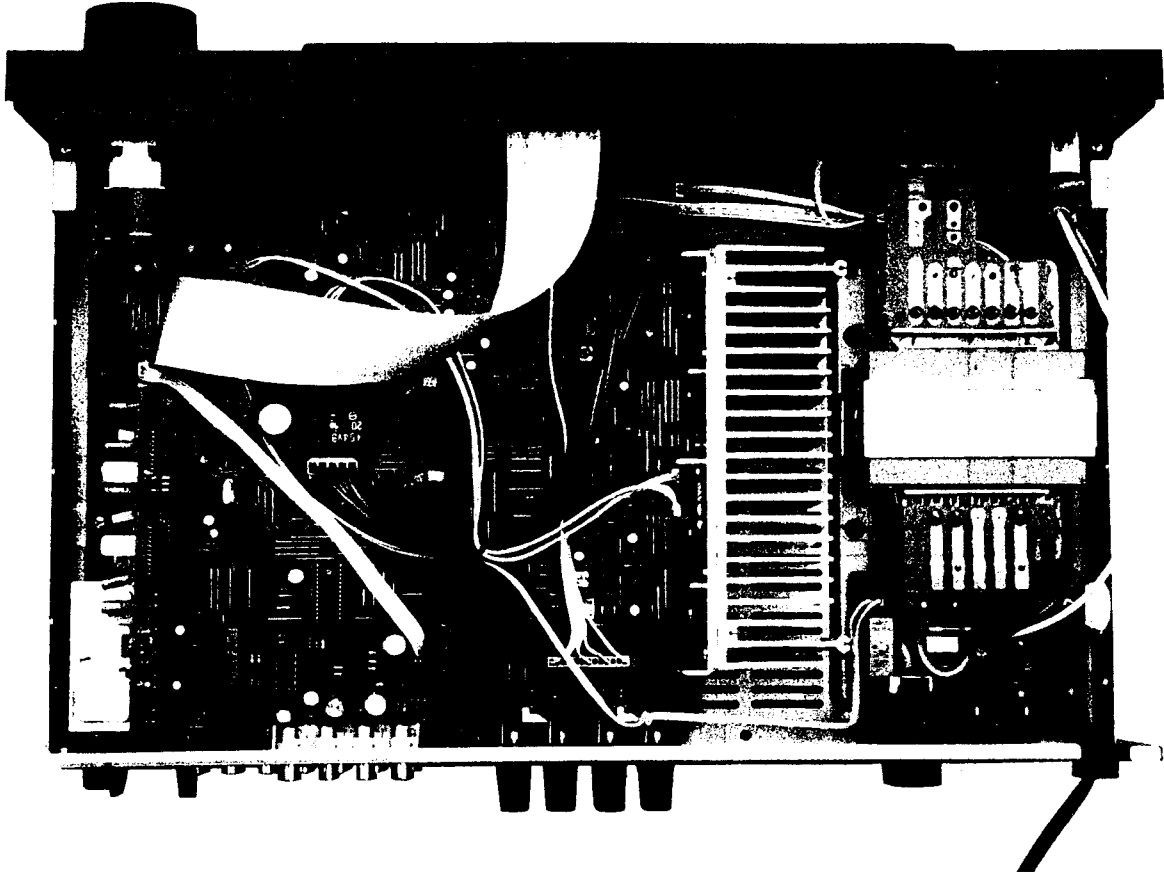

METHOD OF ADJUSTMENTS

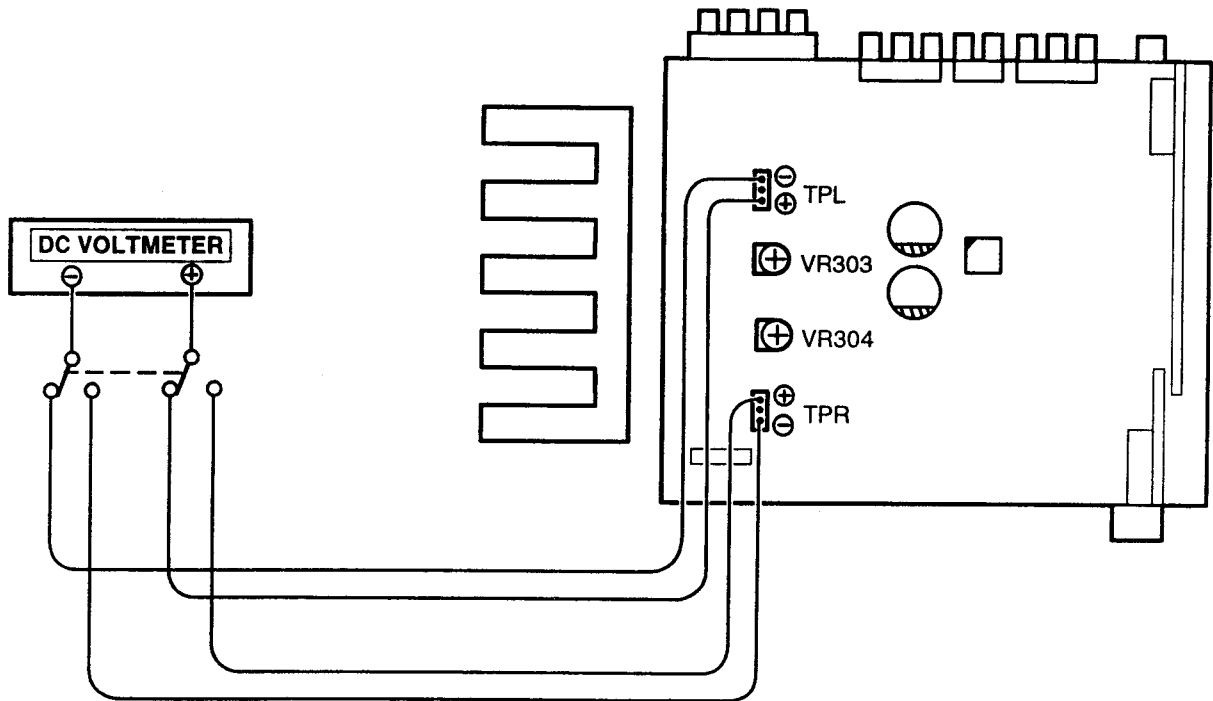

IDLING CURRENT

(1) Set controls as follows.

POWER Switch	→ off (■)
VOLUME Control	→ 0 (min)
SPEAKERS	→ off (■)
Temperature	→ 15°C ~ 30°C (59°F ~ 86°F)
VR303 and VR304	→ min. (↺)

(2) Connect DC Voltmeter to the TPL (Lch) and TPR (Rch).

(3) Turn the Power Switch on and rotate VR303 clockwise so that the DC Voltmeter reads 3 mV \pm 0.5 mV DC at the TPL. Follow the same procedure to VR304 for TPR.

CONNECTION DIAGRAM OF MEASURING INSTRUMENTS

● FM SECTION

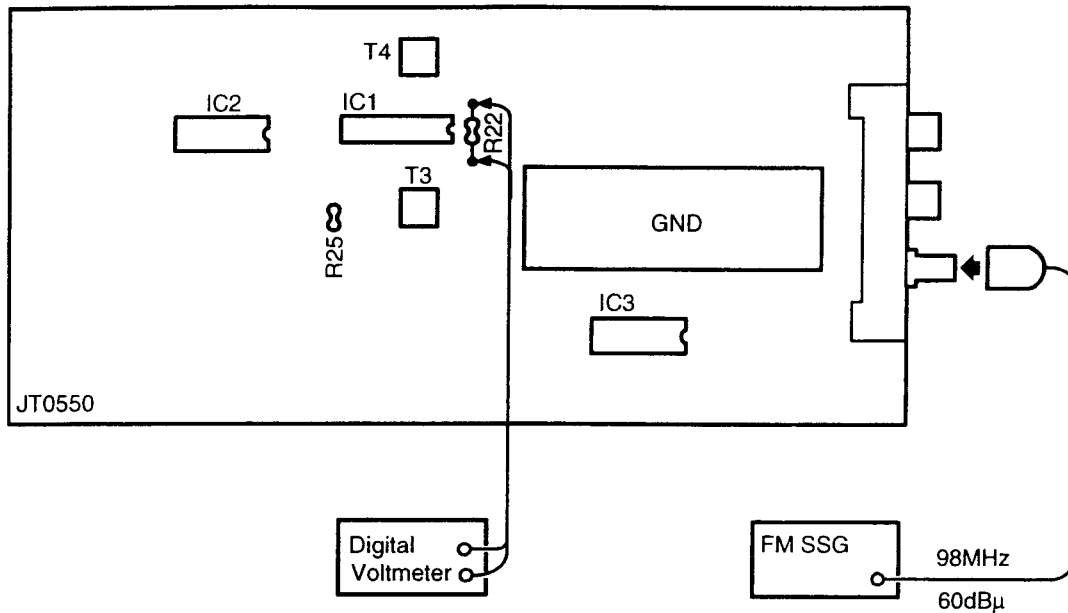

Adjust T4 potential difference across R22 should be within 30mV.

● Initiating (Memory clearing) Method

To clear memory contents of microcomputer and restore to the initial state, take the following steps;

- (1) Press power switch, turn off power of the unit.
- (2) Disconnect AC power cord from wall outlet temporarily.
- (3) Insert power cord into outlet while simultaneously pressing two keys of TUNER and VIDEO SELECT.
- (4) Press power switch to confirm that memory contents are cleared.

By completion of the above, the initial state is restored. In case the memory can not be cleared due to some reasons, repeat steps 1 through 3.

Note: If the Power does not turn on and nothing is displayed except STAND-BY LED even after the above item #4 is performed, the unit may stay remained in the STAND-BY Mode. In such a case, please refer to the Operating Manual, item "POWER" of the "NAME AND FUNCTION OF PARTS" for details.

BLOCK/LEVEL DIAGRAM (DRA-375RD/275RD/275R)

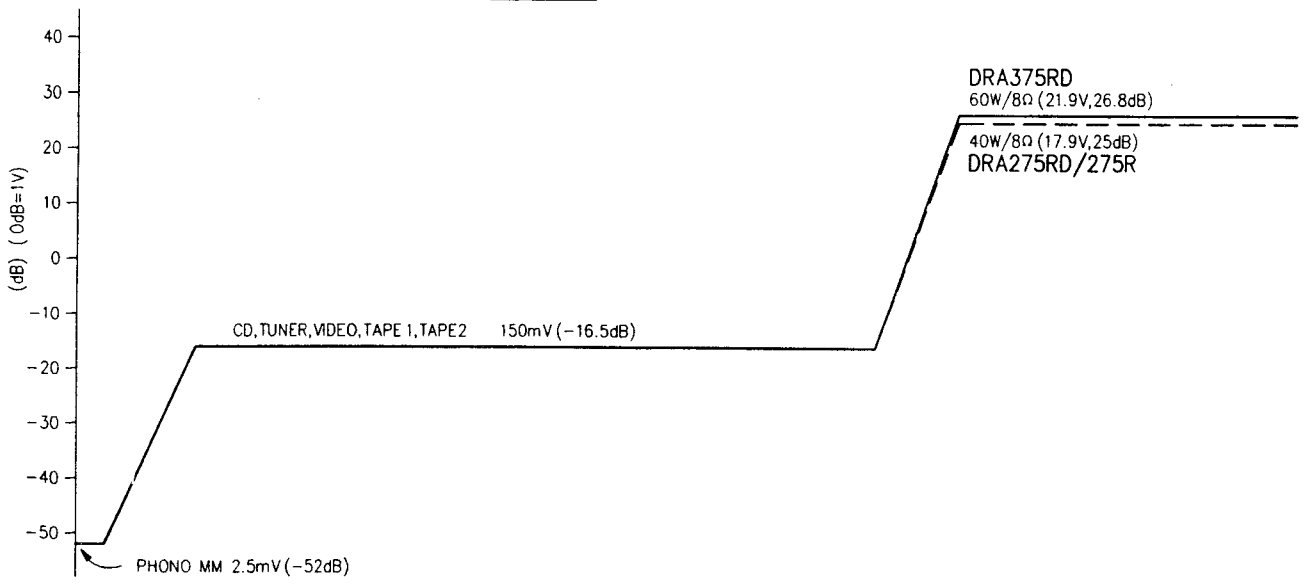
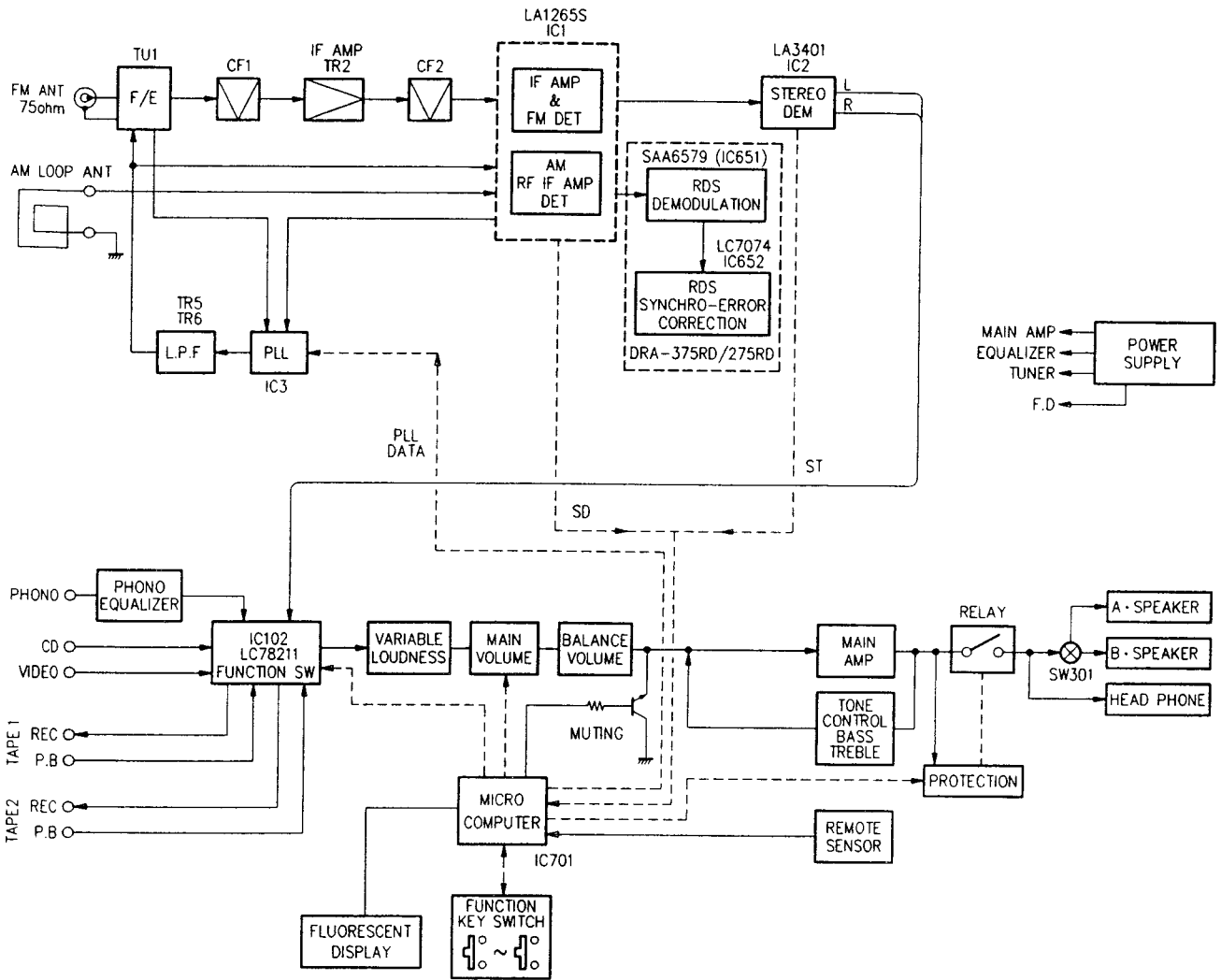

SEMICONDUCTORS

● IC's

TMP87CM71F (IC701)

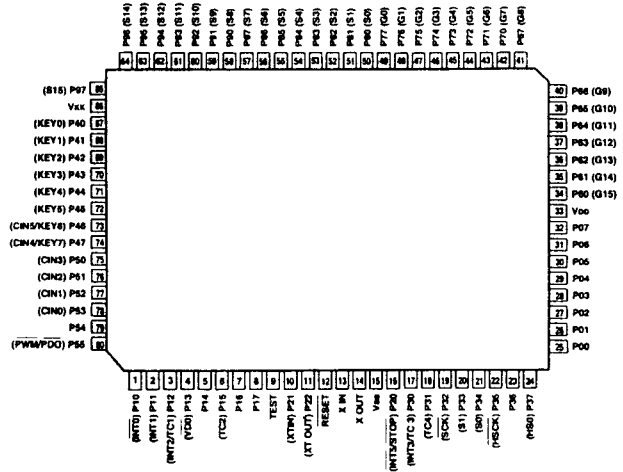
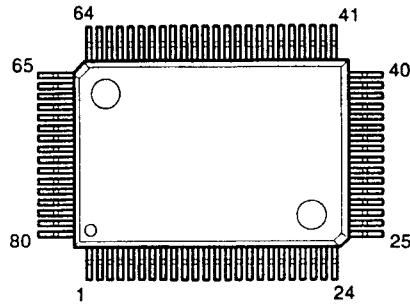

TMP87CM71F Port Allocation Table

Pin No.	Symbol	I/O	Logic	Initial Setting	Function
1	STOP	I	L	—	Power down detection ("L" = at power down).
2	MUTE (A)	I	—	—	MUTE (A) output ("H" = MUTE)
3	RDS	I	Serial	—	RDS data (start) input.
4	RES	O	L	H	LC7074 reset output.
5	GND	I	Serial	—	Not used.
6	FCK	O	Serial	L	Function control output (LC7821) for F-CK.
7	FDA	O	Serial	L	Function control output (LC7821) for F-DATA.
8	F STB	O	H	L	Function control output (LC7821) for F-STB.
9	GND	I	—	—	Connect to GND.
10	SD	I	L	—	Tuned signal input ("L" = at tuned in).
11	GND	I	—	—	Not used.
12	RESET	I	L	—	Reset input.
13	XIN	I	—	—	Oscillation circuit (4MHz).
14	XOUT	O	—	—	Oscillation circuit (4MHz).
15	Vss	PW	—	—	GND
16	GND	I	—	—	GND
17	REM	I	L	—	Remote control signal input.
18	ST	I	L	—	Stereo signal input ("L" = at stereo).
19	RCK	I	Serial	—	RDS data (clock) input.
20	RDA	I	Serial	—	RDS data (data) input.
21	GND	I	—	—	Not used.
22	PCK	O	Serial	L	LM7001 control output for PLL-CK (CL).
23	PDA	O	Serial	L	LM7001 control output for PLL-DATA (DATA).
24	PSTB	O	H	L	LM7001 control output for PLL-STB (CE).
25	GND	O	—	L	GND
26	GND	O	—	L	GND
27	AM	O	L	L	AUTO/MANUAL control.
28	GND	I	—	—	Not used.
29	P O/F	O	H	L	Power control output ("H" = ON).
30	VR-UP	O	H	L	Power volume control output (LB1639 ON = at "H").
31	VR-D	O	H	L	Power volume control output (LB1639 ON = at "H").
32	SP-R	O	H	L	Speaker relay control output (ON = at "H").
33	VDD	PW	—	—	+5V
34	GND	I	—	—	GND
35	GND	I	—	—	GND
36	1G	O	—	—	FL tube control output for 1G.
37	2G	O	—	—	FL tube control output for 2G.
38	3G	O	—	—	FL tube control output for 3G.
39	4G	O	—	—	FL tube control output for 4G.

Pin No.	Symbol	I/O	Logic	Initial Setting	Function
40	5G	O	—	—	FL tube control output for 5G.
41	6G	O	—	—	FL Tube control output for 6G.
42	7G	O	—	—	FL Tube control output for 7G.
43	8G	O	—	—	FL Tube control output for 8G.
44	9G	O	—	—	FL Tube control output for 9G.
45	10G	O	—	—	FL Tube control output for 10G.
46	11G	O	—	—	FL Tube control output for 11G.
47	12G	O	—	—	FL Tube control output for 12G.
48	13G	O	—	—	FL Tube control output for 13G.
49	14G	O	—	—	FL Tube control output for 14G.
50	S0 (a)	O	—	—	FL Tube control output for P(a).
51	S1 (b)	O	—	—	FL Tube control output for P(b).
52	S2 (c)	O	—	—	FL Tube control output for P(c).
53	S3 (d)	O	—	—	FL Tube control output for P(d).
54	S4 (e)	O	—	—	FL Tube control output for P(e).
55	S5 (f)	O	—	—	FL Tube control output for P(f).
56	S6 (g)	O	—	—	FL Tube control output for P(g).
57	S7 (h)	O	—	—	FL Tube control output for P(h).
58	S8 (j)	O	—	—	FL Tube control output for P(j).
59	S9 (k)	O	—	—	FL Tube control output for P(k).
60	S10 (m)	O	—	—	FL Tube control output for P(m).
61	S11 (n)	O	—	—	FL Tube control output for P(n).
62	S12 (p)	O	—	—	FL Tube control output for P(p).
63	S13 (q)	O	—	—	FL Tube control output for P(q).
64	S14 (r)	O	—	—	FL Tube control output for P(r).
65	S15 (s)	O	—	—	FL Tube control output for P(s).
66	Vkk	PW	—	—	-15V
67					
68	GND	I	—	—	GND
69					
70					
71	VA	O	L	H	Video In/Out control ("L" = at selection) BV4066.
72	VB	O	L	H	Video In/Out control ("L" = at selection) BV4066.
73	K1	I	—	—	Key input (A/D conversion input).
74	K2	I	—	—	Key input (A/D conversion input).
75	K3	I	—	—	Key input (A/D conversion input).
76	K4	I	—	—	Key input (A/D conversion input).
77	VER	I	—	—	Forwarding country setting.
78	VER	I	—	—	Specification setting.
79	MUTE (T)	O	H	H	MUTE output ("H" = MUTE).
80	GND	I	—	—	GND

LA1265 (S)
(IC001)

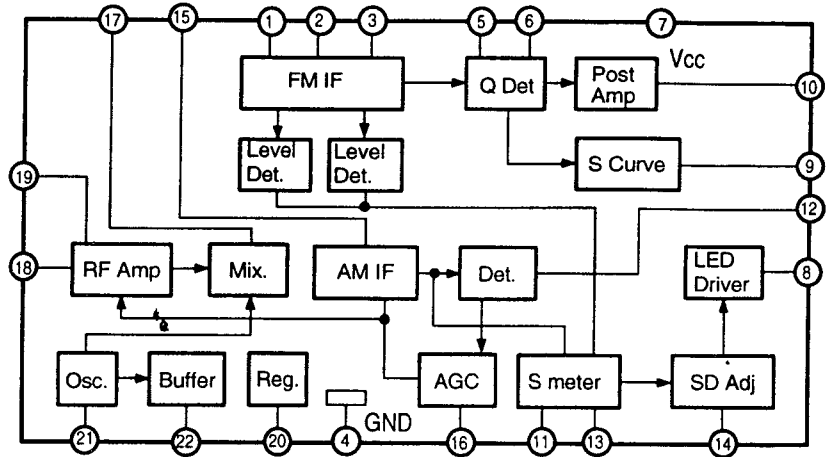
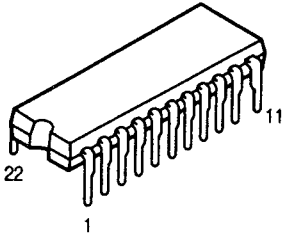

LA3401 (IC002)

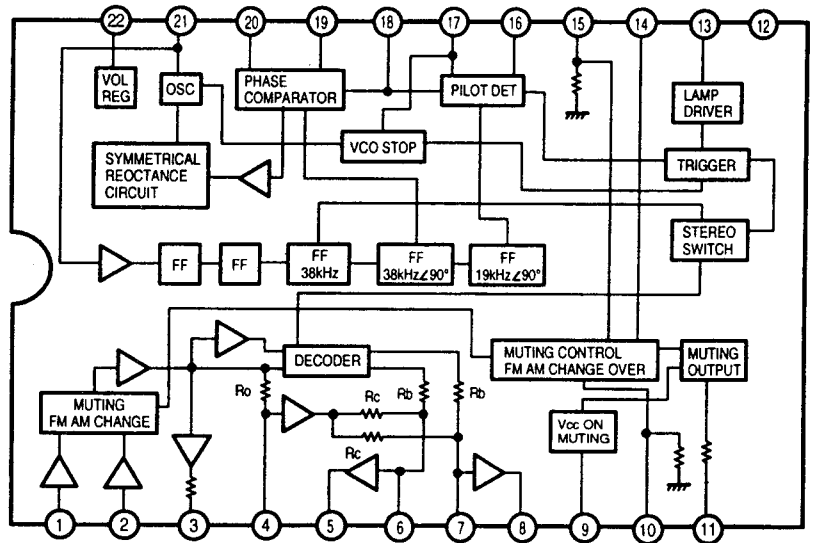
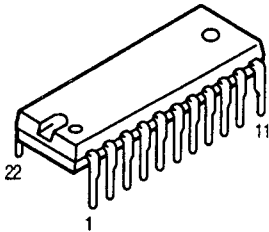

LM7001 (IC003)

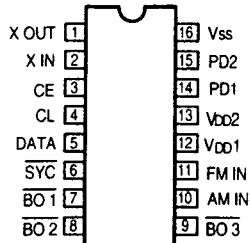
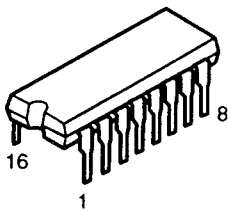

KIA7812PI (IC004)
KIA7806PI (IC401)

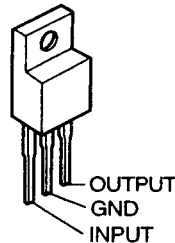

BA4558 (IC101)

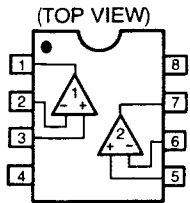
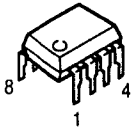

- 1: A Output
- 2: A -Input
- 3: A +Input
- 4: V⁻
- 5: B +Input
- 6: B -Input
- 7: B Output
- 8: V⁺

LA78211 (IC102)

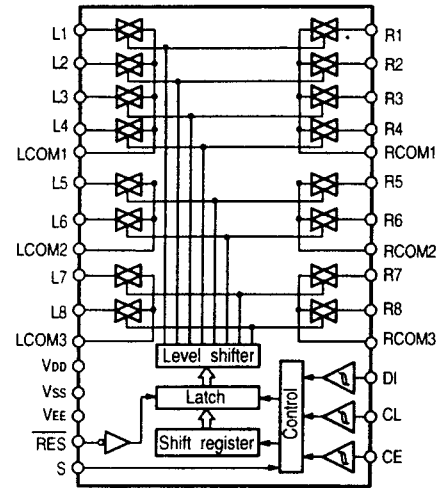
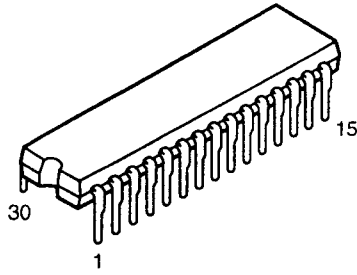

BA6208S (IC201)

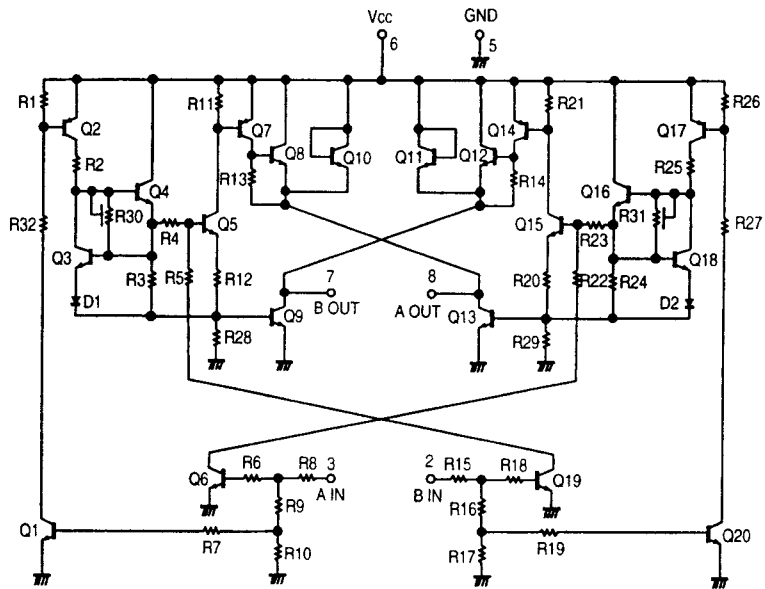
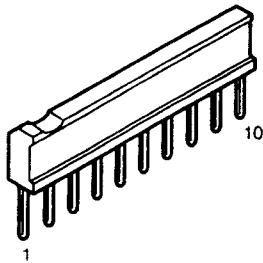

BA15218 (IC301)

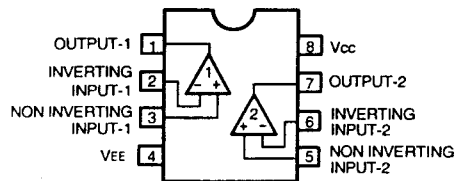
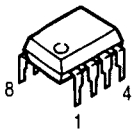

BU4066BC (IC601)

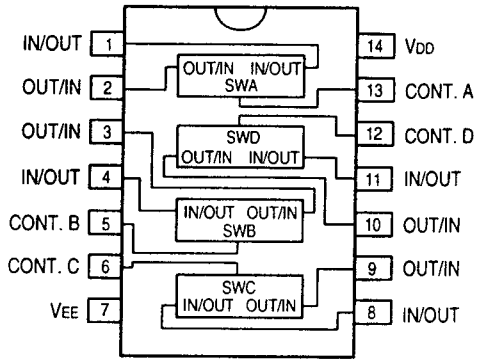
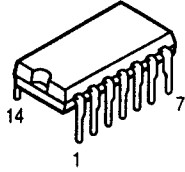

SAA6579T (IC651)

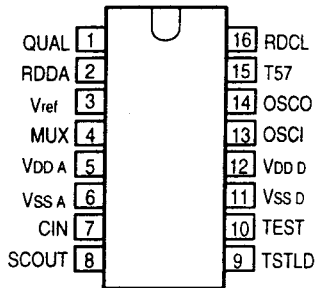

SAA6579T Terminal Function

Pin No.	Symbol	Function
1	QUAL	Quality indication output.
2	RDDA	RDS data output.
3	Vref	Reference voltage output (0.5 V _{DD A}).
4	MUX	Multiplex signal input.
5	VDD A	+5V power supply for analog part.
6	VSS A	Ground for analog part (0V).
7	CIN	Subcarrier input to comparator.
8	SCOUT	Subcarrier output of reconstruction filter.
9	TSTLD	Test control.
10	TEST	Test enable input.
11	VSS D	Ground for digital part (0V).
12	VDD D	+5V power supply for digital part.
13	OSCI	Oscillator input.
14	OSCO	Oscillator output.
15	T57	57kHz clock signal output.
16	RDCL	RDS clock output.

LC7074M (IC652)

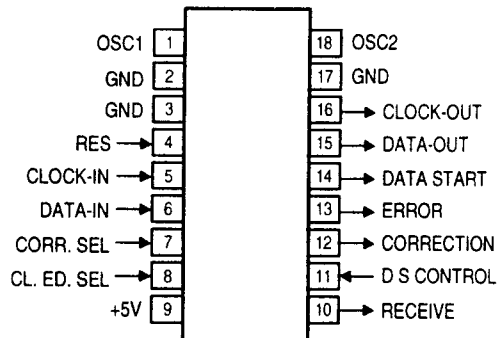
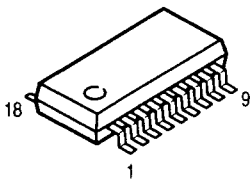

● TRANSISTORS

2SA988 (E/F)
2SC945P
2SC1815 (Y)
2SC1841 (E/F)
2SA1015 (GR)
2SC1815 (GR)

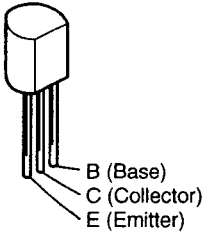

2SB647A (C)

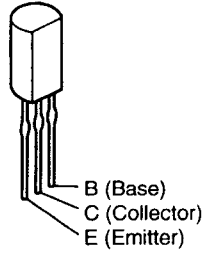

2SA933S (S)
2SC1740S (E)
2SC1740S (S)
2SC2058S (Q)

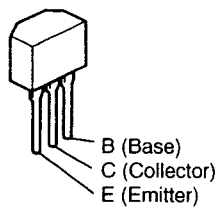

2SB1328 (P)
2SD2004 (P)

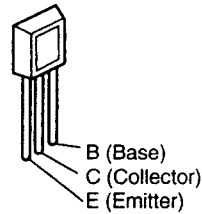

HIT5610 (C)

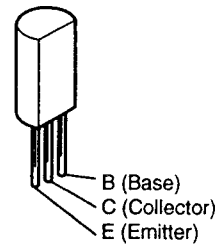

2SK365 (BL/GR)

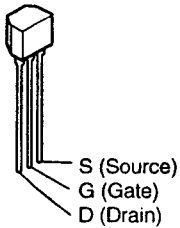

DTA114ES
DTC143ES
DTC144ES
DTC144TS
DTC323TS
RN-1241

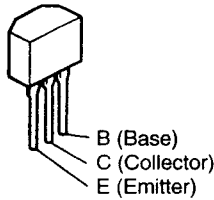

PNP Type

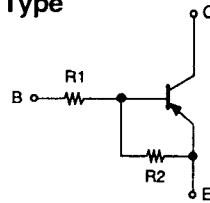

NPN Type

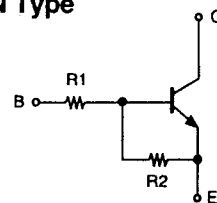

	R1	R2
DTA114ES	10 kohm	10 kohm

	R1	R2
DTC143ES	4.7 kohm	4.7 kohm
DTC144ES	47 kohm	47 kohm
DTC144TS	47 kohm	—
DTC323TS	2.2 kohm	—
RN1241	5.6 kohm	—

2SA1633 (E/F)
2SC4278 (E/F)

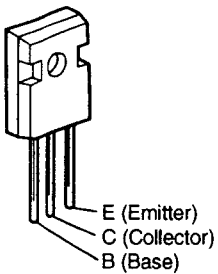

2SB1655

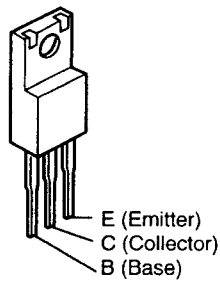

2SD2061

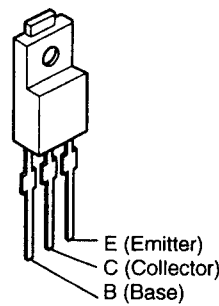

2SK161

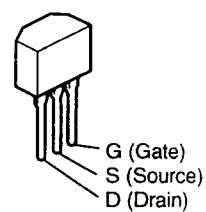

● DIODES & LED

IN4148

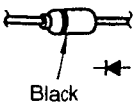

IN4002

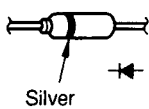

HZ27-04 HZ7B1
HZ3C2 HZ7C3
HZ6C2 HZ9A3

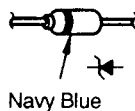

S4VB20

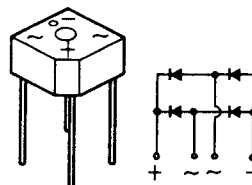

SFOR1A42

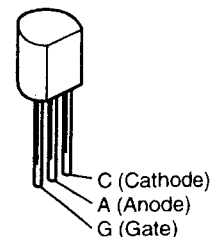

SBX1910-52 (RM701)

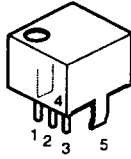

- 1. Vcc
- 2. Output
- 3. GND
- 4. Case Fin
- 5. Case Fin

FLD (14BT48GK)

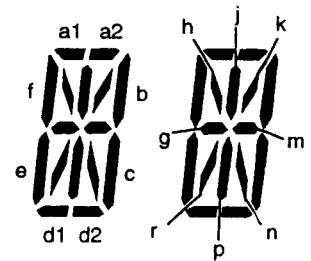
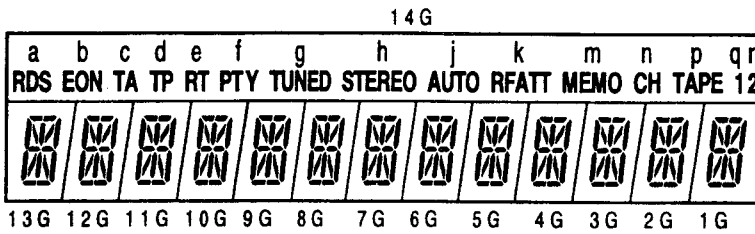
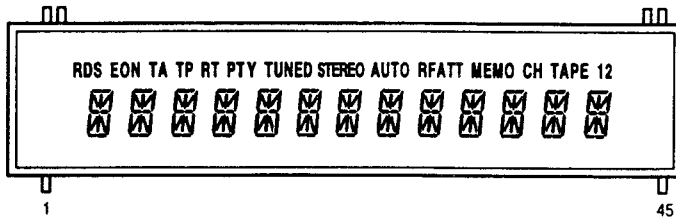

PIN CONNECTION

Pin No.	1	2	3	4	5	6	7	8	9	10	11	12	13	14	15	16	17	18	19	20	21	22	23	24	25	26	27	28	29	30
Connection	F1	F1	NP	NP	NC	NC	NC	NC	NC	NC	NC	P16	P15	P14	P13	P12	P11	P10	P9	P8	P7	P6	P5	P4	P3	P2	P1	14G	13G	12G

Pin No.	31	32	33	34	35	36	37	38	39	40	41	42	43	44	45
Connection	11G	10G	9G	8G	7G	6G	5G	4G	3G	2G	1G	NP	NP	F2	F2

- Note
- 1) F1, F2 ----- Filament
 - 2) NP ----- No pin
 - 3) NC ----- No connection
 - 4) DL ----- Datum line
 - 5) 1G-14G ----- Gird

ANODE CONNECTION

	14G	13G	12G	11G	10G	9G	8G	7G	6G	5G	4G	3G	2G	1G
P1	RDS	a1	a1	a1	a1	a1	a1	a1	a1	a1	a1	a1	a1	a1
P2	EON	a2	a2	a2	a2	a2	a2	a2	a2	a2	a2	a2	a2	a2
P3	TA	b	b	b	b	b	b	b	b	b	b	b	b	b
P4	TP	c	c	c	c	c	c	c	c	c	c	c	c	c
P5	RT	d2	d2	d2	d2	d2	d2	d2	d2	d2	d2	d2	d2	d2
P6	PTY	d1	d1	d1	d1	d1	d1	d1	d1	d1	d1	d1	d1	d1
P7	TUNED	e	e	e	e	e	e	e	e	e	e	e	e	e
P8	STEREO	f	f	f	f	f	f	f	f	f	f	f	f	f
P9	AUTO	j	j	j	j	j	j	j	j	j	j	j	j	j
P10	RFATT	k	k	k	k	k	k	k	k	k	k	k	k	k
P11	MEMO	m	m	m	m	m	m	m	m	m	m	m	m	m
P12	CH	n	n	n	n	n	n	n	n	n	n	n	n	n
P13	TAPE	p	p	p	p	p	p	p	p	p	p	p	p	p
P14	1	r	r	r	r	r	r	r	r	r	r	r	r	r
P15	2	g	g	g	g	g	g	g	g	g	g	g	g	g
P16	—	h	h	h	h	h	h	h	h	h	h	h	h	h

PRINTED WIRING BOARD

1 2 3 4 5 6 7 8

MAIN UNIT

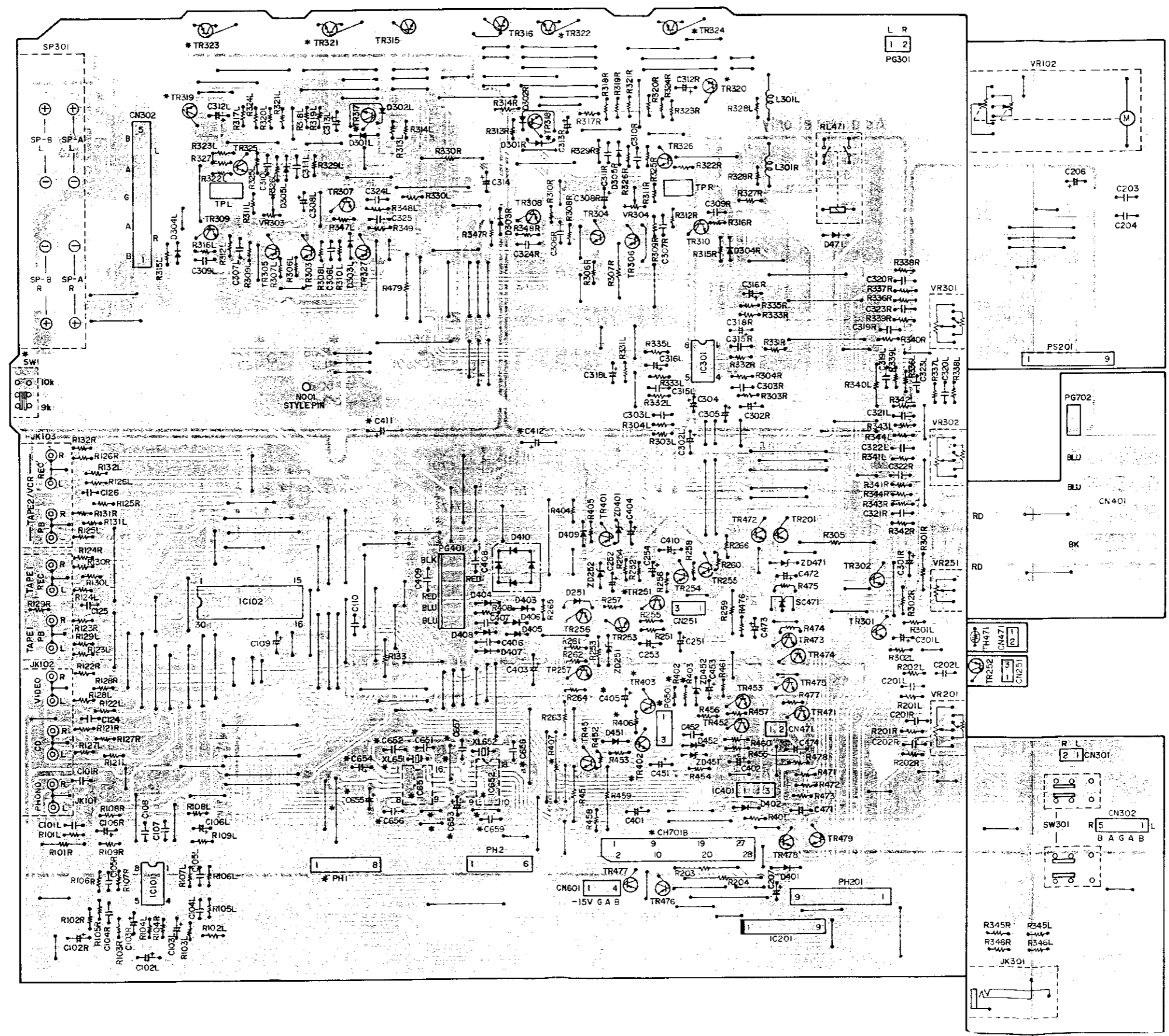

A
B
C
D
E

1 2 3 4 5 6 7 8

DISPLAY UNIT

A

B

C

D

E

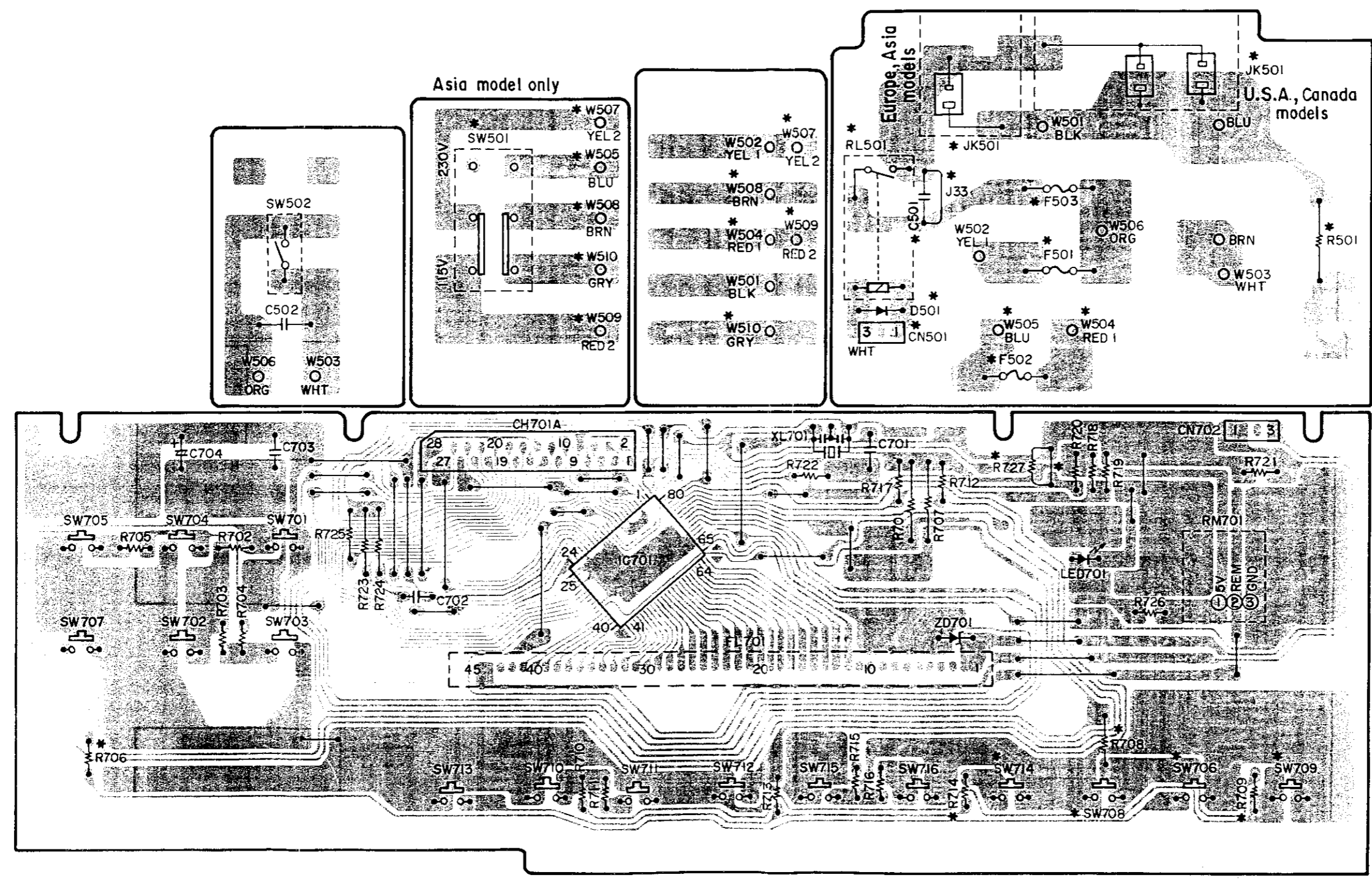

1 2 3 4

TUNER UNIT

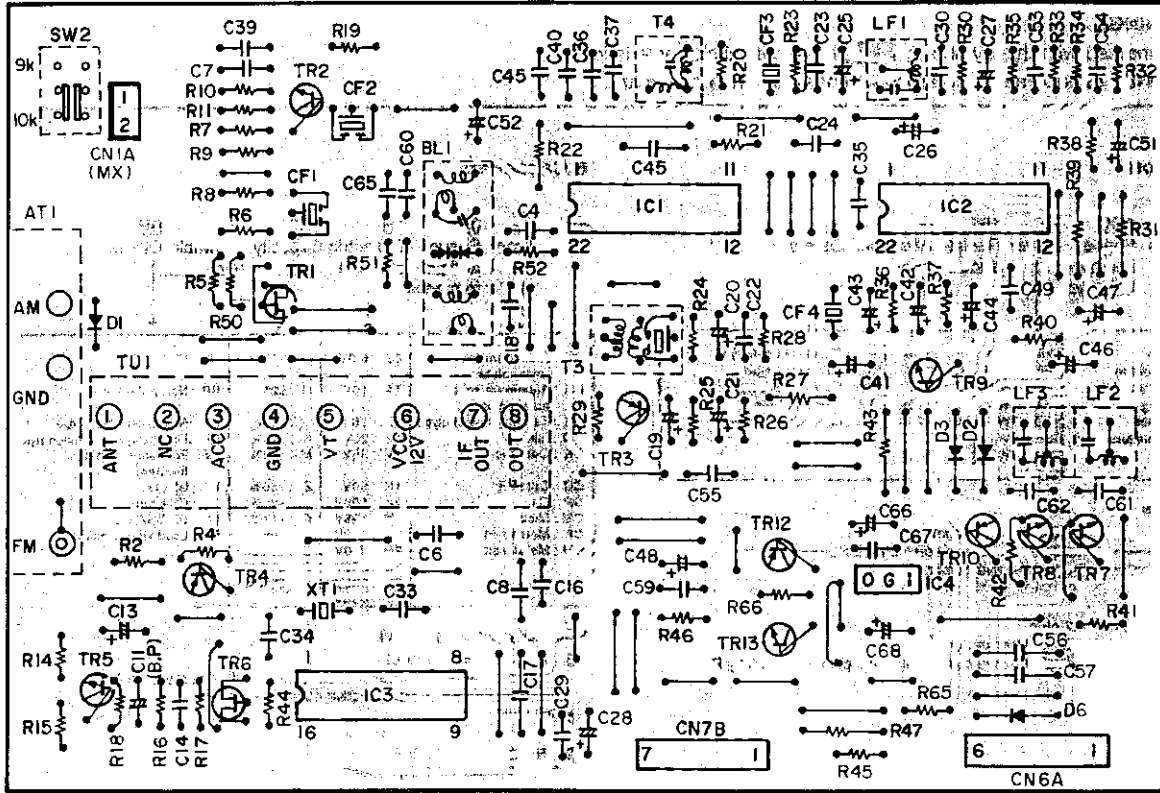

VIDEO JACK UNIT

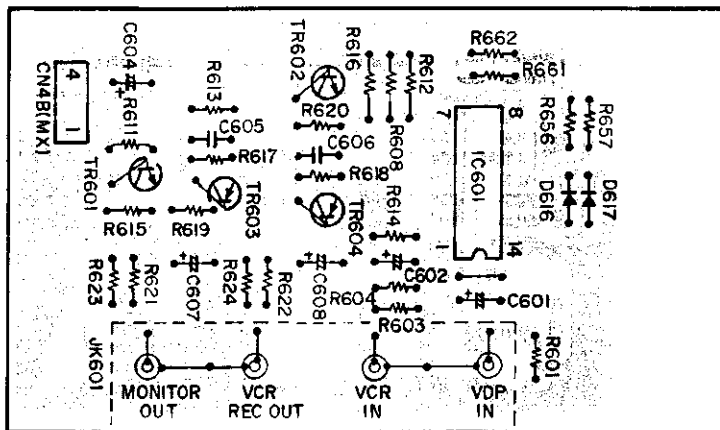

A

B

C

D

E

NOTE FOR PARTS LIST

- Part indicated with the mark "⊗" are not always in stock and possibly to take a long period of time for supplying, or in some case supplying of part may be refused.
- When ordering of part, clearly indicate "1" and "1" (i) to avoid mis-supplying.
- Ordering part without stating its part number can not be supplied.
- Part indicated with the mark "★" is not illustrated in the exploded view.
- Not including Carbon Film ±5%, 1/4W Type in the P.W.Board parts list. (Refer to the Schematic Diagram for those parts.)

WARNING:

Parts marked with this symbol  have critical characteristics.
Use ONLY replacement parts recommended by the manufacturer.

● Resistors

Ex.: **BN** **14K** **2E** **182** **G** **FR**
 Type Shape Power Resist- Allowable Others
 and per- ance error

RD : Carbon	2B : 1/8W	F : ±1%	P : Pulse-resistant type
RC : Composition	2E : 1/4W	G : ±2%	NL : Low noise type
RS : Metal oxide film	2H : 1/2W	J : ±5%	NB : Non-burning type
RW : Winding	3A : 1W	K : ±10%	FR : Fuse-resistor
RN : Metal film	3D : 2W	M : ±20%	F : Lead wire forming
RK : Metal mixture	3F : 3W		
	3H : 5W		

* Resistance

$1 \text{ } \underline{8} \text{ } 2 \Rightarrow 1800 \text{ ohm} = 1.8 \text{ kohm}$
 Indicates number of zeros after effective number.
 2-digit effective number.

• Units: ohm

$1 \text{ } \underline{R} \text{ } 2 \Rightarrow 1.2 \text{ ohm}$
 1-digit effective number.
 2-digit effective number, decimal point indicated by R.

• Units: ohm

● Capacitors

Ex.: **CE** **04W** **1H** **2R2** **M** **BP**
 Type Shape Dielectric Capacity Allowable Others
 and per- strength error

CE : Aluminum foil electrolytic	0J : 6.3V	F : ±1%	HS : High stability type
CA : Aluminum solid electrolytic	1A : 10V	G : ±2%	BP : Non-polar type
CS : Tantalum electrolytic	1C : 16V	J : ±5%	HR : Ripple-resistant type
CQ : Film	1E : 25V	K : ±10%	DL : For charge and discharge
CK : Ceramic	1V : 35V	M : ±20%	HF : For assuring high frequency
CC : Ceramic	1H : 50V	Z : +80%	U : UL part
CP : Oil	2A : 100V	-20%	C : CSA part
CM : Mica	2B : 125V	P : +100%	W : UL-CSA type
CF : Metallized	2C : 160V	-0%	F : Lead wire forming
CH : Metallized	2D : 200V	C : ±0.25pF	
	2E : 250V	D : ±0.5pF	
	2H : 500V	= : Others	
	2J : 630V		

* Capacity (electrolyte only)

$2 \text{ } \underline{2} \text{ } 2 \Rightarrow 2200\mu\text{F}$
 Indicates number of zeros after effective number.
 2-digit effective number.

• Units: μF.

$2 \text{ } \underline{R} \text{ } 2 \Rightarrow 2.2\mu\text{F}$
 1-digit effective number.
 2-digit effective number, decimal point indicated by R.

• Units: μF.

* Capacity (except electrolyte)

$2 \text{ } \underline{2} \text{ } 2 \Rightarrow 2200\text{pF} = 0.0022\mu\text{F}$
 (More than 2) — Indicates number of zeros after effective number.
 2-digit effective number.

• Units: pF.

$2 \text{ } \underline{2} \text{ } 1 \Rightarrow 220\text{pF}$
 (0 or 1) — Indicates number of zeros after effective number.
 2-digit effective number.

• Units: pF.

• When the dielectric strength is indicated in AC, "AC" is included after the dielectric strength value.

PRINTED WIRING BOARD PARTS LIST

MAIN UNIT

Ref. No.	Part No.	Part Name	Remarks	Ref. No.	Part No.	Part Name	Remarks
SEMICONDUCTORS GROUP				RESISTORS GROUP (Not included Carbon Film \pm 5% 1/4W)			
IC101	263 0322 004	IC BA4558		TR471-473	273 0303 910	Transistor 2SC1740S (S)	
IC102	9L2 3016 92W	IC LC78211		TR474	271 0192 002	Transistor 2SA933 (S)	
IC201	263 0927 001	IC BA6208S		TR475	273 0303 910	Transistor 2SC1740S (S)	
IC301	263 0565 007	IC BA15218		TR476,477	269 0046 003	Transistor DTA114ES	
IC401	9LC P024 12	IC KIA7806PI		TR478,479	269 0040 009	Transistor DTC144ES	
IC651	262 1872 000	IC SAA6579T	(DRA-375) Except Asia model	D251	276 0375 002	Diode 1N4148 or 1N4531	
IC651	262 1872 000	IC SAA6579T	(DRA-275) Europe and U.K. models	D301L,301R	276 0375 002	Diode 1N4148 or 1N4531	
IC652	9LC K044 71	IC LC7074M	(DRA-375)Except Asia model	D302L,302R	276 0375 002	Diode 1N4148 or 1N4531	
IC652	9LC K044 71	IC LC7074M	(DRA-275) Europe and U.K. models	D303L,303R	276 0375 002	Diode 1N4148 or 1N4531	
TR201	269 0022 904	Transistor DTA143ES		D304L,304R	276 0375 002	Diode 1N4148 or 1N4531	
TR251	9L2 3184 33	Transistor 2SD2061F	(DRA-375)	D305L,305R	276 0375 002	Diode 1N4148 or 1N4531	
TR251	274 0151 000	Transistor 2SD2004 (P)	(DRA-275)	D401	276 0375 002	Diode 1N4148 or 1N4531	
TR252	9LC F013 21	Transistor 2SB1655E		D402-408	916 0053 008	Diode 1N4002	
TR253	273 0388 906	Transistor 2SC1740S (E)		D409	276 0375 002	Diode 1N4148 or 1N4531	
TR254	271 0192 002	Transistor 2SA933S (S)		D410	276 0338 007	Diode S4VB20	
TR255	273 0235 020	Transistor 2SC1841 (E/F)		D451,452	276 0375 002	Diode 1N4148 or 1N4531	
TR256	271 0131 021	Transistor 2SA988 (E/F)		D471	276 0375 002	Diode 1N4148 or 1N4531	
TR257	273 0388 906	Transistor 2SC1740S (E)		ZD251,252	276 0303 003	Zenar diode HZ6C2	6V
TR301,302	269 0107 900	Transistor RN1241		ZD401	9L2 3321 61M	Zenar diode HZ27-04	27V
TR303,304	273 0235 020	Transistor 2SC1841 (E/F)		ZD451	276 0299 007	Zenar diode HZ3C2	3.3V
TR305-308	271 0131 021	Transistor 2SA988 (E/F)		ZD452	276 0051 041	Zenar diode HZ7B1	6.8V
TR309,310	273 0235 020	Transistor 2SC1841 (E/F)		ZD471	276 0051 083	Zenar diode HZ7C3	7V
TR315,316	9L2 3294 53T	Transistor 2SC945P		SC471	9LC J001 81	Thyristor SF0R3G42	
TR317,318	274 0151 000	Transistor 2SD2004 (P)	(DRA-375)	TH471	9LC J001 51	Thermister	
TR317,381	274 0060 007	Transistor 2SD667A (C)	(DRA-275)	RESISTORS GROUP (Not included Carbon Film \pm 5% 1/4W)			
TR319,320	272 0107 003	Transistor 2SB1328 (P)	(DRA-375)	R265,266	241 2387 940	Carbon film 4.7ohm 1/4W	RD14B2E4R7JNB
TR319,320	272 0053 005	Transistor 2SB647A (C)	(DRA-275)	R315L,315R	241 2369 065	Carbon film 620ohm 1/4W	RD14B2E621JNB
TR321,322	273 0430 003	Transistor 2SC4278 (E/F)	(DRA-375)	R316L,316R	241 2321 074	Carbon film 150ohm 1/4W	RD14B2E151JNB
TR321,322	273 0387 004	Transistor 2SC3853	(DRA-275)	R317L,317R	241 2321 045	Carbon film 220ohm 1/4W	RD14B2E221JNB
TR323,324	271 0276 009	Transistor 2SA1633 (E/F)	(DRA-375)	R318L,318R	9LA T010 12R	Meta oxide 0.22ohm 1W	RS14B3AR22JNB
TR323,324	271 0239 004	Transistor 2SA1489	(DRA-275)	R319L,319R	9LA T010 12R	Meta oxide 0.22ohm 1W	RS14B3AR22JNB
TR325,326	273 0235 020	Transistor 2SC1841 (E/F)		R320L,320R	9LA T010 12R	Meta oxide 0.22ohm 1W	RS14B3AR22JNB
TR327	271 0131 021	Transistor 2SA988 (E/F)		R321L,321R	9LA T010 12R	Meta oxide 0.22ohm 1W	RS14B3AR22JNB
TR401	272 0053 005	Transistor 2SB647A (C)		R324L,324R	241 2321 003	Carbon film 1kohm 1/4W	RD14B2E102JNB
TR402,403	273 0303 910	Transistor 2SC1740S (S)	(DRA-375)	R325L,325R	241 2321 003	Carbon film 1kohm 1/4W	RD14B2E102JNB
TR451	273 0388 906	Transistor 2SC1740S (E)		R329L,329R	241 2387 940	Carbon film 4.7ohm 1/4W	RD14B2E4R7JNB
TR452	269 0018 002	Transistor DTC143ES		R345L,345R	244 0032 005	Metal oxide 180ohm/1W	RS14B3A181JNB
TR453	273 0388 906	Transistor 2SC1740S (E)		R346L,346R	244 0032 005	Metal oxide 180ohm/1W	RS14B3A181JNB
				R347L,347R	241 2369 065	Carbon film 620ohm 1/4W	RD14B2E621JNB
				R348L,348R	241 2321 074	Carbon film 150ohm 1/4W	RD14B2E151JNB

Ref. No.	Part No.	Part Name	Remarks
R401	241 2387 940	Carbon film 4.7ohm 1/4W	RD14B2E4R7JNB
R403	241 2321 074	Carbon film 150ohm 1/4W	RD14B2E151JNB (DRA-375)
R404	241 2322 031	Carbon film 100ohm 1/4W	RD14B2E101JNB
R471	244 0042 008	Metal oxide 1.2kohm/1W	RS14B3A122JNB
R473	244 0049 001	Metal oxide 4.7kohm/1W	RS14B3A472JNB
R408	241 2322 060	Carbon film 1ohm 1/4W	RD14B2E010JNB
VR102	9L0 1579 02	Variable 100kohm	VOL
VR201	9LA Y001 84	Variable 100kohm	LOUD
VR251	9LA Y001 87	Variable 250kohm	BAL
VR301	9LA Y001 85	Variable 100kohm	BASS
VR302	9LA Y001 86	Variable 50kohm	TREBLE
VR303.304	9L0 1603 23	Semi fixed 5kohm	
CAPACITORS GROUP			
C101L,101R	253 1179 026	Ceramic 150pF/50V	CK45B1H151K
C102L,102R	254 4256 907	Electrolytic 10μF/25V	CE04W1E100M
C103L,103R	254 4254 022	Electrolytic 33μF/16V	CE04W1C330M
C104L,104R	255 1069 006	Film 0.0056μF/50V	CQ93M1H562K
C105L,105R	255 1120 026	Film 0.0015μF/50V	CQ93M1H152J
C106L,106R	254 4256 907	Electrolytic 10μF/25V	CE04W1E100M
C107,108	253 1025 002	Ceramic 0.022μF/50V	CK45F1H223Z
C109	254 4256 059	Electrolytic 220μF/25V	CE04W1E221M
C110	253 1025 002	Ceramic 0.022μF/50V	CK45F1H223Z
C124-126	253 1025 002	Ceramic 0.022μF/50V	CK45F1H223Z
C201L,201R	255 1076 002	Film 0.022μF/50V	CQ93M1H223K
C202L,202R	253 1055 014	Ceramic 560pF/50V	CK45B1H561K
C203	253 1025 002	Ceramic 0.022μF/50V	CQ93M1H223K
C204	254 3056 946	Electrolytic 4.7μF/50V BP	CE04D1H4R7MBP
C206	254 4260 948	Electrolytic 1μF/50V	CE04W1H010M
C207	254 4256 033	Electrolytic 47μF/25V	CE04W1E470M
C251-254	254 4256 907	Electrolytic 10μF/25V	CE04W1E100M
C301L,301R	254 4260 948	Electrolytic 1μF/50V	CE04W1H010M
C302L,302R	254 4260 029	Electrolytic 0.33μF/50V	CE04W1HR33M
C303L,303R	253 1055 069	Ceramic 100pF/50V	CC45SL1H101J
C304,305	254 4260 948	Electrolytic 1μF/50V	CE04W1H010M
C306L,306R	9L0 8900 61R	Ceramic 10pF/50V	CC45SL1H100D
C307L,307R	9L0 8900 61R	Ceramic 10pF/50V	CC45SL1H100D
C308L,308R	254 4260 948	Electrolytic 1μF/50V	CE04W1H010M
C309L,309R	255 1084 007	Film 0.1μF/50V	CQ93M1H104K
C310L,310R	255 1076 002	Film 0.022μF/50V	CQ93M1H223K
C311L,311R	255 1084 007	Film 0.1μF/50V	CQ93M1H104K
C312L,312R	254 4262 001	Electrolytic 4.7μF/63V	CE04W1J4R7M
C313L,313R	254 4262 001	Electrolytic 4.7μF/63V	CE04W1J4R7M
C314	254 4260 948	Electrolytic 1μF/50V	CE04W1H010M
C315L,315R	9L0 8900 61R	Ceramic 10pF/50V	CC45SL1H100D
C316L,316R	254 4254 022	Electrolytic 33μF/16V	CE04W1C330M
C318L,318R	254 4260 948	Electrolytic 1μF/50V	CE04W1H010M

Ref. No.	Part No.	Part Name	Remarks
C319L,319R	255 1077 001	Film 0.027μF/50V	CQ93M1H273K
C320L,320R	255 1085 006	Film 0.12μF/50V	CQ93M1H124K
C321L,321R	255 1258 079	Film 0.01μF/50V	CQ93M1H103J
C322L,322R	255 1120 026	Film 0.0015μF/50V	CQ93M1H152J
C323L,323R	253 1055 069	Ceramic 100pF/50V	CC45SL1H101J
C324L,324R	255 1084 007	Film 0.1μF/50V	CQ93M1H104J
C325	255 1258 079	Film 0.01μF/50V	CQ93M1H103J
C401	9L0 2845 82	Electrolytic 8.2μF/5.5V	
C402	254 4256 907	Electrolytic 10μF/25V	CE04W1E100M
C403	254 4257 003	Electrolytic 3300μF/25V	CE04W1E332M
C404	254 4260 948	Electrolytic 1μF/50V	CE04W1H010M
C405	254 4256 907	Electrolytic 10μF/25V	CE04W1E100M
C406,407	255 1258 079	Film 0.01μF/50V	CQ93M1H103J
C408,409	9W0 2445 09	Ceramic 4700pF/500V	
C410	254 4260 948	Electrolytic 1μF/50V	CE04W1H010M
C411,412	9LA L004 72	Electrolytic 8200μF/63V	(DRA-375)
C411,412	9LA L004 71	Electrolytic 8200μF/50V	(DRA-275)
C451	254 4260 074	Electrolytic 4.7μF/50V	CE04W1H4R7M
C452	9L0 8901 01R	Ceramic 0.01μF/16V	CK45B1C103J
C453	254 4260 948	Electrolytic 1μF/50V	CE04W1H010M
C471	254 4260 087	Electrolytic 10μF/50V	CE04W1H100M
C472	254 4260 993	Electrolytic 22μF/50V	CE04W1H220M
C473	254 4250 042	Electrolytic 330μF/6.3V	CE04W0J331M
C474	254 4254 938	Electrolytic 47μF/16V	CE04W1C470M
C651,652	253 3131 907	Ceramic 27pF/50V	CC45CH1H270J (DRA-375) Except Asia model (DRA-275) Europe and U.K. models
C653-655	254 4250 013	Electrolytic 47μF/6.3V	CE04W0J470M (DRA-375) Except Asia model (DRA-275) Europe and U.K. models
C656	253 1055 014	Ceramic 560pF/50V	CK45B1H561K (DRA-375) Except Asia model (DRA-275) Europe and U.K. models
C657,658	253 3614 000	Ceramic 30pF/50V	CC45SL1H300J (DRA-375)Except Asia model (DRA-275) Europe and U.K. models
C659	9L0 8901 01R	Ceramic 0.01μF/16V	CK45B1C103J (DRA-375)Except Asia model (DRA-275) Europe and U.K. models

TUNER UNIT

Ref. No.	Part No.	Part Name	Remarks	Q'ty
C661	9L0 8901 01R	Ceramic 0.01μF/16V	CK45B1C103J (DRA-375)Except Asia model (DRA-275) Europe and U.K. models	
OTHER PARTS GROUP				
SW001	9L2 6225 21	Slide switch	Asia model	
SW301	9LF E001 81	Speaker switch		
RL471	9L2 6413 21	Relay (24V)	SP mute	
XL651	9L2 1701 33	Crystal 4.332MHz	(DRA-375) Except Asia model	
XL651	9L2 1701 33	Crystal 4.332MHz	(DRA-275) Europe and U.K. models	
XL652	399 9018 003	Crystal 4.0MHz	(DRA-375) Except Asia model	
XL652	399 9018 003	Crystal 4.0MHz	(DRA-275) Europe and U.K. models	
L301L,301R	9L2 2273 63	Trap coil 1.1μH		
JK101	9LE R003 41	6P US pin jack		
JK102,103	9LE R003 51	4P US pin jack		
JK301	9LE Y005 01	Headphone jack		
SP301	9LE U003 81	Front SP terminal		
CH701B	9LE D007 91	24P FFC cable holder	(DRA-375) Asia model (DRA-265) U.S.A., Canada and Asia models	
CH701B	9LE D007 92	25P FFC cable holder	(DRA-275) U.K. model	
CH701B	9LE D007 95	28P FFC cable holder	(DRA-375) Except Asia model (DRA-275) Europe model	
	9LM A007 81	Heat sink bracket		1
	9LM F001 71	Insulation sheet		4
	9L8 6914 10	Screw 3x10 BH BT		6

Ref. No.	Part No.	Part Name	Remarks
SEMICONDUCTORS GROUP			
IC001	263 0891 001	IC LA12655	
IC002	263 0439 007	IC LA3401	
IC003	262 0719 009	IC LM7001	
IC004	9LC P024 16	IC KIA7812PI	
IC601	262 1873 009	IC BU4066BC	
TR001	275 0051 006	Transistor 2SK161	
TR002	273 0434 902	Transistor 2SC2058S (Q)	
TR003,004	269 0046 003	Transistor DTA114ES	
TR005	273 0198 002	Transistor 2SC1815 (Y)	
TR006	275 0053 907	Transistor 2SK365 (BL/GR)	
TR007,008	273 0372 909	Transistor DTC323TS	
TR009	269 0079 902	Transistor DTC144TS	
TR010	269 0080 904	Transistor DTA114TS	
TR011	272 0025 004	Transistor HIT5610C or 2SB562C	
TR012	269 0020 906	Transistor DTC144ES	
TR601,602	273 0325 901	Transistor 2SC1815 (GR)	
TR603,604	271 0186 005	Transistor 2SA1015 (GR)	
D001-003	276 0375 002	Diode 1N4531 or 1N4148	
D006	9L2 3980 62T	Diode 1N4001	
D616,617	276 0375 002	Diode 1N4531 or 1N4148	
CAPACITORS GROUP			
C004	253 4536 925	Ceramic 12pF/50V	CC45SL1H120J
C006	253 1174 018	Ceramic 0.01μF/16V	CC14Y1C103M Europe and U.K. models
C007,008	253 1174 018	Ceramic 0.01μF/16V	CC14Y1C103M
C011	254 3056 917	Electrolytic 1μF/50V BP	CE04D1H010MBP
C013	254 4260 906	Electrolytic 0.1μF/50V	CE04W1H0R1M
C014	253 1025 002	Ceramic 0.022μF/50V	CK45F1H223Z
C016	HMA 1000 159	Ceramic 100pF/50V	CC14B1H101K
C017,018	253 1174 018	Ceramic 0.01μF/16V	CC14Y1C103M
C019	254 4260 032	Electrolytic 0.47μF/50V	CE04W1HR47M
C020	254 4260 045	Electrolytic 1μF/50V	CE04W1H010M
C021	254 4260 087	Electrolytic 10μF/50V	CE04W1H100M
C022	253 1025 002	Ceramic 0.022μF/50V	CK45F1H223Z
C023	HMA 1000 159	Ceramic 100pF/50V	CC14B1H101K Except Europe and U.K. models
C024	255 1081 000	Film 0.056μF/50V	CQ93M1H563K
C025-027	254 4260 993	Electrolytic 22μF/50V	CE04W1H220M
C028	254 4260 045	Electrolytic 1μF/50V	CE04W1H010M
C029	253 1174 018	Ceramic 0.01μF/16V	CC14Y1C103M
C030	9L0 8900 32M	Ceramic 560pF/50V	CC14B1H561K Europe and U.K. models
C031,032	254 4260 087	Electrolytic 10μF/50V	CE04W1H100M
C033,034	253 3126 006	Ceramic 16pF/50V	CC45CH1H160J

DISPLAY UNIT

Ref. No.	Part No.	Part Name	Remarks
C035	255 1122 008	Film 0.047µF/50V	CQ93M1H473J
C036,037	253 1174 018	Ceramic 0.01µF/16V	CC14Y1C103M
C039	253 1174 018	Ceramic 0.01µF/16V	CC14Y1C103M
C040	254 4260 045	Electrolytic 1µF/50V	CE04W1H010M
C041	254 4256 033	Electrolytic 47µF/25V	CE04W1E470M
C042	254 4260 045	Electrolytic 1µF/50V	CE04W1H010M
C043	254 4196 012	Electrolytic 0.22µF/50V	CE04W1HR22M
C044	254 4260 045	Electrolytic 1µF/50V	CE04W1H010M
C045	253 1174 018	Ceramic 0.01µF/16V	CC14Y1C103M
C046,047	254 4260 951	Electrolytic 2.2µF/50V	CE04W1H2R2M
C048	254 4260 045	Electrolytic 1µF/50V	CE04W1H010M
C049	253 1174 018	Ceramic 0.01µF/16V	CC14Y1C103M
C051	254 4260 951	Electrolytic 2.2µF/50V	CE04W1H2R2M
C052	254 4260 087	Electrolytic 10µF/50V	CE04W1H100M
C053,054	253 1193 992	Ceramic 330pF/50V	CC14B1H331K Europe and U.K. models
C053,054	253 1194 933	Ceramic 680pF/50V	CC14B1H681K Except Europe and U.K. models
C055	253 1101 900	Ceramic 120pF/50V	CC45B1H121K Europe and U.K. models
C056,057	253 1174 018	Ceramic 0.01µF/16V	CC14Y1C103M
C059,060	253 1174 018	Ceramic 0.01µF/16V	CC14Y1C103M
C061,062	253 1159 961	Ceramic 4700pF/16V	CC14X1C472M Europe and U.K. models
C065	253 1174 018	Ceramic 0.01µF/16V	CC14Y1C103M
C601,602	254 4256 033	Electrolytic 47µF/25V	CE04W1E470M
C604	254 4254 789	Electrolytic 1000µF/16V	CE04W1C102M
C605,606	9L0 8900 05M	Ceramic 4.7pF/50V	CC14SL1H4R7K
C607,608	254 4252 079	Electrolytic 1000µF/10V	CE04W1A102M
OTHER PARTS GROUP			
BJ001	9LB H005 31	MW ANT coil	
T003	9LB J002 51	AM IF transformer	
T004	9L2 1370 33	FM DET transformer	
XT001	9L2 1701 32	Crystal 7.2MHz	
CF001	261 0064 007	Ceramic filter	Europe and U.K. models
CF001	261 0135 907	Ceramic filter	Except Europe and U.K. models
CF002	261 0064 007	Ceramic filter	Europe and U.K. models
CF002	261 0136 906	Ceramic filter	Except Europe and U.K. models
CF003	9LB P005 01	Ceramic filter	
CF004	9LB P004 91	Ceramic filter	
LF001	9L2 1363 13	L.P.F.	Europe and U.K. models
LF002,003	9L2 1363 14	L.P.F.	Europe and U.K. models
JK601	9LE R002 32	4P US pin jack	
AT001	9LE U000 11	ANT terminal board	
TU001	9LH H000 31	Tuner pack	Except Europe and U.K. models
TU001	9L2 4286 51	Tuner pack	Europe and U.K. models

Ref. No.	Part No.	Part Name	Remarks
SEMICONDUCTORS GROUP			
IC701	262 2249 001	IC TMP87CM71F-6348	
TR701	269 0020 906	Transistor DTC114ES	
D501	276 0375 002	Diode 1N4531 or 1N4148	(DRA-375) Except U.K. model
D701	276 0375 002	Diode 1N4531 or 1N4148	
ZD701	9W2 3318 23	Zenar diode HZ9A3	9V
LED701	9L2 3984 05	LED SLR54VC3F	Red
RM701	9LH N000 31	Receiving unit	(SBX1910-52)
RESISTORS GROUP (Not included Carbon Film ± 5% 1/4W)			
R501	9LH 1390 08	Metal oxide 2.2kohm 1/2W	RS14B2H222JNB
CAPACITORS GROUP			
△C501	253 8014 702	Ceramic 0.01µF/400V	CK45F2GAC103MC (DRA-375) Except U.K. model
△C502	253 8014 702	Ceramic 0.01µF/400V	CK45F2GAC103MC
C701	9L0 8901 01	Ceramic 0.01µF/16V	
C702	HMA 1000 159	Ceramic 100pF/50V	CC14B1H101K
C703	9L0 8901 01	Ceramic 0.01µF/16V	
C704	254 4213 034	Electrolytic 100µF/6.3V	CE04W0J101M
OTHER PARTS GROUP			
△SWS01	9LF G000 11	Voltage selector	Asia model
△SWS02	212 1103 004	Power switch TV-5	
SW701-707	9L2 6396 82R	Tact switch	
SW708	9L2 6396 82R	Tact switch	(DRA-375)Asia model (DRA-275) Except Europe and U.K. models
SW709	9L2 6396 82R	Tact switch	(DRA-375) Except Asia model (DRA-275) Europe and U.K. models
SW710-715	9L2 6396 82R	Tact switch	
△F501	9L2 7224 18	Fuse 5A, 125V	U.S.A. and Canada models
△F501	9L2 7216 13	Fuse T2A, 250V	Europe and U.K. models
△F503	9L2 7224 17	Fuse 4A, 125V	U.S.A. and Canada models
△F503	9L2 7216 12	Fuse T1.6A, 250V	Europe model

Ref. No.	Part No.	Part Name	Remarks
E501,502	9L2 7292 52R	Fuse holder	
E503,504	9L2 7292 52R	Fuse holder	Asia model
FL701	9LD D000 41	FL tube	
N701	9LN J017 11	FL holder	
CH701A	9LE D008 21	24P FFC cable holder	(DRA-375)Asia model
CH701A	9LE D008 21	24P FFC cable holder	(DRA-275) Except Europe and U.K. models
CH701A	9LE D008 25	28P FFC cable holder	(DRA-375) Except Asia model
CH701A	9LE D008 25	28P FFC cable holder	(DRA-275) Europe and U.K. models
W701	9LE K001 56	24P flat cable	(DRA-375) Asia model (DRA-275) Except Europe and U.K. models
W701	9LE K001 57	28P flat cable	(DRA-375) Except Asia model (DRA-275) Europe and U.K. models
JK501	9LE P000 91	AC outlet	Europe and Asia models
JK501	9LE Y004 91	AC outlet	U.S.A. and Canada models
RL501	9L2 6405 76	Relay	(DRA-375R) Except U.K. model
XL701	399 9018 003	Crystal 4.0MHz	

EXPLODED VIEW OF CHASSIS AND CABINET

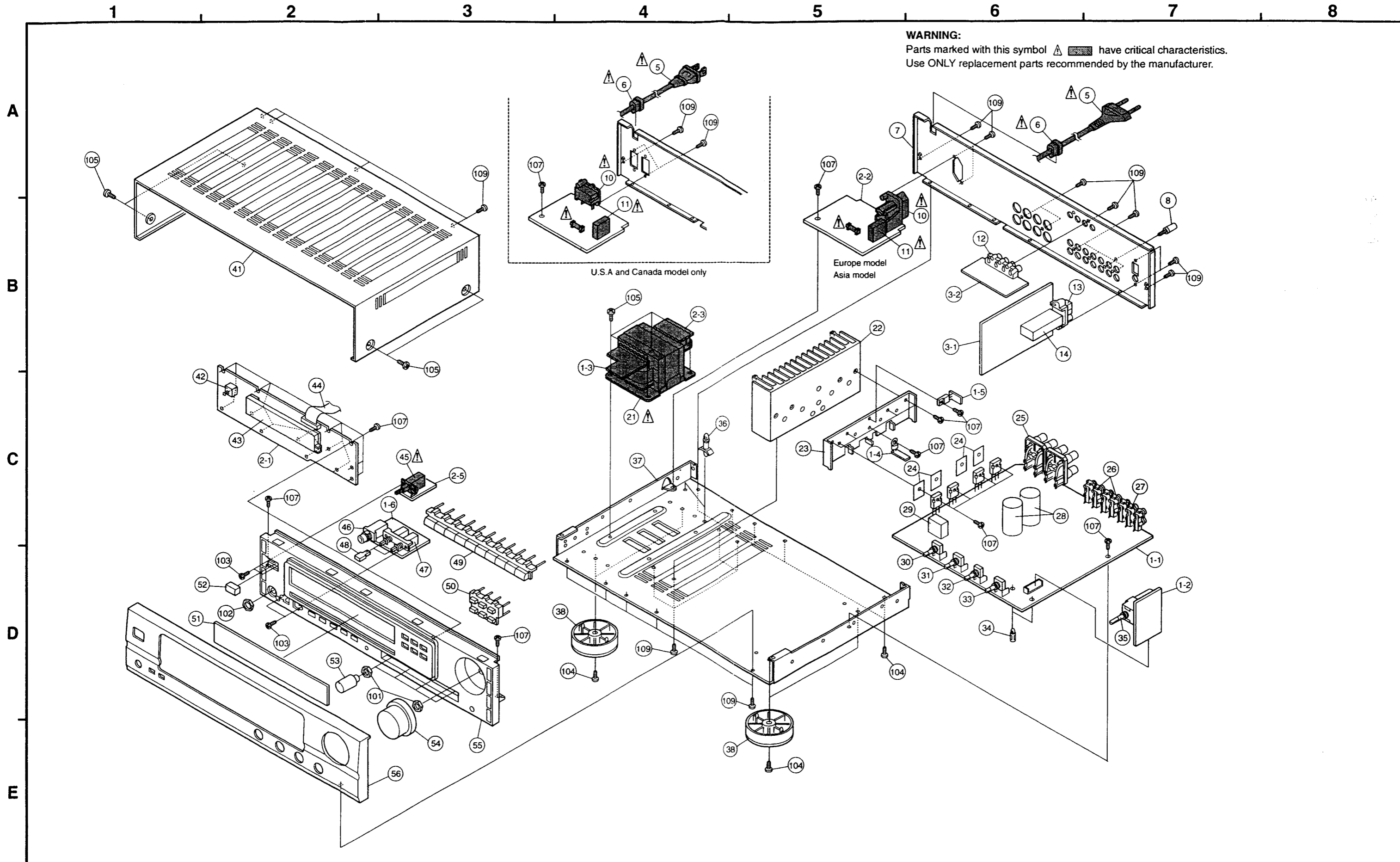

WIRING DIAGRAM

1 2 3 4 5 6 7 8

A

B

C

D

E

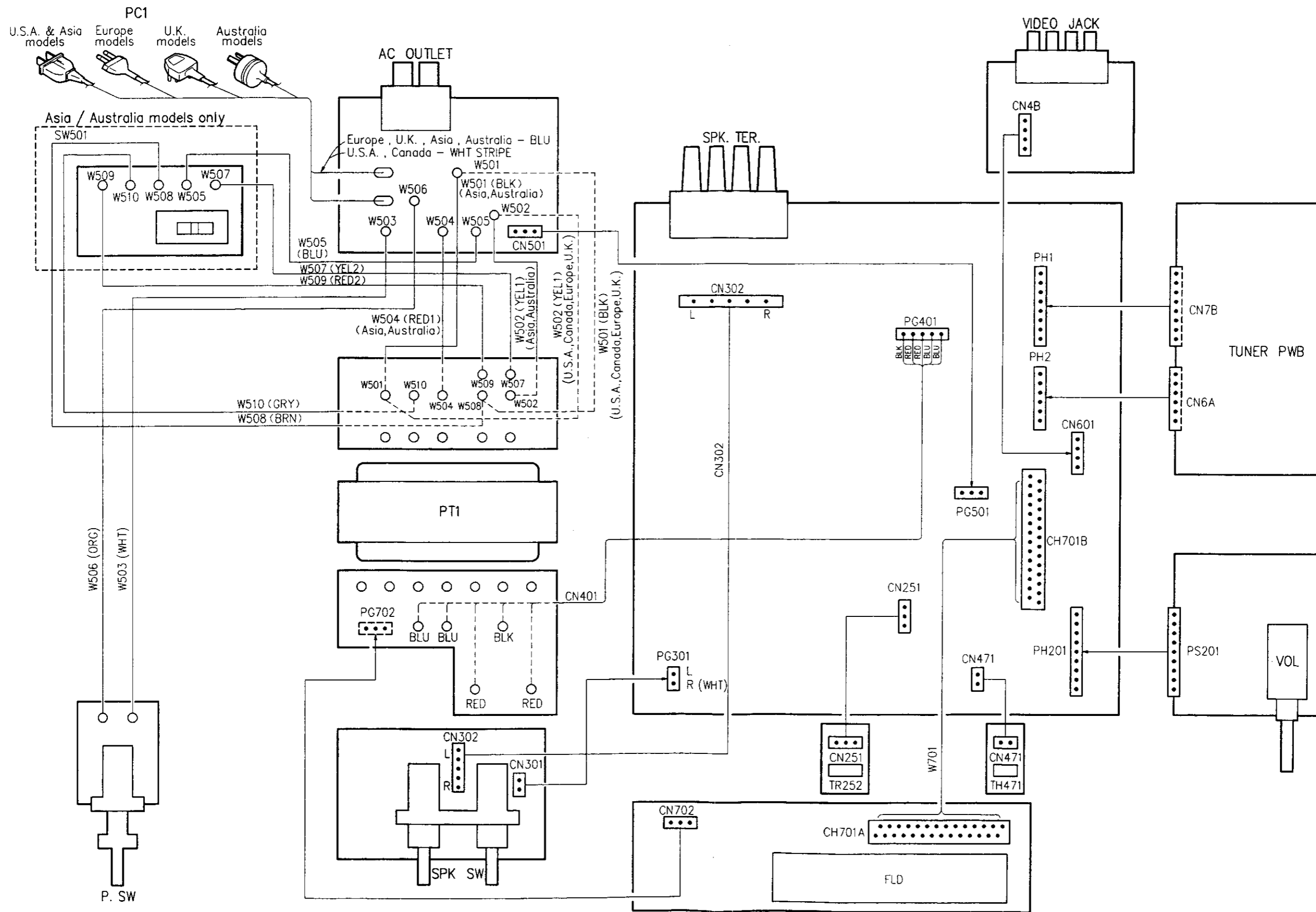

SC/ SCHEMATIC DIAGRAM (1/2)

1 2 3 4 5

		C405	C411 C412	C501	C651 C659	CH701A CH701B	CN501	D501	F501	F502	F503	IC651 IC652	J33	JK501	JK502
DRA275	U.S.A. & Canada	×	8200/50	×	×	24p	×	×	4A 125V	-	4A 125V	×	○	2 OUTLET	×
	Europe	×	8200/50	×	○	28p	×	×	T1.6A	-	T1.6A	○	×	×	1 OUTLET
	Asia	×	8200/50	×	×	24p	×	×	T3.15A	T1.6A	T1.6A	×	○	×	1 OUTLET
	Australia	×	8200/50	×	×	24p	×	×	T3.15A	T1.6A	-	×	×	×	×
DRA375	U.S.A. & Canada	○	8200/63	○	○	28p	○	○	5A 125V	-	4A 125V	○	×	2 OUTLET	×
	Europe	○	8200/63	○	○	28p	○	○	T2A	-	T1.6A	○	×	×	1 OUTLET
	U.K.	×	8200/63	×	○	28p	×	×	T2A	-	-	○	×	×	×
	Asia	○	8200/63	○	×	24p	○	○	T4A	T2A	T1.6A	×	×	×	1 OUTLET
	Australia	×	8200/63	×	×	24p	×	×	T4A	T2A	-	×	×	×	×

A

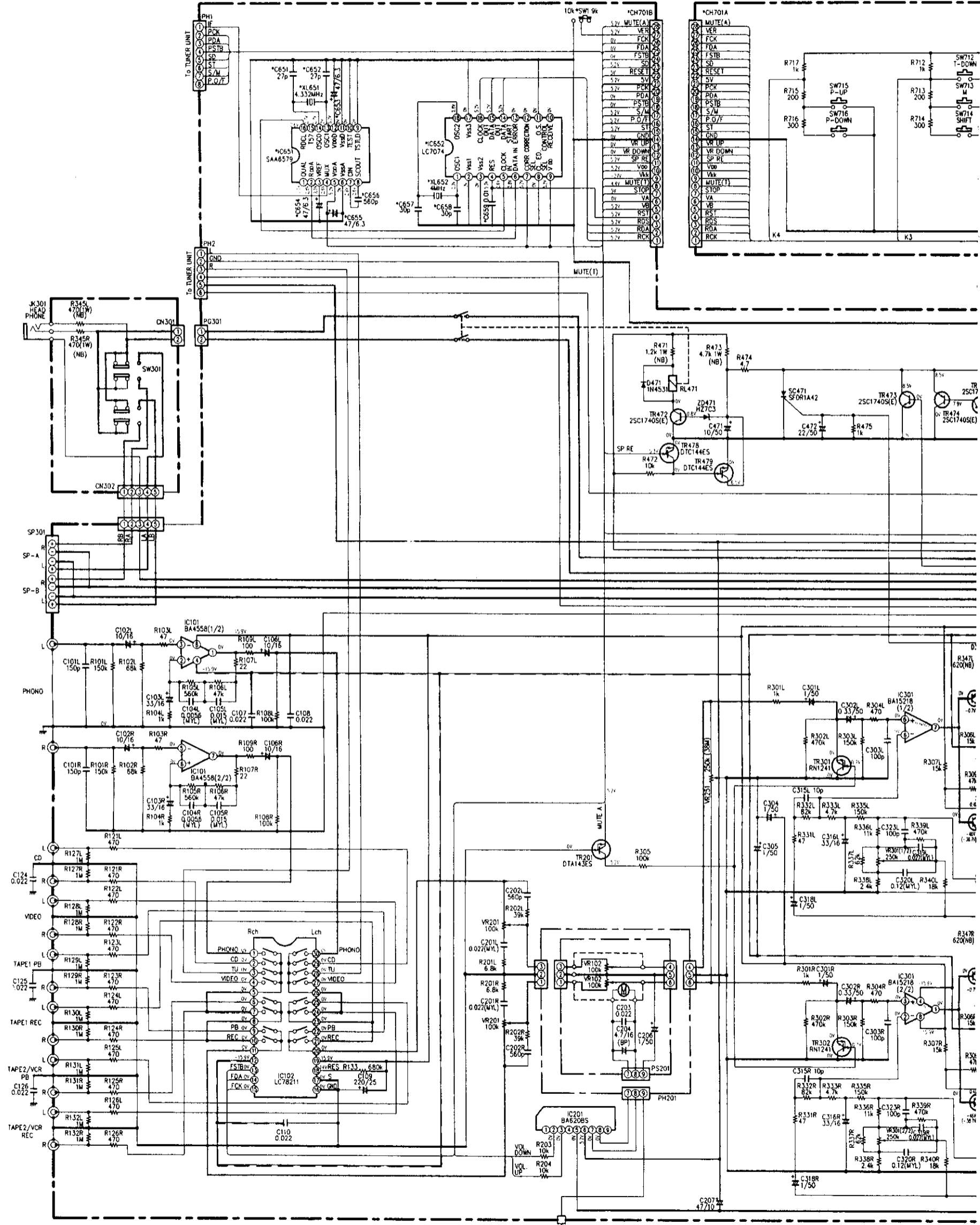

	R402	R406	R407	R501	R706	R709	R708	R719	R720	R727	RL501	SW1	SW501	SW706	SW709	SW708	TR251	TR317	TR318	TR319	TR320	TR321	TR322	TR323	TR324	TR402	TR403	XL651	XL652
X	X	X	X	X	X	X	470	5.6k	X	X	X	X	X	X	X	X	CHARACTER	2SD2004P	2SD667A(C)	2SB647A(C)	2SC3853	2SA1489	X	X	X	X	X	X	
X	X	X	X	X	X	X	200	10k	X	X	X	X	X	X	X	X	ECO-TA	2SD2004P	2SD667A(C)	2SB647A(C)	2SC3853	2SA1489	X	X	X	X	X	X	
X	X	X	X	X	X	X	200	10k	X	X	X	X	X	X	X	X	ECO-TA	2SD2004P	2SD667A(C)	2SB647A(C)	2SC3853	2SA1489	X	X	X	X	X	X	
X	X	X	X	X	X	X	470	5.6k	X	X	X	X	X	X	X	X	CHARACTER	2SD2004P	2SD667A(C)	2SB647A(C)	2SC3853	2SA1489	X	X	X	X	X	X	
X	X	X	X	X	X	X	470	5.6k	X	X	X	X	X	X	X	X	CHARACTER	2SD2004P	2SD667A(C)	2SB647A(C)	2SC3853	2SA1489	X	X	X	X	X	X	
O	O	O	O	O	O	O	200	10k	X	X	X	X	X	X	X	X	2SD2061F	2SD2004P	2SB1328P	2SC4278E	2SA1633E	O	O	O	O	O	O	O	
O	O	O	O	O	O	O	200	10k	X	X	X	X	X	X	X	X	ECO-TA	2SD2061F	2SD2004P	2SB1328P	2SC4278E	2SA1633E	O	O	O	O	O	O	
X	X	X	X	X	X	X	200	10k	X	X	X	X	X	X	X	X	ECO-TA	2SD2061F	2SD2004P	2SB1328P	2SC4278E	2SA1633E	X	X	X	X	X	X	
O	O	O	O	O	O	O	470	5.6k	X	X	X	X	X	X	X	X	CHARACTER	2SD2061F	2SD2004P	2SB1328P	2SC4278E	2SA1633E	O	O	O	O	O	O	
X	X	X	X	X	X	X	470	5.6k	X	X	X	X	X	X	X	X	CHARACTER	2SD2061F	2SD2004P	2SB1328P	2SC4278E	2SA1633E	X	X	X	X	X	X	

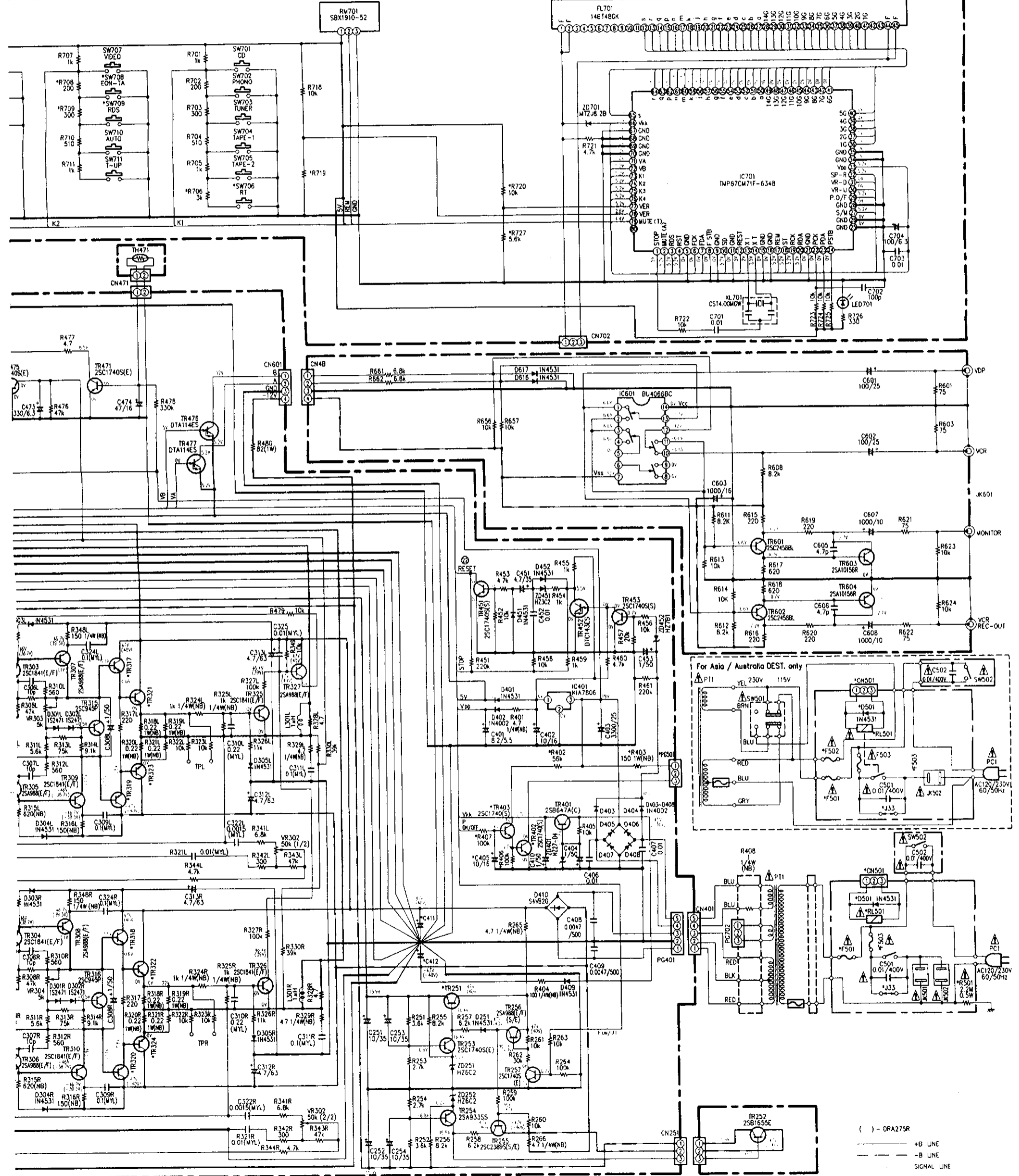

A
B
C
D
E
F
G
H

NOTES
 ALL RESISTANCE VALUES IN OHM. K=1,000 OHM, M=1,000,000 OHM
 ALL CAPACITANCE VALUES IN MICRO FARAD. P=MICRO-MICRO FARAD
 EACH VOLTAGE AND CURRENT ARE MEASURED AT NO SIGNAL INPUT CONDITION
 CIRCUIT AND PARTS ARE SUBJECT TO CHANGE WITHOUT PRIOR NOTICE.

WARNING:
 Parts marked with this symbol have critical characteristics. Use ONLY replacement parts recommended by the manufacturer.

CAUTION:
 Before returning the unit to the customer, make sure you make either (1) a leakage current check or (2) a line to chassis resistance check. If the leakage current exceeds 0.5 millamps, or if the resistance from chassis to either side of the power cord is less than 240 kohms, the unit is defective.

WARNING:
 DO NOT return the unit to the customer until the problem is located and corrected.

() - DRA275R
 --- +B LINE
 --- -B LINE
 --- SIGNAL LINE

SCHEMATIC DIAGRAM (2/2)

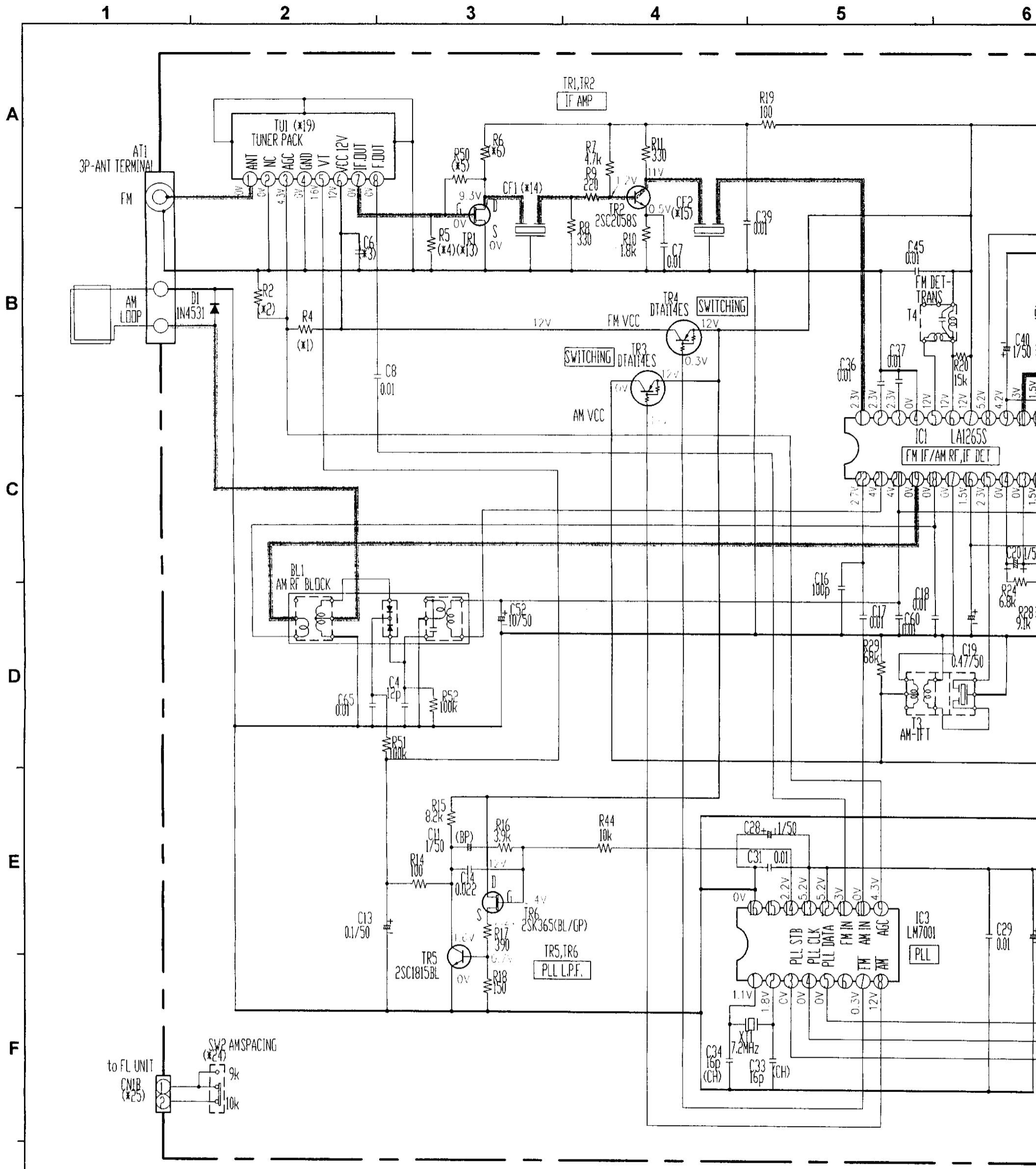

	*1	*2	*3	*4	*5	*6	*7	*8	*9	*10	*11	*12	*13	*14	*15	*16	*17	*18	*19	*20	*21	*22	*23
	R4	R2	C6	R5	R50	R6	R23	R32,R35	C53,C54	R33,R34	C23	R41,R42	TR1	CF1	CF2	C26	LF1 (C30,560p)	LF2,LF3	TU1	J4,5,6	R22	C61,C62	C55
Europe & U.K. models	10k	5.6k	0.01	390	---	330	1.2k	150k	330p	180k	---	4.7k	2SK161	SFT10.7 MS2-A	SFT10.7 MS2-A	22/50	114KHz	19KHz	4-TUNE	---	39k	0.0047	120p
U.S.A. & Canada models	---	---	---	1k	100	---	JUMPER	100k	680p	120k	100p	6.8k	---	SFE10.7 MA-8	SFE10.7 MS2G-A	---	---	---	3-TUNE	JUMPER	18k	---	DRA375 only 120p
Asia model	---	---	---	1k	100	---	JUMPER	100k	680p	120k	100p	6.8k	---	SFT10.7 MS2-A	SFT10.7 MS2-A	---	---	---	3-TUNE	JUMPER	39k	---	---

NOTES
 ALL RESISTANCE VALUES IN OHM, k=1,000 OHM, M=1,000,000 OHM
 ALL CAPACITANCE VALUES IN MICRO FARAD, P=MICRO-MICRO FARAD
 EACH VOLTAGE AND CURRENT ARE MEASURED AT NO SIGNAL INPUT CONDITION.
 CIRCUIT AND PARTS ARE SUBJECT TO CHANGE WITHOUT PRIOR NOTICE.

WARNING:
 Parts marked with this symbol have critical characteristics. Use ONLY replacement parts recommended by the manufacturer.

CAUTION:
 Before returning the unit to the customer, make sure you make either (1) a leakage current check or (2) a line to chassis resistance check. If the leakage current exceeds 0.5 milliamps, or if the resistance from chassis to either side of the power cord is less than 240 kohms, the unit is defective.

WARNING:
 DO NOT return the unit to the customer until the problem is located and corrected.

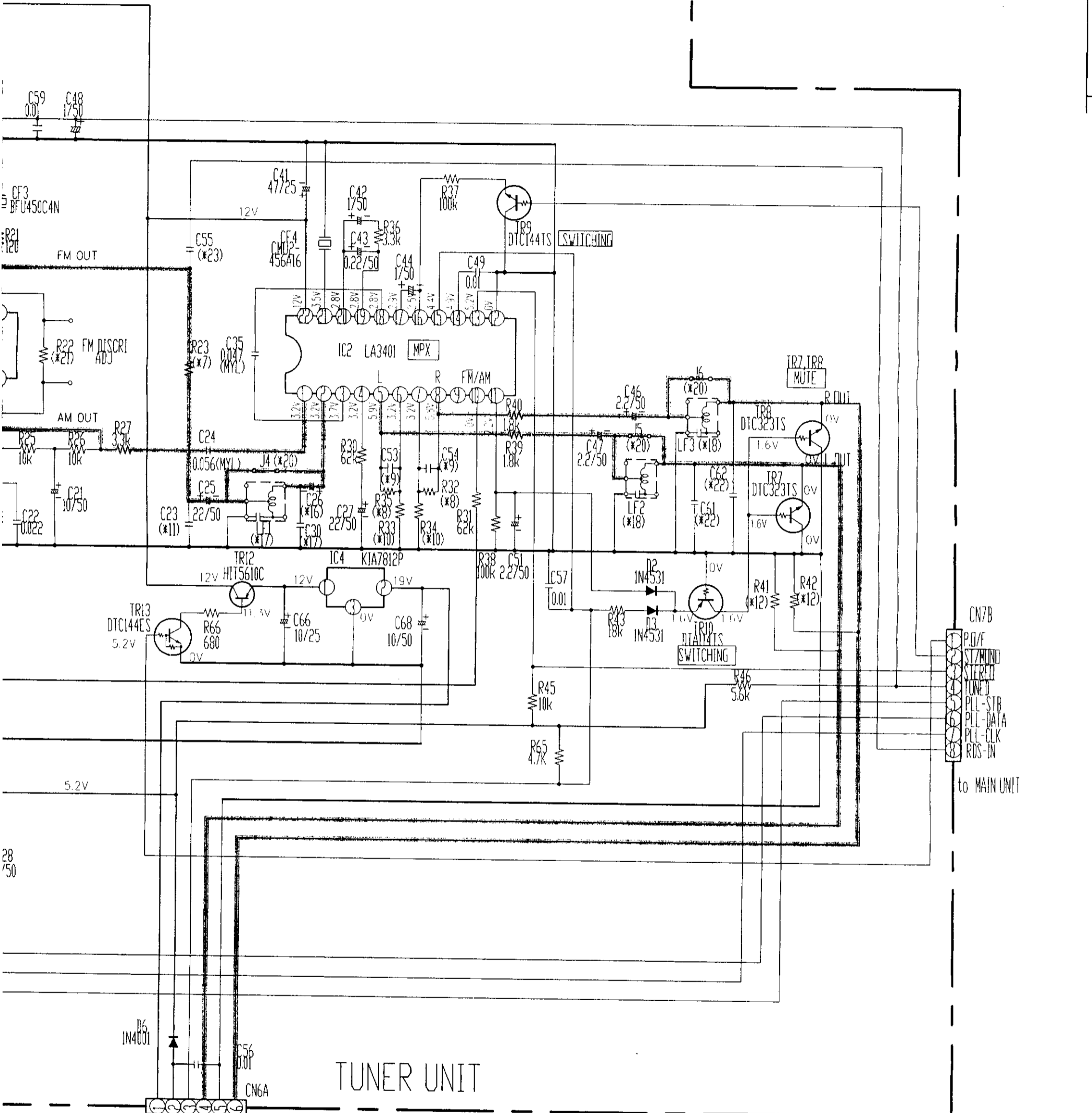

TUNER UNIT

24	*25
*2	CN1B
---	---
---	---
○	○

————— +B LINE
 - - - - - SIGNAL LINE

CN7B
 P/D/F
 ST/MONO
 STEREO
 TUNED
 PLL-STB
 PLL-DATA
 PLL-CLK
 RDS-IN
 to MAIN UNIT

CN6A
 19V
 6V
 TU-MUTE
 L ch OUT
 GND
 R ch OUT
 to MAIN UNIT