

DENON

Hi-Fi AM-FM Stereo Receiver

For EUROPEAN
And U.K Models

SERVICE MANUAL

MODEL DRA-565RD

MODEL DRA-365RD

AM-FM STEREO RECEIVER



DRA-565RD



DRA-365RD



TABLE OF CONTENTS

OPERATING INSTRUCTIONS	2 - 9
DISASSEMBLY	10, 11
METHOD OF ADJUSTMENTS	12
CONNECTION DIAGRAM OF MEASURING INSTRUMENTS	13
SEMICONDUCTORS	13 - 16
BLOCK/LEVEL DIAGRAM (DRA-565RD)	17
BLOCK/LEVEL DIAGRAM (DRA-365RD)	17
NOTE ON PARTS LIST	18
PRINTED WIRING BOARD PARTS LIST (DRA-565RD)	18, 19
PRINTED WIRING BOARD PARTS LIST (DRA-365RD)	19, 20
PRINTED WIRING BOARD PATTERNS	21 - 23
1U-2731B MAIN UNIT (DRA-565RD)	21
1U-2731 MAIN UNIT (DRA-365RD)	22
1U-2732B TUNER & DISPLAY UNIT (DRA-565RD)	23
1U-2732 TUNE & DISPLAY UNIT (DRA-365RD)	24
WIRING DIAGRAM	25
EXPLODED VIEW OF CHASSIS AND CABINET (DRA-565RD)	26
PARTS LIST OF EXPLODED VIEW (DRA-565RD)	27
PARTS LIST OF EXPLODED VIEW (DRA-365RD)	28
EXPLODED VIEW OF CHASSIS AND CABINET (DRA-365RD)	29
SCHEMATIC DIAGRAM (for DRA-565RD)	31
SCHEMATIC DIAGRAM (for DRA-365RD)	32

NIPPON COLUMBIA CO., LTD.



CAUTION
RISK OF ELECTRIC SHOCK
DO NOT OPEN



CAUTION: TO REDUCE THE RISK OF ELECTRIC SHOCK, DO NOT REMOVE COVER (OR BACK). NO USER SERVICEABLE PARTS INSIDE. REFER SERVICING TO QUALIFIED SERVICE PERSONNEL.

The lightning flash with arrowhead symbol, within an equilateral triangle, is intended to alert the user to the presence of uninsulated "dangerous voltage" within the product's enclosure that may be of sufficient magnitude to constitute a risk of electric shock to persons.

The exclamation point within an equilateral triangle is intended to alert the user to the presence of important operating and maintenance (servicing) instructions in the literature accompanying the appliance.

WARNING: TO REDUCE THE RISK OF FIRE OR ELECTRIC SHOCK, DO NOT EXPOSE THIS APPLIANCE TO RAIN OR MOISTURE.

Konformitätsbestätigung

Die DENON Electronic GmbH
 Hatakestraße 32
 40880 Ratingen

Erklärt als Hersteller/Importeur, daß das in dieser Bedienungsanleitung beschriebene Gerät den Technischen Vorschriften für Ton- und Fernseh-Rundfunkempfänger nach der Antragsverordnung 608/1993 (Antragsart des Bundesministers für Post und Telekommunikation vom 31. 8. 1993) entspricht.

PRECAUTIONS FOR INSTALLATION

Install DRA-565/365RD always horizontally. And leave at least 10 cm of space between this unit and other component placed above.

VORKEHRUNGEN FÜR DIE AUFSTELLUNG

Der DRA-565/365RD ist stets waagrecht aufzustellen. Außerdem muß ein Mindestabstand von 10 cm zwischen diesem Gerät und der Komponente gewährleistet werden, die darüber gestellt wird.

PRECAUTIONS D'INSTALLATION

Le DRA-565/365RD doit toujours être installé horizontalement. Et laisser au moins un espace de 10 cm entre cet appareil et l'autre composant placé au-dessus.

PRECAUZIONI PER L'INSTALLAZIONE

Il DRA-565/365RD viene sempre installato in modo orizzontale. Lasciate uno spazio di almeno 10 cm tra quest'unità e un eventuale componente sovrapposto.

PRECAUCIONES PARA LA INSTALACION

Instale siempre el DRA-565/365RD en posición horizontal. Asegúrese también de dejar un espacio de por lo menos 10 cm entre esta unidad y el componente que sea colocado encima.

VOORZORGSMAATREGELEN VOOR INSTALLATIE

De DRA-565/365RD altijd horizontaal plaatsen. En minstens 10 cm ruimte laten tussen dit toestel en het andere component dat u erboven plaatst.

FÖRBEREDELSE FÖR INSTALLATION



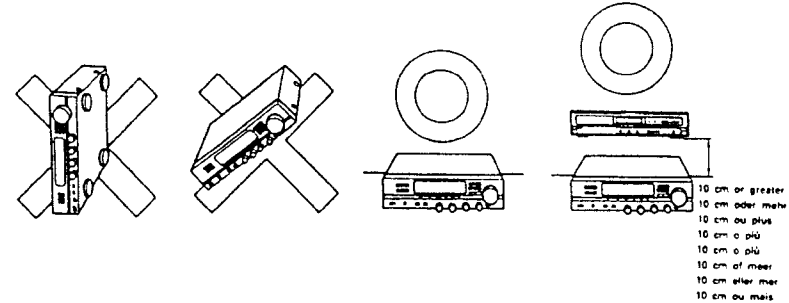

Installera alltid DRA-565/365RD horisontellt. Lämna åtminstone 10 cm mellan denna apparat och en annan komponent som placeras ovanpå.

PRECAUÇÕES PARA A INSTALAÇÃO

Instale sempre horizontalmente o DRA-565/365RD. E deixe pelo menos 10 cm de espaço entre esta unidade e o outro componente colocado acima.

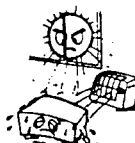

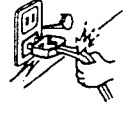
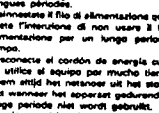
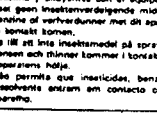
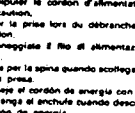
NOTE ON USE/HINWEISE ZUM GEBRAUCH/OBSERVATIONS RELATIVES A L'UTILISATION
NOTE SULL'USO/NOTAS SOBRE EL USO/ALVORENS TE GEBRUIKEN/OBSERVERA
OBSERVAÇÕES QUANTO AO USO

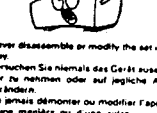
 <ul style="list-style-type: none"> • Avoid high temperatures. Allow for sufficient heat dispersion when installed on a rack. • Vermeden Sie hoge temperaturen. Beachten Sie, daß eine ausreichende Luftzirkulation gewährleistet wird, wenn das Gerät auf ein Regal gestellt wird. • Eviter des températures élevées. Tenez compte d'une dispersion de chaleur suffisante lors de l'installation sur une étagère. • Evitate di esporre l'unità a temperature alte. • Assicurarsi che ci sia un'adeguata dispersione del calore quando si installa l'unità in un mobile per componenti audio. • Evite altas temperaturas. Permita la suficiente dispersión del calor cuando está instalado en la consola. • Vermijd hoge temperaturen. Zorg voor een deeglijk hitte-afvoer indien het apparaat op een rek wordt geplaatst. • Undvik höga temperaturer. Se til at der findes tilstrækkelig luft cirkulation ved monteringen i et rack. • Evite temperaturas altas. Condição suficiente dispersão de calor quando o equipamento for instalado numa prateleira. 	 <ul style="list-style-type: none"> • Keep the set free from moisture, water, and dust. • Halten Sie das Gerät von Feuchtigkeit, Wasser und Staub fern. • Protéger l'appareil contre l'humidité, l'eau et la poussière. • Tenere l'unità lontana dall'umidità, dall'acqua e dalla polvere. • Mantenga el equipo libre de humedad, agua y polvo. • Laat geen vochtigheid, water of stof in het apparaat binnenvallen. • Utställ inte apparaten för fukt, vatten och damm. • Mantenha o aparelho livre de qualquer umidade, água ou pó. 	 <ul style="list-style-type: none"> • Do not let foreign objects in the set. • Keine fremden Gegenstände in das Gerät kommen lassen. • Ne pas laisser des objets étrangers dans l'appareil. • È importante che nessun oggetto è inserito all'interno dell'unità. • No deve objetos estranhos dentro del equipo. • Laat geen vreemde voorwerpen in dit apparaat vallen. • Se till att främmande föremål inte tränger in i apparaten. • Não deixe objetos estranhos no aparelho.
 <ul style="list-style-type: none"> • Handle the power cord carefully. Hold the plug when unplugging the cord. • Gehen Sie vorsichtig mit dem Netzkabel um. • Halten Sie das Kabel am Stecker, wenn Sie den Stecker herausziehen. • Manipuler le cordon d'alimentation avec précaution. • Tenir le prise lors du débranchement du cordon. • Maneggiare il filo di alimentazione con cura. • Agre per la spina quando scollegate il cavo dalla presa. • Manège el cordón de energía con cuidado. Sostenga el enchufe cuando desconecte el cordon de energía. • Hanteer het netkabel voorzichtig. Houd het snoer bij de steeker vast wanneer deze moet worden aen- of losgemaakt. • Hantera nätkabeln varsamt. Håll i kabeln när den kopplas från el uttaget. • Manuseie com cuidado o fio condutor de energia. Segure a tomada ao desconectar o fio. 	 <ul style="list-style-type: none"> • Unplug the power cord when not using the set for long periods of time. • Wenn das Gerät eine längere Zeit nicht verwendet werden soll, trennen Sie das Netzkabel vom Netzstecker. • Débrancher le cordon d'alimentation lorsque l'appareil n'est pas utilisé pendant de longues périodes. • Disconnetta il filo di alimentazione quando avrete l'intenzione di non usare il filo di alimentazione per un lungo periodo di tempo. • Desconecte el cordón de energía cuando no utilice el equipo por mucho tiempo. • Haem altijd het netkabel uit het stopcontact wanneer het apparaat gedurende een lange periode niet wordt gebruikt. • Koppla ur nätkabeln om apparaten inte kommer att användas i lång tid. • Desligue o fio condutor de energia quando o aparelho não tiver que ser usado por um longo período. 	 <ul style="list-style-type: none"> • Do not let insecticides, benzene, and thinner come in contact with the set. • Lassen Sie das Gerät nicht mit Insektiziden, Benzin oder Verdünnungsmitteln in Berührung kommen. • Ne pas mettre en contact des insecticides, du benzène et un diluant avec l'appareil. • Assicurarsi che l'unità non venga in contatto con insetticidi, benzina o solventi. • No permita el contacto de insecticidas, gasolina y diluyentes con el equipo. • Laat geen insecticidevrijdende middelen, benzine of ververdunner met dit apparaat in contact komen. • Se till att inte insektmedel på sprayburk, bensin och thinner kommer i kontakt med apparaten någgr. • Não permita que inseticidas, benzina e diluente entrem em contacto com o aparelho.
 <ul style="list-style-type: none"> • Never obstruct the ventilation holes. • Die Belüftungöffnungen dürfen nicht verdeckt werden. • Ne pas obstruer les trous d'aération. • Non coprire i fori di ventilazione. • No obstruya los orificios de ventilación. • De ventilatieopeningen mogen niet worden beblokt. • Tapp inte till ventilationsöppningarna. • Não obstrua os orifícios de ventilação. 	 <ul style="list-style-type: none"> • Never disassemble or modify the set in any way. • Versuchen Sie niemals das Gerät auseinander zu nehmen oder auf jegliche Art zu verändern. • Ne jamais démonter ou modifier l'appareil d'une manière ou d'une autre. • Non smontare mai, né modificare l'unità in nessun modo. • Nunca desarme o modifique el equipo de ninguna manera. • Noet dit apparaat demonteren of op andere wijze modifieren. • Ta inte isär apparaten och försök inte bryga om den. • Nunca desmonte ou modifique o aparelho de alguma forma. 	 <ul style="list-style-type: none"> • Never disassemble or modify the set in any way. • Versuchen Sie niemals das Gerät auseinander zu nehmen oder auf jegliche Art zu verändern. • Ne jamais démonter ou modifier l'appareil d'une manière ou d'une autre. • Non smontare mai, né modificare l'unità in nessun modo. • Nunca desarme o modifique el equipo de ninguna manera. • Noet dit apparaat demonteren of op andere wijze modifieren. • Ta inte isär apparaten och försök inte bryga om den. • Nunca desmonte ou modifique o aparelho de alguma forma.

FRONT PANEL

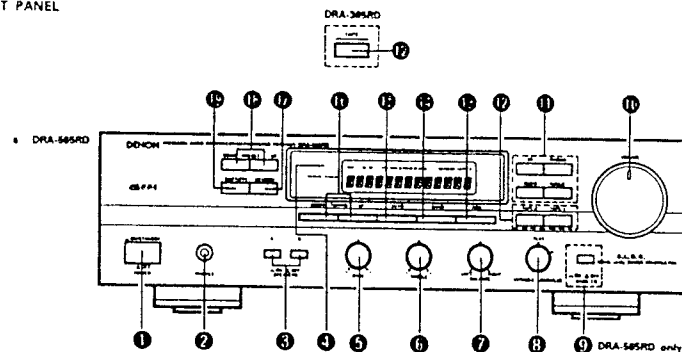

DISPLAY

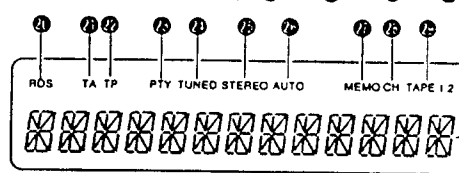

REAR PANEL

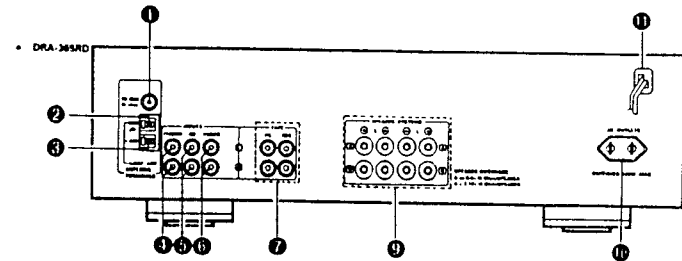
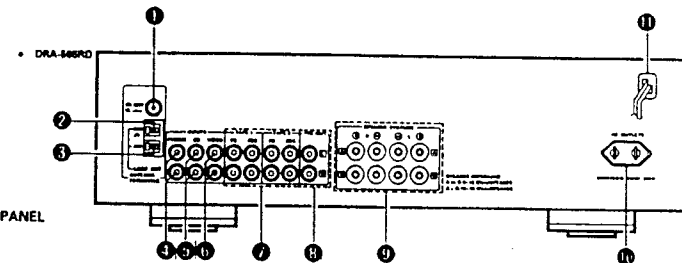

Please check the following items are included with the main unit in the carton:

- (1) Operating Instructions 1
- (2) AM Loop Antenna 1
- (3) FM Antenna 1
- (4) Remote Control RC-174 1
- (5) Batteries R6 (AA) 2

Bitte überprüfen Sie, ob die folgenden Teile vollständig in der Verpackung enthalten sind:

- (1) Bedienungsanleitung 1
- (2) AM-Rahmenantenne 1
- (3) UKW-Antenne 1
- (4) Fernbedienungsgerät RC-174 1
- (5) Trockenzelle-Batterie R6 (AA) 2

Veuillez contrôler que les articles suivants sont bien joints à l'appareil principal dans le carton:

- (1) Mode d'emploi 1
- (2) Antenne-cadre AM 1
- (3) Antenne FM 1
- (4) Télécommande RC-174 1
- (5) Piles de format R6 (AA) 2

Controllare che le parti seguenti si trovano imballate con l'apparecchio nella scatola di spedizione.

- (1) Istruzioni per l'uso 1
- (2) Antenna AM a telaio 1
- (3) Antenna FM 1
- (4) Telecomando RC-174 1
- (5) Batterie a secco R6 (AA) 2

Por favor verifique que los siguientes artículos son empacados en la caja pero separados de la unidad principal.

- (1) Instrucciones de operación 1
- (2) Antena AM de cuadro 1
- (3) Antena de FM 1
- (4) Unidad de control remoto RC-174 1
- (5) Pilas secas R6 (AA) 2

Kontroller de følgende accessories bij het hoofd toestel in de doos zijn verpakt:

- (1) Gebruiksaanwijzing 1
- (2) AM-raamantenne 1
- (3) FM-antenne 1
- (4) Afstandsbediening RC-174 1
- (5) R6 (AA) droge cel batterij 2

Kontrollera att följande tillbehör har packats ner i kartongen tillsammans med huvudenheten.

- (1) Bruksanvisning 1
- (2) Ramantenn för AM-bruk 1
- (3) FM-antenn 1
- (4) Fjärrkontroll RC-174 1
- (5) R6 (AA) torr batteri 2

Cartifique-se de que as seguintes peças estão incluídas na embalagem fora de unidade principal:

- (1) Instruções de operação 1
- (2) Antena de quadro AM 1
- (3) Antena FM 1
- (4) Controle remoto RC-174 1
- (5) Pilhas R6 (AA) 2

For multi-voltage models only:

- The desired voltage may be set with the VOLTAGE SELECTOR KNOB on the rear panel, using a screwdriver.
- Do not twist the VOLTAGE SELECTOR KNOB with excessive force as this may cause damage.
- If the VOLTAGE SELECTOR KNOB does not turn smoothly, please contact a qualified serviceman.

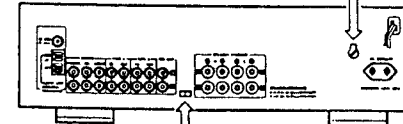

(The voltage is set to 220 V upon shipment from the factory.)

- FREQUENCY STEP (Frequency step switch)**
Set the FREQUENCY STEP switch as described below.
- In the U.S.A. and Canada - set the switch to 100 kHz / 10 kHz side. With this setting, the frequency varies in 100 kHz steps in the range of 87.5 to 108.0 MHz (FM) and in 10 kHz steps in 520 to 1710 kHz (AM).
 - Elsewhere - set the switch to 50 kHz / 9 kHz side. With this setting, the frequency varies in 50 kHz steps in the range of 87.50 to 108.0 MHz (FM) and in 9 kHz steps in 522 to 1811 kHz (AM).

DESIGNATIONS AND FUNCTIONS OF PANEL CONTROLS (Refer to Page 5.)

FRONT PANEL

- 1 **POWER (Power ON-STANDBY/OFF Switch)**
This switch turns the unit ON or OFF. There is a delay of approximately 3 seconds before the unit will operate after this power switch is turned ON. If the unit is turned OFF from the remote control, the unit will be in the STANDBY mode. When in the STANDBY mode, the unit can be turned ON with the power button on the remote control. If the unit will not be used for extended period, be sure to turn the unit OFF from the front panel power switch.
NOTE: This unit includes a STANDBY protection feature. This feature is designed to prevent accidental turn-on from the STANDBY mode in the event of a power failure. Should AC power be disconnected and then reconnected when the unit is in STANDBY mode, the unit will return to the STANDBY mode.
To turn the unit ON from the STANDBY mode without the remote control, operate the front panel power switch four times. The unit will then operate normally.
- 2 **PHONES (Headphones Jack)**
Connect a pair of headphones (sold separately) to this jack for private listening.
- 3 **SPEAKERS (Speaker selector switches)**
These switches are used to select speaker system A and B. No sound is heard through the speakers when both switches are reset to the [A] position.
- 4 **REMOTE SENSOR (Remote control sensor)**
This sensor receives the infra-red light transmitted from the wireless remote control unit. For remote control, point the wireless remote control unit towards the sensor.
- 5 **BASS (Bass control)**
Use this control to adjust the low-range response. When the control is set to the center position, the frequency characteristic curve (below 1,000 Hz) is flat. Turn the control clockwise to increase the bass response and counter-clockwise to decrease it.
- 6 **TREBLE (Treble control)**
Use this control to adjust the high-range response. When the control is set to the center position, the frequency characteristic curve (above 1,000 Hz) is flat. Turn the control clockwise to increase the treble response and counter-clockwise to decrease it.
- 7 **BALANCE (Balance control)**
Use this control to balance the volume levels between left and right channels. The volume levels in both channels are equal when the control is set to the center position.
- 8 **VARIABLE LOUDNESS (Loudness control)**
At low volumes, the human ear is less sensitive to low (BASS) and high (TREBLE) frequencies. Use this control to compensate for this deficiency when listening at low volume levels. Turn this control counter-clockwise until a natural balance of bass and treble sound has been restored.
- 9 **BASS EQ (DRA-565RD only)**
Press this button to switch the BASS EQ ON () for emphasis of bass sounds.
Use in conjunction with the bass adjustment of the tone control will provide further emphasis of bass sounds. Set this switch to OFF () when you wish to listen with a normal setting condition.
- 10 **VOLUME (Volume control)**
This knob is used to adjust the volume level of both channels.
Turn the knob clockwise to raise the volume and counter-clockwise to lower it.

- 11 **Input selector (Input selector buttons)**
These buttons are used to select the audio input source.
 - PHONO: Press to play a record on a record player connected to the PHONO input jacks.
 - CD: Press to listen to a compact disc player or another component connected to the CD input jacks.
 - TUNER: Press to listen to FM or AM programs.
 - VIDEO: Use when playing back the audio from a Hi-Fi video, video disc player or other component connected to the VIDEO terminal.
- 12 **Tape selector (Tape selector/monitor buttons) (DRA-565RD)**
TAPE-1: Press this button once, TAPE-1 indicator will light up and then you can play tape source on TAPE-1 terminal.
In this state you can copy TAPE-1 source to TAPE-2 terminal.
TAPE-2: Press this button once, TAPE-2 indicator will light up and then you can play tape or video source of TAPE-2 terminal.
Press again the button currently accessed, to play sources selected by input selector 11, indicator goes out.
- 13 **TAPE (Tape monitor button) (DRA-365RD)**
Press this button once, TAPE indicator will light up and then you can play tape source on the TAPE terminal.
Press again the button currently accessed, to play sources selected by input selector 11, indicator goes out.
- 14 **RDS button**
This button is used for the RDS search (refer to page 12) and PTY search (refer to page 12), and TP search (refer to page 12, 13) operations, and to input the station name (refer to page 12, 13).
- 15 **BAND (Band selector switch)**
Press this switch to select the FM or AM (MW) band.
- 16 **AUTO (Tuning mode button)**
This switches between auto and manual tuning.
Auto tuning: When the UP button is pressed, the radio is tuned automatically to a higher frequency. Press the DOWN button to tune to a lower frequency. Use this position to eliminate noise when no signals or weak signals are being received.
Manual tuning: In this position, the radio can be tuned manually. Reception is automatically manual when in the manual mode.
- 17 **TUNING (Tuning buttons)**
Use these to change the received frequency to a higher frequency (UP) or a lower frequency (DOWN).
When writing station names, use these buttons to select the letters. (Refer to Page 13).
- 18 **MEMORY (Memory button)**
This switch is used to store the desired radio station to a memory.
 - Presetting stations
After pressing the MEMORY button, press the SHIFT/PTY button to select the memory block, A to E. Now use the PRESET UP and DOWN buttons to specify the preset channel number. Press the MEMORY button again to store the station at the specified preset channel.

- 19 **Preset (Preset station buttons)**
These buttons are used for storing stations or recalling stations which have been preset. Using the SHIFT button you can preset a total of 40 FM or AM stations into preset channels.
Once a radio has been memorized, the same station can later be tuned in instantly simply by recalling the corresponding preset channel with PRESET UP or DOWN button.

DISPLAY

- 20 **RDS Indicator**
This lights when receiving RDS broadcasts, and flashes during the RDS search operations.
- 21 **TA Indicator**
This lights when receiving traffic announcements.
- 22 **TP indicator**
This flashes during the TP search operation and lights when TP stations are tuned in.
- 23 **PTY Indicator**
This flashes during the PTY (Programme type) search operation.
- 24 **TUNED indicator**
This lights when a station is properly tuned in.
- 25 **STEREO indicator**
This lights when receiving stereo broadcasts. It remains off when receiving AM broadcasts.
- 26 **AUTO indicator**
This indicates the tuning mode. It lights in the auto mode, and remains off in the manual mode.
NOTE:
 - TP (Traffic Programme)
 - Stations scheduled to broadcast traffic programmes
 - TA (Traffic Announcement)
 - Traffic information broadcasts

REAR PANEL

- 1 **FM ANT (FM antenna terminals)**
75-ohm coaxial cable can be connected to this terminal. For antenna connecting procedure, see the ANTENNA INSTALLATION.
- 2 **GND (Grounding terminal)**
The grounding wire of the turntable is connected here.
 - Hum or noise may be generated if the grounding wire is not connected.
- 3 **AM ANT (AM antenna terminals)**
Connect the attached AM loop antenna. (Refer to page 10 for connections).
Connect to this terminal when a medium wave outdoor antenna is used.
- 4 **PHONO (Phono input terminals)**
The output cord of the turntable is connected here. Since the input sensitivity of "PHONO" is extremely high, do not use the unit without the input pin cord. If used without this cord, the speakers may generate hum.
- 5 **CD**
The output cord of the CD player is connected here.
- 6 **VIDEO**
A VIDEO, such as a VCR or Video Disc may be connected here.
- 7 **TAPE-1, TAPE-2 (Tape deck playback/recording terminal) (DRA-565RD)**
Two tape decks or tape deck can be connected to these jacks for full-fledged playback, recording and tape dubbing operation.
 - TAPE (DRA-365RD)
Tape decks can be connected for full use including playing or copying.

- 8 **SHIFT/PTY button**
Use this button to select the memory blocks, A (1 to 8), B (1 to 8), C (1 to 8), D (1 to 8) or E (1 to 8).
For PTY search, use this button to select the program type.
When writing station names, use this button to set the writing position.

- 9 **MEMO indicator**
This indicator lights for approximately 10 seconds when the MEMORY button has been pressed and a station can be stored on a PRESET CHANNEL button.
This flashes continuously during the auto memory operation.
- 10 **CH indicator**
This lights when the preset channel number and shift mode (A, B, C, D or E) are displayed.
- 11 **TAPE-1/TAPE-2 indicator (DRA-565RD)**
The TAPE-1 indicator lights when the TAPE-1 source is selected with the tape selector buttons. The TAPE-2 indicator lights when the TAPE-2 source is selected.
The TAPE indicator (DRA-365RD)
The TAPE indicator lights when the TAPE source is selected with the tape selector buttons.
- 12 **Multi function display**
This displays the frequency, station name, programme type, etc.

- 13 **PRE-OUT (DRA-565RD only)**
Output signals for power amplifiers are sent from these jacks.
The rated output is 2 volts.
- 14 **SPEAKER SYSTEMS (Speaker terminals)**
Two pairs of speakers A and B can be connected to these terminals.
- 15 **AC OUTLET (AC power outlets)**
This AC outlet is controlled by the power switch and Remote control unit (DRA-565RD), controlled by the power switch (DRA-365RD).
- 16 **AC CORD (Power cord)**
Connect this cord into the wall outlet.

NOTES

- This receiver has a full back-up system. When the power is turned on, the INPUT SELECTOR buttons are set to the last mode set before the power was turned off.
- When using this receiver in close proximity to video equipment (TV, VCR, VDP, etc.), noise may be generated in AM broadcasts. To

avoid this, keep the receiver as far away from other video components as possible, or place the AM loop antenna where noise is reduced. If the noise is not reduced, turn off the power of the video components when listening to AM broadcasts.

CONNECTIONS

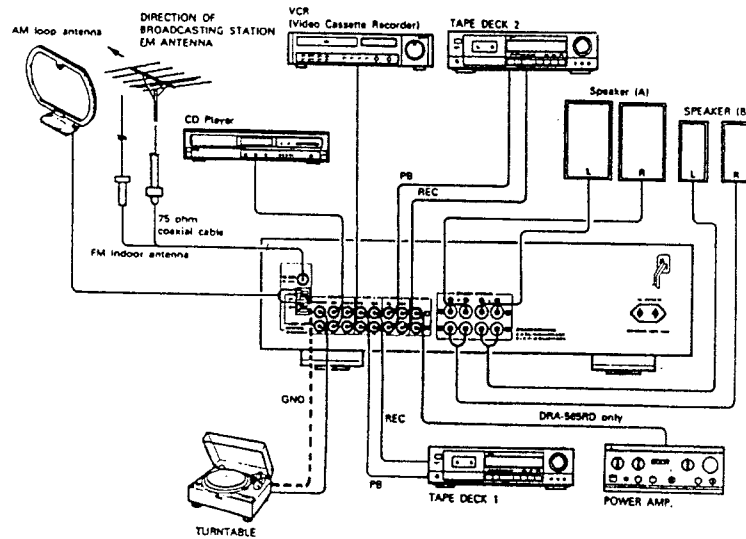

ANTENNA INSTALLATION

- **FM ANTENNA**
The supplied indoor FM antenna can be used inside wooden houses for receiving local FM stations and other strong FM signals. Stretch out the ends of the antenna and mount the antenna on the wall or ceiling where optimum reception is achieved. A indoor FM antenna may not consistently ensure stable reception, due to environment changes. In such cases, the indoor FM antenna should only be used temporarily until an outdoor FM antenna has been installed.
When connecting an outdoor FM antenna, the use of 75 ohm coaxial cable (DC-2V, 5C-2V) is strongly recommended.
- **AM ANTENNA**
Attach the supplied AM loop antenna even when using an outdoor AM antenna.
Connect the leads to the AM and GND terminals.
Also use the AM terminals for connecting an outdoor AM antenna (when making such a connection do not disconnect the AM loop antenna.)
Adjust the loop antenna to obtain optimum reception. Where broadcast stations are distant and only weak signals are received, or where signals are blocked, it is best to install an outdoor AM antenna.

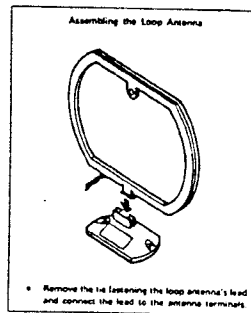

SPEAKER CONNECTION

Confirm polarity (+, -) and left and right channels (L, R). Connect the speaker pairs to the SPEAKER terminals A or B on the back panel. Connections must be made with power cord disconnected.

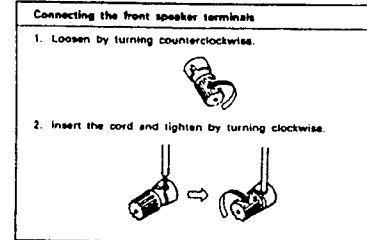
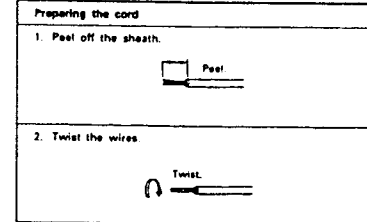

- Notes on Connection**
- Do not plug the power cord into the AC wall outlet until all connections have been completed.
 - Make sure channels are correctly connected. Connect Left channels to Left channels and Right channels to Right channels. Follow the color markings of plugs and terminals to make sure mistakes are not made.
 - Connect all pin-plugs securely, pushing them completely into the jacks. Incomplete connections will cause noise generation.
 - Binding the connection cables to power cords, or running such cables close to power supply transformers will cause humming or noise, and should thus be avoided.

- Notes:**
- Do not connect two FM antennas simultaneously.
 - Even if an external AM antenna is used, do not disconnect the AM loop antenna.
 - Make sure AM loop antenna lead terminals do not touch metal parts of the panel.

CAUTION

Protective Circuit
This set is equipped with a high speed protective circuit. This circuit protects the internal circuitry from damage due to large currents flowing when the speaker jacks are not completely connected or when an output is generated by a short circuit.
This protective circuit's operation cuts off the output to the speakers. In such a case, be sure to turn the power to the set off and check the connections to the speakers. Then turn the power on again. After muting for several seconds, the set will operate normally.

Using the Various Functions

1. Presetting stations in the memory

The frequency and the name of the radio station (including names which you have input yourself), are also stored in the memory.

In particular, the various RDS functions can be used effectively when RDS stations are stored in the memory.

How to preset the memory

Press the MEMORY button . The "MEMO" indicator on the display lights. Next, use SHIFT/PTY button to select the memory block A, B, C, D or E. Now press the PRESET UP or DOWN button to specify the preset channel number, and then press the MEMORY button to store the station in the memory.

The preset channel numbers for the different memory blocks are as follows.

Memory block A	: 1 to 8
Memory block B	: 1 to 8
Memory block C	: 1 to 8
Memory block D	: 1 to 8
Memory block E	: 1 to 8

2. Auto Memory (FM only)

The DRA-565RD/DRA-365RD is equipped with an auto memory function.

Connect the antenna, set it so that stations can be received, then hold in the MEMORY button and press the POWER button to turn the power on. Stations for which the auto stop function operates are stored in the preset memory in the order A1 to A8, B1 to B8, and so on, through E8.

Channel A1 is tuned in after the auto memory operation is completed.

Using this function makes it possible to find out the overall reception conditions of the receivable stations. The memory can be used effectively by recalling the channels in the preset memory and replacing stations whose reception is poor with stations whose reception is good, using the procedure described in 1 above.

3. Recalling preset stations

Use the SHIFT/PTY button to select memory block A, B, C, D or E, then press the PRESET UP or DOWN button to recall the station stored in the memory.

If the PRESET UP or DOWN buttons are pressed without pressing the SHIFT/PTY button , the stations are recalled in the order A1 to A8, B1 to B8, and so on, through E8.

4. RDS search (for FM only)

Use this function to automatically tune to stations offering Radio Data Service.

This operation is also possible by pressing the TUNER button on the remote control unit once when the function is set to the TUNER mode.

Operation	Display
1. Press the RDS button once.	RDS SEARCH
2. Press the PRESET UP or DOWN button .	"RDS SEARCH" flashes on the display.

(Preset memory channels A1 to E8 are being searched.)
If no RDS station is found with the above operation, all the reception bands are searched.
The station name is displayed after searching stops.

3. Press the PRESET UP or DOWN button again while the RDS mark is flashing.	RDS search starts again.
---	--------------------------

If no other RDS station is found when all the frequencies are searched, "NO RDS" is displayed.)

5. PTY search (for FM only)

Use this function to find stations broadcasting a designated type of programme type (PTY).

This operation is also possible by pressing the TUNER button on the remote control unit twice when the function is set to the TUNER mode. Next, press the PANEL button on the remote control unit, select the PTY, then press the PRESET UP or DOWN buttons to start the PTY search function in the specified direction.

Operation	Display
1. Press the RDS button twice.	PTY SEARCH
2. Press the SHIFT/PTY button.	Programme type or PTY Designated programme type

(Always do this to designate the programme type if "PTY" is displayed in step 1.)

3. Press the PRESET UP or DOWN button .	"PTY SEARCH" flashes on the display.
---	--------------------------------------

(Preset memory channels A1 to E8 are being searched.)
If there is no station broadcasting the designated programme type with the above operation, all the reception bands are searched.
The station name is displayed after searching stops.

4. Press the PRESET UP or DOWN button again while the PTY mark is flashing.	PTY search starts again.
---	--------------------------

If no other station broadcasting the designated programme type is found when all the frequencies are searched, "NO PROGRAMME" is displayed.)

The programme types which can be displayed are listed on Page 13.

6. TP Search (for FM only)

This function is used to find stations scheduled to broadcast traffic programmes (TP stations).

This operation is also possible by pressing the TUNER button on the remote control unit three times when the function is set to the TUNER mode.

Operation	Display
1. Press the RDS button 3 times.	TP SEARCH
2. Press the PRESET UP or DOWN button .	"TP SEARCH" flashes on the display.

(Preset memory channels A1 to E8 are being searched.)
If no TP station is found with the above operation, all the reception bands are searched.
The station name is displayed after searching stops.

3. Press the PRESET UP or DOWN button again while the TP mark is flashing.	TP search starts again.
--	-------------------------

If no other TP station is found when all the frequencies are searched, "NO PROGRAMME" is displayed.)

7. Writing station names
You can write in station names yourself.
(Up to 8 characters)
(Refer to the table of characters on page 13.)

Operation	Display
1. Press the RDS button 4 times.	First character flashes.
2. Use the TUNING and DOWN buttons to select the desired characters.	First letter flashes.
3. Use the SHF/PTY button to move to the next place.	Specified place flashes.

4. After writing the entire station name, store it in the memory.
(Refer to page 8.)

RDS Emergency Alarm
"ALARM" will flash on the display when the unit receives the Emergency Programme Type Code (PTY31) from an RDS station.
This feature may not operate properly if the signal from the RDS station is too weak or is subjected to interference.
It is not possible to select the "ALARM" display from the PTY search mode.

8. Clearing station names

- Recall the station name you want to clear.
- Press the RDS button 4 times until the character at the first place flashes.
- Then press the SHIFT/PTY button for at least 2 seconds. The current station name will then be cleared.

Note: Station names must be stored in a preset memory to be retained. If the power is turned off, or if the band (AM/FM) is changed, the station name will be lost. Be sure to store the entered station name in a Preset Memory before changing the band or turning the power switch OFF.

The following programme types can be designated:

NEWS	NEWS	M.O.R. MUSIC	M.O.R. MUSIC
AFFAIRS	AFFAIRS	L-CLASSICS	LIGHT CLASSICS
INFORMATION	INFORMATION	S-CLASSICS	SERIOUS CLASSICS
SPORT	SPORT	OTHER MUSIC	OTHER MUSIC
EDUCATION	EDUCATION		
DRAMA	DRAMA		
CULTURE	CULTURE		
SCIENCE	SCIENCE		
VARIED	VARIED		
POP MUSIC	POP MUSIC		
ROCK MUSIC	ROCK MUSIC		

Table of characters

The characters are input in the order shown to the right. Use the TUNING buttons to select the desired characters.

→ ABCDEFGHIJKLMNOPQRSTUVWXYZ
→ 01234567890-@#%&'()*+,-./:;=<=>SPACE

PLAYBACK USING THE REMOTE CONTROL

The accessory RC-174 remote control unit is used to control the RECEIVER from a distance.

(1) Inserting the dry cell batteries

1. Remove the rear cover on the remote control unit.

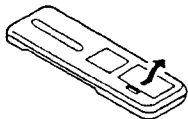

2. Insert two size "AA" (R6) dry cell batteries as shown in the diagram on the battery supply unit.

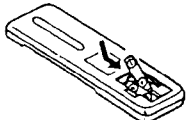

3. Replace the rear cover.

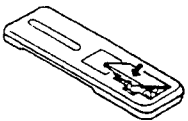

(2) Directions for use

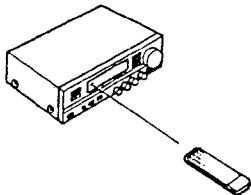

Note on Operation

- Do not press the operating buttons on the receiver and the remote control unit at the same time. This will cause misoperation.
- Operation of the remote control unit will become less effective or erratic if the infrared remote control sensor on the receiver is exposed to strong light or if there are obstructions between the remote control unit and the sensor.
- In case you operate your VCR, TV or other components by remote control, do not operate buttons on two different remote control units at the same time. This will cause mis-operation.

Notes on Use of the Batteries

- The remote control unit uses size "AA" (R6) dry cell batteries.
- The batteries will need to be replaced approximately once a year. This will depend upon how often the remote control is used.
- If, in less than a year from the time new batteries were inserted, the remote control fails to operate the receiver from a near-by position, it is time to replace the batteries.
- Insert the batteries properly, following the diagram on the remote control battery supply unit, and making sure to align the plus and minus sides of each battery.
- Batteries are prone to damage and leakage. Therefore:
 - Do not combine new batteries with used ones.
 - Do not combine different types of batteries.
 - Do not jumper the opposite poles of the batteries, expose them to heat or break them open, or put them into open fire.
- When the remote control is not to be used for a long period of time, remove the batteries from the unit.
- If the batteries have leaked, remove any battery fluid from the inside of the battery supply unit by wiping it out thoroughly, and insert new batteries.

- Operate the remote control unit while pointing it towards the remote control sensor on the receiver as shown in the diagram left.
- The remote control unit can be used at distances up to about 8 meters in a straight line from the receiver. This distance will decrease if there are obstructions blocking the infra-red light transmission or if the remote control unit is not directed straight at the receiver.

Besides being able to operate the DRA-565RD/365RD receiver with this remote control unit, you can also operate a DENON cassette deck and CD player from this handy full-system remote control unit.

Remote Control Section

Full-system Remote Control Unit

The full-system remote control unit operates all major functions of the receiver such as function switching, volume control, and preset station selection. But that's not all! The same control pad can also control the major functions of a DENON CD player and cassette deck to create a remarkably ergonomic and versatile DENON system with all the quality sound reproduction that the devoted audiophile expects.

Remote Control Unit RC-174 supplied with DRA-565RD/365RD

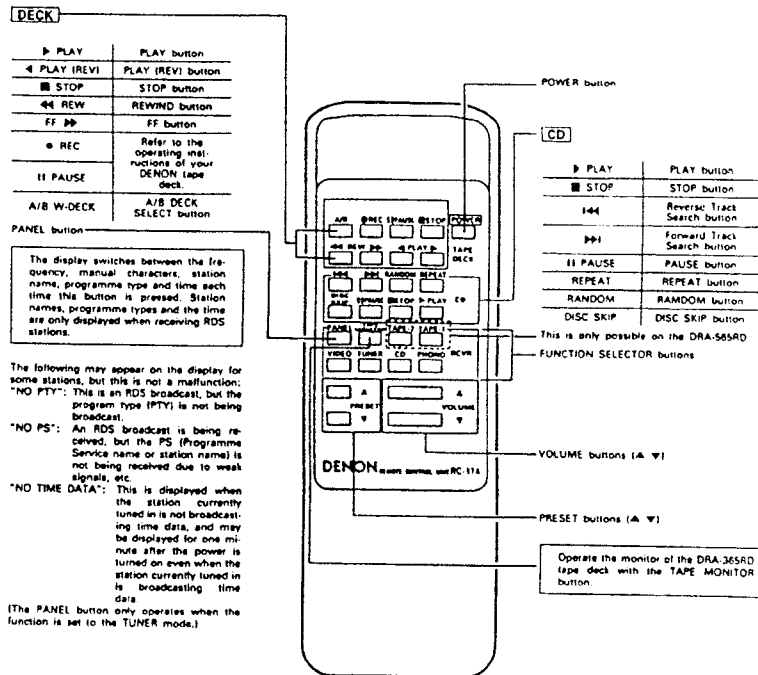

- The RC-174 Remote Control Unit can control CD players and cassette decks made by DENON.
- Note that operation may not be possible for some models.
- Buttons are conveniently separated into groups, each group controlling one specific component. The groups are RECEIVER, CD and DECK.

For details on operating other components, refer to the instruction manuals for the CD player and/or cassette deck.

CAUTION:

- If the power is turned off with the remote control unit, the receiver is switched to the power stand-by state. If you are to be absent for a long period of time, be sure to turn the power off using the POWER switch on the receiver.
- A part of the digit of fluorescent display light while the receiver is in the power stand-by state.
- You may experience erratic operation of the remote control unit if it is operated in fluorescent light and direct sunlight, in particular if this light strikes the remote control sensor on the receiver. However, this is not a malfunction, and if this should happen, protect the sensor against such light.

TROUBLESHOOTING

1. Have all connections been made PROPERLY?
2. Have you followed all operational instructions correctly?
3. Check speaker and the turntable systems for proper operation.

When your unit does not seem to be operating correctly, first check the items in the following table. If the symptom does not correspond to any of the problems as shown below, turn off the power sources immediately and contact your DENON dealer.

Problem	Cause	Remedy
FM AND AM RECEPTION		
Radio program can not be received.	<ul style="list-style-type: none"> • Antenna connection is wrong. • A signal strength is weak. 	<ul style="list-style-type: none"> • Check the connection. • Check the antenna installation.
Noise is reproduced.	<ul style="list-style-type: none"> • A signal strength is weak. • Automobile ignition noise interferes with reception. • Other electrical equipment interferes with reception. 	<ul style="list-style-type: none"> • Install an outdoor antenna. • Keep the antenna away from the street. • Keep the equipment away from this set, or turn off the power of the other equipment.
The preset frequencies are erased.	<ul style="list-style-type: none"> • The memory back-up term (about 1 month) passed. 	<ul style="list-style-type: none"> • Preset again.
In automatic tuning, the frequency doesn't stop at the radio station.	<ul style="list-style-type: none"> • A signal strength is weak. 	<ul style="list-style-type: none"> • Use manual tuning.
In automatic tuning, it stops at the one step lower or higher frequency than the radio station.	<ul style="list-style-type: none"> • Noise or strong signal strength is received. 	<ul style="list-style-type: none"> • Use manual tuning for optimum reception.
PLAYBACK OF THE AUDIO EQUIPMENTS		
No sound is produced with power on.	<ul style="list-style-type: none"> • Input and speaker cords connection are wrong. • Speaker switch is off. • The INPUT SELECTOR buttons are in wrong position. • The protective circuit is operating. • The fuse has blown out. 	<ul style="list-style-type: none"> • Check the connection. • Turn on speaker switch. • Check these position. • Turn the power off once, check the connections to the speakers, then turn the power on again. • Ask your dealer, or the nearest DENON representative.
Audible hum when playing records.	<ul style="list-style-type: none"> • The input and grounding cords connection of the turntable are wrong. • The cords connection of the cartridge are wrong. • The interference from the nearby TV or radio transmission antenna. 	<ul style="list-style-type: none"> • Check the connection. • Check the connection. • Ask your dealer, or the nearest DENON representative.
Howling is produced when the volume control is turned up too high while playing records.	<ul style="list-style-type: none"> • The vibrations and sounds transmit from the speakers to the turntable. 	<ul style="list-style-type: none"> • Insulate the vibrations, or keep the speakers away from the turntable.
Cracking noise is produced when playing records.	<ul style="list-style-type: none"> • The record is stained with the dust. • The stylus tip of the cartridge is stained with the dust. • The cartridge is defective. 	<ul style="list-style-type: none"> • Clean the record. • Clean the stylus tip. • Try the other cartridge.

SPECIFICATIONS

AMPLIFIER SECTION

Continuous Power Output: **DRA-565RD: 80 W + 80 W (4 ohms, 1 kHz)**
DRA-365RD: 62 W + 62 W (4 ohms, 1 kHz)
 Power Bandwidth (BW): **10 Hz ~ 40 kHz (T.H.D. 0.1%, both channels driven into 8 ohms)**

Total Harmonic Distortion: **0.03% (-3 dB at rated output, 8 ohms)**
 Frequency Response: **PHONO RIAA Standard Curve (Recording Output)**
 MM 20 Hz ~ 20 kHz ± 0.5 dB
 CD, VIDEO, 20 Hz ~ 60 kHz ± 1.5 dB (at 1W)
 TAPE-1, TAPE-2 (DRA-565RD)
 TAPE (DRA-365RD)

Input Sensitivity and Impedance:
 PHONO MM 2.5 mV 47 k ohms
 CD, VIDEO, 150 mV 25 k ohms
 TAPE-1, TAPE-2 (DRA-565RD)
 TAPE (DRA-365RD)

Maximum Input Level (at 1 kHz):
 Signal to Noise Ratio (IHF-A):
 PHONO MM 78 dB (at 5.0 mV input)
 CD, VIDEO, 95 dB
 TAPE-1, TAPE-2 (DRA-565RD)
 TAPE (DRA-365RD)

Tone Controls:
 BASS ± 10 dB at 100 Hz
 TREBLE ± 10 dB at 10 kHz
 Loudness Control Effect:
 VARIABLE LOUDNESS at maximum position
 50 Hz/10 kHz, $+10$ dB/ $+8$ dB

PRE-OUT terminals (DRA-565RD only)
 Rated output:
 2 V (at 100 kohm load)

TUNER SECTION

(FM) (note: μ V at 75 ohms, 0 dB/ -1×10^{-16} W)
 Receiving Range: **87.5 ~ 108 MHz**
 Usable Sensitivity: **0.9 μ V (10.3 dB)**

Signal to Noise Ratio (IHF-A):
 MONO 82 dB
 STEREO 78 dB
 85 dB
 Image Rejection:
 Selectivity (± 300 kHz):
 55 dB
 Frequency Response:
 30 Hz ~ 15 kHz $+10$ dB
 -1.5 dB
 Stereo Separation (at 1 kHz):
 40 dB
 [AM]
 Receiving Range:
 522 ~ 1611 kHz

Usable Sensitivity:
 Signal to Noise Ratio:
 18 μ V
 55 dB

General

Power Supply:
 AC 230V 50 Hz
 Power Consumption:
 145 W (DRA-565RD)
 120 W (DRA-365RD)

Power Outlets:
 Dimensions:
 SWITCHED 100 W
 434 mm (W) \times 130 mm (H)
 \times 312 mm (D) (DRA-565RD)
 434 mm (W) \times 120 mm (H)
 \times 312 mm (D) (DRA-365RD)
 7.2 kg (DRA-565RD)
 6.0 kg (DRA-365RD)

REMOTE CONTROL UNIT

RC-174
 Remote control system:
 Infrared pulse system
 Power supply:
 3V DC Two size "AA" (RS)
 dry cell batteries
 External dimensions:
 80 mm W \times 175 mm H
 \times 18 mm D
 Weight:
 120 g (includes batteries)

Design and specifications are subject to change without prior notice.

DISASSEMBLY

(To reassemble reverse disassembly)

● Top Cover

Remove 4 screws ① and 2 screws ②.

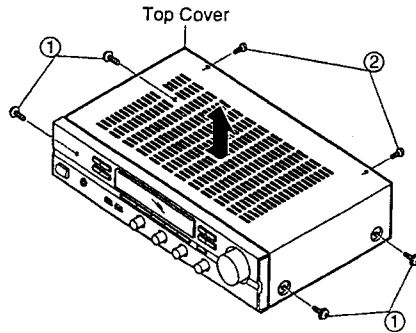

● Front Mold Panel

- (1) Pull out Volume knob ④ and 4 round knobs ⑤.
- (2) Remove 5 nuts ⑥ and Speed Nut ⑦.
- (3) Remove 2 screws ⑧.

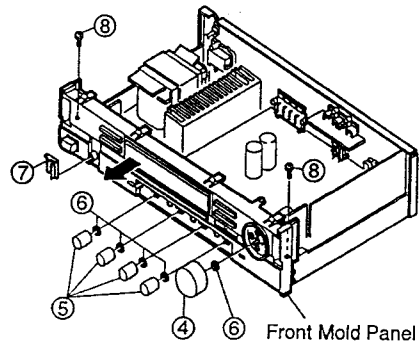

● Front Aluminium Panel

Remove 4 screws (365RD) 5 screws (565RD) ③ and undo hooks at 4 places.

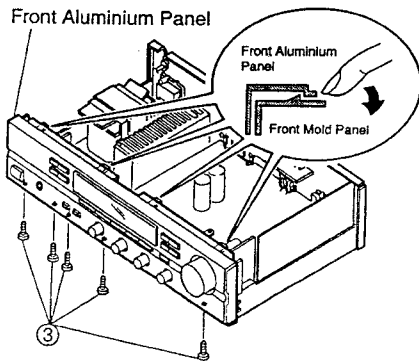

● Rear Panel

- (1) Disconnect cord bush ⑨.
- (2) Remove 7 screws ⑩, and 8 screws (365RD) 9 screws (565RD) ⑪.

*Screws 11 is tighten.

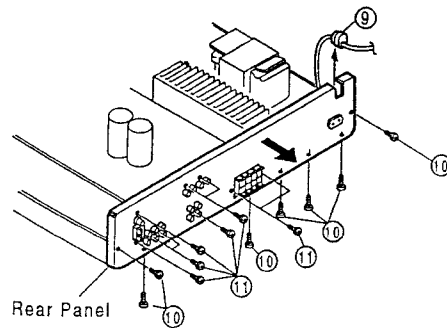

- Despite the transformer and PWB are connected with the wire, an arrangement clumper is relatively easy to remove at a time of service.

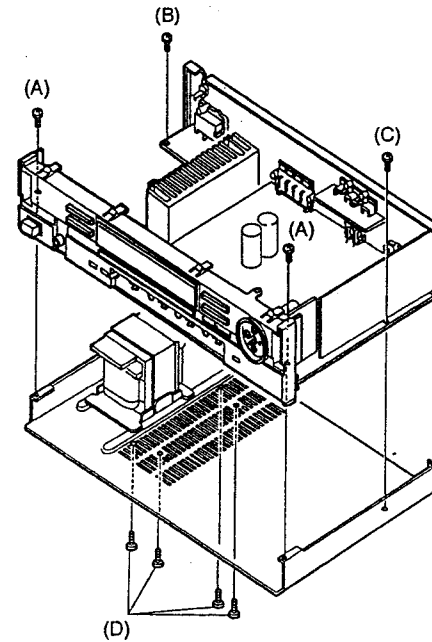

- (1) Disassemble Front Aluminium Panel (refer to previous Item 2).
- (2) Remove 4 screws (D) securing the Radiator to the Bottom Cover.
- (3) Unfasten 2 screws on the surface and 5 screws on the bottom of Rear Panel (refer to previous Item 4).
- (4) Remove 2 screws (A) securing the Inner Panel.
- (5) Untighten a screw (C) and detach Main PWB, remove a screw (B) and detach Power Supply PWB.
- (6) Remove arrangement clumper for the wire of Transformer.
- (7) Hold and lift the Back Panel and Inner Panel.

Checking is feasible by positioning the PWB upright.

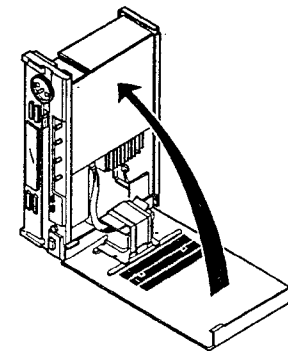

METHOD OF ADJUSTMENTS

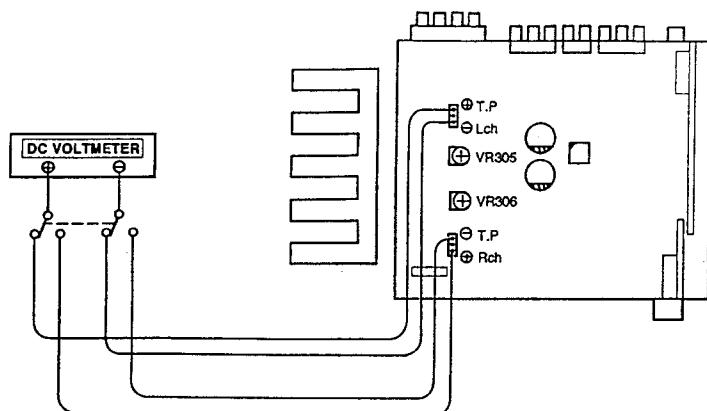

IDLING CURRENT

- (1) Set controls as follows.
 - POWER Switch → off ()
 - VOLUME Control → 0 (min.)
 - SPEAKERS → off ()
 - Temperature → 15°C ~ 30°C (59°F ~ 86°F)
 - VR305 and VR306 of the 1U-2718-1 (Main Unit) → MIN. ()
- (2) Connect DC Voltmeter to the T.P Lch and T.P Rch of the 1U-2718.
- (3) Turn the Power Switch on and rotate VR305 clockwise so that the DC Voltmeter reads 2.5 mV ±0.2 mV DC at the T.P Lch. Follow the same procedure to VR306 for T.P Rch.
- (4) Warm up for three minutes, then readjust VR305 and VR306 so that the DC Voltmeter reads 2.5 mV ±0.5 mV DC.
- (5) Warm up for 10 minutes, then readjust VR 305 and VR306 so that the DC Voltmeter reads 2.5 mV ±0.5 mV DC.

CONNECTINON DIAGRAM OF MEASURING INSTRUMENTS

● FM SECTION

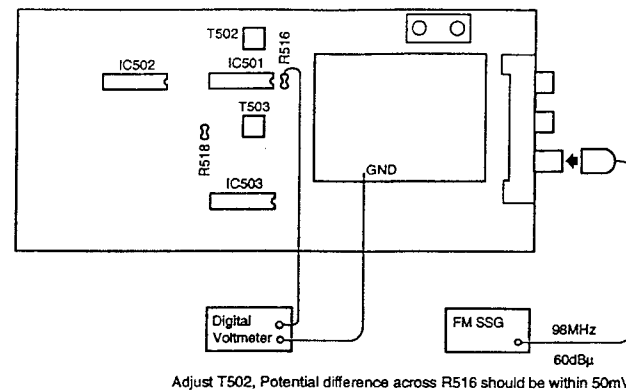

Adjust T502, Potential difference across R516 should be within 50mV.

● AM SECTION

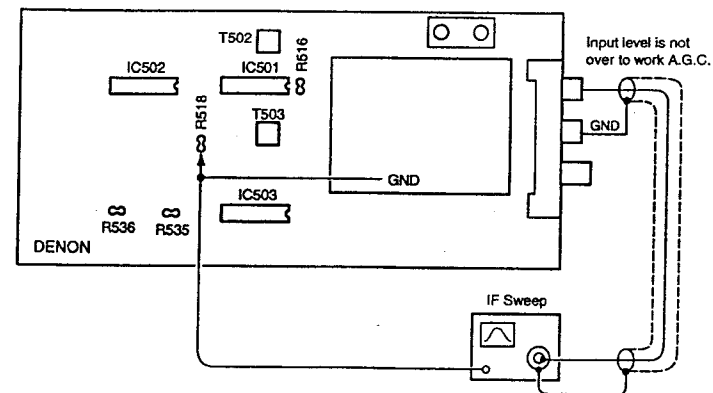

Adjust T503 for maximum height and best symmetry curve.

SEMICONDUCTORS

● IC's

TMP87CM71F (IC601)

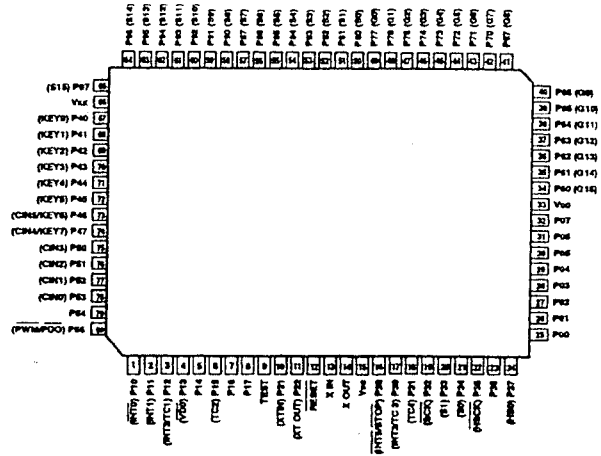
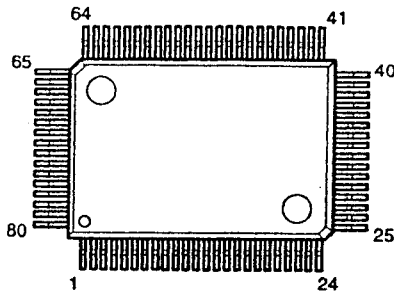

TMP87CM71F Port Allocation Table

Pin No.	Symbol	IO	Logic	Initial Setting	Function
1	STOP	I	L	—	Power down detection ("L" = at power down).
2	MUTE (A)	I	—	—	MUTE (A) output ("H" = MUTE)
3	RDS	I	Serial	—	RDS data (start) input.
4	RES	O	L	H	LC7074 reset output.
5	GND	I	Serial	—	Not used.
6	FCK	O	Serial	L	Function control output (LC7821) for F-CK.
7	FDA	O	Serial	L	Function control output (LC7821) for F-DATA.
8	FSTB	O	H	L	Function control output (LC7821) for F-STB.
9	GND	I	—	—	Connect to GND.
10	SD	I	L	—	Tuned signal input ("L" = at tuned in).
11	GND	I	—	—	Not used.
12	RESET	I	L	—	Reset input.
13	XIN	I	—	—	Oscillation circuit (4MHz).
14	XOUT	I	—	—	Oscillation circuit (4MHz).
15	Vss	PW	—	—	GND
16	GND	I	—	—	GND
17	REM	I	L	—	Remote control signal input.
18	ST	I	L	—	Stereo signal input ("L" = at stereo).
19	RCK	I	Serial	—	RDS data (clock) input.
20	RDA	I	Serial	—	RDS data (data) input.
21	GND	I	—	—	Not used.
22	PCK	O	Serial	L	LM7001 control output for PLL-CK (CL).
23	PDA	O	Serial	L	LM7001 control output for PLL-DATA (DATA).
24	PSTB	O	H	L	LM7001 control output for PLL-STB (CE).
25	GND	O	—	L	GND
26	GND	O	—	L	GND
27	AM	O	L	L	AUTOMANUAL control.
28	GND	I	—	—	Not used.
29	P.OF	O	H	L	Power control output ("H" = ON).
30	VR-UP	O	H	L	Power volume control output (LB1639 ON = at "H").
31	VR-D	O	H	L	Power volume control output (LB1639 ON = at "H").
32	SP-R	O	H	L	Speaker relay control output (ON = at "H").
33	Vcc	PW	—	—	+5V
34	GND	I	—	—	GND
35	GND	I	—	—	GND
36	1G	O	—	—	FL tube control output for 1G.
37	2G	O	—	—	FL tube control output for 2G.
38	3G	O	—	—	FL tube control output for 3G.
39	4G	O	—	—	FL tube control output for 4G.
40	5G	O	—	—	FL tube control output for 5G.
41	6G	O	—	—	FL Tube control output for 6G.
42	7G	O	—	—	FL Tube control output for 7G.
43	8G	O	—	—	FL Tube control output for 8G.
44	9G	O	—	—	FL Tube control output for 9G.
45	10G	O	—	—	FL Tube control output for 10G.
46	11G	O	—	—	FL Tube control output for 11G.
47	12G	O	—	—	FL Tube control output for 12G.
48	13G	O	—	—	FL Tube control output for 13G.
49	14G	O	—	—	FL Tube control output for 14G.
50	S0 (a)	O	—	—	FL Tube control output for P(a).
51	S1 (b)	O	—	—	FL Tube control output for P(b).
52	S2 (c)	O	—	—	FL Tube control output for P(c).
53	S3 (d)	O	—	—	FL Tube control output for P(d).
54	S4 (e)	O	—	—	FL Tube control output for P(e).
55	S5 (f)	O	—	—	FL Tube control output for P(f).
56	S6 (g)	O	—	—	FL Tube control output for P(g).
57	S7 (h)	O	—	—	FL Tube control output for P(h).
58	S8 (i)	O	—	—	FL Tube control output for P(i).
59	S9 (k)	O	—	—	FL Tube control output for P(k).
60	S10 (m)	O	—	—	FL Tube control output for P(m).
61	S11 (n)	O	—	—	FL Tube control output for p(n).
62	S12 (p)	O	—	—	FL Tube control output for P(p).
63	S13 (q)	O	—	—	FL Tube control output for P(q).
64	S14 (r)	O	—	—	FL Tube control output for P(r).
65	S15 (s)	O	—	—	FL Tube control output for P(s).
66	Vkk	PW	—	—	-15V
67					
70	GND	I	—	—	GND
71	VA	O	L	H	Video In/Out control ("L" = at selection) BV4066.
72	VB	O	L	H	Video In/Out control ("L" = at selection) BV4066.
73	K1	I	—	—	Key input (A/D conversion input).
74	K2	I	—	—	Key input (A/D conversion input).
75	K3	I	—	—	Key input (A/D conversion input).
76	K4	I	—	—	Key input (A/D conversion input).
77	VER	I	—	—	Forwarding country setting.
78	VER	I	—	—	Specification setting.
79	MUTE (T)	O	H	H	MUTE output ("H" = MUTE).
80	GND	I	—	—	GND

BA4558 (IC101)

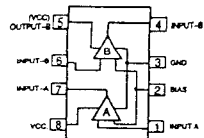
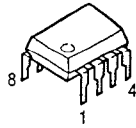

LM7001 (IC503)

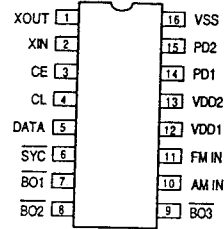
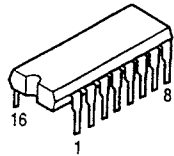

LA3401 (IC502)

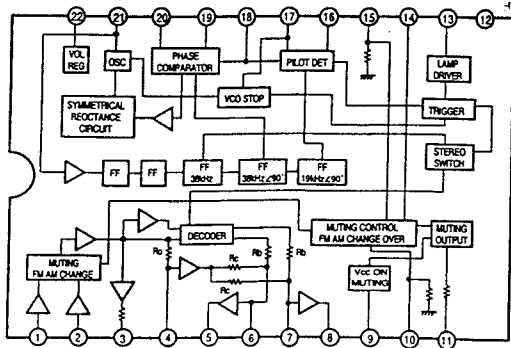
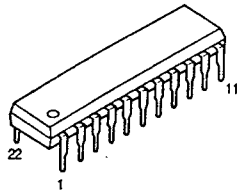

LA1265 (S) (IC501)

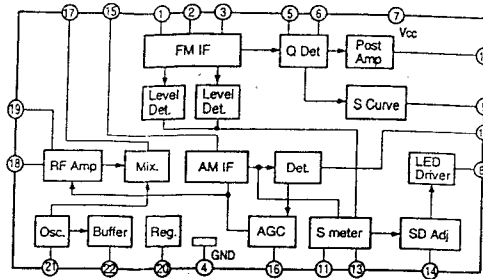
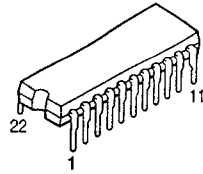

LC7821 (IC102)

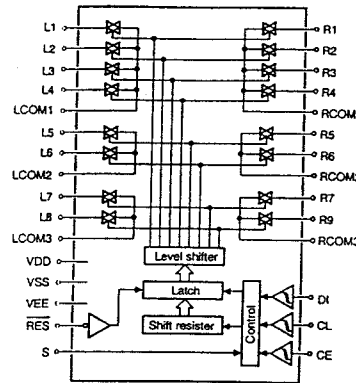
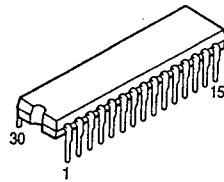

SAA6579T (IC601)

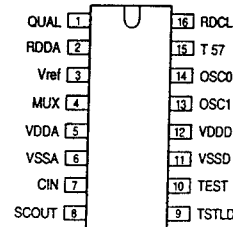

Pin No.	Symbol	Description
1	QUAL	Quality indication output.
2	RDDA	RDS data output.
3	V _{ref}	Reference voltage output (0.5 V _{DDA}).
4	MUX	Multiplex signal input.
5	V _{DDA}	+5 V supply voltage for analog part.
6	V _{SSA}	Ground for analog part (0 V).
7	CIN	Subcarrier input to comparator.
8	SCOUT	Subcarrier output of reconstruction filter.
9	TSTLD	Test control.
10	TEST	Test enable.
11	V _{SSD}	Ground for digital part (0 V).
12	V _{DDO}	+5 V supply voltage for digital part.
13	OSCI	Oscillator input.
14	OSCO	Oscillator output.
15	TS7	57 kHz clock signal output.
16	RDCL	RDS clock output.

LC7074 (IC602)

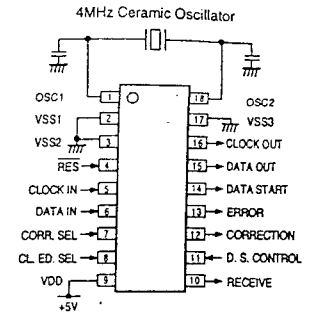
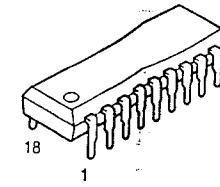

LB1639 (IC201)

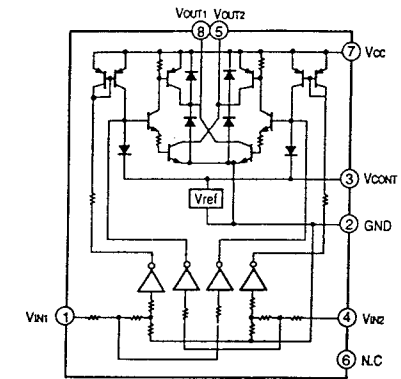
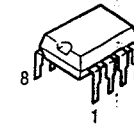

BA15218 (IC301)

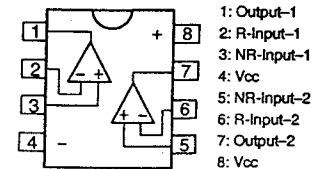
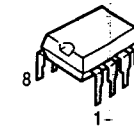

NJM78M12FA
(IC504)
NJM7806FA
(IC401)

SBX1610-52 (REMOTE SENSOR)

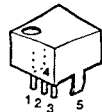
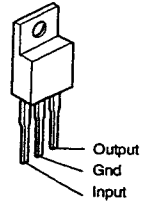

1. Vcc
2. Output
3. GND
4. Case Fin
5. Case Fin

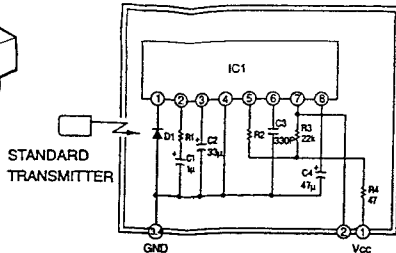

IC1 : CX20106A Chip
D1 : PIN Photo Diode Chip
C1, C2, C4 : Aluminum Electrolytic Capacitor
C3 : SL Characteristic ±5%
R1 : Gain Adjuster
R2 : fo Adjust ±1% USE
R3, R4 : ± 5%

FLD (FIP14AM7R)

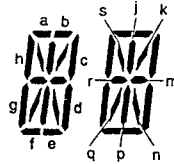
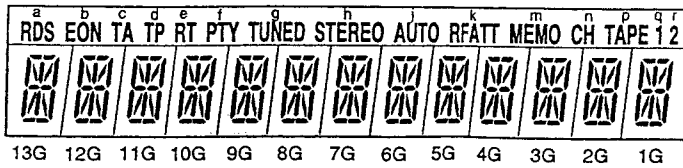
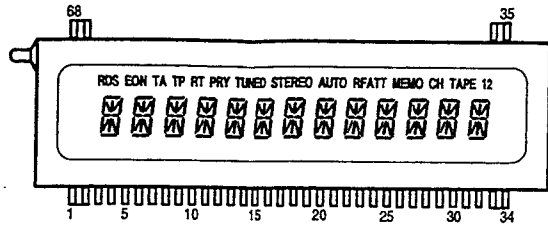

TERMINAL CONNECTION
(UPPER)

TERMINAL NO.	68	67	66	65	64	63	62	61	60	59	58	57	56	55	54	53	52				
ELECTRODE	F1	F1	NP	NP	NP	NP	NP	NP	NP	NP	NP	NP	NP	NP	NP	NP	NP				
TERMINAL NO.				51	50	49	48	47	46	45	44	43	42	41	40	39	38	37	36	35	
ELECTRODE				NP	NP	NP	NP	NP	NP	NP	NP	NP	NP	NP	NP	NP	NP	NP	NP	F2	F2

(LOWER)

TERMINAL NO.				18	19	20	21	22	23	24	25	26	27	28	29	30	31	32	33	34
ELECTRODE				P	14G	13G	12G	11G	10G	9G	8G	7G	6G	5G	4G	3G	2G	1G	F2	F2
TERMINAL NO.	1	2	3	4	5	6	7	8	9	10	11	12	13	14	15	16	17			
ELECTRODE	F1	F1	P	P	P	P	P	P	P	P	P	P	P	P	P	P				

Notes : F : Filament NP : No. Pin
G : Grid
P : Anode

● TRANSISTORS

2SA988(E/F)
2SA1515(R)
2SC1815(Y)
2SC1841(E/F)

2SB647A(C)
2SB1041(R)
2SD667A(C)

2SA933S(S)
2SA1038S(S/E)
2SC1740S(E)
2SC1740SLN(E)
2SC2058(Q)
2SC2389S(S/E)

2SB1328(P)
2SD2004(P)

2SK161(GR)

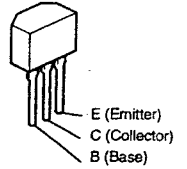
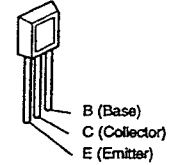
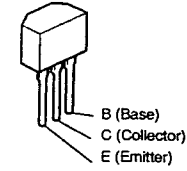
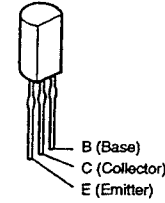
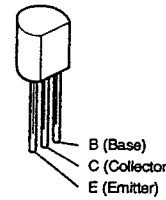

2SA1489(O/P/Y)(Z)
2SA1491(O/P/Y)(Z)
2SC3853(O/P/Y)(Z)
2SC3855(O/P/Y)(Z)

DTA143ES(4.7K-4.7K)
DTA114ES(10K-10K)
DTB123ES
DTC143ES(4.7K-4.7K)
RN-1241(A/B)
DTC144ES(47K-47K)

2SK365 (BL/GR)

DTC143ES

RN1241

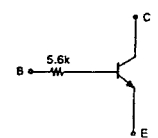
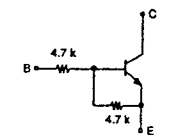
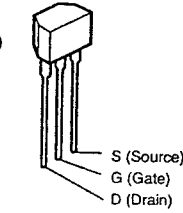
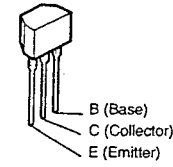
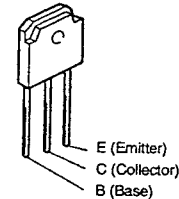

DTA143ES

DTB123ES

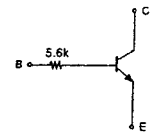
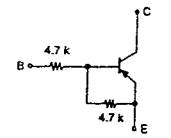

● DIODES & LED

1SS252

1S2471

MTZJ3.3A MTZJ7.5C
MTZJ6.2A MTZJ8.2B
MTZJ6.8C MTZJ27D

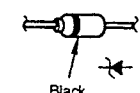
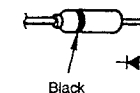
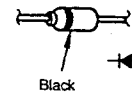

1SR35-200A

S4VB20

SFOR1A42

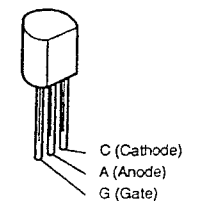
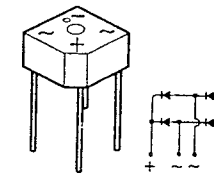
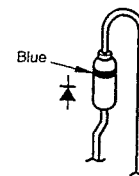

BLOCK/LEVEL DIAGRAM (DRA-565RD)

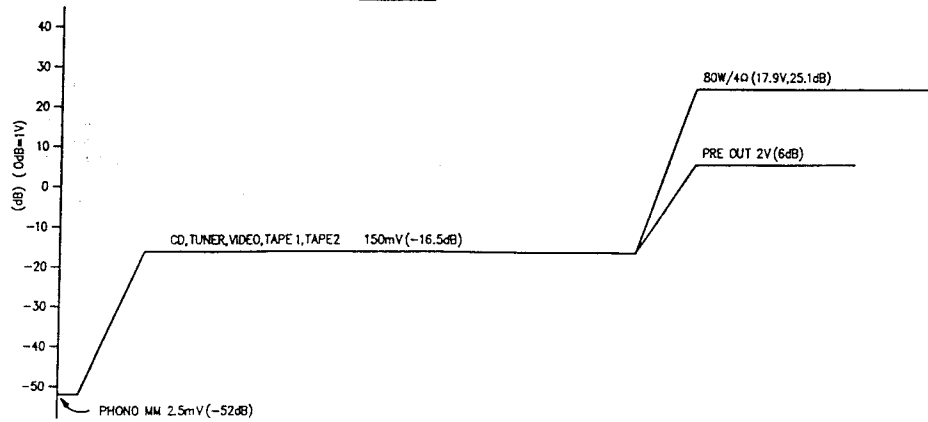
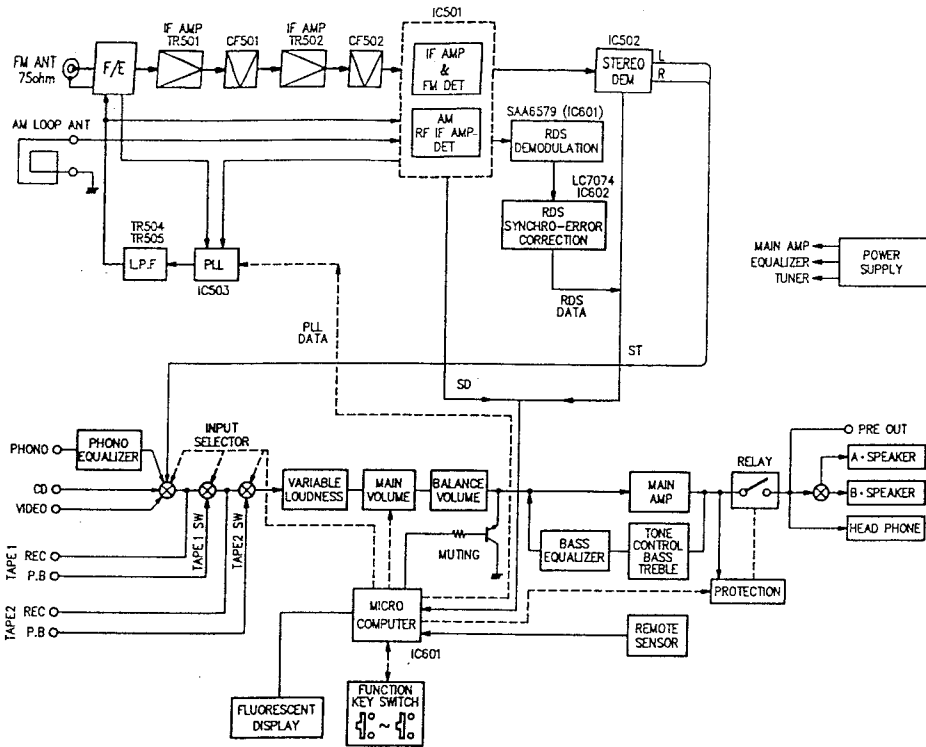

BLOCK/LEVEL DIAGRAM (DRA-365RD)

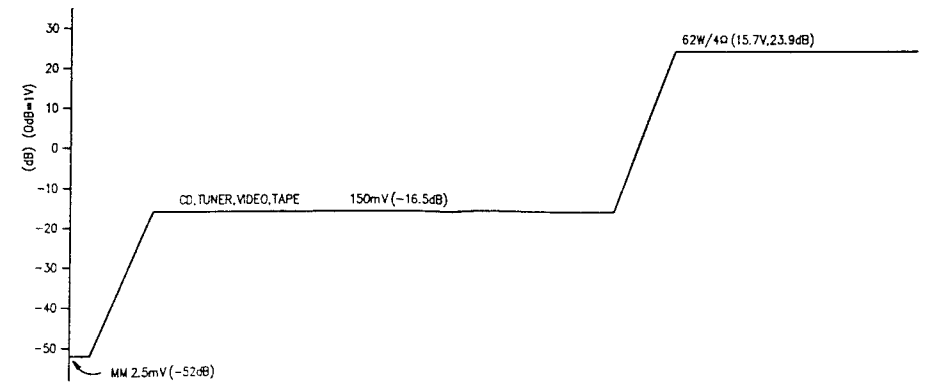
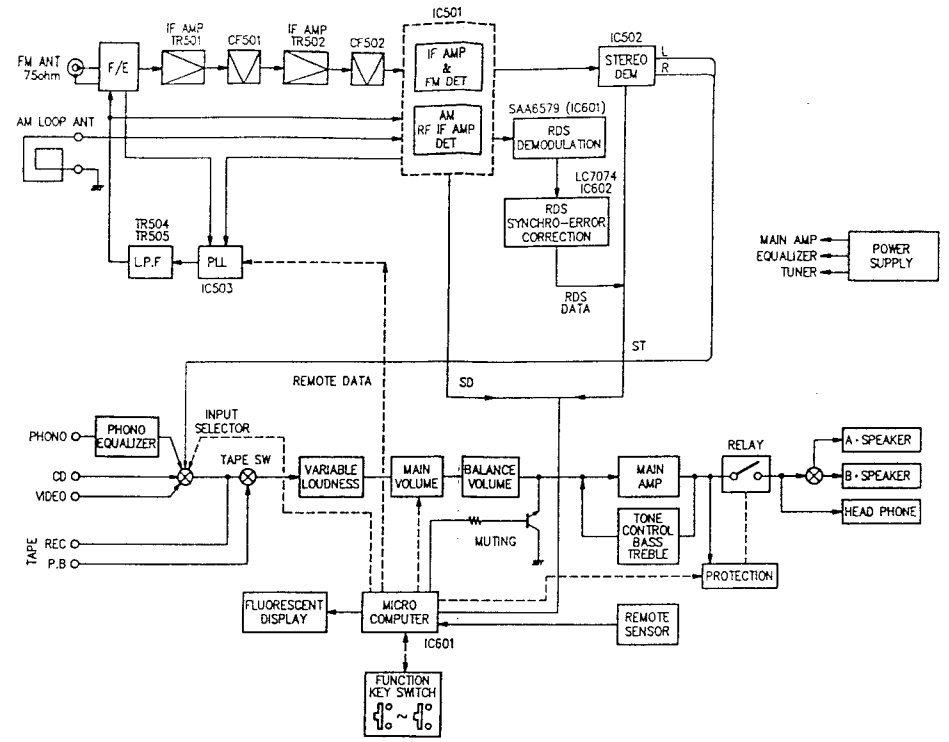

NOTE FOR PARTS LIST

- Part indicated with the mark * ◎ * are not always in stock and possibly to take a long period of time for supplying, or in some case supplying of part may be refused.
- When ordering of part, clearly indicate "1" and "1" (i) to avoid mis-supplying.
- Ordering part without stating its part number can not be supplied.
- Part indicated with the mark * * * is not illustrated in the exploded view.
- Not including Carbon Film ±5%, 1/4W Type in the P.W.Board parts list. (Refer to the Schematic Diagram for those parts.)

WARNING:

Parts marked with this symbol  have critical characteristics. Use ONLY replacement parts recommended by the manufacturer.

Resistors

RN	14K	2E	1B2	G	FR
Type	Shape and performance	Power	Resistance	Allowable error	Others
RD : Carbon	2B : 1/8W	F : ±1%	P : Pulse-resistant type		
RC : Composition	2E : 1/4W	G : ±2%	RL : Low noise type		
RS : Metal oxide film	2H : 1/2W	J : ±5%	NB : Non-burning type		
RW : Winding	3A : 1W	K : ±10%	FR : Fuse-resistor		
RH : Metal film	3D : 2W	M : ±20%	F : Lead wire forming		
RL : Metal mixture	3F : 3W				
	3H : 5W				

Resistance

1 8 2 = 1800 ohm = 1.8 kohm
Indicates number of zeros after effective number.
2-digit effective number.

Units: ohm

1 R 2 = 1.2 ohm
1-digit effective number.
2-digit effective number, decimal point indicated by R.

Units: ohm

Capacitors

CE	04W	1H	2R2	M	BP
Type	Shape and performance	Dielectric strength	Capacity	Allowable error	Others
CE : Aluminum foil electrolytic	0J : 6.3V	F : ±1%	NS : High stability type		
CA : Aluminum solid electrolytic	1A : 10V	G : ±2%	BP : Non-polar type		
CS : Tantalum electrolytic	1C : 16V	J : ±5%	HR : Ripple-resistant type		
CO : Film	1E : 25V	K : ±10%	DL : For charge and discharge		
CK : Ceramic	1V : 35V	M : ±20%	HF : For assuring high frequency		
CC : Ceramic	1H : 50V	Z : ±80%	U : UL part		
CP : Oil	2A : 100V	P : ±100%	C : CSA part		
CM : Mica	2B : 125V	D : ±50%	W : UL-CSA type		
CF : Metallized	2D : 160V	C : ±0.25pF	F : Lead wire forming		
CH : Metallized	2D : 200V	E : ±0.5pF			
	2E : 250V	= : Others			
	2H : 500V				
	2J : 630V				

Capacity (electrolyte only)

2 2 = 2200µF
Indicates number of zeros after effective number.
2-digit effective number.

Units: µF.

2 R 2 = 2.2µF
1-digit effective number.
2-digit effective number, decimal point indicated by R.

Units: µF.

Capacity (except electrolyte)

2 2 2 = 2200pF = 0.0022µF
(More than 2) — Indicates number of zeros after effective number.
2-digit effective number.

Units: µF.

2 2 1 = 220pF
(0 or 1) — Indicates number of zeros after effective number.
2-digit effective number.

Units: pF.

* When the dielectric strength is indicated in AC, "AC" is included after the dielectric strength value.

PRINTED WIRING BOARD PARTS LIST
1U-2731B MAIN UNIT (DRA-565RD)

Ref. No.	Part No.	Part Name	Remarks	Ref. No.	Part No.	Part Name	Remarks
SEMICONDUCTORS GROUP							
IC101	263 0609 002	IC NJM2068DDC		△ F267-390	241 2377 989	Carbon 150ohm 1/4W	RD14B2E151.NBS
IC102	262 1227 008	IC LC7821		△ F269-394	244 2051 957	Metallic 4.7ohm 1W	RS14B3A4R7.NBS(S)
IC201	263 0476 002	IC LB1639		△ F401	244 2051 987	Metallic 4.7ohm 1W	RS14B3A4R7.NBS(S)
IC301	263 0665 007	IC BA15218		△ F403	244 2055 954	Metallic 150ohm 1W	RS14B3A151.NBS(S)
IC401	263 0793 002	IC NJM7806FA(S)		△ F408	244 2387 908	Carbon 10ohm 1/4W	RD14B2E101.NBS
IC601	262 1701 906	IC SA66579T		△ F411	241 2377 947	Carbon 10ohm 1/4W	RD14B2E101.NBS
IC602	262 1929 908	IC LC704NM-TE-R		△ F471	244 2055 996	Metallic 1.2kohm 1W	RS14B3A122.NBS(S)
				△ F474	244 2051 990	Metallic 4.7kohm 1W	RS14B3A472.NBS(S)
TR201	269 0022 904	Transistor DTA143ES(4.7K-4.7K)		VR102	211 0831 002	Variable 100kohm	V1620V25F=104R(MG)
TR251	274 0151 903	Transistor 2SD2004(P)		VR201	211 0830 003	Variable 100kohm	V14V20FB104K
TR252	272 0107 906	Transistor 2SB1328(P)		VR251	211 0827 003	Variable 250kohm	V11V20FW254K
TR253	273 0388 906	Transistor 2SC1740S(E)		VR301	211 0828 002	Variable 250kohm	V14V20FC254K
TR254	271 0192 905	Transistor 2SA933S(S)		VR303	211 0829 001	Variable 50kohm	V14V20FCS03K
TR255	273 0432 904	Transistor 2SC2389S(S/E)		VR305,306	211 6093 912	Semr Fixed Resistor 4.7Kohm	V06PB472
TR256	271 0280 901	Transistor 2SA1038S(E)		Europe Model Only (Except for U.K.)			
TR257	273 0388 906	Transistor 2SC1740S(E)					
TR301,302	269 0107 900	Transistor RN1241(A/B)					
TR303,304	273 0235 923	Transistor 2SC1841(E/F)					
TR305-308	271 0131 924	Transistor 2SA988(E/F)					
TR309,310	273 0235 923	Transistor 2SC1841(E/F)					
TR315,316	273 0198 002	Transistor 2SC1815(Y)					
TR317,318	274 0151 903	Transistor 2SD2004(P)					
TR319,320	272 0107 906	Transistor 2SB1328(P)					
TR325,326	273 0235 923	Transistor 2SC1841(E/F)					
TR327	271 0131 924	Transistor 2SA988(E/F)					
TR401	272 0131 901	Transistor 2SB1041(R)					
TR402,403	273 0388 906	Transistor 2SC1740S(E)					
TR451	273 0388 906	Transistor 2SC1740S(E)					
TR452	269 0018 905	Transistor DTC143ES(4.7K-4.7K)					
TR453	273 0388 906	Transistor 2SC1740S(E)					
TR472,473	273 0388 906	Transistor 2SC1740S(E)					
TR474	271 0192 905	Transistor 2SA933S(S)					
TR475	273 0388 906	Transistor 2SC1740S(E)					
TR478,479	269 0040 902	Transistor DTC144ES(4.7K-4.7K)					
D202-204	276 0616 907	Diode 1SS252					
D303-306	276 0619 904	Diode 1S2471					
D907-312	276 0616 907	Diode 1SS252					
D401	276 0616 907	Diode 1SS252					
D402-404	276 0553 905	Diode 1SR35-200A					
D405	276 0338 007	Diode 54VB20F					
D406	276 0616 907	Diode 1SS252					
D407-410	276 0553 905	Diode 1SR35-200A					
D451	276 0616 907	Diode 1SS252					
D452	276 0616 907	Diode 1SS252					
D471	276 0616 907	Diode 1SS252					
ZD251,252	276 0637 902	Zener Diode MTZJ6.2A					
ZD401	276 0632 907	Zener Diode MTZL27D					
ZD451	276 0634 905	Zener Diode MTZJ3.3A					
ZD452	276 0633 906	Zener Diode MTZJ6.8C					
ZD471	276 0635 904	Zener Diode MTZJ7.5C					
SC471	279 0016 904	Thyristor SF0R1A42					
RESISTORS GROUP							
△ F205-208	244 2050 933	Metallic 180ohm 1W	RS14B3A181.NBS(S)				
△ F265,266	241 2387 940	Carbon 4.7ohm 1/4W	RD14B2E471.NBS				
△ F311,312	241 2378 932	Carbon 620ohm 1/4W	RD14B2E621.NBS				
△ F329,330	241 2378 920	Carbon 220ohm 1/4W	RD14B2E221.NBS				
△ F331-338	244 2043 982	Metallic 0.22ohm 1W	RS14B3A022.NBS(S)				
△ F343-345	241 2378 987	Carbon 1kohm 1/4W	RD14B2E102.NBS				
△ F385,386	241 2378 932	Carbon 620ohm 1/4W	RD14B2E621.NBS				
C101,102	253 1179 945	Ceramic 220pF50V	CK45B1H221K				
C103,104	254 4254 909	Electrolytic 10µF16V	CE04W1C100M				
C105,106	254 4254 925	Electrolytic 33µF16V	CE04W1C330M				
C107,108	253 4537 966	Ceramic 47pF50V	CC45SL1H470J				
C109,110	255 1264 999	Film 5600pF50V	CO93M1H562J(B)				
C111,112	255 1264 924	Film 1500pF50V	CO93M1H152J(B)				
C113,114	254 4254 909	Electrolytic 10µF16V	CE04W1C100M				
C115,116	253 1181 917	Ceramic 0.022µF50V	CK45F1H223Z				
C121-128	253 4357 982	Ceramic 56pF50V	CC45SL1H560J				
C129-131	253 1181 917	Ceramic 0.022µF50V	CK45F1H223Z				
C133	253 1181 917	Ceramic 0.022µF50V	CK45F1H223Z				
C135	253 1181 917	Ceramic 0.022µF50V	CK45F1H223Z				
C136	254 4260 948	Electrolytic 1µF50V	CE04W1H010M				
C141,142	255 1264 908	Film 1000pF50V	CO93M1H102J(B)				
C151	253 1146 907	Ceramic 0.01µF50V	CK45F1H103Z				
C183	253 1181 917	Ceramic 0.022µF50V	CK45F1H223Z				
C201-204	255 1264 982	Film 4700pF50V	CO93M1H472J(B)				
C205,210	253 1179 903	Ceramic 100pF50V	CK45B1H101K				
C211	254 4260 948	Electrolytic 1µF50V	CE04W1H010M				
C213,214	255 1265 978	Film 0.22µF50V	CO93M1H223J(B)				
C215,216	253 1179 990	Ceramic 560pF50V	CK45B1H561K				
C217	253 1181 917	Ceramic 0.022µF50V	CK45F1H223Z				
C218,219	254 4254 909	Electrolytic 10µF16V	CE04W1C100M				
C220	254 4252 927	Electrolytic 47µF10V	CE04W1A470M				
C221	254 4260 948	Electrolytic 1µF50V	CE04W1H010M				
C225,226	253 1146 907	Ceramic 0.01µF50V	CK45F1H103Z				
C251	254 4256 952	Electrolytic 220µF25V	CE04W1E221M				
C252-254	254 4258 918	Electrolytic 10µF50V	CE04W1V100M				
C301,302	254 4260 948	Electrolytic 1µF50V	CE04W1H010M				
C303,304	254 4260 922	Electrolytic 0.33µF50V	CE04W1HR33M				
C305,306	253 1179 903	Ceramic 100pF50V	CK45B1H101K				
C307,308	253 4537 966	Ceramic 47pF50V	CC45SL1H470J				
C311-316	253 4536 909	Ceramic 10pF50V	CC45SL1H100D				
C323,234	254 4260 948	Electrolytic 1µF50V	CE04W1H010M				
C325,326	255 1265 978	Film 0.22µF50V	CO93M1H223J(B)				
C327-330	254 4262 904	Electrolytic 4.7µF63V	CE04W1J477M				
C331,332	255 1265 907	Film 6800pF50V	CO93M1H682J(B)				
C333,334	254 4254 925	Electrolytic 33µF16V	CE04W1C330M				
C335,336	253 1179 903	Ceramic 100pF50V	CK45B1H101K				
C337,338	255 1265 981	Film 0.27µF50V	CO93M1H273J(B)				
C339,340	256 1034 982	Film 0.012µF50V	CF93A1H124J				
C341,342	255 1264 924	Film 1500pF50V	CO93M1H152J(B)				
C343,344	255 1265 936	Film 0.1µF50V	CO93M1H103J(B)				
C345,346	254 4260 948	Electrolytic 1µF50V	CE04W1H010M				
C347	255 1265 936	Film 0.1µF50V	CO93M1H103J(B)				
C348	254 4263 945	Electrolytic 1µF100V	CE04W2A010M				

PRINTED WIRING BOARD PATTERNS

1 2 3 4 5 6 7 8

1U-2731B MAIN UNIT (DRA-565RD)

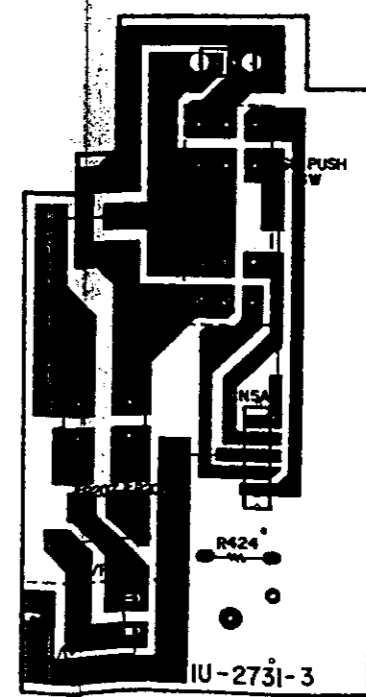
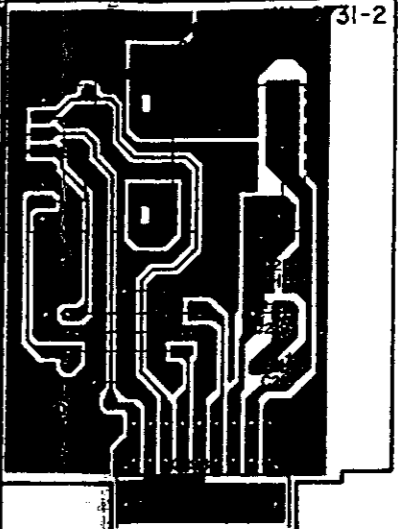
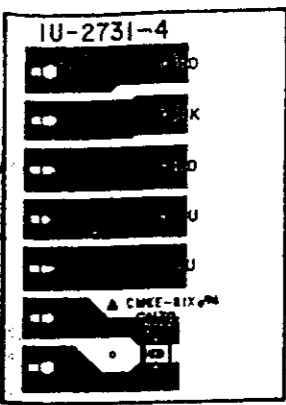
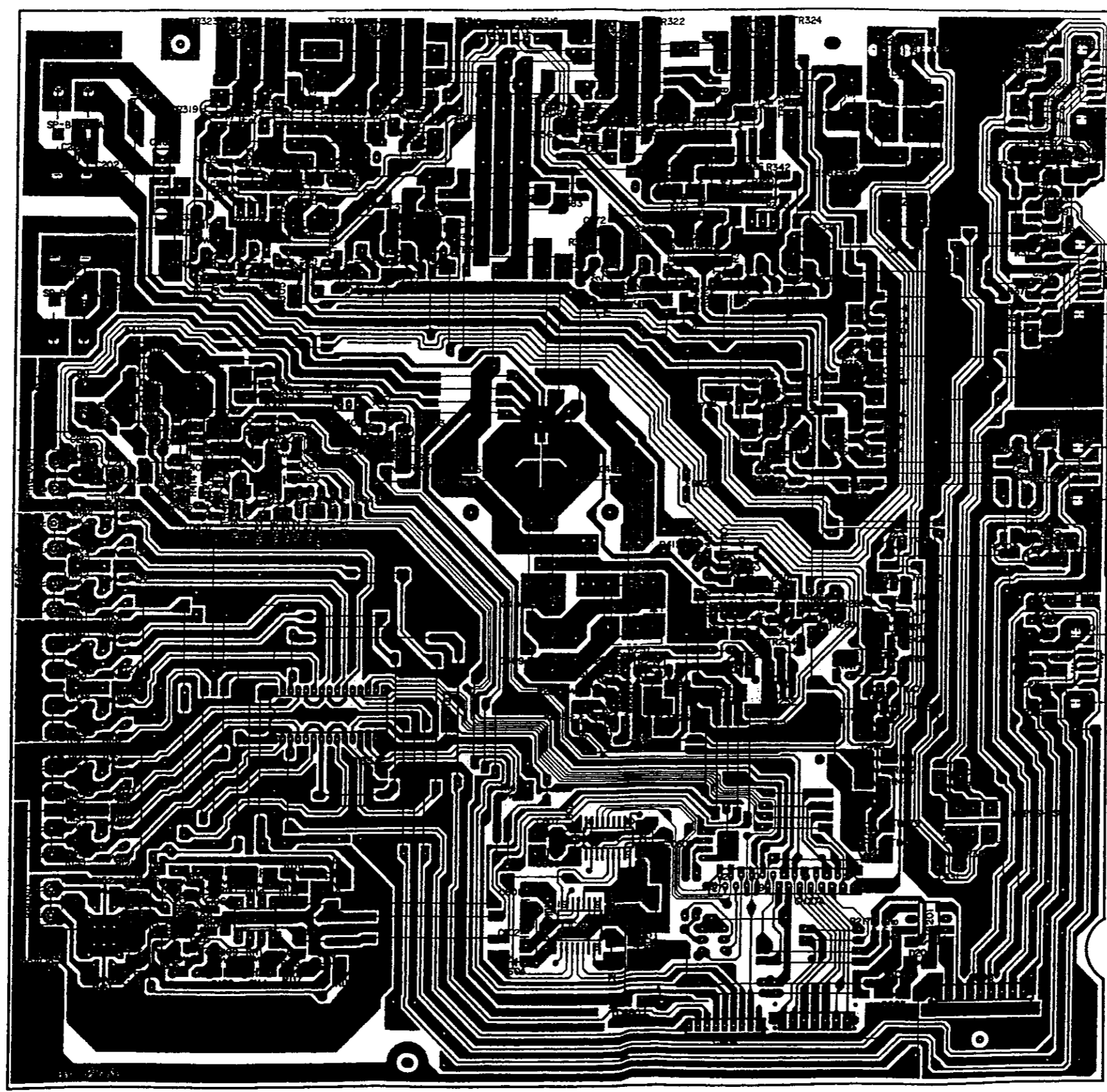

*
 CN3F
 TR402
 TR403
 C405
 R402
 R403
 R406
 R407
 Europe Model Only
 (Except For U.K.)

A
 B
 C
 D
 E

1 2 3 4 5 6 7 8

1U-2731 MAIN UNIT (DRA-365RD)

A
B
C
D
E

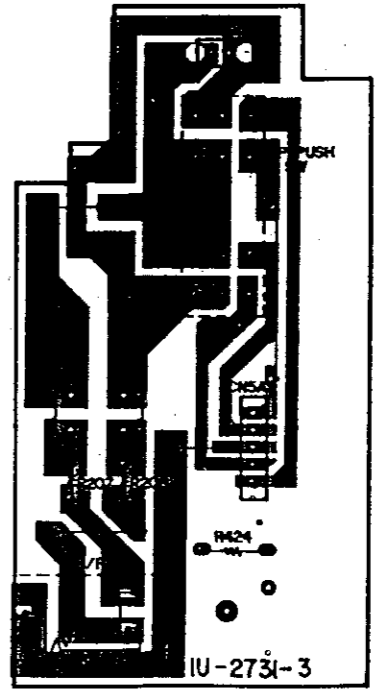
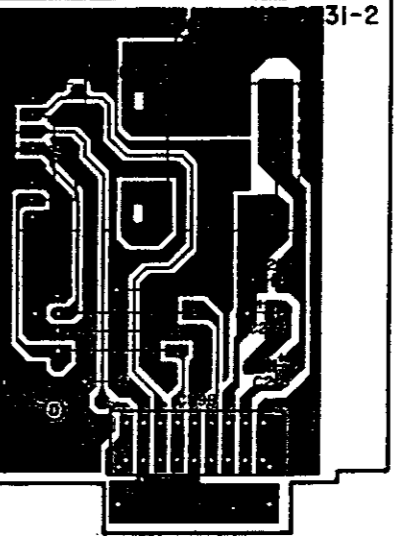
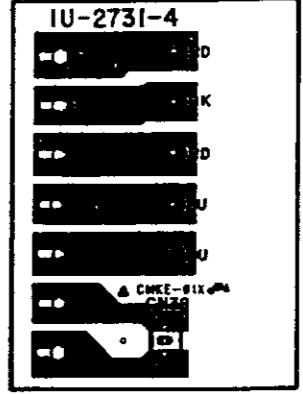
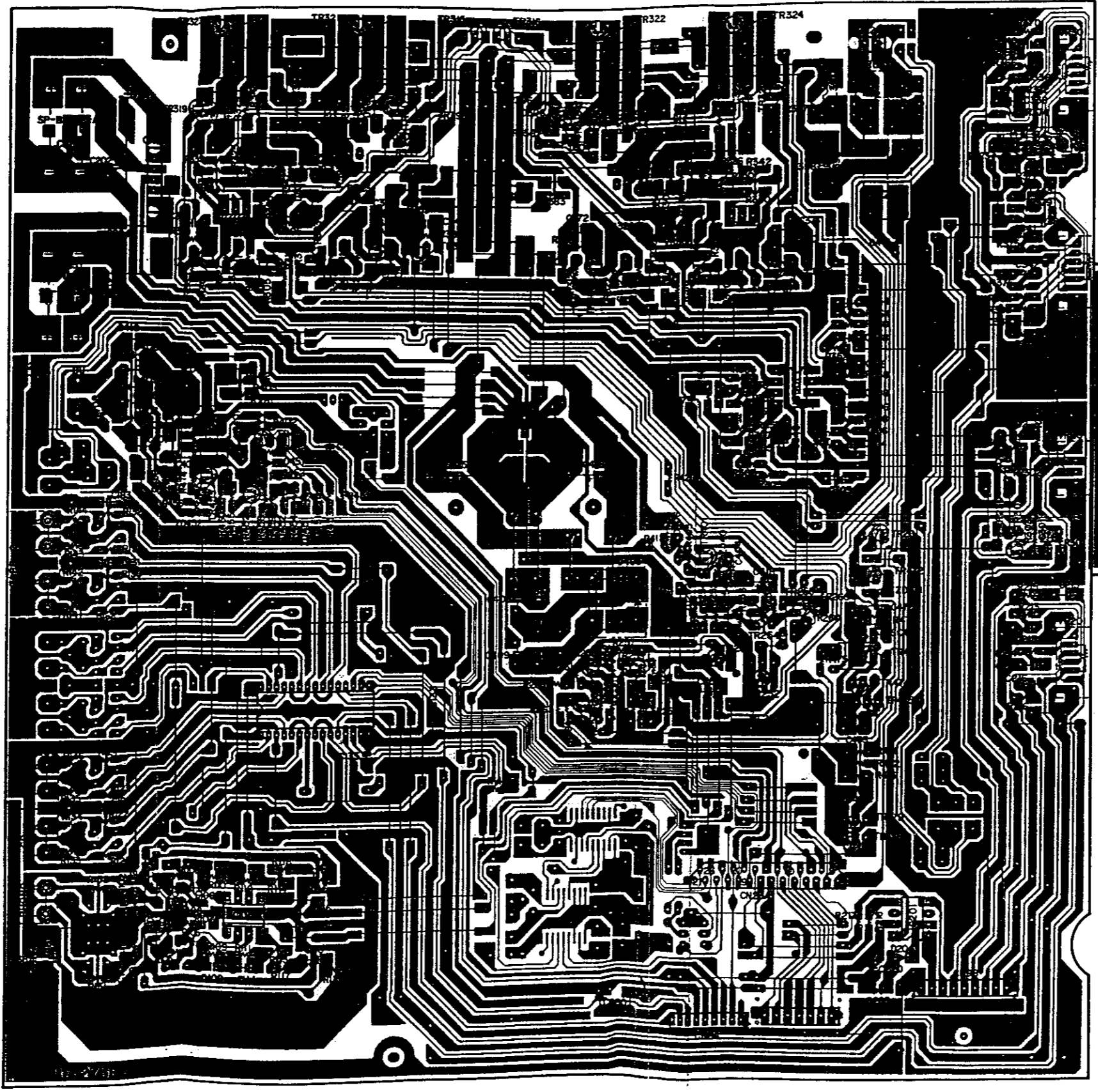

1U-2732B TUNER & DISPLAY (DRA-565RD)

CN3F
 F402
 D411
 RL401
 C410
 AC OUTLET

※
 Europe Model Only
 (Except For U.K.)

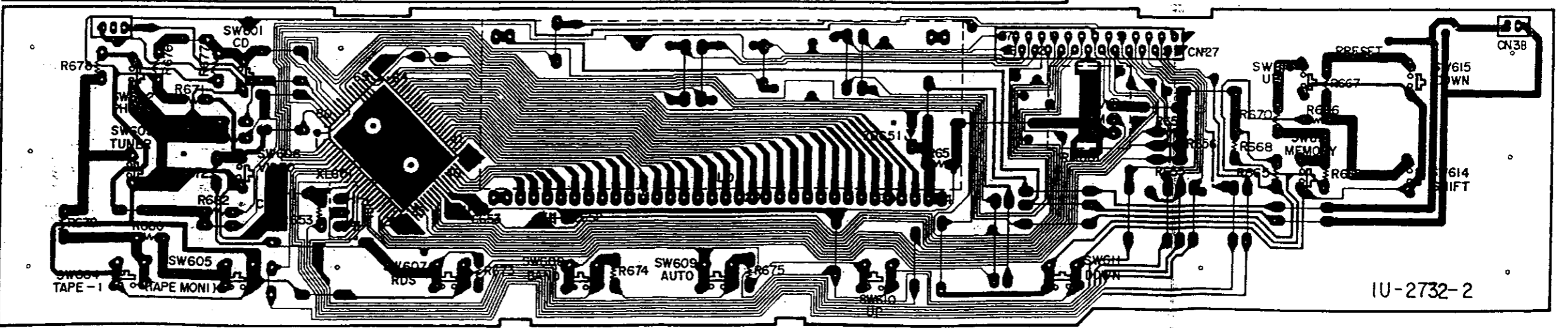
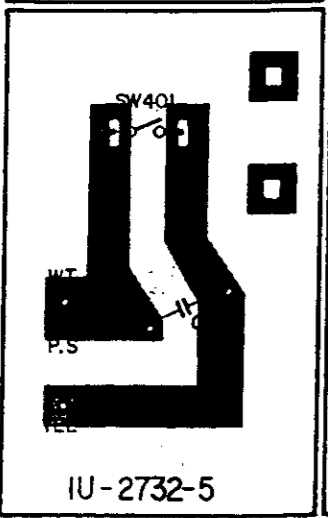
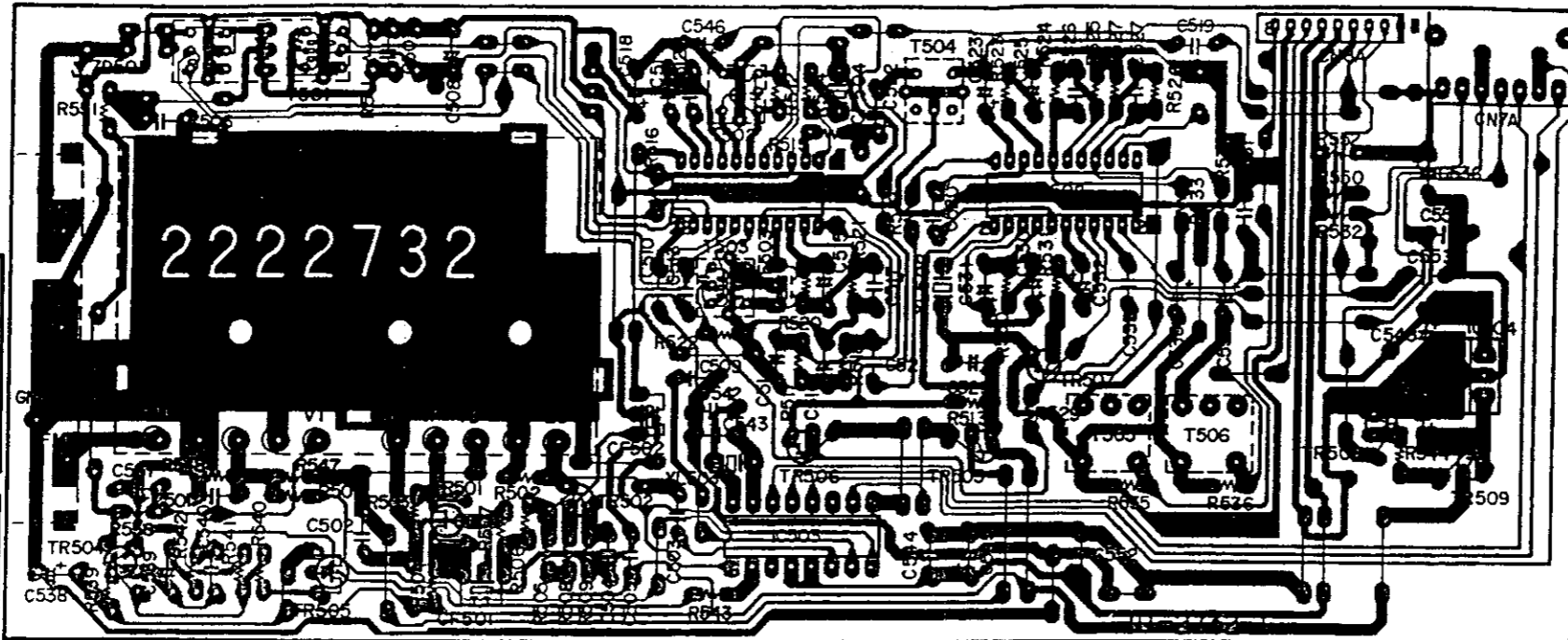
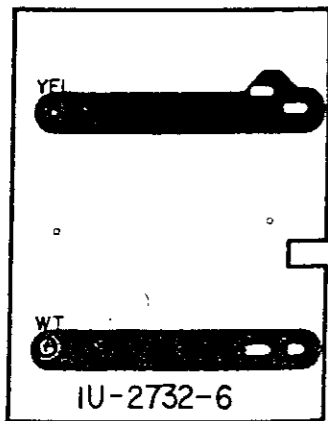
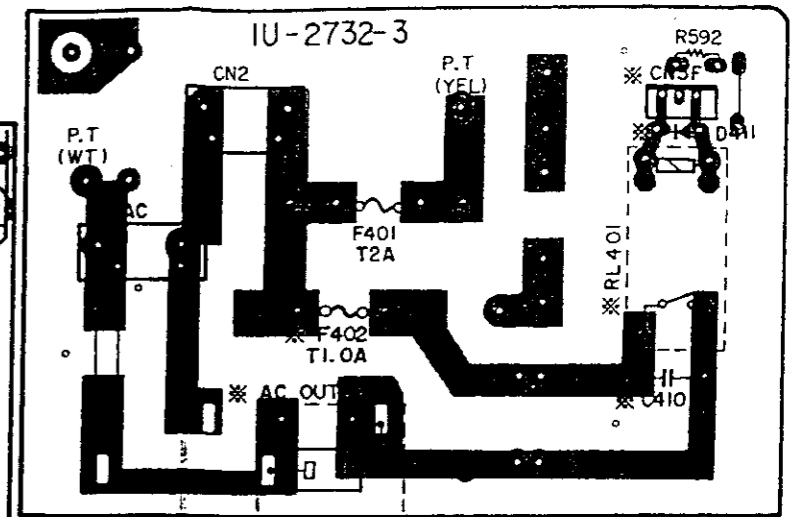

A
 B
 C
 D
 E

1 2 3 4 5 6 7 8

1U-2732 TUNER & DISPLAY UNIT (DRA-365RD)

* F402 } Europe Model Only
AC OUTLET } (Except For U.K.)

A

B

C

D

E

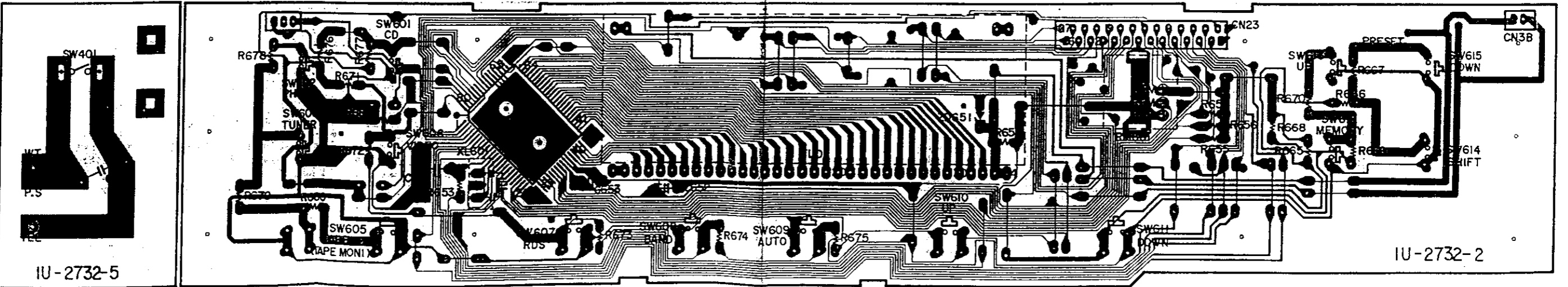
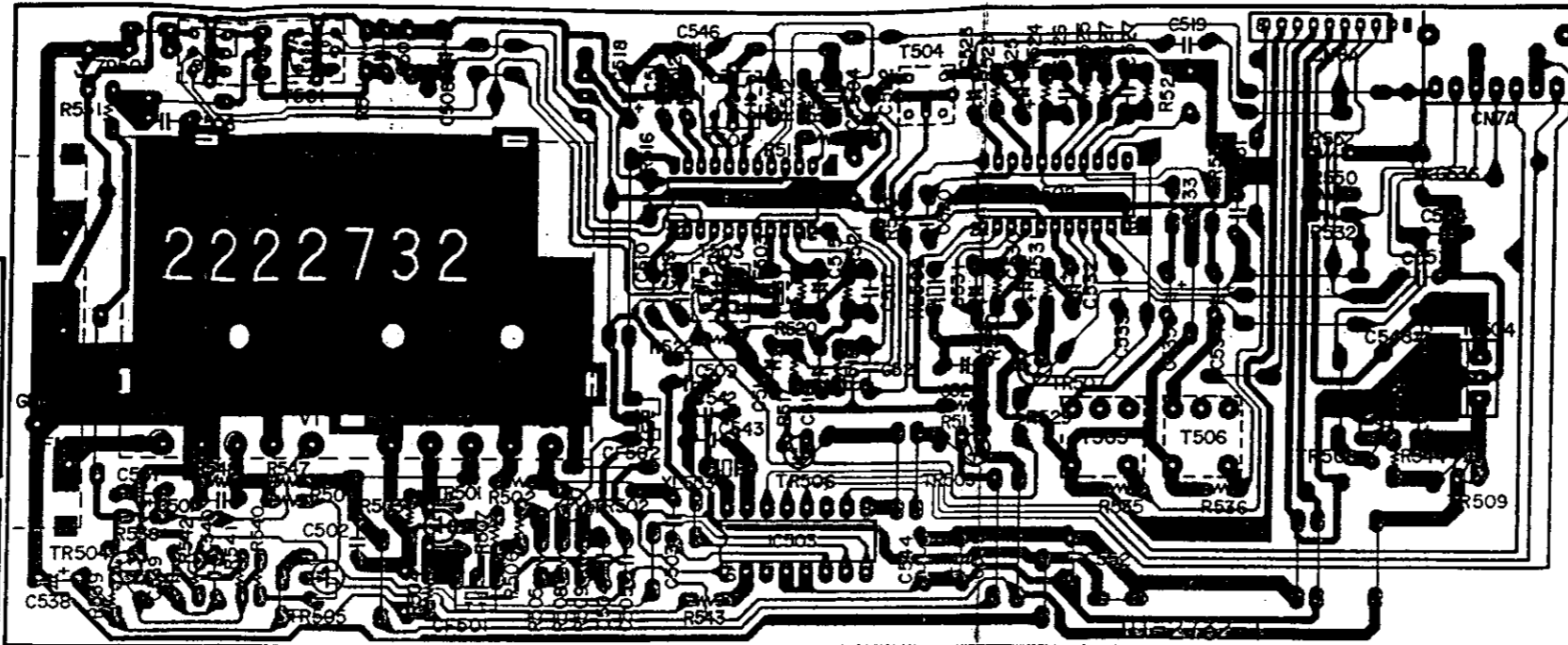
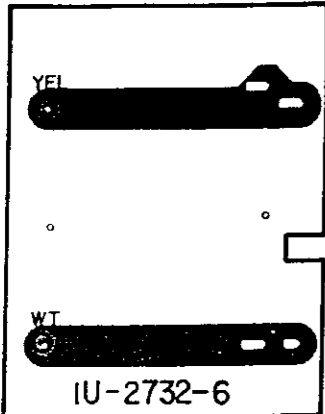
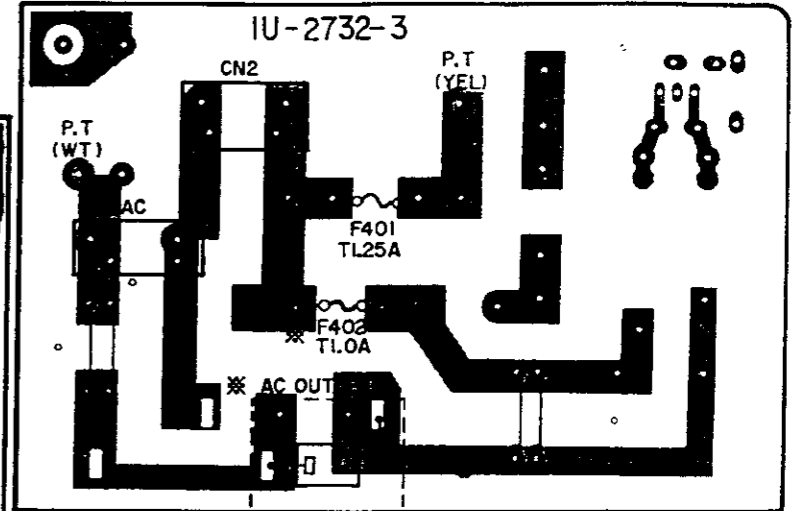

IU-2732-2

WIRING DIAGRAM

1

2

3

4

DRA-565RD

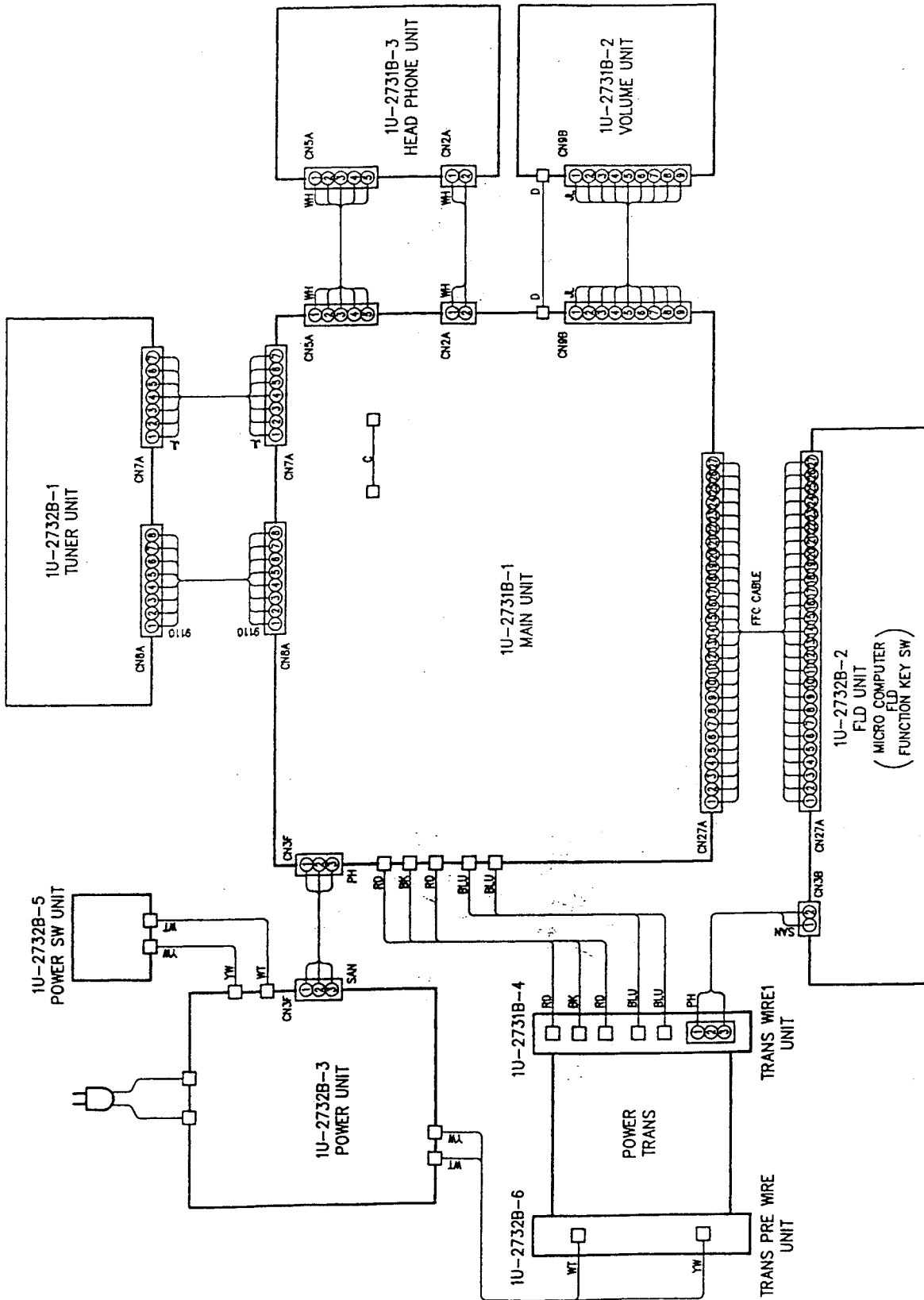

5

6

7

8

DRA-365RD

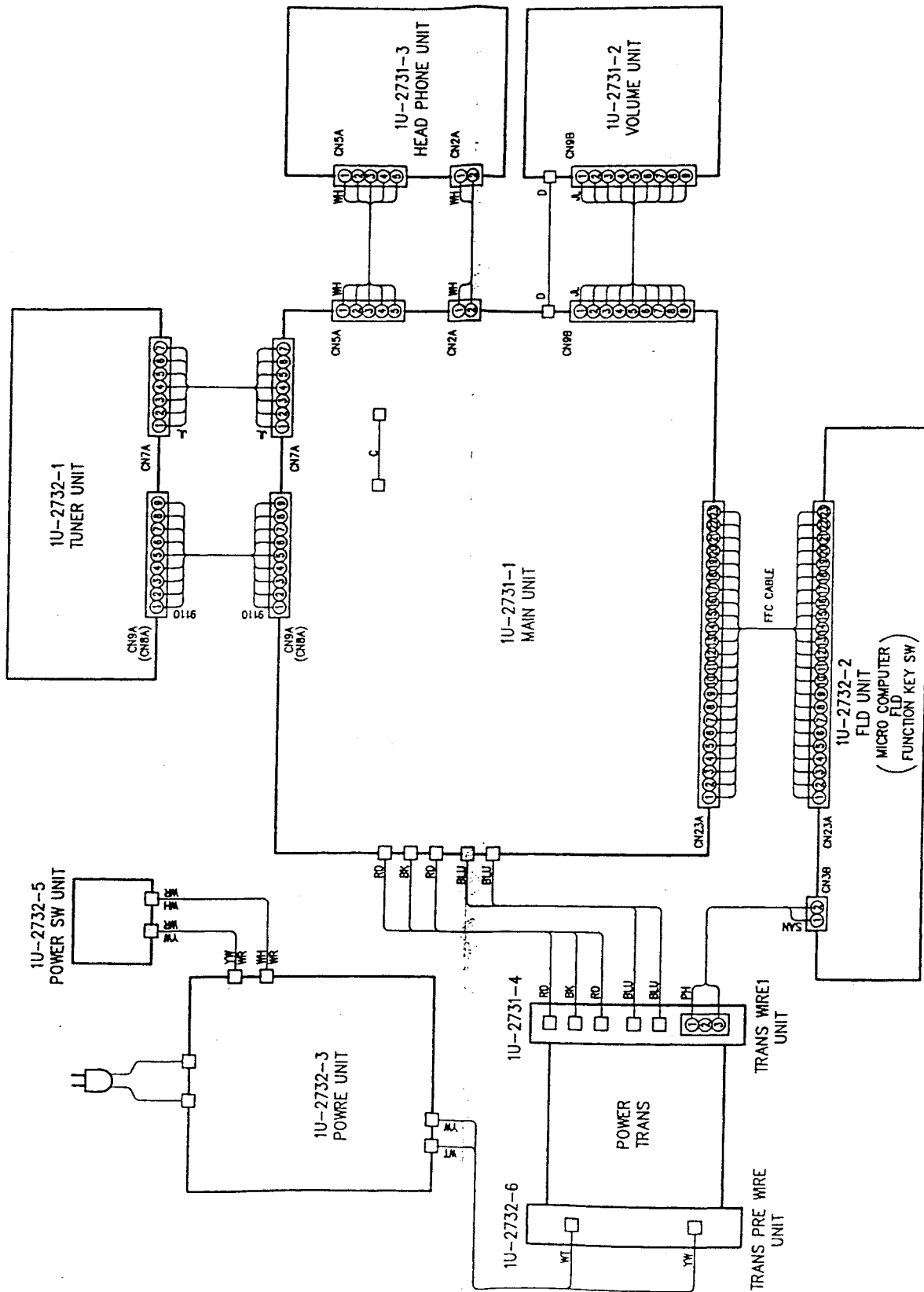

A

B

C

D

E

PARTS LIST EXPLODED VIEW (DRA-565RD)

Ref. No.	Part No.	Part Name	Remarks	Q'ty	Ref. No.	Part No.	Part Name	Remarks	Q'ty
1	1U-2731 B	MAIN UNIT ASSY		1	48	102 0520 129	TOP COVER		1
1-1	---	MAIN UNIT			49	461 0769 009	RUBBER SHEET		2
1-2	---	VOLUME UNIT			50	122 0146 015	HIMERON SHEET		1
1-3	---	HEAD PHONE UNIT			51	445 0048 003	CORD HOLDER (L=76)		2
1-4	---	TRANS WIRE 1 UNIT			52	009 0112 005	Z7P FFC CORD		1
2	1U-2732 B	TUNER/DISPLAY UNIT ASSY		1	53	254 4374 708	ELECTROLYTIC 8200µF56V		1
2-1	---	TUNER UNIT			54	412 2955 107	SIDE BRACKET		1
2-2	---	DISPLAY UNIT			SCREWS				
2-3	---	POWER UNIT			101	473 7015 018	TAPING SCREW 3x8 (S)	Black	4
2-5	---	POWER SW UNIT			102	473 7002 018	TAPING SCREW 3x8 (S)		10
2-6	---	TRANS PRE WIRE UNIT			103	473 8007 009	CUP SCREW 3x12		4
5	204 8354 004	HEAD PHONE JACK		1	104	473 7501 001	TAPING SCREW 3x10 (P)		3
6	214 9003 005	RELAY	RL471	1	105	477 0064 107	FDING SCREW 3x10	Black	12
7	211 0827 003	VARIABLE	VR251	2	106	473 7004 016	TAPING SCREW 4x6 (S)		4
8	211 0828 002	VARIABLE	VR301	1	107	473 7508 017	TAPING SCREW 3x10 (P)	Black	14
9	211 0829 001	VARIABLE	VR303	1	108	477 0263 005	3P SWELLING SCREW		4
10	211 0830 003	VARIABLE	VR201	1	109	473 7002 005	TAPING SCREW 3x8 (S)		9
11	211 0831 002	VARIABLE	VR102	1	PACKING AND ACCESSORIES (not included EXPLODED view)				
12	204 8466 002	4 PIN JACK		1	505 9125 009	POLY COVER		1	
13	204 8467 001	6P PIN JACK		2	511 2637 007	OPERATING INSTRUCTION		1	
14	212 4778 009	2P PUSH SWITCH		1	231 1314 003	AM LOOP ANTENNA		1	
15	212 1074 007	1P PUSH SWITCH	SW601-615	1	395 0023 008	FM ANTENNA ASSY		1	
16	212 5604 910	TACT SWITCH		15	399 0242 001	REMOTE CONTROL UNIT	RC-174	1	
17	303 4155 002	FLD	PIP14AM7R	1	505 0131 050	CABINET COVER		1	
18	499 0150 008	REMOTE SENSOR	SBX1610-52	1	504 0125 005	STYRENE PAPER	For AC CORD	1	
19	218 0065 006	FRONT END		1	503 1140 002	CUSHION		2	
20	206 1015 029	FUSE 1A	F402	1	502 0741 056	PAD	U.K. Model Only	1	
21	205 0847 004	3P ANTENNA TERMINAL	Europe Model Only (Except for U.K.)	1	501 1783 010	CARTON CASE	Europe Model	1	
22	213 3942 007	AC OUTLET	Europe Model Only (Except for U.K.)	1	501 1783 023	CARTON CASE	U.K. Model	1	
23	214 0176 009	RELAY(GSP-1)	RL401	1					
24	212 1030 009	POWER SWITCH(IV-5)	Europe Model (Except for U.K.)	1					
25	206 1015 081	FUSE 2A	F401	1					
26	205 0484 001	8P SPEAKER TERMINAL	Europe Model	1					
27	461 0539 022	RUBBER SHEET	U.K. Model	1					
28	411 1285 006	MAIN CHASSIS		1					
29	105 1136 029	REAR PANEL	Europe Model	1					
30	104 0194 108	FOOT ASSY	U.K. Model	1					
31	417 0498 205	POWER RADIATOR		1					
32	273 0389 002	TRANSISTOR	TR321,322	2					
33	271 0240 006	TRANSISTOR	TR323,324	2					
34	415 0234 007	INSULATING SHEET		4					
35	412 3767 006	P.W.B. BRACKET		2					
36	208 2091 000	AC CORD WITH CONNECTOR	Europe Model	1					
37	445 0056 009	CORD BUSH	U.K. Model	1					
38	229 6116 006	POWER TRANS		1					
39	146 1495 127	INNER PANEL		1					
40	143 0880 006	WINDOW		1					
41	113 1679 008	BUTTON(4KEY)		2					
42	113 1680 107	BUTTON(7KEY)		1					
43	113 1558 006	PUSH BUTTON(KAKU)		3					
44	144 2370 119	FRONT PANEL		1					
45	112 0647 009	VOLUME KNOB		1					
46	112 0739 001	KNOB(MARU)		4					
47	113 9213 000	POWER BUTTON ASSY		1					

PARTS LIST EXPLODED VIEW (DRA-365RD)

Ref. No.	Part No.	Part Name	Remarks	Q'ty	Ref. No.	Part No.	Part Name	Remarks	Q'ty
1	1U-2731	MAIN UNIT ASSY		1	50	122 0146 015	HIMERON SHEET		1
1-1	---	MAIN UNIT			51	445 0048 003	CORD HOLDER (L=76)		1
1-2	---	VOLUME UNIT			52	009 0112 005	27P PFC CORD		1
1-3	---	HEAD PHONE UNIT			53	254 4355 002	ELECTROLYTIC 6800µF/50V		2
1-4	---	TRANS WIRE 1 UNIT			54	412 2855 107	SIDE BRACKET		1
2	1U-2732	TUNER/DISPLAY UNIT ASSY		1	SCREWS				
2-1	---	TUNER UNIT			101	473 7015 018	TAPING SCREW 3x8 (S)	Black	4
2-2	---	DISPLAY UNIT			102	473 7002 018	TAPING SCREW 3x8 (S)		10
2-3	---	POWER UNIT			103	473 8007 009	CUP SCREW 3x12		4
2-5	---	POWER SW UNIT			104	473 7501 001	TAPING SCREW 3x10 (P)		2
2-6	---	TRANS PRE WIRE UNIT			105	477 0064 107	FIXING SCREW 3x10	Black	10
5	204 8354 004	HEAD PHONE JACK		1	106	473 7004 016	TAPING SCREW 4x8 (S)		4
6	214 9003 005	RELAY	FL471	1	107	473 7508 017	TAPING SCREW 3x10 (P)	Black	14
7	211 0627 003	VARIABLE <i>Var. Loud.</i>	VR251	2	108	477 0263 005	3P SWELLING SCREW		4
8	211 0628 002	VARIABLE <i>Bass</i>	VR301	1	109	473 7002 005	TAPING SCREW 3x6 (S)		9
9	211 0629 001	VARIABLE <i>Treble</i>	VR303	1	PACKING AND ACCESSORIES (not included EXPLODED view)				
10	211 0630 003	VARIABLE <i>Bal.Loud</i>	VR201	1	505 9125 009	POLY COVER			1
11	211 0631 002	VARIABLE <i>Volume</i>	VR102	1	511 2637 007	OPERATING INSTRUCTION			1
12	204 8466 002	4P PIN JACK		1	231 1914 003	AM LOOP ANTENNA			1
13	204 8467 001	6P PIN JACK		2	395 0023 008	FM ANTENNA ASSY			1
14	212 4778 009	2P PUSH SWITCH		1	399 0242 001	REMOTE CONTROL UNIT	RC-174		1
15	---	---			505 0131 050	CABINET COVER			1
16	212 5604 910	TACT SWITCH		14	504 0125 005	STYRENE PAPER	For AC CORD		1
17	393 4155 002	FLD	FB14AM7R	1	503 0939 007	CUSHION			2
18	499 0150 008	REMOTE SENSOR	SBX1610-52	1	502 0741 056	PAD	U.K. Model Only		1
19	216 0065 006	FRONT END		1	501 1782 011	CARTON CASE	Europe Model		1
20	206 2061 000	AC CORD WITH CONNECTOR	Europe Model Only (Except for U.K.)	1	501 1782 024	CARTON CASE	U.K. Model		1
21	205 0647 004	3P ANTENNA TERMINAL		1					
22	223 3942 007	AC OUTLET	Europe Model Only (Except for U.K.)	1					
23	---	---							
24	212 3030 009	POWER SWITCH (TV-5)		1					
25	206 2061 000	ELSE J 2SA	ES01	1					
26	205 0484 001	8P SPEAKER TERMINAL	Europe Model	1					
27	205 0472 013	8P SPEAKER TERMINAL	U.K. Model	1					
28	461 0539 022	RUBBER SHEET		1					
29	411 1285 006	MAIN CHASSIS		1					
30	105 1135 020	REAR PANEL	Europe Model	1					
31	105 1136 033	REAR PANEL	U.K. Model	1					
32	104 0194 108	FOOT ASSY		4					
33	417 0498 218	POWER RADIATOR		2					
34	273 0396 005	TRANSISTOR 2SC3854(OP/YXZ)	TR321,322	2					
35	271 0237 006	TRANSISTOR 2SA1490(OP/YXZ)	TR323,324	2					
36	415 0234 007	INSULATING SHEET		4					
37	412 3767 006	P.W.B. BRACKET		2					
38	206 2061 000	AC CORD WITH CONNECTOR	Europe Model	1					
39	206 2109 002	AC CORD WITH CONNECTOR	U.K. Model	1					
40	445 0056 006	CORD BUSH		1					
41	233 6115 007	POWER TRANS		1					
42	146 1493 129	INNER PANEL		1					
43	143 0880 006	WINDOW		1					
44	113 1679 008	BUTTON(4KEY)		2					
45	113 1680 110	BUTTON(6KEY)		1					
46	---	---		3					
47	144 2369 010	FRONT PANEL		1					
48	112 0647 009	VOLUME KNOB		1					
49	112 0739 001	KNOB(MARU)		4					
50	113 9213 000	POWER BUTTON ASSY		1					
51	102 0426 223	TOP COVER		1					
52	461 0769 009	RUBBER SHEET		2					

EXPLODED VIEW OF CHASSIS AND CABINET

1 2 3 4 5 6 7 8

DRA-365RD

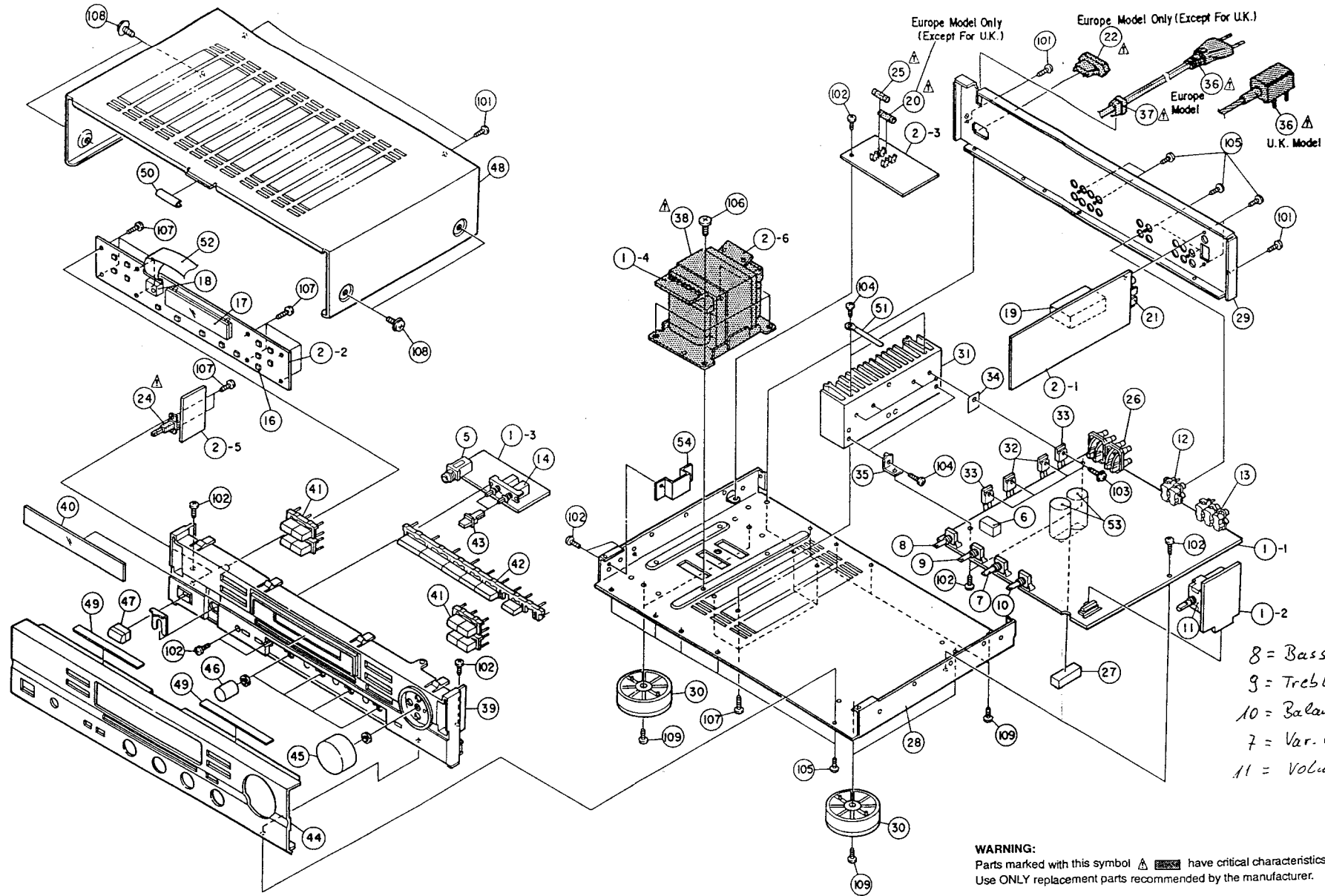

Europe Model Only (Except For U.K.)

Europe Model Only (Except For U.K.)

Europe Model

U.K. Model

8 = Bass
 9 = Treble
 10 = Balance
 7 = Var. Loud.
 11 = Volume

WARNING:
 Parts marked with this symbol  have critical characteristics.
 Use ONLY replacement parts recommended by the manufacturer.

A
 B
 C
 D
 E

SCHEMATIC DIAGRAM (for DRA-565RD)

10

9

8

7

6

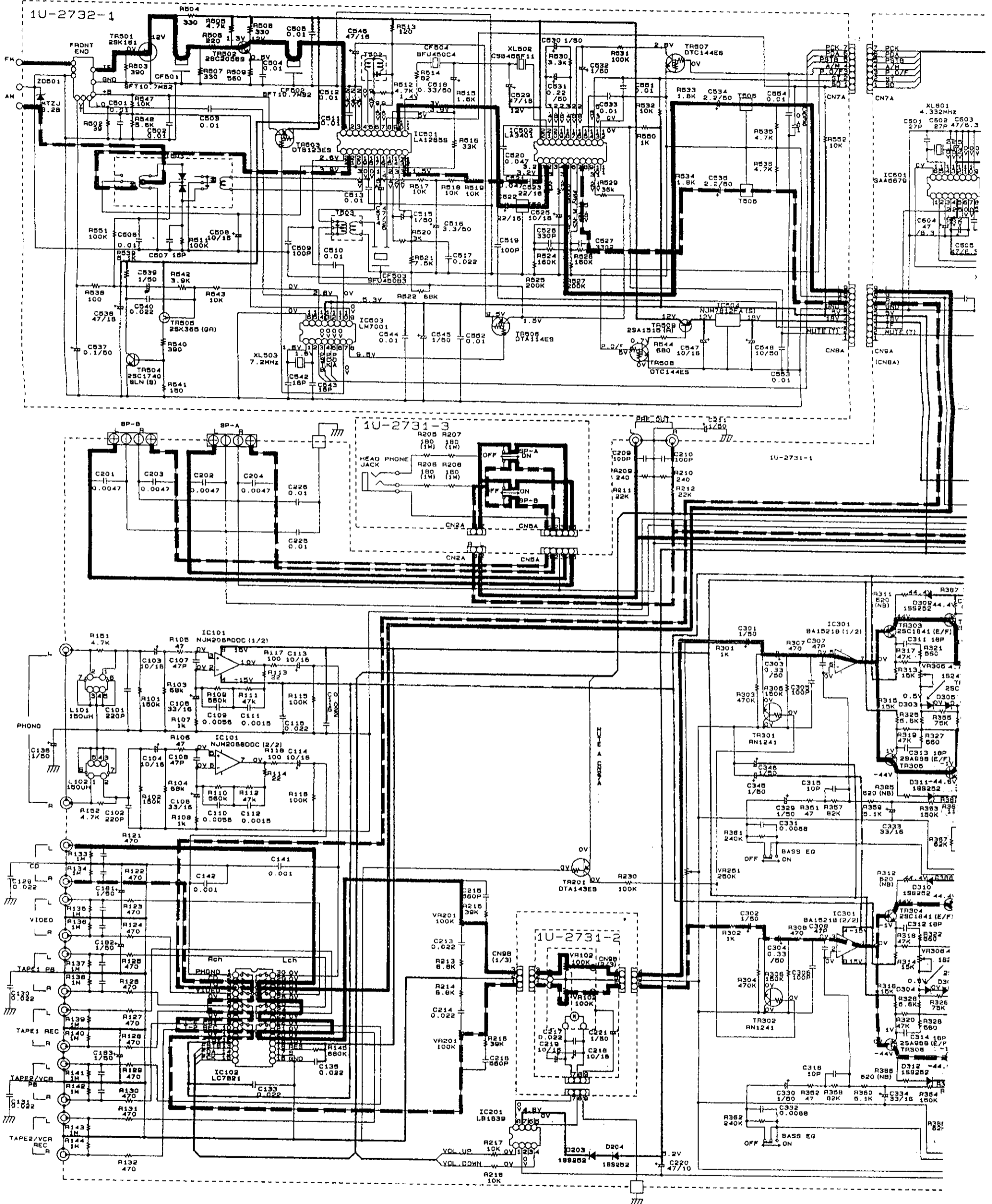

WARNING:
Parts marked with this symbol  have critical characteristics. Use ONLY replacement parts recommended by the manufacturer.

CAUTION:
Before returning the unit to the customer, make sure you make either (leakage current exceeds 0.5 millamps, or if the resistance from chassis

WARNING:
DO NOT return the unit to the customer until the problem is located an

NOTES:
Circuit and parts are subject to change without prior notice.

DENC-00-96 DRUCK17

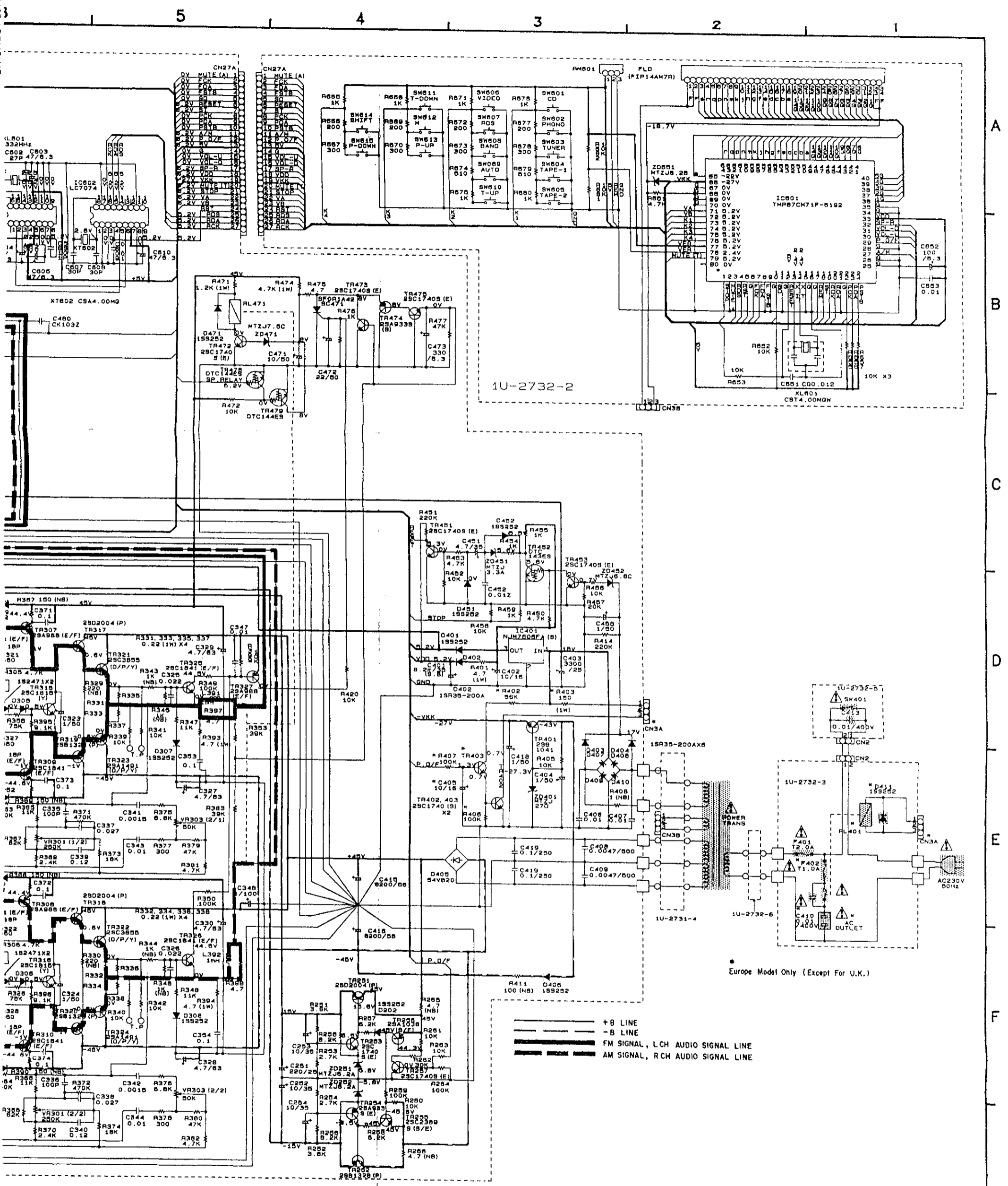

or (1) a leakage current check or (2) a line to chassis resistance check. If the chassis resistance to either side of the power cord is less than 240 kohms, the unit is defective and corrected.

NOTES
 ALL RESISTANCE VALUES IN OHM. k=1,000 OHM, M=1,000,000 OHM
 ALL CAPACITANCE VALUES IN MICRO FARAD. P=MICRO-MICRO FARAD
 EACH VOLTAGE AND CURRENT ARE MEASURED AT NO SIGNAL INPUT CONDITION.
 CIRCUIT AND PARTS ARE SUBJECT TO CHANGE WITHOUT PRIOR NOTICE.

SCHEMATIC DIAGRAM (for DRA-365RD)

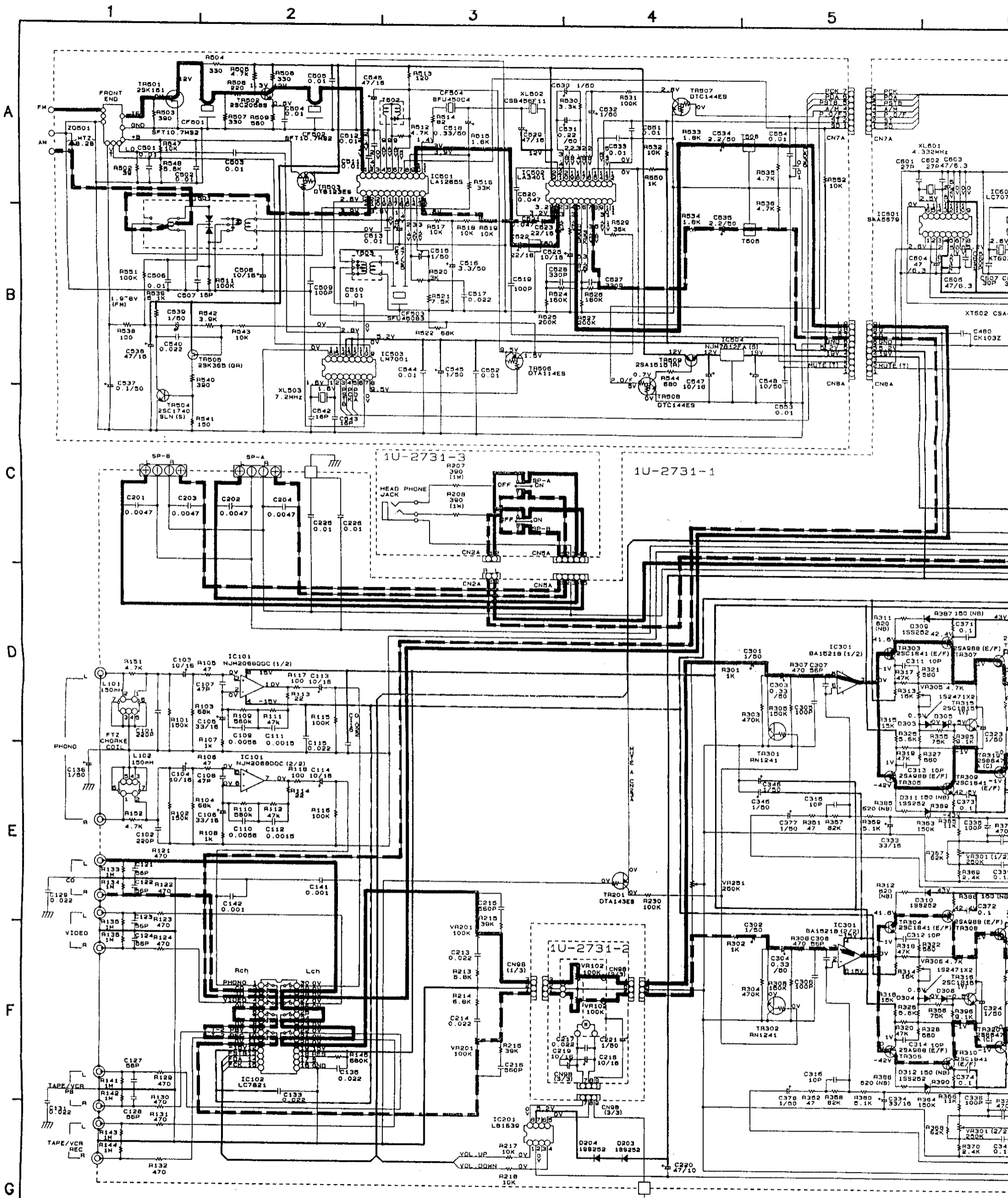

NOTES
 ALL RESISTANCE VALUES IN OHM. k=1,000 OHM, M=1,000,000 OHM
 ALL CAPACITANCE VALUES IN MICRO FARAD. P=MICRO-MICRO FARAD
 EACH VOLTAGE AND CURRENT ARE MEASURED AT NO SIGNAL INPUT CONDITION.
 CIRCUIT AND PARTS ARE SUBJECT TO CHANGE WITHOUT PRIOR NOTICE.

WARNING:
 Parts marked with this symbol have critical ch.
 Use ONLY replacement parts recommended by the mar

CAUTION:
 Before returning the unit to the customer, make sure you
 leakage current exceeds 0.5 milliamps, or if the resistan

WARNING:
 DO NOT return the unit to the customer until the problem

NOTES:
 Circuit and parts are subject to change without pr

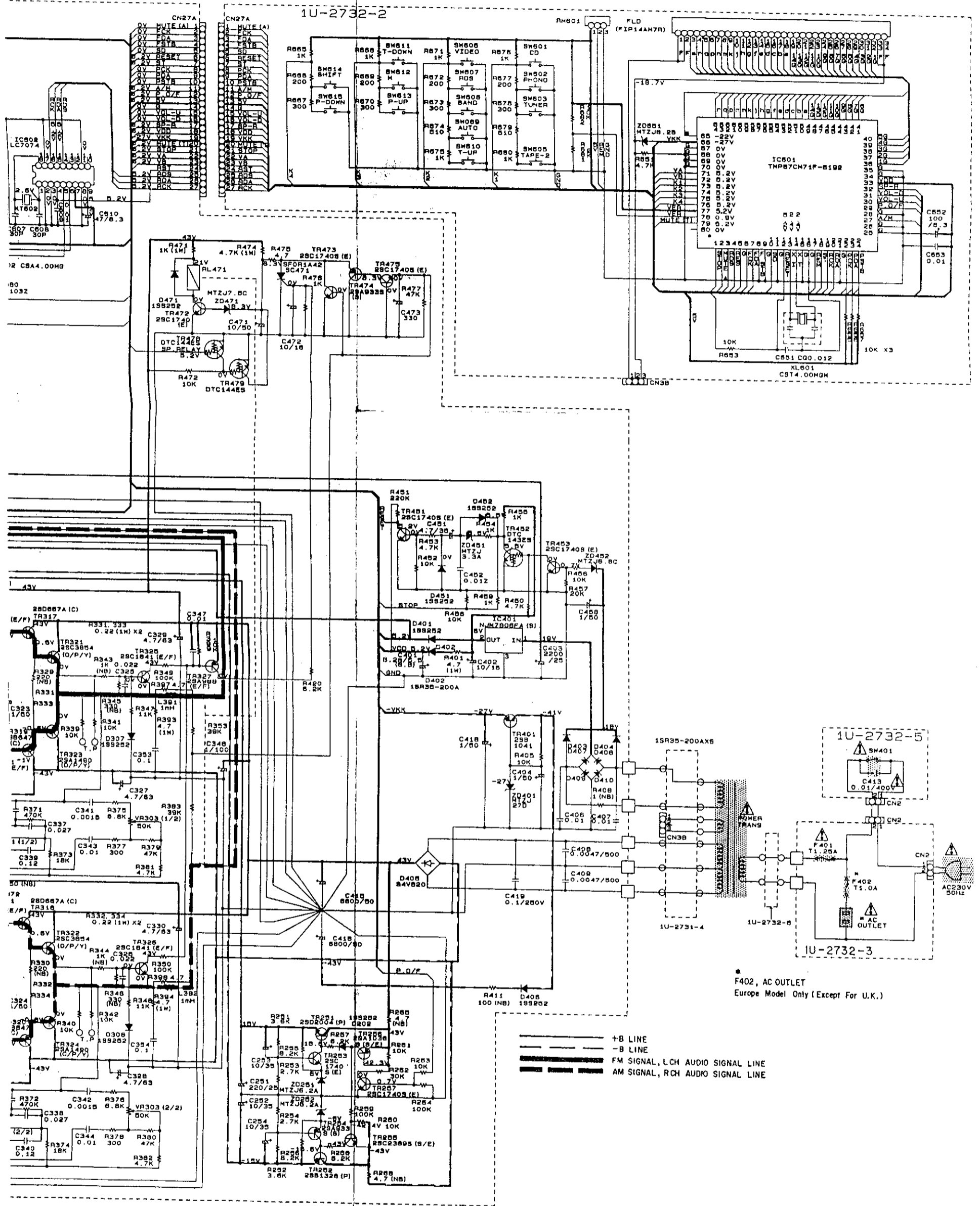

local characteristics.
 manufacturer.

When you make either (1) a leakage current check or (2) a line to chassis resistance check. If the resistance from chassis to either side of the power cord is less than 240 kohms, the unit is defective.

Problem is located and corrected.

Notice prior.