

# DENON

Hi-Fi Component

## SERVICE MANUAL

# MODEL POA-T2/T3

# MODEL POA-3200

### STEREO POWER AMPLIFIER

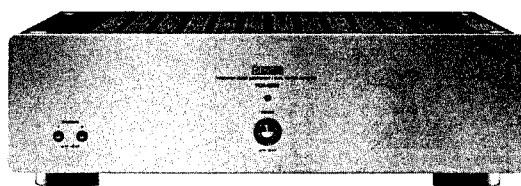

POA-3200

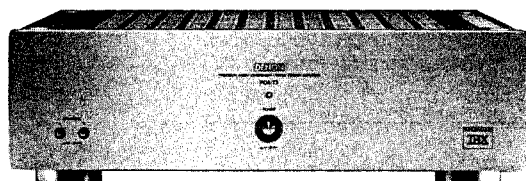

POA-T2

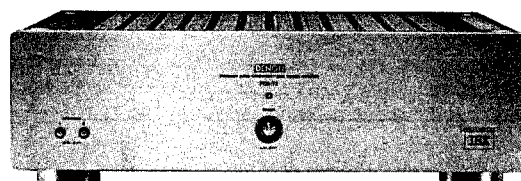

POA-T3

#### — TABLE OF CONTENTS —

OPERATING INSTRUCTIONS (POA-T2/T3) .....	2-5
OPERATING INSTRUCTIONS (POA-3200) .....	6-11
DISASSEMBLY .....	12-15
BLOCK DIAGRAM .....	16
METHOD OF ADJUSTMENT .....	17
SEMICONDUCTORS .....	18
NOTE FOR PARTS LIST .....	19
PARTS LIST OF PRINTED WIRING BOARD .....	20,21
PARTS LIST OF EXPLODED VIEW (POA-T3) .....	22
EXPLODED VIEW (POA-T3) .....	23
PARTS LIST OF EXPLODED VIEW (POA-T2/3200) .....	24
EXPLODED VIEW (POA-T2/3200) .....	25
PRINTED WIRING BOARD .....	26,27
WIRING DIAGRAM .....	28
SCHEMATIC DIAGRAM .....	29

## NIPPON COLUMBIA CO., LTD.



**CAUTION**  
RISK OF ELECTRIC SHOCK  
DO NOT OPEN

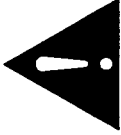

**CAUTION: TO REDUCE THE RISK OF ELECTRIC SHOCK, DO NOT REMOVE COVER (OR BACK). NO USER SERVICEABLE PARTS INSIDE. REFER SERVICING TO QUALIFIED SERVICE PERSONNEL.**

The lightning flash with arrowhead symbol, within an equilateral triangle, is intended to alert the user to the presence of uninsulated "dangerous voltage" within the product's enclosure that may be of sufficient magnitude to constitute a risk of electric shock to persons.

The exclamation point within an equilateral triangle is intended to alert the user to the presence of important operating and maintenance (servicing) instructions in the literature accompanying the appliance.

**WARNING: TO REDUCE THE RISK OF FIRE OR ELECTRIC SHOCK, DO NOT EXPOSE THIS APPLIANCE TO RAIN OR MOISTURE.**

安全注意事項



**CAUTION**  
RISK OF ELECTRIC SHOCK  
DO NOT OPEN









注意：為減少觸電危險，切勿拆下機殼（或機背）。機身內並無用戶修理用零件。請交由專業修理人員修理本機。

三角形內有箭頭的閃電符號旨在提醒用戶，本產品機殼內有未經絕緣的“危險電壓”，其幅度足以使人觸電而發生危險。

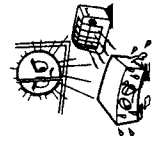
三角形內加感嘆符號旨在提醒用戶，有重要的操作與維修說明書配合本機。

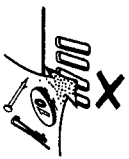
警告：為減少着火或觸電危險，切勿讓本機受雨淋濕或受潮。

NOTE ON USE

		
<ul style="list-style-type: none"> <li>Avoid high temperatures. Allow for sufficient heat dispersion when installed on a rack.</li> </ul>	<ul style="list-style-type: none"> <li>Keep the set free from moisture, water, and dust.</li> </ul>	<ul style="list-style-type: none"> <li>Do not let foreign objects in the set.</li> </ul>
		
<ul style="list-style-type: none"> <li>Handle the power cord carefully. Hold the plug when unplugging the cord.</li> </ul>	<ul style="list-style-type: none"> <li>Unplug the power cord when not using the set for long periods of time.</li> </ul>	<ul style="list-style-type: none"> <li>Do not let insecticides, benzene, and thinner come in contact with the set.</li> </ul>
		<ul style="list-style-type: none"> <li>Never disassemble or modify the set in any way.</li> </ul>

Please check to make sure the following items are included with the main unit in the carton:

- (1) Operating Instructions ..... 1
- (2) Remote Power Cord ..... 1
- (3) AC Power Cord ..... 1

NOTE:

1. Always keep the POWER switch on the main unit turned on.
2. Turn the power on and off from the remote control unit of the pre-amplifier (AVP-A1, etc).
3. Unplug the power cord when you do not plan to use the unit for a long period of time.

PRECAUTIONS FOR INSTALLATION

Leave at least 10cm of space between this unit and any other component placed above.

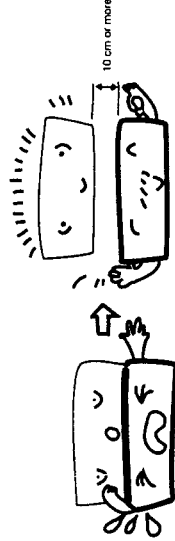

**FRONT PANEL**

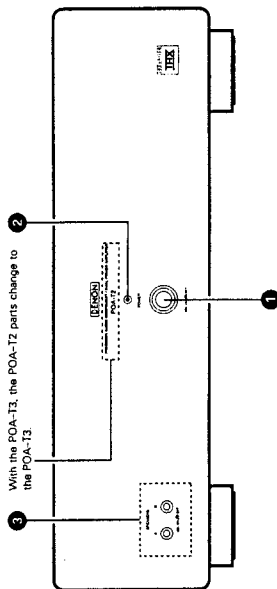

**NAMES AND FUNCTIONS OF PARTS**

- 1 Power switch (POWER)**  
When this switch is pressed, the power is turned on, the POWER indicator (2) flashes for some seconds and then lights steadily, and stable operation condition is reached. When this switch is pressed again, the power is turned off.
- 2 Power indicator**  
This lights orange when the power is on, and turns red when the power is turned off with remote terminal (5).
- 3 Speaker selector buttons (SPEAKERS)**  
When button A is set to the "ON ( )" position, sound is produced from the speaker systems connected to the "A" speaker terminals.  
When button B is set to the "ON ( )" position, sound is produced from the speaker systems connected to the "B" speaker terminals.  
When both the A and B buttons are set to the "ON ( )" position, sound is produced from the speaker systems connected to both the "A" and "B" speaker terminals.  
When both the A and B buttons are set to the "OFF ( )" position, no sound is produced from the speaker systems. Use this when listening over headphones.

**REAR PANEL**

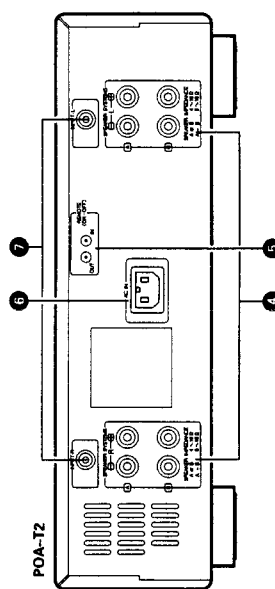
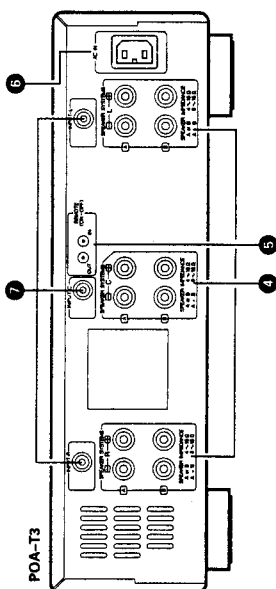

- 4 Speaker System terminal (SPEAKER SYSTEMS)**  
Connect the speaker systems here.
- 5 Remote terminal (REMOTE ON-OFF)**  
This terminal is used for remote control of the pre-amplifier. A low-voltage DC current is emitted from the terminal to turn on the power of a DENON pre-amplifier.  
The main unit's power can be turned on and off with the pre-amplifier's remote control unit when the pre-amplifier and main unit's input terminal are connected with the included cable. When the main unit's output terminal is connected to the input terminal of another power amplifier, the other power amplifier's power can be turned on and off.
- 6 AC IN**  
Connect this to a power outlet using the included AC power cord.
- 7 Input terminal (INPUT)**  
This is an input terminal (RCA connector). Connect it to the pre-amplifier's pre-out terminal.

**PROTECTOR**

Various protector circuits are included in this unit. The output is interrupted in the following case:

- (1) Muting time, which lasts for several seconds after the power is turned "on".
- (2) When the offset voltage of the power amplifier has drifted outside the prescribed range.
- (3) When the temperature of the power amplifier is abnormally high.
- (4) When a speaker terminal is shorted or a speaker's impedance is extremely low.

This set is equipped with a heat-dispersing motor fan.  
The motor fan operates when it senses that the temperature inside the set is high and the heat must be dispersed.



Manufactured under license from Lucasfilm Ltd. Lucasfilm and THX are registered trademarks of Lucasfilm Ltd.

CONNECTIONS

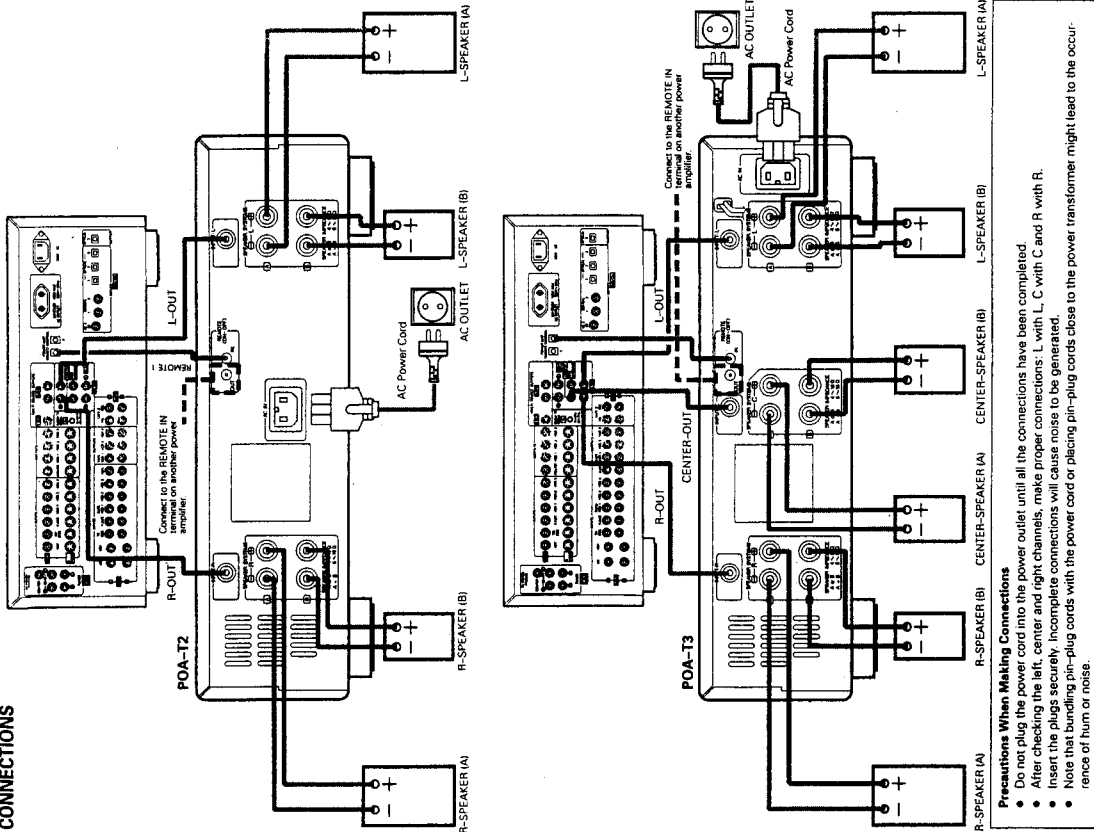

Precautions When Making Connections

- Do not plug the power cord into the power outlet until all the connections have been completed.
- After checking the left, center and right channels, make proper connections: L with L, C with C and R with R.
- Insert the plugs securely. Incomplete connections will cause noise to be generated.
- Note that bundling pin-plug cords with the power cord or placing pin-plug cords close to the power transformer might lead to the occurrence of hum or noise.

- **Connection to the speaker system**
  - When connecting the speaker terminals to the speaker systems, make certain to connect the polarities correctly (+ to + and - to -). If the polarities are incorrect when the two are connected, the center area of the sound will be lacking, the positions of the musical instruments will not be clear, and the stereo directional sensitivity will be impaired.
  - During connection, be careful that the center wires in the speaker cords do not protrude from the terminals to contact any other terminal, and that the central wires in the separate speaker cords do not contact each other.

- **Speaker impedance**
  - When only one of the A or B terminals is used, the speakers that are to be connected should have a nominal impedance of 4 to 16  $\Omega$ /ohms.
  - When the two sets (A + B) are to be used at the same time, use of speakers whose impedance is outside the range from 8 to 16  $\Omega$ /ohms will result in malfunction. Be careful not to let this happen.
  - Speakers with a lower impedance may cause the protective circuitry to operate.

SPECIFICATIONS

<b>Rated Output Power:</b> (8 $\Omega$ /ohms Load) 20 Hz to 20 kHz, T.H.D. 0.02% (4 $\Omega$ /ohms Load) 1 kHz, T.H.D. 0.5%	120 W 200 W	<b>Input Impedance:</b> Normal in:	47 k $\Omega$ /kohms
<b>Total Harmonic Distortion:</b> (-3 dB at rated output, 8 $\Omega$ /ohms) (20 Hz to 20 kHz)	0.008%	<b>Output Impedance:</b>	0.1 $\Omega$ /ohms (1 kHz)
<b>Intermodulation Distortion:</b> (60 Hz/7 kHz: 4/1 at rated output, 8 $\Omega$ /ohms)	0.002%	<b>S/N Ratio:</b> (IHF, A-weighting) (Normal)	110 dB
<b>Power Band Width:</b> (8 $\Omega$ /ohms, THD 0.05%)	5 Hz - 50 kHz	<b>Output Terminals:</b> Speakers A or B 4 $\Omega$ /ohms - 16 $\Omega$ /ohms A + B 8 $\Omega$ /ohms - 16 $\Omega$ /ohms	
<b>Frequency Response:</b> +0, -3 dB (at 1 W)	1 Hz - 100 kHz	<b>Power Supply:</b>	AC 230 V/50 Hz
<b>Input Sensitivity:</b> Normal in:	1.1 V	<b>Power Consumption:</b>	POA-T3 470 W POA-T2 330 W
		<b>Dimensions:</b> (Including control knobs and feet)	434 (W) x 135 (H) x 353 (D)mm
		<b>Weight:</b>	POA-T3 16 kg POA-T2 12.3 kg

- Specifications and contents are subject to change without notice for purposes of improvement.

**TROUBLESHOOTING**

Before troubleshooting, be sure to check whether your audio system is really the source of the problem.

**If you think the amplifier is out of order, first check the following one more time:**

1. Are all the connections correctly made?
  2. Is the set being operated properly in accordance with the Operating Manual?
  3. Are the speakers and pre-amplifier being operated correctly?
- If the set does not operate properly, perform the checks indicated in the flow chart below. Turn off the power immediately, and contact the outlet where you purchased the amplifier or your nearest DENON dealer.

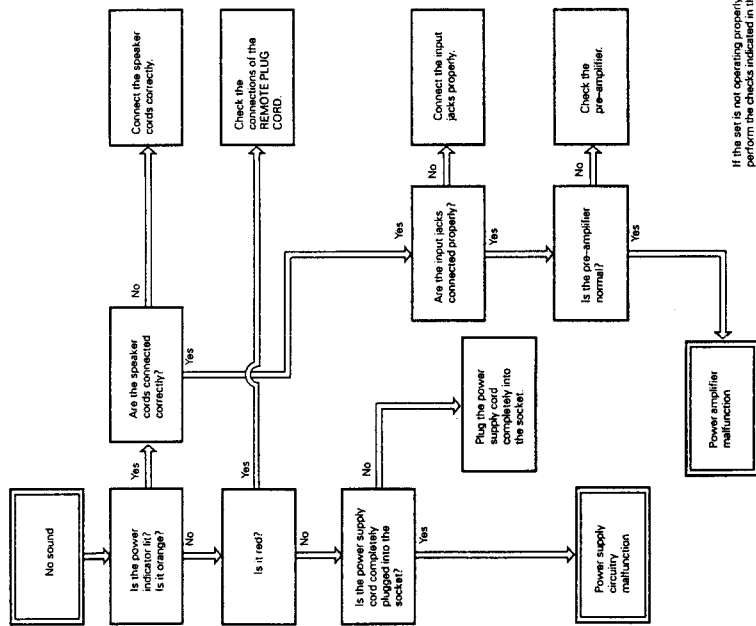

If the set is not operating properly, perform the checks indicated in this flow chart.

# SAFETY INSTRUCTIONS

1. Read Instructions - All the safety and operating instructions should be read before the appliance is operated.
2. Retain Instructions - The safety and operating instructions should be retained for future reference.
3. Heed Warnings - All warnings on the appliance and in the operating instructions should be adhered to.
4. Follow Instructions - All operating and use instructions should be followed.
5. Water and Moisture - The appliance should not be used near water - for example, near a bathtub, washbowl, kitchen sink, laundry tub, in a wet basement, or near a swimming pool, and the like.
6. Carts and Stands - The appliance should be used only with a cart or stand that is recommended by the manufacturer.
- 6A. An combination and cart combination should be moved with care. Quick stops, excessive force, and uneven surfaces may cause the appliance and cart combination to overturn.
7. Wall or Ceiling Mounting - The appliance should be mounted to a wall or ceiling only as recommended by the manufacturer.
8. Ventilation - The appliance should be situated so that its location or position does not interfere with its proper ventilation. For example, the appliance should not be situated on a bed, sofa, rug, or similar surface that may block the ventilation openings; or, placed in a built-in installation, such as a bookcase or cabinet that may impede the flow of air through the ventilation openings.
9. Heat - The appliance should be situated away from heat sources such as radiators, heat registers, stoves, or other appliances (including amplifiers) that produce heat.
10. Power Sources - The appliance should be connected to a power supply only of the type described in the operating instructions or as marked on the appliance.
11. Grounding or Polarization - Precautions should be taken so that the grounding or polarization means of an appliance is not defeated.
12. Power-Cord Protection - Power-supply cords should be routed so that they are not likely to be walked on or pinched by items placed upon or against them; paying particular attention to cords at plugs, convenience receptacles, and the point where they exit from the appliance.
14. Cleaning - The appliance should be cleaned only as recommended by the manufacturer.
15. Power Lines - An outdoor antenna should be located away from power lines.
16. Outdoor Antenna Grounding - If an outside antenna is connected to the receiver, be sure the antenna system is grounded so as to provide some protection against voltage surges and built-up static charges. Article 810 of the National Electrical Code, ANSI/NFPA 70, provides information with regard to proper grounding of the mast and supporting structure, grounding of the lead-in wire to an antenna-discharge unit, size of grounding conductors, location of antenna-discharge unit, connection to grounding electrodes, and requirements for the grounding electrode. See Figure A.
17. Nonuse Periods - The power cord of the appliance should be unplugged from the outlet when left unused for a long period of time.
18. Object and Liquid Entry - Care should be taken so that objects do not fall and liquids are not spilled into the enclosure through openings.
19. Damage Requiring Service - The appliance should be serviced by qualified service personnel when:
  - A. The power-supply cord or the plug has been damaged, or
  - B. Objects have fallen, or liquid has been spilled into the appliance, or
  - C. The appliance has been exposed to rain; or
  - D. The appliance does not appear to operate normally or exhibits a marked change in performance; or
  - E. The appliance has been dropped, or the enclosure damaged.
20. Servicing - The user should not attempt to service the appliance beyond that described in the operating instructions. All other servicing should be referred to qualified service personnel.



**CAUTION**  
RISK OF ELECTRIC SHOCK  
DO NOT OPEN

**CAUTION: TO REDUCE THE RISK OF ELECTRIC SHOCK, DO NOT REMOVE COVER (OR BACK). NO USER SERVICEABLE PARTS INSIDE. REFER SERVICING TO QUALIFIED SERVICE PERSONNEL.**

The lightning flash with arrowhead symbol, within an equilateral triangle, is intended to alert the user to the presence of uninsulated "dangerous voltage" within the product's enclosure that may be of sufficient magnitude to constitute a risk of electric shock to persons.

The exclamation point, within an equilateral triangle is intended to alert the user to the presence of important operating and maintenance (servicing) instructions in the literature accompanying the appliance.

**WARNING: TO REDUCE THE RISK OF FIRE OR ELECTRIC SHOCK, DO NOT EXPOSE THIS APPLIANCE TO RAIN OR MOISTURE.**

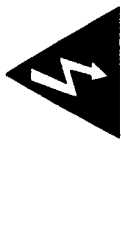

● FOR U.S.A. & CANADA MODEL ONLY

**CAUTION**

TO PREVENT ELECTRIC SHOCK DO NOT USE THIS (POLARIZED) PLUG WITH AN EXTENSION CORD, RECEPTACLE OR OTHER OUTLET UNLESS THE BLADES CAN BE FULLY INSERTED TO PREVENT BLADE EXPOSURE.

● POUR LE MODELE CANADIEN UNIQUEMENT

**ATTENTION**

POUR PREVENIR LES CHOCs ELECTRIQUES NE PAS UTILISER CETTE FICHE POLARISEE AVEC UN PROLONGATEUR, UNE PRISE DE COURANT OU UNE AUTRE SORTIE DE COURANT, SAUF SI LES LAMES PEUVENT ETRE INSEREES A FOND SANS EN LAISSER AUCUNE PARTIE A DECOUVERT.

● NUR FÜR EUROPÄISCHE MODELLE

**Konformitätserklärung**

Die DENON Electronic GmbH  
Halskestraße 32  
40880 Ratingen

Erklärt als Hersteller/Importeur, daß, das in dieser Bedienungsanleitung beschriebene Gerät den Technischen Vorschriften für Ton- und Fernseh-Rundfunkempfängernach der Amtsblattverfügung 868/1989 (Amtsblatt des Bundesministers für Post und Telekommunikation vom 31. 8. 1989) entspricht.

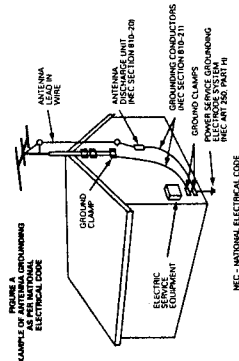

FIGURE A  
EXAMPLE OF ANTENNA GROUNDING  
AS PER NATIONAL ELECTRICAL CODE

NEC - NATIONAL ELECTRICAL CODE

**NOTE:**  
 1. Always keep the POWER switch on the main unit turned on.  
 2. Turn the power on and off from the remote control unit of the pre-amplifier (PPA-S10, etc.).  
 3. Unplug the power cord when you do not plan to use the unit for a long period of time.

**CAUTION:**  
 If only the STANDBY indicator is lit, this means that the power is turned off from the remote control unit. Turn the power on from the remote control unit of the pre-amplifier (PPA-S10, etc.).

**HINWEIS:**  
 1. Lassen Sie den Netzschalter (POWER) am Hauptgerät stets eingeschaltet.  
 2. Schalten Sie den Strom mit Hilfe des Fernbedienungsgerätes des Vorverstärkers (PPA-S10 o.ä.) ein und aus.  
 3. Trennen Sie das Netzkabel vom Netz ab, wenn Sie beabsichtigen, das Gerät über einen längeren Zeitraum hinweg nicht zu benutzen.

**VORSICHT:**  
 Wenn die STANDBY-Anzeige leuchtet, bedeutet dies, das der Strom mit dem Fernbedienungsgerät ausgeschaltet worden ist. Schalten Sie den Strom mit dem Fernbedienungsgerät des Vorverstärkers (PPA-S10 usw.) ein.

**REMARQUE:**  
 1. S'assurer que le commutateur d'alimentation (POWER) sur l'unité principale reste toujours allumé.  
 2. Allumer et éteindre l'appareil avec le télécommande du préamplificateur (PPA-S10, etc.).  
 3. Débrancher le cordon d'alimentation lorsque l'appareil ne sera pas utilisé pendant une longue période.

**ATTENTION:**  
 Se solamente l'indicatore STANDBY (attesa) è illuminato, ciò significa che la corrente è stata spenta usando il telecomando del preamplificatore (PPA-S10, etc.).

**NOTA:**  
 1. Tenete sempre l'interruttore della corrente (POWER) dell'unità principale nella posizione di attivazione.  
 2. Spegnete e accendete la corrente usando il telecomando del preamplificatore (PPA-S10, etc.).  
 3. Scollegate il filo di alimentazione quando avete intenzione di non usare l'apparecchio per un lungo periodo.

**AVISO:**  
 Se solo l'indicatore STANDBY (attesa) es iluminado, ciò significa que la corriente è stata spenta usando il telecomando. Riaccendete la corrente usando il telecomando del preamplificatore (PPA-S10, etc.).

**PRECAUTIONS FOR INSTALLATION**  
 Leave at least 10 cm of space between this unit and any other component placed above.

**SICHERHEITSMASSNAHMEN BEIM EINBAU**  
 Lassen einen Mindestabstand von 10 cm zwischen diesem Gerät und der anderen Komponente, die daraufgestellt wird.

**PRECAUTIONS D'INSTALLATION**  
 Prévoir un espace d'au moins 10 cm entre l'unité et tout autre appareil se trouvant au-dessus.

**PRECAUTIONI PER L'INSTALLAZIONE**  
 Lasciate uno spazio libero di almeno 10 cm tra quest'unità e qualsiasi altro componente che è collocato sopra la stessa.

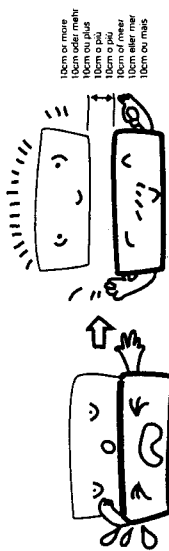

**NOTA:**  
 1. Mantenga siempre activado el interruptor de alimentación (POWER) en la unidad principal.  
 2. Conecte y desconecte la alimentación mediante la unidad de control remoto del preamplificador (PPA-S10, etc.).  
 3. Cuando la unidad vaya a estar fuera de uso por un periodo prolongado de tiempo, desconecte el cable de alimentación.

**PRECAUTION:**  
 Cuando solo el indicador STANDBY (espera) esté encendido, significa que la alimentación ha sido desconectada desde la unidad de control remoto. Conecte la alimentación mediante la unidad de control remoto del preamplificador (PPA-S10, etc.).

**OPMERKING:**  
 1. Zorg ervoor voor dat de stroomschakelaar (POWER) van het hoofd toestel in de juiste toestand staat.  
 2. Schakel de spanning in en uit met de afstandsbediening van de voorversterker (PPA-S10, enz.).  
 3. Trek het netkabel uit wanneer u denkt het toestel gedurende een lange periode niet te gebruiken.

**WAARSCHUWING:**  
 Wanneer alleen de STANDBY-indicator brandt, betekent dit dat de spanning is uitgeschakeld met de afstandsbediening. Schakel de spanning in met de afstandsbediening van de voorversterker (PPA-S10, enz.).

**OBSERVERA:**  
 1. Låt alltid strömstyraren (POWER) på huvudenheten vara påslagen.  
 2. Sätt strömmen till och från via fjärrkontrollen som medföljer för förstärkaren (PPA-S10 m.fl.).  
 3. Koppla loss nätkabeln om apparaten inte skall användas under lång tid.

**AVVARNING:**  
 Om endast strömindikatorn lyser betyder det att strömmen har stängts av via fjärrkontrollen. När du sedan står på strömmen igen måste denna göras från fjärrkontrollen som medföljer förstärkaren (PPA-S10 m.fl.).

**NOTA:**  
 1. Mantenga o interruptor de Corrente (POWER) na unidade principal sempre ligado.  
 2. Ligue e desligue a corrente a partir da unidade de controle remoto do pré-amplificador (PPA-S10, etc.).  
 3. Desconecte o fio de força quando intente não utilizar a unidade por longo tempo.

**PRECAUÇÃO:**  
 Se apenas estiver iluminado o indicador de aguardar (STANDBY), isto significa que a corrente está desligada a partir da unidade de controle remoto. Ligue a corrente a partir da unidade de controle remoto do pré-amplificador (PPA-S10, etc.).

**PRECAUCIONES PARA LA INSTALACION**  
 Deje por lo menos 10 cm. de espacio entre esta unidad y cualquier otro componente situado sobre ella.

**VOORZORGSMAATREGELEN**  
 Bij plaatsing dient u een ruimte van minstens 10 cm open te laten tussen het toestel en een ander erop geplaatst component.

**FÖRSIKTIGHETSÅTGÄRDER VID INSTALLATIONEN**  
 Se till att det finns minst 10 cm mellanrum mellan apparaten och en ev. annan apparat som sätts ovanpå.

**CUIDADOS NA INSTALAÇÃO**  
 Deixe um espaço de pelo menos 10 cm entre esta unidade e qualquer outro componente colocada acima.

**ENGLISH**

Please check to make sure the following items are included with the main unit in the carton:

- (1) Operating Instructions
- (2) Remote Power Cord
- (3) AC Power Cord

**DEUTSCH**

Bitte überprüfen Sie, ob die folgenden Teile vollständig in der Verpackung enthalten sind:

- (1) Bedienungsanleitung
- (2) Fernbedienungskabel
- (3) AC-Netzkabel

**FRANCAIS**

Veuillez contrôler que les articles suivants sont bien joints à l'appareil principal dans le carton:

- (1) Mode d'emploi
- (2) Cordon d'alimentation de télécommande
- (3) Cordon électrique AC

**ITALIANO**

Controllare che le parti seguenti si trovino imballate con l'apparecchio nella scatola di spedizione:

- (1) Libretto delle istruzioni
- (2) Fido di alimentazione a distanza
- (3) Fido di alimentazione CA

**ESPAÑOL**

Por favor verifique asegurándose de que los siguientes artículos son empacados en la caja pero separados de la unidad principal:

- (1) Manual de instrucciones
- (2) Cable de encendido automático
- (3) Cable de corriente CA

**NEDERLANDS**

Controleer of de volgende accessoires bij het hoofdtoestel in de doos zijn verpakt:

- (1) Gebruiksaanwijzing
- (2) Afstandsbedieningshoer
- (3) Netkabel

**SVENSKA**

Kontrollera att följande, förutom huvudapparaten, finns med i kartongen:

- (1) Bruksanvisning
- (2) Kabel för fjärrstyrd strömstyrning
- (3) Nätledad

**PORTUGUÊS**

Certifique-se de que as seguintes peças estão incluídas na embalagem fora da unidade principal:

- (1) Instruções de operação
- (2) Cabo de Alimentação de Controle Remoto
- (3) Cabo de CA

**NOTE ON USE/HINWEISE ZUM GEBRAUCH/OBSERVATIONS RELATIVES A L'UTILISATION  
NOTE SULL'USO/NOTAS SOBRE EL USO/ALVORENS TE GEBRUIKEN/OBSERVERA  
OBSERVAÇÕES QUANTO AO USO**

**FRONT PANEL  
FRONTPLATTE  
PANNEAU AVANT  
PANNELLO ANTERIORE**

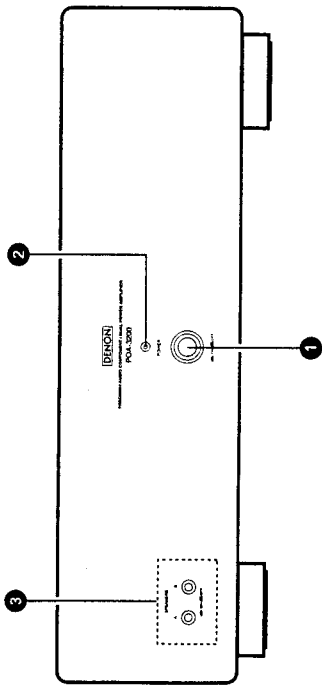



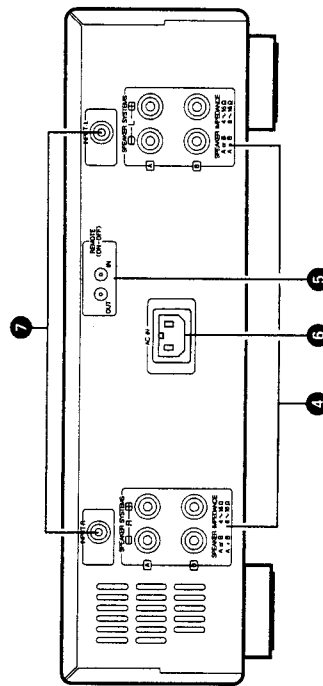

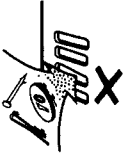
**REAR PANEL  
RÜCKWAND  
PANNEAU ARRIERE  
PANNELLO POSTERIORE**



 <ul style="list-style-type: none"> <li>Do not let foreign objects in the set.</li> <li>Ne laissez pas d'objets étrangers dans l'appareil.</li> <li>Ne pas laisser des objets étrangers dans l'appareil.</li> <li>E' impedimenti che nessun oggetto è inserito nel dispositivo.</li> <li>No darf kein fremdes Gegenstand in das Gerät einstecken.</li> <li>Last geen vreemde voorwerpen in dit apparaat plaatsen.</li> <li>Não deixe objetos estranhos no aparelho.</li> </ul>	<ul style="list-style-type: none"> <li>Keep the set free from moisture, water, and steam.</li> <li>Halten Sie das Gerät von Feuchtigkeit, Wasser und Dampf fern.</li> <li>Protéger l'appareil contre l'humidité, l'eau et la vapeur.</li> <li>Tener l'unità lontana dall'umidità, dall'acqua e dalla polvere.</li> <li>Mantenga el equipo libre de humedad, agua y vapor.</li> <li>Last geen vochtigheid, water of stof in het apparaat.</li> <li>Maintenez l'appareil de l'humidité, de la vapeur et de la poussière.</li> <li>Mantenha o aparelho livre de qualquer umidade, água ou pó.</li> </ul>	<ul style="list-style-type: none"> <li>Avoid high temperatures.</li> <li>Allow for sufficient heat dispersion when installing the set.</li> <li>Vermeiden Sie hohe Temperaturen.</li> <li>Vermeiden Sie eine ausreichende Luftzirkulation gewährleisten, wenn das Gerät aufgestellt wird.</li> <li>Eviter des températures élevées.</li> <li>Tenir compte d'une dispersion de chaleur suffisante lors de l'installation sur une étagère.</li> <li>Evitar de exponer el equipo a temperaturas altas.</li> <li>Assure que o aparelho seja instalado em um ambiente de calor adequado.</li> <li>Evite altas temperaturas.</li> <li>Permita que o aparelho tenha um espaço adequado de calor quando estiver instalado em uma estante.</li> <li>Vermijd hoge temperaturen.</li> <li>Zorg voor een adequate hitteafvoer indien het apparaat wordt opgesteld.</li> <li>Unbik hohe temperaturen.</li> <li>Se ist all drei firts möglicht till god värmavledning vid montering i ett rack.</li> <li>Conecte o sistema de dispersão de calor quando o equipamento for instalado numa prateleira.</li> </ul>
<ul style="list-style-type: none"> <li>Do not let insecticides, benzene, and thinner come in contact with the set.</li> <li>Lasen Sie das Gerät nicht mit Insektiziden, Benzin oder Verdünnungsmitteln in Berührung kommen.</li> <li>Ne pas mettre en contact des insecticides, du benzène et un diluant avec l'appareil.</li> <li>Non lasciare mai in contatto con insetticidi, benzina o solventi.</li> <li>No permita el contacto de insecticidas, gasolina y disolventes con el equipo.</li> <li>Não deixe inseticidas, benzina ou solventes em contato com o aparelho.</li> <li>Se il kit nie maskujemy på spraybruk, benzin och thinner kommer i kontakt med apparaten, ska den demonteras och förslutas.</li> <li>Não permita que inseticidas, benzina e disolventes entrem em contato com o aparelho.</li> </ul>	<ul style="list-style-type: none"> <li>Unplug the power cord when not using the set for long periods of time.</li> <li>Zieh das Netzstecker aus, wenn Sie das Netzstecker für längere Zeit nicht verwenden.</li> <li>Unplug the power cord when not using the set for long periods of time.</li> <li>Debranchez le cordon d'alimentation lorsque vous n'utilisez pas l'appareil pendant de longues périodes.</li> <li>Disinnestate il filo di alimentazione quando avete intenzione di non usare il filo di alimentazione per un periodo di tempo.</li> <li>Desconecte el cordón de energía cuando no utilice el equipo por mucho tiempo.</li> <li>Neem altijd het netstroom-uit het stopcontact uit bij langere tijd niet gebruik.</li> <li>Kopple ur netkabeln om apparaten inte kommer att användas i lång tid.</li> <li>Desconecte o cabo de energia quando o aparelho não for usado por um longo período.</li> </ul>	<ul style="list-style-type: none"> <li>Handle the power cord carefully.</li> <li>Hold the plug when unplugging the cord.</li> <li>Gehen Sie vorsichtig mit dem Netzlabel um.</li> <li>Halten Sie das Kabel am Stecker, wenn Sie den Stecker ausstecken.</li> <li>Maintain the cord of alimentation avec précaution.</li> <li>Prenez la prise lors du débranchement du cordon.</li> <li>Maneggiare il filo di alimentazione con cura.</li> <li>Agite per la spina quando scollegare il cavo dalla presa.</li> <li>Maneje el cordón de energía con cuidado.</li> <li>Agite por la espina cuando desconecte el cordón de energía.</li> <li>Handleer het netstroom-voorzicht.</li> <li>Handel het snoer bij de stekker vast wanneer de stopcontact wordt ontkoppeld.</li> <li>Handle o cabo de energia com cuidado.</li> <li>Mantenha o cabo de energia firme quando estiver desligando o equipamento.</li> <li>Segure a tomada ao desconectar o fio.</li> </ul>
<ul style="list-style-type: none"> <li>Never disassemble or modify the set in any way.</li> <li>Niemals das Gerät auseinanderbauen oder auf jegliche Art zu verändern.</li> <li>Ne jamais démonter ou modifier l'appareil d'une manière ou d'une autre.</li> <li>Ne desmonte mai, né modifiez l'unité in aucune manière.</li> <li>Nunca desarme o modifique el equipo de ninguna manera.</li> <li>Não desmonte ou modifique o aparelho de qualquer maneira.</li> <li>Do not disassemble or modify the set in any way.</li> <li>Do not disassemble or modify the set in any way.</li> </ul>	<ul style="list-style-type: none"> <li>Do not obstruct the ventilation holes.</li> <li>Die Reilöffnungen dürfen nicht verdeckt werden.</li> <li>Do not obstruct the trous of aeration.</li> <li>Non coprire i fori di ventilazione.</li> <li>Do not obstruct the holes of aeration.</li> <li>De ventilatieopeningen mogen niet worden bedekt.</li> <li>Do not obstruct the holes of aeration.</li> <li>Do not obstruct the holes of aeration.</li> </ul>	<ul style="list-style-type: none"> <li>Never disassemble or modify the set in any way.</li> <li>Niemals das Gerät auseinanderbauen oder auf jegliche Art zu verändern.</li> <li>Ne jamais démonter ou modifier l'appareil d'une manière ou d'une autre.</li> <li>Ne desmonte mai, né modifiez l'unité in aucune manière.</li> <li>Nunca desarme o modifique el equipo de ninguna manera.</li> <li>Não desmonte ou modifique o aparelho de qualquer maneira.</li> <li>Do not disassemble or modify the set in any way.</li> <li>Do not disassemble or modify the set in any way.</li> </ul>



**NAMES AND FUNCTIONS OF PARTS**

- 1 Power switch (POWER)**  
When this switch is pressed, the power is turned on, the POWER indicator **2** flashes for some seconds and then lights steadily, and stable operation condition is reached.  
When this switch is pressed again, the power is turned off.
- 2 Power indicator**  
This lights orange when the power is on, and turns red when the power is turned off with remote terminal **5**.
- 3 Speaker selector buttons (SPEAKERS)**  
When button A is set to the "ON (  )" position, sound is produced from the speaker systems connected to the "A" speaker terminals.  
When button B is set to the "ON (  )" position, sound is produced from the speaker systems connected to the "B" speaker terminals.  
When both the A and B buttons are set to the "ON (  )" position, sound is produced from the speaker systems connected to both the "A" and "B" speaker terminals.  
When both the A and B buttons are set to the "OFF (  )" position, no sound is produced from the speaker systems. Use this when listening over headphones.
- 4 Speaker System terminal (SPEAKER SYSTEMS)**  
Connect the speaker systems here.
- 5 Remote terminal (REMOTE ON-OFF)**  
This terminal is used for remote control of the pre-amplifier. A low-voltage DC current is emitted from the terminal to turn on the power of a DENON pre-amplifier.  
The main unit's power can be turned on and off with the pre-amplifier's remote control unit when the pre-amplifier and main unit's input terminal are connected with the included cable. When the main unit's output terminal is connected to the input terminal of another power amplifier, the other power amplifier's power can be turned on and off.
- 6 AC IN**  
Connect the included AC power cord here.
- 7 Input terminal (INPUT)**  
This is an input terminal (RCA connector). Connect it to the pre-amplifier's pre-out terminal.

**PROTECTOR**

Various protector circuits are included in this unit. The output is interrupted in the following case:

- (1) Muting time, which lasts for several seconds after the power is turned "on".
- (2) When the offset voltage of the power amplifier has drifted outside the prescribed range.
- (3) When the temperature of the power amplifier is abnormally high.
- (4) When a speaker terminal is shorted or a speaker's impedance is extremely low.

This set is equipped with a heat-dissipating motor fan.  
The motor fan operates when it senses that the temperature inside the set is high and the heat must be dispersed.

**CONNECTIONS**

**Precautions When Making Connections**

- Do not plug the power cord into the power outlet until all the connections have been completed.
- After checking the left and right channels, make proper connections: L with L, and R with R.
- Insert the plugs securely. Incomplete connections will cause noise to be generated.
- Note that bundling pin-plug cords with the power cord or placing pin-plug cords close to the power transformer might lead to the occurrence of hum or noise.

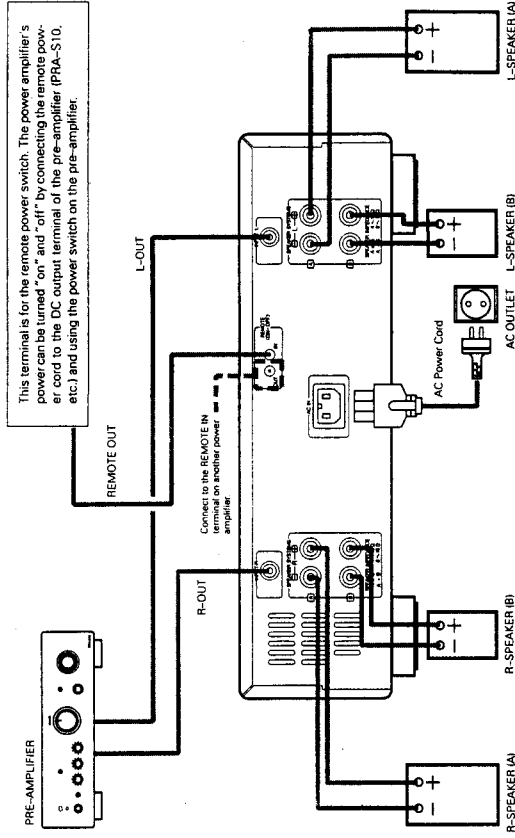

**• Connection to the speaker system**

- When connecting the speaker terminals to the speaker systems, make certain to connect the polarities correctly (+ to + and - to -). If the polarities are incorrect when the two are connected, the center area of the sound will be lacking, the positions of the musical instruments will not be clear, and the stereo directional sensitivity will be impaired.
- During connection, be careful that the center wires in the speaker cords do not protrude from the terminals to contact any other terminal, and that the central wires in the separate speaker cords do not contact each other.

**• Speaker impedance**

- When only one of the A or B terminals is used, the speakers that are connected should have a nominal impedance of 4 to 16 Ω/ohms.
- When the two sets (A + B) are to be used at the same time, use of speakers whose impedance is outside the range from 8 to 16 Ω/ohms will result in malfunction. Be careful not to let this happen.
- Speakers with a lower impedance may cause the protective circuitry to operate.

## TROUBLESHOOTING

Before troubleshooting, be sure to check whether your audio system is really the source of the problem.

**If you think the amplifier is out of order, first check the following one more time:**

1. Are all the connections correctly made?
2. Is the set being operated properly in accordance with the Operating Manual?
3. Are the speakers and pre-amplifier being operated correctly?

If the set does not operate properly, perform the checks indicated in the flow chart below.

If none of the items listed apply to the difficulty, the amplifier is probably out of order. Turn off the power immediately, and contact the outlet where you purchased the amplifier or your nearest DENON dealer.

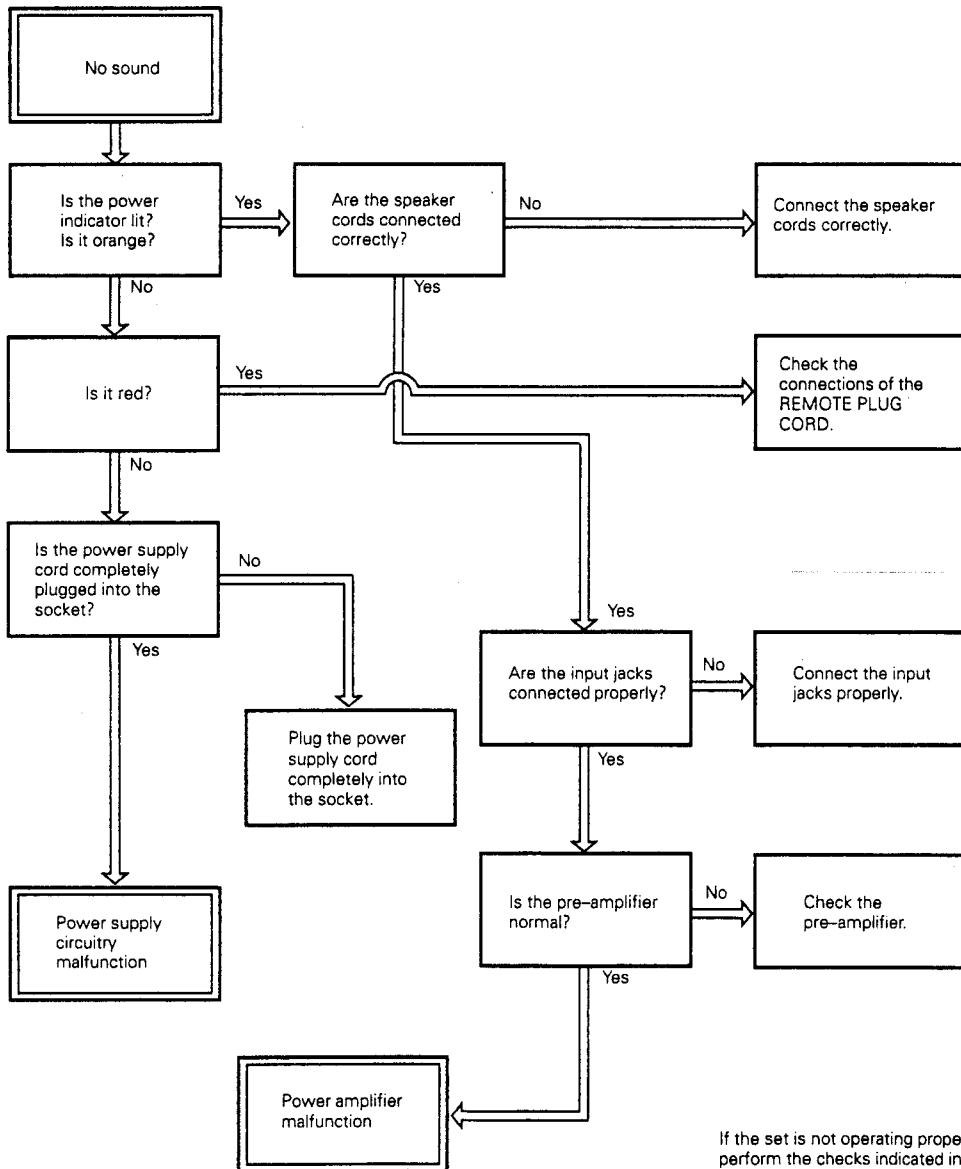

If the set is not operating properly, perform the checks indicated in this flow chart.

Technical Data (typical value)	Technische Daten (typische werte)	Caractéristiques techniques (valeur caractéristique)	
<p><b>• POWER AMPLIFIER SECTION</b></p> <p><b>Rated Output Power:</b> (8 <math>\Omega</math>/ohm Load) 20 Hz to 20 kHz, T.H.D. 0.02% (4<math>\Omega</math>/ohm Load) DIN, 1 kHz, T.H.D. 0.5%</p> <p><b>Total Harmonic Distortion:</b> (-3 dB at rated output, 8 <math>\Omega</math>/ohms) (1 kHz)</p> <p><b>Intermodulation Distortion:</b> (60 Hz/7 kHz: 4/1 at rated output, 8 <math>\Omega</math>/ohms)</p> <p><b>Power Band Width:</b> (8 <math>\Omega</math>/ohms, T.H.D. 0.05%)</p> <p><b>Frequency Response:</b> +0, -3 dB (at 1 W)</p> <p><b>Input Sensitivity:</b> Normal in:</p> <p><b>Input Impedance:</b> Normal in:</p> <p><b>Output Impedance:</b></p> <p><b>S / N Ratio:</b> (IHF, A-weighting) (Normal)</p> <p><b>Output Terminals:</b> Speakers A or B 4 <math>\Omega</math>/ohm <math>\sim</math> 16 <math>\Omega</math>/ohm A + B 8 <math>\Omega</math>/ohm <math>\sim</math> 16 <math>\Omega</math>/ohm</p> <p><b>Power Supply:</b></p> <p><b>Power Consumption:</b></p> <p><b>Dimensions:</b> (Including control knobs and feet)</p> <p><b>Weight:</b></p>	<p><b>• LEISTUNGSEND VERSTÄRKER</b></p> <p><b>Nenn-Ausgangsleistung:</b> (an 8 <math>\Omega</math>/Ohm) 20 Hz bis 20 kHz, T.H.D. 0.02% (an 4 <math>\Omega</math>/Ohm) DIN, 1 kHz, T.H.D. 0,5%</p> <p><b>Gesamtklirrfaktor:</b> (-3 dB bei Nennausgang, 8 <math>\Omega</math>/Ohm) (1 kHz)</p> <p><b>Intermodulationsverzerrung:</b> (60 Hz/7 kHz: 4/1 bei Nennausgang, 8 <math>\Omega</math>/Ohm)</p> <p><b>Netzbandbreite:</b> (8 <math>\Omega</math>/Ohms, Klirrfaktor 0,05%)</p> <p><b>Frequenzgang:</b> +0, -3 dB (bei 1 W)</p> <p><b>Eingangsempfindlichkeit:</b> Normaleingang:</p> <p><b>Eingangsimpedanz:</b> Normaleingang:</p> <p><b>Ausgangsimpedanz:</b></p> <p><b>Rauschabstand:</b> (IHF, A-bewertet) (Normal)</p> <p><b>Ausgangsklemmen:</b> Lautsprecher A oder B 4 <math>\Omega</math>/Ohm <math>\sim</math> 16 <math>\Omega</math>/Ohm A + B 8 <math>\Omega</math>/Ohm <math>\sim</math> 16 <math>\Omega</math>/Ohm</p> <p><b>Netzteil:</b></p> <p><b>Stromaufnahme:</b></p> <p><b>Abmessungen:</b> (einschließlich Reglern und Füßen)</p> <p><b>Gewicht:</b></p>	<p><b>• PARTIE AMPLIFICATEUR DE PUISSANCE</b></p> <p><b>Puissance nominale:</b> (charge 8 <math>\Omega</math>/ohms) 20 Hz à 20 kHz, D.H.T. 0.02% (charge 4 <math>\Omega</math>/ohms) DIN, 1 kHz, T.H.D. 0,5%</p> <p><b>Distorsion harmonique totale:</b> (-3 dB à la sortie nominale, 8 <math>\Omega</math>/ohms) (1 kHz)</p> <p><b>Distorsion d'intermodulation:</b> (60 Hz/7 kHz: 4/1 sortie nominale, sur 8 <math>\Omega</math>/ohms)</p> <p><b>Bande passante:</b> (8 <math>\Omega</math>/ohms, D.H.T. 0,05%)</p> <p><b>Réponse en fréquence:</b> +0, -3 dB (à 1 W)</p> <p><b>Sensibilité d'entrée:</b> Normal:</p> <p><b>Impédance d'entrée:</b> Normal:</p> <p><b>Impédance de sortie:</b></p> <p><b>Rapport S / B:</b> (IHF, pondéré A) (Normal)</p> <p><b>Bornes de sortie:</b> Enceintes A ou B 4 <math>\Omega</math>/ohms <math>\sim</math> 16 <math>\Omega</math>/ohms A + B 8 <math>\Omega</math>/ohms <math>\sim</math> 16 <math>\Omega</math>/ohms</p> <p><b>Alimentation:</b></p> <p><b>Consommation:</b></p> <p><b>Dimensions:</b> (avec les commandes et les pieds)</p> <p><b>Poids:</b></p>	<p>120 W</p> <p>200 W</p> <p>0.008%</p> <p>0.002%</p> <p>5 Hz <math>\sim</math> 50 kHz</p> <p>1 Hz <math>\sim</math> 100 kHz</p> <p>1.1 V</p> <p>47 k<math>\Omega</math>/kohms</p> <p>0.1 <math>\Omega</math>/ohm (1 kHz)</p> <p>110 dB</p> <p>AC 230 V / 50 Hz</p> <p>330 W</p> <p>434 (W) <math>\times</math> 135 (H) <math>\times</math> 353 (D) mm (17-3/32" <math>\times</math> 5-11/32" <math>\times</math> 13-19/32")</p> <p>12.3 kg (27 lbs 2 oz)</p>

- Specifications and contents are subject to change without notice for purposes of improvement.
- Änderungen des Inhalts und der technischen Daten zum Zwecke der Verbesserung vorbehalten.
- Spécifications et contenu sont sujets à modification sans préavis.

## DISASSEMBLY (POA-T3)

### 1. Top Cover

Remove 8 screws **(A)** fixing the Top Cover and 2 screws **(B)** mounting the Rear Panel. Detach the Top Cover as shown in arrow direction.

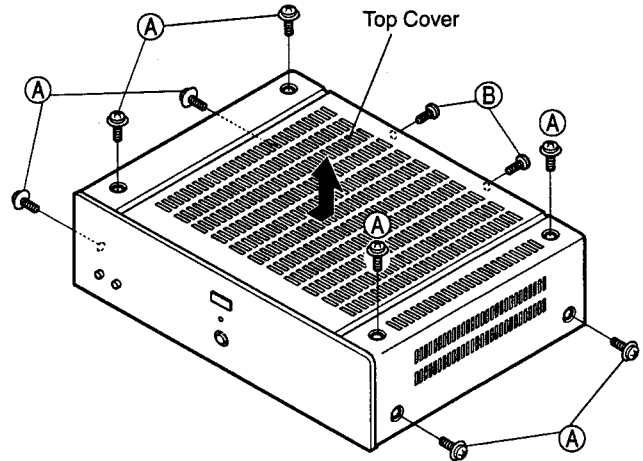

### 2. Front Panel

Remove 4 upper screws **(D)** and 2 screws **(C)** fixing the Front Panel and detach the Front Panel as shown in arrow direction.

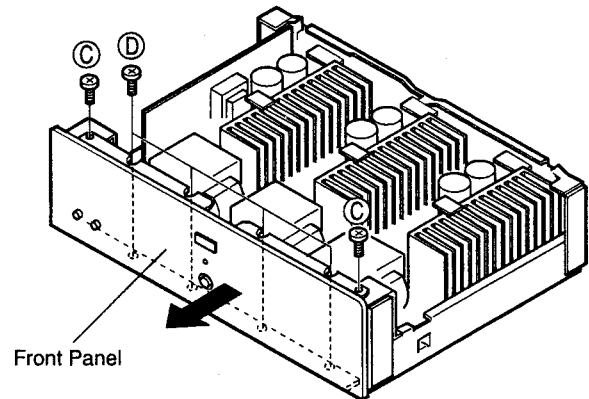

### 3. Each P.W.Board of Front Panel

- Speaker Switch P.W.Board  
Remove 2 screws **(E)** fixing the Speaker Switch P.W.Board and detach the Speaker Switch P.W.Board as shown in arrow direction.
- Power Supply Switch P.W.Board  
Remove 2 screws **(F)** mounting the Front Panel and detach the Power Supply Switch P.W. Board as shown in arrow direction.
- LED P.W.Board  
Undo 2 Hooks and detach the LED P.W.Board.

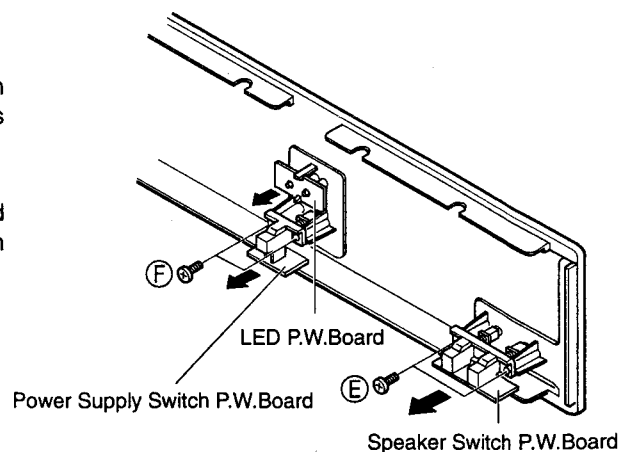

#### 4. Each P.W.Board and Fan of Rear Panel

- Protector P.W.Board  
Remove 3 screws (G) fixing the bracket. Detach the Protector P.W.Board as shown in arrow direction.
- Preset P.W.Board  
Remove 4 screws (H) fixing the Rear Panel and detach the Preset P.W.Board.
- Input (R, C, L) P.W.Board  
Remove each screw (I) fixing the Rear Panel and detach each Input (R, C, L) P.W.Board.
- Fan Cover  
Remove 4 screws (J) and detach the Fan Cover.

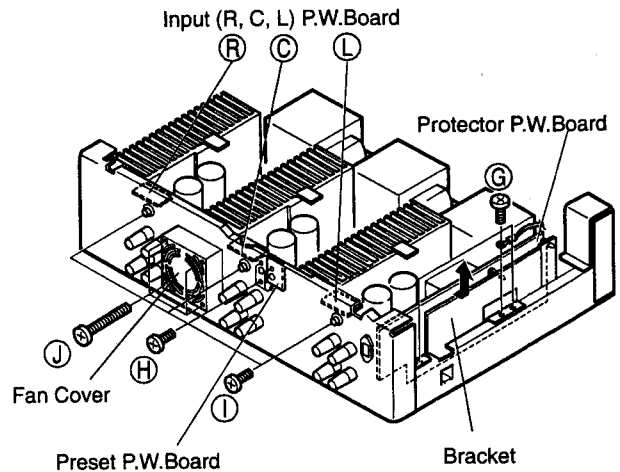

#### 5. Power Supply Transformer

Remove 12 screws (K) mounting the Chassis and detach 3 Power Supply Transformers.

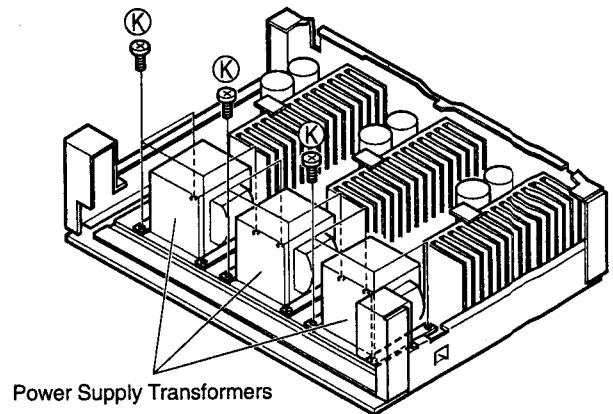

#### 6. Power Amp. P.W.Board

Undo 2 Holders, remove a screw (L) fixing the Rear Panel and 4 screws (M) fixing Radiator Plate of Power Amp. P.W.Board. Detach 3 Power Amp. P.W.Boards as same way above.

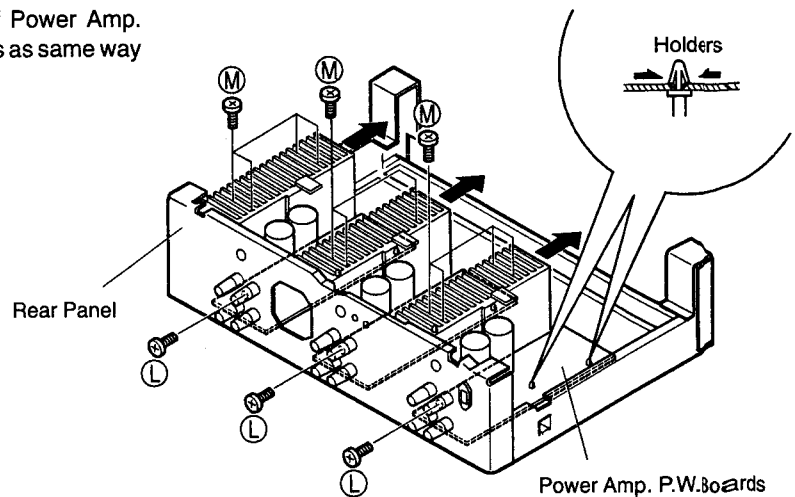

## (POA-T2/3200)

### 1. Top Cover

Remove 8 screws **(A)** fixing the Top Cover and 2 screws **(B)** mounting the Rear Panel. Detach the Top Cover as shown in arrow direction.

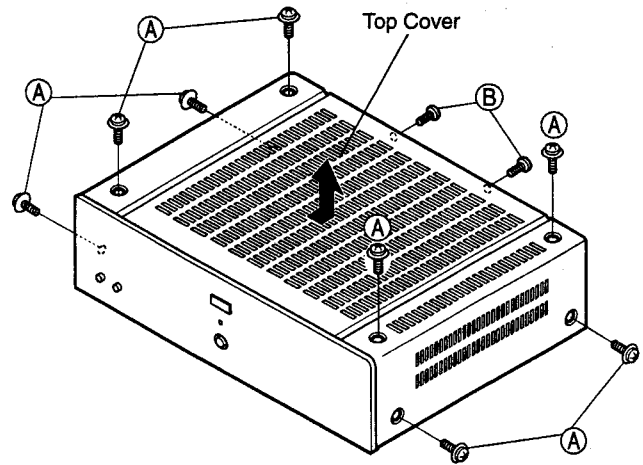

### 2. Front Panel

Remove 4 upper screws **(D)** and 2 screws **(C)** fixing the Front Panel and detach the Front Panel as shown in arrow direction.

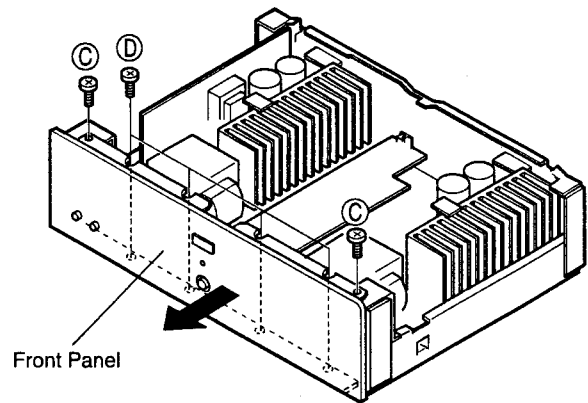

### 3. Each P.W.Board of Front Panel

- Speaker Switch P.W.Board  
Remove 2 screws **(E)** fixing the Speaker Switch P.W.Board and detach the Speaker Switch P.W.Board as shown in arrow direction.
- Power Supply Switch P.W.Board  
Remove 2 screws **(F)** mounting the Front Panel and detach the Power Supply Switch Board as shown in arrow direction.
- LED P.W.Board  
Undo 2 Hooks and detach the LED P.W.Board.

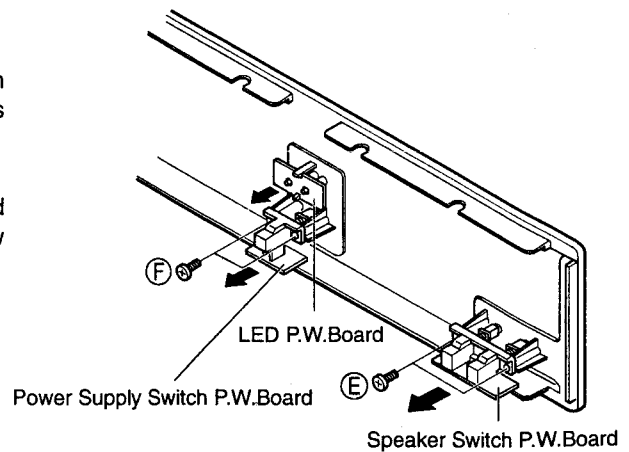

#### 4. Each P.W.Board and Fan of Rear Panel

- Protector P.W.Board  
Undo 2 Holders and remove 3 screws (G) fixing Protector P.W.Board. Detach the Protector P.W.Board as shown in arrow direction.
- Preset P.W.Board  
Remove 4 screws (H) fixing the Rear Panel and detach the Preset P.W.Board.
- Input (R, L) P.W.Board  
Remove each screw (I) fixing the Rear Panel and detach each Input (R, L) P.W.Board.
- Fan Cover (POA-T2 only)  
Remove 4 screws (J) and detach the Fan Cover.

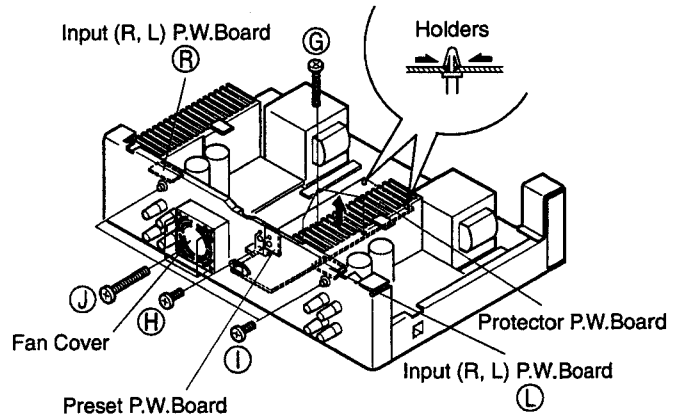

#### 5. Power Supply Transformer

Remove 8 screws (K) mounting the Chassis and detach 2 Power Supply Transformers.

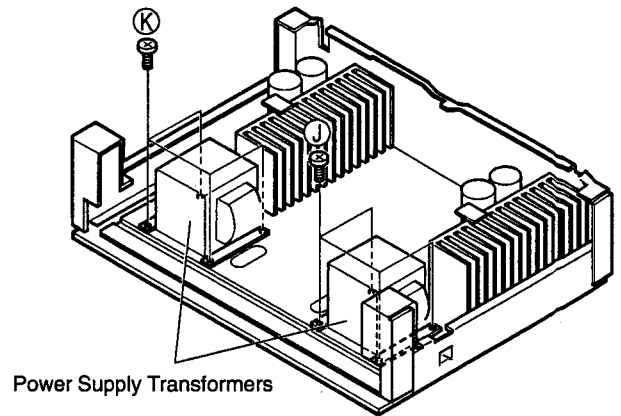

#### 6. Power Amp. P.W.Board

Undo 2 Holders, remove a screw (L) fixing the Rear Panel and 4 screws (M) fixing Radiator Plate of Power Amp. P.W.Board. Detach 2 Power Amp. P.W.Boards as same way above.

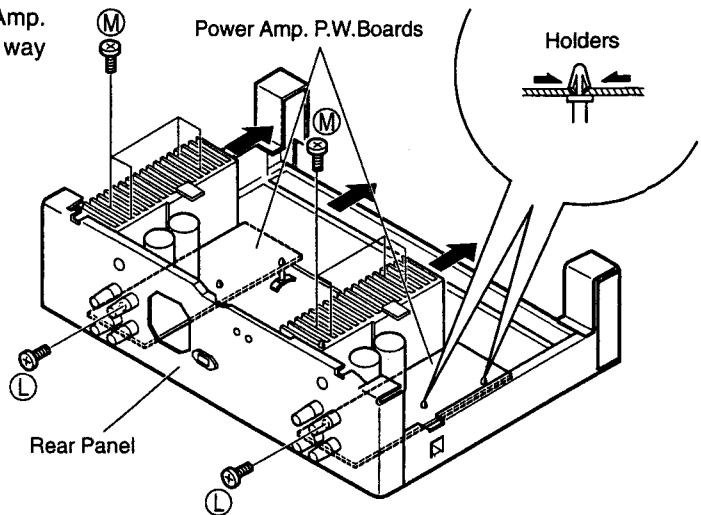

# BLOCK DIAGRAM

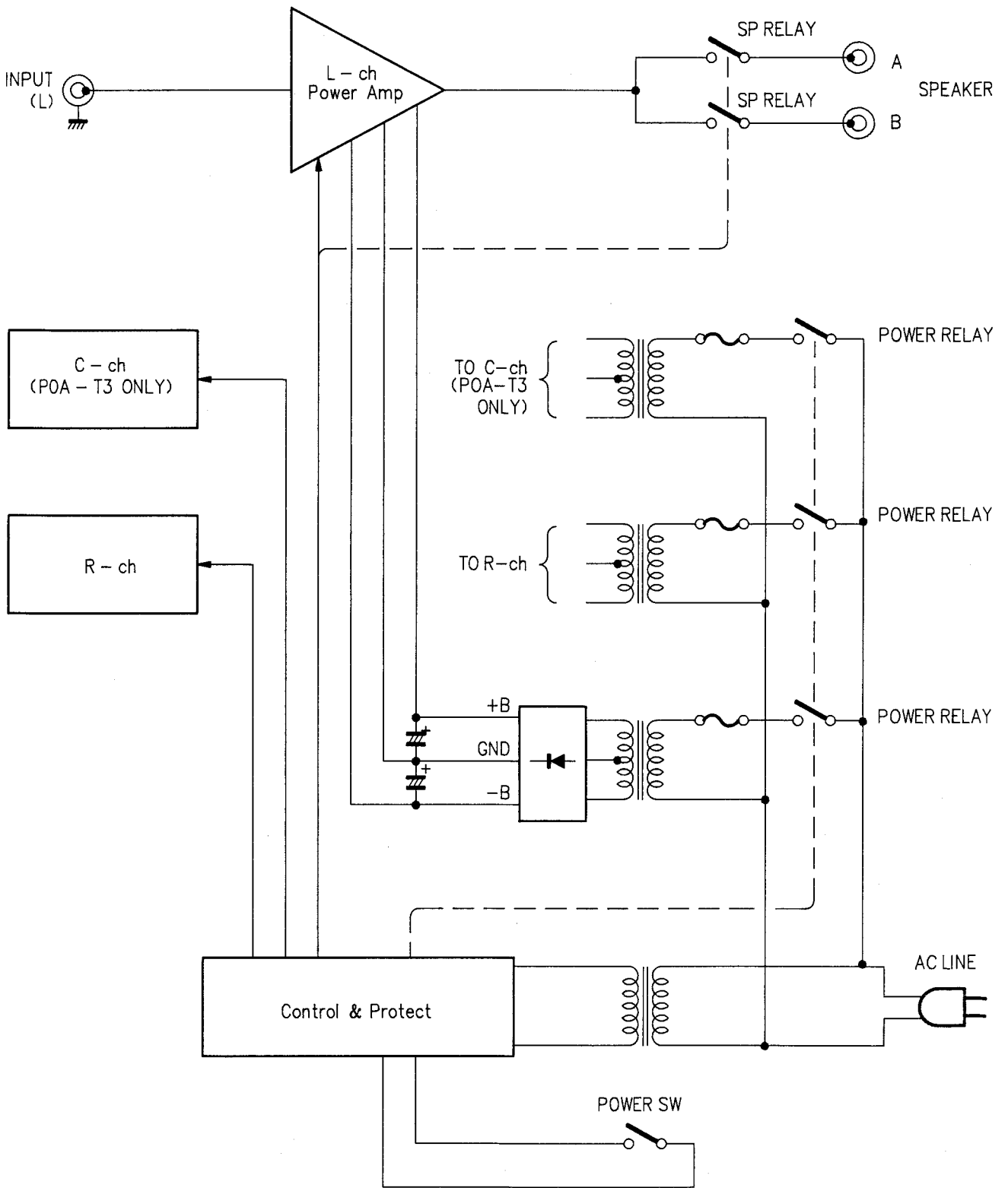



## METHOD OF ADJUSTMENT

### IDLE CURRENT ADJUSTMENT

#### ● Setup

1. Keep the unit away from direct wind blown by an air-conditioner and an electric fan, and keep the unit under normal conditions. Adjust the range of ambient temperature to 15 – 30°C.
2. Set the following conditions as follows:
  - POWER (Power switch) to off
  - SPEAKERS (Speaker Terminal) to no load (Speakers Disconnected),(But SP-A SW to on.)
  - Disconnect input terminal

#### ● Adjustment

1. Connect DC Voltmeter to Test points (TP101) of 1U-2909.
2. Turn POWER Switch "ON".
3. Adjust VR102 so that the DC Voltmeter reads  $2 \pm 0.5\text{mV}$ .
4. Then after 3 minutes warm-up time, readjust VR102 so that the DC Voltmeter reads  $2 \pm 1\text{mV}$ .
5. Adjust each channel as same way above.

### OFFSET ADJUSTMENT

#### ● Setup

1. Keep the unit away from direct wind blown by an air-conditioner and an electric fan, and keep the unit under normal conditions. Adjust the range of ambient temperature to 15 – 30°C.
2. Set the following conditions as follows:
  - POWER (Power switch) to off
  - SPEAKERS (Speaker Terminal) to no load (Speakers Disconnected),(But SP-A SW to on.)
  - Disconnect input terminal

#### ● Adjustment

1. Connect Speaker A terminal to DC Voltmeter and oscilloscope.
2. Adjust oscilloscope range to 5mV/div.
3. Turn Power Switch "ON".
4. Adjust VR101 so that the DC Voltmeter reads  $0 \pm 1\text{mV}$ .
5. Then after 3 minutes warm-up time, readjust VR101 so that the DC Voltmeter reads  $0 \pm 1\text{mV}$ .
6. Adjust each channel as same way above.

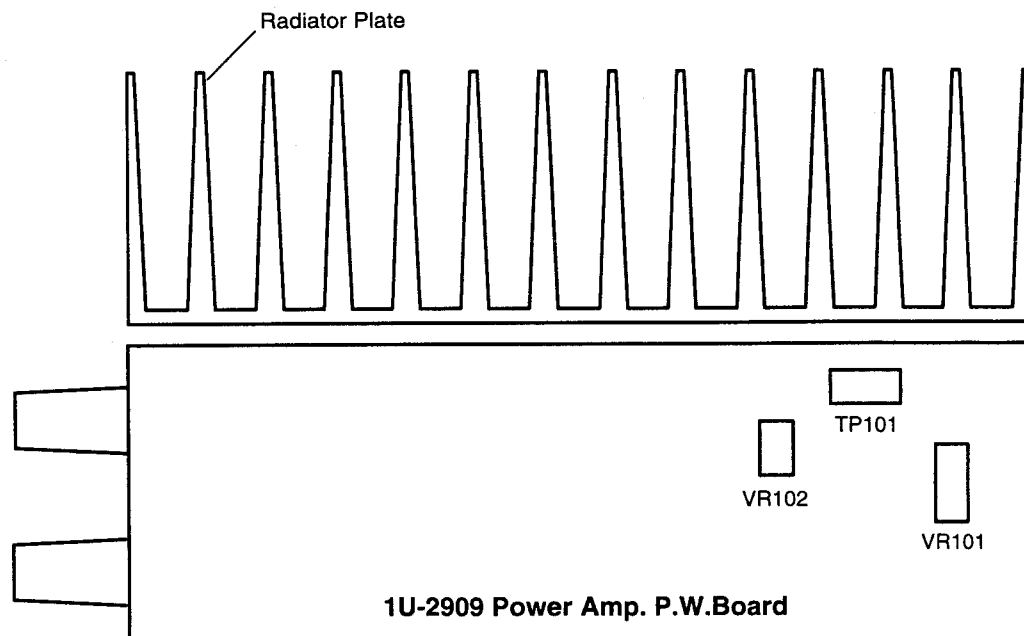

# SEMICONDUCTATORS

## ● TRANSISTORS

2SA1015 (GR)  
2SC1815 (BL)  
2SC1841 (E/F)

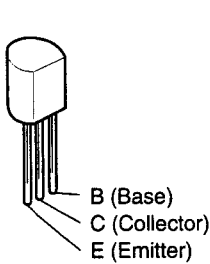

2SA1145 (O)/(Y)  
2SC2705 (O)/(Y)

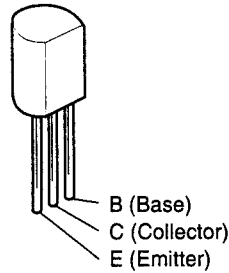

RN1201 (4.7k-4.7k)  
RN1202 (10k-10k)

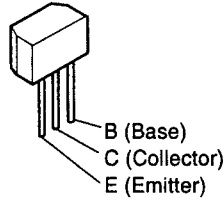

RN1202

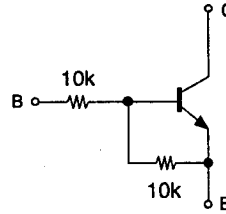

RN1201

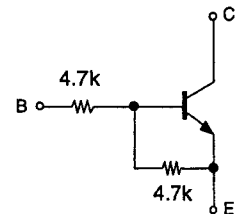

2SA1048 (GR)  
2SC2458 (BL)

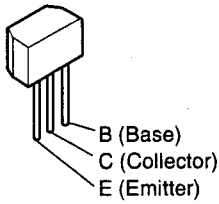

2SC3421

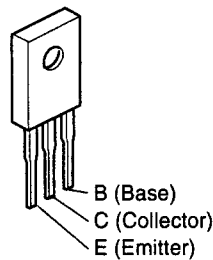

2SA1837-Y  
2SC4793-Y

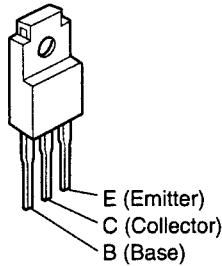

2SA1302 (R/O)  
2SC3281 (R/O)

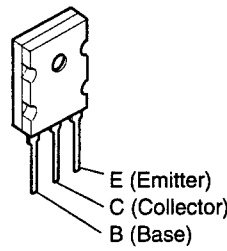

2SK389 (GR)/(BL)/(V)

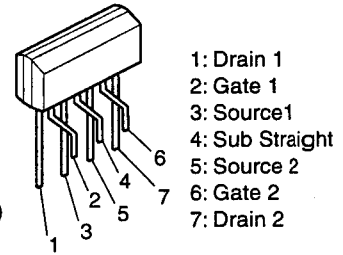

## ● DIODES (included LED)

HZS2B-1 HZS7B-1  
HZS3C-1 HZS7C-1  
HZS4B-1

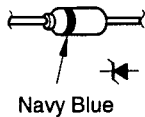

1S2076A  
1SS270A

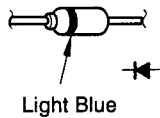

1SR35-200A

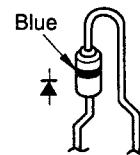

4D4B42

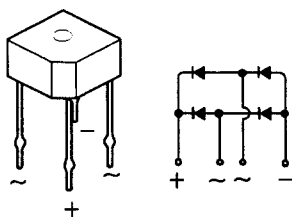

SFOR3G42  
(Thyristor)

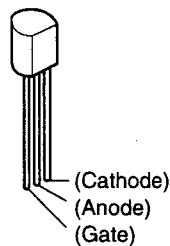

SML1216W (LED)

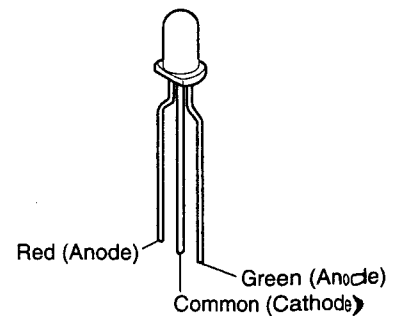

## NOTE FOR PARTS LIST

- Part indicated with the mark "◎" are not always in stock and possibly to take a long period of time for supplying, or in some case supplying of part may be refused.
- When ordering of part, clearly indicate "1" and "1" (i) to avoid mis-supplying.
- Ordering part without stating its part number can not be supplied.
- Part indicated with the mark "★" is not illustrated in the exploded view.
- Not including Carbon Film ±5%, 1/4W Type in the P.W.Board parts list. (Refer to the Schematic Diagram for those parts.)

**WARNING:**

Parts marked with this symbol  have critical characteristics.  
Use ONLY replacement parts recommended by the manufacturer.

### ● Resistors

Ex.: RN 14K 2E 182 G FR  
 Type Shape and performance Power Resistance Allowable error Others

RD : Carbon	2B : 1/8W	F : ±1%	P : Pulse-resistant type
RC : Composition	2E : 1/4W	G : ±2%	NL : Low noise type
RS : Metal oxide film	2H : 1/2W	J : ±5%	NB : Non-burning type
RW : Winding	3A : 1W	K : ±10%	FR : Fuse-resistor
RN : Metal film	3D : 2W	M : ±20%	F : Lead wire forming
RK : Metal mixture	3F : 3W		
	3H : 5W		

**\* Resistance**

1 8 2 ⇒ 1800 ohm = 1.8 kohm  
 Indicates number of zeros after effective number.  
 2-digit effective number.

• Units: ohm

1 R 2 ⇒ 1.2 ohm  
 1-digit effective number.  
 2-digit effective number, decimal point indicated by R.

• Units: ohm

### ● Capacitors

Ex.: CE 04W 1H 2R2 M BP  
 Type Shape and performance Dielectric strength Capacity Allowable error Others

CE : Aluminum foil electrolytic	0J : 6.3V	F : ±1%	HS : High stability type
CA : Aluminum solid electrolytic	1A : 10V	G : ±2%	BP : Non-polar type
CS : Tantalum electrolytic	1C : 16V	J : ±5%	HR : Ripple-resistant type
CQ : Film	1E : 25V	K : ±10%	DL : For charge and discharge
CK : Ceramic	1V : 35V	M : ±20%	HF : For assuring high frequency
CC : Ceramic	1H : 50V	Z : +80%	U : UL part
CP : Oil	2A : 100V	-20%	C : CSA part
CM : Mica	2B : 125V	P : +100%	W : UL-CSA type
CF : Metallized	2C : 160V	-0%	F : Lead wire forming
CH : Metallized	2D : 200V	C : ±0.25pF	
	2E : 250V	D : ±0.5pF	
	2H : 500V	= : Others	
	2J : 630V		

**\* Capacity (electrolyte only)**

2 2 2 ⇒ 2200µF  
 Indicates number of zeros after effective number.  
 2-digit effective number.

• Units: µF.

2 R 2 ⇒ 2.2µF  
 1-digit effective number.  
 2-digit effective number, decimal point indicated by R.

• Units: µF.

**\* Capacity (except electrolyte)**

2 2 2 ⇒ 2200pF = 0.0022µF  
 (More than 2) — Indicates number of zeros after effective number.  
 2-digit effective number.

• Units: µF.

2 2 1 ⇒ 220pF  
 (0 or 1) — Indicates number of zeros after effective number.  
 2-digit effective number.

• Units: pF.

• When the dielectric strength is indicated in AC, "AC" is included after the dielectric strength value.

# PARTS LIST OF PRINTED WIRING BOARD

## 1U-2909 MAIN P.W.B. UNIT ASS'Y

Ref. No.	Part No.	Part Name	Remarks
<b>SEMICONDUCTORS GROUP</b>			
TR101	275 0045 012	Transistor 2SK389 (GR)/(BL)/(V)	
TR103,104	273 0235 923	Transistor 2SC1841 (E/F)	
TR105,106	271 0168 900	Transistor 2SA1145 (O)/(Y)	
TR108	273 0281 906	Transistor 2SC2705 (O)/(Y)	
TR109	273 0423 007	Transistor 2SC4793-Y	
TR110	271 0272 003	Transistor 2SA1837-Y	
TR115	273 0281 906	Transistor 2SC2705 (O)/(Y)	
TR116,117	273 0235 923	Transistor 2SC1841 (E/F)	
TR304	271 0191 906	Transistor 2SA1048 (GR)	
D101-105	276 0432 903	Diode 1SS270A	
D106,106	276 0424 005	Diode 4D4B42 (LC1)	
D107,108	276 0432 903	Diode 1SS270A	
ZD101,102	276 0466 908	Zener diode HZS7C-1	
ZD103	276 0454 907	Zener diode HZS3C-1	
ZD104	276 0456 905	Zener diode HZS4B-1	
ZD105,106	276 0466 908	Zener diode HZS7C-1	
PT101,101	279 0034 067	Photo transistor PTH9M04BB222TS2F333	
<b>RESISTORS GROUP</b>			
VR101	211 6175 011	Semi fixed resistor 100ohm	V06PB101(Sermet)
VR102	211 6075 037	Semi fixed resistor 10kohm	V06PB103(Sermet)
VR103,103	211 0741 008	Variable resistor 50kohm	V1610V25FB503 (POA-3200 only)
△ R101	241 2426 953	Carbon 51kohm 1/4W	RD14B2E513J(PSNB)
△ R102	241 2381 904	Carbon 3.3kohm 1/4W	RD14B2E332JNBS
△ R103	241 2375 981	Carbon 22ohm 1/4W	RD14B2E220JNBS
△ R104,105	241 2361 946	Carbon 4.2kohm 1/4W	RD14B2E472JNBS
△ R106	241 2424 968	Carbon 8.2kohm 1/4W	RD14B2E822J(PSNB)
△ R107	241 2379 987	Carbon 1kohm 1/4W	RD14B2E102JNBS
△ R108	241 2425 996	Carbon 30kohm 1/4W	RD14B2E303J(PSNB)
△ R109	241 2429 963	Carbon 1Mohm 1/4W	RD14B2E105J(PSNB)
△ R110-113	244 2051 932	Metallic 3.3kohm 1W	RS14B3A332JNBS(S)
△ R114	241 2380 921	Carbon 1.2kohm 1/4W	RD14B2E152JNBS
△ R115,116	241 2313 969	Carbon 47ohm 1/4W	RD14B2E470GFBS
△ R117,118	241 2316 937	Carbon 470ohm 1/4W	RD14B2E471GFBR
△ R119	241 2371 985	Carbon 91ohm 1/4W	RD14B2E910GFBS
△ R120	244 2052 999	Metallic 10kohm 1W	RS14B3A103JNBS(S)
△ R121	241 2424 942	Carbon 6.8kohm 1/4W	RD14B2E682J(PSNB)
△ R123,124	241 2313 901	Carbon 100ohm 1/4W	RD14B2E101GFBS
△ R127	241 2387 940	Carbon 4.7ohm 1/4W	RD14B2E47JNBS
△ R128	241 2378 920	Carbon 220ohm 1/4W	RD14B2E221JNBS
△ R129	241 2387 940	Carbon 4.7ohm 1/4W	RD14B2E47JNBS
△ R130,131	243 2061 000	Wire wound 0.1ohm/3W	RW99-3FDR1K
△ R132,133	241 2387 940	Carbon 4.7ohm 1/4W	RD14B2E47JNBS

Ref No.	Part No.	Part Name	Remarks
△ R134,135	243 2061 000	Wire wound 0.1ohm/3W	RW99-3FDR1K
△ R136,139	244 2051 929	Metallic 820ohm 1W	RS14B3A821JNBS(S)
△ R140	244 2051 929	Metallic 820ohm 1W	RS14B3A821JNBS(S)
△ R141,142	241 2380 921	Carbon 1.2kohm 1/4W	RD14B2E152JNBS
△ R144	244 2043 937	Metallic 10ohm 1W	RS14B3A100JNBS(S)
△ R147	244 2050 904	Metallic 22ohm 1W	RS14B3A220JNBS(S)
△ R148	244 2051 987	Metallic 4.7ohm 1W	RS14B3A47JNBS(S)
△ R151	241 2420 904	Carbon 100ohm 1/4W	RD14B2E101J(PSNB)
△ R152	244 2051 929	Metallic 820ohm 1W	RS14B3A821JNBS(S)
△ R154	241 2429 963	Carbon 1Mohm 1/4W	RD14B2E105J(PSNB)
<b>CAPACITORS GROUP</b>			
C000	255 6181 073	Film 27pF/400V	CQ09S2G270KF(B)
C101,102	254 4356 014	Electrolytic 100µF/50V	CE04W1H101M(ARS)
C103	255 4235 950	Film 6800pF/100V	CQ93P2A682J(NH)
C104	255 4235 921	Film 270pF/100V	CQ93P2A271J(NH)
C105	255 4235 918	Film 100pF/100V	CQ93P2A101J(NH)
C106,106	253 4480 903	Ceramic 27pF/250V	CC45SL2H270J
C109	255 4235 918	Film 100pF/100V	CQ93P2A101J(NH)
C111	255 4232 924	Film 39pF/100V	CQ93P2A390J(NH)
C112	255 4235 989	Film 470pF/100V	CQ93P2A471J(NH)
C115,116	254 4498 707	Electrolytic 220µF/25V	CE04W1E221MC(ARS)
C117	254 4313 963	Electrolytic 1µF/50V	CE04W1H010M(ASF)
C118,118	254 4356 027	Electrolytic 22µF/50V	CE04W1H220M(ARS)
C122	254 4313 963	Electrolytic 1µF/50V	CE04W1H010M(ASF)
C124	255 4235 934	Film 0.01µF/100V	CQ93P2A103J(NH)
C125	255 4199 973	Film 0.01µF/50V	CQ92M1H103J(MRZ)
C126,127	255 4235 743	Film 0.022µF/100V	CQ93P2A223J(NH)
C130	255 4237 903	Film 2700pF/100V	CQ93P2A272J(NH)
C131,132	256 1042 903	Metalzide 0.1µF/250V	CF93A2E104K
C133,134	255 4237 903	Film 2700pF/100V	CQ93P2A272J(NH)
C138	255 4235 918	Film 100pF/100V	CQ93P2A101J(NH)
<b>OTHERS PARTS GROUP</b>			
	203 0386 093	1P SIN connector Assy	
	203 0602 065	1P SIN cord Assy	
JK101	204 8500 007	1P Pin jack (WH)	
	205 0185 038	3P wire holder	
TP101	205 0190 036	3P NH connector base	
CB101	205 0278 039	3P EH connector base (BK)	
CB102	205 0233 032	3P EH connector base	
CN101	205 0278 039	3P EH connector base (BK)	
CN102	205 0233 032	3P EH connector base	
CN103	205 0355 062	6P KR connector base (L)	
SP101	205 0991 002	4P Terminal (S-GND)	
RL101,102	214 0167 005	Relay(G5Z-2A)	
L101	235 0068 004	Inductor(1MH)	
	415 0309 013	PVC tube (L=10)	

1U-2910 CONTROL P.W.B. UNIT ASS'Y

Ref. No.	Part No.	Part Name	Remarks	Ref No.	Part No.	Part Name	Remarks
<b>SEMICONDUCTORS GROUP</b>				<b>OTHERS PARTS GROUP</b>			
TR301	273 0317 906	Transistor 2SC2458(BL)	(POA-T3G only)	C310	254 4250 932	Electrolytic 220µF/6.3V	CE04W0J221M
TR302,303	269 0023 903	Transistor RN1201(4.4k-4.7k)		C311	254 4260 948	Electrolytic 1µF/50V	CE04W1H010M
TR304	271 0191 906	Transistor 2SA1048(GR)		C312	254 4260 919	Electrolytic 0.22µF/50V	CE04W1HR22M
TR305,306	273 0317 906	Transistor 2SC2458(BL)		C313	254 4254 792	Electrolytic 2200µF/16V	CE04W1C222MC
TR307	273 0317 906	Transistor 2SC2458(BL)		C314	254 4256 949	Electrolytic 100µF/25V	CE04W1E101M
TR308	273 0198 015	Transistor 2SC1815(BL)		C315	254 4256 949	Electrolytic 100µF/25V	CE04W1E101M (POA-T3G only)
TR309	273 0317 906	Transistor 2SC2458(BL)		<b>OTHERS PARTS GROUP</b>			
TR310	271 0102 924	Transistor 2SA1015(GR)		△	202 0040 909	Fuse dip	
TR311	271 0191 906	Transistor 2SA1048(GR)			203 0644 007	1P SIN cord Assy	
TR312,313	273 0317 906	Transistor 2SC2458(BL)		JK301,302	204 8101 008	2P Power jack	
TR314	271 0191 906	Transistor 2SA1048(GR)		△ CN001	205 0606 025	2P Wrapping terminal	
TR315-317	273 0317 906	Transistor 2SC2458(BL)		△ CN002,003	205 0606 025	2P Wrapping terminal	(POA-3200/POA-T2G)
TR318	273 0235 923	Transistor 2SC1841(E/F)		△ CN002,003	205 0606 036	3P Wrapping terminal	(POA-T3G)
TR319	271 0191 906	Transistor 2SA1048(GR)		CN301,301	205 0233 032	3P EH connector base	
TR320	273 0235 923	Transistor 2SC1841(E/F)		CN302,302	205 0277 030	3P EH connector base (RD)	
TR321	271 0191 906	Transistor 2SA1048(GR)		CN303,303	205 0296 037	3P EH connector base (YW)	
TR322	273 0235 923	Transistor 2SC1841(E/F)		CN304-306	205 0233 061	6P EH connector base	
TR324	269 0025 901	Transistor RN1202(10k-10k)		CN307,307	205 0276 031	3P EH connector base (BU)	
TR325	269 0025 901	Transistor RN1202(10k-10k)		CN308,308	205 0949 038	3P EH connector base (GR)	
TR326	269 0023 903	Transistor RN1201(4.4k-4.7k)		△ F001	206 1015 061	Fuse 2A	(POA-T3G only)
TR327	273 0317 906	Transistor 2SC2458(BL)		△ F002,003	206 1015 061	Fuse 2A	
D001	276 0432 903	Diode 1SS270A		SW301	212 4791 002	2P push switch	
D002,003	276 0432 903	Diode 1SS270A		SW303	212 1056 009	1P push switch	
D301-303	276 0432 903	Diode 1SS270A		△ RL001	214 0142 004	Relay(TV-5)	(POA-T3G only)
D304-309	276 0553 905	Diode 1SR35-200A		△ RL002,003	214 0142 004	Relay(TV-5)	
D310-313	276 0432 903	Diode 1SS270A		△ T301	233 5746 006	Power trans (EU mini)	
ZD301	276 0450 901	Zener diode HZS2B-1		P301	279 0034 041	Thermistor PTH9M04BD222TS2F333	
ZD302,303	276 0456 905	Zener diode HZS4B-1	LD001	393 9491 004	LED (SML1216W)	T2.0A	
ZD304	276 0456 905	Zener diode HZS4B-1		513 9406 004	Fuse label		
ZD305	276 0465 909	Zener diode HZS7B-1					
SC301	279 0038 908	SCR SFOR3G42					
<b>RESISTORS GROUP (Not included carbon film ±5% 1/4W)</b>							
<b>CAPACITORS GROUP</b>							
△ C001	253 9014 702	Ceramic 0.01µF/400V AC	CK45F2GAC103MC (POA-T3G only)				
△ C002,003	253 9014 702	Ceramic 0.01µF/400V AC	CK45F2GAC103MC				
C005	255 4223 920	Film 0.01µF/50V	CQ92M1H103J(MRZ)				
C301,302	253 1146 907	Ceramic 0.01µF/50V	CK45F1H103Z				
C303,304	254 4254 909	Electrolytic 10µF/16V	CE04W1C100M				
C305	254 4254 909	Electrolytic 10µF/16V	CE04W1C100M (POA-T3G only)				
C307	254 4252 943	Electrolytic 220µF/10V	CE04W1A221M				
C308	254 4254 909	Electrolytic 10µF/16V	CE04W1C100M				

**PARTS LIST OF EXPLODED VIEW (POA-T3)**

Ref. No.	Part No.	Part Name	Remarks	Q'ty	Ref. No.	Part No.	Part Name	Remarks	Q'ty
1	1U- 2909	Main P.W.B. unit Ass'y		3	45	412 9499 006	Support braket (R)		1
1-1	—	Power amp. P.W.B. unit			46	412 9497 008	Support braket (L)		1
1-2	—	Input P.W.B. unit			47	—			
2	1U- 2910 B	Control P.W.B. unit Ass'y		1	48	—			
2-1	—	Control P.W.B. unit			49	—			
2-2	—	SP. switch P.W.B. unit			50	—			
2-3	—	Remote P.W.B. unit			51	412 2814 028	Card spacer (L=10)		2
2-4	—	Power switch P.W.B. unit			52	—			
2-5	—	LED P.W.B. unit			53	—			
3	105 1188 200	Bottom cover		1	54	477 0096 007	Push rivet		12
4	412 4078 105	Angle (A)		1	★	001 0085 073	Vinyl wire		1
5	412 4089 107	Angle (B)		1	★	001 0085 086	Vinyl wire		1
6	412 4079 201	Trans bracket		1	★	203 5111 027	3P EH-EH shield	CN101×3	3
7	411 9136 117	Side chassis		2	★	203 5134 004	3P EH-EH connector cord		2
8	104 9044 000	Foot Ass'y		4	★	203 5134 017	3P EH-EH connector cord	CN301	1
9	105 1189 319	Rear panel		1	★	203 5134 020	3P EH-EH connector cord	CN302	1
10	415 9016 035	P.W.B. holder		6	★	203 5135 003	3P PH-PH connector cord	CN307	1
11	417 0530 105	Radiator		3	★	203 5135 016	3P PH-PH connector cord	CN308	1
12	412 4080 106	Radiator plate		6	★	204 0378 091	6P KR-KR ribbon 250	CN103A	1
13	412 3225 205	P.W.B.bracket (A)		6	★	204 0379 058	6P KR-KR ribbon 400	CN103B	1
14	273 0391 003	2SC3281 (R/O)	TR111,113×3	6	★	415 0777 001	UL tube		1
15	271 0245 001	2SA1302 (R/O)	TR112,114×3	6	★	415 0393 029	UL tube (12.7)		1
16	273 0323 000	2SC3421 (O/Y)	TR107×3	3	★	445 0048 016	Cord holder (L50)		6
17	254 4500 006	Electrolytic 6800μF/71V	C128,129×3	6	<b>SCREWS</b>				
18	412 9503 002	P.W.B.bracket (IN)		1	101	473 7002 034	Screw 3×6 CBTS(S)-B		45
19	412 3548 021	P.W.B.catcher		4	102	473 7508 046	Screw 3×16 CBTS(P)-B		3
20	415 9016 019	P.W.B.holder		2	103	477 0064 107	Fixing screw		10
21	144 2491 111	Fan cover		1	104	473 8050 014	Screw 3×30 CBTS(2)-B		4
22	421 0722 006	Motor fan		1	105	473 7007 000	Screw 4×8 CBTS(S)-B		25
23	412 4081 105	Front bracket (L)		1	106	473 7500 044	Screw 3×8 CBTS(P)-B		7
24	412 4082 104	Front bracket (R)		1	107	473 7015 005	Screw 3×6 CBTS(S)-B		6
△ 25	233 6200 006	Power trans (E2)		3	108	471 9043 008	Special screw 4×10 CBTS-S-G		8
△ 26	203 3970 006	AC inlet		1	109	473 7015 018	Screw 3×8 CBTS(S)-B		2
27	415 9059 005	Insulating sheet		12	110	473 8034 001	Screw 3×8 CBTS(B)-CU		15
28	144 2489 259	Front panel Ass'y		1	111	473 8007 038	Cup screw 3×14		15
29	—				112	473 7003 017	Screw 3×8 CFTS(S)-B		2
30	461 9001 001	Rubber sheet		2	<b>PACKING &amp; ACCESSORIES</b>				
31	461 0390 012	Rubber sheet		4		203 4442 001	Remote plug cord		1
32	122 9006 004	Spacer		1		206 2147 006	AC cord with connector		1
33	113 9303 101	Power button Ass'y		1		501 9265 064	Carton case		1
34	143 0952 002	Lens		1		503 9275 102	Cushion		2
35	146 1606 013	LED guide		1		504 9102 003	Stylene paper		1
36	113 1356 062	Push button (MARU)		2		505 8006 019	Envelope		1
37	102 9048 246	Top cover		1		505 9102 006	Poly cover		1
38	205 0991 002	4P terminal (S-GND)	SP101×3	3		511 9445 001	Instructions manual		1
39	204 8500 007	1P pin jack (WH)	JK101×3	3		513 9111 001	Color label (GOLD)		2
40	204 8101 008	2P power jack	JK301,302	2					
41	212 4791 002	2P push switch	SW301	1					
42	212 1056 009	1P push switch	SW303	1					
△ 43	233 0199 007	Power trans (E2 mini)	T301	1					
△ 44	206 1015 061	Fuse 2A	F001,002,003	3					

# EXPLODED VIEW (POA-T3)

1                      2                      3                      4                      5                      6                      7                      8

**WARNING:**  
Parts marked with this symbol  have critical characteristics.  
Use ONLY replacement parts recommended by the manufacturer.

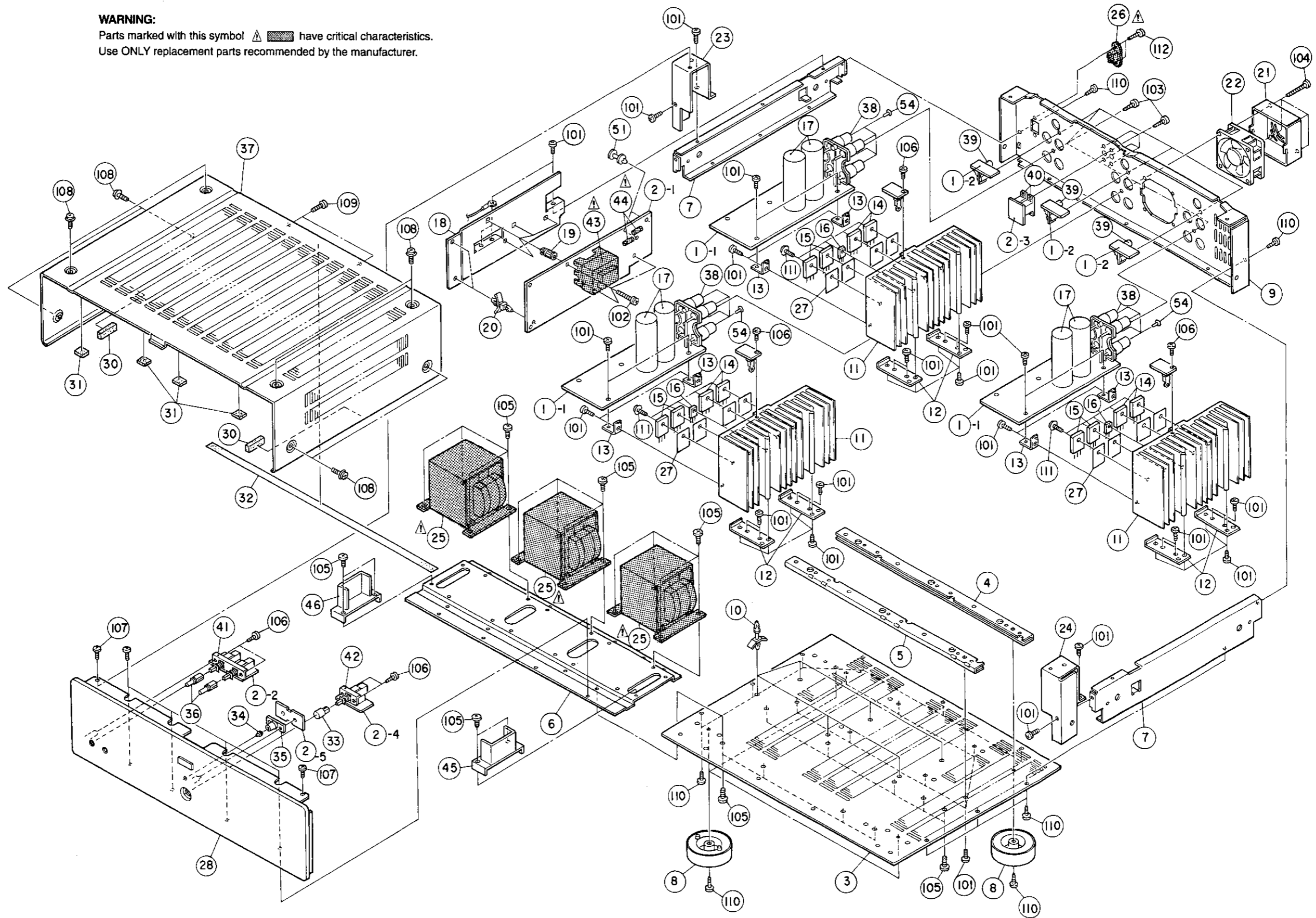

A  
B  
C  
D  
E





# EXPLODED VIEW (POA-T2/3200)

1                      2                      3                      4                      5                      6                      7                      8

**WARNING:**  
Parts marked with this symbol  have critical characteristics.  
Use ONLY replacement parts recommended by the manufacturer.

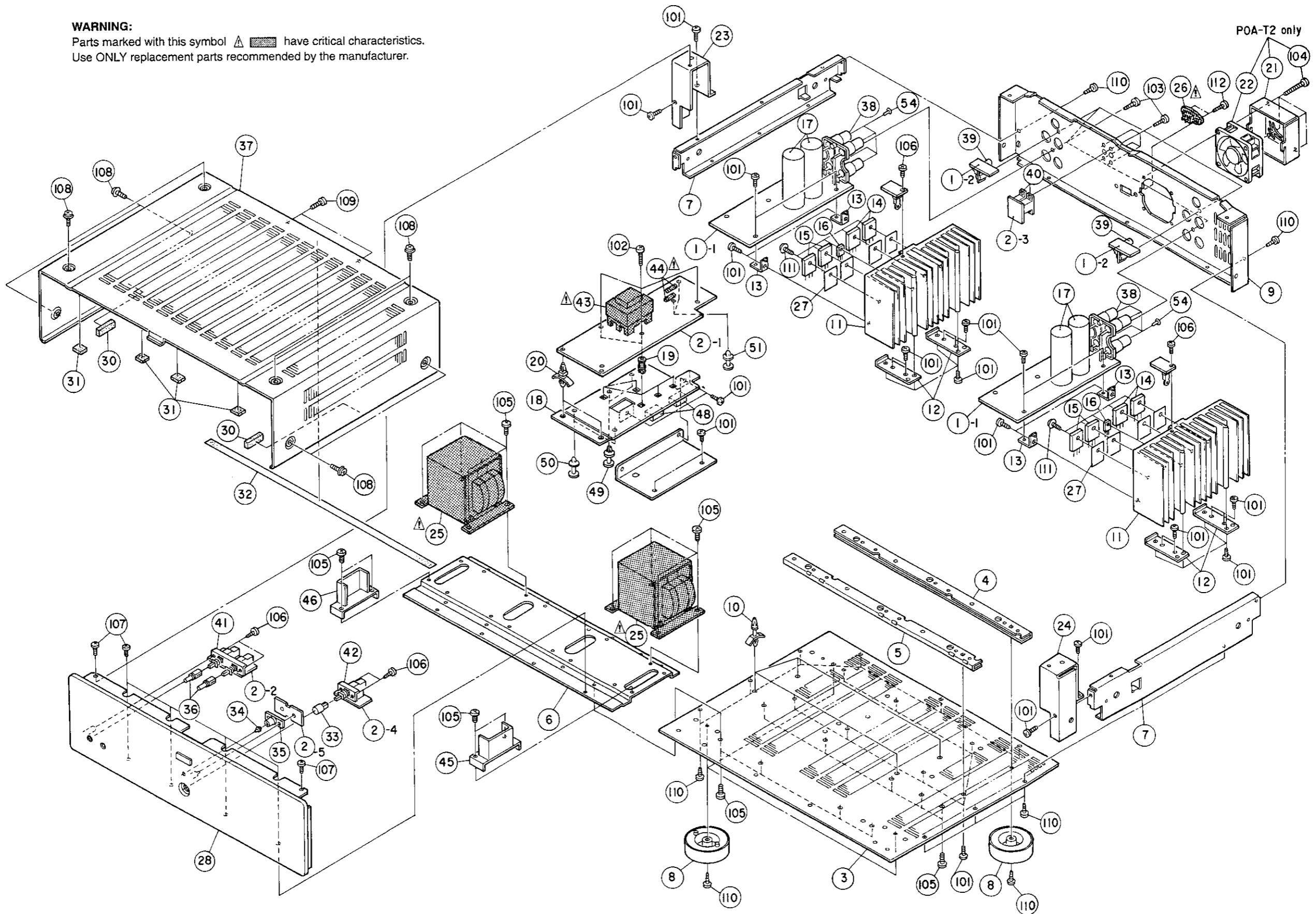

PRINTED WIRING BOARD

1 2 3 4 5 6 7 8

1U-2909 MAIN P.W.B. UNIT ASS'Y

A

B

C

D

E

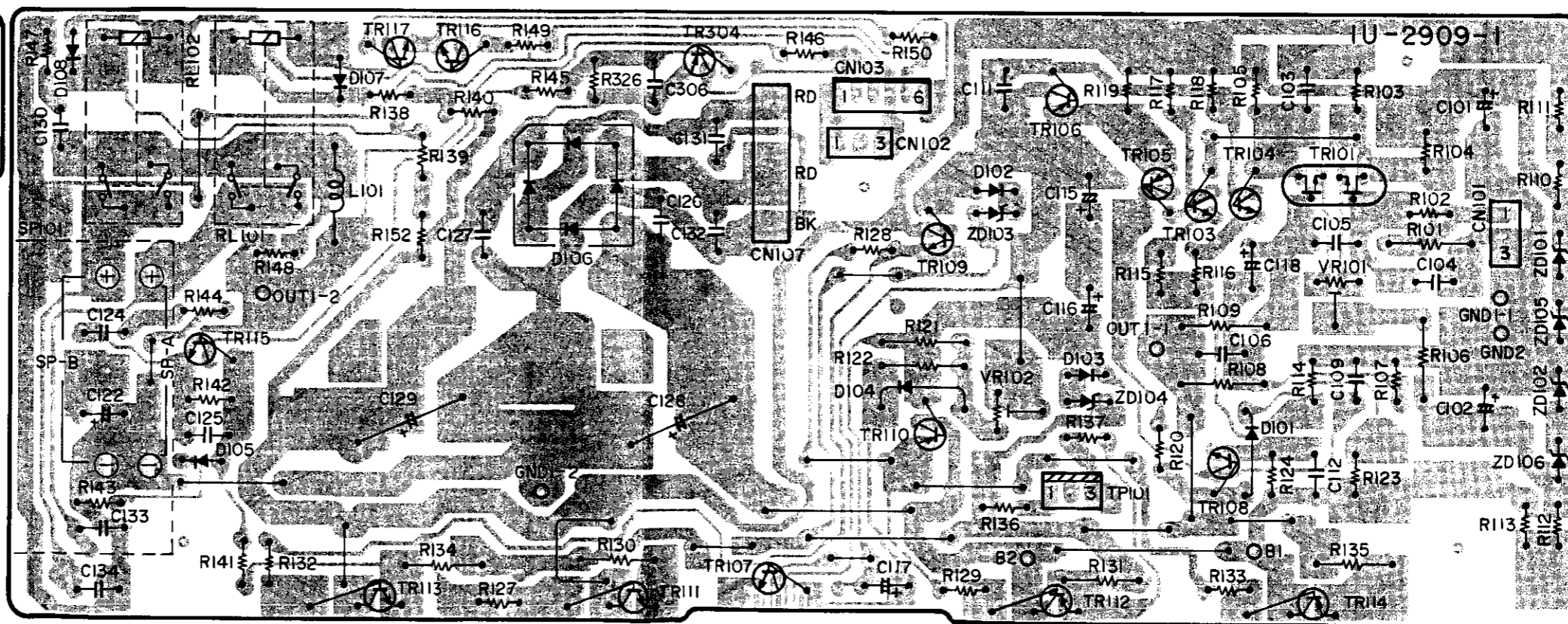
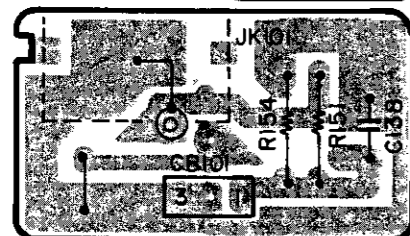
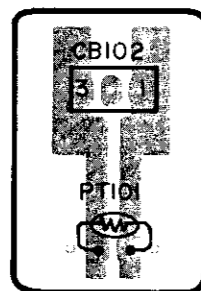

1 2 3 4 5 6 7 8

1U-2910 CONTROL P.W.B. UNIT ASS'Y

A

B

C

D

E

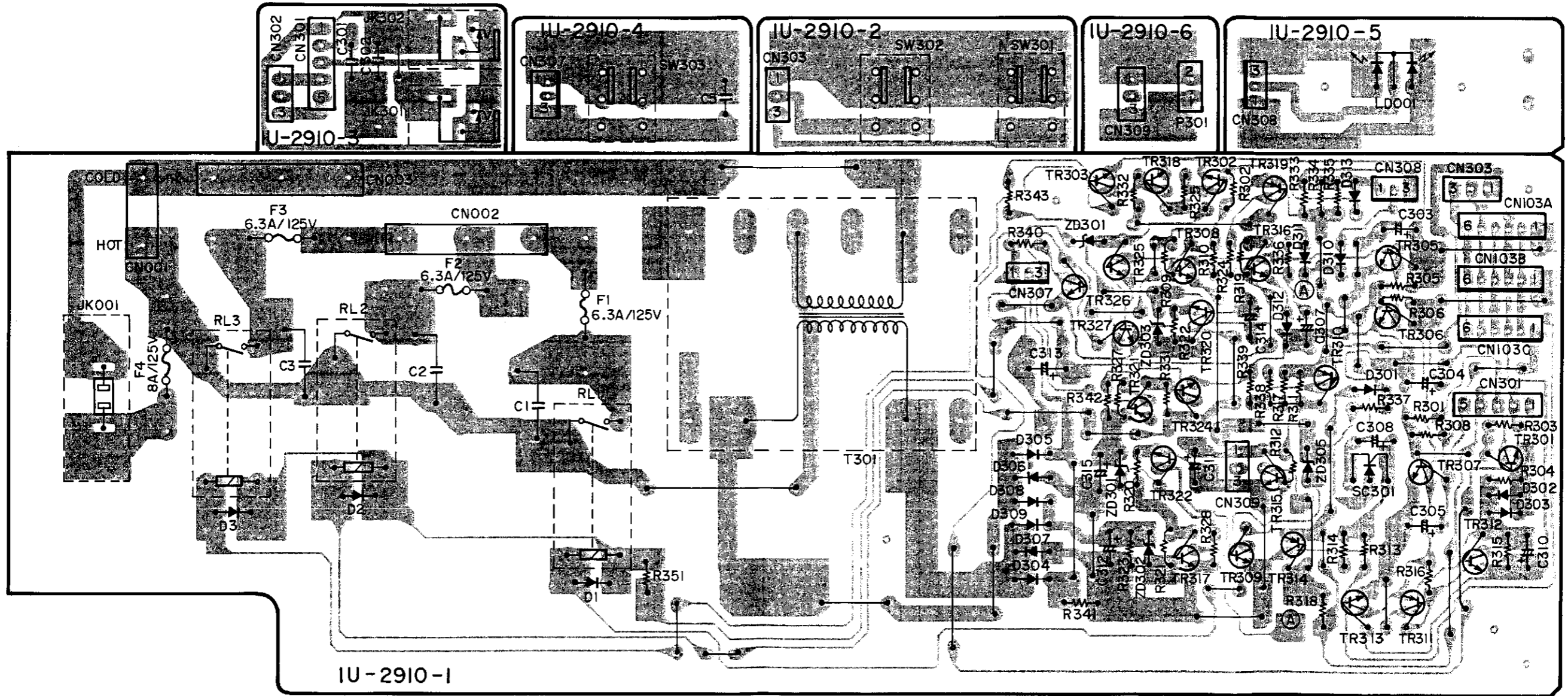

WIRING DIAGRAM

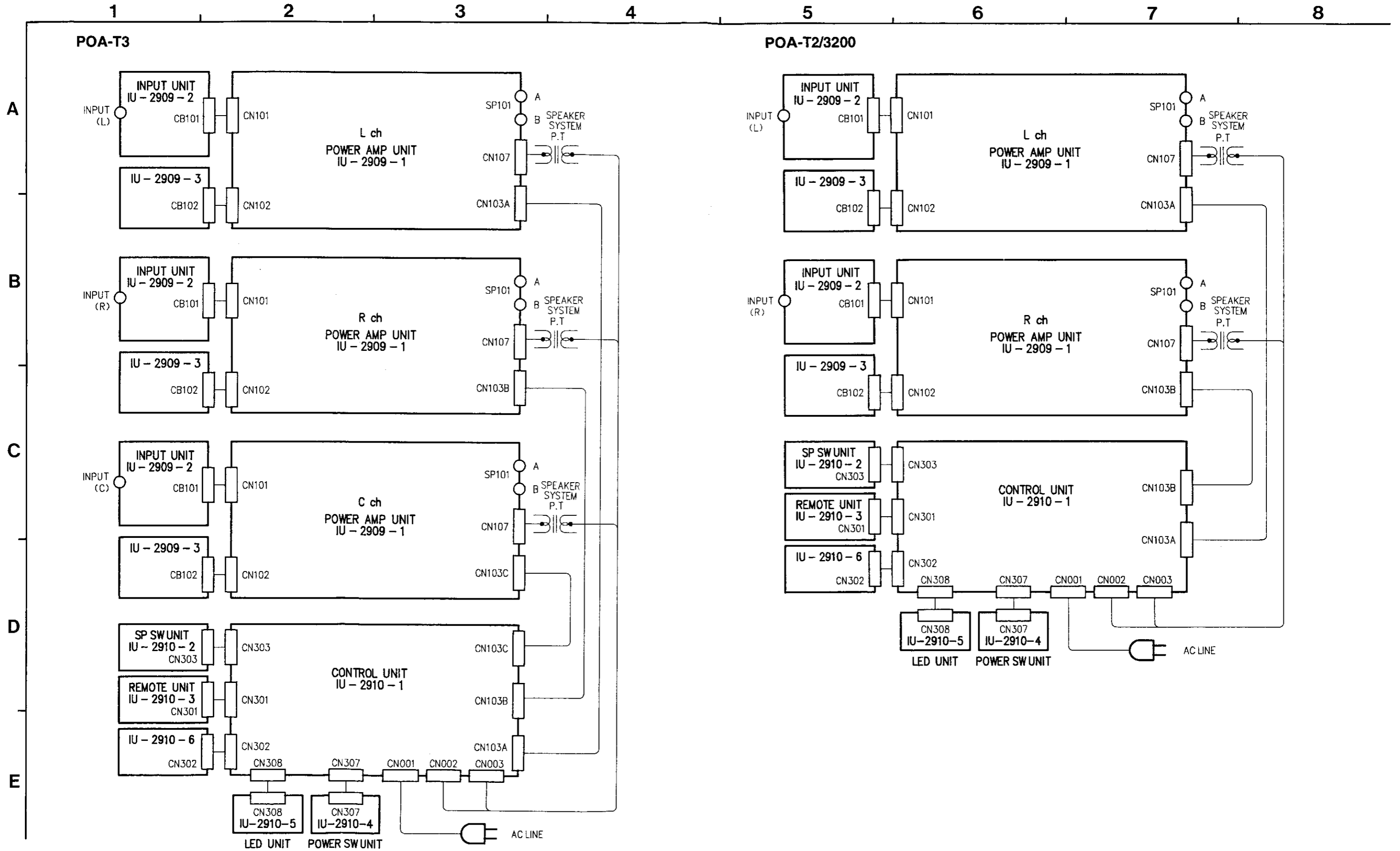



6 7 8 9 10 11

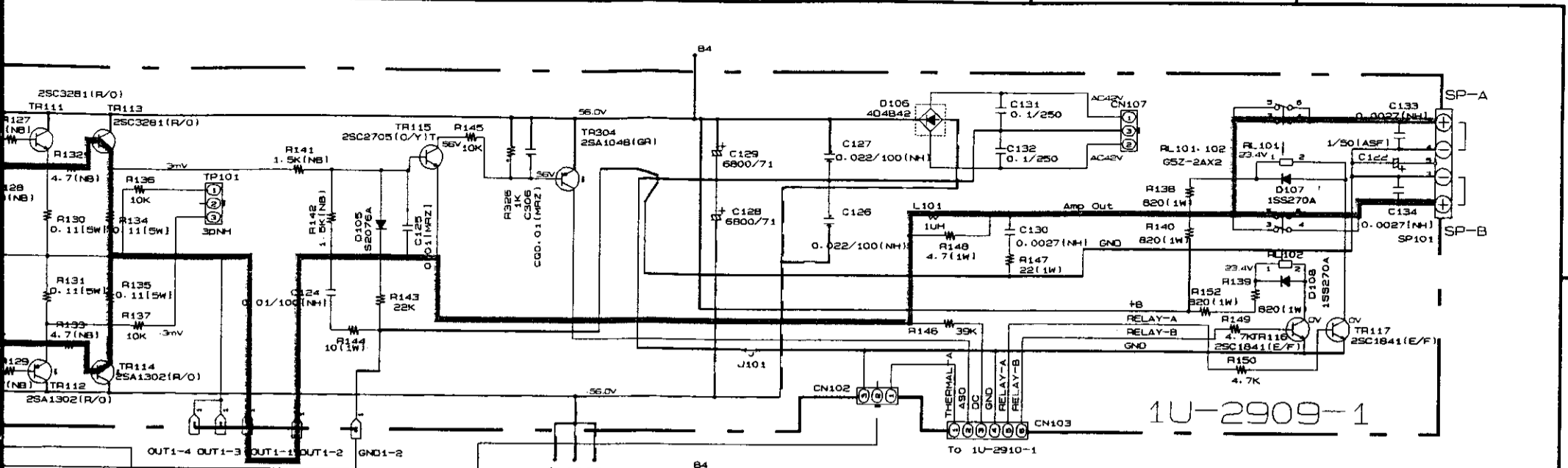

1U-2909-1

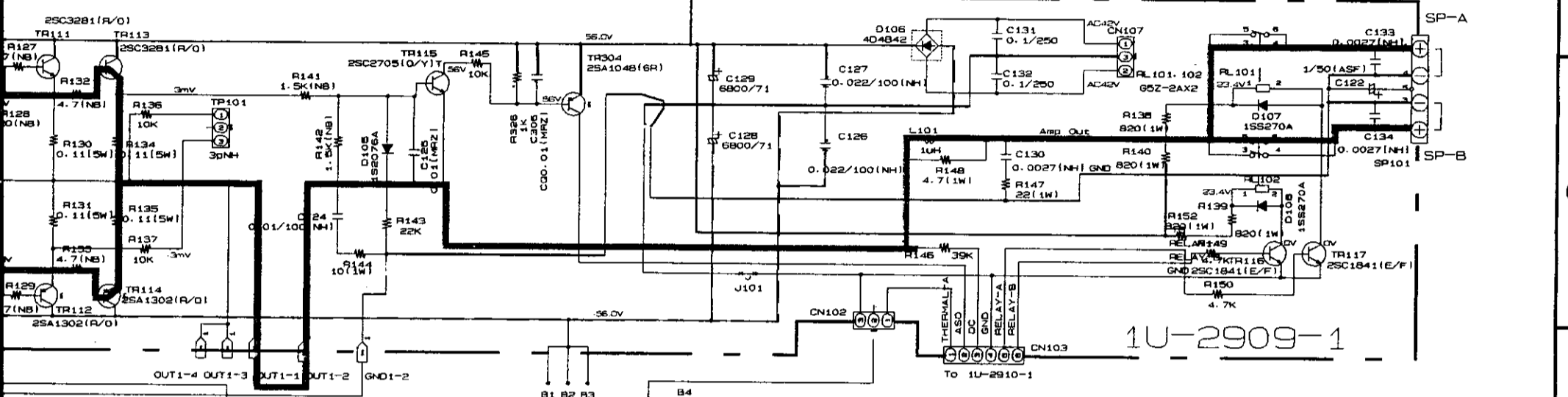

1U-2909-1

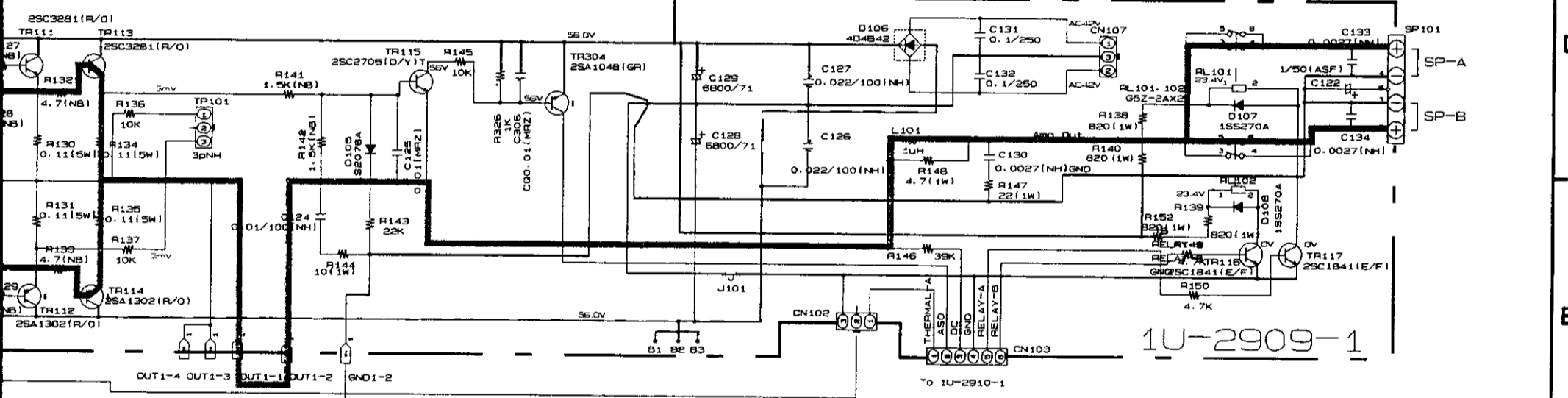

1U-2909-1

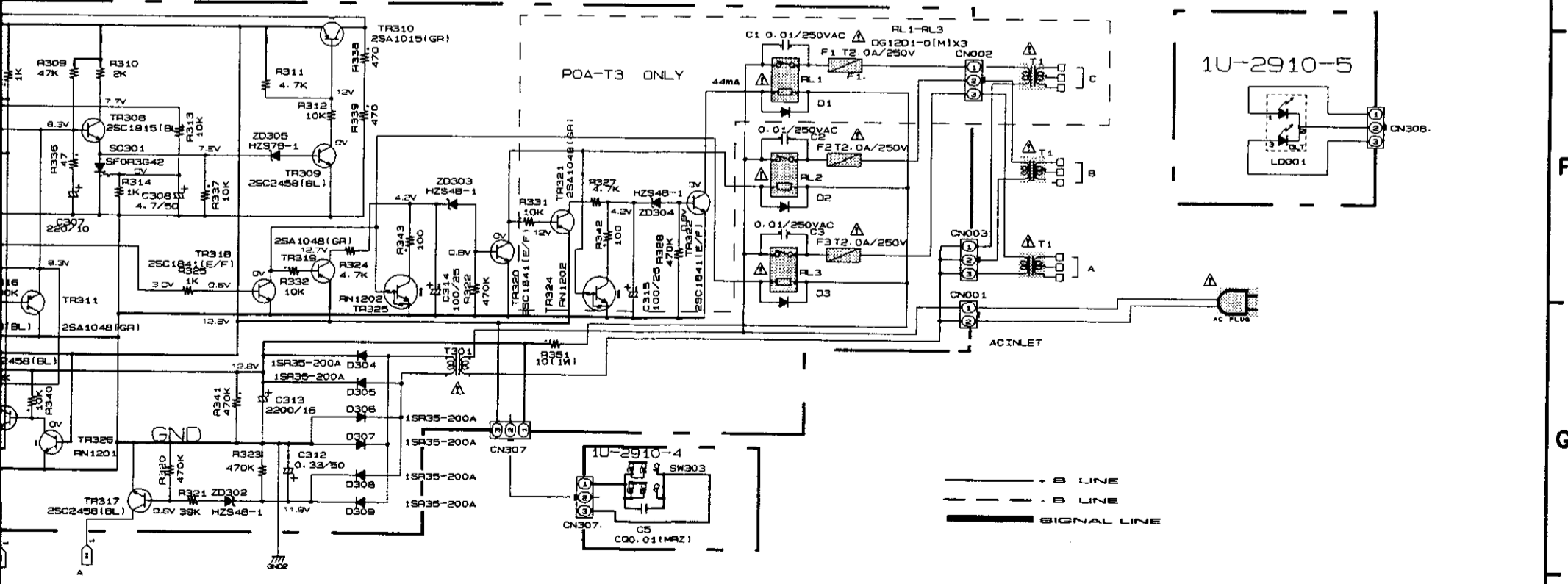

1U-2910-5

**NOTES**  
 ALL RESISTANCE VALUES IN OHM. K=1,000 OHM, M=1,000,000 OHM  
 ALL CAPACITANCE VALUES IN MICRO FARAD. P=MICRO-MICRO FARAD  
 EACH VOLTAGE AND CURRENT ARE MEASURED AT NO SIGNAL INPUT CONDITION.  
 CIRCUIT AND PARTS ARE SUBJECT TO CHANGE WITHOUT PRIOR NOTICE.

**WARNING:**  
 Parts marked with this symbol have critical characteristics. Use ONLY replacement parts recommended by the manufacturer.

**CAUTION:**  
 Before returning the unit to the customer, make sure you make either (1) a leakage current check or (2) a line to chassis resistance check. If the leakage current exceeds 0.5 millamps, or if the resistance from chassis to either side of the power cord is less than 240 kohms, the unit is defective.

**WARNING:**  
 DO NOT return the unit to the customer until the problem is located and corrected.