

DENON

Hi-Fi Component Amplifier

SERVICE MANUAL MODEL POA-3000

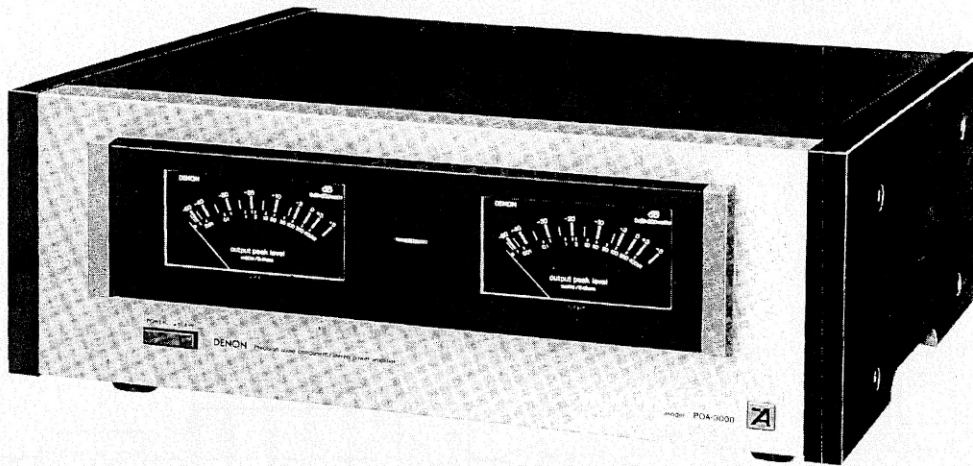

CONTENTS

SPECIFICATIONS	1
BLOCK DIAGRAM	1
METHODE OF ADJUSTMENT	2
EXPLODED VIEW OF CHASSIS AND CABINET	3
EXPLODED VIEW OF PARTS LIST	4
PRINTED CIRCUIT BOARD PATTERNS AND PARTS LIST	
RADIATOR UNIT ETC-359	5,6
POWER DRIVE (L) UNIT PUX-025	7 ~ 10
RECT UNIT ETC-361	10
POWER DRIVE (R) UNIT ETC-026	11 ~ 14
PROTECT UNIT ETC-358B	14
POWER SUPPLY UNIT SUX-024B	15,16
WIRING DIAGRAM	18,19

NIPPON COLUMBIA CO., LTD.

SPECIFICATIONS

MUSIC POWER

(with 8 ohm load): 250 W + 250 W
 Rated Output (sinusoidal output, 8 ohm load): 180 W + 180 W, 20 Hz ~ 20 kHz
 Total Harmonic Distortion Factor: 0.002% Max., 20 Hz ~ 10 kHz
 0.003% Max., 20 Hz ~ 20 kHz

180 Watts per channel at 8 ohms from 20 Hz to 20 kHz with no more than 0.005 % total harmonic distortion.
 — This specification is U.S.A. only —

Mixed-modulation

Distortion Factor: 0.003% Max., at 180 W rated output or equivalent with 4/1 = 60 Hz / 7 kHz

Power Bandwidth (Both-channel drive, IHF):

5 Hz ~ 100 kHz (THD of 0.02%)

Input Sensitivity/Input Impedance:

1 V / 50 k ohm

Output Impedance/

Damping Factor: 0.04 ohm / 200 1 kHz

S/N Ratio: 122 dB Min. (IHF "A")

SPEAKER TERMINALS: One system; 8 ohms for optimum load impedance

Transmission

Characteristic: 1 Hz ~ 350 kHz ± 0 dB

Subsonic Filter

Characteristic: 16 Hz · 6 dB/OCT

Separation: 100 dB Min. for 20 Hz ~ 10 kHz

85 dB Min. for 20 Hz ~ 20 kHz

LEVEL METER CHARACTERISTIC:

Type of Indication: Output level peak indication

Indicating Range: 0 dB = 200 W/8 ohm, -50 dB ~ +5 dB

Frequency Characteristic: ± 3 dB, 10 Hz ~ 100 kHz

OTHERS:

Power Requirements: Germany and France : AC 220 V, 50 Hz
 U.S.A. : AC 120 V, 60 Hz

Power Consumption: 1,300 W (at maximum output) (IEC)
 570 W (U.S.A.) (UL)

Cabinet Dimensions

(inc. feet): 495 mm(W) x 188 mm(H) x 495 mm(D)

Weight: 34 kg

Specifications are subject to change without notice for further improvement.

NOTE: The following codes correspond to the appropriate model.
 E2 for Europe, E3 for U.S.A..

BLOCK DIAGRAM

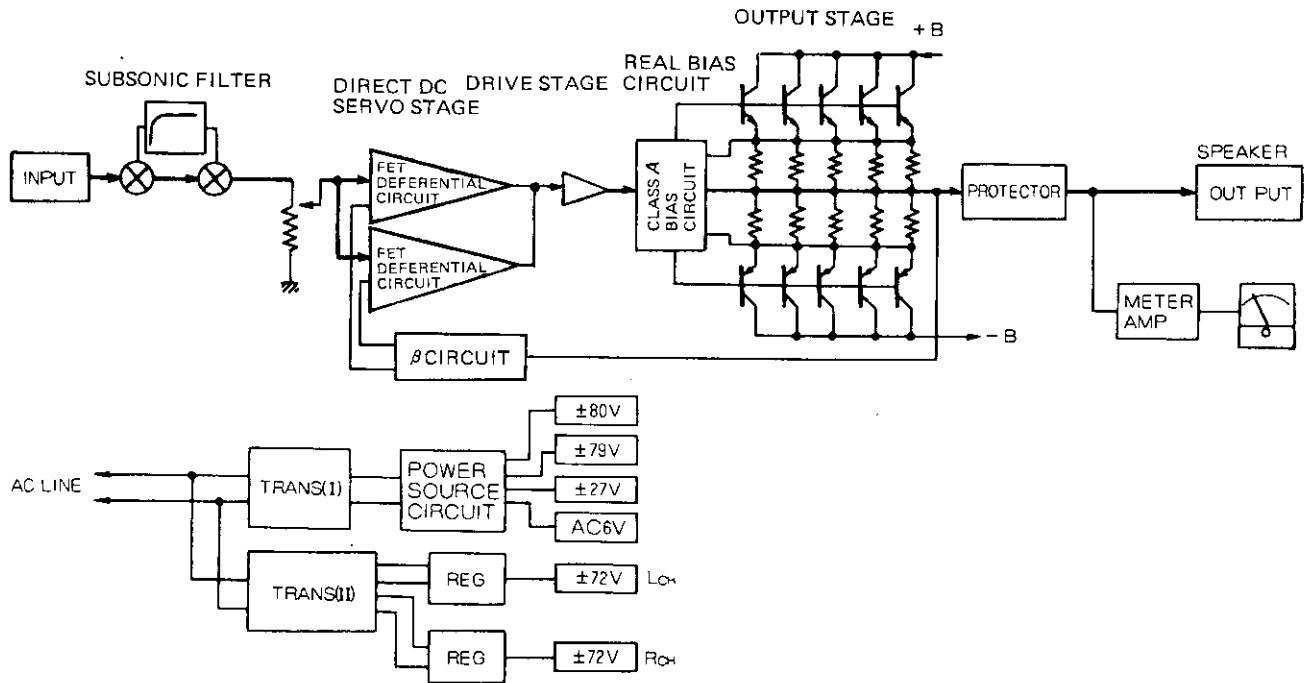

METHOD OF ADJUSTMENT

ADJ. POINT

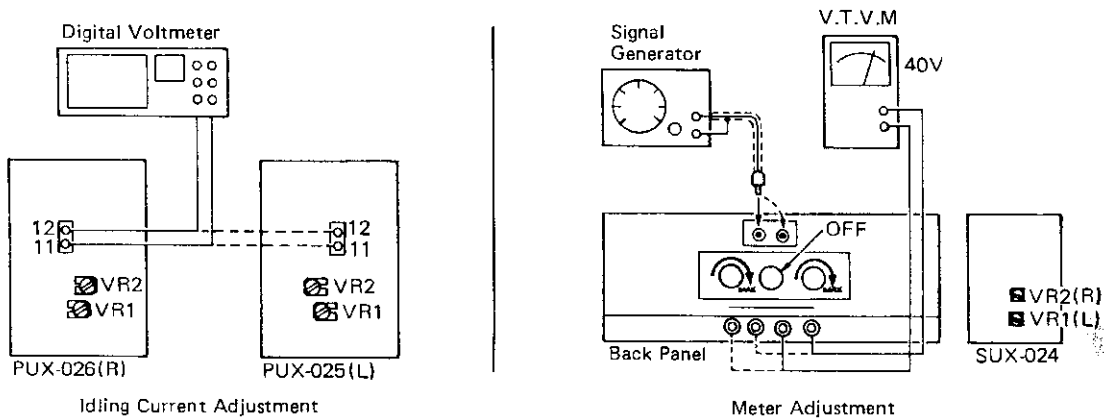

● **Precaution**

Never measure * points in the schematic drawing, or Transistors on ETC-0359-3, 4 P.C.B can be damaged.

ADJUSTMENT

● **Instrument Setting**

1. Set each Switch as per,

Front Panel

Power Switch → OFF

Back Panel

Sub-sonic Switch → OFF

L.Rch Input Level → MIN

2. Connect Digital Voltmeter to 11 and 12 terminals of PUX-025 (L Power drive P.C.B) and PUX-026 (R Power drive P.C.B).

● **Idling Current Adjustment**

1. Turn Power Switch ON. After 3 minutes warming up, adjust both L, Rch so as the digital voltmeter indicates $180 \begin{smallmatrix} +20 \\ -0 \end{smallmatrix}$ mV.
2. Adjust VR2 on PUX-025 (L Power Drive P.C.B) so as the digital voltmeter shows 180 mV.
3. Adjust VR1 so as the digital voltmeter indicates minimum.
4. Adjust VR2 so as the digital voltmeter indicates approximately 180 mV.
5. Adjust VR1 so as the digital voltmeter indicates minimum.
6. Adjust VR2 digital voltmeter shows $180 \begin{smallmatrix} +20 \\ -0 \end{smallmatrix}$ mV.
7. Repeat the same adjustment with PUX-026 (R Power Drive P.C.B).

● **Neutral Point Adjustment**

1. Connect digital voltmeter to Lch speaker terminals.
2. See to it that the digital voltmeter indicates less than 50 mV.
3. Connect digital voltmeter to Rch.
4. See to it that the digital voltmeter indicates less than 50 mV.

● **How to Adjust Meter**

1. Adjust 0 setting knob on Front chassis meter so as the pointer centers on the point, on both L, Rch. The adjustment must be done with Power Switch ON, and Input Level minimum.
2. Connect Signal Generator to L, Rch Input terminals on back panel.
3. Connect digital voltmeter to Lch (or Rch) speaker terminals. Put the speaker terminal no load.
4. Set L, Rch Input Level on back panel MAX.
5. Adjust signal generator attenuator so as V.T.V.M indicates 40 V. (Set the attenuator to 0 dB)
6. Then, adjust Lch VR1 on SUX-024 (Power Supply P.C.B), and Rch VR2 so as the meter indicates 0 dB.
7. Set attenuator to -10 dB and see to it the meter indicates -10 ± 1.5 dB on both L, Rch.
8. Set attenuator to -20 dB and see to it the meter indicates -20 ± 3 dB on both L, Rch.
9. Set attenuator to -30 dB and see to it the meter indicates -30 ± 3 dB on both L, Rch.
10. Set attenuator to -40 dB and see to it the meter indicates -40 ± 3 dB on both L, Rch.

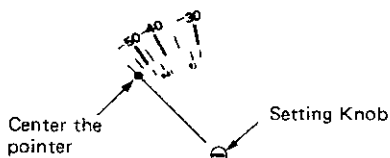

Fig. 1

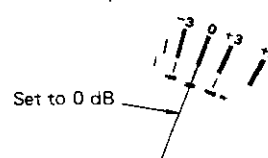

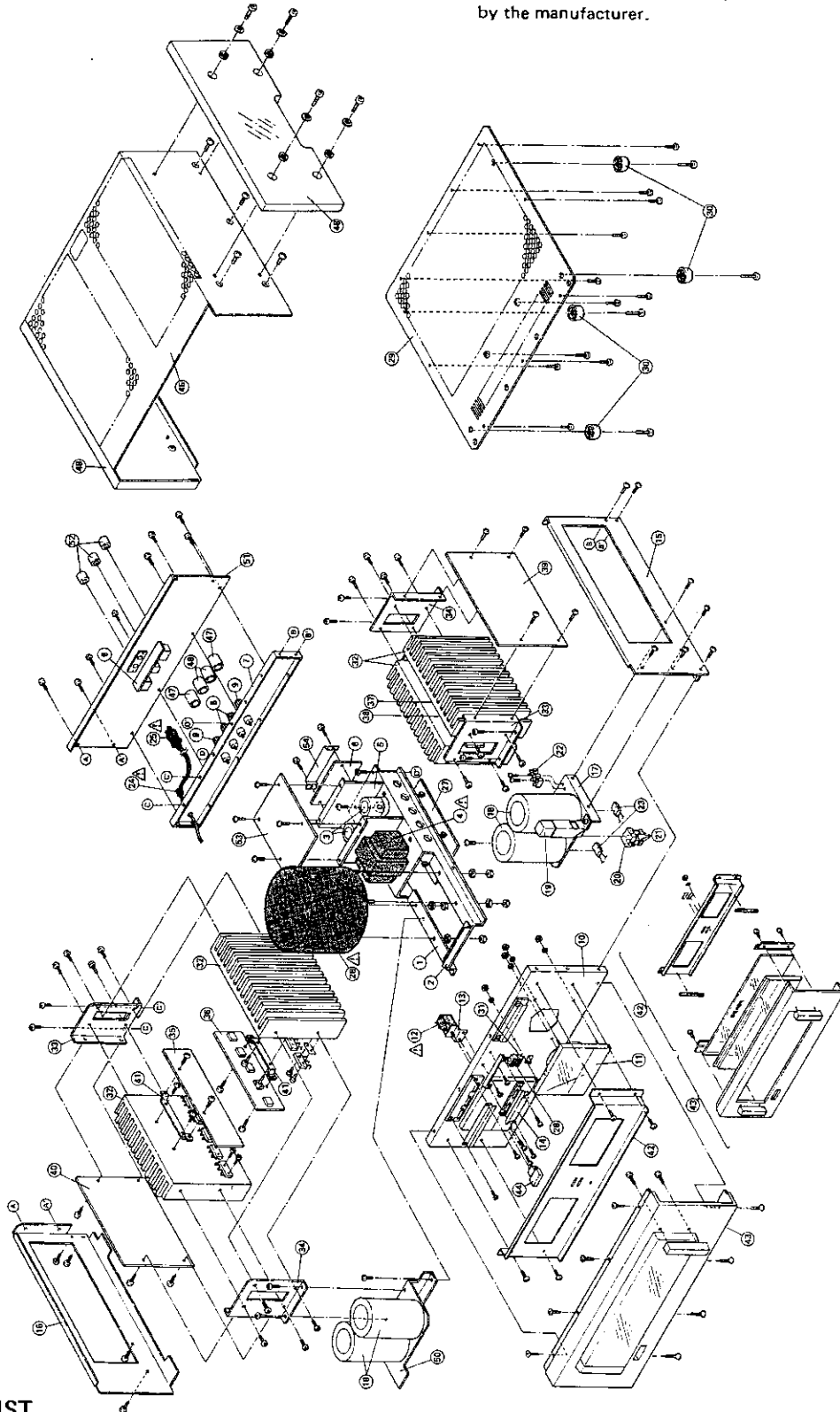







Fig. 2

EXPLODED VIEW OF CHASSIS AND CABINET

 Means important safety item, which must be replaced, when necessary, by a part specified or meeting the specification by the manufacturer.



ADDENDUM LIST

Ref. No.	Part Name & Descriptions	E3 for U.S.A.			
 4	POWER TRANS	2335253009			
 25	AC CORD	2062021009			
 26	POWER TRANS	2335254008			
 12	PUSH SWITCH	2124049097			
 27	METALIZED CAPACITOR	2568005721			
	PROTECT UNIT	ETC0358C			
	PACKING & ACCESSORIES				
	FUSE 15A	2061017030			
	FUSE 1.6A SPARE PARTS	2061023024			

EXPLODED VIEW OF PARTS LIST

Note: See addendum list below for the Parts with asterisk (*) on the Ref. No. and the other Part not included in this list.

Ref. No.	Part No.	Part Name & Descriptions
1	4120605200	TRANS CHASSIS
2	4120606005	BRACKET
	4730354035	TAPPING SCREW (2) 3x8
3		METALIZED CAPACITOR
	MD-5271	P.C.B SUPPORT
	2050088009	4P TERMINAL
	EP-4772	CORD HOLDER
*4	2335251001	POWER TRANS.
	4730454032	TAPPING SCREW (2) 4x8
5	4120607208	BOARD BRACKET
	2546042009	CHEMICON 470µF 160WV
6	ETC-03611	RECT UNIT
54	4140200009	SHIELD COVER
	4150164009	SPACER
	2710121002	TRANSISTOR 2SA968(Y)LB104A
	2730224002	TRANSISTOR 2SC2238(Y)LB104A
	4150137007	INSULATING WASHER
	4150052001	INSULATING SHEET
	4700012006	CROSS PAN SCREW WITH S. WASHER 3x12
	4751003006	3 WASHER
	4756006008	3 NUT
	ETC03612	RECT UNIT
7	4120608100	BRACKET FRAME
	2050115008	1P TERMINAL
	2050115011	1P TERMINAL
	4752005003	5 SPRING WASHER
	5130446005	BLIND SHEET
10	4120609109	FRONT CHASSIS
11	2150044105	METER ASS
	4752003005	3 SPRING WASHER
	1430147008	FILTER
*12	2124049055	PUSH SWITCH
13	4120525115	SWITCH BRACKET
	4711303018	CROSS PAN SCREW 3x6
*14	2518001007	OIL CAPACITOR 0.01µF 450WV
	4410314007	LAMP BRACKET
	ETC03613	LAMP UNIT
	ETC03614	LAMP UNIT
14	4140191008	REFLECTOR
	2034105089	3P CONNECTOR CORD
15	4120610101	SIDE CHASSIS (R)
16	4120611003	SIDE CHASSIS (L)
17	4120612019	CHEMICON BRACKET (R)
18	2546043008	CHEMICON 25000µF 80WV
	4752004004	4 SPRING WASHER
	4756008006	4 NUT
	2050010006	5T LUG
	2034142013	3P CONNECTOR CORD
	2030205006	CONTACT ASS
	2030205019	CONTACT ASS
	-	TOOTH WASHER φ5
	-	5x10 BOLT
	EP-5868	4T LUG
	4730353036	TAPPING SCREW (2) 3x6
19	2432025017	WIRE WOUND RESISTOR 2.7 OHM
	2032080009	2P CONNECTOR CORD
	2050116104	EARTH PLATE
20	2760257007	DIODE 15D4B41
	4730359014	TAPPING SCREW (2) 3x16
21	2561017019	METALIZED CAPACITOR 0.01µF 630WV
22	2050086014	3P TERMINAL BLOCK
23	2561019004	METALIZED CAPACITOR 1µF 100WV
50	4120613001	CHEMICON BRACKET (L)
	4700026018	TAPPING SCREW (2) 3x8
*24	4450020005	CORD PLUG
*25	2062016001	AC CORD
*26	2335252000	POWER TRANS.
	4752006002	6 SPRING WASHER
	4756012005	6 NUT

Ref. No.	Part No.	Part Name & Descriptions
*27	ETC03588	PROTECT UNIT
28	3930032035	PILOT LAMP 6.3V 0.15A
	1050291101	BOTTOM COVER
	4770064107	FIXING SCREW
30	1040027107	FOOT
	4730460013	TAPPING SCREW (2) 4x20
31	3930044007	PILOT LAMP 6.3V 0.05A
53	SUX-0024B	POWER SUPPLY UNIT
	-	4 WASHER
32	4170113001	POWER RADIATOR
	4410315103	PCB BRACKET
	2710137009	TRANSISTOR 2SA1095(Y)/(O)LB
	2730238001	TRANSISTOR 2SC2565(Y)/(O)LB
	ETC0359	RADIATOR UNIT
	4730354035	TAPPING SCREW (2) 3x8 BLACK
	2050114009	COMMON PLATE
33	4120614000	RADIATOR BRACKET (L)
34	4120615203	RADIATOR BRACKET (R)
40	PUX0025	POWER DRIVE (L) UNIT
	4170113001	POWER RADIATOR
41	4410315103	PCB BRACKET
39	PUX0026	POWER DRIVE (R) UNIT
*51	1050292207	BACK PANEL
	4753001051	3 TOOTH WASHER
	2032037010	2P PIN JACK
	SC-10822	NUT
	2050003000	3T LUG
	2554081007	PLASTIC FILM CAPACITOR 0.047µF 100WV
	ETC03615	VR SWITCH UNIT
	-	8 WASHER
	-	8 NUT
	-	7 TOOTH WASHER
	-	7 NUT
42	1440576106	INSIDE PANEL
	1430148007	FILTER
	1430148023	FILTER
	4610136001	RUBBER SHEET
	4610094088	RUBBER SHEET
	4410318003	SPACER
	4610123001	LED HOLDER
	2034136003	3P CONNECTOR ASS
	3939032007	LED TLR206
43	1440566200	FRONT PANEL
	4610074192	BLIND
	1430145204	WINDOW GLASS
	1440567102	ESC BAR
	4120627000	BRACKET (A)
	4120628009	BRACKET (B)
	1140046101	KNOB GUIDE
	1350035009	MARK
	1220069008	SPACER
	4610135002	BLIND
	1430150008	INDOOR WINDOW
	4610066184	RUBBER SHEET
44	1130173107	PUSH KNOB ASS
52	1120270007	KNOB
	1220007073	SPACER
	5130454000	CAUTION SHEET
	1020091108	TOP COVER
	4610061163	RUBBER SHEET
	1220007015	SPACER
8	4620036007	TERMINAL CAP (BLACK)
9	4620036010	TERMINAL CAP (RED)
48	1010620204	WOOD BOARD (R)
49	1010621009	WOOD BOARD (L)
	4751006016	5 WASHER
	4711509032	CROSS PAN SCREW 5x16

Ref. No.	Part No.	Part Name & Descriptions
PACKING & ACCESSORIES		
	5040055007	CABINET SHEET
	5030209106	CUSHION
	5030210108	CUSHION
	5010486059	CARTON CASE

Ref. No.	Part No.	Part Name & Descriptions
	PC-3244	ENVELOPE
	2061017027	FUSE 8A
	2061025022	FUSE 0.8A (TIME LAG TYPE)
	5050034018	POLY COVER

PRINTED CIRCUIT BOARD PATTERNS AND PARTS LIST
ETC-359 RADIATOR UNIT

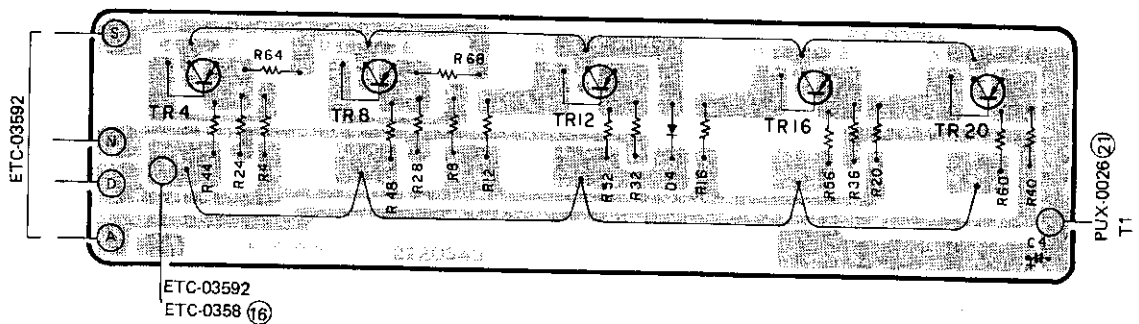
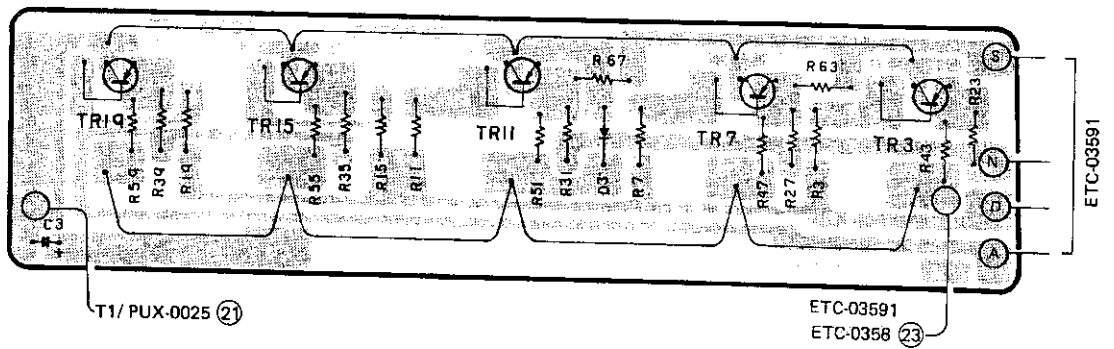
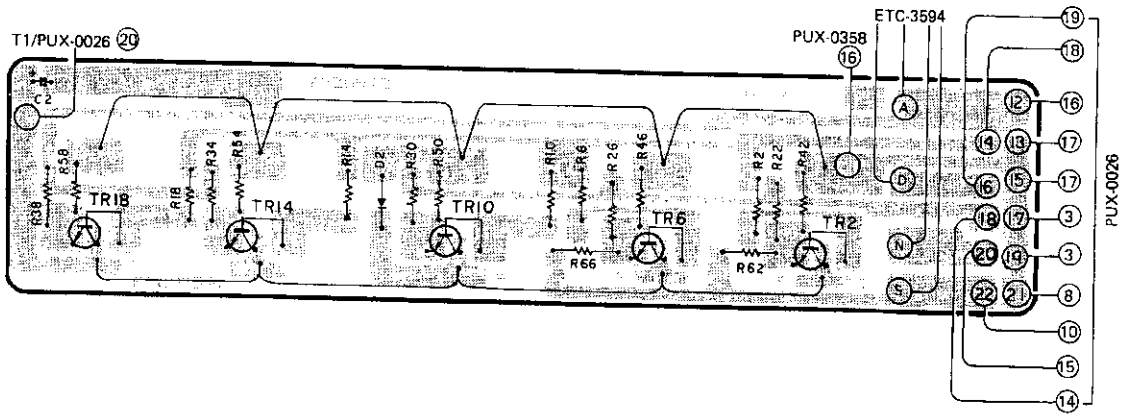
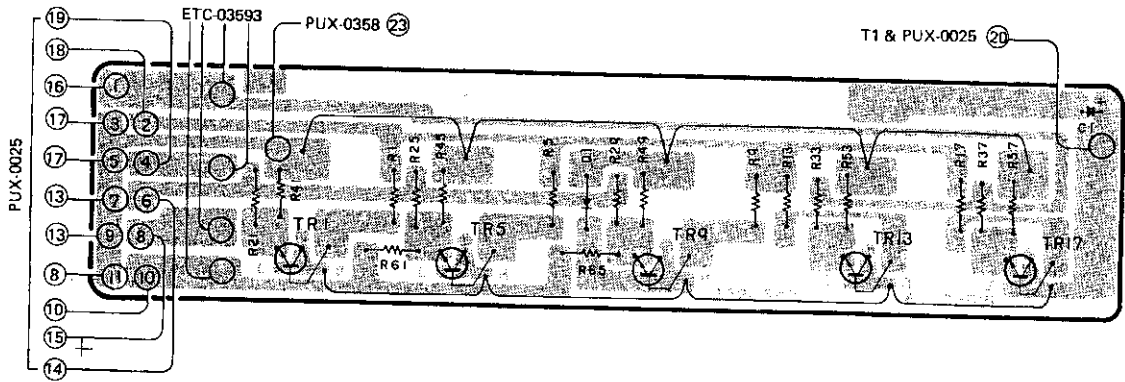

ETC-359 PARTS LIST

Ref. No.	Part No.	Part Name & Descriptions	
SEMICONDUCTORS			
D01	2760184002	1S1834	DIODE
D02	2760184002	1S1834	DIODE
D03	2760184002	1S1834	DIODE
D04	2760184002	1S1834	DIODE
RESISTORS			
R01	2442020002	10 ohm ±5% 1/4W	METAL OXIDE FILM
R02	2442020002	10 ohm ±5% 1/4W	METAL OXIDE FILM
R03	2442020002	10 ohm ±5% 1/4W	METAL OXIDE FILM
R04	2442020002	10 ohm ±5% 1/4W	METAL OXIDE FILM
R05	2442020002	10 ohm ±5% 1/4W	METAL OXIDE FILM
R06	2442020002	10 ohm ±5% 1/4W	METAL OXIDE FILM
R07	2442020002	10 ohm ±5% 1/4W	METAL OXIDE FILM
R08	2442020002	10 ohm ±5% 1/4W	METAL OXIDE FILM
R09	2442020002	10 ohm ±5% 1/4W	METAL OXIDE FILM
R10	2442020002	10 ohm ±5% 1/4W	METAL OXIDE FILM
R11	2442020002	10 ohm ±5% 1/4W	METAL OXIDE FILM
R12	2442020002	10 ohm ±5% 1/4W	METAL OXIDE FILM
R13	2442020002	10 ohm ±5% 1/4W	METAL OXIDE FILM
R14	2442020002	10 ohm ±5% 1/4W	METAL OXIDE FILM
R15	2442020002	10 ohm ±5% 1/4W	METAL OXIDE FILM
R16	2442020002	10 ohm ±5% 1/4W	METAL OXIDE FILM
R17	2442020002	10 ohm ±5% 1/4W	METAL OXIDE FILM
R18	2442020002	10 ohm ±5% 1/4W	METAL OXIDE FILM
R19	2442020002	10 ohm ±5% 1/4W	METAL OXIDE FILM
R20	2442020002	10 ohm ±5% 1/4W	METAL OXIDE FILM
R21	2442022000	1 kohm ±5% 1/4W	METAL OXIDE FILM
R22	2442022000	1 kohm ±5% 1/4W	METAL OXIDE FILM
R23	2442022000	1 kohm ±5% 1/4W	METAL OXIDE FILM
R24	2442022000	1 kohm ±5% 1/4W	METAL OXIDE FILM
R25	2442022000	1 kohm ±5% 1/4W	METAL OXIDE FILM
R26	2442022000	1 kohm ±5% 1/4W	METAL OXIDE FILM
R27	2442022000	1 kohm ±5% 1/4W	METAL OXIDE FILM
R28	2442022000	1 kohm ±5% 1/4W	METAL OXIDE FILM
R29	2442022000	1 kohm ±5% 1/4W	METAL OXIDE FILM
R30	2442022000	1 kohm ±5% 1/4W	METAL OXIDE FILM
R31	2442022000	1 kohm ±5% 1/4W	METAL OXIDE FILM
R32	2442022000	1 kohm ±5% 1/4W	METAL OXIDE FILM
R33	2442022000	1 kohm ±5% 1/4W	METAL OXIDE FILM
R34	2442022000	1 kohm ±5% 1/4W	METAL OXIDE FILM
R35	2442022000	1 kohm ±5% 1/4W	METAL OXIDE FILM
R36	2442022000	1 kohm ±5% 1/4W	METAL OXIDE FILM
R37	2442022000	1 kohm ±5% 1/4W	METAL OXIDE FILM
R38	2442022000	1 kohm ±5% 1/4W	METAL OXIDE FILM

Ref. No.	Part No.	Part Name & Descriptions	
R39	2442022000	1 kohm ±5% 1/4W	METAL OXIDE FILM
R40	2442022000	1 kohm ±5% 1/4W	METAL OXIDE FILM
R41	2432027002	1 ohm ±5% 3.15W	WIRE WOUND
R42	2432027002	1 ohm ±5% 3.15W	WIRE WOUND
R43	2432027002	1 ohm ±5% 3.15W	WIRE WOUND
R44	2432027002	1 ohm ±5% 3.15W	WIRE WOUND
R45	2432027002	1 ohm ±5% 3.15W	WIRE WOUND
R46	2432027002	1 ohm ±5% 3.15W	WIRE WOUND
R47	2432027002	1 ohm ±5% 3.15W	WIRE WOUND
R48	2432027002	1 ohm ±5% 3.15W	WIRE WOUND
R49	2432027002	1 ohm ±5% 3.15W	WIRE WOUND
R50	2432027002	1 ohm ±5% 3.15W	WIRE WOUND
R51	2432027002	1 ohm ±5% 3.15W	WIRE WOUND
R52	2432027002	1 ohm ±5% 3.15W	WIRE WOUND
R53	2432027002	1 ohm ±5% 3.15W	WIRE WOUND
R54	2432027002	1 ohm ±5% 3.15W	WIRE WOUND
R55	2432027002	1 ohm ±5% 3.15W	WIRE WOUND
R56	2432027002	1 ohm ±5% 3.15W	WIRE WOUND
R57	2432027002	1 ohm ±5% 3.15W	WIRE WOUND
R58	2432027002	1 ohm ±5% 3.15W	WIRE WOUND
R59	2432027002	1 ohm ±5% 3.15W	WIRE WOUND
R60	2432027002	1 ohm ±5% 3.15W	WIRE WOUND
R61	2442007038	100 ohm ±5% 1/4W	METAL OXIDE FILM
R62	2442007038	100 ohm ±5% 1/4W	METAL OXIDE FILM
R63	2442007038	100 ohm ±5% 1/4W	METAL OXIDE FILM
R64	2442007038	100 ohm ±5% 1/4W	METAL OXIDE FILM
R65	2442007038	100 ohm ±5% 1/4W	METAL OXIDE FILM
R66	2442007038	100 ohm ±5% 1/4W	METAL OXIDE FILM
R67	2442007038	100 ohm ±5% 1/4W	METAL OXIDE FILM
R68	2442007038	100 ohm ±5% 1/4W	METAL OXIDE FILM
CAPACITORS			
C01	2544060025	1μF	100V ELECTROLYTIC
C02	2544060025	1μF	100V ELECTROLYTIC
C03	2544060025	1μF	100V ELECTROLYTIC
C04	2544060025	1μF	100V ELECTROLYTIC
OTHER PARTS			
	2220543002	P.W. BOARD	
	EP-5667H1	TERMINAL FOR WRAPPING PIN USED 8	
	2036080005	4P CONNECTOR CORD	
	2034134005	3P CONNECTOR CORD	
	2034135004	3P CONNECTOR CORD	

PUX-025 POWER DRIVE (L) UNIT

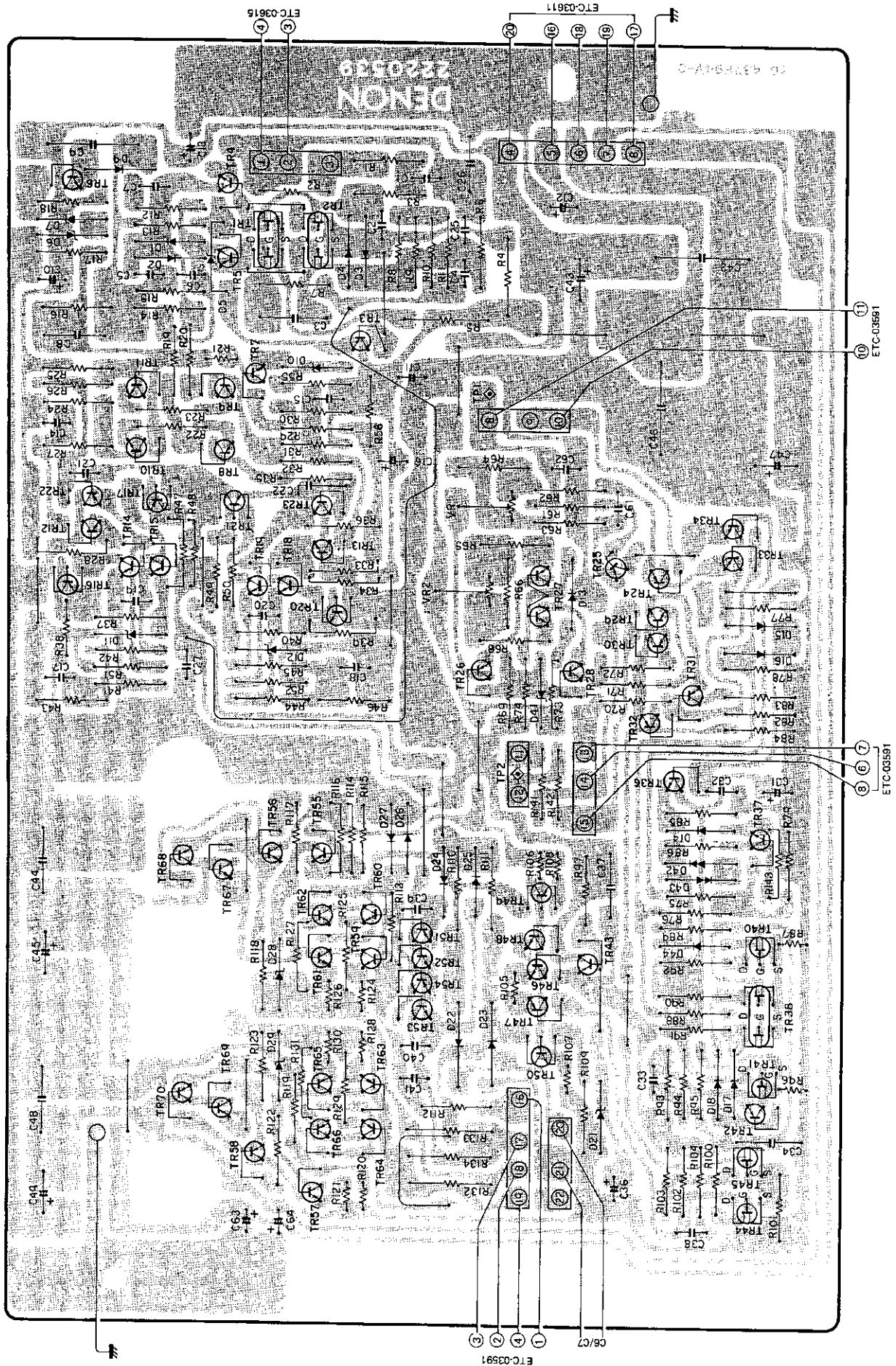

PUX-025 PARTS LIST

Ref. No.	Part No.	Part Name & Descriptions
SEMICONDUCTORS		
TR01	2750022006	2SK129A(M) FIELD EFFECT TRANSISTOR
TR02	2750022006	2SK129A(M) FIELD EFFECT TRANSISTOR
TR03	2710094016	2SA970(BL) TRANSISTOR
TR04	2730198002	2SC1815(Y) TRANSISTOR
TR05	2730198002	2SC1815(Y) TRANSISTOR
TR06	2730177007	2SC1626(Y) TRANSISTOR
TR07	2730205005	2SC1941(L) TRANSISTOR
TR08	2710094016	2SA970(BL) TRANSISTOR
TR09	2710094016	2SA970(BL) TRANSISTOR
TR10	2730187013	2SC2240(BL) TRANSISTOR
TR11	2730187013	2SC2240(BL) TRANSISTOR
TR12	2710094016	2SA970(BL) TRANSISTOR
TR13	2730187013	2SC2240(BL) TRANSISTOR
TR14	2710102005	2SA1015(Y) TRANSISTOR
TR15	2710102005	2SA1015(Y) TRANSISTOR
TR16	2710114006	2SA964A(Q) TRANSISTOR
TR17	2710114006	2SA964A(Q) TRANSISTOR
TR18	2730198002	2SC1815(Y) TRANSISTOR
TR19	2730198002	2SC1815(Y) TRANSISTOR
TR20	2730210003	2SC2224A(Q) TRANSISTOR
TR21	2730210003	2SC2224A(Q) TRANSISTOR
TR22	2710094016	2SA970(BL) TRANSISTOR
TR23	2730187013	2SC2240(BL) TRANSISTOR
TR24	2710102005	2SA1015(Y) TRANSISTOR
TR25	2710102005	2SA1015(Y) TRANSISTOR
TR26	2710110000	2SA916(L) TRANSISTOR
TR27	2710115005	2SA995(G) TRANSISTOR
TR28	2710110000	2SA916(L) TRANSISTOR
TR29	2710102005	2SA1015(Y) TRANSISTOR
TR30	2710102005	2SA1015(Y) TRANSISTOR
TR31	2710094016	2SA970(BL) TRANSISTOR
TR32	2710094016	2SA970(BL) TRANSISTOR
TR33	2710094016	2SA970(BL) TRANSISTOR
TR34	2710094016	2SA970(BL) TRANSISTOR
TR36	2730198002	2SC1815(Y) TRANSISTOR
TR37	2730198002	2SC1815(Y) TRANSISTOR
TR38	2750022006	2SK129A(M) FIELD EFFECT TRANSISTOR
TR40	2750020008	2SK163(M) FIELD EFFECT TRANSISTOR
TR41	2750020008	2SK163(M) FIELD EFFECT TRANSISTOR
TR42	2710102005	2SA1015(Y) TRANSISTOR
TR43	2730186001	2SC1940(L) TRANSISTOR
TR44	2750020008	2SK163(M) FIELD EFFECT TRANSISTOR
TR45	2750020008	2SK163(M) FIELD EFFECT TRANSISTOR
TR46	2730198002	2SC1815(Y) TRANSISTOR
TR47	2710102005	2SA1015(Y) TRANSISTOR
TR48	2730186001	2SC1940(L) TRANSISTOR
TR49	2710114006	2SA964A(Q) TRANSISTOR
TR50	2730210003	2SC2224A(Q) TRANSISTOR
TR51	2710102005	2SA1015(Y) TRANSISTOR
TR52	2730198002	2SC1815(Y) TRANSISTOR
TR53	2730198002	2SC1815(Y) TRANSISTOR
TR54	2710102005	2SA1015(Y) TRANSISTOR
TR55	2710094016	2SA970(BL) TRANSISTOR
TR56	2730187013	2SC2240(BL) TRANSISTOR
TR57	2730187013	2SC2240(BL) TRANSISTOR
TR58	2710094016	2SA970(BL) TRANSISTOR
TR59	2730198002	2SC1815(Y) TRANSISTOR
TR60	2730198002	2SC1815(Y) TRANSISTOR
TR61	2730198002	2SC1815(Y) TRANSISTOR
TR62	2730198002	2SC1815(Y) TRANSISTOR
TR63	2710102005	2SA1015(Y) TRANSISTOR
TR64	2710102005	2SA1015(Y) TRANSISTOR
TR65	2710102005	2SA1015(Y) TRANSISTOR

Ref. No.	Part No.	Part Name & Descriptions
TR66	2710102005	2SA1015(Y) TRANSISTOR
TR67	2730199001	2SC2238(Y) TRANSISTOR
TR68	2730199001	2SC2238(Y) TRANSISTOR
TR69	2710104003	2SA968(Y) TRANSISTOR
TR70	2710104003	2SA968(Y) TRANSISTOR
D01	2760049008	1S2076 DIODE
D02	2760049008	1S2076 DIODE
D03	2760049008	1S2076 DIODE
D04	2760049008	1S2076 DIODE
D05	2760254000	HZ7B-3 DIODE
D06	2760255009	HZ12C-3 DIODE
D07	2760255009	HZ12C-3 DIODE
D09	2760049011	1S2076A DIODE
D10	2760173039	HZ6-B2 DIODE
D11	2760256008	HZ16-2 DIODE
D12	2760256008	HZ16-2 DIODE
D13	2760049008	1S2076 DIODE
D14	2760049008	1S2076 DIODE
D15	2760049008	1S2076 DIODE
D16	2760049008	1S2076 DIODE
D17	2760049008	1S2076 DIODE
D18	2760049008	1S2076 DIODE
D21	2760221017	HZ36-2 DIODE
D22	2760184002	1S1834 DIODE
D23	2760184002	1S1834 DIODE
D24	2760049008	1S2076 DIODE
D25	2760049008	1S2076 DIODE
D26	2760049008	1S2076 DIODE
D27	2760049008	1S2076 DIODE
D28	2760256008	HZ16-2 DIODE
D29	2760256008	HZ16-2 DIODE
D41	2760254000	HZ7B-3 DIODE
D42	2760200009	MV-11 DIODE
D43	2760200009	MV-11 DIODE
D44	2760049008	1S2076 DIODE
D50	2760191008	W03C DIODE
RESISTORS		
R01	2410314009	1 kohm ±5% ¼W CARBON FILM
R02	2410378003	470 kohm ±5% ¼W CARBON FILM
R03	2410290000	100 ohm ±5% ¼W CARBON FILM
R04	2440054025	12 kohm ±5% 1W METAL OXIDE FILM
R05	2440054025	12 kohm ±5% 1W METAL OXIDE FILM
R06	2410302008	330 ohm ±5% ¼W CARBON FILM
R07	2420203003	10M ohm ±10% ¼W CARBON COMPOSIT
R08	2410340002	12 kohm ±5% ¼W CARBON FILM
R09	2410340002	12 kohm ±5% ¼W CARBON FILM
R10	2410340002	12 kohm ±5% ¼W CARBON FILM
R11	2410340002	12 kohm ±5% ¼W CARBON FILM
R12	2410276008	27 ohm ±5% ¼W CARBON FILM
R13	2410346006	22 kohm ±5% ¼W CARBON FILM
R14	2410322004	2.2 kohm ±5% ¼W CARBON FILM
R15	2410322004	2.2 kohm ±5% ¼W CARBON FILM
R16	2410336003	8.2 kohm ±5% ¼W CARBON FILM
R17	2410342000	15 kohm ±5% ¼W CARBON FILM
R18	2410358007	68 kohm ±5% ¼W CARBON FILM
R19	2410314009	1 kohm ±5% ¼W CARBON FILM
R20	2410314009	1 kohm ±5% ¼W CARBON FILM
R21	2412022085	47 kohm ±5% ¼W CARBON FILM
R22	2410300000	270 ohm ±5% ¼W CARBON FILM
R23	2410300000	270 ohm ±5% ¼W CARBON FILM
R24	2410327009	3.6 kohm ±5% ¼W CARBON FILM
R25	2410327009	3.6 kohm ±5% ¼W CARBON FILM
R26	2410314009	1 kohm ±5% ¼W CARBON FILM
R27	2410314009	1 kohm ±5% ¼W CARBON FILM
R28	2410354001	47 kohm ±5% ¼W CARBON FILM
R29	2410314009	1 kohm ±5% ¼W CARBON FILM

(Con.)

Ref. No.	Part No.	Part Name & Descriptions
R30	2410327009	3.6 kohm ±5% ¼W CARBON FILM
R31	2410327009	3.6 kohm ±5% ¼W CARBON FILM
R32	2410314009	1 kohm ±5% ¼W CARBON FILM
R33	2410369009	200 kohm ±5% ¼W CARBON FILM
R34	2410354001	47 kohm ±5% ¼W CARBON FILM
R35	2410314009	1 kohm ±5% ¼W CARBON FILM
R36	2410369009	200 kohm ±5% ¼W CARBON FILM
R37	2410336003	8.2 kohm ±5% ¼W CARBON FILM
R38	2410346006	22 kohm ±5% ¼W CARBON FILM
R39	2410346006	22 kohm ±5% ¼W CARBON FILM
R40	2410336003	8.2 kohm ±5% ¼W CARBON FILM
R41	2410278006	33 ohm ±5% ¼W CARBON FILM
R42	2410278006	33 ohm ±5% ¼W CARBON FILM
R43	2410171006	270 ohm ±5% ¼W CARBON FILM
R44	2410278006	33 ohm ±5% ¼W CARBON FILM
R45	2410278006	33 ohm ±5% ¼W CARBON FILM
R46	2410171006	270 ohm ±5% ¼W CARBON FILM
R47	2410348004	27 kohm ±5% ¼W CARBON FILM
R48	2410359006	75 kohm ±5% ¼W CARBON FILM
R49	2410359006	75 kohm ±5% ¼W CARBON FILM
R50	2410348004	27 kohm ±5% ¼W CARBON FILM
R51	2410330009	4.7 kohm ±5% ¼W CARBON FILM
R52	2410330009	4.7 kohm ±5% ¼W CARBON FILM
R55	2410306004	470 ohm ±5% ¼W CARBON FILM
R56	2410372009	270 kohm ±5% ¼W CARBON FILM
R61	2410284003	56 ohm ±5% ¼W CARBON FILM
R62	2410300000	270 ohm ±5% ¼W CARBON FILM
R63	2410300000	270 ohm ±5% ¼W CARBON FILM
R64	2410284003	56 ohm ±5% ¼W CARBON FILM
R65	2410312001	820 ohm ±5% ¼W CARBON FILM
R66	2410304006	390 ohm ±5% ¼W CARBON FILM
R68	2410312001	820 ohm ±5% ¼P CARBON FILM
R69	2410351004	36 kohm ±5% ¼W CARBON FILM
R70	2410338001	10 kohm ±5% ¼W CARBON FILM
R71	2410311002	750 ohm ±5% ¼W CARBON FILM
R72	2410311002	750 ohm ±5% ¼W CARBON FILM
R73	2410330009	4.7 kohm ±5% ¼W CARBON FILM
R74	2410358007	68 kohm ±5% ¼W CARBON FILM
R75	2410345007	20 kohm ±5% ¼W CARBON
R76	2410345007	20 kohm ±5% ¼W CARBON FILM
R77	2410326000	3.3 kohm ±5% ¼W CARBON FILM
R78	2410326000	3.3 kohm ±5% ¼W CARBON FILM
R79	2410765001	1M ohm ±5% ¼W CARBON FILM
R82	2410350005	33 kohm ±5% ¼W CARBON FILM
R83	2410326000	3.3 kohm ±5% ¼W CARBON FILM
R84	2410326000	3.3 kohm ±5% ¼W CARBON FILM
R85	2410330009	4.7 kohm ±5% ¼W CARBON FILM
R86	2410362006	100 kohm ±5% ¼W CARBON FILM
R87	2412020045	3.9 kohm ±5% ¼W CARBON FILM
R88	2410306004	470 ohm ±5% ¼W CARBON FILM
R89	2410306004	470 ohm ±5% ¼W CARBON FILM
R90	2410338001	10 kohm ±5% ¼W CARBON FILM
R91	2410338001	10 kohm ±5% ¼W CARBON FILM
R92	2410338001	10 kohm ±5% ¼W CARBON FILM
R93	2410338001	10 kohm ±5% ¼W CARBON FILM
R94	2410279005	36 ohm ±5% ¼W CARBON FILM
R95	2410290000	100 ohm ±5% ¼W CARBON FILM
R96	2412020090	10 kohm ±5% ¼W CARBON FILM
R97	2410342000	15 kohm ±5% ¼W CARBON FILM
R100	2410306004	470 ohm ±5% ¼W CARBON FILM
R101	2410328008	3.9 kohm ±5% ¼W CARBON FILM
R102	2410338001	10 kohm ±5% ¼W CARBON FILM
R103	2410338001	10 kohm ±5% ¼W CARBON FILM
R104	2410314009	1 kohm ±5% ¼W CARBON FILM
R105	2412028021	1.6 kohm ±5% ¼W CARBON FILM
R106	2412002021	330 ohm ±5% ¼W CARBON FILM
R107	2412002021	330 ohm ±5% ¼W CARBON FILM
R108	2412002005	220 ohm ±5% ¼W CARBON FILM

Ref. No.	Part No.	Part Name & Descriptions
R109	2410298002	220 ohm ±5% ¼W CARBON FILM
R110	2440090005	220 ohm ±5% 2W METAL OXIDE FILM
R111	2440090005	220 ohm ±5% 2W METAL OXIDE FILM
R112	2410314009	1 kohm ±5% ¼W CARBON FILM
R113	2410358007	68 kohm ±5% ¼W CARBON FILM
R114	2410319004	1.6 kohm ±5% ¼W CARBON FILM
R115	2410356009	56 kohm ±5% ¼W CARBON FILM
R116	2410314009	1 kohm ±5% ¼W CARBON FILM
R117	2410306004	470 ohm ±5% ¼W CARBON FILM
R118	2410332007	5.6 kohm ±5% ¼W CARBON FILM
R119	2410356009	56 kohm ±5% ¼W CARBON FILM
R120	2412028021	1.6 kohm ±5% ¼W CARBON FILM
R121	2412002089	1 kohm ±5% ¼W CARBON FILM
R122	2410306004	470 ohm ±5% ¼W CARBON FILM
R123	2410332007	5.6 kohm ±5% ¼W CARBON FILM
R124	2412000049	10 ohm ±5% ¼W CARBON FILM
R125	2410266005	10 ohm ±5% ¼W CARBON FILM
R126	2412000049	10 ohm ±5% ¼W CARBON FILM
R127	2410266005	10 ohm ±5% ¼W CARBON FILM
R128	2412000049	10 ohm ±5% ¼W CARBON FILM
R129	2410266005	10 ohm ±5% ¼W CARBON FILM
R130	2412000049	10 ohm ±5% ¼W CARBON FILM
R131	2410266005	10 ohm ±5% ¼W CARBON FILM
R132	2442021098	100 ohm ±5% ¼W METAL OXIDE FILM
R133	2440086006	100 ohm ±5% 2W METAL OXIDE FILM
R134	2440086006	100 ohm ±5% 2W METAL OXIDE FILM
R141	2410324002	2.7 kohm ±5% ¼W CARBON FILM
R142	2410324002	2.7 kohm ±5% ¼W CARBON FILM
R143	2420203003	10M ohm ±10% ¼W CARBON COMPOSIT

CAPACITORS

C01	2556085001	270pF ±5% 50V PLASTIC FILM
C02	2556152086	33pF ±5% 250V PLASTIC FILM
C03	2561018018	2.2µF ±10% 250V METALIZED
C04	2556154013	7pF ±1% 250V PLASTIC FILM
C05	2556105004	0.0018µF ±5% 50V PLASTIC FILM
C06	2556109000	0.0027µF ±5% 50V PLASTIC FILM
C07	2556105004	0.0018µF ±5% 50V PLASTIC FILM
C08	2561014041	0.1µF ±10% 250V METALIZED
C09	2561014012	0.22µF ±10% 250V METALIZED
C10	2544060025	1µF 100V ELECTROLYTIC
C11	2544060025	1µF 100V ELECTROLYTIC
C12	2544060025	1µF 100V ELECTROLYTIC
C13	2544060025	1µF 100V ELECTROLYTIC
C14	2556091008	470pF ±5% 50V PLASTIC FILM
C15	2556080006	160pF ±5% 50V PLASTIC FILM
C16	2544043000	0.47µF 50V ELECTROLYTIC
C17	2556101008	0.0012µF ±5% 50V PLASTIC FILM
C18	2556101008	0.0012µF ±5% 50V PLASTIC FILM
C19	2556091008	470pF ±5% 50V PLASTIC FILM
C20	2556091008	470pF ±5% 50V PLASTIC FILM
C21	2521081014	1pF ±0.5pF 500V MICA FILM
C25	2556154000	5pF ±1% 250V PLASTIC FILM
C26	2554081007	0.047µF ±5% 100V PLASTIC FILM
C27	2556083003	220pF ±5% 50V PLASTIC FILM
C31	2544047006	10µF 50V ELECTROLYTIC
C32	2556091008	470pF ±5% 50V PLASTIC FILM
C33	2556152086	33pF ±5% 250V PLASTIC FILM
C34	2561017035	0.022µF ±10% 630V METALIZED
C37	2561014041	0.1µF ±10% 250V METALIZED
C38	2556091008	470pF ±5% 50V PLASTIC FILM
C39	2556091008	470pF ±5% 50V PLASTIC FILM
C40	2556091008	470pF ±5% 50V PLASTIC FILM
C41	2556107002	0.0022µF ±5% 50V PLASTIC FILM
C42	2561019004	1µF ±10% 100V METALIZED
C43	2544060012	100µF 100V ELECTROLYTIC
C44	2561018005	1µF ±10% 250V METALIZED

ETC-361 RECT UNIT

(Con.)

Ref. No.	Part No.	Part Name & Descriptions
C45	2544060012	100μF 100V ELECTROLYTIC
C46	2561019004	1μF ±10% 100V METALIZED
C47	2544060012	100μF 100V ELECTROLYTIC
C48	2561018005	1μF ±10% 250V METALIZED
C49	2544060012	100μF 100V ELECTROLYTIC
C61	2556082004	200pF ±5% 50V PLASTIC FILM
C62	2556082004	200pF ±5% 50V PLASTIC FILM
C63	2544060025	1μF 100V ELECTROLYTIC
C64	2544060025	1μF 100V ELECTROLYTIC
OTHER PARTS		
	2220539100	P.W. BOARD
	2050112030	3P CONNECTOR BASE USED 4
	2050112043	4P CONNECTOR BASE USED 1
	2050112056	5P CONNECTOR BASE USED 1
	2050087026	2P TERMINAL
	2090008120	JUMPER SHORT LEAD P=10mm USED 3
	2090008117	JUMPER SHORT LEAD P=12.5mm USED 15
	2090008104	JUMPER SHORT LEAD P=15mm USED 1
	4140116106	SHIELD COVER
	2050003000	3T LUG
	4170043100	RADIATOR
	4730353036	TAPPING SCREW 3x6
VR01	2116016012	SEMI FIXED RESISTOR 500 OHM
VR02	2116016012	SEMI FIXED RESISTOR 500 OHM
	4170078201	RADIATOR
	4700013005	CROSS PAN SCREW WITH S. WASHER 3x14
	4756006008	3 NUT
	4730454016	TAPPING SCREW (2) 4x8

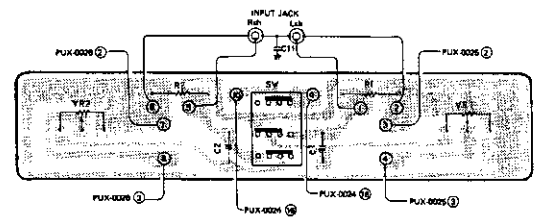
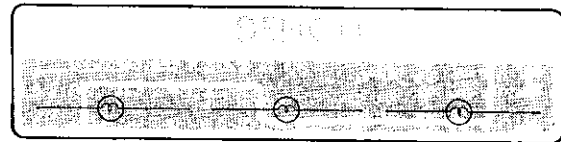
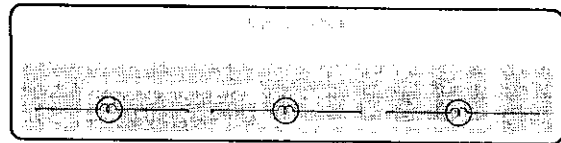
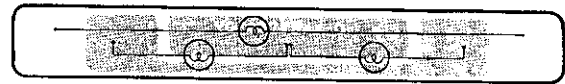
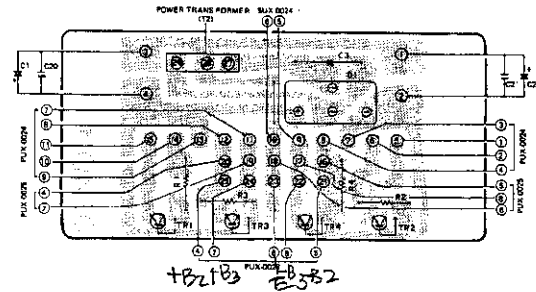

ETC-361 PARTS LIST

Ref. No.	Part No.	Part Name & Descriptions
SEMICONDUCTORS		
D07	2760245006	1S1RBA40F DIODE
D08	2760049008	1S2076 DIODE
RESISTORS		
R01	2410306004	470 ohm ±5% ¼W CARBON FILM
R02	2410306004	470 ohm ±5% ¼W CARBON FILM
R03	2452012055	470 ohm ±1% ¼W METALIZED FILM
R04	2452012055	470 ohm ±1% ¼W METALIZED FILM
CAPACITORS		
C03	2561017019	0.01μF ±10% 630V METALIZED
C04	2561017019	0.01μF ±10% 630V METALIZED
C05	2561017019	0.01μF ±10% 630V METALIZED
C06	2561017019	0.01μF ±10% 630V METALIZED
OTHER PARTS		
	2220544108	P.W. BOARD
	2090008120	JUMPER SHORT LEAD P=10mm USED 1

Ref. No.	Part No.	Part Name & Descriptions
	2050112030	3P CONNECTOR BASE
	2038083000	5P CONNECTOR CORD
	2040063018	6P CONNECTOR CORD
	2038082001	5P CONNECTOR CORD
	2030165052	1P CONTACT (D) ASS
	2030056093	1P CONTACT (D) ASS
	2030200014	1P CONTACT (D) ASS
	3930043008	PILOT LAMP
	2034133006	3P CONNECTOR CORD
	2032036040	2P CONNECTOR
	2032080025	2P CONNECTOR CORD
VR01	2110228107	VARIABLE RESISTOR 100 kohm
VR02	2110228107	VARIABLE RESISTOR 100 kohm
SW01	2120155008	ROTARY SWITCH (4 CIRCUIT 2 POSITION)
	4140190009	REFLECTOR
	4140194005	REFLECTOR
	2032080012	2P CONNECTOR CORD

6.3V 0.5A
3930107009

PUX-026 POWER DRIVE (R) UNIT

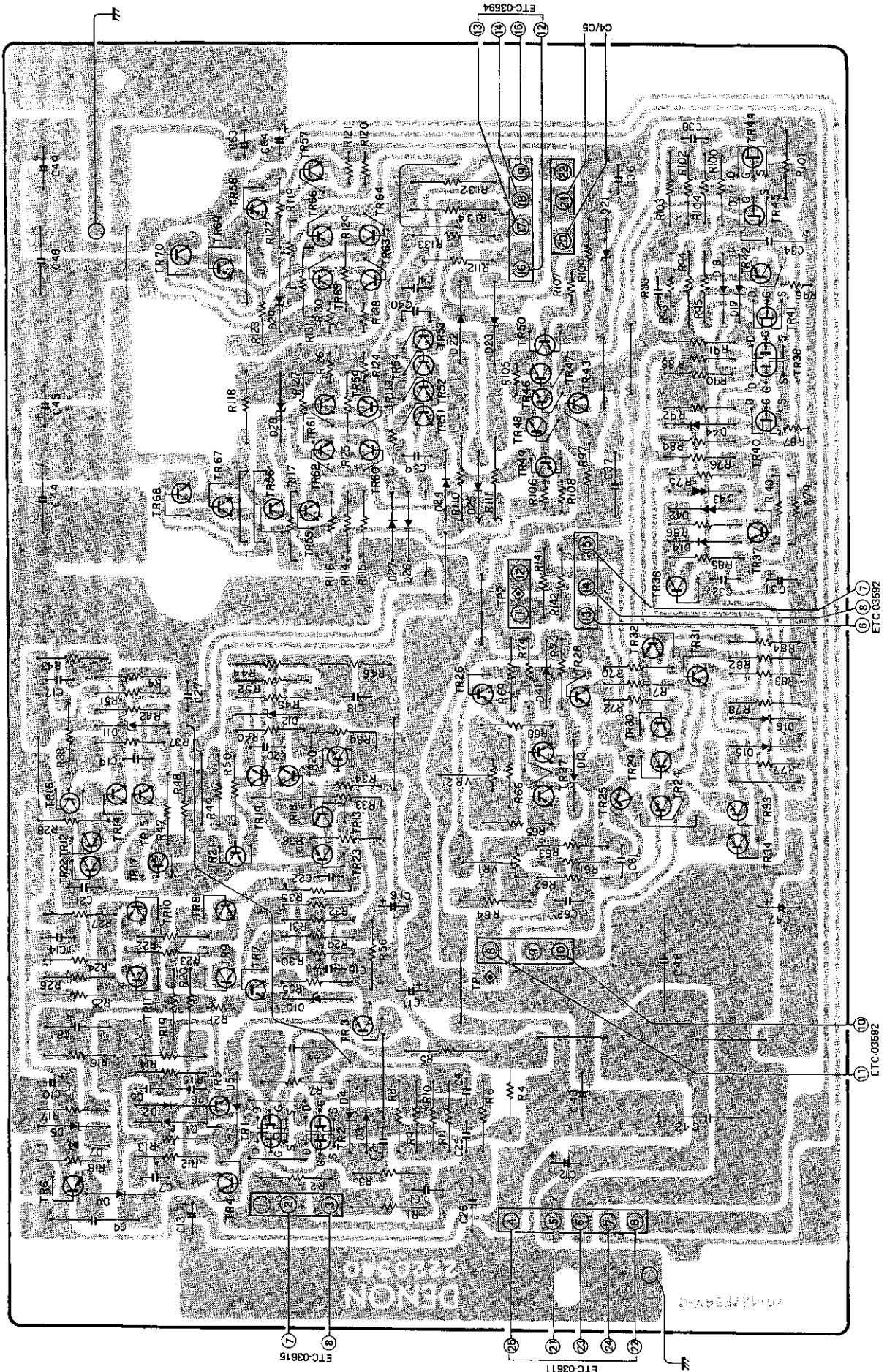

SUX-026 PARTS LIST

Ref. No.	Part No.	Part Name & Descriptions
SEMICONDUCTORS		
TR01	2750022006	2SK129A(M) FIELD EFFECT TRANSISTOR
TR02	2750022006	2SK129A(M) FIELD EFFECT TRANSISTOR
TR03	2710094016	2SA970(BL) TRANSISTOR
TR04	2730198002	2SC1815(Y) TRANSISTOR
TR05	2730198002	2SC1815(Y) TRANSISTOR
TR06	2730177007	2SC1626(Y) TRANSISTOR
TR07	2730205005	2SC1941(L) TRANSISTOR
TR08	2710094016	2SA970(BL) TRANSISTOR
TR09	2710094016	2SA970(BL) TRANSISTOR
TR10	2730187013	2SC2240(BL) TRANSISTOR
TR11	2730187013	2SC2240(BL) TRANSISTOR
TR12	2710094016	2SA970(BL) TRANSISTOR
TR13	2730187013	2SC2240(BL) TRANSISTOR
TR14	2710102005	2SA1015(Y) TRANSISTOR
TR15	2710102005	2SA1015(Y) TRANSISTOR
TR16	2710114006	2SA964A(Q) TRANSISTOR
TR17	2710114006	2SA964A(Q) TRANSISTOR
TR18	2730198002	2SC1815(Y) TRANSISTOR
TR19	2730198002	2SC1815(Y) TRANSISTOR
TR20	2730210003	2SC2224A(Q) TRANSISTOR
TR21	2730210003	2SC2224A(Q) TRANSISTOR
TR22	2710094016	2SA970(BL) TRANSISTOR
TR23	2730187013	2SC2240(BL) TRANSISTOR
TR24	2710102005	2SA1015(Y) TRANSISTOR
TR25	2710102005	2SA1015(Y) TRANSISTOR
TR26	2710110000	2SA916(L) TRANSISTOR
TR27	2710115005	2SA995(G) TRANSISTOR
TR28	2710110000	2SA916(L) TRANSISTOR
TR29	2710102005	2SA1015(Y) TRANSISTOR
TR30	2710102005	2SA1015(Y) TRANSISTOR
TR31	2710094016	2SA970(BL) TRANSISTOR
TR32	2710094016	2SA970(BL) TRANSISTOR
TR33	2710094016	2SA970(BL) TRANSISTOR
TR34	2710094016	2SA970(BL) TRANSISTOR
TR36	2730198002	2SC1815(Y) TRANSISTOR
TR37	2730198002	2SC1815(Y) TRANSISTOR
TR38	2750022006	2SK129A(M) FIELD EFFECT TRANSISTOR
TR40	2750020008	2SK163(M)FIELD EFFECT TRANSISTOR
TR41	2750020008	2SK163(M)FIELD EFFECT TRANSISTOR
TR42	2710102005	2SA1015(Y) TRANSISTOR
TR43	2730186001	2SC1940(L) TRANSISTOR
TR44	2750020008	2SK163(M)FIELD EFFECT TRANSISTOR
TR45	2750020008	2SK163(M)FIELD EFFECT TRANSISTOR
TR46	2730198002	2SC1815(Y) TRANSISTOR
TR47	2710102005	2SA1015(Y) TRANSISTOR
TR48	2730186001	2SC1940(L) TRANSISTOR
TR49	2710114006	2SA964A(Q) TRANSISTOR
TR50	2730210003	2SC2224A(Q) TRANSISTOR
TR51	2710102005	2SA1015(Y) TRANSISTOR
TR52	2730198002	2SC1815(Y) TRANSISTOR
TR53	2730198002	2SC1815(Y) TRANSISTOR
TR54	2710102005	2SA1015(Y) TRANSISTOR
TR55	2710094016	2SA970(BL) TRANSISTOR
TR56	2730187013	2SC2240(BL) TRANSISTOR
TR57	2730187013	2SC2240(BL) TRANSISTOR
TR58	2710094016	2SA970(BL) TRANSISTOR
TR59	2730198002	2SC1815(Y) TRANSISTOR
TR60	2730198002	2SC1815(Y) TRANSISTOR
TR61	2730198002	2SC1815(Y) TRANSISTOR
TR62	2730198002	2SC1815(Y) TRANSISTOR
TR63	2710102005	2SA1015(Y) TRANSISTOR
TR64	2710102005	2SA1015(Y) TRANSISTOR
TR65	2710102005	2SA1015(Y) TRANSISTOR

Ref. No.	Part No.	Part Name & Descriptions
TR66	2710102005	2SA1015(Y) TRANSISTOR
TR67	2730199001	2SC2238(Y) TRANSISTOR
TR68	2730199001	2SC2238(Y) TRANSISTOR
TR69	2710104003	2SA968(Y) TRANSISTOR
TR70	2710104003	2SA968(Y) TRANSISTOR
D01	2760049008	1S2076 DIODE
D02	2760049008	1S2076 DIODE
D03	2760049008	1S2076 DIODE
D04	2760049008	1S2076 DIODE
D05	2760254000	HZ7B-3 DIODE
D06	2760255009	HZ12C-3 DIODE
D07	2760255009	HZ12C-3 DIODE
D09	2760049011	1S2076A DIODE
D10	2760173039	HZ6-B2 DIODE
D11	2760256008	HZ16-2 DIODE
D12	2760256008	HZ16-2 DIODE
D13	2760049008	1S2076 DIODE
D14	2760049008	1S2076 DIODE
D15	2760049008	1S2076 DIODE
D16	2760049008	1S2076 DIODE
D17	2760049008	1S2076 DIODE
D18	2760049008	1S2076 DIODE
D21	2760221017	HZ36-2 DIODE
D22	2760184002	1S1834 DIODE
D23	2760184002	1S1834 DIODE
D24	2760049008	1S2076 DIODE
D25	2760049008	1S2076 DIODE
D26	2760049008	1S2076 DIODE
D27	2760049008	1S2076 DIODE
D28	2760256008	HZ16-2 DIODE
D29	2760256008	HZ16-2 DIODE
D41	2760254000	HZ7B-3 DIODE
D42	2760200009	MV-11 DIODE
D43	2760200009	MV-11 DIODE
D44	2760049008	1S2076 DIODE
D50	2760191008	W03C DIODE
RESISTORS		
R01	2410314009	1 kohm ±5% ¼W CARBON FILM
R02	2410378003	470 kohm±5% ¼W CARBON FILM
R03	2410290000	100 ohm ±5% ¼W CARBON FILM
R04	2440054025	12 kohm ±5% 1W METAL OXIDE FILM
R05	2440054025	12 kohm ±5% 1W METAL OXIDE FILM
R06	2410302008	330 ohm ±5% ¼W CARBON FILM
R07	2420203003	10M ohm ±10% ¼W CARBON COMPOSIT
R08	2410340002	12 kohm ±5% ¼W CARBON FILM
R09	2410340002	12 kohm ±5% ¼W CARBON FILM
R10	2410340002	12 kohm ±5% ¼W CARBON FILM
R11	2410340002	12 kohm ±5% ¼W CARBON FILM
R12	2410276008	27 ohm ±5% ¼W CARBON FILM
R13	2410346006	22 kohm ±5% ¼W CARBON FILM
R14	2410322004	2.2 kohm ±5% ¼W CARBON FILM
R15	2410322004	2.2 kohm ±5% ¼W CARBON FILM
R16	2410336003	8.2 kohm ±5% ¼W CARBON FILM
R17	2410342000	15 kohm ±5% ¼W CARBON FILM
R18	2410358007	68 kohm ±5% ¼W CARBON FILM
R19	2410314009	1 kohm ±5% ¼W CARBON FILM
R20	2410314009	1 kohm ±5% ¼W CARBON FILM
R21	2412022085	47 kohm ±5% ¼W CARBON FILM
R22	2410300000	270 ohm ±5% ¼W CARBON FILM
R23	2410300000	270 ohm ±5% ¼W CARBON FILM
R24	2410327009	3.6 kohm ±5% ¼W CARBON FILM
R25	2410327009	3.6 kohm ±5% ¼W CARBON FILM
R26	2410314009	1 kohm ±5% ¼W CARBON FILM
R27	2410314009	1 kohm ±5% ¼W CARBON FILM
R28	2410354001	47 kohm ±5% ¼W CARBON FILM
R29	2410314009	1 kohm ±5% ¼W CARBON FILM

(Con.)

Ref. No.	Part No.	Part Name & Descriptions
R30	2410327009	3.6 kohm ±5% ¼W CARBON FILM
R31	2410327009	3.6 kohm ±5% ¼W CARBON FILM
R32	2410314009	1 kohm ±5% ¼W CARBON FILM
R33	2410369009	200 kohm±5% ¼W CARBON FILM
R34	2410354001	47 kohm ±5% ¼W CARBON FILM
R35	2410314009	1 kohm ±5% ¼W CARBON FILM
R36	2410369009	200 kohm±5% ¼W CARBON FILM
R37	2410336003	8.2 kohm ±5% ¼W CARBON FILM
R38	2410346006	22 kohm ±5% ¼W CARBON FILM
R39	2410346006	22 kohm ±5% ¼W CARBON FILM
R40	2410336003	8.2 kohm ±5% ¼W CARBON FILM
R41	2410278006	33 ohm ±5% ¼W CARBON FILM
R42	2410278006	33 ohm ±5% ¼W CARBON FILM
R43	2410171006	270 ohm ±5% ¼W CARBON FILM
R44	2410278006	33 ohm ±5% ¼W CARBON FILM
R45	2410278006	33 ohm ±5% ¼W CARBON FILM
R46	2410171006	270 ohm ±5% ¼W CARBON FILM
R47	2410348004	27 kohm ±5% ¼W CARBON FILM
R48	2410359006	75 kohm ±5% ¼W CARBON FILM
R49	2410359006	75 kohm ±5% ¼W CARBON FILM
R50	2410348004	27 kohm ±5% ¼W CARBON FILM
R51	2410330009	4.7 kohm ±5% ¼W CARBON FILM
R52	2410330009	4.7 kohm ±5% ¼W CARBON FILM
R55	2410306004	470 ohm ±5% ¼W CARBON FILM
R56	2410372009	270 kohm ±5% ¼W CARBON FILM
R61	2410284003	56 ohm ±5% ¼W CARBON FILM
R62	2410300000	270 ohm ±5% ¼W CARBON FILM
R63	2410300000	270 ohm ±5% ¼W CARBON FILM
R64	2410284003	56 ohm ±5% ¼W CARBON FILM
R65	2410312001	820 ohm ±5% ¼W CARBON FILM
R66	2410304006	390 ohm ±5% ¼W CARBON FILM
R68	2410312001	820 ohm ±5% ¼W CARBON FILM
R69	2410351004	36 kohm ±5% ¼W CARBON FILM
R70	2410338001	10 kohm ±5% ¼W CARBON FILM
R71	2410311002	750 ohm ±5% ¼W CARBON FILM
R72	2410311002	750 ohm ±5% ¼W CARBON FILM
R73	2410330009	4.7 kohm ±5% ¼W CARBON FILM
R74	2410358007	68 kohm ±5% ¼W CARBON FILM
R75	2410345007	20 kohm ±5% ¼W CARBON FILM
R76	2410345007	20 kohm ±5% ¼W CARBON FILM
R77	2410326000	3.3 kohm ±5% ¼W CARBON FILM
R78	2410326000	3.3 kohm ±5% ¼W CARBON FILM
R79	2410765001	1M ohm ±5% ¼W CARBON FILM
R82	2410350005	33 kohm ±5% ¼W CARBON FILM
R83	2410326000	3.3 kohm ±5% ¼W CARBON FILM
R84	2410326000	3.3 kohm ±5% ¼W CARBON FILM
R85	2410330009	4.7 kohm ±5% ¼W CARBON FILM
R86	2410362006	100 kohm±5% ¼W CARBON FILM
R87	2412020045	3.9 kohm ±5% ¼W CARBON FILM
R88	2410306004	470 ohm ±5% ¼W CARBON FILM
R89	2410306004	470 ohm ±5% ¼W CARBON FILM
R90	2410338001	10 kohm ±5% ¼W CARBON FILM
R91	2410338001	10 kohm ±5% ¼W CARBON FILM
R92	2410338001	10 kohm ±5% ¼W CARBON FILM
R93	2410338001	10 kohm ±5% ¼W CARBON FILM
R94	2410279005	36 ohm ±5% ¼W CARBON FILM
R95	2410290000	100 ohm ±5% ¼W CARBON FILM
R96	2412020090	10 kohm ±5% ¼W CARBON FILM
R97	2410342000	15 kohm ±5% ¼W CARBON FILM
R100	2410306004	470 ohm ±5% ¼W CARBON FILM
R101	2410328008	3.9 kohm ±5% ¼W CARBON FILM
R102	2410338001	10 kohm ±5% ¼W CARBON FILM
R103	2410338001	10 kohm ±5% ¼W CARBON FILM
R104	2410314009	1 kohm ±5% ¼W CARBON FILM
R105	2412028021	1.6 kohm ±5% ¼W CARBON FILM
R106	2412002021	330 ohm ±5% ¼W CARBON FILM
R107	2412002021	330 ohm ±5% ¼W CARBON FILM
R108	2412002005	220 ohm ±5% ¼W CARBON FILM

Ref. No.	Part No.	Part Name & Descriptions
R109	2410298002	220 ohm ±5% ¼W CARBON FILM
R110	2440090005	220 ohm ±5% 2W METAL OXIDE FILM
R111	2440090005	220 ohm ±5% 2W METAL OXIDE FILM
R112	2410314009	1 kohm ±5% ¼W CARBON FILM
R113	2410358007	68 kohm ±5% ¼W CARBON FILM
R114	2410319004	1.6 kohm ±5% ¼W CARBON FILM
R115	2410356009	56 kohm ±5% ¼W CARBON FILM
R116	2410314009	1 kohm ±5% ¼W CARBON FILM
R117	2410306004	470 ohm ±5% ¼W CARBON FILM
R118	2410332007	5.6 kohm ±5% ¼W CARBON FILM
R119	2410356009	56 kohm ±5% ¼W CARBON FILM
R120	2412028021	1.6 kohm ±5% ¼W CARBON FILM
R121	2412002089	1 kohm ±5% ¼W CARBON FILM
R122	2410306004	470 ohm ±5% ¼W CARBON FILM
R123	2410332007	5.6 kohm ±5% ¼W CARBON FILM
R124	2412000049	10 ohm ±5% ¼W CARBON FILM
R125	2410266005	10 ohm ±5% ¼W CARBON FILM
R126	2412000049	10 ohm ±5% ¼W CARBON FILM
R127	2410266005	10 ohm ±5% ¼W CARBON FILM
R128	2412000049	10 ohm ±5% ¼W CARBON FILM
R129	2410266005	10 ohm ±5% ¼W CARBON FILM
R130	2412000049	10 ohm ±5% ¼W CARBON FILM
R131	2410266005	10 ohm ±5% ¼W CARBON FILM
R132	2442021098	100 ohm ±5% ½W METAL OXIDE FILM
R133	2440086006	100 ohm ±5% 2W METAL OXIDE FILM
R134	2440086006	100 ohm ±5% 2W METAL OXIDE FILM
R141	2410324002	2.7 kohm ±5% ¼W CARBON FILM
R142	2410324002	2.7 kohm ±5% ¼W CARBON FILM
R143	2420203003	10M ohm ±10% ¼W CARBON COMPOSIT

CAPACITORS

C01	2556085001	270pF ±5% 50V PLASTIC FILM
C02	2556152086	33pF ±5% 250V PLASTIC FILM
C03	2561018018	2.2µF ±10% 250V METALIZED
C04	2556154013	7pF ±1% 250V PLASTIC FILM
C05	2556105004	0.0018µF ±5% 50V PLASTIC FILM
C06	2556109000	0.0027µF ±5% 50V PLASTIC FILM
C07	2556105004	0.0018µF ±5% 50V PLASTIC FILM
C08	2561014041	0.1µF ±10% 250V METALIZED
C09	2561014012	0.22µF ±10% 250V METALIZED
C10	2544060025	1µF 100V ELECTROLYTIC
C11	2544060025	1µF 100V ELECTROLYTIC
C12	2544060025	1µF 100V ELECTROLYTIC
C13	2544060025	1µF 100V ELECTROLYTIC
C14	2556091008	470pF ±5% 50V PLASTIC FILM
C15	2556080006	160pF ±5% 50V PLASTIC FILM
C16	2544043000	0.47µF 50V ELECTROLYTIC
C17	2556101008	0.0012µF ±5% 50V PLASTIC FILM
C18	2556101008	0.0012µF ±5% 50V PLASTIC FILM
C19	2556091008	470pF ±5% 50V PLASTIC FILM
C20	2556091008	470pF ±5% 50V PLASTIC FILM
C21	2521081014	1pF ±0.5pF 500V MICA FILM
C25	2556154000	5pF ±1% 250V PLASTIC FILM
C26	2554081007	0.047µF ±5% 100V PLASTIC FILM
C27	2556083003	220pF ±5% 50V PLASTIC FILM
C31	2544047006	10µF 50V ELECTROLYTIC
C32	2556091008	470pF ±5% 50V PLASTIC FILM
C33	2556152086	33pF ±5% 250V PLASTIC FILM
C34	2561017035	0.022µF ±10% 630V METALIZED
C37	2561014041	0.1µF ±10% 250V METALIZED
C38	2556091008	470pF ±5% 50V PLASTIC FILM
C39	2556091008	470pF ±5% 50V PLASTIC FILM
C40	2556091008	470pF ±5% 50V PLASTIC FILM
C41	2556107002	0.0022µF ±5% 50V PLASTIC FILM
C42	2561019004	1µF ±10% 100V METALIZED
C43	2544060012	100µF 100V ELECTROLYTIC
C44	2561018005	1µF ±10% 250V METALIZED

ETC-358B PROTECT UNIT

(Con.)

Ref. No.	Part No.	Part Name & Descriptions
C45	2544060012	100 μ F 100V ELECTROLYTIC
C46	2561019004	1 μ F \pm 10% 100V METALIZED
C47	2544060012	100 μ F 100V ELECTROLYTIC
C48	2561018005	1 μ F \pm 10% 250V METALIZED
C49	2544060012	100 μ F 100V ELECTROLYTIC
C61	2556082004	200pF \pm 5% 50V PLASTIC FILM
C62	2556082004	200pF \pm 5% 50V PLASTIC FILM
C63	2544060025	1 μ F 100V ELECTROLYTIC
C64	2544060025	1 μ F 100V ELECTROLYTIC
OTHER PARTS		
VR01 VR02	2220540102	P.W. BOARD
	2050112030	3P CONNECTOR BASE USED 4
	2050112043	4P CONNECTOR BASE USED 1
	2050112056	5P CONNECTOR BASE USED 1
	2050087026	2P TERMINAL
	2090008120	JUMPER SHORT LEAD P=10mm USED 3
	2090008117	JUMPER SHORT LEAD P=12.5mm USED 16
	2090008104	JUMPER SHORT LEAD P=15mm USED 2
	4140116106	SHIELD COVER
	2050003000	3T LUG
	4170043100	RADIATOR
	4730353036	TAPPING SCREW 3x6
	2116016012	SEMI FIXED RESISTOR 500 OHM
	2116016012	SEMI FIXED RESISTOR 500 OHM
	4170078201	RADIATOR
	4700013005	CROSS PAN SCREW WITH S. WASHER 3x14
	4756006008	3 NUT
	4730454016	TAPPING SCREW (2) 4x8

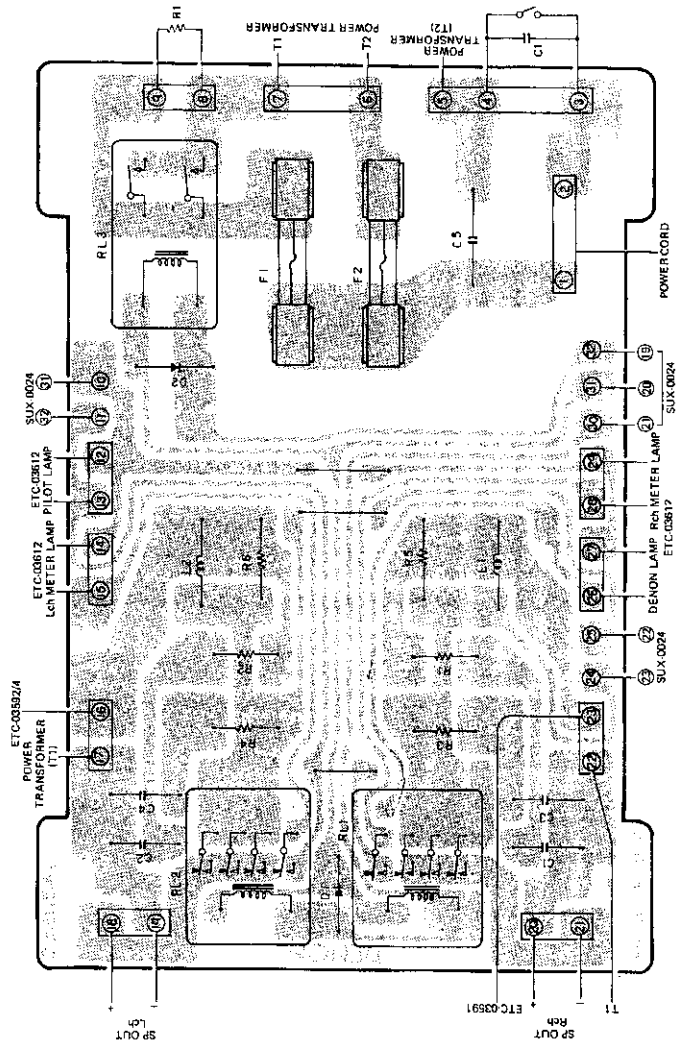

TC-358B PARTS LIST

Ref. No.	Part No.	Part Name & Descriptions
SEMICONDUCTORS		
D01	2760237001	RV06 DIODE
D02	2760237001	RV06 DIODE
RESISTORS		
R01	2430045002	10 ohm \pm 10% 5W WIRE WOUND
R02	2430045002	10 ohm \pm 10% 5W WIRE WOUND
R03	2430045002	10 ohm \pm 10% 5W WIRE WOUND
R04	2430045002	10 ohm \pm 10% 5W WIRE WOUND
R05	2410137008	10 ohm \pm 5% 1/2W CARBON FILM
R06	2410137008	10 ohm \pm 5% 1/2W CARBON FILM
CAPACITORS		
C01	2561017035	0.022 μ F \pm 10% 630V METALIZED
C02	2561017035	0.022 μ F \pm 10% 630V METALIZED
C03	2561017019	0.01 μ F \pm 10% 630V METALIZED
C04	2561017019	0.01 μ F \pm 10% 630V METALIZED

Ref. No.	Part No.	Part Name & Descriptions
OTHER PARTS		
	2220541101	P.W. BOARD
	2050112027	2P CONNECTOR BASE
	2090008120	JUMPER SHORT LEAD P=10mm USED 1
	2090008104	JUMPER SHORT LEAD P=15mm USED 2
	2050087039	3P TERMINAL
	2050087042	4P TERMINAL
	2050087026	2P TERMINAL
	2034118047	3P CONNECTOR CORD
	2034118050	3P CONNECTOR CORD
	2032036082	2P CONNECTOR CORD
	EP-5870	FUSE HOLDER
F01	2061017027	FUSE (8A)
F02	2061025022	FUSE (0.8A) TIME LAG TYPE
L01	2320017001	INDUCTOR
L02	2320017001	INDUCTOR
RL01	2140016004	RELAY FOR SPEAKER
RL02	2140016004	RELAY FOR SPEAKER
RL03	2140038008	RELAY FOR AC SWITCH

SUX-024B POWER SUPPLY UNIT

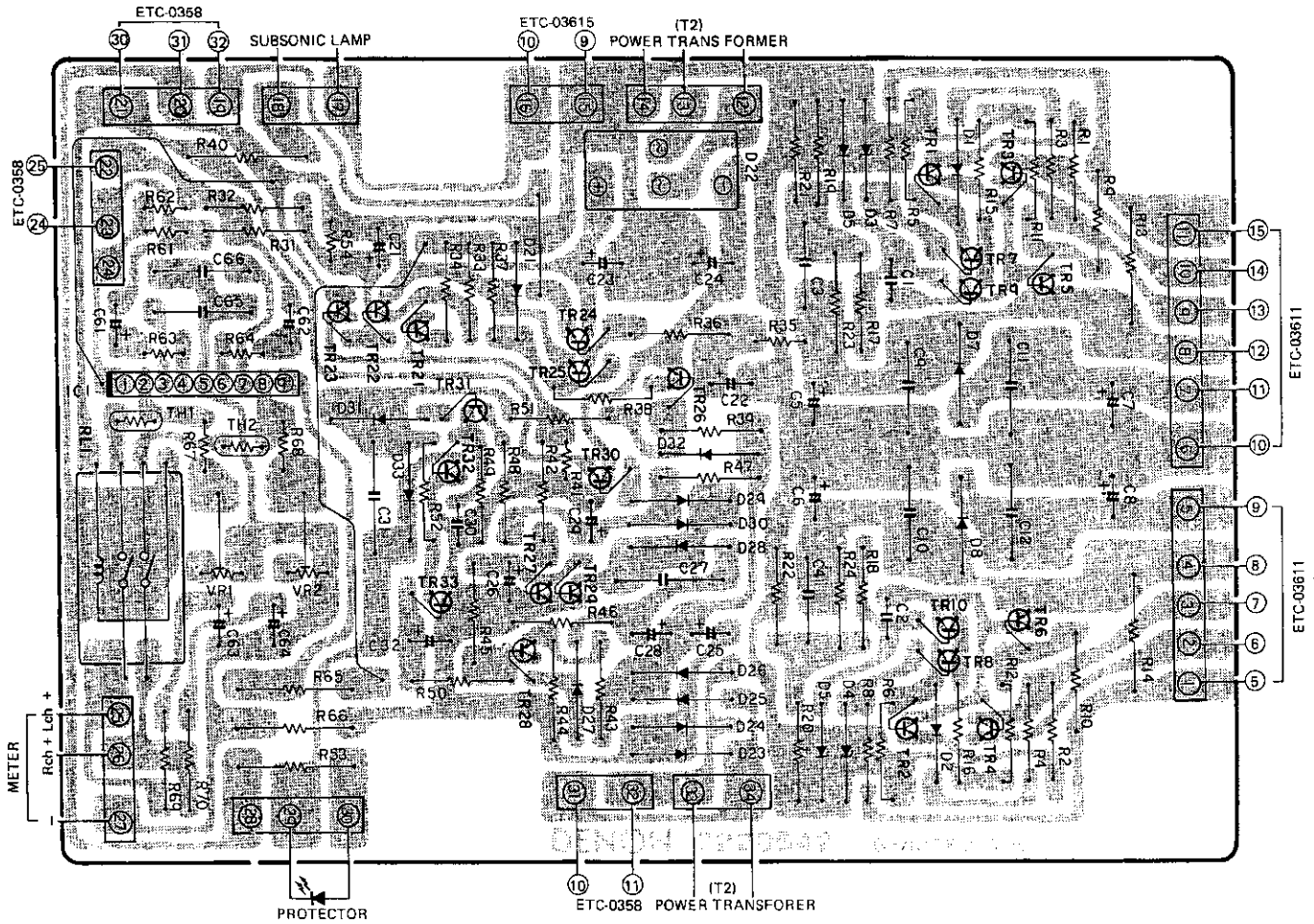

SUX-024B PARTS LIST

Ref. No.	Part No.	Part Name & Descriptions	Ref. No.	Part No.	Part Name & Descriptions
SEMICONDUCTORS					
IC01	2630071009	TA-7318P INTEGRATED CIRCUIT	TR32	2730198002	2SC1815(Y) TRANSISTOR
TR01	2710094016	2SA970(BL) TRANSISTOR	TR33	2730198002	2SC1815(Y) TRANSISTOR
TR02	2730187013	2SC2240(BL) TRANSISTOR	D01	2760049008	1S2076 DIODE
TR03	2730187013	2SC2240(BL) TRANSISTOR	D02	2760049008	1S2076 DIODE
TR04	2710094016	2SA970(BL) TRANSISTOR	D03	2760254000	HZ7B-3 DIODE
TR05	2730187013	2SC2240(BL) TRANSISTOR	D04	2760254000	HZ7B-3 DIODE
TR06	2710094016	2SA970(BL) TRANSISTOR	D05	2760049008	1S2076 DIODE
TR07	2730187013	2SC2240(BL) TRANSISTOR	D06	2760049008	1S2076 DIODE
TR08	2710094016	2SA970(BL) TRANSISTOR	D21	2760049008	1S2076 DIODE
TR09	2730187013	2SC2240(BL) TRANSISTOR	D22	2760194018	1RBA10F DIODE
TR10	2710094016	2SA970(BL) TRANSISTOR	D23	2760237001	RV06 DIODE
TR21	2710102005	2SA1015(Y) TRANSISTOR	D24	2760237001	RV06 DIODE
TR22	2730198002	2SC1815(Y) TRANSISTOR	D25	2760237001	RV06 DIODE
TR23	2710102005	2SA1015(Y) TRANSISTOR	D26	2760237001	RV06 DIODE
TR24	2730198015	2SC1815(BL) TRANSISTOR	D27	2760049008	1S2076 DIODE
TR25	2730198002	2SC1815(Y) TRANSISTOR	D28	2760049008	1S2076 DIODE
TR26	2730198002	2SC1815(Y) TRANSISTOR	D29	2760049008	1S2076 DIODE
TR27	2730198002	2SC1815(Y) TRANSISTOR	D30	2760049008	1S2076 DIODE
TR28	2710102005	2SA1015(Y) TRANSISTOR	D31	2760049008	1S2076 DIODE
TR29	2730198002	2SC1815(Y) TRANSISTOR	D32	2760049008	1S2076 DIODE
TR30	2710102005	2SA1015(Y) TRANSISTOR	D33	2760049008	1S2076 DIODE
TR31	2710102005	2SA1015(Y) TRANSISTOR	TH01	2790006011	11210-2 THERMISTOR (100 OHM)
			TH02	2790006011	112101-2 THERMISTOR (100 OHM)

(Con.)

Ref. No.	Part No.	Part Name & Descriptions
RESISTORS		
R01	2440029021	100 ohm ±5% 1W METAL OXIDE FILM
R02	2440029021	100 ohm ±5% 1W METAL OXIDE FILM
R03	2440029021	100 ohm ±5% 1W METAL OXIDE FILM
R04	2440029021	100 ohm ±5% 1W METAL OXIDE FILM
R05	2410765001	1M ohm ±5% ¼W CARBON FILM
R06	2410765001	1M ohm ±5% ¼W CARBON FILM
R07	2410354001	47 kohm ±5% ¼W CARBON FILM
R08	2410354001	47 kohm ±5% ¼W CARBON FILM
R09	2410321005	2 kohm ±5% ¼W CARBON FILM
R10	2410321005	2 kohm ±5% ¼W CARBON FILM
R11	2410354001	47 kohm ±5% ¼W CARBON FILM
R12	2410354001	47 kohm ±5% ¼W CARBON FILM
R13	2440017020	10 ohm ±5% 1W METAL OXIDE FILM
R14	2440017020	10 ohm ±5% 1W METAL OXIDE FILM
R15	2410330009	4.7 kohm ±5% ¼W CARBON FILM
R16	2410330009	4.7 kohm ±5% ¼W CARBON FILM
R17	2410314009	1 kohm ±5% ¼W CARBON FILM
R18	2410314009	1 kohm ±5% ¼W CARBON FILM
R19	2410361007	91 kohm ±5% ¼W CARBON FILM
R20	2410361007	91 kohm ±5% ¼W CARBON FILM
R21	2412169016	11 kohm ±2% ¼W CARBON FILM
R22	2412169016	11 kohm ±2% ¼W CARBON FILM
R23	2412032088	100 kohm ±2% ¼W CARBON FILM
R24	2412032088	100 kohm ±2% ¼W CARBON FILM
R31	2410357008	62 kohm ±5% ¼W CARBON FILM
R32	2410357008	62 kohm ±5% ¼W CARBON FILM
R33	2410334005	6.8 kohm ±5% ¼W CARBON FILM
R34	2410334005	6.8 kohm ±5% ¼W CARBON FILM
R35	2412003059	180 kohm ±5% ¼W CARBON FILM
R36	2410314009	1 kohm ±5% ¼W CARBON FILM
R37	2410338001	10 kohm ±5% ¼W CARBON FILM
R38	2410326000	3.3 kohm ±5% ¼W CARBON FILM
R39	2410350005	33 kohm ±5% ¼W CARBON FILM
R40	2440093028	390 ohm ±5% 2W METAL OXIDE FILM
R41	2412020090	10 kohm ±5% ¼W CARBON FILM
R42	2410346006	22 kohm ±5% ¼W CARBON FILM
R43	2410318005	1.5 kohm ±5% ¼W CARBON FILM
R44	2410318005	1.5 kohm ±5% ¼W CARBON FILM
R45	2410324002	2.7 kohm ±5% ¼W CARBON FILM
R46	2410768008	1.3M ohm ± ¼W CARBON FILM
R47	2410350005	33 kohm ±5% ¼W CARBON FILM
R48	2410308002	560 ohm ±5% ¼W CARBON FILM
R49	2410330009	4.7 kohm ±5% ¼W CARBON FILM
R50	2410346006	22 kohm ±5% ¼W CARBON FILM
R51	2410354001	47 kohm ±5% ¼W CARBON FILM
R52	2410370001	220 kohm ±5% ¼W CARBON FILM
R53	2440041025	1 kohm ±5% 1W METAL OXIDE FILM
R54	2410770009	560 kohm ±5% ¼W CARBON FILM
R61	2412003020	100 kohm ±5% ¼W CARBON FILM
R62	2412003020	100 kohm ±5% ¼W CARBON FILM
R63	2412003004	68 kohm ±5% ¼W CARBON FILM
R64	2412003004	68 kohm ±5% ¼W CARBON FILM

Ref. No.	Part No.	Part Name & Descriptions
R65	2440043023	1.5 kohm ±5% 1W METAL OXIDE FILM
R66	2440043023	1.5 kohm ±5% 1W METAL OXIDE FILM
R67	2412027077	620 ohm ±5% ¼W CARBON FILM
R68	2412027077	620 ohm ±5% ¼W CARBON FILM
R69	2410314009	1 kohm ±5% ¼W CARBON FILM
R70	2410314009	1 kohm ±5% ¼W CARBON FILM
R81	2410165009	150 ohm ±5% ¼W CARBON FILM
R82	2410147001	27 ohm ±5% ¼W CARBON FILM
CAPACITORS		
C01	2556152015	15pF ±5% 250V PLASTIC FILM
C02	2556152015	15pF ±5% 250V PLASTIC FILM
C03	2561014041	0.1µF ±10% 250V METALIZED
C04	2561014041	0.1µF ±10% 250V METALIZED
C05	2544060009	10µF 100V ELECTROLYTIC
C06	2544060009	10µF 100V ELECTROLYTIC
C07	2544060012	100µF 100V ELECTROLYTIC
C08	2544060012	100µF 100V ELECTROLYTIC
C09	2561018005	1µF ±10% 250V METALIZED
C10	2561018005	1µF ±10% 250V METALIZED
C21	2544003008	100µF 63V ELECTROLYTIC
C22	2549011024	10µF 50V ELECTROLYTIC
C23	2544050006	100µF 50V ELECTROLYTIC
C24	2544050006	100µF 50V ELECTROLYTIC
C25	2544024003	4.7µF 25V ELECTROLYTIC
C26	2544024003	4.7µF 25V ELECTROLYTIC
C27	2554081081	0.1µF ±5% 100V PLASTIC FILM
C28	2549008024	4.7µF 25V ELECTROLYTIC
C29	2549008024	4.7µF 25V ELECTROLYTIC
C30	2556099000	0.001µF ±5% 50V PLASTIC FILM
C31	2554081081	0.1µF ±5% 100V PLASTIC FILM
C32	2544015009	10µF 16V ELECTROLYTIC
C61	2544044009	1µF 50V ELECTROLYTIC
C62	2544044009	1µF 50V ELECTROLYTIC
C63	2544009002	47µF 10V ELECTROLYTIC
C64	2544009002	47µF 10V ELECTROLYTIC
C65	2554080024	0.022µF ±5% 100V PLASTIC FILM
C66	2554080024	0.022µF ±5% 100V PLASTIC FILM
C70	2544047006	10µF 50V ELECTROLYTIC
C71	2556152015	15pF ±5% 250V PLASTIC FILM
C72	2556152015	15pF ±5% 250V PLASTIC FILM
OTHER PARTS		
	2220542100	P.W. BOARD
	2050112027	2P CONNECTOR BASE
	2050112030	3P CONNECTOR BASE
	2050112056	5P CONNECTOR BASE
	2050112069	6P CONNECTOR BASE
RL01	2140015005	REED RELAY 2140034002
VR01	2116016012	SEMI FIXED RESISTOR 500 OHM
VR02	2116016012	SEMI FIXED RESISTOR 500 OHM

WIRING DIAGRAM

Means important safety item, which must be replaced, when necessary, by a part specified or meeting the specification by the manufacturer.

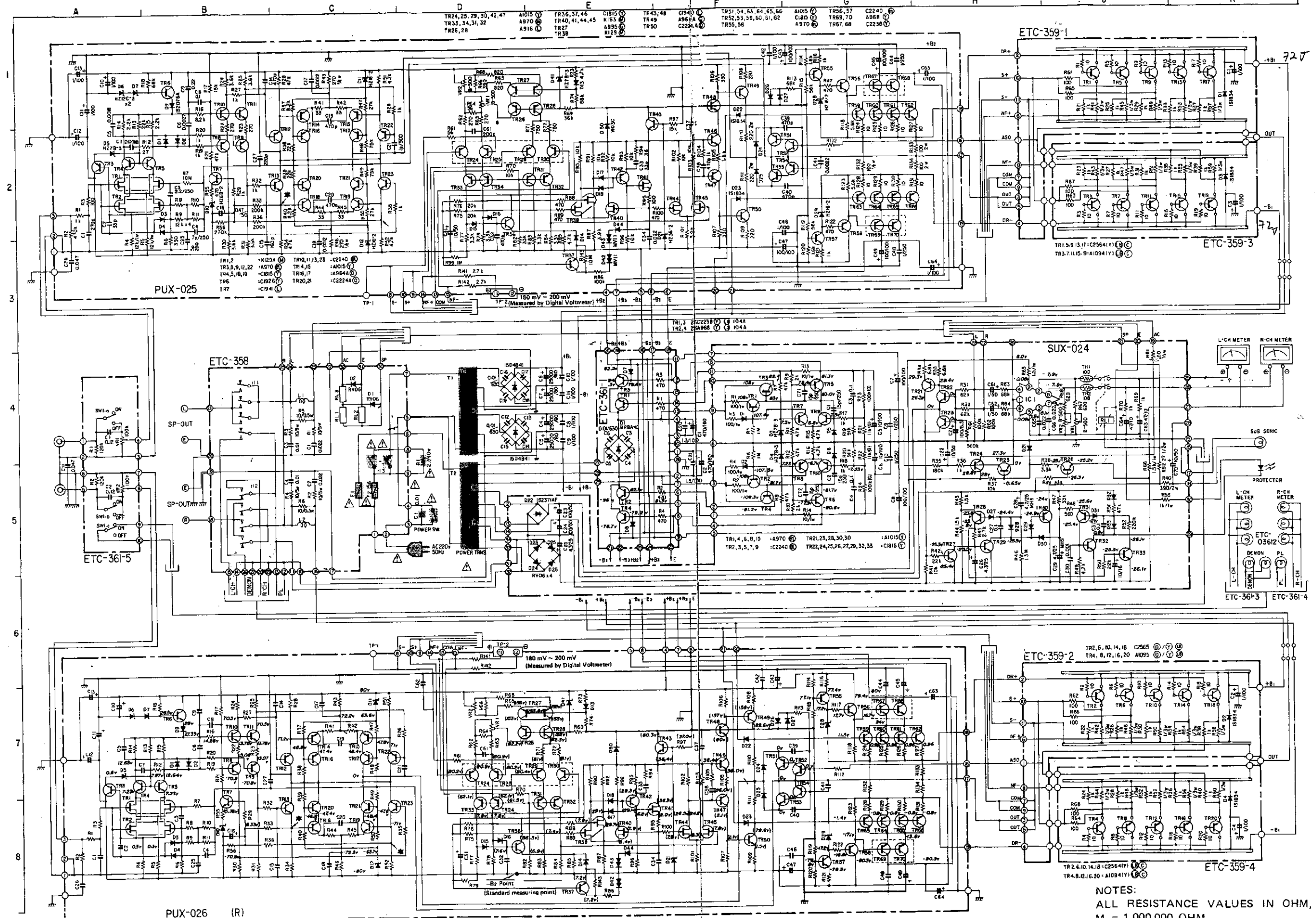

WARNING: THE POINTS INDICATED WITH "*" SHOULD NOT BE TOUCHED FOR MEASUREMENT, OR INVITE DAMAGE TO THE TRANSISTORS ON ETC-03594 P.C. BOARD. UNLESS OTHERWISE SPECIFIED, DIODES ARE 1S2076. CIRCUIT AND PARTS ARE SUBJECT TO CHANGE WITHOUT PRIOR NOTICE.

NOTES: ALL RESISTANCE VALUES IN OHM, K = 1,000 OHM, M = 1,000,000 OHM. ALL CAPACITANCE VALUES IN MICROFARAD, P = MICRO-MICRO FARAD. EVERY VOLTAGES AND CURRENTS IS MEASURED AT NO SIGNAL INPUT CONDITION. ALL VOLTAGE VALUES IN () ARE MEASURED BETWEEN THE SPECIFIED POINTS AND THE STANDERD MEASURING POINT INDICATED -B2.