

BEKKO

COLOUR TELEVISIONS

Service Manual
K5 CHASSIS-DVD COMBO TV

CONTENTS	PAGE
o <u>Safety Instructions</u>	<u>2</u>
o <u>Technical Specifications</u>	<u>3</u>
o <u>Remote Control</u>	<u>4</u>
o <u>Preparations</u>	<u>7</u>
o <u>Operating Your TV</u>	<u>8</u>
o <u>Block Diagram</u>	<u>21</u>
o <u>IC Datasheets&Specs</u>	<u>22</u>
o <u>Pin Voltages of IC's</u>	<u>29</u>
o <u>Oscillosgraphs Of Some IC Pins</u>	<u>31</u>
o <u>Electrical Adjustments</u>	<u>35</u>
o <u>Channel Frequency Tables</u>	<u>38</u>
o <u>Spare Part List</u>	<u>41</u>

1. SAFETY INSTRUCTIONS

GENERAL GUIDELINES

1. It is advised to insert an isolation transformer in the AC supply before servicing a hot chassis.
2. Potentials as high as 33KV are present when this receiver is in operation. Operation of the receiver without the rear cover involves the danger of a shock hazard from the receiver power supply. Servicing should not be attempted by any one who is not competent with the precautions necessary when working on the high voltage equipment. Always discharge the anode of the tube.
3. When servicing observe the original lead dress in the high voltage circuits. If a short circuit is found, replace all the parts which have been overheated or damaged by the short circuit.
4. Always use the manufacturer's replacement safety components. The critical safety components marked with \triangle on the schematics diagrams should not be replaced by other substitutes. Other substitute may create the electrical shock, fire or other hazards. Take attention to replace the spacers with the originals. Furthermore where a short circuit has occurred, replace those components that indicate evidence of overheating.
5. After servicing, see that all the protective devices such as insulation barriers, insulation papers, shields and isolation R-C combinations are correctly installed.
6. When the receiver is not being used for a long time of period of time, unplug the power cord from the AC outlet.
7. After servicing make the following leakage current checks to prevent the customer from being exposed to shock hazard.

LEAKAGE CURRENT COLD CHECK

1. Unplug the AC cord and connect a jumper between the two prongs of the plug.
2. Turn the receiver's power switch on.
3. Measure the resistance value with an ohmmeter, between the jumpered AC plug and each exposed metallic cabinet part on the receiver, such as screw heads, aerials, connectors, control shafts etc. When the

exposed metallic part a return path to the chassis the reading should be between 4Mohm and the 20Mohm. When the exposed metal does not have a return path to the chassis, the reading must be infinite.

LEAKAGE CURRENT HOT CHECK

1. Plug the AC cord directly in to the AC outlet. Do not use an isolation transformer for this check.
2. Connect a 2Kohm 10W resistor in series with an exposed metallic part on the receiver and an earth, such as a water pipe.
3. Use an AC voltmeter with high impedance to measure the potential across the resistor.
4. Check each exposed metallic part and check the voltage at the each point.
5. Reverse the AC plug at the outlet and repeat each of the above measurements.
6. The potential at the any point should not exceed 1.4 Vrms. In case a measurement is outside the limits specified, there is the possibility of a shock hazard, and the receiver should be repaired and rechecked before it is returned to the customer.

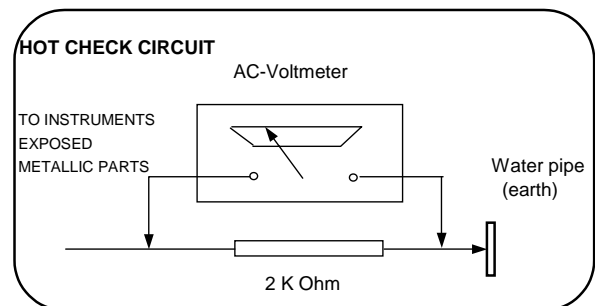

Figure 1

X-RAY RADIATION WARNING

The primary source of X-ray radiation in this receiver is the picture tube. The chassis is specially constructed to limit X-ray radiation. For continued X-ray radiation protection, replace the tube with the same type of the original one.

CAUTION

AFTER REMOVAL OF THE ANODE CAP, DISCHARGE THE ANODE OF THE PICTURE TUBE AND THE ANODE CAP TO THE METAL CHASSIS, CRT SHIELD, OR THE CARBON PAINTED ON THE CRT WITH A HIGH VOLTAGE PROBE AND MULTIMETER (SELECT VDC) AND THEN SHORT CIRCUIT DIRECTLY TO DISCHARGE COMPLETELY

2. TECHNICAL SPECIFICATIONS



Power source:	220-240V AC, 50-60Hz	
Power consumption (nom.):	73W	20", 21"
Standby power consumption :	2 W	
Aerial impedance :	75Ohm, coaxial type	
Receiving system ¹:	PAL BG PAL SECAM BG PAL SECAM BG DK PAL I	
Receiving channels:	VHF BAND I	CH2-4
	VHF BAND III	CH5-12
	CABLE TV	S1-41
	UHF BAND	CH21-69
Audio outputs :	7W RMS at %10 THD	21"
High Voltage :	25 ± 0.5 KV	21"
Focus voltage :	%25.6 ± %38 of EHT	
Grid 2 voltage :	0-1400 V	
Heater voltage :	6.2 ± 0.2 Vrms	
Video/Audio Terminals :	AV1 IN	Video : 1 Vpp,75 Ohm Audio : 0.5 Vrms, >10 Kohm RGB
	AV1OUT	Video : 1 Vpp, 75 Ohm Audio : 0.5 Vrms, <1 Kohm
	AV2 IN	Video : 1 Vpp,75 Ohm Audio : 0.5 Vrms, >10 Kohm RGB
	AV2OUT	Video : 1 Vpp, 75 Ohm Audio : 0.5 Vrms, <1 Kohm
	AV3 IN (RCA, optional)	Video : 1 Vpp, 75 Ohm Audio : 0.5 Vrms, >10 Kohm
Ambient temperature :	5°C-40 °C Degrees	
Safety :	IEC 65 /BS P2N	
X-Ray radiation :	ACC. IEC 65/BS P2N	
Disc formats:	DVD R, DVD RW, CD-R, CD-RW	
Media formats:	DVD video, audio CD, video CD (VCD 1.0/1.1/2.0), S-Video CD, CD-ROM (MP3, JPEG)	

¹ : TV set is produced to receive "one" of these colour and sound systems.

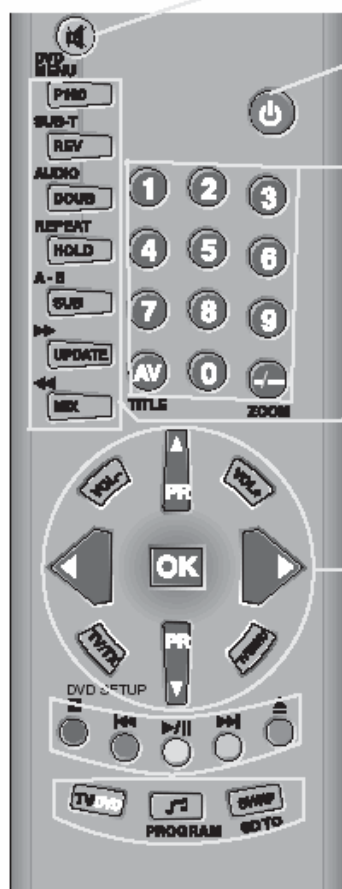
3. REMOTE CONTROL



TV operation

-  Sound on/off (mute).
-  Switches off the television set (stand-by).
- 0...9** Switches the television on from stand-by mode. Selects channels directly.
- AV** Selects the AV channels and the most recently viewed television channel.
- /--** Switches between single- and double-digit preset channels.
- P 100** Shows information on preset channels. Selects page 100 in teletext mode.
- REV** Reveals answers in teletext mode.
- DOUB** Switches to double character size in teletext mode.
- HOLD** Holds pages in teletext mode.
- SUB** Shows the time. Selects sub-pages in teletext mode.
- UPDATE** Updates the page in teletext mode.
- MIX** Selects the mix function in teletext mode (TV picture and teletext).
- VOL - +** Adjusts the volume.
- PR ▲** Switch the television on from standby.
- PR ▼** Select channels step-by-step. Move the cursor up and down.
- OK** Calls up the station list. Activates various functions.
- ◀ ▶** Move cursor to the left/right.
- TV/TX** Switches between teletext and TV modes. Hides the menu.
- TV MENU** Opens the menu. Switches to previous TV menu page.



DVD mode

- DVD MENU** During playback, opens the disc menu* of a DVD.
- SUB-T** For selecting and displaying subtitles* of the DVD during playback.
- AUDIO** Switches between the original and the dubbed language* during DVD playback.
- REPEAT** Selects repeat functions.
- A - B** For marking sections for repeated playback.
- ▶▶** Switches to forward frame search at various speeds during playback.
- ◀◀** Switches to reverse frame search at various speeds during playback.
- 0...9** Numerical keys for various inputs.
- Title** Calls up the DVD title menu* during playback.
- Zoom** Zooms in on scenes during playback.
- ◀▶** Select various functions in the menus.
- PR ▲▼**
- OK** Confirms functions.
- DVD SETUP** Opens the setup main menu of the DVD unit.
- Interrupts all drive functions.
- ◀◀** Selects the previous title or section during playback.
- ▶||** Starts playback.
Freeze-frame for DVDs and video CDs.
Pause for audio CDs and MP3 CDs.
- ▶▶** Selects the next title or section during playback.
- ▲** Opens and closes the disc compartment.
- TV/DVD** Switches the remote control and the TV from DVD mode and back.
- PROGRAM** For programming a playback list for the inserted disc.
- GO TO** Opens the info menu of DVD unit.

(*) Depends on the DVD in use.



- **Red** Sound menu button
Moves page in teletext mode.
- **Green** Picture menu button
Moves page in teletext mode.
- **Yellow** Program Table menu button
Selects a chapter in teletext mode.
- **Blue** Setup menu button
Selects a topic in teletext mode.
- **Purple** Features menu button
- TV/DVD** Switches the remote control and the TV mode to DVD mode and back.
-  Selects sound mode
- SWAP** Switches between the two most recently viewed TV channels.

Special features

- Your TV can receive stereo channels directly (NICAM optional).
- Automatic tuning system with country selection.
- 100 Programme Memory.
- Available for Cable Channels (A decoder may be required).
- Manual Fine Tuning.
- Child Lock.
- Return to the last viewed channel (SWAP).
- Spatial Sound effect.
- 16:9 picture format.
- S-Video connection (optional).
- Audio/Video RCA sockets (optional).
- Sound adjustment using one button (Smart control).
- Equalizer Sound Setup.
- Automatic Volume Limiting.
- Your TV set is equipped with an On-Screen Display system. This system enables the user to see the functions on-screen and to control them efficiently.
- Infrared Remote Control.
- Virtual Dolby Surround (optional).
- Dynamic Bass (optional).
- Multi language menu system.
- On Timer.
- Off Timer.
- Stereo headphone socket (optional).
- 2 Scart Socket: Video cassette recorder, satellite receiver, video disc player, DVD, TV games or a home computer can be connected to this AV socket with an appropriate connecting cable.
- Channel naming.
- Teletext reception.
- Automatic recognition of the broadcasting format (4:3, 16-9) via WSS feature.
- Channel editing.
- Quick Program Display.
- Alarm function (optional).
- Zoom.
- Freeze.
- MP3 Playback.
- JPEG display.
- Dolby Digital.
- Coaxial output (optional).
- Screen saver.
- SPDIF output.
- Last memory.
- Kid Safe mode.

(*): These features are not available in all models.

4. PREPARATIONS

MAIN SUPPLY CONNECTIONS

Connect the TV mains plug into your domestic mains socket outlet (230 V 50Hz AC).

Press the Program up, Program down button or Numeric Buttons on the remote handset to switch

- the TV on.



AERIAL CONNECTION

Using a 75Ω aerial lead connect your TV to the aerial outlet in your home.

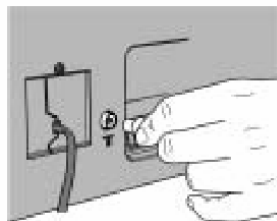

BATTERY FITTING

Insert the 2 AAA Batteries supplied into the compartment on the rear of the remote control, ensure you follow the polarity diagram inside the compartment.

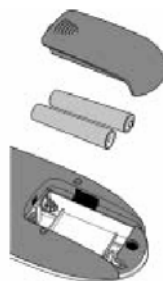

PIN CONNECTIONS FOR SCART SOCKET

- | | |
|----------------------------|-------------------------|
| 1- Audio output Right | 11- RGB input, Green |
| 2- Audio input Right | 12- |
| 3- Audio output Left(Mono) | 13- Red ground |
| 4- Audio ground | 14- Ground |
| 5- Blue ground | 15- RGB input, Red |
| 6- Audio input Left(Mono) | 16- Blanking Signal |
| 7- RGB input, Blue | 17- Video output ground |
| 8- Switching voltage | 18- Video input ground |
| 9- Green ground | 19- Video output |
| 10- | 20- Video input |
| | 21- Screening |

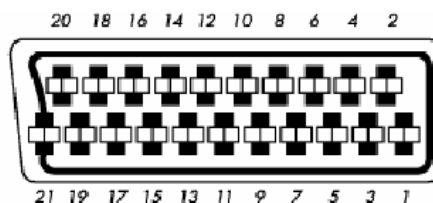

CONNECTING TV WITH VIDEO AND SATELLITE/DIGITALRECEIVER

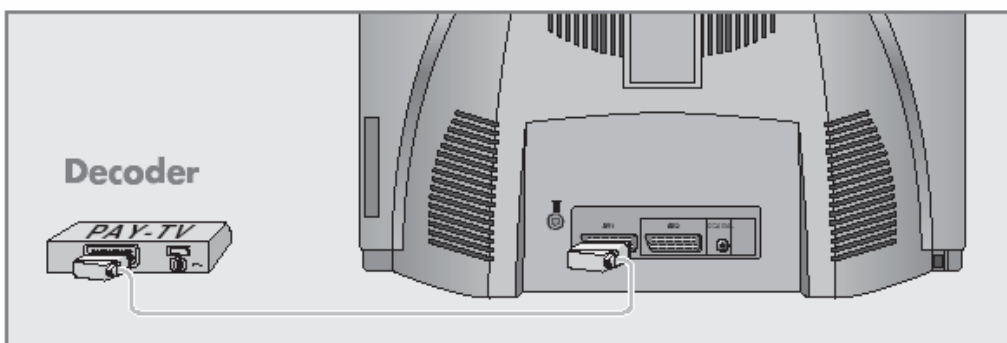

5. OPERATING YOUR TV

A. SWAP FUNCTION



Allows you to swap between the program you are watching and the last selected program. i.e. If you were watching Program 1 and change to Program 11, press the SWAP button to go back to Program 1. Press it again to return to Program 11.



B. AV



Press the AV button to select your For use when you are connecting an external source to your TV (Video recorder, DVD player etc.) via the SCART sockets or RCA sockets.

See 'Connecting external equipment'.

Press the AV button to select your input as follows:

2 Scart models:

- 1 AV1 when using SCART socket 1.
- 2 AV2 when using SCART socket 2.
- 3 AV2-S for S-Video equipment. (Optional)
- 4 AV3 when using the RCA sockets of the TV. (Optional)
- 5 AV3-S when using the S-video socket and RCA audio sockets of the TV. (Optional)

1 Scart models:

- 1 AV1 when using SCART socket 1.
- 2 AV2 when using the RCA sockets of the TV. (Optional)
- 3 AV2-S when using the S-video socket and RCA audio sockets of the TV. (Optional)



Press the AV button again to return to TV

C. TUNING THE TELEVISION

There are two ways of tuning your television:

- Manual, where you control the tuning process or Autoprogram where the television does it all automatically.
- The TV sets equipped with ATS (Automatic Tuning System) sorts the channels regarding the broadcasting system of your country (optionally).

Please Note

If the TV is set to a channel with no signal the TV will return to standby after 5 minutes. The time remaining is displayed on the screen.

Manual Tuning

Tuning the TV is accessed through the SETUP menu.

There are two ways to access the SETUP menu:



Press the blue **Setup** button or Press the **Menu** button and use the **Program down** button to select SETUP. Press the **OK** button to enter the SETUP menu.

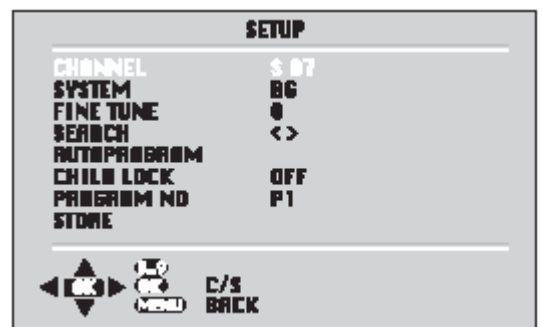

Please note

The system will displayed automatically on SYSTEM row i.e. BG, L, I, DK depending the receiving broadcasting system of the country. In some countries the broadcasting system can be both in BG/DK or BG/LL'. Only the TV sets produced with Pal Secam BG/DK or Pal Secam BG/LL' systems can receive both BG/DK or BG/LL' broadcasts. In this case the user can select the required SYSTEM using Volume up/down buttons.

Please note

If you do not press any buttons for 15 seconds the TV will exit the menu system.

In the Setup menu select PROG NO and change to P1 using the **Program down** button to select it and the **Volume up** button to change it.

Starting with Program 1, tune in the first channel as follows:

Use the **Program down** button to select SEARCH.

Press the **Volume up** or **Volume down** button to start the tuning search.

When the search finds a strong channel signal it will stop searching. The picture will appear.

Identify which channel you are watching (BBC 1, ITV 1 etc.) and decide which program number you want it to be.

Use the **Program down** button to select PROGRAM NO.

Use the **Volume up/down** buttons to select the program number.

Use the **Program down** button to select Store. Press the OK button and STORED will appear on the STORE line.

You have now stored the first channel.

Use the **Program up** button to select again SEARCH and continue the tuning procedure until you have tuned in all the programmes you want or the television can receive.

Tuning with channel numbers

Enter the SETUP menu by pressing the blue button. Press the **OK** button to enter the CHANNEL row.

Use the **OK** button to select "S" for cable channels and "C" for terrestrial broadcast.

Use **Volume up** button to select the channel number buttons.

Enter the channel number using the Numeric buttons.

Press the **Program down/up** buttons to exit the channel row.

Use the **Program down** button to select PROGRAM NO.

Use the **Volume up/down** buttons to select the program number.

Use the **Program down** button to select STORE. Press the **OK** button and STORED will appear on the STORE line.

You have now stored the first channel.

Use the **Program up** button to select again SEARCH and continue the tuning procedure until you have tuned in all the programmes you want or the television can receive.

To exit the SETUP menu press the TV/TX button.

Automatic tuning (Autoprogram)

Enter the SETUP menu as before.

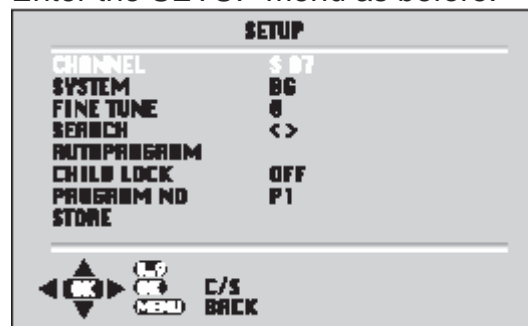



Use the Program down button to select AUTOPROGRAM and the **OK** button. A list of Press countries will appear. Select the desired country using **Program** and **Volume** buttons.



When you are sure the aerial is connected properly press the **OK** button. Autoprogram will start.

To cancel Autoprogram while it is working press the **Menu** button.

Your TV is now tuned and ready to use.

Please note:

If auto sort fails to arrange the programmes in the required sequence please refer to programme table.

Fine tuning

Although the search and Autoprogram will automatically try and tune to the best reception, in areas of poor reception a bit of fine tuning may be required.



In the SETUP menu use the Program up/down buttons to select FINE TUNE. Use the Volume up and Volume down buttons to fine tune.

When you have finished use the **Program down** button to select STORE and press the **OK** button.

D. FEATURES

1-) TV GUIDE(Optional)

You can see the TV Guide information on the screen by pressing "**DOUB**" button while a provider channel or a supported channel by provider is selected. The information of the current and next programmes which is sent by provider is displayed on the screen.

Note: TV Guide information may not have for all programmes. It depends on the broadcasting and determined by broadcasting company.

Note: TV Guide is not displayed on the screen, if there is not a provider in the saved channels.



DATE: Date information is given by provider channel. You can use the numeric buttons to change the date.

PROVIDER: Provider is the channel which send the TV Guide information. You can select the provider via this function. Press **Volume up/down** buttons to select the provider and then press "**OK**".



STATION MATCH: The supported channels by provider may not be defined automatically. You can open this menu and define the provider for these channels. Adjusting the provider just one time is enough for these channels.



DISPLAY INFO: If you want to see the TV Guide information automatically while changing the channels, this option should be open. In this case, if you open the provider channel Mini Guide occurs on the screen.



2-) PAT (Picture and Text) (OPTIONAL)

In the double window function, you can also display the teletext screen in the second window.

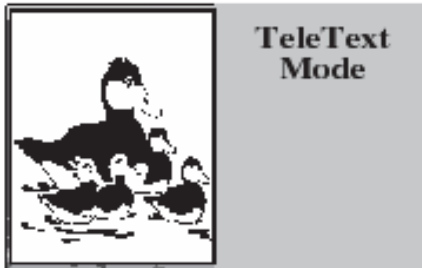

3-) PIP Picture Position Change



Press the **POS** button repeatedly until desired position is achieved. The PIP picture moves clockwise.

DVD Mode

Special DVD features

Your DVD player provides you with perfect digital video playback of studio quality.

It also provides superb cinema-quality audio playback – in stereo or with digital multi-channel sound – depending on the type of DVD and audio system or stereo television.

Other features of DVD video include the choice of audio channel and language, choice of subtitle language, and various camera recording angles. Your DVD player is suitable for DVDs with regional code 2.

As well as DVDs, it can also play MP3 CDs, JPEG coded (photo) CDs, video CDs, S-video CDs and audio CDs.



Disc formats

Your DVD player can play back CD-R, CD-RW, VCD 2.0, Super-VCD, DVD R, DVD RW discs.

Due to the difference in quality of the recording media and the quality of the recording itself, it can occasionally happen that a home-made DVD or CD cannot be read. This does not indicate a malfunction of the DVD player.

You have to finalize your own CD-R and CD-RW recordings.

Note that the settings of your CD burning program must meet the ISO 9660 standard in order to create a CD-R or CD-RW.

When MP3 or JPEG CDs are played back, individual tracks/pictures may be skipped or incorrectly played back and displayed. This can be due to the disc configuration, the encoder software or the hardware used for the recording.

Audio CDs (CDDA) correspond to the specification and bear the corresponding logo. Copy-protected CDs do not meet this specification and do not bear the corresponding logo. These CDs can cause playback errors.



Preparation

Switching on

- 1 Switch on the television and press »TV/DVD« to select DVD mode.
- 2 If an audio system or an AV receiver is connected to the device, switch it on and select the audio input for the device.

Inserting a disc

- 1 Open the disc compartment by pressing »▲«. – The disc compartment opens.
- 2 Insert the disc you want to play in the disc compartment with the label facing upwards.
- 3 Close the disc compartment with »▲«. – The disc tray retracts again and the disc is scanned.

Notes:

Playback of a DVD, VCD, SVCD or audio CD (CDDA) starts automatically.

The file browser appears if an MP3 CD is inserted.

If the »⊘« symbol appears on the television screen, the selected function is not possible with this disc.

Removing discs

- 1 Press »▲« to open the compartment and take out the disc.

DVD Mode

DVD features



You can recognise a DVD by the logo on the label.

Depending on the content of the DVD, the discs contain one or more titles.

Each title may contain one or more chapters. Titles and chapters can be selected easily and conveniently.

You can control the direct playback of a DVD using the menu of the DVD player on the television screen.

Special DVD features

DVDs have a title menu which provides an overview of the available titles and the passages they contain.

Some of the DVD player's functions, such as slow motion, freeze-frame and auto-play, can also be controlled by the DVD itself. It is therefore possible that the freeze-frame function, for example, cannot be selected during certain scenes.

Many DVDs have audio tracks recorded in up to eight languages. This enables you to select the language you prefer.

Many DVDs are recorded by the manufacturer with subtitles in several languages. You can select subtitles from up to 32 different languages.

Since films are released in different parts of the world at different times, all DVD players world-wide are given a regional code. The regional code for your DVD player is 2.

DVDs may also be given a supplementary regional code. If you insert a DVD with a code different to that of the DVD player, a reference to the regional code appears on the television screen.

The DVD player will not be able to play back the DVD.

S-VCD/VCD features



You can recognise S-VCD/VCDs (video CDs) by the logo on the label.

Depending on the contents of the S-VCD/VCD (films, music videos etc.), the discs may carry one or more tracks.

Like audio CDs, S-VCDs/VCDs have a track structure.

S-VCDs/VCDs can be created using the PBC (playback control) system for track navigation. This depends on the processing and burning software used.

You can control the direct playback of the S-VCD/VCD using the menu on the television screen.

You cannot select some of the functions (slow motion, camera angle, marking scenes) when you are playing an S-VCD/VCD. This depends on how the S-VCD/VCD was created.

Depending on how they were created, S-VCDs can have various subtitles and dubbed languages.

DVD Mode

MP3 CD features



MP3 stands for MPEG-1 Audio Layer 3 and arises from the Motion Picture Expert Group (MPEG) Standard which was developed for compressing film data.

The MP3 format enables audio files to be saved on a computer with a sound quality similar to that of a CD. This only requires approx. 10% of the original data quantity. The standard encoding bit rate for MP3 files is 128 kbps. Generally, the higher the bit rate of a an MP3 file, the better the sound quality.

Most MP3 files on the Internet are encoded at 128 or 160 kbps. 160 kbps is considered CD quality.

MP3 files can be downloaded from the Internet and then burned onto a CD-ROM disc. Your DVD player can read the ID3 tag from the file header, which contains information on title and artist, and display this in the info menu/status display.

MP3 CDs contain sound recordings. They can be played in the normal manner on an audio system. The digital signals transmitted during MP3 playback are PCM coded, regardless of the audio output setting. The signals are output with the same data rate as the music source (possibilities are: 32 kbps – 320 kbps, ideal: 128 kbps).

MP3 files can be organised into folders and subfolders, similar to files within a PC.

JPEG CD features

JPEG stands for Joint Picture Experts Group. This process was designed to compress picture files.

JPEG files can be burned onto a CD along with other file types.

Such CDs are known as file CDs or mixed mode CDs. For example, the CD could contain MP3 files (audio) and JPEG files (for example to display album covers).

The files on a JPEG CD can be organised in directories. This structure is similar to that of an MP3 CD.

JPEG CDs only contain data in from of the compressed JPEG format. This is mostly data from digital cameras or from imaging programs. The data (images) can be displayed individually or in sequence in a slide show.

Audio CD features



An audio CD is identified by this logo. Audio CDs contain only sound recordings. They can be played in the normal manner on an audio system.

The individual tracks are stored in a sequence. There are no folders.

DVD Mode

Using a DVD, Video CD or Audio CD

Depending on the disc being used, some functions may not be available.

Playing back a title

1 After the disc compartment closes and the disc is scanned, playback starts automatically.

2 To pause playback (freeze-frame), press »▶/||«.

3 Press »▶/||« to resume playback.

4 Press »■« to end playback.

Note:

Depending on the disc being used, you may have to select chapters or titles on the disc using »PR ▲«, »PR ▼«, »◀« or »▶« and press »OK« to activate the or »▶/||« to start playback.

Calling up information*

You can call up information on the title, chapter and playing time for display on the screen.

1 Press »GO TO« to display the info menu.
– You will see information on:

Title 01/02 The current title and available titles

Chapter 03/18 The current chapter and available chapters

Selecting titles and chapters using the disc menu*

If a disc contains several titles and/or chapters, you can select them. If a disc contains several tracks/chapters, this can be seen by »Title« and »Chapter« in the info menu.

1 Call up the contents of the disc with »DVD MENU« (Disc Menu) or »TITLE« (Title Menu).
– If the disc has a title menu it will appear on the screen.

2 Select tracks or chapters with »PR ▲«, »PR ▼«, »◀« or »▶« and activate with »OK«.
– Playback of the selected title or chapter begins.

Selecting titles directly with the numerical buttons.

Press the GOTO button twice, enter the number of the title or chapter or time with »1...0« and press »OK« button to confirm.

DVD Mode

Selecting chapters in steps (SKIP)

- 1 To select the next chapter, press »▶▶« during playback.
- 2 Press »◀◀« to select the previous chapter.
– Playback of the selected chapter begins.

Pausing and resuming playback

The playback of a DVD can be interrupted at any point and then resumed from the same place.

- 1 Interrupt playback by pressing »■« once only.
- 2 Press »▶||« to resume playback at the point where it was interrupted.

Ending playback

You can stop playback at any point by pressing »■« twice.

Additional functions during DVD or video CD playback

Notes:

The sound is muted during the “Frame search”, “Slow motion” and “Freeze-frame” functions. Depending on the disc, some functions cannot be selected.

Frame search

Several different speeds are available.

- 1 Select the playback speed during playback by pressing »◀◀« or »▶▶«.
- 2 Press »▶||« to resume playback.

Slow motion

You can choose between different speeds (1/2, 1/4, 1/6, 1/8 forwards or reverse).

- 1 Press »▶||« during playback.
- 2 Select the slow motion speed by pressing »◀◀« or »▶▶«.
- 3 Press »▶||« to resume playback.

Enlarging the picture (zoom)

This function allows you to enlarge various picture sections. The picture enlargement options are selected in the sequence: Q1, Q2, Q3, Q4.

- 1 During playback or pause, press »ZOOM« repeatedly.
– Display: e.g. »Q1«, part of the picture is enlarged.
- 2 Move the picture section on the screen with »PR ▲« »PR ▼«, »◀◀« or »▶▶«.
- 3 Switch back to “normal” picture size with »ZOOM«.

DVD Mode

Switching the dubbed language or the audio format

These settings switch away from the preset dubbed language, if the DVD offers any alternatives.

1 Press »**AUDIO**« during playback.
– Display: e.g. »1/3: AC 3 5.1CH German« is displayed briefly, the dubbed language currently selected is displayed.
In this example: the first of 3 possible dubbed languages, sound format 5.1.

2 Keep pressing »**AUDIO**« to select the dubbed language.

Note:

Switching the dubbed language can be suppressed by the structure of the disc itself. In this case the setting is usually made in the disc menu.

Selecting and displaying subtitles

If the disc provides subtitles, they can be displayed on your TV screen.
When subtitles are available in several languages, you can select your preferred language.

1 Press »**SUB-T**« during playback.
– Display: e.g. »02/20 German« is briefly displayed, and the current subtitle is displayed.

2 Keep pressing »**SUB-T**« to select the subtitle language.

Notes:

To switch off the subtitles, keep pressing »**SUB-T**« until »Off« appears on the display.

Switching the subtitles can be suppressed by the structure of the disc itself. In this case the setting is usually made in the disc menu.

Using an MP3 CD playback

1 After the disc compartment has closed and the MP3 CD has been scanned, the File Browser (Contents menu) of the disc is displayed and start playback.

2 Press »▶/||« to pause playback.

3 Press »▶/||« to resume playback.

4 End playback by pressing »■«

Using a JPEG CD playback

1 After the disc compartment has closed and the JPEG CD has been scanned and start to playback.

2 Press the »■« button and a will appear File Browser menü.

3 Press »PR ▲« »PR ▼« to select the track you want to hear and then »OK« to start playback.

4 Press »▶/||« to pause playback.

5 Press »▶/||« to resume playback.

6 End playback by pressing »■«

Selecting specific tracks using the numerical buttons

During playback, select the track with »1 ... 0« or »PR ▲«, »PR ▼« or »▶«, »◀« and press »OK« to confirm.

– Playback begins with the selected track.

Selecting a track in steps (SKIP)

1 Select the next track by pressing »▶▶« during playback.

2 Select the previous track by pressing »◀◀«.
– Playback begins with the selected track.

DVD Mode

Additional JPEG CD playback functions

Adjusting the picture display

The pictures can be rotated or reversed.

- 1 During playback, press »GOTO« to rotate the pictures by 90°.
- 2 Press »■« to end playback.

Enlarging the picture (zoom)

This function enables you to enlarge sections of the picture and move them on the screen.

- 1 During playback or pause, press »ZOOM«.
- 2 Switch back to "normal" picture size with »ZOOM«.

Repeat functions

Repeating a selected scene (A-B Repeat)
You can mark the start and end of a scene, this is then played back repeatedly.

- 1 During playback, mark the beginning of the scene by pressing »A-B«.
- 2 To mark the end of the scene, press »A-B« again.
– The scene is repeated over and over.
- 3 Press »A-B« again to quit the function.

Repeating a chapter, a title or a disc DVD.

These functions repeat the chapter or the title currently playing or the entire DVD.

- 1 Press »REPEAT« during playback.
– Display: »Chapter«, the chapter is repeated.
- 2 During playback, press »REPEAT« twice.
– Display: »Title« and the title is repeated.
- 3 During playback, press »REPEAT« three times.
– Display: »All« and the entire disc is repeated.
- 4 Press »REPEAT« again to quit the function.
– No display.

Repeating a chapter, a title or a disc JPEG, MP3, AUDIO, VCD

These functions repeat the chapter or the title currently playing or the entire JPEG, MP3, AUDIO and VCD.

- 1 Press »REPEAT« during playback.
– Display: »Single«, the chapter is repeated.
- 2 During playback, press »REPEAT« twice.
– Display: »All« and the title is repeated.
- 3 During playback, press »REPEAT« three times.
– Display: »Off« and the entire disc is not repeated.

Creating and playing a playlist

This function enables you to create a playback list for all types of discs.

Up to 12 titles, chapters or tracks can be stored.

- 1 Place a disc in the tray.
- 2 Open the »Program« menu by pressing »PROGRAM«.
– Depending on the type of disc in use the program menu appears, and item 1 is marked.
- 3 Enter the two-digit number of the title, chapter or track with »1... 0«.

Program Input		Title/Chapter	
1 ---	4 ---	7 ---	10 ---
2 ---	5 ---	8 ---	11 ---
3 ---	6 ---	9 ---	12 ---
Play Program		Clear All	

- 4 To start playback, select »Play Program«.
– Playback of the program starts.
- 5 Press »■« to end playback.

DVD Settings

No settings are necessary for operating the DVD unit of the television set.

However, in the »DVD SETUP« menu you can change the language, select audio, video, features and adjust many other settings.

Selecting the menu

- 1 Press »DVD SETUP« to call up the menu.
– The »DVD SETUP« menu appears.
 - 2 Select the menu with »◀« or »▶« and press »OK« to confirm.
 - 3 Select the item with »PR ▲« or »PR ▼« and press »OK« to confirm.
– The setting options are displayed.
 - 4 Select the sub function or setting using »PR ▲« or »PR ▼« and press »OK« to confirm.
- Note:**
Press »OK« to go back one level.
- 5 Press »DVD SETUP« to quit the menu.

Menu options

DVD Setup Menu

- Installation: – Select the language.
- Picture: – Select the Picture settings with this menu.
- Sound: – Select the Sound settings with this menu.
- Child Lock: – Select the Child Lock setting with this menu.

Language Menu

Installation	Picture	Sound	Child Lock
Player Language	English		
Subtitle	Auto		
Audio Language	Auto		
Menu Language	Auto		
Display Function	Off		

- Player Language: – Select the on-screen menu language.
- Subtitle: – Select the Subtitle language.
- Audio Language: – Select the Audio language.
- Menu Language: – Select the Menu language.
- Display Function: – Activate / Deactivate

DVD Settings

Picture

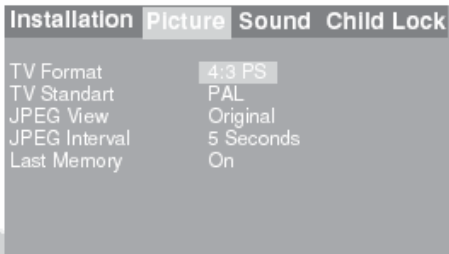

- TV Format:- Set the picture format
- TV Standart:- Select the TV standart
- JPEG View:- Select JPEG Viewing mode
- JPEG Interval:- Select the transition time
- Last Memory:- Avtivate / Deactivate

Sound

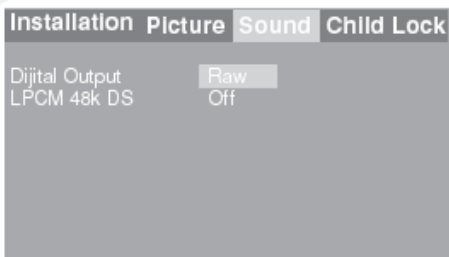

- Digital Output:- Set digital output
- LPCM 48k DS:- Set scanning rate

Child Lock

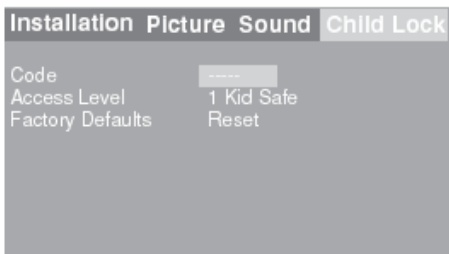

- Code:- Enter the password
- Access Level:- Select content control
- Factory Defaults:- Return to factory settings

K1 CHASSIS BLOCK DIAGRAM

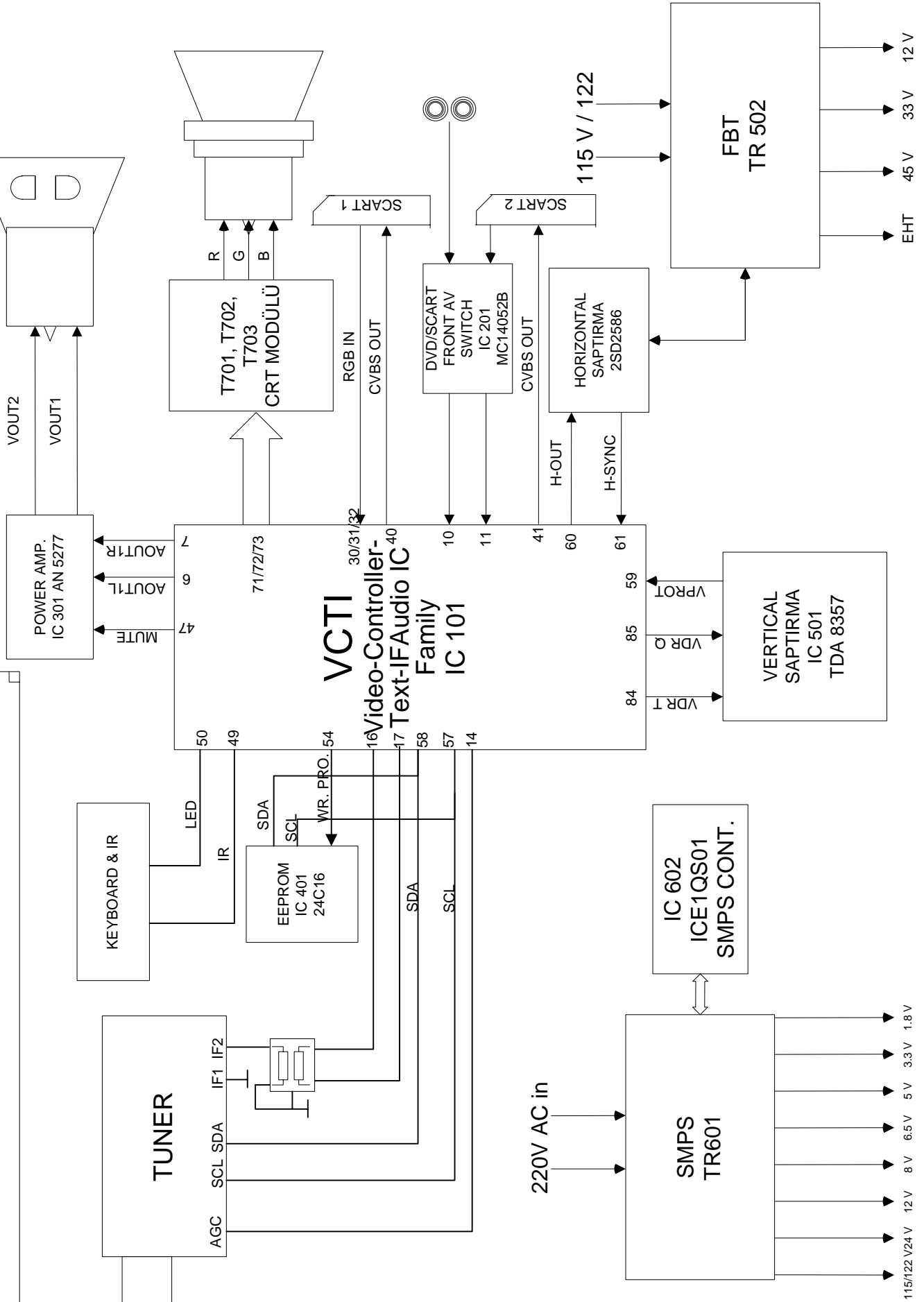

7.1)VCT 49XYI GENERAL DECRPTION

The VCT 49xyl is an IC family of high-quality singlechip TV processors. Modular design and deep-submicron technology allow the economic integration of features in all classes of single-scan TV sets. The VCT 49xyl family is based on functional blocks contained and approved in existing products like DRX 396xA, MSP 34x5G, VSP 94x7B, DDP 3315C, and SDA 55xx. Each member of the family contains the entire IF, audio, video, display, and deflection processing for 4:3 and 16:9 50/60-Hz mono and stereo TV sets. The integrated microcontroller is supported by a powerful OSD generator with integrated Teletext & CC acquisition including on-chip page memory.

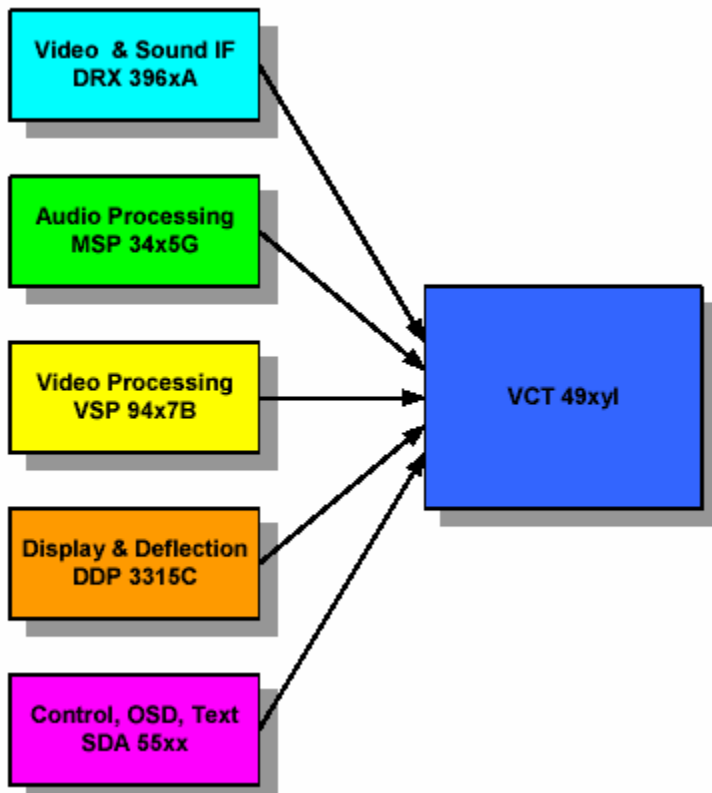

- Single 20.25 MHz reference crystal
- 8-bit 8051 instruction set compatible CPU
- Up to 256 kB on-chip program ROM
- WST, PDC, VPS, and WSS acquisition
- Closed Caption and V-chip acquisition
- Up to 10 pages on-chip teletext memory
- Multi-standard QSS IF processing with single SAW
- FM Radio and RDS with standard TV tuner
- TV-sound demodulation:
 - all A2 standards
 - all NICAM standards
 - BTSC/SAP with MNR (DBX optional)
 - EIA-J
- Baseband sound processing for loudspeaker channel:
 - volume and balance

Features

- The VCT 49xyl family offers a rich feature set, overing the whole range of state-of-the-art 50/60-Hz TV applications.
- PSSDIP88-1/-2 package
 - PMQFP144-2 package
 - Submicron CMOS technology
 - Low-power standby mode

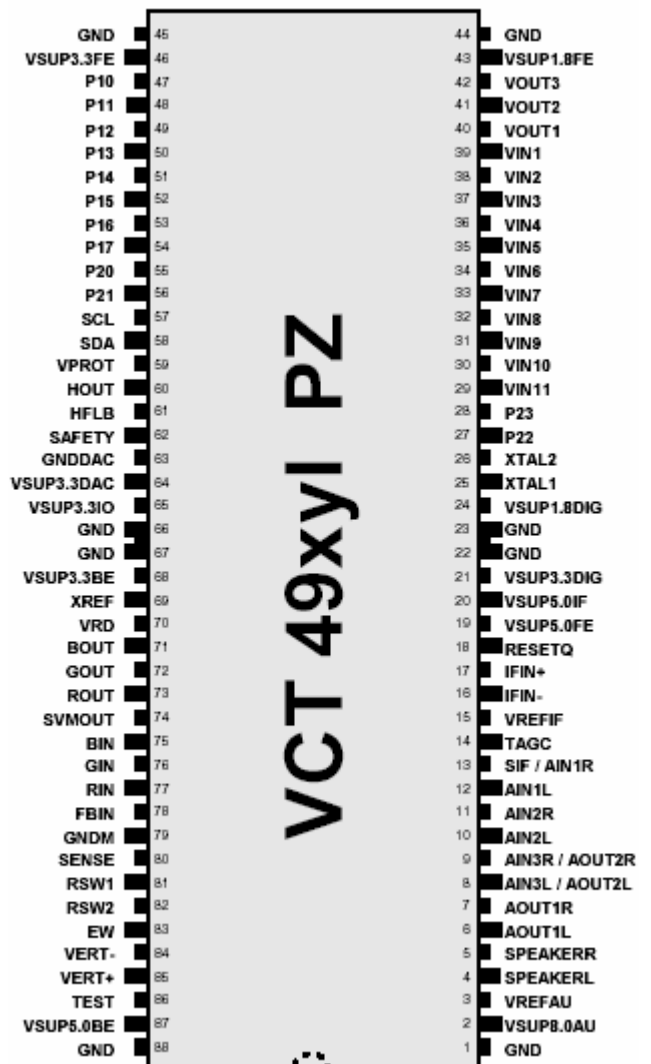

- bass/treble or equalizer
- loudness and spatial effect (e.g. pseudo stereo)
- Micronas AROUND (virtual Dolby optional)
- Micronas BASS
- further optional and licence requiring sound enhancements as BBE, SRS Wow and Micronas

VOICE

- CVBS, S-VHS, YCrCb and RGB inputs
- 4H adaptive comb filter (PAL/NTSC)
- multi-standard color decoder (PAL/NTSC/SECAM)
- Nonlinear horizontal scaling “panorama vision”
- Luma and chroma transient improvement (LTI, CTI)
- Non-linear color space enhancement (NCE)
- Dynamic black level expander (BLE)
- Scan velocity modulation output
- Soft start/stop of H-drive
- Vertical angle and bow correction
- Average and peak beam current limiter
- Nonlinear and dynamic EHT compensation
- Black switch off procedure (BSO)

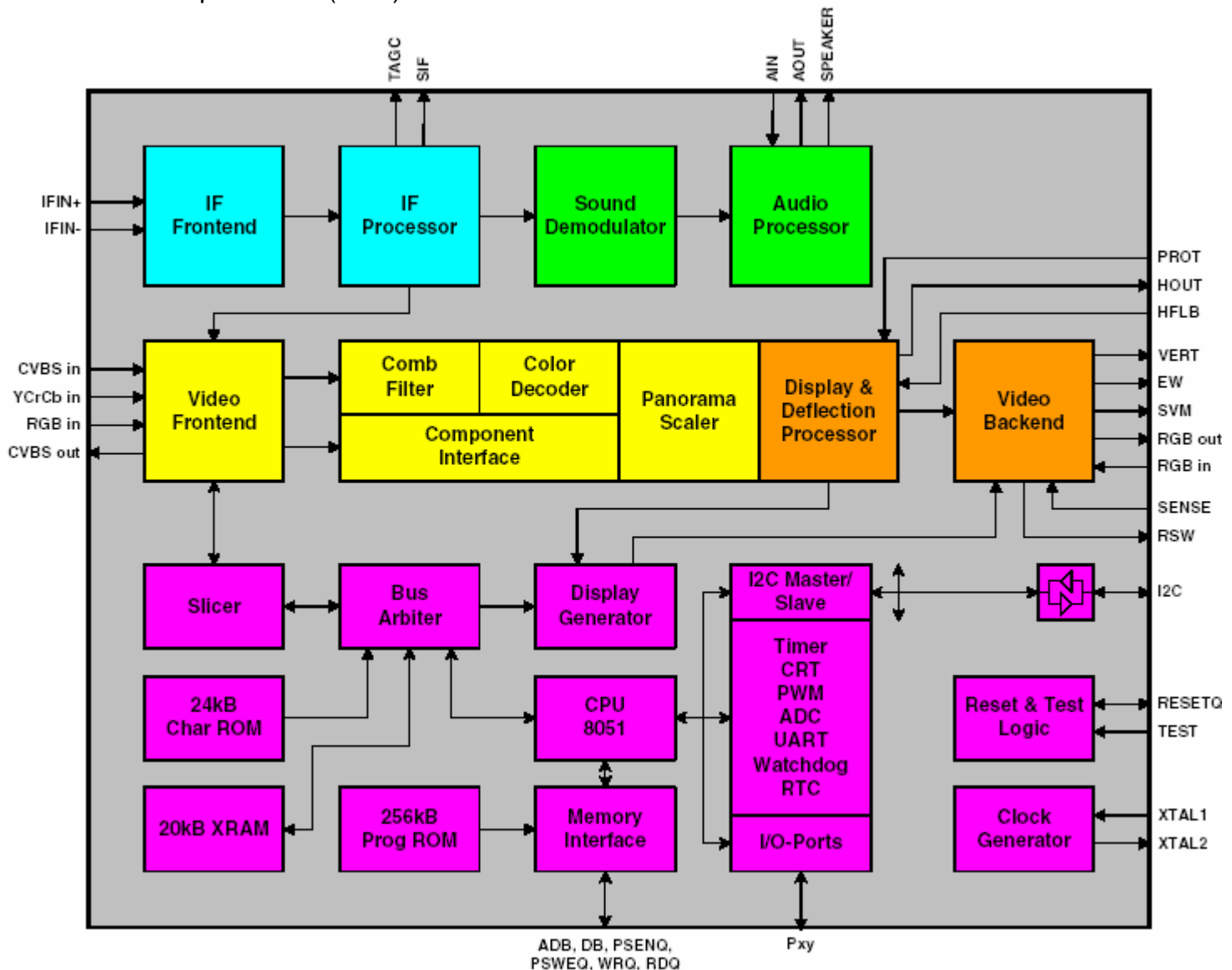

PIN CONNECTIONS AND SHORT DESCRIPTIONS

NC = not connected
 LV = if not used, leave vacant
 OBL = obligatory; connect as described in circuit diagram
 IN = Input Pin
 OUT = Output Pin
 SUPPLY = Supply Pin

Pin No	Pin Name	Type	Connection (If not used)	Short Description
1	GND	SUPPLY	OBL	Ground Platform
2	VSUP8.0AU	SUPPLY	OBL	Supply Voltage Analog Audio, 8.0 V
3	VREFAU		OBL	Reference Voltage, Audio
4	SPEAKERL	OUT	LV	Analog Loudspeaker Output, Right
5	SPEAKERR	OUT	LV	Analog Loudspeaker Output, Right
6	AOUT1L	OUT	LV	Analog Audio 1 Output, Left
7	AOUT1R	OUT	LV	Analog Audio 1 Output, Right
8	AIN3L/AOUT2L	IN/OUT	LV	Analog Audio 3 Input, Left / Analog Audio 2 Output, Left
9	AIN3R/AOUT2R	IN/OUT	LV	Analog Audio 3 Input, Right / Analog Audio 2 Output, Right
10	AIN2L	IN	GND	Analog Audio 2 Input, Left
11	AIN2R	IN	GND	Analog Audio 2 Input, Right
12	AIN1L	IN	GND	Analog Audio 1 Input, Left
13	AIN1R/SIF	IN/OUT	GND	Analog Audio 1 Input Right/Analog 2nd Sound IF Output
14	TAGC	OUT	LV	Tuner AGC Output
15	VREFIF		OBL	Reference Voltage, IF ADCs
16	IFIN-	IN	VREFif	Differential IF Input
17	IFIN+	IN	VREFif	Differential IF Input
18	RESETQ	IN/OUT	OBL	Reset Input/Output
19	VSUP5.0FE	SUPPLY	OBL	Supply Voltage Analog IF Front-end, 5.0 V
20	VSUP5.0IF	SUPPLY	OBL	Supply Voltage IF ADC, 5.0 V
21	VSUP3.3DIG	SUPPLY	OBL	Supply Voltage Digital Core, 3.3 V
22	GND	SUPPLY	OBL	Ground Platform
23	GND	SUPPLY	OBL	Ground Platform
24	VSUP1.8DIG	SUPPLY	OBL	Supply Voltage Digital Core, 1.8 V (main and stand by supply)
25	XTAL1	IN	OBL	Analog Crystal Input
26	XTAL2	OUT	OBL	Analog Crystal Output
27	P22	IN/OUT	LV	Port 2, Bit 2 Input/Output
28	P23	IN/OUT	LV	Port 2, Bit 3 Input/Output
29	VIN11	IN	GND	Analog Video 11 Input
30	VIN10	IN	GND	Analog Video 10 Input
31	VIN9	IN	GND	Analog Video 9 Input
32	VIN8	IN	GND	Analog Video 8 Input
33	VIN7	IN	GND	Analog Video 7 Input
34	VIN6	IN	GND	Analog Video 6 Input
35	VIN5	IN	GND	Analog Video 5 Input
36	VIN4	IN	GND	Analog Video 4 Input
37	VIN3	IN	GND	Analog Video 3 Input
38	VIN2	IN	GND	Analog Video 2 Input
39	VIN1	IN	GND	Analog Video 1 Input
40	VOUT1	OUT	LV	Analog Video 1 Output
41	VOUT2	OUT	LV	Analog Video 2 Output
42	VOUT3	OUT	LV	Analog Video 3 Output

43	VSUP1.8FE	SUPPLY	OBL	Supply Voltage Analog Video Front-end, 1.8 V (main and stand by supply)
44	GND	SUPPLY	OBL	Ground Platform
45	GND	SUPPLY	OBL	Ground Platform
46	VSUP3.3FE	SUPPLY	OBL	Supply Voltage Analog Video Front-end, 3.3 V (main and stand by supply)
47	P10	IN/OUT	LV	Port 1, Bit 0 Input/Output
48	P11	IN/OUT	LV	Port 1, Bit 1 Input/Output
49	P12	IN/OUT	LV	Port 1, Bit 2 Input/Output
50	P13	IN/OUT	LV	Port 1, Bit 3 Input/Output
51	P14	IN/OUT	LV	Port 1, Bit 4 Input/Output
52	P15	IN/OUT	LV	Port 1, Bit 5 Input/Output
53	P16	IN/OUT	LV	Port 1, Bit 6 Input/Output
54	P17	IN/OUT	LV	Port 1, Bit 7 Input/Output
55	P20	IN/OUT	LV	Port 2, Bit 0 Input/Output
56	P21	IN/OUT	LV	Port 2, Bit 1 Input/Output
57	SCL	IN/OUT	OBL	I ² C Bus Clock Input/Output
58	SDA	IN/OUT	OBL	I ² C Bus Data Input/Output
59	VPROT	IN	GND	Vertical Protection Input
60	HOUT	OUT	LV	Horizontal Drive Output
61	HFLB	IN	HOUT	Horizontal Flyback Input
62	SAFETY	IN	GND	Safety Input
63	GNDDAC	SUPPLY	OBL	Ground Video DACs
64	VSUP3.3DAC	SUPPLY	OBL	Supply Voltage Video DACs, 3.3 V
65	VSUP3.3IO	SUPPLY	OBL	Supply Voltage I/O Ports, 3.3 V (main and Standby supply)
66	GND	SUPPLY	OBL	Ground Platform
67	GND	SUPPLY	OBL	Ground Platform
68	VSUP3.3BE	SUPPLY	OBL	Supply Voltage Analog Video Back-end, 3.3 V
69	XREF		OBL	Reference Current for RGB DACs
70	VRD		OBL	Reference Voltage for RGB DACs
71	BOUT	OUT	VSUP5.0BE	Analog Blue Output
72	GOOUT	OUT	VSUP5.0BE	Analog Green Output
73	ROUT	OUT	VSUP5.0BE	Analog Red Output
74	SVMOUT	OUT	VSUP5.0BE	Scan Velocity Modulation Output
75	BIN	IN	GND	Analog Blue Input, Back-end
76	GIN	IN	GND	Analog Green Input, Back-end
77	RIN	IN	GND	Analog Red Input, Back-end
78	FBIN	IN	GND	Fast Blank Input, Back-end
79	GNDM	IN	GND	Reference Ground for Sense ADC
80	SENSE	IN	GND	Sense ADC Input
81	RSW1	OUT	LV	Range Switch 1 Output
82	RSW2	OUT	LV	Range Switch 2 Output
83	EW	OUT	GND	Vertical Parabola Output
84	VERT-	OUT	GND	Differential Vertical Sawtooth Output
85	VERT+	OUT	GND	Differential Vertical Sawtooth Output
86	TEST	IN	GND	Test Input, reserved for Test
87	VSUP5.0BE	SUPPLY	OBL	Supply Voltage Analog Video Back-end, 5.0 V
88	GND	SUPPLY	OBL	Ground Platform

7.2)TDA 8357

GENERAL DESCRIPTION

The TDA8357J is a power circuit for use in 90° and 110° colour deflection systems for 25 to 200 Hz field frequencies, and for 4 : 3 and 16 : 9 picture tubes. The IC contains a vertical deflection output circuit, operating as a high efficiency class G system. The full bridge output circuit allows DC coupling of the deflection coil in combination with single positive supply voltages. The IC is constructed in a Low Voltage DMOS (LVDMOS) process that combines bipolar, CMOS and DMOS devices. DMOS transistors are used in the output stage because of absence of second breakdown.

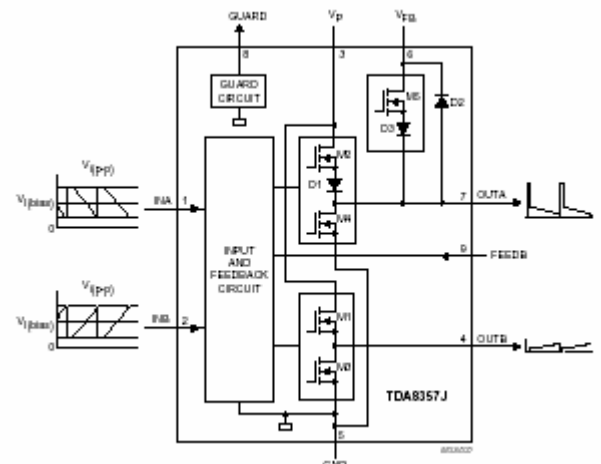

FEATURES

- Few external components required
- High efficiency fully DC coupled vertical bridge output circuit
- Vertical flyback switch with short rise and fall times
- Built-in guard circuit
- Thermal protection circuit
- Improved EMC performance due to differential inputs

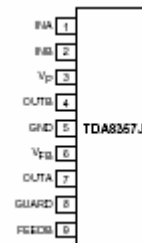

SYMBOL	PARAMETERS	CONDITIONS	MIN.	TYP.	MAX	UNIT
Supplies						
Vp	Supply voltage		7.5	12	18	V
VFB	flyback supply voltage		2 x VP	45	66	V
Iq(P)(av)	average quiescent supply current	during scan	-	10	15	mA
Iq(FB)(av)	Iq(FB)(av)	during scan	-	-	10	mA
Ptot	total power dissipation		-	-	8	W
Inputs and outputs						
Vi(p-p)	input voltage (peak-to-peak value)		-	1000	1500	mV
Io(p-p)	output current (peak-to-peak value)		-	-	2.0	A
Flyback switch						
Io(peak)	maximum (peak) output current	t ≤ 1.5 ms	-	-	± 1.2	A
Thermal data; in accordance with IEC 60747-1						
Tstg	storage temperature		-55	-	+150	°C
Tj	junction temperature		-	-	+150	°C

7.3)MC14052B

The MC14052B analog multiplexer is a digitally–controlled analog switch. The MC14052B effectively implements a DP4T solid state switch. This device's feature low ON impedance and very low OFF leakage current. Control of analog signals up to the complete supply voltage range can be achieved.

- Triple Diode Protection on Control Inputs
- Switch Function is Break Before Make
- Supply Voltage Range = 3.0 Vdc to 18 Vdc

PIN ASSIGNMENT

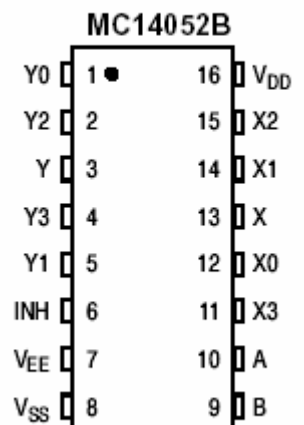

- Analog Voltage Range ($V_{DD} - V_{EE}$) = 3.0 to 18 V Note: V_{EE} must be $_ V_{SS}$
- Linearized Transfer Characteristics
- Low-noise – 12 nV//Cycle, $f . 1.0$ kHz Typical

This device contains protection circuitry to guard against damage due to high static voltages or electric fields. However, precautions must be taken to avoid applications of any voltage higher than maximum rated voltages to this high-impedance circuit. For proper operation, V_{in} and V_{out} should be constrained to the range $V_{SS} _ (V_{in} \text{ or } V_{out}) _ V_{DD}$. Unused inputs must always be tied to an appropriate logic voltage level (e.g., either V_{SS} , V_{EE} or V_{DD}). Unused outputs must be left open.

7.4)AN5277(Dual Channel SEPP Power Amplifier)

The AN5277 is a monolithic integrated circuit designed for 10.0 W (26 V, 8 W)output audio power amplifier. It is a dual channel SEPP IC suitable for stereo operation in TV application.

Features

- Few external components :
- No Boucherot cells(output C, R)
- No Bootstrap Capacitors
- No Negative Feedback Capacitors
- Built-in muting circuit
- Built-in standby circuit
- Built-in various protection circuits (Load-short, thermal, over-voltage and current)
- High ripple rejection(55 dB)
- Compatible with AN5275, AN5276
- Operating voltage range 10 ~ 32 V(26 V typ.)

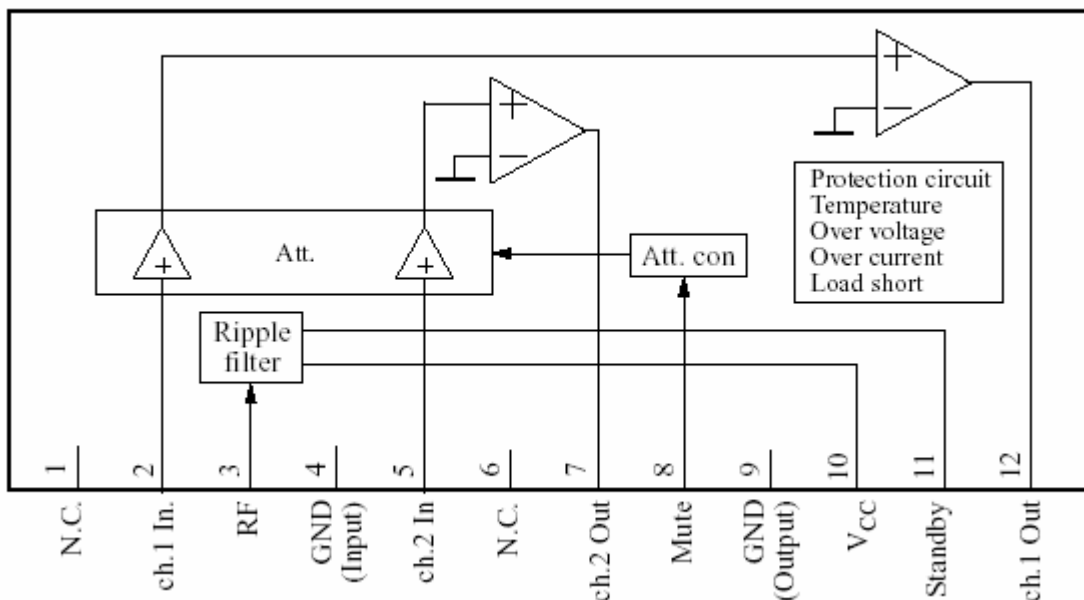

7.5)ICE1QS01(Controller for Switch Mode Power Supplies Supporting Low Power Standby and Power Factor Correction (PFC))

Features

- Line Current Consumption with PFC
- Standby Input Power < 1 W
- Stable Standby Frequency

- Low Power Consumption
- Very Low Start-up Current
- Soft-Start for noiseless Start-up
- Standby Burst Mode with and without Control Signal for lowered Output Voltages
- Digital Frequency Reduction in small Steps at Decreasing Load
- Over- and Undervoltage Lockout
- Switch Off at Mains Undervoltage
- Mains Voltage Dependent Fold Back Point Correction
- Ringing Suppression Time Controlled from Output Voltage
- Easy Design In
- Free usable Fault Comparator

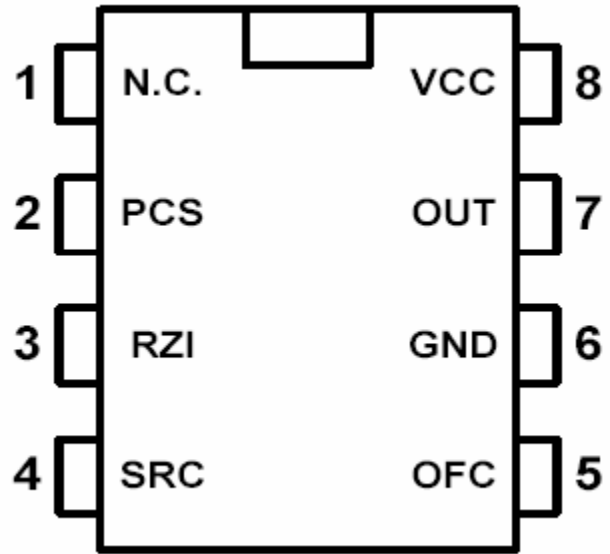

Functional Description

The ICE1QS01 is optimized to control free running flyback converters with and without Power Factor Correction (with PFC Charge Pump). The switching frequency is reduced in small steps with decreasing load towards a minimum of 20 kHz in standby mode. This function is performed by a digital circuit to avoid any jitter also with periodically pulsed loads. To provide extremely low power consumption at light loads, this device can be switched into Standby Burst Mode. This is also possible without standby control signal (for adapter application). Additionally, the start up current is very low. To avoid switching stresses of the power devices, the power transistor is always switched on at minimum voltage. The device has several protection functions: VCC over and undervoltage, mains undervoltage and current limiting. Regulation can be done by using the internal error amplifier or an opto coupler feedback. The output driver is ideally suited for driving a power MOSFET. The ICE1QS01 is suited for TV-sets, VCR- sets, SAT- receivers and other consumer applications in the power range from 0 to app. 300 W.

8. PIN VOLTAGES OF IC'S

IC 101(VCTI) Video-Controller-Text-IFAudio IC Family

Pin No	Pin Name	Short Description	V DC	ST-BY	Pin No	Pin Name	Short Description	V DC	ST-BY
1	GND	Ground Platform	0	0	45	GND	Ground Platform	0	0
2	VSUP8.0AU	Supply Voltage Analog Audio, 8.0 V	8,13	1,35	46	VSUP3.3FE	Supply Voltage Analog Video Front-end, 3.3 V	3,3	3,3
3	VREFAU	Reference Voltage, Audio	3,67	0	47	P10	Port 1, Bit 0 Input/Output	3,27	0
4	SPEAKERL	Analog Loudspeaker Output, Right	3,72	0	48	P11	Port 1, Bit 1 Input/Output	0	3,27
5	SPEAKERR	Analog Loudspeaker Output, Right	3,72	0	49	P12	Port 1, Bit 2 Input/Output	3,3	3,29
6	AOUT1L	Analog Audio 1 Output, Left	3,72	0	50	P13	Port 1, Bit 3 Input/Output	0	3,28
7	AOUT1R	Analog Audio 1 Output, Right	3,72	0	51	P14	Port 1, Bit 4 Input/Output	0	0
8	AIN3L/AOUT2L	Analog Audio 3 Input, Left / Analog Audio 2 Output, Left	3,43	0	52	P15	Port 1, Bit 5 Input/Output	0	0
9	AIN3R/AOUT2R	Analog Audio 3 Input, Right / Analog Audio 2 Output, Right	3,44	0	53	P16	Port 1, Bit 6 Input/Output	2,77	2,77
10	AIN2L	Analog Audio 2 Input, Left	3,7	0	54	P17	Port 1, Bit 7 Input/Output	2,79	2,79
11	AIN2R	Analog Audio 2 Input, Right	3,7	0	55	P20	Port 2, Bit 0 Input/Output	3,32	2,9
12	AIN1L	Analog Audio 1 Input, Left	3,7	0	56	P21	Port 2, Bit 1 Input/Output	3,24	0,6
13	AIN1R/SIF	Analog Audio 1 Input Right/Analog 2nd Sound IF Output	3,7	0	57	SCL	I ² C Bus Clock Input/Output	3,3	3,06
14	TAGC	Tuner AGC Output	3,77	0,82	58	SDA	I ² C Bus Data Input/Output	3,3	3,06
15	VREFIF	Reference Voltage, IF ADCs	2,42	0,9	59	VPROT	Vertical Protection Input	0,05	0
16	IFIN-	Differential IF Input	2,43	0,76	60	HOUT	Horizontal Drive Output	1,55	3,29
17	IFIN+	Differential IF Input	2,43	0,76	61	HFLB	Horizontal Flyback Input	0,65	0
18	RESETQ	Reset Input/Output	3,29	3,27	62	SAFETY	Safety Input	0,03	0,43
19	VSUP5.0FE	Supply Voltage Analog IF Front-end, 5.0 V	4,96	1	63	GNDDAC	Ground Video DACs	0	0
20	VSUP5.0IF	Supply Voltage IF ADC, 5.0 V	4,92	1	64	VSUP3.3DAC	Supply Voltage Video DACs, 3.3 V	3,29	1
21	VSUP3.3DIG	Supply Voltage Digital Core, 3.3 V	3,14	1	65	VSUP3.3IO	Supply Voltage I/O Ports, 3.3 V (main and Standby supply)	3,31	3,31
22	GND	Ground Platform	0	0	66	GND	Ground Platform	0	0
23	GND	Ground Platform	0	0	67	GND	Ground Platform	0	0
24	VSUP1.8DIG	Supply Voltage Digital Core, 1.8 V (main and stand by supply)	1,85	1,97	68	VSUP3.3BE	Supply Voltage Analog Video Back-end, 3.3 V	3,28	1
25	XTAL1	Analog Crystal Input	1,71	1,7	69	XREF	Reference Current for RGB DACs	1,22	0
26	XTAL2	Analog Crystal Output	1,74	1,72	70	VRD	Reference Voltage for RGB DACs	1,24	0,95
27	P22	Port 2, Bit 2 Input/Output	3,27	3,26	71	BOUT	Analog Blue Output	4,66	1
28	P23	Port 2, Bit 3 Input/Output	3,27	3,26	72	GOOUT	Analog Green Output	4,66	1
29	VIN11	Analog Video 11 Input	0,12	0,09	73	ROOUT	Analog Red Output	4,66	1
30	VIN10	Analog Video 10 Input	0	0,09	74	SVMOUT	Scan Velocity Modulation Output	1,77	0,37
31	VIN9	Analog Video 9 Input	0,5	0,09	75	BIN	Analog Blue Input, Back-end	0,19	0
32	VIN8	Analog Video 8 Input	0,5	0,09	76	GIN	Analog Green Input, Back-end	0,19	0
33	VIN7	Analog Video 7 Input	0,99	0,09	77	RIN	Analog Red Input, Back-end	0,19	0
34	VIN6	Analog Video 6 Input	0,99	0,09	78	FBIN	Fast Blank Input, Back-end	0,07	0,07
35	VIN5	Analog Video 5 Input	0,99	0,09	79	GNDM	Reference Ground for Sense ADC	0	0
36	VIN4	Analog Video 4 Input	1	0,09	80	SENSE	Sense ADC Input	0,23	0
37	VIN3	Analog Video 3 Input	1	0,09	81	RSW1	Range Switch 1 Output	0,03	0
38	VIN2	Analog Video 2 Input	1	0,09	82	RSW2	Range Switch 2 Output	0,01	0
39	VIN1	Analog Video 1 Input	1	0,09	83	EW	Vertical Parabola Output	4,37	0
40	VOOUT1	Analog Video 1 Output	1,08	1,49	84	VERT-	Differential Vertical Sawtooth Output	0,82	0
41	VOOUT2	Analog Video 2 Output	1,08	1,49	85	VERT+	Differential Vertical Sawtooth Output	0,79	0
42	VOOUT3	Analog Video 3 Output	1,17	0,98	86	TEST	Test Input, reserved for Test	3,71	0
43	VSUP1.8FE	Supply Voltage Analog Video Front-end, 1.8 V	1,9	1,9	87	VSUP5.0BE	Supply Voltage Analog Video Back-end, 5.0 V	5,01	0
44	GND	Ground Platform	0	0	88	GND	Ground Platform	0	0

IC 301(AN 5277)
Dual Channel SEPP Power Amplifier

Pin No	Pin Name	Short Description	V DC	ST-BY	Pin No	Pin Name	Short Description	V DC	ST-BY
1	N.C	NOT CONNECTED	0	0	7	CH.2 OUT	CHANNEL 2 OUTPUT	12	0
2	CH.1 IN.	CHANNEL 1 INPUT	0	0	8	MUTE	MUTE	0,37	4,44
3	RF	RIPPLE FILTER	23,1	0,76	9	GND(OUTPUT)	OUTPUT GROUND	0	0
4	GND(INPUT)	INPUT GROUND	0	0	10	Vcc	Vcc	25,3	8,47
5	CH.2 IN	CHANNEL 2 INPUT	0	0	11	ST-BY	STANDBY	16,5	0,43
6	N.C	NOT CONNECTED	0	0	12	CH.1 OUT	CHANNEL 1 OUTPUT	12	0

IC 602(ICE1QS01)
Dual Channel SEPP Power Amplifier

Pin No	Pin Name	Short Description	V DC	ST-BY	Pin No	Pin Name	Short Description	V DC	ST-BY
1	N.C	NOT CONNECTED	0	0	5	OFC	OVERVOLTAGE FAULT COMPARATOR	0	0
2	PCS	PRIMARY CURRENT SIMULATION	1,3	9,06	6	GND	GROUND	0	0
3	RZI	REGULATION AND ZERO CROSSING INPUT	1,35	0,04	7	OUT	OUTPUT	1,79	0
4	SRC	SOFT-START AND REGULATION CPACITOR	2,76	0,34	8	Vcc	SUPPLY VOLTAGE	11,4	10,1

IC 501(TDA 8357)
VERTICAL DEFLECTION

Pin No	Pin Name	Short Description	V DC	ST-BY	Pin No	Pin Name	Short Description	V DC	ST-BY
1	INA	INPUT A	0,79	0	6	Vfb	FLAYBACK SUPPLY COLTAGE	46,5	0
2	INB	INPUT B	0,77	0	7	OUTA	OUTPUT A	6,46	0
3	Vp	SUPPLY VOLTAGE	12,4	0	8	GUARD	GUARD OUTPUT	0,25	0
4	OUTB	OUTPUT B	6,5	0	9	FEEDB	FEEDBACK INPUT	6,55	0
5	GND	GROUND	0	0					

9. OSCILLOGRAPHS OF SOME IC PINS

Note : A pattern Generator is connected to the TV (Colour Bar, sound 1 kHz)

9.1 VCTI-IC 101

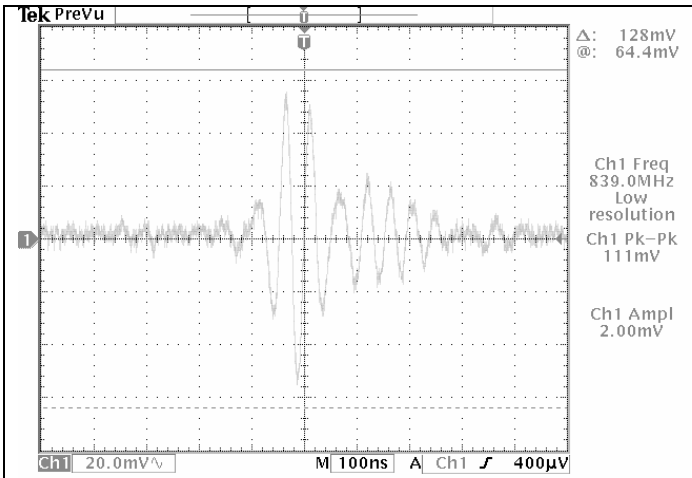

Pin 02, Supply Voltage Analog Audio, 15625 kHz

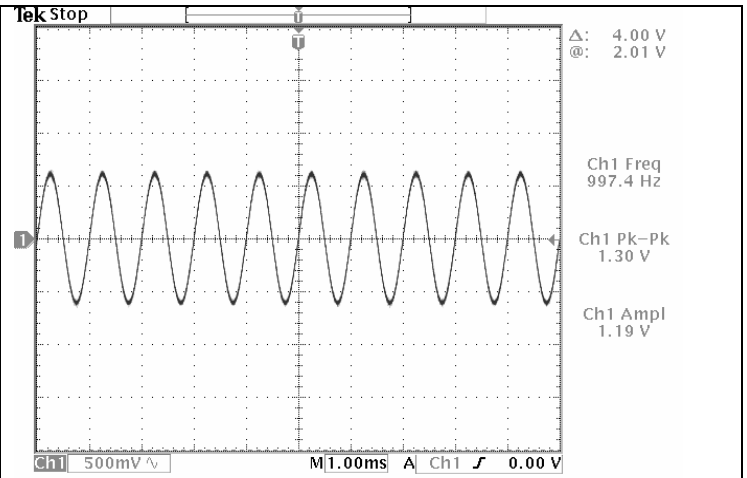

Pin 06, Analog Audio 1 Output, Left, 15625 kHz

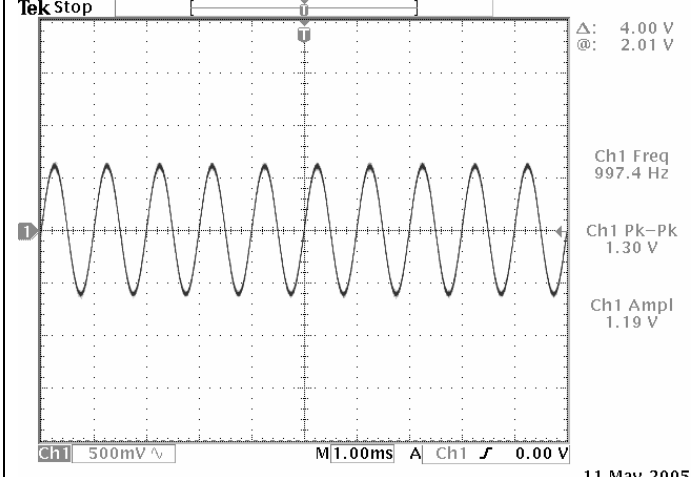

Pin 07, Analog Audio Output, Right, 15625 kHz

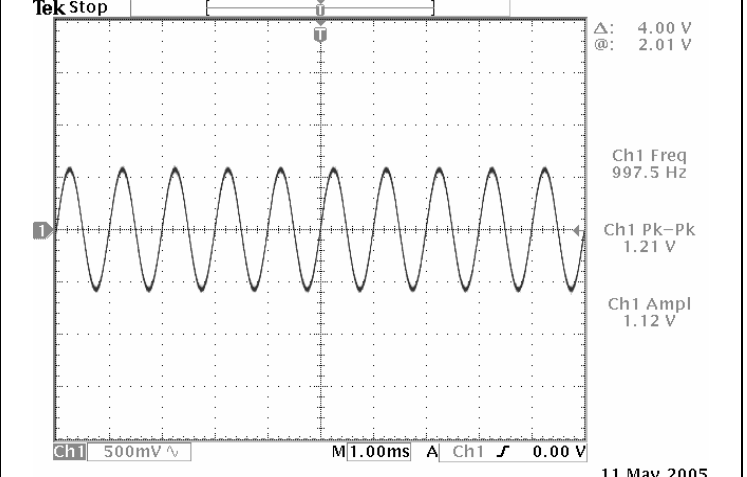

Pin 08, Analog Audio 3 Input, Left, 15625 kHz

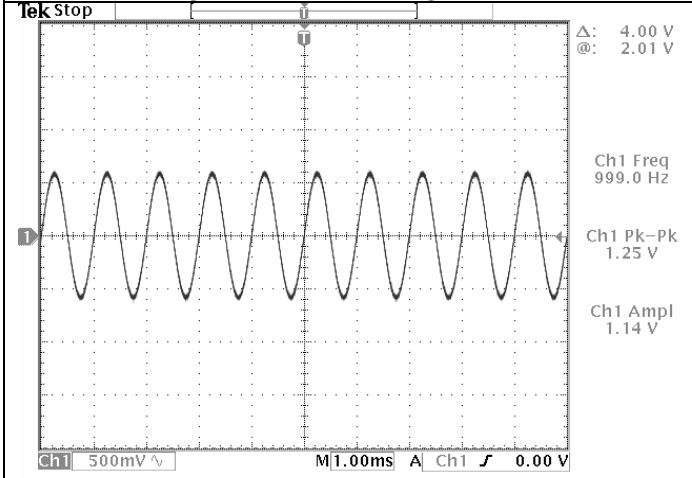

Pin 09, Analog Audio 3 Input, Right, 15625kHz

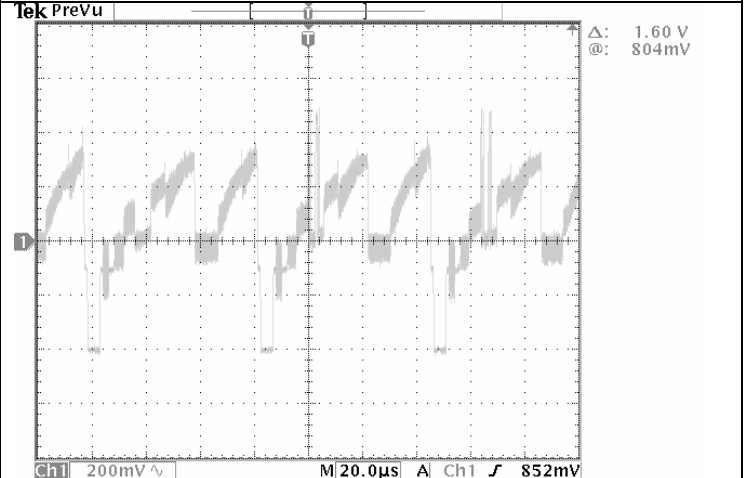

Pin 38, Analog Video 2 Input, 15625kHz

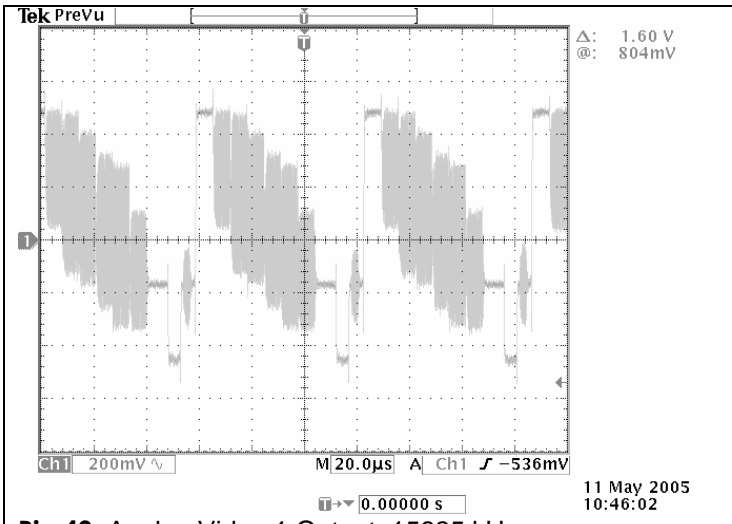

Pin 40, Analog Video 1 Output, 15625 kHz

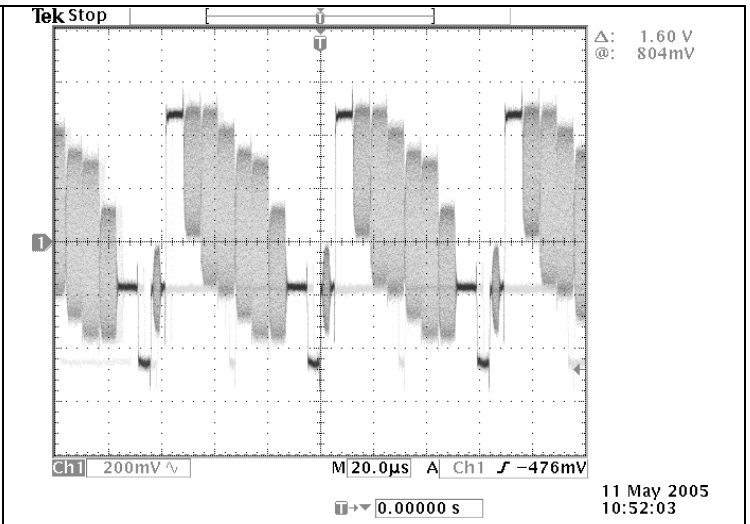

Pin 41, Analog Video 2 Output, 15625 kHz

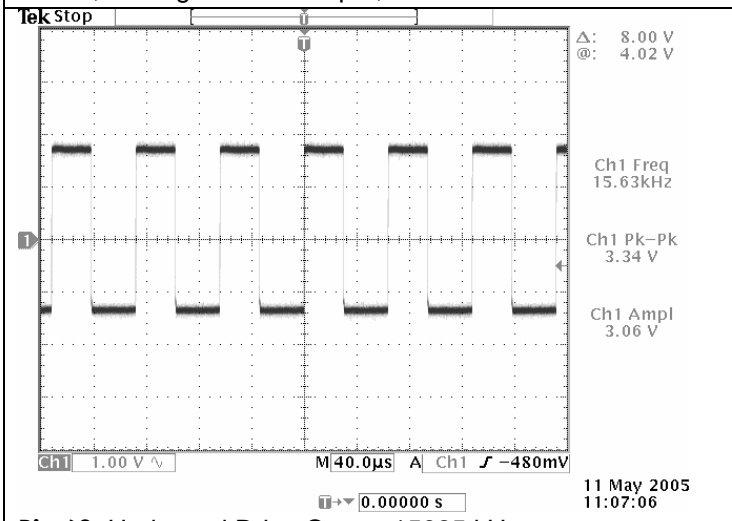

Pin 60, Horizontal Drive Output, 15625 kHz

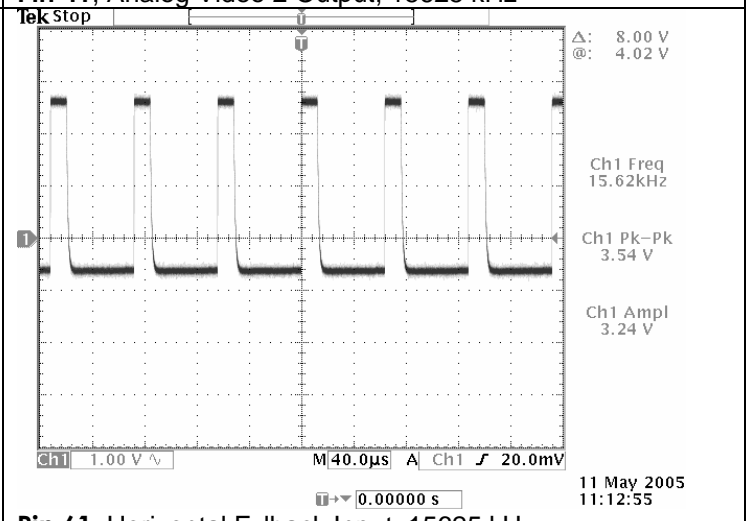

Pin 61, Horizontal Flyback Input, 15625 kHz

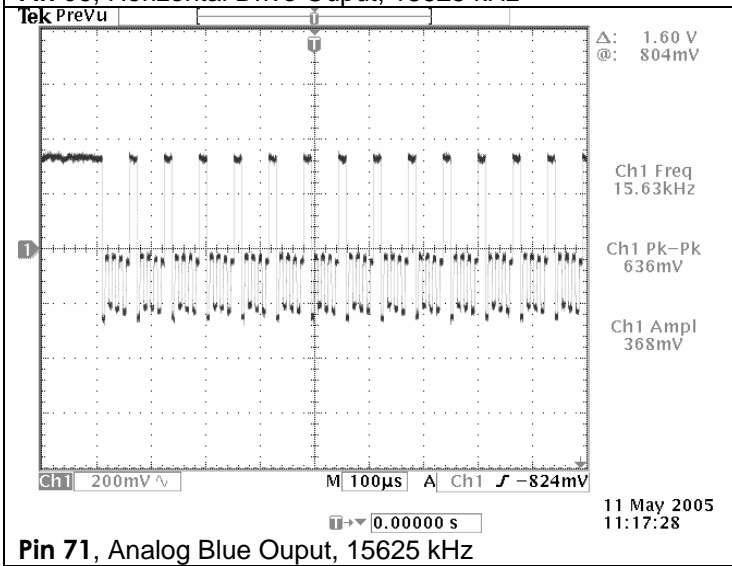

Pin 71, Analog Blue Output, 15625 kHz

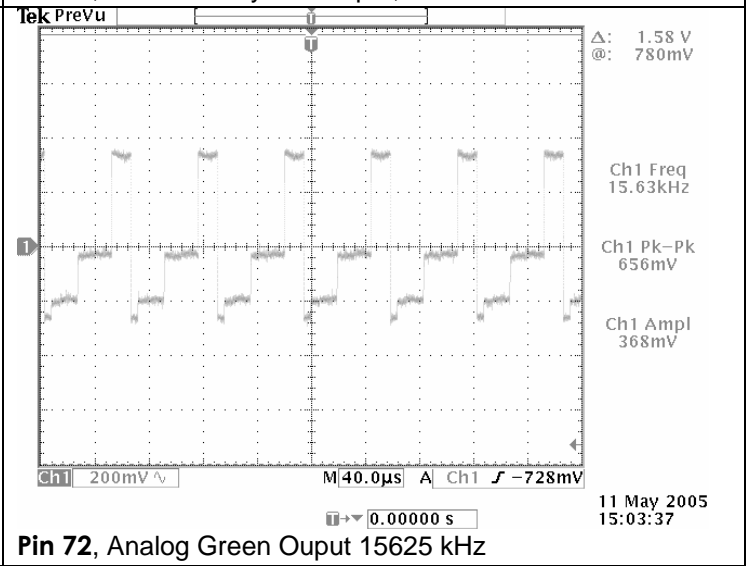

Pin 72, Analog Green Output, 15625 kHz

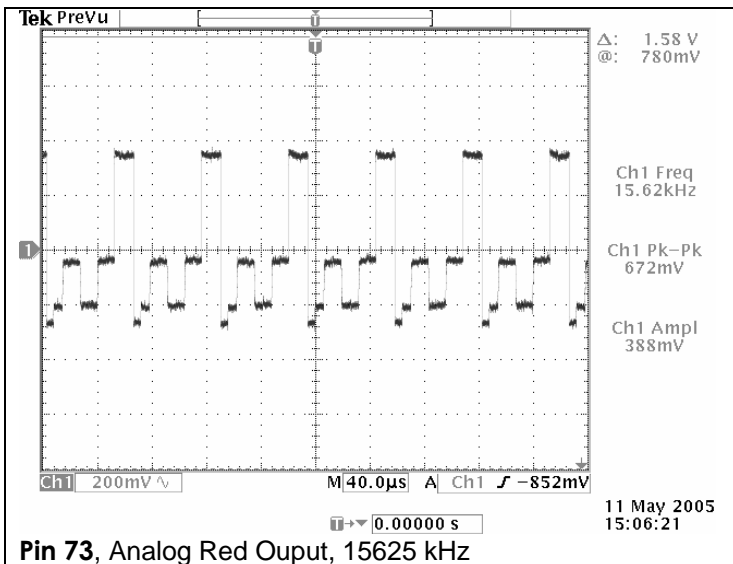

Pin 73, Analog Red Ouput, 15625 kHz

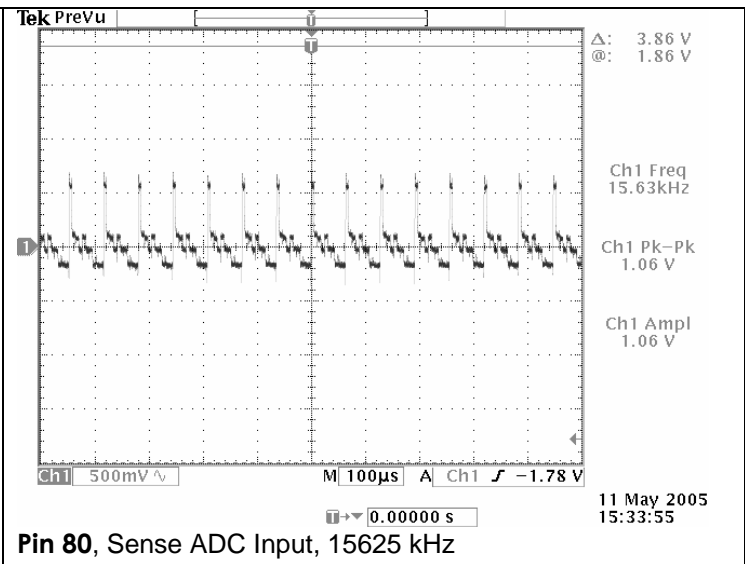

Pin 80, Sense ADC Input, 15625 kHz

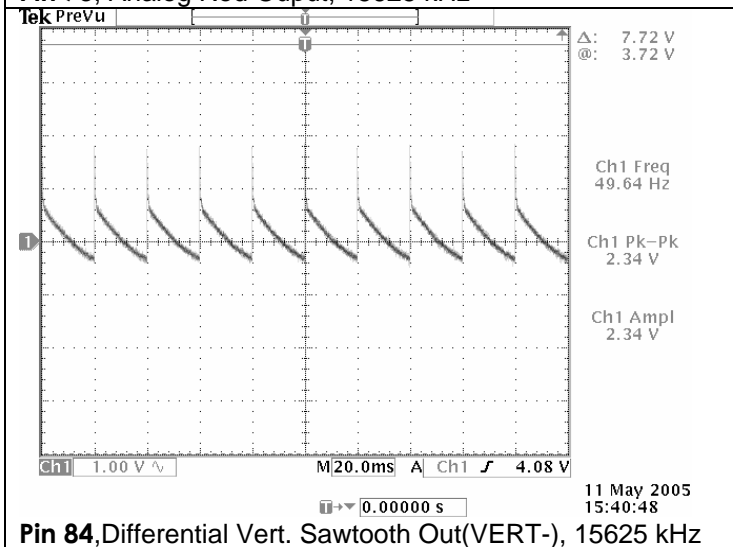

Pin 84, Differential Vert. Sawtooth Out(VERT-), 15625 kHz

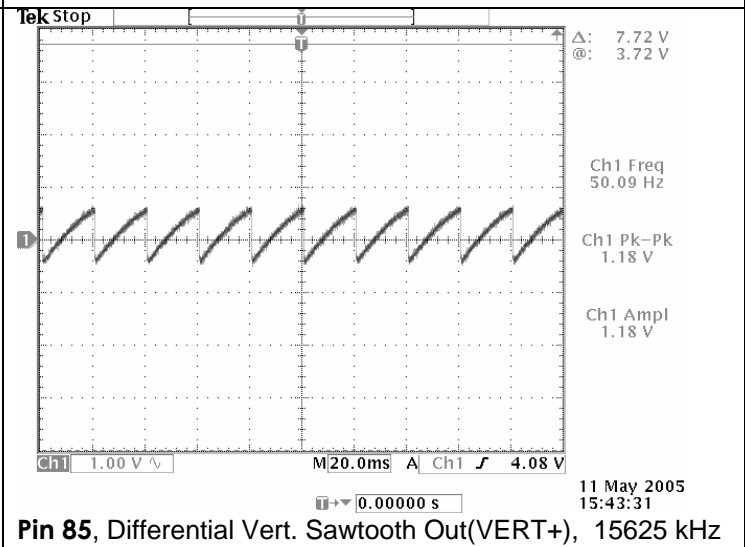

Pin 85, Differential Vert. Sawtooth Out(VERT+), 15625 kHz

9.2 TDA 2822-IC 301

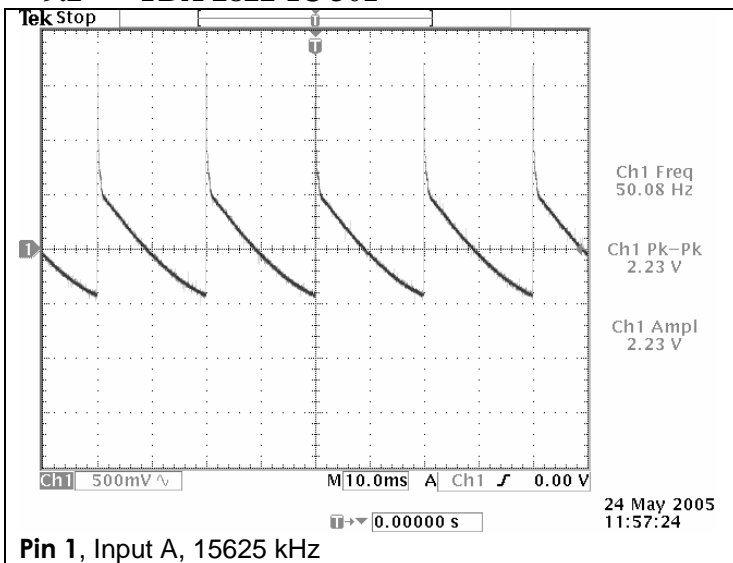

Pin 1, Input A, 15625 kHz

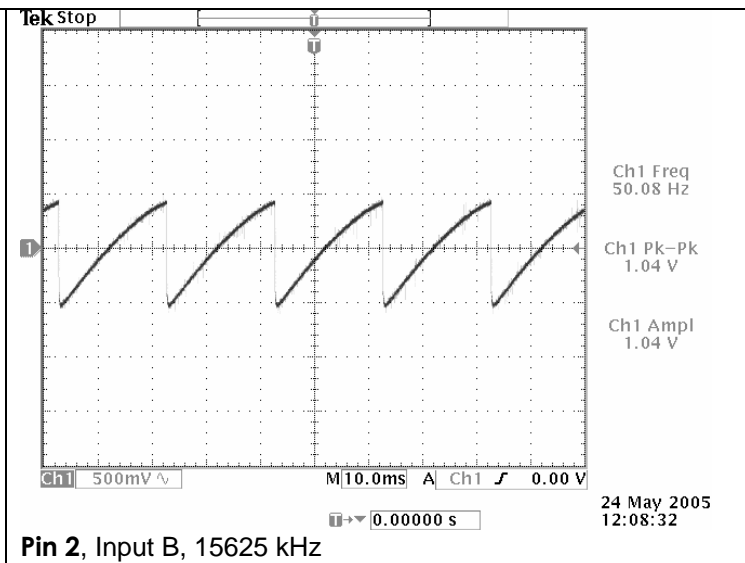

Pin 2, Input B, 15625 kHz

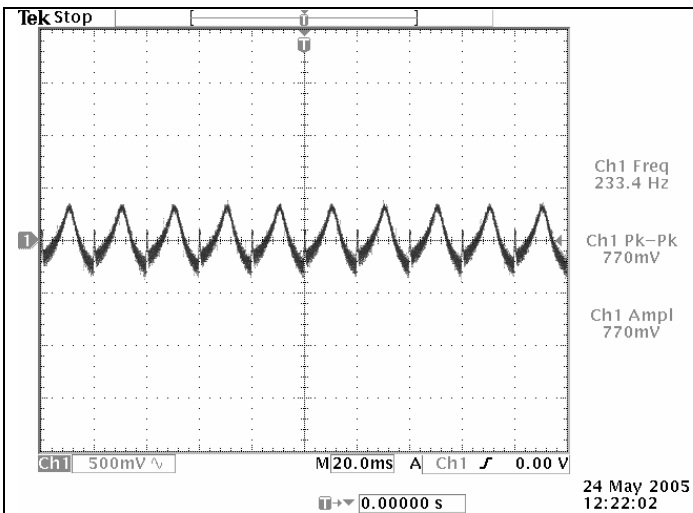

Pin 3, Supply Voltage, 15625 kHz

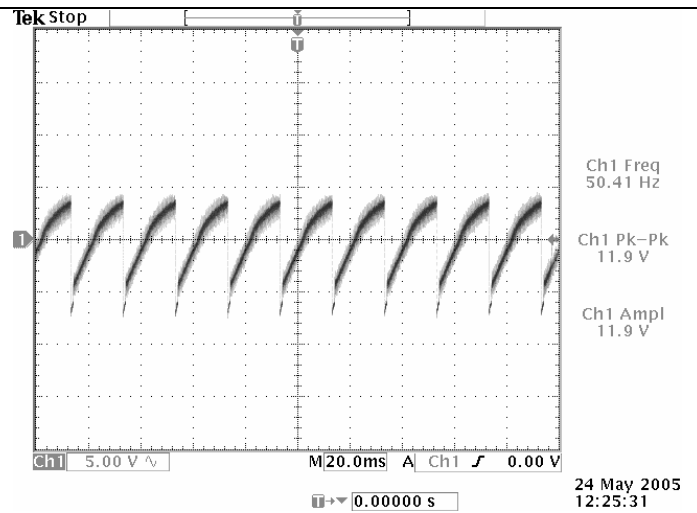

Pin 4, Output B, 15625 kHz

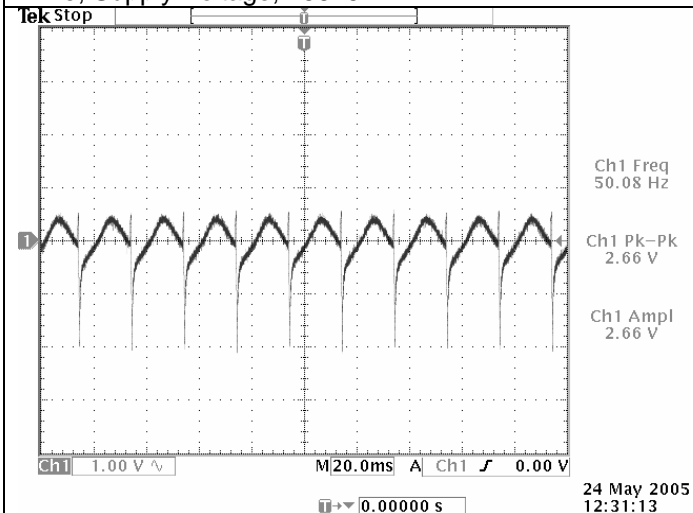

Pin 6, Flyback Supply Voltage, 15625 kHz

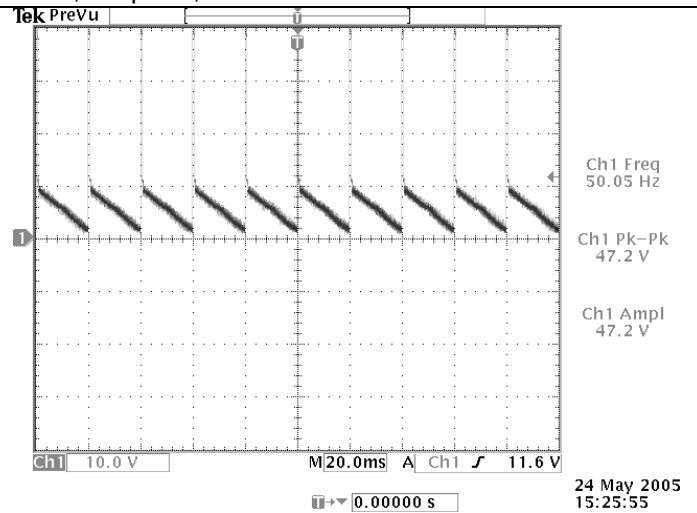

Pin 7, Output A, 15625 kHz

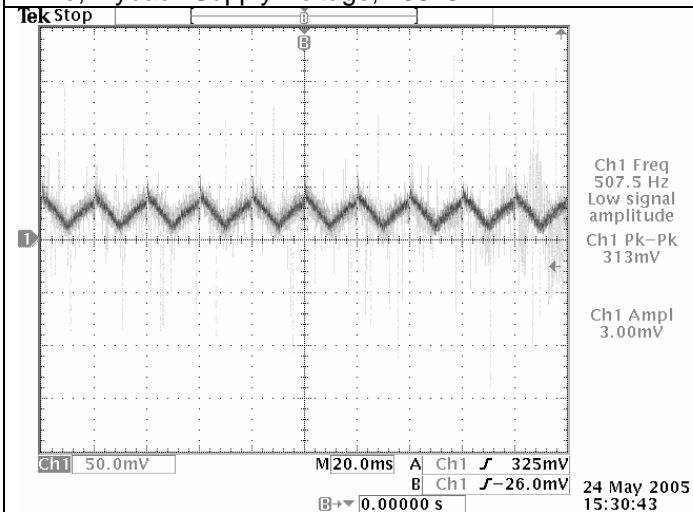

Pin 8, Guard Output, 15625 kHz

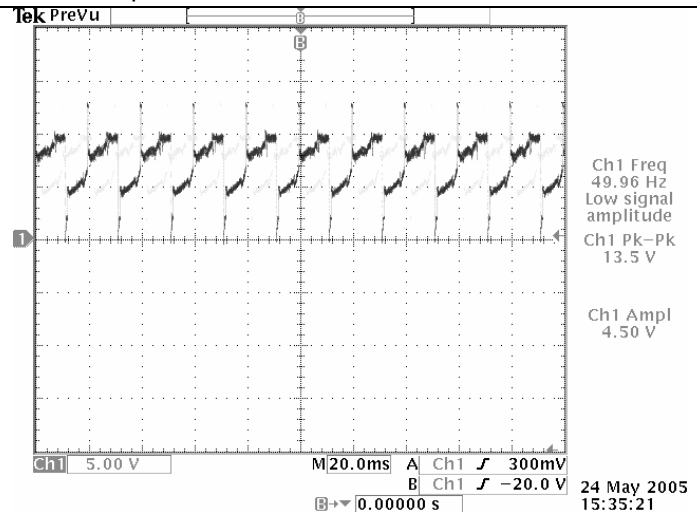

Pin 9, Feedback Input, 15625 kHz

10. ELECTRICAL ADJUSTMENTS

1. ELECTRICAL ADJUSTMENTS

1.1 Supply Voltage Adjustment

Connect a digital voltmeter to the cathode of diode D610 at the AV mode of the TV and set the screen voltage to the minimum with the screen potentiometer. Adjust the main supply voltage (B+) with P601 potentiometer to the following value (after supply adjustment, readjust Screen and focus voltage).

21" : 122 VDC (for A51QDX993X030)

2. SERVICE ADJUSTMENTS

To enter the Service Mode, 'Service In/Out' button on the Service Remote Control or activate the "Picture Menu" with the user remote control and press "9301" (Press "0" button to exit the Service Mode). To exit from the service menu, TV/TX button should be typed on the Remote Control.

While the service menu is on screen, version and the date of the software are written on right bottom of the screen.

For Example:

SK5.256-01 T09

12:07:26

10/03/05 F1



2.1 AGC Adjustment

- Switch to Service Menu
- Find the "AGC METHOD" under "OPTIONS" sub-menu with P+/P-,
- Set its value to "SYNC+PEAK WHITE".
- Find "AGC" under "IF ADJ." sub-menu with P+/P-,
- Set its value to "4"
- Find "AGC FOR VHF I" under "IF ADJ." sub-menu with P+/P-,
- Set its value to "4"
- Set "PIP AGC" topic's value to "15"
- Set "PIP AGC FOR VHF I" topic's value to "20"
- Exit from the service menu.

2.2 Screen Adjustment

- Switch the TV to the AV mode
- Do not make any connection from the scart switch
- Switch on the service menu
- Set the value of "BLUEBLACK" option to "OFF"
- Set the value of the "SCREEN ADJ." to the indicated value in FACTORY SETTINGS TABLE
- Press "OK" button on the RC
- There should appear a horizontal line on the center of the set
- Adjust the screen potentiometer to set the line at the first seen point.
- Exit from the service menu

2.3 White Balance Adjustment

- Apply a white pattern with a pattern generator to the antenna input.
- Enter the Service Menu and access to VIDEO ADJ. I sub-menu
- Set the value of "G.CUT OFF" value to "156" and "G.DRIVE" value to "356".
- Adjust red drive with "R.DRIVE" and blue drive with "B.DRIVE" .
- Adjust red cut off with "R.CUT OFF" and blue cut off with "B. CUT OFF"
- If white balance can not be adjusted properly, slightly change the values of "G.CUT OFF" and "G.DRIVE".
- Exit from Service menu.

2.4 Geometry Adjustments

- Apply the cross hatch pattern with a pattern generator to the antenna input.
- Enter Service Menu and access to GEOMETRY sub-menu
- The options, "50Hz GEOM.", "50Hz. GEOM.HOR.II", "50Hz GEOM.EHT" are for PAL/SECAM.
- The options, "60Hz GEOM.", "60Hz. GEOM.HOR.II", "60Hz GEOM.EHT" are for NTSC.
- Adjust Vertical Amplitude with "VERTICAL AMPLITUDE" option.
- Adjust vertical centring with "VERTICAL SHIFT", vertical linearity with "LINEARITY" , vertical s-correction with "S-CORRECTION", vertical parallelogram with "VERTICAL ANGLE", vertical bow with "VERTICAL BOW", horizontal centering with "HORIZONTAL SHIFT", trapeze adjustment with "TRAPEEZE CORR.I", general parabole adjustment with "CUSHION CORR.I" options.
- Adjust the parabole of the top corners with "UPPER CORNER 1" and "UPPER CORNER 2".
- Adjust the parabole of the bottom corners with "LOWER CORNER 1" and "LOWER CORNER 2".
- Adjust the horizontal OSD centering with "HORIZONTAL OSD POSITION" and vertical OSD centering with "VERTICAL OSD POSITION"
- For NTSC adjustments, connect an NTSC signal from AV1 follow the adjustments explained above under the sub-menus "60Hz GEOM.", "60Hz. GEOM.HOR.II", "60Hz GEOM.EHT".
- Exit from the Service Menu.

2.7 Options Menu

Enter the Service Menu with the Service RC and and access to OPTION sub-menu and the options and their defitinons are written below.

AV1YUV	: AVAILABLE(Component input is available from Scart 1); N/A(Not Available)
AV2&AV3	: AV2&AV3 N/A (Not Available); AV2 AVAIL.-AV3 N/A (AV1 Available, AV2 Not Av.); AV2&AV3 AVAILABLE (Both Available)
AV4	: NONE(No Front AV); CVBS+SVHS(Both Available); CVBS ONLY(Front AV Available); SVHS ONLY(SVHS available)
TELETEXT	: DEFAULT(Teletext); FASTEXT; TOPTTEXT; FASTEXT+TOPTTEXT
LANGUAGE	: 1 (English, French, German, Italien, Spanish, Portuguese, Dutch, Greek, Danish, Swedish, Finnish, Norwegian, Turkish, Hebrew, Russian, Hungarian, Slovak, Czech, Polish, Albanian, Macedonian, Serbian, Slovenian, Romanian, Croatia, Bulgarian); 2 (English, French, German, Italian, Dutch, Greek, Danish, Swedish, Spanish, Portuguese, Norwegian, Finnish, Albanian, Macedonian, Turkish, Russian, Hebrew, Hungarian, Croatia, Romanian, Bulgarian, Slovenian, Czech, Slovak, Arabish, Persian)
TXT TABLE	: AUTO; WEST(English, French, German, Turkish, Spanish, Italian, Finnish, Swedish, Norwegian, Danish); EAST(Polish, French, Hungarian, Czech, German, Slovenian, Italian, Romanian); GREEC(English, French, Turkish, German, Finnish, Norwegian, Swedish, Danish, Spanish, Italian, Greek); CYRILLIC(English, Russian, German, Czech, Estonian, Ukrainian, Latvian); ARABIC(English, French, German, Turkish, Spanish, Italian, Finnish, Swedish, Norwegian, Danish, Arabic); FARSI(English, French, German, Turkish, Spanish, Italian, Finnish, Swedish, Norwegian, Danish, Persian); HEBREW(English, French, German, Tuskish, Italian, Finnish, Swedish; Norwegian,Danish)
CRT	: 4:3; 16:9
PIP	: AVAILABLE; N/A
MAIN TUNER	: Philips; Panasonic DB2G3-DA5G3; Temic; Panasonic D44G3; Sharp or Alps
PIP TUNER	: Philips; Panasonic DB2G3-DA5G3; Temic; Panasonic D44G3; Sharp or Alps
SVM&DCI	: ON; OFF; MENU

BLUEBLACK : ON(blueblack acticated), OFF(Blueblack inactivated)
 LTI&COMB : ON; OFF
 CTI :ON(Colour Transition Improvement available); OFF(N/A)
 ADAPTIVE PKG : ON(Digital Noise Reduction available); OFF(N/A); MENU(via menu)
 PROTECTION : N/A(No Protection circuit); BCL ONLY(Only Beem Current Limiting available); VERTICAL ONLY(Only Vertical protection available); BCL&VERTICAL(Both available)
 PANORAMA : AVAILABLE; N/A
 KEYBOARD : P-P+V-V+; MENU P/V-+
 GAME : AVAILABLE; N/A
 ALARM TIMER : AVAILABLE; N/A
 DVD LANG : A; B; C; D
 DEMO : 0(Otoprogram in first start, closed); 1 (open)

2.7 Sound Options Menu

BG : EUROPE(BG Europe); NEW ZELLAND(BG New Zelland); AUSTRALIA(BG Australia); N/A(BG not available)
 DK : AVAILABLE; N/A
 I : AVAILABLE; N/A
 L/L' : AVAILABLE; N/A
 FM RADIO
 / TV GUIDE : NONE(Radio&EPG, not available); FM RADIO(Only radio available); TV GUIDE(Only TV Guide available)
 NICAM : AVAILABLE; N/A
 DOLBY VITUAL : AVAILABLE; N/A
 BASS OPTION : DYNAMIC BASS(Dynamic Bass available); SUBWOOFER(Subwoofer available); NONE
 HEADPHONE : AVAILABLE; N/A
 CARRIER MUTE : VIA MSP; VIA MICRO
 PAT : AVAILABLE(Picture and Text available); N/A
 SIMPLE HOTEL : AVAILABLE; N/A
 HOTEL MAX
 VOL : Limites the max volume level in hotel mode
 AGC METHOD : SYNC PEAK WHITE; FIXED
 TILT : N/A; AVAILABLE
 CRT 4:3,
 MODE 16:9 : VIA FLYBL(Prevents cut off line to be seen by shifting up); DISABLE CUTOFF(Directly Prevents Cut off line to be seen)

2.7 Hotel Mode

If "Simple Hotel" option in the Service Menu is selected as "ON", to access set up menu "4658" should be typed whilst the "Features Menu" is on screen. After finishing the adjustments by taking the TV to St.by or shutting down, the access can be re-inhibited.

2.7 Factory Settings for Service Mode

Values given in Table 1 are typical values and can vary according to the CRT type.

FACTORY SETTINGS FOR SERVICE MODE									
VIDEO ADJ. I	21" Master	21" Grun.	21" GS9	21" VC0	50 HZ GEOM.	21" Master	21" Grun.	21" GS9	21" VC0
R.DRIVE	356	356	356	356	VERTICAL AMPLITUDE	-250	-250	-170	-105
G.DRIVE	356	356	356	356	VERTICAL SHIFT	2	2	2	2
B.DRIVE	356	356	356	356	LINEARITY	20	20	-12	-12
R. CUTOFF	156	156	156	156	S-CORRECTION	140	140	130	140
G. CUTOFF	156	156	156	156	VERTICAL ANGLE	0	0	0	0
B. CUTOFF	156	156	156	156	VERTICAL BOW	0	0	0	0
IBRM	270	270	290	280	START LINE MEASUR.	11	11	14	11
WDRM	290	290	240	250	VER. BLANKING STOP	20	20	22	20
SCREEN ADJ.	296	296	250	405	VER. BLANKING START	333	333	-34	333
VIDEO ADJ. II					HORIZONTAL WIDTH	0	0	0	0
BCL GAIN	270	270	270	330	HORIZONTAL SHIFT	-23	-23	-23	-39
BCL TRESHOLD	200	200	200	160	TRAPEZE CORR. I	0	0	0	0
BCL TRESHOLD II	130	130	80	74	CUSHION CORR. I	0	0	0	0
BCL TIME CONSTANT 1	511	511	511	511	UPPER CORNER 1 I	0	0	0	0
BCL TIME CONSTANT 2	0	0	0	0	LOWER CORNER 1 I	0	0	0	0
OSD BRIGHTNESS	120	110	120	120	UPPER CORNER 2 I	0	0	0	0
OSD CONTRAST	140	140	110	120	LOWER CORNER 2 I	0	0	0	0
TXT BRIGHTNESS	110	90	110	110	HOR. BLANKING STOP	215	215	215	215
TXT CONTRAST	110	110	110	110	HOR. BLANKING START	1235	1235	1235	1235
YC DELAY FOR PAL	9	9	9	9	HOR. OSD POSITION	31	31	31	31
YC DELAY FOR SECAM	2	2	2	2	VER. OSD POSITION	18	18	18	18
YC DELAY FOR NTSC	10	10	10	10	60 HZ GEOM.				
SUBCARRIER ADJ.	18	18	18	18	VERTICAL AMPLITUDE	-206	-206	-180	-130
VIDEO ADJ. III					VERTICAL SHIFT	9	9	4	5
DPWL GAIN	-300	-300	-300	-300	LINEARITY	0	0	-50	-70
DPWL START P.	400	400	400	400	S-CORRECTION	-41	-41	100	140
PWL TIME CONSTANT	1	1	1	1	VERTICAL ANGLE	0	0	0	0
PWL	90	90	70	90	VERTICAL BOW	0	0	0	0
SVM GAIN	0	0	0	0	START LINE MEASUR.	11	11	16	11
SVM CORING	0	0	0	0	VER. BLANKING STOP	18	18	18	18
SVM LIMITTER	0	0	0	0	VER. BLANKING START	333	333	333	333
SVM DELAY	0	0	0	0	HORIZONTAL WIDTH	0	0	0	-57
SVM DIFF. WINDOW	0	0	0	0	HORIZONTAL SHIFT	-42	-42	-50	-42
PIP POSITION					TRAPEZE CORR. I	0	0	0	0
HORIZONTAL					CUSHION CORR. I	0	0	0	0
VERTICAL					UPPER CORNER 1 I	0	0	0	0
SOUND OPTIONS					LOWER CORNER 1 I	0	0	0	0
BCL DELTA	50	50	20	50	UPPER CORNER 2 I	0	0	0	0
TILT	0	0	0	0	LOWER CORNER 2 I	0	0	0	0
50HZ GEOM. EHT					HOR. BLANKING STOP	190	175	175	183
EHT TRESHOLD	70	70	70	70	HOR. BLANKING START	1225	1225	1225	1225
EHT TIME CONSTANT	40	40	40	40	HOR. OSD POSITION	18	18	16	18
VERTICAL EHT 1	-162	-162	-130	-200	VER. OSD POSITION	6	6	10	9
VERTICAL EHT 2	-160	-160	-50	-40	50 HZ GEOM. HOR. II				
HORIZONTAL EHT 1	0	0	0	0	HOR. WIDTH II	110	110	110	110
HORIZONTAL EHT 2	0	0	0	0	VER. ZOOM II	60	60	50	60
EHT DTC	0	0	0	0	FLYBL	14	14	17	14
EHT P1	0	0	0	0	TRAPEZE CORR. II	0	0	0	0
EHT P2	0	0	0	0	CUSHION CORR. II	0	0	0	0
60 HZ GEOM. EHT					UPPER CORNER 1 II	0	0	0	0
EHT TRESHOLD	80	80	80	80	LOWER CORNER 1 II	0	0	0	0
EHT TIME CONSTANT	40	40	40	40	UPPER CORNER 2 II	0	0	0	0
VERTICAL EHT 1	-93	-93	-130	-180	LOWER CORNER 2 II	0	0	0	0
VERTICAL EHT 2	-80	-80	-40	-40	60 HZ GEOM. HOR. II				
HORIZONTAL EHT 1	0	0	0	0	HOR. WIDTH II	110	110	110	110
HORIZONTAL EHT 2	0	0	0	0	VER. ZOOM II	60	60	60	60
EHT DTC	0	0	0	0	FLYBL	10	10	10	10
EHT P1	0	0	0	0	TRAPEZE CORR. II	0	0	0	0
EHT P2	0	0	0	0	CUSHION CORR. II	0	0	0	0
					UPPER CORNER 1 II	0	0	0	0
					LOWER CORNER 1 II	0	0	0	0
					UPPER CORNER 2 II	0	0	0	0
					LOWER CORNER 2 II	0	0	0	0

11. CHANNEL FREQUENCY TABLE

CHANNEL FREQUENCY TABLE (BG,I,DK,LL')

CHANNEL NO	BG	I	DK	L/L'			
CH1		49.75	49.75	47.75			
CH2	48.25	59.25	59.25	55.75			
CH3	55.25	77.25	77.25	60.50			
CH4	62.25	85.25	85.25	63.75			
CH5	175.25	93.25	93.25	176.00			
CH6	182.25	175.25	175.25	184.00			
CH7	189.25	183.25	183.25	192.00			
CH8	196.25	191.25	191.25	200.00			
CH9	203.25	199.25	199.25	208.00			
CH10	210.25	207.25	207.25	216.00			
CH11	217.25	215.25	215.25	189.25			
CH12	224.25	223.25	223.25	182.25			
CH13	53.75	45.75		196.25			
CH14	62.25	53.75		210.25			
CH15	82.25	61.75					
CH16	175.25	69.75					
CH17	183.25	95.25					
CH18	192.25						
CH19	201.25						
CH20	210.25						
CH21	471.25	471.25	471.25	471.25			
CH22	479.25	479.25	479.25	479.25			
CH23	487.25	487.25	487.25	487.25			
CH24	495.25	495.25	495.25	495.25			
CH25	503.25	503.25	503.25	503.25			
CH26	511.25	511.25	511.25	511.25			
CH27	519.25	519.25	519.25	519.25			
CH28	527.25	527.25	527.25	527.25			
CH29	535.25	535.25	535.25	535.25			
CH30	543.25	543.25	543.25	543.25			
CH31	551.25	551.25	551.25	551.25			
CH32	559.25	559.25	559.25	559.25			
CH33	567.25	567.25	567.25	567.25			
CH34	575.25	575.25	575.25	575.25			
CH35	583.25	583.25	583.25	583.25			
CH36	591.25	591.25	591.25	591.25			
CH37	599.25	599.25	599.25	599.25			
CH38	607.25	607.25	607.25	607.25			
CH39	615.25	615.25	615.25	615.25			
CH40	623.25	623.25	623.25	623.25			
CH41	631.25	631.25	631.25	631.25			
CH42	639.25	639.25	639.25	639.25			
CH43	647.25	647.25	647.25	647.25			
CH44	655.25	655.25	655.25	655.25			
CH45	663.25	663.25	663.25	663.25			
CH46	671.25	671.25	671.25	671.25			
CH47	679.25	679.25	679.25	679.25			
CH48	687.25	687.25	687.25	687.25			
CH49	695.25	695.25	695.25	695.25			
CH50	703.25	703.25	703.25	703.25			
CH51	711.25	711.25	711.25	711.25			
CH52	719.25	719.25	719.25	719.25			
CH53	727.25	727.25	727.25	727.25			
CH54	735.25	735.25	735.25	735.25			
CH55	743.25	743.25	743.25	743.25			
CH56	751.25	751.25	751.25	751.25			
CH57	759.25	759.25	759.25	759.25			
CH58	767.25	767.25	767.25	767.25			
CH59	775.25	775.25	775.25	775.25			

CH60	783.25	783.25	783.25	783.25			
CH61	791.25	791.25	791.25	791.25			
CH62	799.25	799.25	799.25	799.25			
CH63	807.25	807.25	807.25	807.25			
CH64	815.25	815.25	815.25	815.25			
CH65	823.25	823.25	823.25	823.25			
CH66	831.25	831.25	831.25	831.25			
CH67	839.25	839.25	839.25	839.25			
CH68	847.25	847.25	847.25	847.25			
CH69	855.25	855.25	855.25	855.25			
CH70				863.25			
CH71							
CH72							
CH73							
CH74	69.25						
CH75	76.25						
CH76	83.25						
CH77	90.25						
CH78	97.25						
CH79	59.25						
CH80	93.25						
S1	105.25	103.25	103.25	116.75			
S2	112.25	111.25	111.25	128.75			
S3	119.25	119.25	119.25	140.75			
S4	126.25	127.25	127.25	152.75			
S5	133.25	135.25	135.25	164.75			
S6	140.25	143.25	143.25	176.75			
S7	147.25	151.25	151.25	188.75			
S8	154.25	159.25	159.25	200.75			
S9	161.25	167.25	167.25	212.75			
S10	168.25	231.25	231.25	224.75			
S11	231.25	239.25	239.25	236.75			
S12	238.25	247.25	247.25	248.75			
S13	245.25	255.25	255.25	260.75			
S14	252.25	263.25	263.25	272.75			
S15	259.25	271.25	271.25	284.75			
S16	266.25	279.25	279.25	296.75			
S17	273.25	287.25	287.25	55.75			
S18	280.25	295.25	295.25	60.50			
S19	287.25	303.25	303.25	63.75			
S20	294.25						
S21	303.25			303.25			
S22	311.25	311.25	311.25	311.25			
S23	319.25	319.25	319.25	319.25			
S24	327.25	327.25	327.25	327.25			
S25	335.25	335.25	335.25	335.25			
S26	343.25	343.25	343.25	343.25			
S27	351.25	351.25	351.25	351.25			
S28	359.25	359.25	359.25	359.25			
S29	367.25	367.25	367.25	367.25			
S30	375.25	375.25	375.25	375.25			
S31	383.25	383.25	383.25	383.25			
S32	391.25	391.25	391.25	391.25			
S33	399.25	399.25	399.25	399.25			
S34	407.25	407.25	407.25	407.25			
S35	415.25	415.25	415.25	415.25			
S36	423.25	423.25	423.25	423.25			
S37	431.25	431.25	431.25	431.25			
S38	439.25	439.25	439.25	439.25			
S39	447.25	447.25	447.25	447.25			
S40	455.25	455.25	455.25	455.25			
S41	463.25	463.25	463.25	463.25			

12. SPARE PARTS LIST

Insertion Point	Object description	Component	Definition
C01	EC 47UF M 6.3V 11*5 R:5	251487R	
C02-C03	CC-CHIP 100PF J 50V /1206 NPO	291101R	
C102	EC 47UF 16V 11*5 R:5	251478R	
C103	CC-CHIP 10NF K 50V /0603 X7R	293113R	
C104-C110	CC-CHIP 1NF K 50V /0603 X7R	292114R	
C111-C123	CC-CHIP 100NF K 50V /0603 X7R	294122R	
C125-C128	CC-CHIP 100NF K 50V /0603 X7R	294122R	
C129-C135	EC 3.3UF 16V 11*5 R:5	250333R	
C136-C146	CC-CHIP 47PF J 50V /0603 NPO TAPE	290475R	
C148-C151	CC-CHIP 47PF J 50V /0603 NPO TAPE	290475R	
C152-C155	CC-CHIP 22PF J 50V /0603 NPO TAPE	290223R	
C156-C157	CC-CHIP 100PF J 50V /0603 NPO	291104R	
C158	CC-CHIP 27NF J 25V /0603 X7R	293271R	
C160	EC 4.7UF 63V 11*5 R:5	250475R	
C161	CC-CHIP 1UF K 16V /0805 X7R	295110R	
C162-C163	CC-CHIP 1NF K 50V /0603 X7R	292114R	
C202-C210	EC 4.7UF 16V 11*5 R:5	250470R	
C211-C212	CC-CHIP 220PF J 50V /0603 NPO TAPE	291226R	
C215-C216	CC-CHIP 22NF K 50V /0603 X7R TAPE	293234R	
C218-C219	CC-CHIP 22NF K 50V /0603 X7R TAPE	293234R	
C220-C225	CC-CHIP 220PF J 50V /0603 NPO TAPE	291226R	
C228-C230	EC 47UF 16V 11*5 R:5	251478R	
C233-C235	CC-CHIP 10NF K 50V /0603 X7R	293113R	
C236-C241	CC-CHIP 4.7NF K 50V /0603 X7R	292475R	
C242	EC 47UF 16V 11*5 R:5	251478R	
C243	CC-CHIP 10NF K 50V /0805 X7R	293108R	
C247-C248	CC-CHIP 1NF K 50V /0603 X7R	292114R	
C249	EC 10UF 16V 5*3.5 R:5	251105R	
C250	CC-CHIP 220NF K 50V /0805 X7R	294233R	
C251	CC-CHIP 10NF K 50V /0603 X7R	293113R	
C252-C253	CC-CHIP 100PF J 50V /0603 NPO	291104R	
C301	CC-CHIP 10NF K 50V /0603 X7R	293113R	
C302	CC 1NF K 63V NPO R:5	202109R	
C304-C307	CC-CHIP 1NF K 50V /0603 X7R	292114R	
C308	EC 10UF 16V 5*3.5 R:5	251105R	
C309-C310	CC-CHIP 100NF K 50V /0603 X7R	294122R	
C311-C313	EC 100UF 16V 11*6 R:5	252112R	
C315	CC-CHIP 47NF K 25V /0603 X7R TAPE	293478R	
C316-C317	CC-CHIP 470NF K 16V /0805 X7R	294476R	
C318-C321	CC-CHIP 1NF K 50V /0603 X7R	292114R	
C322	EC 100UF 25V 11*6 R:5	252113R	
C323-C324	CC-CHIP 1.5NF K 50V /0603 X7R TAPE	292153R	
C325	CC-CHIP 68NF K 50V /0603 X7R	293685R	
C326	EC 1500UF 35V 20*13 R:5	253155R	
C327-C328	EC 1000UF 16V 20*10 R:5	253115R	
C329-C330	C-PEM 100NF J 100V R:5	274107R	
C331	C-CE 100NF 50V K R:5	224112R	
C401	EC 4.7UF 16V 11*5 R:5	250470R	
C402	CC-CHIP 22NF K 50V /0603 X7R TAPE	293234R	
C404-C405	CC-CHIP 10NF K 50V /0603 X7R	293113R	
C406-C407	CC-CHIP 33NF K 50V /0603 X7R	293334R	
C408-C410	CC-CHIP 10NF K 50V /0603 X7R	293113R	
C412-C421	CC-CHIP 1NF K 50V /0603 X7R	292114R	
C422-C424	EC 10UF 16V 5*3.5 R:5	251105R	
C426	CC-CHIP 100NF K 50V /0603 X7R	294122R	
C428	CC-CHIP 100NF K 50V /0603 X7R	294122R	
C429-C431	EC 100UF 16V 11*6 R:5	252112R	
C435-C437	CC-CHIP 330PF J 50V /0603 NPO	291337R	
C438	CC-CHIP 47NF K 25V /0603 X7R TAPE	293478R	
C441	CC-CHIP 100PF J 50V /0603 NPO	291104R	
C442	CC-CHIP 33PF J 50V /0603 NPO TAPE	290335R	
C445-C446	CC-CHIP 10PF J 50V /0603 NPO TAPE	290107R	
C447	CC-CHIP 220NF Z 16V /0603 Y5V TAPE	294235R	
C502	CC 470PF K 500V Y5P R:5	201470	
C503	CC-CHIP 100NF K 50V /0603 X7R	294122R	
C504	CC-CHIP 47NF K 25V /0603 X7R TAPE	293478R	
C506-C507	CC-CHIP 10NF K 50V /0603 X7R	293113R	
C508-C509	CC-CHIP 100NF K 50V /0805 X7R	294109R	
C510	C-PEM 1NF J 100V R:5	272110R	
C511	C-PEM 47NF K 63V R:5	273471R	
C512	EC 47UF 25V 11*5 R:5	251479R	
C514	CC-CHIP 1NF K 50V /0603 X7R	292114R	
C515	EC 4.7UF 50V 11*5 R:5	250479R	
C517	CC 10NF K 50V R:5	203106R	
C518	C-PEM 220NF J 100V R:5	274230R	
C519	CC 68PF J 500V NPO R:5	200680R	
C52	EC 47UF 16V 11*5 R:5	251478R	
C522	C-PEM 330NF J 250V R:15	274330R	
C527	C-PPM 7.8NF %3.5 1.5/1.6KV R:15 CLASS-B	272780	See the "CPT Difference List", too
C528	C-PPM 270NF J 250V R:15	274274R	See the "CPT Difference List", too
C530	EC 1UF 160V 11*6.3 R:5	250100R	
C531	EC 47UF 63V 11*6.3 R:5	251475R	
C532	EC 22UF 250V 20*13 R:5	251230R	
C533	EC 470UF 16V 12.5*10 R:5	252482R	
C534	EC 22UF-M 50V 11*5 R:5	251221R	
C602	CC-CHIP 47NF K 25V /0603 X7R TAPE	293478R	
C603-C607	CC-CHIP 10NF K 50V /0603 X7R	293113R	
C608	EC 10UF 63V 11*5 R:5	251116R	
C611	CC-CHIP 33NF K 50V /0603 X7R	293334R	
C612-C621	CC-CHIP 47NF K 25V /0603 X7R TAPE	293478R	
C622	EC 1500UF 35V 20*13 R:5	253155R	
C623	CC-CHIP 100NF K 50V /0603 X7R	294122R	
C624	C-PEM 100NF J 250V R:10	274105R	
C625	C-PPM 330NF K 275V-AC R:22.5 CLASS-B	274342R	
C626	C-PEM 220NF K 275V-AC R:15 CLASS-B	274238R	
C627	C-PPM 33NF J 630V R:15	203330R	
C628-C629	CC 470PF 2KV	201471R	
C630-C631	EC 47UF 160V 21*13 R:5	251489R	

Insertion Point	Object description	Component	Definition
C632	CC-CHIP 56PF J 50V/0603 NPO TAPE	290562R	
C633	CC-CHIP 680PF J 0603 50V NPO	291688R	
C634	C-PEM 100NF J 250V R:10	274105R	
C635	CC-CHIP 1.5NF K 50V /0603 X7R TAPE	292153R	
C636-C637	CC 220PF M 250VAC R:10 Y5U AH/NSA	201227R	
C639-C642	CC 1NF K 1KV Y5P R:5	202105R	
C644	C-PEM 100NF J 250V R:10	274105R	
C646	CC-CHIP 100NF K 50V /0805 X7R	294109R	
C647-C649	CC-CHIP 10NF K 50V /0603 X7R	293113R	
C650	CC-CHIP 47PF J 50V /0603 NPO TAPE	290475R	
C651	EC 100UF 400V 30*22 R:10	252121R	
C652	EC 47UF 25V 11*5 R:5	251479R	
C653	CC 220PF K 2KV Y5P R:5	201226R	
C654	CC 2.2NF M 250VAC Y5U R:10 AH/NSA	202220R	
C655	C-ELA 2200UF 16V 20*13 R:5	253233	
C656	EC 1000UF 16V 20*10 R:5	253115R	
C657	CC-CHIP 56PF J 50V/0603 NPO TAPE	290562R	
C658	EC 1000UF 16V 20*10 R:5	253115R	
C659	EC 47UF 25V 11*5 R:5	251479R	
C660	EC 1000UF 16V 20*10 R:5	253115R	
C661	CC 100PF 500V NPO R:5	201108R	
C662	EC 1000UF 16V 20*10 R:5	253115R	
C664-C667	EC 22UF 16V 11*5 R:5	251225R	
C668	EC 22UF 25V 11*5 R:5	251226	
C670	EC 1000UF 16V 20*10 R:5	253115R	
C701	EC 10UF 16V 5*3.5 R:5	251105R	
C702	CC-CHIP 100NF K 50V /0603 X7R	294122R	
C704-C705	EC 10UF 250V 16*10 R:5	251109R	
C706-C708	CC-CHIP 680PF J 0603 50V NPO	291688R	
C709	CC-CHIP 10PF J 50V /0603 NPO TAPE	290107R	
C710-C712	CC 390PF J 50V SL R:5	201390R	
C713	CC 4.7NF K 1KV Z4V R:7.5	222477R	
C714	C-PEM 100NF J 250V R:10	274105R	
C920-C923	CC 1NF K 50V Y5P R:5	202106R	
C940-C941	C-PEM 47NF K 63V R:5	273471R	
D01	LED IR SIR563SB3F 23/940	303991R	
D102	DIODE 1N5819 SHOTH	303246R	
D201	DIODE 4148 MELF SOD-80C	303195R	
D202	DIODE 1N4148 52MM	302289R	
D401-D405	DIODE 4148 MELF SOD-80C	303195R	
D501	DIODE 1N4148 52MM	302289R	
D504-D505	DIODE 4148 MELF SOD-80C	303195R	
D508-D511	DIODE BA157	300311R	
D512	DIODE 4148 MELF SOD-80C	303195R	
D604	DIODE 1N4148 52MM	302289R	
D605	DIODE 4148 MELF SOD-80C	303195R	
D606-D609	DIODE RFP2007	303308R	
D610	DIODE RGP30MS	303206R	
D611	DIODE 4148 MELF SOD-80C	303195R	
D612-D613	DIODE 1N4148 52MM	302289R	
D614	DIODE RGP10J	303217R	
D615	DIODE RGP30D	303228R	
D616	DIODE SB540	303424R	
D617-D618	DIODE RGP10J	303217R	
D619	DIODE BA157	300311R	
D620	DIODE 1N4148 52MM	302289R	
D621-D701	DIODE 4148 MELF SOD-80C	303195R	
D702-D704	DIODE 1N4148 52MM	302289R	
D705-D707	DIODE 4148 MELF SOD-80C	303195R	
D708	DIODE 1N4007	302948R	
DOWN	TACT SWITCH 2 LEG (MTSB)	010844R	
EJECT	TACT SWITCH 2 LEG (MTSB)	010844R	
F103	SAW FILTER X6966M	056298R	
FORWARD	TACT SWITCH 2 LEG (MTSB)	010844R	
FS601	FUSE 3.15AT (215)	054280R	
IC01	IC-CHIP S3C1840DA9/SMB91 T&R	452382R	
IC101	IC VCTI-ECO 90DEG.-NO VD-FLASH-F1	453987R	
IC201	IC-CHIP MC14052BDR2 G T&R	453174R	
IC301	IC AN5277	453170R	
IC401	IC-CHIP AT24C16AN 10SU2.7 TAPE&REEL	452662R-2	
IC501	IC TDA8357 J N2	452975R-1	
IC601	IC MC33269T G 0.8A LD TO220	453177R	
IC602	IC ICE1QS01	452785R	
IC603-IC604	IC LM317LZRAG 0.1A TO92	453176R	
IC605	IC TL431CLPRA G	451885R-1	
IC606-IC608	IC-CHIP NCP1117DTARK G (DPAK) T&R TO252	453095R	
IC609	IC TL431CLPRA G	451885R-1	
L101-L102	COIL CHOKE 10UH LAN02 280MA/1R	053823R	
L103	COIL 10UH LAL02	053331R	
L104-L105	COIL 10UH K (TAIYO) LAL03	053711R	
L106	COIL 10UH LAL02	053331R	
L107-L108	COIL CHOKE 10UH LAN02 280MA/1R	053823R	
L109-L110	COIL 10UH K (TAIYO) LAL03	053711R	
L111	COIL 10UH K AXIAL LAL04	053500R	
L112	COIL CHOKE 10UH LAN02 280MA/1R	053823R	
L113	COIL 4.7UH LAL03	053734R	
L114	COIL 4.7UH LAL04 52MM	053732R	
L115	COIL-CHIP 8.2UH K /0805	053806R	
L116-L117	COIL 10UH LAL02	053331R	
L203-L204	COIL-CHIP 10UH K 0805	053804R	
L207-L208	COIL-CHIP 10UH K 0805	053804R	
L301	COIL 10UH K (TAIYO) LAL03	053711R	
L401-L403	COIL CHOKE 10UH LAN02 280MA/1R	053823R	
L404	COIL 10UH K (TAIYO) LAL03	053711R	
L405	COIL CHOKE 10UH LAN02 280MA/1R	053823R	
L406	COIL 4.7UH LAL03	053734R	
L504	COIL H-LIN 100UH	51600	See the "CPT Difference List", too
L601	LINE FILTRE 2*18MH R<0.7R /2416008010122	51628	
L602	COIL CHOKE 50UH DIALTECH	053739R-10	

Insertion Point	Object description	Component	Definition
L603	COIL 4.7UH LAL03	053734R	See the "CPT Difference List", too
L701	COIL- CHOKE 10UH R0814 14.1	053352R	
MENU	TACT SWITCH 2 LEG (MTSB)	010844R	
P602	R-VAR 10K V(2.5MM) 5*3	133118R	
PH601	IC OPTOCOUPLER TCET1100V310U27 VISHAY	452297R-2	
PLAY/PAUSE	TACT SWITCH 2 LEG (MTSB)	010844R	
PR/VOL	TACT SWITCH 2 LEG (MTSB)	010844R	
Q01	CER.RESONATOR GSB455E	056210R	
Q102	CRYSTAL 20.25MHZ 20PPM (106478)	056038R	
R01	RC-CHIP 0R /1206	179002R	
R102-R108	RC-CHIP 10K J 1/16W /0603	173108R	
R109-R110	RC-CHIP 100R J 1/16W /0603	171107R	
R113-R115	RC-CHIP 100R J 1/16W /0603	171107R	
R119	RC-CHIP 33K J 1/16W /0603 TAPE	173332R	
R120	RC-CHIP 0R /0603 1.6"0.8 TAPE	179005R	
R121	RC-CHIP 1K J 1/16W /0603	172104R	
R122-R123	CFR 220R J 1/4W 52MM	101223R	
R124	RC-CHIP 6.8K J 1/16W /0603	172686R	
R125-R126	CFR 4.7K J 1/4W /6 26MM	102487R	
R127	CFR 47K J 1/4W /6 26MM	103484R	
R128	RC-CHIP 100R J 1/16W /0603	171107R	
R129	CFR 100R J 1/4W 26MM	101117R	
R130	RC-CHIP 100R J 1/16W /0603	171107R	
R131-R132	CFR 100R J 1/4W 26MM	101117R	
R133	RC-CHIP 0R /0805 2*1.25	179001R	
R201-R202	RC-CHIP 18K J 1/16W /0603 TAPE	173183R	
R203-R204	RC-CHIP 330R J 1/16W /0603 TAPE	171336R	
R205-R206	RC-CHIP 560R J 1/16W/0603 TAPE	171562R	
R207-R209	RC-CHIP 470R J 1/16W /0603 TAPE	171472R	
R210	CFR 10K J 1/4W /6 52MM	103116R	
R211	RC-CHIP 0R /0603 1.6"0.8 TAPE	179005R	
R212	RC-CHIP 180R J 1/16W /0603	171184R	
R213-R223	RC-CHIP 75R J 1/16W /0603	170754R	
R224	RC-CHIP 180R J 1/16W /0603	171184R	
R225-R226	RC-CHIP 100R J 1/16W /0603	171107R	
R228	CFR 100R J 1/4W 26MM	101117R	
R229	RC-CHIP 100R J 1/16W /0603	171107R	
R230	RC-CHIP 100R J 1/16W /0603	171107R	
R233-R236	RC-CHIP 270R J 1/16W/0603 TAPE	171227R	
R237-R257	RC-CHIP 1K J 1/16W /0603	172104R	
R258	CFR 4.7R J 1/4W /6 26MM	109473R	
R259	CFR 10K J 1/4W /6 52MM	103116R	
R301-R302	RC-CHIP 330R J 1/16W /0603 TAPE	171336R	
R303-R304	RC-CHIP 7.5K J 1/16W /0603	172751R	
R305-R306	RC-CHIP 10K J 1/16W /0603	173108R	
R307	RC-CHIP 6.8K J 1/16W /0603	172686R	
R308	RC-CHIP 1K J 1/10W /0805	172101R	
R311	CFR 1K J 1/4W /6 52MM	102101R	
R312-R312	RC-CHIP 3.3K J 1/16W /0603	172336R	
R314	RC-CHIP 2.2K J 1/16W/0603 TAPE	172224R	
R317-R318	RC-CHIP 56K J 1/16W /0603	173563R	
R319-R320	RC-CHIP 4.7K J 1/16W /0603 TAPE	172479R	
R323-R324	CFR 4.7R J 1/4W /6 26MM	109473R	
R325	RC-CHIP 18K J 1/10W /0805	173182	
R401	RC-CHIP 470R J 1/16W /0603 TAPE	171472R	
R402	RC-CHIP 10K J 1/16W /0603	173108R	
R404-R407	RC-CHIP 100R J 1/16W /0603	171107R	
R408-R409	CFR 100R J 1/4W 26MM	101117R	
R410-R413	RC-CHIP 100R J 1/16W /0603	171107R	
R414-R417	RC-CHIP 270R J 1/16W/0603 TAPE	171227R	
R418	RC-CHIP 1K J 1/16W /0603	172104R	
R419	CFR 1K J 1/4W /6 52MM	102101R	
R420	CFR 10K J 1/4W /6 52MM	103116R	
R423-R424	RC-CHIP 2.7K J 1/16W /0603	172276R	
R425	RC-CHIP 22R J 1/16W /0603 TAPE	170221R	
R427-R431	RC-CHIP 3.3K J 1/16W /0603	172336R	
R432	RC-CHIP 180R J 1/16W /0603	171184R	
R434	RC-CHIP 22K J 1/16W /0603	173229R	
R435	CFR 22K J 1/4W 26MM	103234R	
R436-R437	RC-CHIP 7.5K J 1/16W /0603	172751R	
R439-R441	RC-CHIP 150R J 1/16W /0603	171154R	
R442-R444	RC-CHIP 33R J 1/16W /0603 TAPE	170333R	
R445	RC-CHIP 4.7K J 1/16W /0603 TAPE	172479R	
R446	RC-CHIP 100K J 1/16W /0603	173114R	
R447	RC-CHIP 1.5K J 1/16W /0603 TAPE	172154R	
R448	CFR 10K J 1/4W /6 52MM	103116R	
R449	RC-CHIP 4.7K J 1/16W /0603 TAPE	172479R	
R450	CFR 10K J 1/4W /6 52MM	103116R	
R451	RC-CHIP 5.6K J 1/16W /0603 TAPE	172567R	
R452	RC-CHIP 47K J 1/16W /0603 TAPE	173478R	
R453	RC-CHIP 1.2K J 1/16W/0603 TAPE	172125R	
R454-R460	RC-CHIP 100R J 1/16W /0603	171107R	
R461	RC-CHIP 4.7K J 1/16W /0603 TAPE	172479R	
R462	CFR 4.7K J 1/4W /6 26MM	102487R	
R463	RC-CHIP 220R J 1/16W/0603 TAPE	171224R	
R464	RC-CHIP 22R J 1/10W /0603	170225R	
R466-R467	RC-CHIP 1.5K J 1/16W /0603 TAPE	172154R	
R468	RC-CHIP 1K J 1/16W /0603	172104R	
R472	RC-CHIP 1.5K J 1/16W /0603 TAPE	172154R	
R481	RC-CHIP 15K J 1/16W /0603 TAPE	173153R	
R501	RC-CHIP 18K J 1/16W /0603 TAPE	173183R	
R502	RC-CHIP 220R J 1/16W/0603 TAPE	171224R	
R504	RC-CHIP 1K J 1/16W /0603	172104R	
R506	RM 10K J 1/2W 52MM	113114	
R508	CFR 2.7K J 1/4W /6 52MM	102273R	
R509	RC-CHIP 5.6K J 1/10W /0805	172561R	
R51	CFR 390R J 1/4W /6 26MM	101396R	
R510	RC-CHIP 5.6K J 1/10W /0805	172561R	
R511	RC-CHIP 560K J 1/16W /0603	174563	

Insertion Point	Object description	Component	Definition
R513	RC-CHIP 10K J 1/16W /0603	173108R	
R514	RC-CHIP 10K J 1/16W /0603	173108R	
R515	CFR 2.7K J 1/4W /6 52MM	102273R	
R516-R517	RM 3.9R J 1/2W /9 52MM	111396R	
R52	CFR 220R J 1/4W 26MM	101236R	
R521	RW 4.7R J 7W R.5	129487R	
R522	RMF 0.22R J 1W	119224	See the "CPT Difference List", too
R523	CFR 330R J 1/4W /6 52MM	101331R	See the "CPT Difference List", too
R524	CFR 1.5R J 1/2W /9	109150R	
R525	RMF 10R 1/4W	120118R	
R526	CFR 47K J 1/4W /6 26MM	103484R	
R527	CFR 470R J 1/2W /9 52MM	101471R	
R529	CFR 560R J 1/4W /6 52MM	101562R	
R531-R532	RM 150K J 1/2W ' SAFETY'	114151R	
R533	CFR 0.47R J 1/2W /9 52MM	109472R	
R534	CFR 47R J 1/4W /6 52MM	100473R	
R537	RC-CHIP 56R J 1/16W /0603 TAPE	170560R	
R538	RC-CHIP 1.5K J 1/16W /0603 TAPE	172154R	
R539	RC-CHIP 47K J 1/16W /0603 TAPE	173478R	
R54	CFR 1.5K J 1/4W /6 26MM	102166R	
R540	RC-CHIP 47K J 1/16W /0603 TAPE	173478R	
R541	RC-CHIP 10K J 1/16W /0603	173108R	
R542	RC-CHIP 1.5K J 1/16W /0603 TAPE	172154R	
R55	CFR 1K J 1/4W /6 52MM	102101R	
R56-R57	CFR 470R J 1/4W /6 52MM	101470R	
R58	CFR 390R J 1/4W /6 26MM	101396R	
R59	CFR 220R J 1/4W 26MM	101236R	
R601-R602	RC-CHIP 10K J 1/16W /0603	173108R	
R605	RC-CHIP 1K J 1/16W /0603	172104R	
R606	CFR 1K J 1/4W /6 26MM	102141R	
R608	RC-CHIP 390R %1 1/16W/0603 TAPE	171392R	
R609	RC-CHIP 1K J 1/16W /0603	172104R	
R610	CFR 1K J 1/4W /6 52MM	102101R	
R611	RC-CHIP 2.7K J 1/16W /0603	172276R	
R617	RC-CHIP 22K J 1/16W /0603	173229R	
R618	RC-CHIP 47K J 1/16W /0603 TAPE	173478R	
R619	RM 1M J .5W 52MM SAFETY	115110R	
R620	PTC 9R/2 PIN - 3 CYCLE BOX TYPE	154234R	
R621	RMO 68K J 2W 73MM	113684R	
R624	RC-CHIP 47K J 1/16W /0603 TAPE	173478R	
R625	RC-CHIP 3.3K J 1/16W /0603	172336R	
R626	RC-CHIP 22R J 1/10W /0603	170225R	
R627	CFR 47K J 1/4W /6 26MM	103484R	
R628	RM 115K %1 1/4W	114115R	
R629	CFR 10K J 1/4W /6 26MM	103136R	See the "CPT Difference List", too
R63	CFR 100R J 1/4W 26MM	101117R	
R631	RMO 47K J 1W	113475R	
R632	RC-CHIP 12K J 1/16W /0603 TAPE	173124R	
R634	RC-CHIP 0R /0603 1.6" 0.8 TAPE	179005R	
R635	RW 2.7R K 5W R:15 MM	129272R	
R636	RM 1M J 1W 52MM	115103R	
R637	RC-CHIP 68K J 1/16W /0603	173685R	
R638	CFR 47R J 1/4W /6 52MM	100473R	
R639	CFR 120R J 1/4W 52MM	101124R	
R640	RC-CHIP 33R J 1/16W /0603 TAPE	170333R	
R644	RM 4.7M J 1/2W 52MM 'SAFETY '	115470R	
R645	CFR 47R J 1/4W /6 52MM	100473R	
R648	RC-CHIP 820R J 1/16W /0603 TAPE	171824R	
R649	RPF 0.05R K 1/2W AXIAL	119003R	
R650	RC-CHIP 2.7K %1 1/16W /0603	172278R	
R651	RC-CHIP 39K J 1/16W /0603 TAPE	173394R	
R652	RM 150K J 1/2W ' SAFETY'	114151R	
R654	RC-CHIP 1.3K %1 1/16W/0603 TAPE	172131R	
R656-R658	RC-CHIP 240R %1 1/16W /0603 TAPE	171241R	
R659	RC-CHIP 390R %1 1/16W/0603 TAPE	171392R	
R660-R661	RC-CHIP 2.7K %1 1/16W /0603	172278R	
R663	RC-CHIP 365R %1 1/16W /0603 TAPE	171363R	
R664	RC-CHIP 390R %1 1/16W/0603 TAPE	171392R	
R665	RC-CHIP 470R %1 1/16W /0603 TAPE	171479R	
R666	RC-CHIP 120R %1 1/16W /0805	171128R	
R667	RC-CHIP 820R %1 1/16W /0603 TAPE	171825R	
R668	RC-CHIP 240R %1 1/16W /0603 TAPE	171241R	
R702-R705	RC-CHIP 1K J 1/16W /0603	172104R	
R706-R708	CFR 1K J 1/2W /6 52MM	102105R	
R709-R711	RC-CHIP 220R J 1/16W/0603 TAPE	171224R	
R712-R714	RC-CHIP 3.3K J 1/16W /0603	172336R	
R715	CFR 220R J 1/4W 26MM	101236R	
R716-R718	RMO 12K J 2W	113121R	
R719	CFR 330K J 1/4W /6 52MM	104332R	
R720	CFR 47K J 1/4W /6 26MM	103484R	
R721	CFR 1M J 1/4W /6 26MM	105110R	
R722-R724	RC-CHIP 22R J 1/10W /0603	170225R	
R725	CFR 1.5K J 1/2W /9 52MM	102159R	
R726-R727	CFR 100R J 1/4W 26MM	101117R	
R728	RC-CHIP 100R J 1/16W /0603	171107R	
R729	CFR 470K J 1/4W /6 26MM	104470R	
R730-R732	RC-CHIP 470R J 1/16W /0603 TAPE	171472R	
R920-R921	CFR 75R J 1/4W /6 26MM	100751R	
R922-R923	CFR 470R J 1/4W /6 26MM	101494R	
R940-R941	CFR 180R J 1/2W (A) 52MM	101184R	
R942-R943	CFR 390R J 1/4W /6 26MM	101396R	
REWIND	TACT SWITCH 2 LEG (MTSB)	010844R	
SK202	SCART SOKET HR-DM2441S-O	31197	
STOP	TACT SWITCH 2 LEG (MTSB)	010844R	
T01	TRN BC337-25	401047R	
T102-T205	TRN-CHIP BC848BLT1G SOT23	401141R	
T206-T207	TRN-CHIP BC858BLT1G SOT23	401142R	
T301-T307	TRN-CHIP BC848BLT1G SOT23	401141R	
T401	TRN-CHIP BC818-215 SOT23	401193R	

Insertion Point	Object description	Component	Definition
T403-T406	TRN-CHIP BC848BLT1G SOT23	401141R	
T407-T501	TRN-CHIP BC858BLT1G SOT23	401142R	
T502	TRN BC639	400240R	
T504	TRN 2SD2586	401506R	
T505	TRN BC327-25RL1 G	400901R	
T506-T608	TRN-CHIP BC848BLT1G SOT23	401141R	
T609	TRN 2SK3567 TO220SIS	401512R	
T610	TRN STP20NE06LFP	401335R	
T701-T703	TRN-CHIP BC848BLT1G SOT23	401141R	
T704-T706	TRN BF421	401366R	
T707-T709	TRN 2SC3619	400891R	
TH601	THRYSTOR MCR22-8RL1G	410026R	
TR501	TRANSFORMER HORIZONTAL DRIVE E1	051839R	
TU102	TUNER PS ASIMETRIK ENV57DA5G3R(SEC LL IY	7R2136RPS4	
TV/DVD	TACT SWITCH 2 LEG (MTSB)	010844R	
UP	TACT SWITCH 2 LEG (MTSB)	010844R	
X202	CON.MALE6 LI 2317-6S JST B 6B-XH-A WHIT	38874	
X202-DVD	CABLE 8+6LI BEYAZ L=...K5	KX5511R	
X203	CONN.HOUSING X2003 RED	31857	
X204	CONN.HOUSING X2003 BLACK	31856	
X205	CONN. CINCHBLACK HOR. L6B	032937R	
X301	CONN.HOUSING X2004 GREY	31858	
X302	CONN.HOUSING X2003 GREY	31854	
X401A	CABLE WITH HOLDER 5P L=275 CRT/CHAS	KX5558R	See the "CPT Difference List", too
X402	CONN.HOUS.2P 2317-2S JST B 2B-XH-A RED	032993R	
X402-1	CONN.MALE 5 RIGHT-A 2317-5R JST S 5B-XH-	38889	
X402-2	CONN.HOUSING.2P 2.5MM HORIZ.250G-R	31575	
X402-X402-2	CABLE HAR.CFIZ 2LI TUS T. DVD L=...MM	KX5530R	
X403	CONN.HOUS.3P 2317-3S JST B 3B-XH-A RED	31646	
X403-DVD	CABLE 3'LU 2317 BEYAZ KON.L=330 FER+SUN	Y08509R	
X404	CONN.HOUSING 2.5TMK 2104 GRI	31989	
X406	CONN.HOUS.5P 2317-5S JST B 5B-XH-A RED	031196R	
X406-X402-1	CABLE 5'LI RED/WHI CON.L=370 K5	KX5512R	
X407	CONN.HOUS 2P 2317-2S JST B 2B-XH-A WHITE	31245	
X407-DVD	CABLE BLEND/FER. 2LI L=430 DIG.AUDIO	KX5504R	
X501	CONN.HOUSING 2'LI GREY	31850	
X502	CONN.HOUSING LOCKED 5/4	31777	
X503	CABLE WITH HOLDER 3+1P L=430 CRT/SASI K1	KX1553R	See the "CPT Difference List", too
X601	CON.HOUSING 2P MALE	31675	
X602	CON.HOUSING 2P MALE TPK75(POW)12.6 RED	31797	
X603	CON.MALE 5'LI 2317-5S JST B5B-XH-A BLACK	38890	
X603-DVD	CABLE 5'LI BLACK/WHI MINI KON.L=...K5 FE	KX5513R	
X703	CRT SOCKET NARROW INCHANG	31532	See the "CPT Difference List", too
X921	KONN. CINCH YELLOW HOR.14.1	031165R	
X922	KONN. CINCH RED HOR.14.1	031164R	
X923	KONN. CINCH WHITE HOR.14.1	031163R	
X925	CONN.S-VHS	031795R	
X941	HEADPHONE JACK YKB21-5103	031423R	
ZD501	DIODE Z. BZX55C 15V	303826R	
ZD502	DIODE Z. BZX55C33 52MM	302318R	
ZD503-ZD504	DIODE Z. BZX55C8V2 26MM	302294R	
ZD601	DIODE Z.TZMB9V1	303454R	
ZD602	DIODE Z. BZX55C5V1	302298R	
	DEGAUS BOB KPL 21" B.SARGILI (9R PTC)	621167-AS	
	CPT SS A51QDX993X030 P.FLAT(MACAR)	056321-SS0	
	K5 CHASSIS.SD 21" P/BG/SX/2SC/K/S/A-OSD	KX5110	
TR502	DST 21PF TR/2416003313132 28KV K1	040150R-T1	See the "CPT Difference List", too
	DVD COMBO DIVX LOADER HUALU	KX5001R	
	HOP. 8R 7W(NOM):/10W (MAX) 120X50	7ZY107R	
TR601	SMPS 20/21 EL/ 2084.0130 23V	050150R-E1	See the "CPT Difference List", too

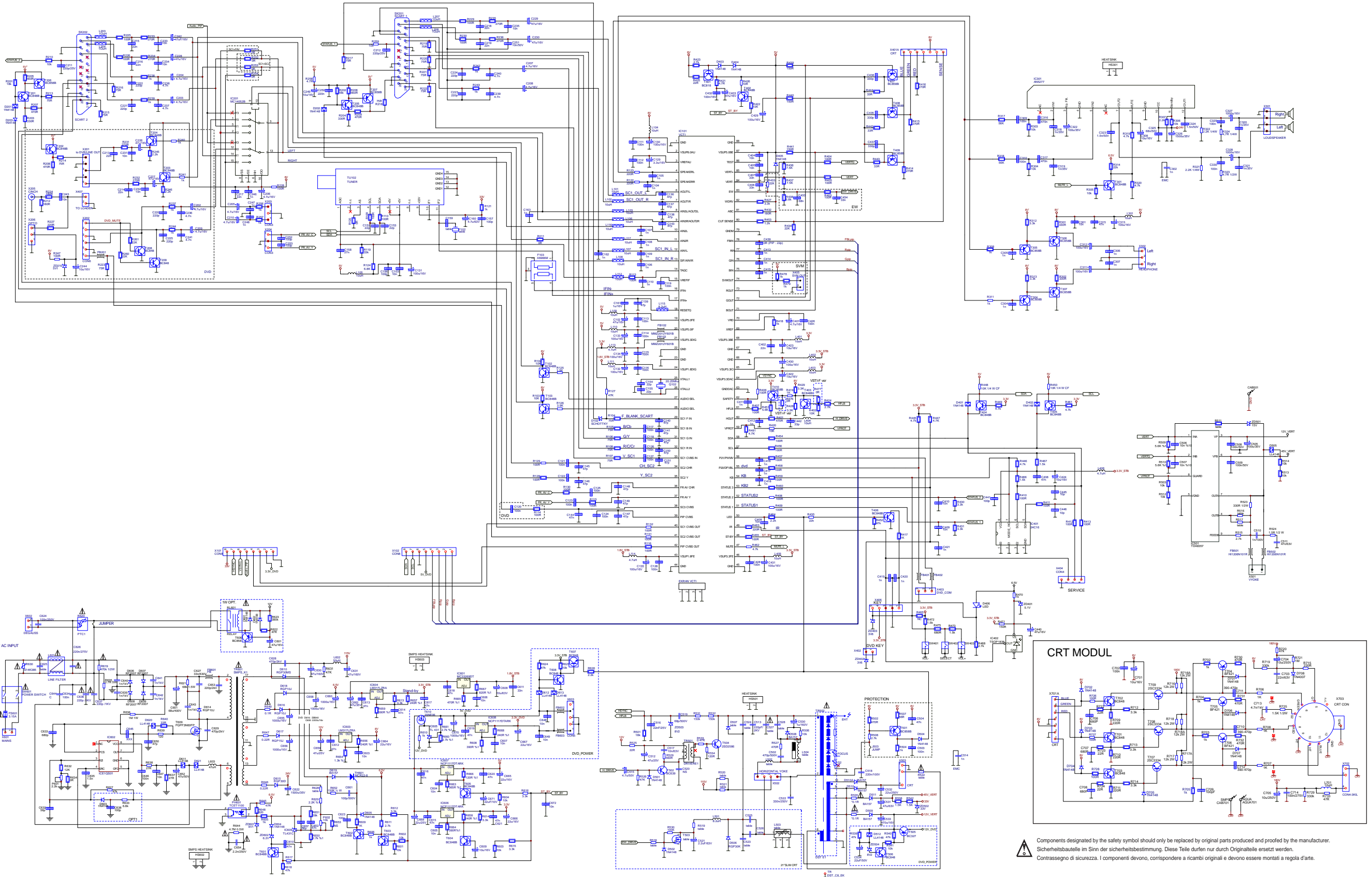

 Components designated by the safety symbol should only be replaced by original parts produced and proofed by the manufacturer.
 Sicherheitsbauteile im Sinn der sicherheitsbestimmung. Diese Teile dürfen nur durch Originaleile ersetzt werden.
 Contrassegno di sicurezza. I componenti devono, corrispondere a ricambi originali e devono essere montati a regola d'arte.