

SOLID STATE INTEGRATED AMPLIFIER

# **L80/81/V**

## **SERVICE MANUAL**

## Circuit Description

### 1. Equalizer Amp. Section

Adopted is an Operational I.C., RAYTHEON RC-4558-DN, which is of 8-pin Dual In-Line Package Type. A built-in phase compensation capacitor for high frequency makes it impossible to adjust the value even for the R & D works. This contributes so much to the various characteristics and sonic quality. Fundamentally at the negative feedback amplifier, especially at the equalizer amplifier, the high frequency phase compensation should be kept in proper condition. When the compensation is too weak, the circuit becomes unstable and in many case oscillation is inevitable. In such state, the sonic quality is out of discussion.

On the contrary, if the phase compensation is too strong, the distortion at high frequency range is much increased and at the same time it affects sonic quality to a great extent. That is why the input impedance is reduced by the high frequency phase compensation (e.g., Mirror Integration), which is indispensable to the multi-stage amplifier, and linearity of the former stage is affected to deteriorate the distortion characteristic. The capacitor inserted between Q6 and Q7 is for high frequency phase compensation.

To comply with the unique gain distribution of the L-80V, we considered a semi-conductor device which offers more inherent gain, comparing with the conventional 3-stage E-E Feedback type equalizer. The I.C. offers more than 100dB of inherent gain, and the loop gain at 1KHz is approximately 37dB, which ensures sufficient amount of Negative Feedback at low frequency range. The RC-4558-dN is carefully selected to fulfill no more than 1.5uV Input-Conversion Noise Voltage. Despite that the phase compensation is included, proper compensation is realized as well as the stability, and therefore any type of cartridge can be connected. As for the load condition, the I.C. circuitry exceeds the conventional 3-stage E-E Feedback Circuitry.

### 2. Power Amp. Section

Adopted is the fully complementary circuit configuration, which seems to be the most ideal one at present. Signals are supplied from the equalizer amp directly to the power amp section via buffer stage. The rated output of 50W/ch is realized at 190mV of equalizer output voltage (Input Sensitivity 2.8mV). This means the voltage gain is approximately 39dB, which is higher by some 6dB than that of standard power amplifiers. And naturally various problems must be considered. First, the harmonic distortion, especially at high frequency range, tends to be worse. In actuality, distortion at 10KHz is twice as bad as that of the amplifier having some 33dB voltage gain. This is of course in the case of using the same semi-conductor device.

To compensate the lost gain caused by applying Negative Feedback, it is necessary to increase the inherent gain by studying the inherent characteristics. At the first differential input stage, it is of utmost necessity to reduce the DC offset voltage at the output terminal, and therefore required are transistors of matched hfe characteristic, and of high hfe at the operational current area. For the L-80V, adopted is that of 3dB allowance between minimum and maximum. The standard hfe value is 500, which is very high. Also at this stage a zener diode is arranged to deal with the mains power fluctuation.

#### Second differential Amp. Stage

This stage plays an important role to decide distortion ratio, especially at high frequency range. Fundamentally transistors of high  $f_T$  and low  $C_{ob}$  are necessary, and high load impedance should be realized since most of the voltage gain depends on this stage. Therefore inherent gain is obtained sufficiently up to high frequency range thanks to constant current drive. The  $f_T$  of the transistors is more than 130MHz ( $I_c = 10mA$ ), and the  $C_{ob}$  is less than 2pF, which is far above the audio frequency band. Nevertheless from the view point of  $f_{ae}$ , the  $f_{ae}$  is 75kHz in case hfe is determined as 200. Thus such high frequency characteristic is indispensable.

Also at the driver stage and the power stage, transistors of high  $f_T$  are necessary when good high frequency characteristic is required, but there exists a close relation between  $f_T$  and breakdown of transistors: When  $f_T$  is extended, high frequency becomes unstable, and power transistors are easily damaged due to oscillation etc. And recently, this is solved by increasing VCE(sat), the saturation voltage between collector and emitter, which deteriorates voltage utilization ratio as well as linearity of hfe at the time of huge current driving.

The power transistors adopted in the L-80V ensure excellent reliability against breakdown by using larger scale pellet than that of the conventional transistors. Therefore, the L-80V realized excellent reliability against breakdown without deteriorating high frequency characteristic. Of course the linearity of hfe is excellent.

Thus after exhaustive study of the semi-conductor device, we increased the loop gain, and the high frequency characteristic is far much improved. This is because the high frequency compensation could be slighter thanks to the betterment of the inherent characteristics.

### 3. Tone Control Section

Adopted is the LUX NF type with turnover frequency selector of two steps both for bass and treble respectively.

Bass turnover frequency:	150Hz,	300Hz
Treble turnover frequency:	3KHz,	6KHz

### 4. Delay Time Muting Section

In the amplifier of Direct-Coupled configuration, the speaker loads are directly connected to the power transistors, therefore it may be possible to impair the speaker systems in case DC potential appears at the output terminal. Also a slight DC potential gives some bias to the speakers, which affects the sonic quality adversely. Thus the protection circuit is indispensable to eliminate these phenomena. For the L-80V, the Delay Time Muting Circuit operates as a protection circuit at the same time. Therefore the amplifier is muted 5 - 10 seconds at the time of turning the power switch on.

### Block Diagram

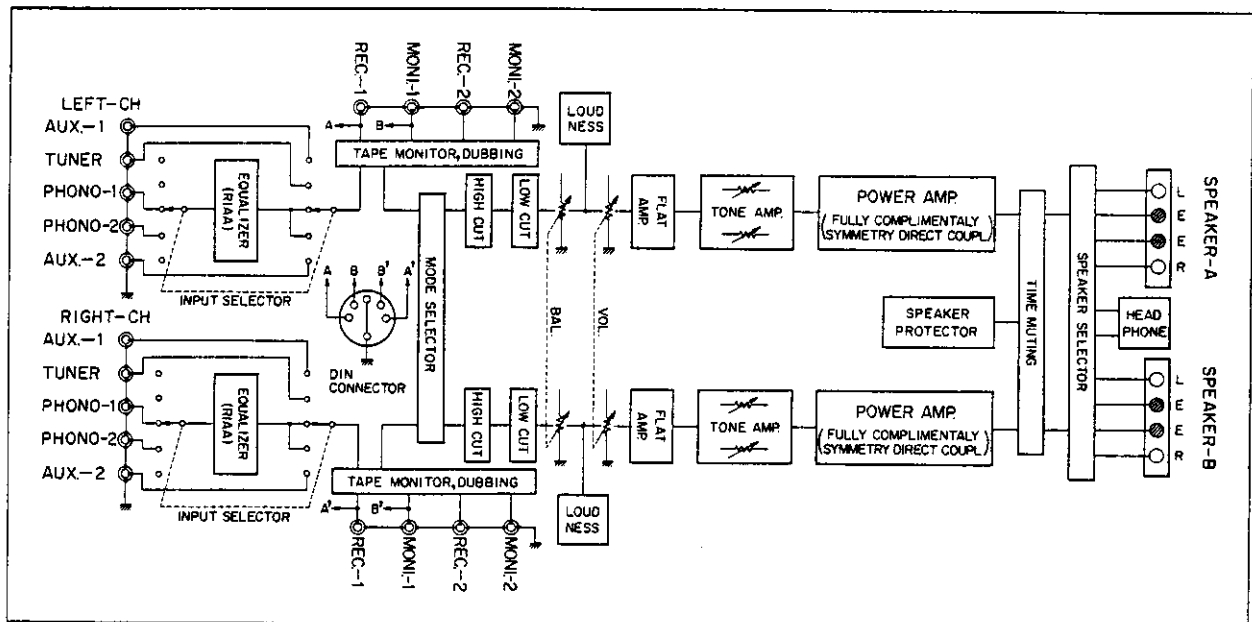

Replacement Parts List

L-80

PB-891 (Resistors; 1/4W,  $\pm 5\%$  unless otherwise noted.)

R101	1M	3Y, 2Y	R120	120	3X, 2X	R604	10K	5Y
102	5.6K	3Y, 2Y	121	100 1/2W	3Y, 2Y	605	10K	5Y
103	47	3X, 2X	122	100 1/2W	3Y, 2Y	606	3.9K	4Y
104	47	3X, 2X	123	0.33 3W	3Y, 2Y	607	2.7K	4Y
105	6.8K 1/2W	3X, 2X	124	0.33 3W	3Y, 2Y	608	18K	5Y
106	6.8K 1/2W	3X, 2X	125	22 1W	3Y, 2Y	609	18K	5Y
107	47K	3Y, 2Y	R201	120K	1X, 1Y	R701	4.7K 1W	5X
108	3.3K	3Y, 2Y	202	3.3K	1X, 1Y	702	4.7K 1W	5X
109	3.3K	3Y, 2Y	203	390K	1X, 1Y	703	27K	4Y
110	8.2K	3Y, 2Y	204	1K	1X, 1Y	704	27K	4X
111	180	3X, 2X	205	39K	1X, 1Y	705	1K 1/2W	4X
112	22 1/2W	3X, 2X	206	560K	1X, 1Y	706	3.3K 1/2W	4X
113	47K	3Y, 2Y	207	1K	1X, 1Y	707	1.8K 1/2W	4X
114	1.2K	3Y, 2Y	208	680	1X, 1Y	708	1.8K 1/2W	5X
115	1.5K 1/2W	3X, 2X	209	220	1X, 1Y	709	4.7K 1W	4X
116	470	3X, 2X	R601	33 1/2W	5Y	710	4.7K 1W	5X
117	33K 1/2W	3X, 2X	602	56K	5Y			
118	22 1/2W	3X, 2X	603	1K	5Y			
119	3.9K	3Y, 2Y						

C101	10uF	10V	3Y, 2Y	C601	22uF	50V	5Y
102	220pF		3Y, 2Y	602	220uF	10V	4Y
103	100uF	16V	3Y, 2Y	603	220uF	16V	4Y
104	100uF	50V	3X, 2X	604	220uF	16V	4Y
105	47pF		2X, 3X	C705	220uF	35V	4X
106	47pF		3Y, 2Y	706	220uF	35V	5X
107	33uF	10V	3Y, 2Y	707	100pF		4Y
108	100uF	50V	3X, 2Y	708	100pF		4X
109	150pF		3X, 2X	709	100uF	35V	4X
110	0.022uF		3X, 2X	710	100uF	35V	4X
111	470uF	6.3V	3Y, 2Y	711	100uF	35V	4X
112	1uF	50V	2X	712	47uF	35V	4X
113	0.04uF		3X	713	100uF	35V	4X
114	1uF	50V	2X	714	100uF	35V	4X
115	0.04uF						
116	0.1uF		3Y, 2Y				
C201	2.2uF	25V	1X, 1Y				
202	22uF	10V	1X, 1Y				
203	1800pF		1X, 1Y				
204	6200pF		1X, 1Y				
205	0.47uF		1X, 1Y				
206	0.04uF		1Y				
207	0.04uF		1X				

Q101	2SA750	2Y, 3Y	Q601	2SD571	5Y
102	2SA750	2Y, 3Y	602	2SC945	5Y
103	2SC1940	2X, 3X	603	2SA733	4Y
104	2SC1940	2Y, 3Y	604	2SC945	4Y
105	2SA915	2X, 3X	605	2SC945	4Y
106	2SC945	2Y, 3Y	Q701	2SD571	4X
107	2SB536	2X, 3X	702	2SB605	4X
108	2SD381	2X, 3X			
Q201	RC-4558	1Y			

D101	RD-12EB	2X, 3X	D702	1N-4002	5X
102	VD-1221	2X, 3X	703	1N-4002	5X
103	VD-1221	2Y, 3Y	704	1N-4002	5X
D601	1N-4002	5Y	705	1N-4002	5X
602	1N-4002	5Y			
603	1S-1555	5Y			

VR101	4.7K-B	2X, 3X
102	4.7K-B	2Y, 3Y

PB-894

R501	27K	R502	12K	R503	12K
C501	220pF	C502	0.082uF		

PB-892

R301	680K	R307	68K	R314	1M
302	470K	308	1K	315	10K
303	4.7K	309	10K	316	1M
304	100K	310	82K	317	1M
305	8.2K	311	27K		
306	18K	312	10K		

C301	4.7uF	16V	C307	22pF	
302	33uF	10V	308	2.2uF	25V
303	0.047uF		310	0.033uF	
304	47uF	10V	311	0.1uF	
305	100uF	35V	312	0.0022uF	
306	100uF	10V	313	0.0012uF	

Q301	2SC-1222
302	2SA-750

PB-893

R401	18K	3X	C402	0.033uF		2X, 3X
403	2.7K	2X, 3X	405	4.7uF	16V	1X, 3X
404	18K	1X, 3X	406	100uF	6.3V	1Y, 2Y
405	1K	1X, 2Y	407	0.04uF		1X, 2Y
406	1K	2X, 2Y	408	100uF	35V	
410	220K	1X, 2X	409	2.2uF	25V	1Y, 3X
411	39K	1X, 2X				
412	5.6K	1Y, 2X				
413	1.5K	1X, 2X				
414	100K	3X, 1Y				

Q401	2SC-1222	VR401	100K-B
------	----------	-------	--------

Idle Adjust & Zero DC Offset

**TOP VIEW**

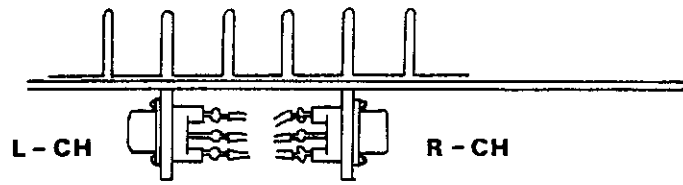

PB-891

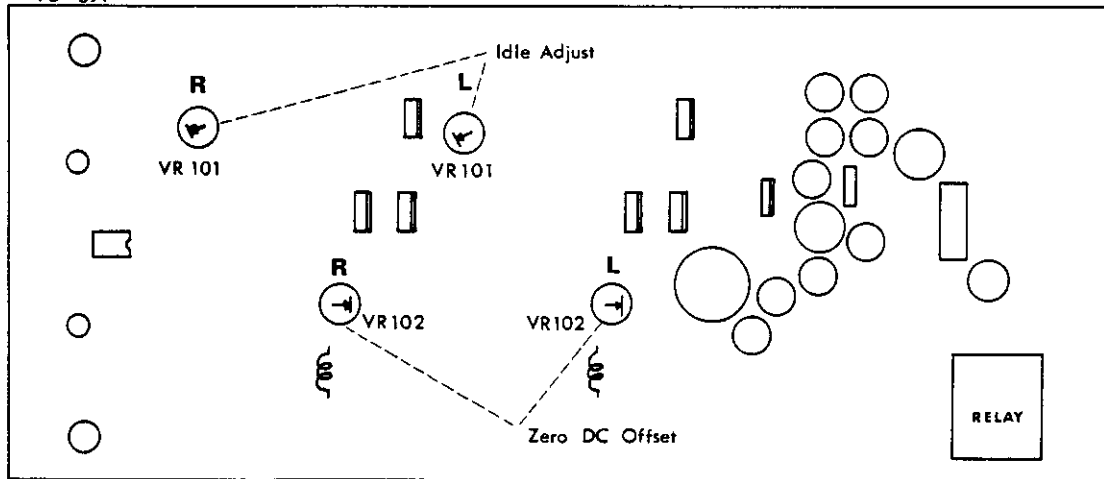

**FRONT VIEW**

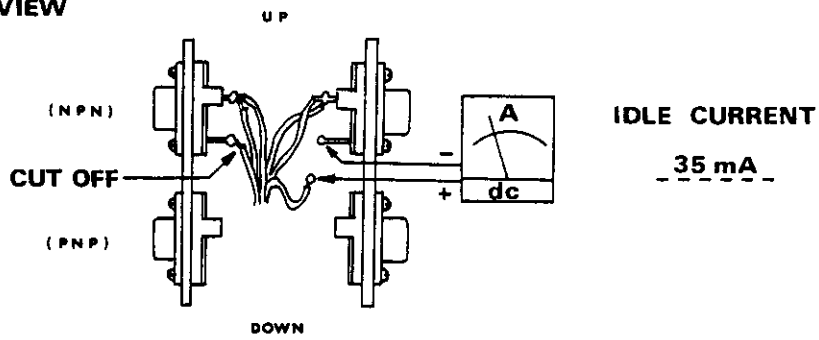

PB-891

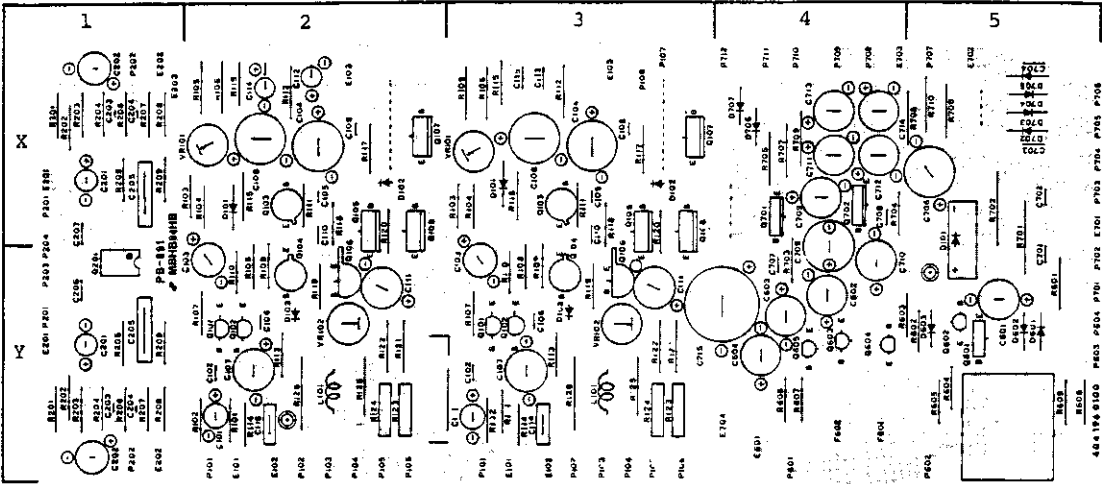

PB-892

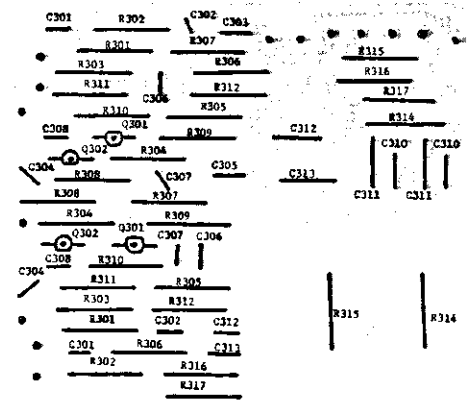

L-80V

PB-891 (Resistors; 1/4W, ±5% unless otherwise noted.)

R101	1M	3Y, 2Y	R120	120	3X, 2X	R604	10K	5Y
102	5.6K	3Y, 2Y	121	100 1/2W	3Y, 2Y	605	10K	5Y
103	47	3X, 2X	122	100 1/2W	3Y, 2Y	606	3.9K	4Y
104	47	3X, 2X	123	0.33 3W	3Y, 2Y	607	2.7K	4Y
105	6.8K 1/2W	3X, 3Y	124	0.33 3W	3Y, 2Y	608	18K	5Y
106	6.8K 1/2W	3X, 2X	125	22 1W	3Y, 2Y	609	18K	5Y
107	47K	3Y, 2Y	201	120K	1X, 1Y	R701	4.7K 1W	5X
108	3.3K	3Y, 2Y	202	3.3K	1X, 1Y	702	4.7K 1W	5X
109	3.3K	3Y, 2Y	203	390K	1X, 1Y	703	27K	4Y
110	8.2K	3Y, 2Y	204	1K	1X, 1Y	704	27K	4X
111	180	3X, 2X	205	39K	1X, 1Y	705	1K 1/2W	4X
112	22 1/2W	3X, 2X	206	560K	1X, 1Y	706	3.3K 1/2W	4X
113	47K	3Y, 2Y	207	1K	1X, 1Y	707	1.8K 1/2W	4X
114	1.2K	3Y, 2Y	208	680	1X, 1Y	708	1.8K 1/2W	5X
115	1.5K 1/2W	3X, 2X	209	220	1X, 1Y	709	4.7K 1W	4X
116	470	3X, 2X	601	100 1/2W	5Y	710	4.7K 1W	5X
117	33K 1/2W	3X, 2X	602	56K	5Y			
118	22 1/2W	3X, 2X	603	1K	5Y			
119	3.9K	3Y, 2Y						

C101	10uF	10V	3Y, 2Y	C601	22uF	50V	5Y
102	220pF		3Y, 2Y	602	220uF	10V	4Y
103	100uF	16V	3Y, 2Y	603	220uF	16V	4Y
104	100uF	50V	3X, 2X	604	220uF	16V	4Y
105	47pF		2X, 3X	705	220uF	35V	4X
106	47pF		3Y, 2Y	706	220uF	35V	5X
107	33uF	10V	3Y, 2Y	707	100pF		4Y
108	100uF	50V	3X, 2Y	708	100pF		4X
109	150pF		3X, 2X	709	100uF	35V	4X
110	0.022uF		3X, 2X	710	100uF	35V	4X
111	470uF	6.3V	3Y, 2Y	711	100uF	35V	4X
112	1uF	50V	2X	712	47uF	35V	4X
113	0.04uF		3X	713	100uF	35V	4X
114	1uF	50V	2X	714	100uF	35V	4X
115	0.04uF						
116	0.1uF		3Y, 2Y				
201	2.2uF	25V	1X, 1Y				
202	22uF	10V	1X, 1Y				
203	1800pF		1X, 1Y				
204	6200pF		1X, 1Y				
205	0.47uF		1X, 1Y				
206	0.04uF		1Y				
207	0.04uF		1X				

Q101	2SA750	2Y, 3Y	Q601	2SD571	5Y
102	2SA750	2Y, 3Y	602	2SC945	5Y
103	2SC1507	2X, 3X	603	2SA733	4Y
104	2SC1507	2Y, 3Y	604	2SC945	4Y
105	2SB536	2X, 3X	605	2SC945	4Y
106	2SC945	2Y, 3Y	701	2SD571	4X
107	2SB536	2X, 3X	702	2SB605	4X
201	RC-4558	1Y	108	2SD381	2X, 3X

D101	RD-12EB	2X, 3X	D702	1N4002	5X
102	VD-1221	2X, 3X	703	1N4002	5X
103	VD-1221	2Y, 3Y	704	1N4002	5X
601	1N-4002	5Y	705	1N4002	5X
602	1N-4002	5Y			
603	1S-1555	5Y			

VR101	4.7K-B	2X, 3X
102	4.7K-B	2Y, 3Y

PB-894

R501	27K	R502	12K	R503	12K
C501	220pF	C502	0.082uF		



PB-892

R301	680K	R307	68K	R314	1M
302	470K	308	1K	315	10K
303	4.7K	309	10K	316	1M
304	100K	310	82K	317	1M
305	8.2K	311	27K		
306	18K	312	10K		

C301	4.7uF	16V	C307	22pF
302	33uF	10V	308	25V - 2.2uF
303	0.04uF		310	0.033uF
304	47uF	10V	311	0.1uF
305	100uF	35V	312	0.0022uF
306	100uF	10V	313	0.0012uF

Q301	2SC-1222
302	2SA-750

PB-893

R401	18K	R408	1M
402	1M	409	3.3K
403	2.7K	410	220K
404	18K	411	39K
405	1K	412	5.6K
406	1K	413	1.5K
407	1M	414	100K

C401	0.033uF	C406	100uF - 6.3V
402	0.033uF	407	0.04uF
403	0.0012uF	408	100uF - 35V
404	0.0027uF	409	2.2uF - 25V
405	4.7uF - 16V		

Q401	2SC-1222
------	----------

VR401	100K-B
402	50K-B

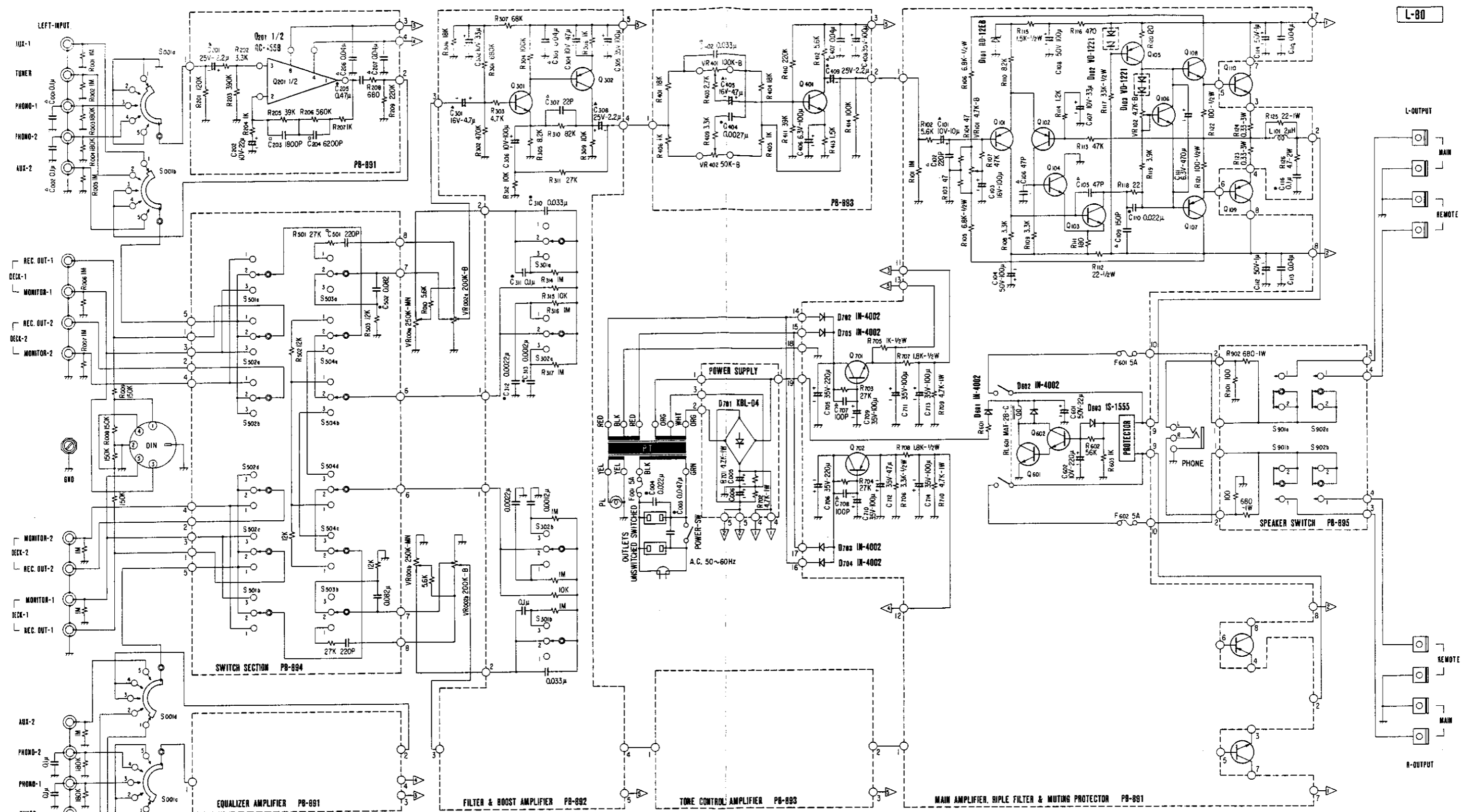

S001a, 901b, 001c, 001d... FUNCTION (1. AUX-1, 2. TUNER, 3. PHONE-1, 4. PHONE-2, 5. AUX-2)  
 S301a, 301b... LOW CUT (1. SUBSONIC, 2. DEFEAT, 3. 70Hz)  
 S501a, 501b... MONITOR (1. DECK-2, 2. SOURCE, 3. DECK-1)  
 S502a, 502b, 502c, 502d... DUBBING (1. DECK-2 TO DECK-1, 2. SOURCE, 3. DECK-1 TO DECK-2)  
 S503a, 503b... LOUDNESS (1. LOW FREQUENCY ONLY, 2. DEFEAT, 3. LOUDNESS IN)

S504a, 504b, 504c, 504d... MODE (1. MONO, 2. STEREO, 3. REVERSE)  
 S901a, 901b... MAIN SPEAKER (1. OFF, 2. ON)  
 S902a, 902b... REMOTE SPEAKER (1. OFF, 2. ON)  
 VR001a, 001b... BALANCE CONTROL  
 VR002a, 002b... VOLUME CONTROL  
 VR401a, 401b... BASS CONTROL  
 VR402a, 402b... TREBLE CONTROL

Q301, 401... 2SC-1222  
 Q101, 102, 302... 2SA-750  
 Q103, 104... 2SC-1940  
 Q105... 2SA-915  
 Q107... 2SB-536  
 Q108... 2SD-381  
 Q109... 2SB-545-A  
 Q110... 2SD-188-A  
 Q702... 2SB-605  
 Q601, 701... 2SD-571  
 Q106, 802... 2SC-945  
 C005, 006... 50V-6800µ  
 R001... 33-1/2W  
 P.T. ... P-1980-B

1. Unless otherwise specified, all resistors are in ohm ¼ watt, all capacitors are in micro farad (µF).  
 2. Transistors, IC and diodes may be replaced with any types having comparable rating.  
 3. There might be slight changes in the actual set.

**LUX CORPORATION, JAPAN**

HEAD OFFICE & FACTORY 1-8-31 NAGAHASHI, NISHINARI-KU, OSAKA  
 PHONES: 632 0031 CABLE: LUXELECT OSAKA  
 TELEX: J63694

**LUX AUDIO OF AMERICA LTD.**

200 AERIAL WAY, SYOSSET, NEW YORK 11791, U.S.A.  
 PHONE: (516)822-7070

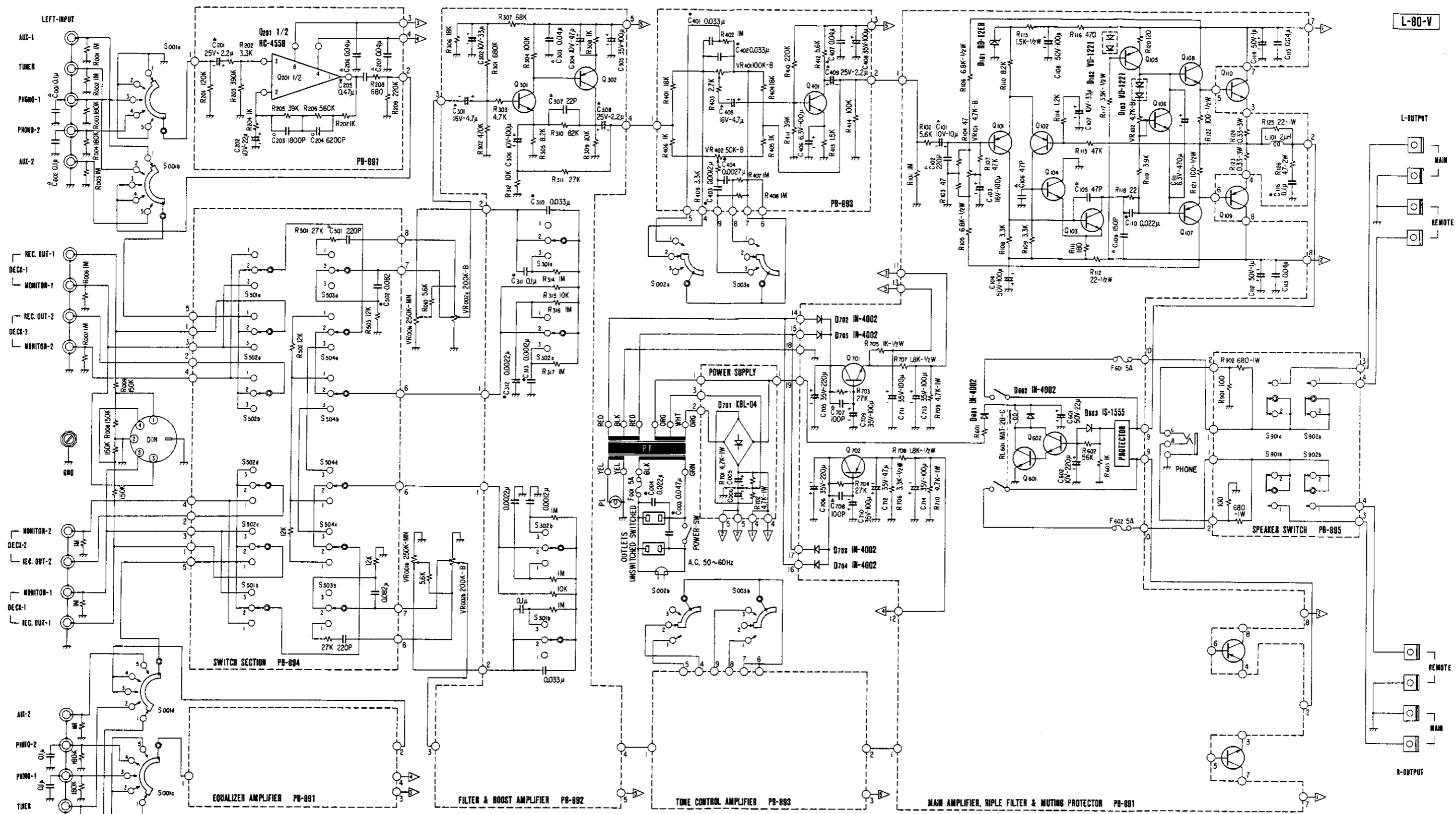

S001a, 801b, 001c, 001d... FUNCTION (1. AUX-1, 2. TUNER, 3. PHONE-1, 4. PHONE-2, 5. AUX-2)  
 S301a, 301b... LOW CUT (1. SUBSONIC, 2. DEFEAT, 3. 70Hz)  
 S302a, 302b... HIGH CUT (1. 12KHz, 2. DEFEAT, 3. 7KHz)  
 S002a, 002b... BASS (1. 150Hz, 2. DEFEAT, 3. 300Hz)  
 S003a, 003b... TREBLE (1. 3KHz, 2. DEFEAT, 3. 6KHz)  
 S501a, 501b... MONITOR (1. DECK-2, 2. SOURCE, 3. DECK-1)  
 S502a, 502b, 502c, 502d... DUBBING (1. DECK-2 TO DECK-1, 2. SOURCE, 3. DECK-1 TO DECK-2)  
 S503a, 503b... LOUDNESS (1. LOW FREQUENCY ONLY, 2. DEFEAT, 3. LOUDNESS IN)

S504a, 504b, 504c, 504d... MODE (1. MONO, 2. STEREO, 3. REVERSE)  
 S901a, 901b... MAIN SPEAKER (1. OFF, 2. ON)  
 S902a, 902b... REMOTE SPEAKER (1. OFF, 2. ON)  
 VR001a, 001b... BALANCE CONTROL  
 VR002a, 002b... VOLUME CONTROL  
 VR401a, 401b... BASS CONTROL  
 VR402a, 402b... TREBLE CONTROL

Q301, 401... 2SC-1222  
 Q101, 102, 302... 2SA-750  
 Q103, 104... 2SC-1507  
 Q105, 107... 2SB-536  
 Q108... 2SD-381  
 Q109... 2SB-541-A  
 Q110... 2SD-388-A  
 Q702... 2SB-605  
 Q801, 701... 2SD-571  
 Q106, 602... 2SC-945  
 C005, 006... 50V-10000µ  
 R801... 100-1/2W  
 P.T. ... P-1964

1. Unless otherwise specified, all resistors are in ohm 1/4 watt, all capacitors are in micro farad (µF).  
 2. Transistors, IC and diodes may be replaced with any types having comparable rating.  
 3. There might be slight changes in the actual set.