

SERVICE MANUAL

SERVICE SAFETY PRECAUTIONS (UL)

1. Use exact replacement parts for critical locations marked "⚠"
2. Return lead dress to original position and re-install protective covers.
3. Before returning to customer, test for shock hazard; use either method A or B:
 - A. Leakage test "cold":
 1. Unplug the AC cord; turn power switch ON.
 2. Connect one lead of High Voltage Insulation Tester to both prongs of the AC plug.
 3. Touch other lead to all exposed metal parts.
 4. Impedance measurement must be 0.3-5.0 Megohms.
 - B. Leakage test, "live" :
 1. Plug unit directly into the AC outlet: do not use isolation transformer.
 2. Connect one lead of the Leakage Current Tester to earth ground.
 3. Touch other lead to all exposed metal parts.
 4. Leakage measurement must be less than 0.5 milliamps.

**214/216
STEREO POWER
AMPLIFIER**

**214/216
STEREO POWER
AMPLIFIER**

TABLE OF CONTENTS

SPECIFICATIONS	3
REAR PANEL	4
FRONT PANEL	4
PCB LAYOUT	5
EXPLODED VIEW PARTS LIST	6
EXPLODED VIEW	7
WIRING DIAGRAM	8
SCHEMATIC DIAGRAMS	
214	9
216	10
ELECTRICAL PARTS LIST	11
ALIGNMENT PROCEDURE	14
PACKING DIAGRAM	15

NOTE: The "A", given after an item number, refers to the part number for the model 216 only.

SPECIFICATIONS

Specifications are measured in accordance with EIA Standard RS-490 (IHF T-202) for amplifiers.

STEREO MODE	214	216
Continuous Power Output 8 ohms	80W	125W
(20Hz/1kHz/20kHz at rated THD)	4 ohms	120W
Clipping Power at 0.1%THD 8 ohms	95W	150W
(1kHz)	4 ohms	150W
Rated THD (with 80kHz LPF)	0.03%	0.03%
20Hz/1kHz/20kHz at rated power		
Soft Clipping THD, 1kHz	10%	10%
Output Reduction	1dB	1dB
Signal/Noise Ratio, 1kHz ref. 1W	96.5dB	96.5dB
(A-weighted, 220 ohm load) ref. 8 ohms rated power	115.5dB	117.5dB
Frequency Response 20Hz	0~-0.3dB	0~-0.3dB
	20kHz	-0.2~-0.8dB
Input Sensitivity, 1kHz	895±30mV	1120±40mV
(Rated output into 8 ohms)		
Channel Separation 1kHz	75dB	75dB
	10kHz	58dB
Damping Factor	200	200
(at 50Hz/8 ohms)		
Dynamic Power 8 ohms	110W	170W
	4 ohms	180W
	2 ohms	250W
		400W

BRIDGE MODE

Continuous Power Output 8 ohms	240W	400W
(20Hz/1kHz/20kHz at rated THD with 80kHz LPF)		
Input Sensitivity	775±40mV	1000±50mV
(Rated output into 8 ohms)		

PHYSICAL

Dimensions (Width x Height x Depth)	435 x 128 x 370mm	435 x 146 x 370mm
Gross weight	12.5kg (27.5lbs)	15.5kg (34.1lbs)
Power consumption at 120, 220 or 240VAC, 50/60Hz	384VA	540VA

WARNING: TO PREVENT FIRE OR ELECTRIC SHOCK, DO NOT EXPOSE THIS APPLIANCE TO RAIN OR MOISTURE.

FRONT PANEL

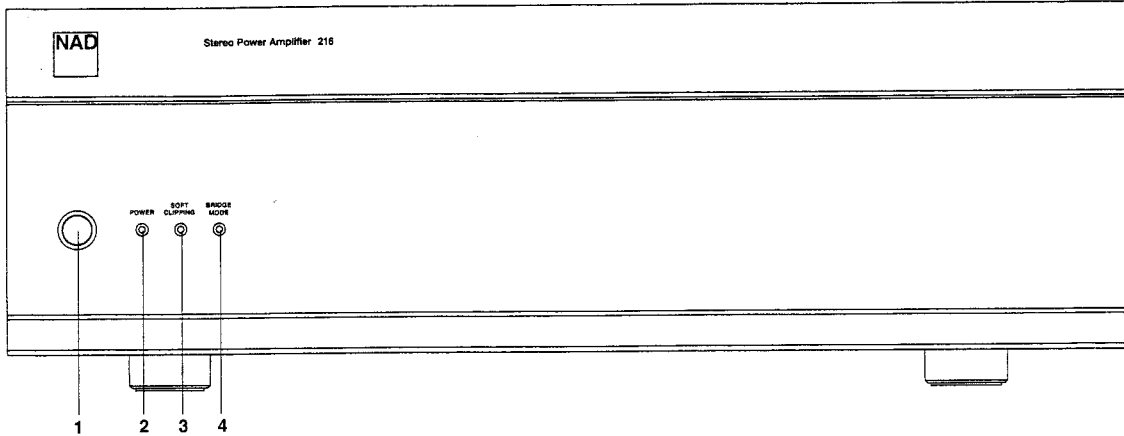

1. POWER Switch
2. POWER Indicator
3. SOFT CLIPPING Indicator
4. BRIDGE MODE Indicator



The lightning flash with arrowhead symbol, within an equilateral triangle, is intended to alert the user to the presence of uninsulated "dangerous voltage" within the product's enclosure, that may be of sufficient magnitude to constitute a risk of electric shock to persons.



The exclamation point within an equilateral triangle is intended to alert the user of the presence of important operating and maintenance (servicing) instructions in the literature accompanying the appliance.

REAR PANEL

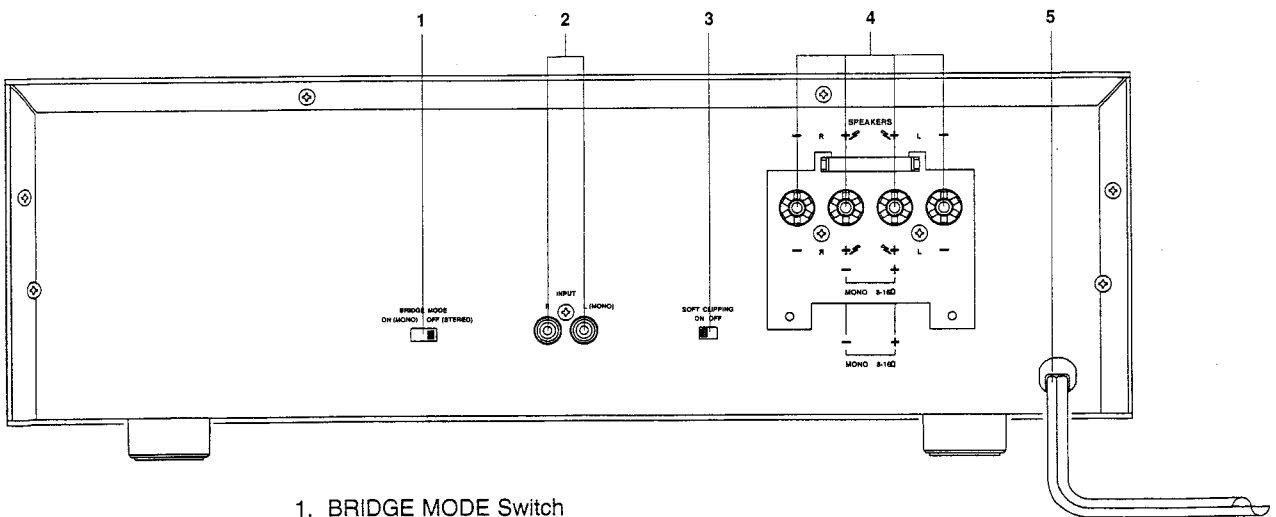

1. BRIDGE MODE Switch
2. INPUT Jacks
3. SOFT CLIPPING Switch
4. SPEAKER OUTPUT Terminals
5. AC POWER CORD

PCB LAYOUT

LEFT CHANNEL

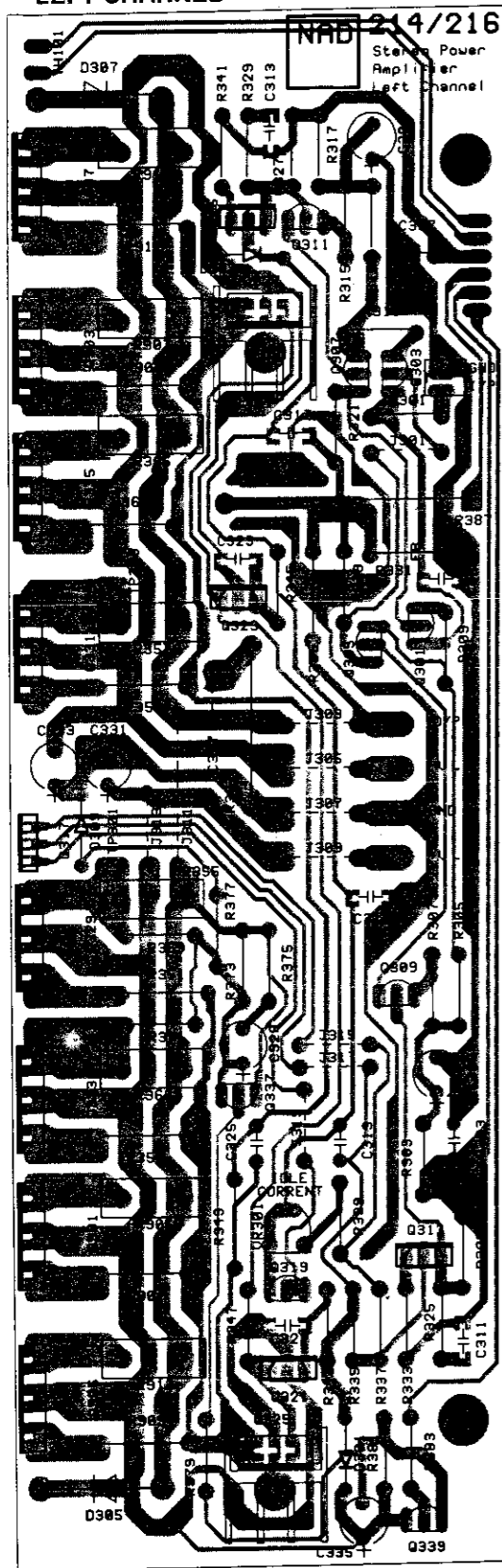

SPEAKER

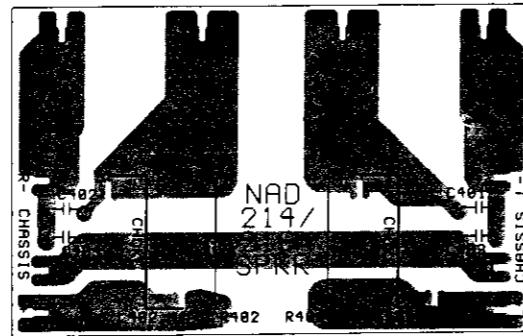

MAINS

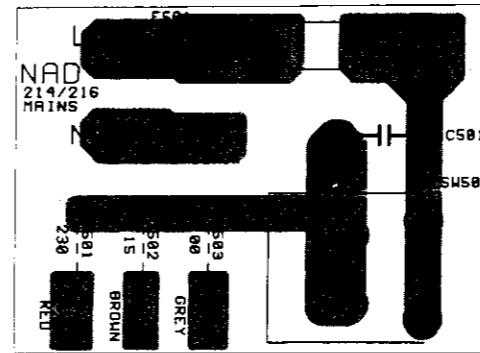

LED

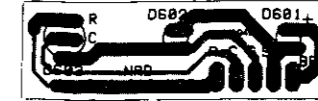

RIGHT CHANNEL

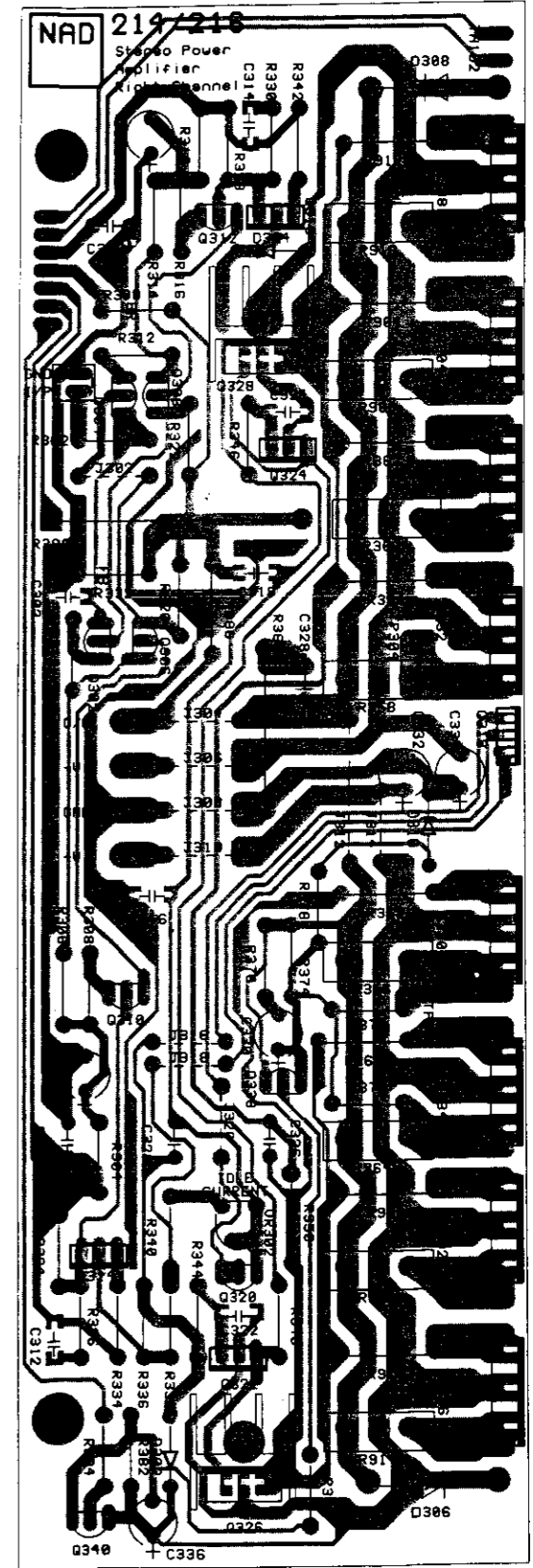

POWER SUPPLY

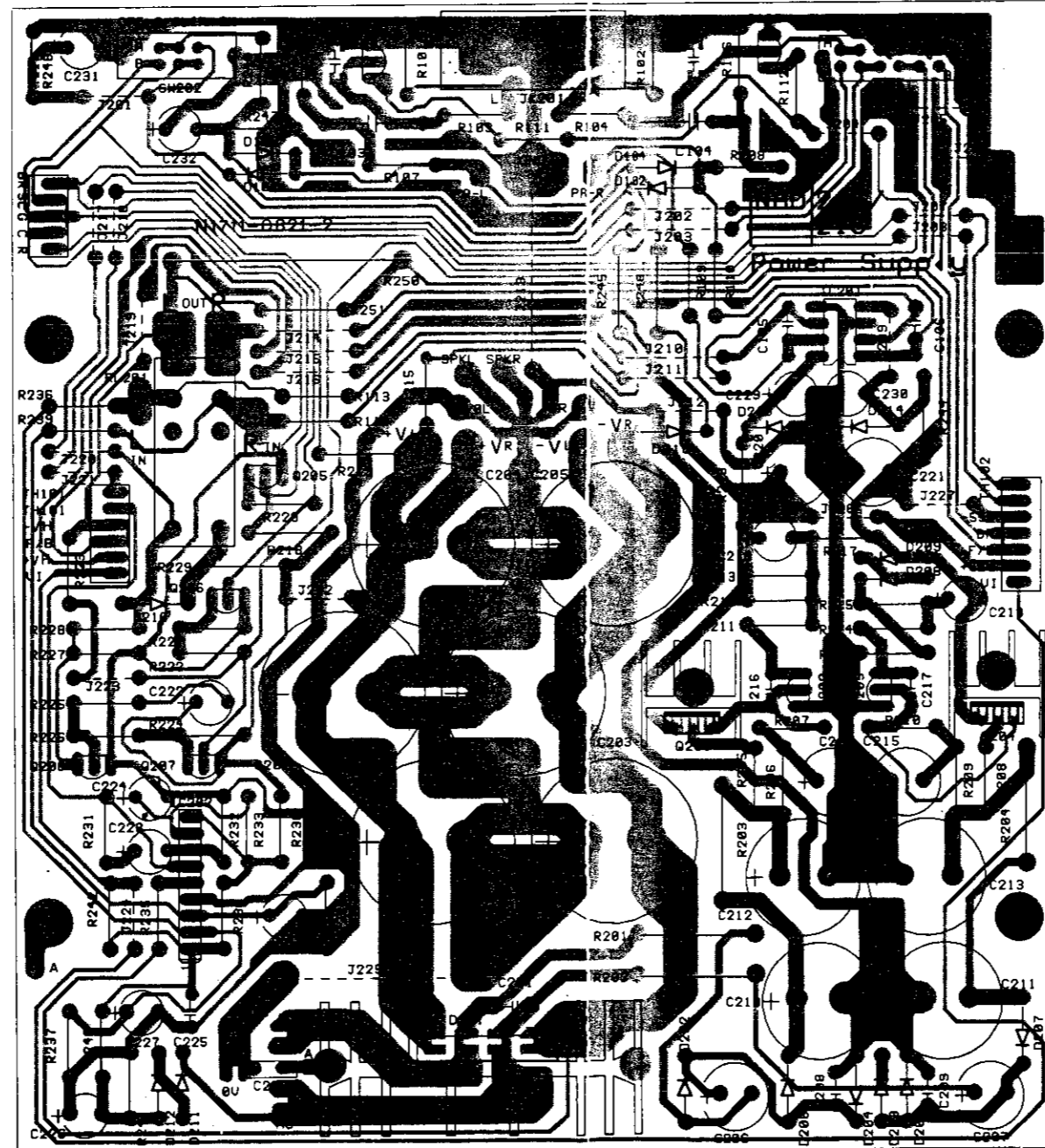

EXPLODED VIEW PARTS LIST

ITEM NO.	PART NUMBER	DESCRIPTION	QTY.
1	N14619601-1	Fascia 214	1
1 A	N14620601-1	Fascia 216	1
2	N14023250-1	Subfascia 214	1
2 A	N14023350-1	Subfascia 216	1
3	N14023270-1	Base Plate	1
4	N14023290-1	Subchassis	1
5	N14023300-0	Access Cover	2
6 *AH	N14023260-1	Rear Panel 214 AH	1
6 *C	N14023320-1	Rear Panel 214 C	1
6 A*AH	N14023360-0	Rear Panel 216 AH	1
6 A*C	N14023370-1	Rear Panel 216 C	1
7	N14023280-0	Top Cover 214	1
7 A	N14023380-0	Top Cover 216	1
8	N41519991-0	Bezel	1
9	N41520011-0	Clear LED Lens	3
10	N2437640B-0	Power Button	1
11	N16600600-0	Shrinkage Tube ID=38.1mm 0.07m	1
12	N16600710-0	Sleeve Tube ID=10mm 0.3m	1
13 *C	N21038004-0	Speaker Terminal with Plug C	1
13 *AH	N21038104-0	Speaker Terminal without Plug AH	1
14 A*AH	N41520022-0	UL Box Backplate Pantone 420 Grey AH	1
15 A*AH	N41520031-0	UL Box Saddle AH	1
16 A*AH	N41519981-0	UL Box Cover AH	1
17	N41519951-0	PCB Support (LCBS)	4
18	N17110821-2	214/216 Amp PCB without components	1
19	N31003191-0	Silicon Sheet	8
20	N41321671-0	Transistor Clamp	8
21	N41321661-0	Thermal Mounting Clip	2
22	N54000841-0	Main Heatsink 214	2
22 A	N54000871-0	Main Heatsink 216	2
23	N54000831-0	Heatsink Power Amplifier	4
24	N54000851-0	Heatsink Regulator	2
25	N54000821-1	Heatsink Power Supply 214	1
25 A	N54000901-0	Heatsink Power Supply 216	1
26 *AH	N70093100-1	AC Cord 18AWGx2 UL/CSA SPT-2 AH	1
26 *B	N70095100-0	AC Cord ASTA BS1363 with 5A Fuse B	1
26 *B1	N70091190-1	AC Cord SAA AS3112 B1	1
26 *C	N70093110-0	AC Cord SEMKO C	1
27	N41519461-0	Strain Relief Bushing	1
28	N89100055-0	Thermal Breaker UP 7290C	2
29	N18062102-0	Transformer TI-61233with Accessory 214	1
29 A	N18062105-0	Transformer TI-61242with Accessory 216	1
30	N41322151-0	Transformer Bracket	1
31	N41519411-0	Cushion 130x10x1.0mm	1
32	N41520331-0	Transformer Bushing	1
33	28368075-0	Nut M8x0.75mm 214	1
34	29078070-2000	Bolt Hexagon Head M8x0.75mm - 70mm 214	1
34 A	N41321891-0	Bolt + Nut Hexagon Head BSW 18TPI - 3.5" 216	1
35	28428015-0	Spring Washer M8	1

ITEM NO.	PART NUMBER	DESCRIPTION	QTY.
36	41321971-0	Flat Washer M8x22x1.5mm	1
37	28153042-0	Screw M3x4mm	2
38	29004006-3010	Screw M4x0.5x6mm with Flat Washer	6
39	29084012-3400	Screw Hexagon Socket Head 4x12mm Blk	8
40	29542606-0000	Screw BT 2.6x6mm	8
41	29543006-0000	Screw B-Tite 3x6mm Yel.Zn	17
42	29543006-3000	Screw B-Tite 3x6mm Blk.Zn	6
43	29443008-3000	Screw S-Tite 3x8mm Blk	2
44	29503008-3000	Screw Tapping 3x8mm	8
45	29543008-3000	Screw B-Tite 3x8mm Blk.Zn	11
46	29543010-3000	Screw B-Tite 3x10mm Blk.Zn	12
47	29543510-0000	Screw B-Tite 3.5x10mm Yel.Zn	1
48	29503516-3100	Screw B-Tite 3.5x16mm	22
49	28423367-0	Metal Washer ID=3.3mm OD=6.7mm	4
50 A	N18080110-0	Ferrite Core 33RH15.5x28.5x7.3 216	1
51	N41519371-1	Rubber Foot	4

EXPLODED VIEW

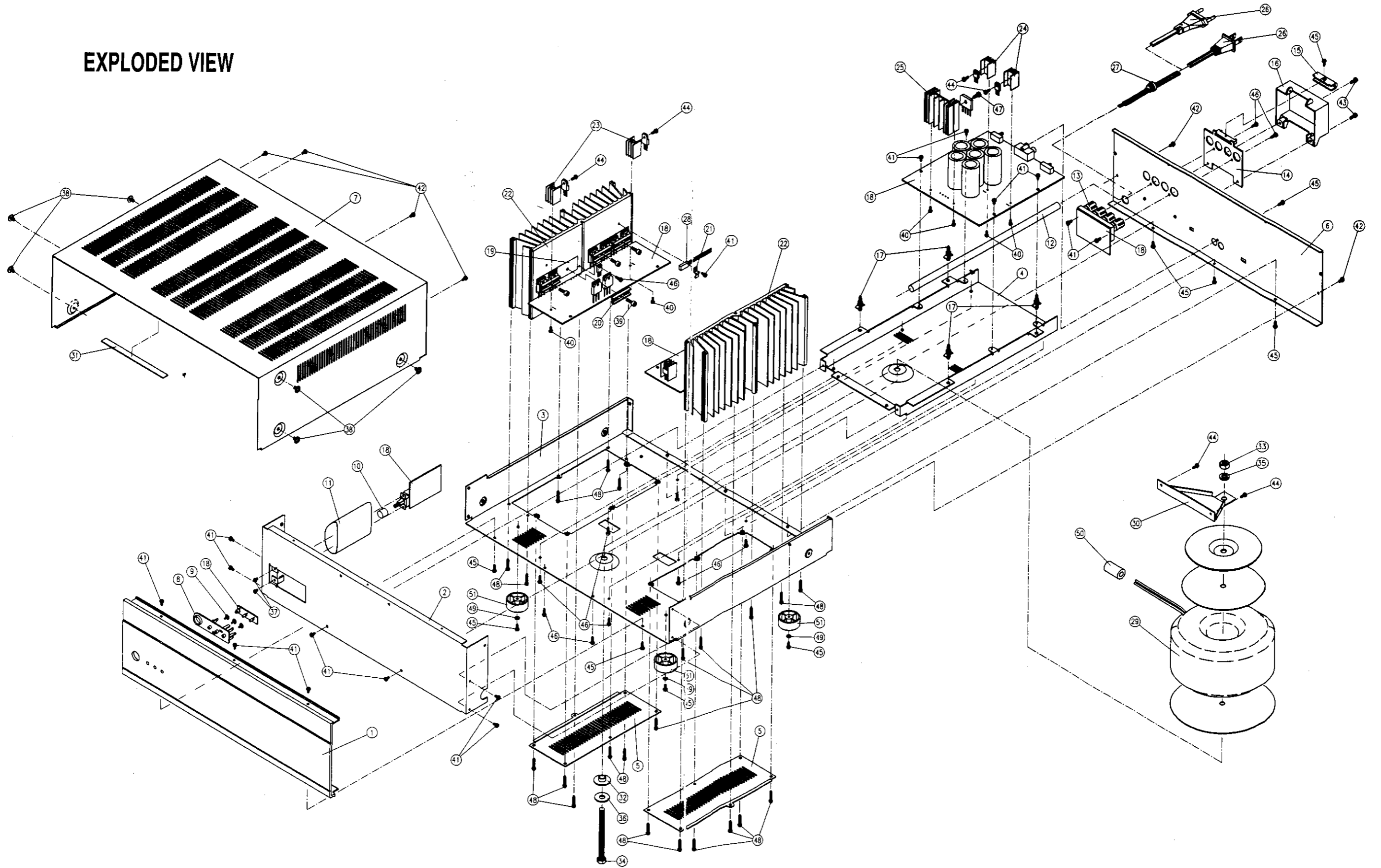

WIRING DIAGRAM

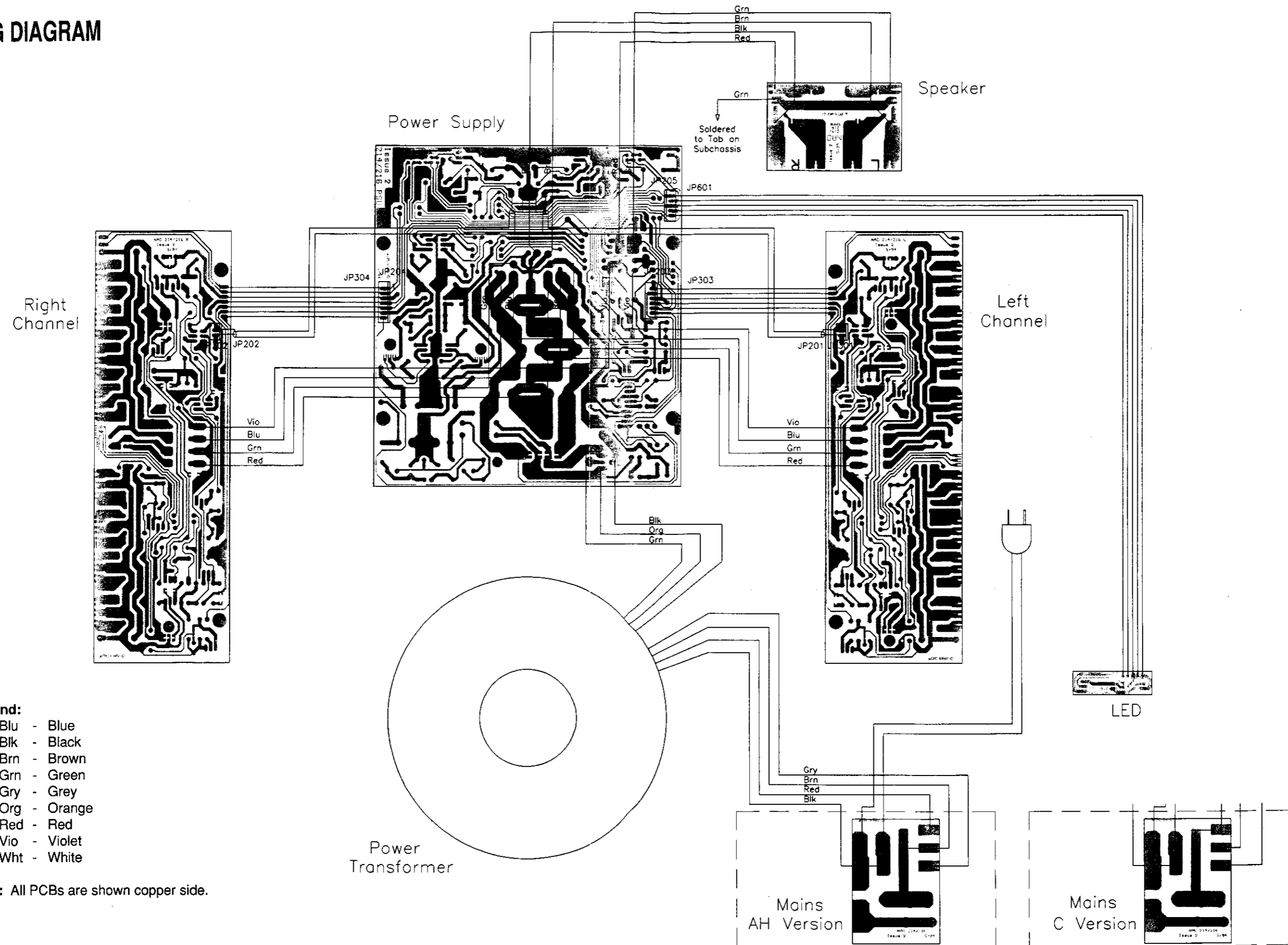

Legend:

- Blu - Blue
- Blk - Black
- Brn - Brown
- Grn - Green
- Gry - Grey
- Org - Orange
- Red - Red
- Vio - Violet
- Wht - White

Note: All PCBs are shown copper side.

SCHEMATIC DIAGRAM

214 POWER AMPLIFIER

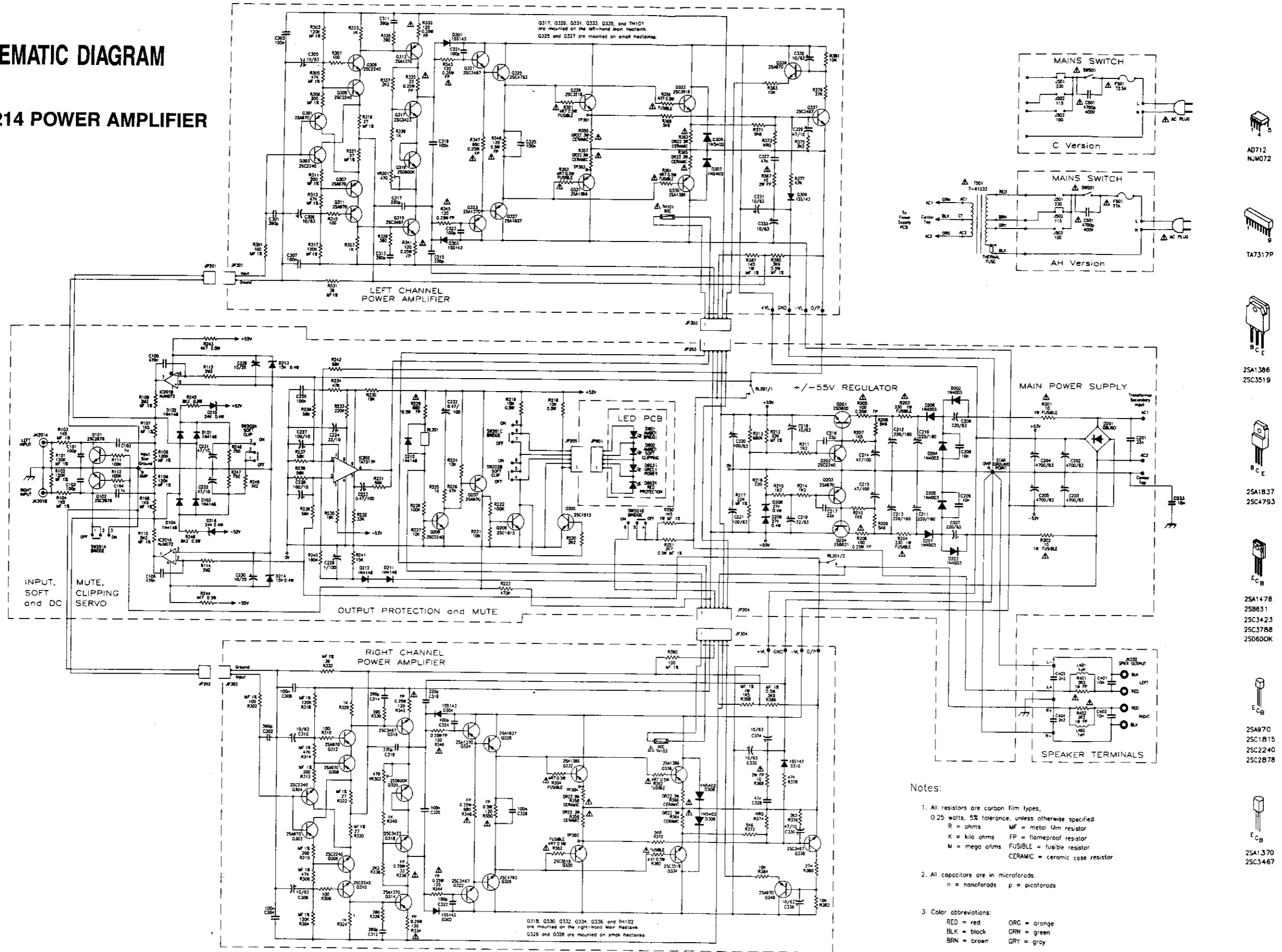

- AD712 N/W072
- TA7317P
- 25A1386 25C3519
- 25A1837 25C4793
- 25A1478 25B631 25C3423 25C3788 25D600K
- 25A970 25C1815 25C2240 25C2878
- 25A1370 25C3467

216 POWER AMPLIFIER

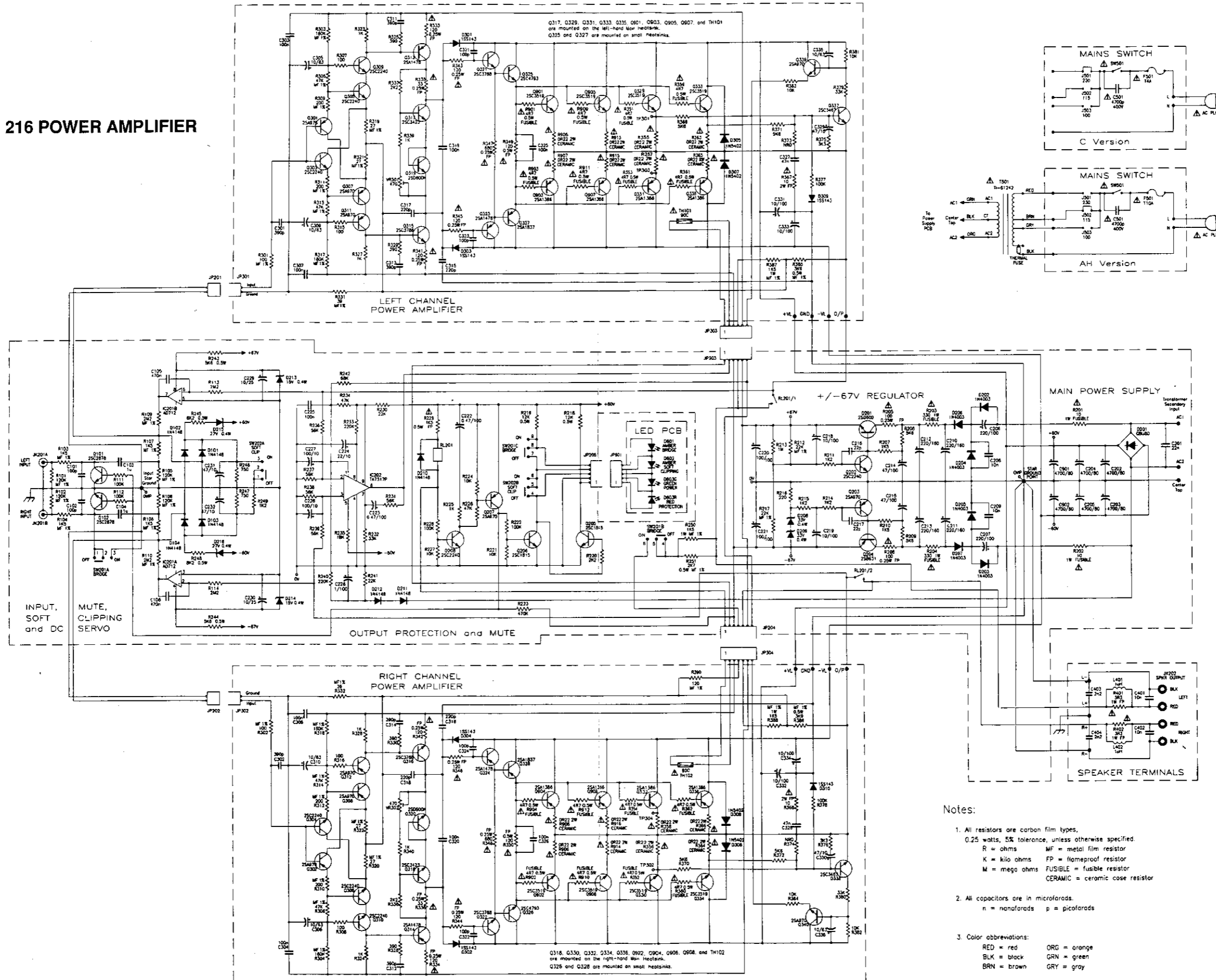

- Notes:
- All resistors are carbon film types, 0.25 watts, 5% tolerance, unless otherwise specified.
R = ohms MF = metal film resistor
K = kilo ohms FP = flameproof resistor
M = mega ohms FUSIBLE = fusible resistor
CERAMIC = ceramic case resistor
 - All capacitors are in microfarads.
n = nanofarads p = picofarads
 - Color abbreviations:
RED = red ORG = orange
BLK = black GRN = green
BRN = brown GRY = gray

ELECTRICAL PARTS LIST

SYMBOL NO.	PART NUMBER	DESCRIPTION	REMARKS
C101, C102	N158R101J-5-IQ	Capacitor, Polystyrene 250V 100pF ±5%	
C103, C104	153I105K-9-NL	Capacitor, Mylar 63V 1uF ±10%	
C105, C106	153I474K-9-NL	Capacitor, Mylar 63V 0.47uF ±10%	
C201	153R223M-9-NL	Capacitor, Mylar 250V 0.022uF ±20%	
C202, C203	N89100057-0	Capacitor, Electrolytic 63V 4700uF ±20%	214
C202, C203 A	89100062-0	Capacitor, Electrolytic 80V 4700uF ±20%	216
C204, C205	N89100057-0	Capacitor, Electrolytic 63V 4700uF ±20%	214
C204, C205 A	89100062-0	Capacitor, Electrolytic 80V 4700uF ±20%	216
C206, C207 A	157H227M-5-5&	Capacitor, Electrolytic 100V 220uF ±20%	216
C206, C207	N157I227M-5-S9	Capacitor, Electrolytic 63V 220uF ±20%	214
C208, C209	153R103M-9-NL	Capacitor, Mylar 250V 0.01uF ±20%	
C210, C211	N89100056-0	Capacitor, Electrolytic 160V 220uF ±20%	
C212, C213	N89100056-0	Capacitor, Electrolytic 160V 220uF ±20%	
C214, C215	157H476M-5-S5	Capacitor, Electrolytic 100V 47uF ±20%	
C216, C217	15CG220J-7-IJ	CTC 0/30 22pF ±5%	
C218, C219 A	157H106M-5-LU	Capacitor, Electrolytic 100V 10uF ±20%	216
C218	N157I106M-5-IU	Capacitor, Electrolytic 63V 10uF ±20%	214
C219	N157I226M-5-IU	Capacitor, Electrolytic 63V 22uF ±20%	214
C220, C221 A	157H107M-5-X9	Capacitor, Electrolytic 100V 100uF ±20%	216
C220, C221	N157I107M-5-SX	Capacitor, Electrolytic 63V 100uF ±20%	214
C222, C223	N157H474M-5-IU	Capacitor, Electrolytic 100V 0.47uF ±20%	
C224	157C226M-5-IU	Capacitor, Electrolytic 10V 22uF ±20%	
C225	153H104M-9-NL	Capacitor, Mylar 100V 0.1uF ±20%	
C226	N157H105M-5-IU	Capacitor, Electrolytic 100V 1uF ±20%	
C227, C228	157C107M-5-IU	Capacitor, Electrolytic 10V 100uF ±20%	
C229, C230	157E106M-5-IU	Capacitor, Electrolytic 25V 10uF ±20%	
C231, C232	157C476M-5-IU	Capacitor, Electrolytic 10V 47uF ±20%	
C233	N150F103K-5-UU	Capacitor, Ceramic 50V 0.01uF ±10%	214
C301, C302	N158F391J-5-IQ	Capacitor, Polystyrene 50V 390pF ±5%	
C303, C304	153H104M-9-NL	Capacitor, Mylar 100V 0.1uF ±20%	
C305, C306	157I106M-5-IU	Capacitor, Electrolytic 63V 10uF ±20%	
C307, C308	153H104M-9-NL	Capacitor, Mylar 100V 0.1uF ±20%	
C309, C310	157I106M-5-IU	Capacitor, Electrolytic 63V 10uF ±20%	
C311, C312	N158F391J-5-IQ	Capacitor, Polystyrene 50V 390pF ±5%	
C313, C314	N158F391J-5-IQ	Capacitor, Polystyrene 50V 390pF ±5%	
C315, C316	N158K221J-5-IQ	Capacitor, Polystyrene 150V 220pF ±5%	
C317, C318	N158K221J-5-IQ	Capacitor, Polystyrene 150V 220pF ±5%	
C319, C320	153H104M-9-NL	Capacitor, Mylar 100V 0.1uF ±20%	
C321, C322	N158R101J-5-IQ	Capacitor, Polystyrene 250V 100pF ±5%	
C323, C324	N158R101J-5-IQ	Capacitor, Polystyrene 250V 100pF ±5%	
C325, C326	153H104M-9-NL	Capacitor, Mylar 100V 0.1uF ±20%	
C327, C328	153H473K-9-SW	Capacitor, Mylar 100V 0.047uF ±10%	
C329, C330	157C476M-5-IU	Capacitor, Electrolytic 10V 47uF ±20%	
C331, C332 A	157H106M-5-LU	Capacitor, Electrolytic 100V 10uF ±20%	216
C331, C332	N157I106M-5-IU	Capacitor, Electrolytic 63V 10uF ±20%	214
C333, C334 A	157H106M-5-LU	Capacitor, Electrolytic 100V 10uF ±20%	216
C333, C334	N157I106M-5-IU	Capacitor, Electrolytic 63V 10uF ±20%	214
C335, C336	157I106M-5-IU	Capacitor, Electrolytic 63V 10uF ±20%	
C401, C402	153R103M-9-NL	Capacitor, Mylar 250V 0.01uF ±20%	
C403, C404	15CG222J-7-IJ	CTC 0/30 2200pF ±5%	
C501	N89100049-0	CAP 400V 4700pF DE7150F472MVA1KC	⚠
C901, C902 A	89100062-0	Capacitor, Electrolytic 80V 4700uF ±20%	216

SYMBOL NO.	PARTNUMBER	DESCRIPTION	REMARKS
D101, D102	48041480-2	Diode 1N4148	
D103, D104	48041480-2	Diode 1N4148	
D201	N48400610-0	Diode, Bridge GBU8D	
D202, D203	N48040030-2	Diode 1N4003	
D204, D205	N48040030-2	Diode 1N4003	
D206, D207	N48040030-2	Diode 1N4003	
D208, D209	N483727V0-2	Diode, Zener 0.5W 27V	214
D208, D209 A	483733V0-2	Diode, Zener 0.5W 33V	216
D210, D211	48041480-2	Diode 1N4148	
D212	48041480-2	Diode 1N4148	
D213, D214	48400510-0	Diode, Zener 0.5W 15V	
D215, D216	N48400620-0	Diode, Zener 0.5W 24V	214
D215, D216 A	483727V0-2	Diode, Zener 0.5W 27V	216
D301, D302	48400590-0	Diode 1SS143	
D303, D304	48400590-0	Diode 1SS143	
D305, D306	N48054020-L	Diode 1N5402	
D307, D308	N48054020-L	Diode 1N5402	
D309, D310	48400590-0	Diode 1SS143	
D601, D602	N37003513-Y	LED Yellow (L-424YDT) 3mm	
D603	N37003517-RG	LED Red/Green (L-469HGW)	
F501 A*AH	N51001030-3A	Fuse T10A 125V/250V (UL/CSA)	△ 216AH
F501 *C	N51002530-1B	Fuse T2.5A 250V IEC (SEMKO/VDE)	△ 214C
F501 *AH	N51007030-1A	Fuse T7A 125V (UL/CSA)	△ 214AH
F501 A*C	51200017-0	Fuse T4A 250V SEMKO/VDE	△ 216C
IC201	N31303560-0	IC NJM072 (D)	214
IC201 A	N31303830-0	IC AD712 (JN) Analog Devices	216
IC202	N31303530-0	IC TA7317P	
JK201	N21037902-0	Twin RCA Jack YKC21-3539	
L401, L402	N18040490-0	Spring Coil 1uH 1/9/16.5	
Q101, Q102	N48600070-5	Transistor 2SC2878 (A, B)	
Q201	N48600740-5	Transistor 2SD600K (E, F)	
Q202	N485240GR-5	Transistor 2SC2240 (G, R)	
Q203	N48600650-5	Transistor 2SA970 (G, R)	
Q204	N48600870-5	Transistor 2SB631K (E, F)	
Q205, Q206	N4851815Y-5	Transistor 2SC1815-Y	
Q207	N48600650-5	Transistor 2SA970 (G, R)	
Q208	N485240GR-5	Transistor 2SC2240 (G, R)	
Q301, Q302	N48600650-5	Transistor 2SA970 (G, R)	
Q303, Q304	N485240GR-5	Transistor 2SC2240 (G, R)	
Q305, Q306	N485240GR-5	Transistor 2SC2240 (G, R)	
Q307, Q308	N48600650-5	Transistor 2SA970 (G, R)	
Q309, Q310	N485240GR-5	Transistor 2SC2240 (G, R)	
Q311, Q312	N48600650-5	Transistor 2SA970 (G, R)	
Q313, Q314	N48600680-5	Transistor 2SA1370 (E)	214
Q313, Q314 A	N48600810-5	Transistor 2SA1478 (E)	216
Q315, Q316	N48600720-5	Transistor 2SC3467 (E)	214
Q315, Q316 A	N48600820-5	Transistor 2SC3788 (E)	216
Q317, Q318	N48600790-5	Transistor 2SC3423 (Y)	
Q319, Q320	N48600740-5	Transistor 2SD600K (E, F)	
Q321, Q322	N48600720-5	Transistor 2SC3467 (E)	214
Q321, Q322 A	N48600820-5	Transistor 2SC3788 (E)	216
Q323, Q324	N48600680-5	Transistor 2SA1370 (E)	214

SYMBOL NO.	PART NUMBER	DESCRIPTION	REMARKS
Q323, Q324 A	N48600810-5	Transistor 2SA1478 (E)	216
Q325, Q326	48601060-5	Transistor 2SC4793	
Q327, Q328	48601050-5	Transistor 2SA1837	
Q329, Q330	N48600730-5	Transistor 2SC3519 (O, P, Y)	
Q331, Q332	N48600690-5	Transistor 2SA1386 (O, P, Y)	
Q333, Q334	N48600730-5	Transistor 2SC3519 (O, P, Y)	
Q335, Q336	N48600690-5	Transistor 2SA1386 (O, P, Y)	
Q337, Q338	N48600720-5	Transistor 2SC3467 (E)	
Q339, Q340	N48600650-5	Transistor 2SA970 (G, R)	
Q901, Q902 A	N48600730-5	Transistor 2SC3519 (O, P, Y)	216
Q903, Q904 A	N48600690-5	Transistor 2SA1386 (O, P, Y)	216
Q905, Q906 A	N48600730-5	Transistor 2SC3519 (O, P, Y)	216
Q907, Q908 A	N48600690-5	Transistor 2SA1386 (O, P, Y)	216
R201, R202	N4718100J-2-F	Resistor Fusible 10 1W 5%	⚠
R203, R204	N4718331J-2-F	Resistor Fusible 330 1W 5%	⚠
R205, R208	N4715101J-2-P	Resistor Flame Proof 100 0.25W 5%	⚠
R229	N4717681J-2-P	Resistor Flame Proof 680 0.5W 5%	⚠ 214
R229 A	N4717152J-2-P	Resistor Flame Proof 1K5 0.5W 5%	⚠ 216
R333, R334	4715121J-2-P	Resistor Flame Proof 120 0.25W 5%	⚠
R335, R336	N4715330J-2-P	Resistor Flame Proof 33 0.25W 5%	⚠
R341, R342	4715121J-2-P	Resistor Flame Proof 120 0.25W 5%	⚠
R343, R344	4715121J-2-P	Resistor Flame Proof 120 0.25W 5%	⚠
R345, R346	4715121J-2-P	Resistor Flame Proof 120 0.25W 5%	⚠
R347, R348	N4715681J-2-P	Resistor Flame Proof 680 0.25W 5%	⚠
R349, R350	4717121J-2-P	Resistor Flame Proof 120 0.5W 5%	⚠
R351, R352	47174R7J-2-F	Resistor Fusible 4R7 0.5W 5%	⚠
R353, R354	47174R7J-2-F	Resistor Fusible 4R7 0.5W 5%	⚠
R355, R356	471A022K-5-N	Resistor Ceramic Case 0R22 3W 10%	⚠ 214
R355, R356 A	4719022K-5-N	Resistor Ceramic Case 0R22 2W 10%	⚠ 216
R357, R358	471A022K-5-N	Resistor Ceramic Case 0R22 3W 10%	⚠ 214
R357, R358 A	4719022K-5-N	Resistor Ceramic Case 0R22 2W 10%	⚠ 216
R359, R360	47174R7J-2-F	Resistor Fusible 4R7 0.5W 5%	⚠
R361, R362	47174R7J-2-F	Resistor Fusible 4R7 0.5W 5%	⚠
R363, R364	471A022K-5-N	Resistor Ceramic Case 0R22 3W 10%	⚠ 214
R363, R364 A	4719022K-5-N	Resistor Ceramic Case 0R22 2W 10%	⚠ 216
R365, R366	471A022K-5-N	Resistor Ceramic Case 0R22 3W 10%	⚠ 214
R365, R366 A	4719022K-5-N	Resistor Ceramic Case 0R22 2W 10%	⚠ 216
R367, R368	4719100J-1-P	Resistor Flame Proof 10 2W 5%	⚠
R401, R402	N47183R3J-2-P	Resistor Flame Proof 3R3 1W 5%	⚠
R901, R902 A	47174R7J-2-F	Resistor Fusible 4R7 0.5W 5%	⚠ 216
R903, R904 A	47174R7J-2-F	Resistor Fusible 4R7 0.5W 5%	⚠ 216
R905, R906 A	4719022K-5-N	Resistor Ceramic Case 0R22 2W 10%	⚠ 216
R907, R908 A	4719022K-5-N	Resistor Ceramic Case 0R22 2W 10%	⚠ 216
R909, R910 A	47174R7J-2-F	Resistor Fusible 4R7 0.5W 5%	⚠ 216
R911, R912 A	47174R7J-2-F	Resistor Fusible 4R7 0.5W 5%	⚠ 216
R913, R914 A	4719022K-5-N	Resistor Ceramic Case 0R22 2W 10%	⚠ 216
R915, R916 A	4719022K-5-N	Resistor Ceramic Case 0R22 2W 10%	⚠ 216
RL201	N45000130-0	Relay DEC DH48D2-0 (M) DH 2U	
SW201	N52003161-0-01	4PDT Slide Switch SK-42F28-G6TS	
SW202	N52003171-0-01	DPDT Slide Switch SK-22F28-G9TS	
SW501	N52003181-0-01	DPST Push Switch SDDFA3066A	⚠
TH101, TH102	N89100055-0	Thermal Breaker UP 72 90C	⚠
VR301, VR302	N47564716-3-06	Resistor, Semi-fixed 470 H3 7X7.6 RH0615C	

ALIGNMENT PROCEDURE

EQUIPMENT

Digital voltmeter (DVM) switched to 200mV DC range.

TEST CONDITIONS

Ensure VR301 and VR302 are set to minimum (fully counterclockwise) before first switching on.

Preheat	Minimum five (5) minutes
Load	No load
Input	No signal

ALIGNMENT

1. Connect DVM across TP301 and TP303, Left Channel.
2. Adjust VR301, Left channel, for a reading of:
 214 20mV \pm 1.5mV.
 216 18mV \pm 1.5mV.
3. Connect DVM across TP302 and TP304, Right channel.
4. Adjust VR302, Right channel, for a reading of:
 214 20 mV \pm 1.5mV.
 216 18mV \pm 1.5mV.
5. Leave power on for a further five (5) minutes (minimum).
6. Repeat steps 1 to 4.

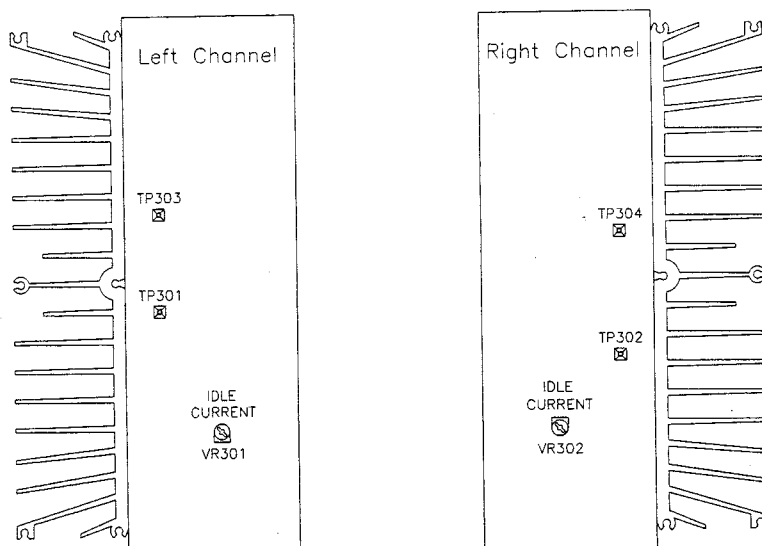

AMPLIFIER ADJUSTMENT POINTS

PACKING DIAGRAM

ITEM	PART NUMBER	NAME	QTY
52		Unit	1
53	N14971252-0	EPE Bag (214)	1
53 A	N14971162-0	EPE Bag (216)	1
54	N14971072-3	Polybag Unit	1
55	N4901583-0	Polyfoam (214)	2
55 A	N4901643-0	Polyfoam (216)	2
56	N43013535-0	Instruction Manual	1
57 *AH	N30301057-2	Safety Instruction Sheet (AH)	1
58 *AH	N30301056-0	Warranty Card (AH)	1
59	N14971062-0	Polybag Manual	1
60	N14761401-0	Gift Box (214)	1
60 A	N14761600-0	Gift Box (216)	1

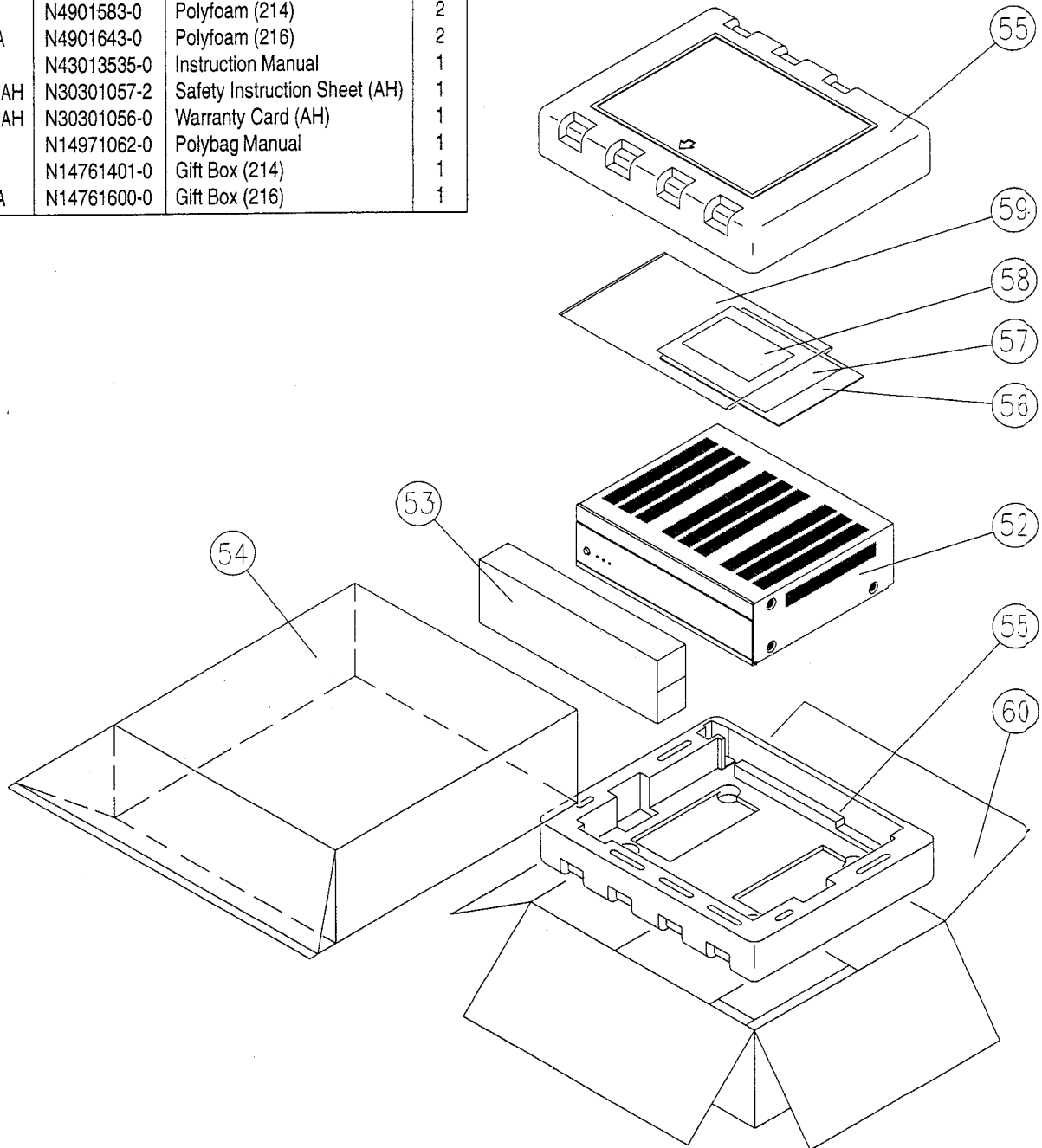

Proprietary information for servicing purposes only. The information herein may not be used commercially without the prior written agreement of NAD Electronics Ltd., London, England.