

AKAI

SEMI AUTOMATIC TURNTABLE
AP-A101/C

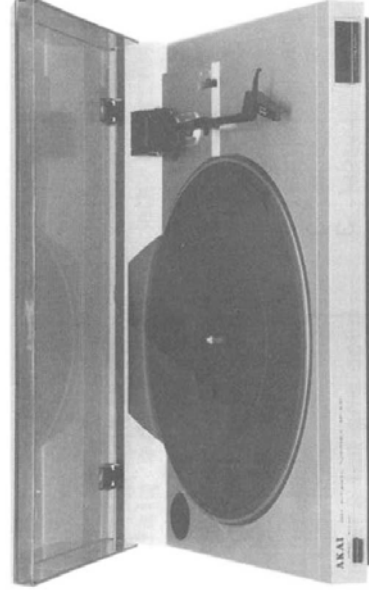

Operator's Manual **E**

- * This operator's manual applies equally to models AP-A101 and AP-A101C, except where otherwise noted.
- * Cartridge illustrated in the photo is standard on model AP-A101C only.



This is the Akai Semi Automatic Turntable

This Akai semi automatic turntable will provide excellent sound reproduction and years of reliable operation. Use it in combination with other components of the Pro Series, and you will have an excellent Hi-Fi system.

Features

- DC servo motor for stable record playback.
- Arm lifter damper eliminates the possibility of accidental scratches to your records.
- The **VM** moving magnet **TP** type plug-in cartridge is easy to change.
- * The **TP** cartridge is standard on model AP-A101C only.
- Highly sensitive low-mass straight tone arm.

Table of Contents

Warning	1
What you should know to protect yourself	2
Turntable set-up	3
Making the right connections	3
Controls	4
Let's enjoy music	5
Useful facts about your turntable	6
To change the stylus	6
To change or install the cartridge	6
Problem? Let's check	7
Specifications	7

WARNING

To Prevent fire or shock hazard, do not expose this appliance to rain or moisture.

Power requirements

Power requirements for electrical equipment differ from area to area. Please ensure that your machine meets the power requirements in your area.

If in doubt, consult a qualified electrician.

120 V, 60 Hz for USA and Canada

220 V, 50 Hz for Europe except UK

240 V, 50 Hz for UK and Australia

110 V—120 V/220 V—240 V, 50 Hz/60 Hz convertible for other countries.

Before Assembling the Platter! Voltage conversion.

Each machine is preset at the factory according to its destination, but some machines can be set to 110 V—120 V or 220 V—240 V as required.

If your machine's voltage can be converted:

Before connecting the power cord or assembling the platter, move the VOLTAGE SELECTOR located on the top of the cabinet with a screwdriver until the correct voltage is indicated. Models for USA, Canada, Europe, UK and Australia are not equipped with this facility.

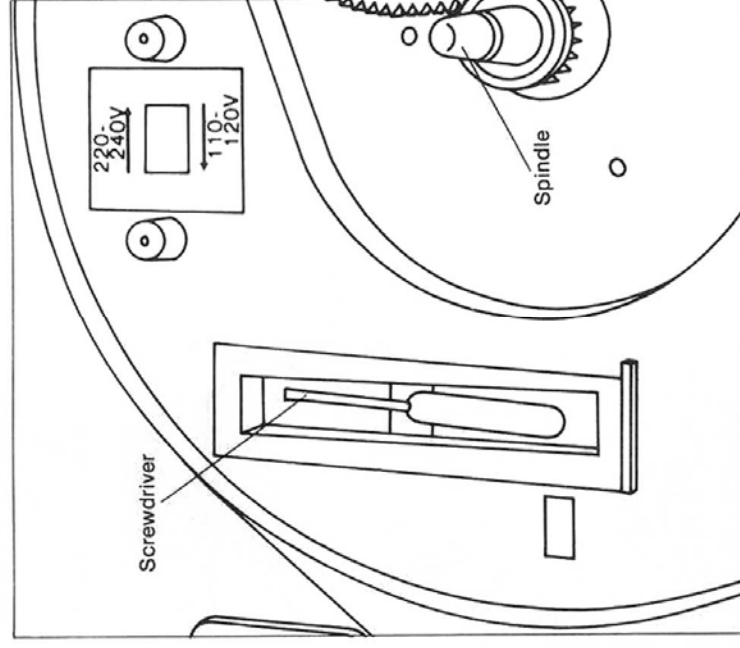

This equipment conforms to No. 82/499 EEC standards.

What you should know to protect yourself

FOR CUSTOMERS IN THE UK

Watch out! You might get an electric shock.

- Never touch the plug with wet hands.
- Always pull out by the plug and never the cord.
- Only let a qualified professional repair or disassemble the Akai turntable. An unauthorized person might touch the internal parts and receive a serious electric shock.
- Never allow a child to put anything, especially metal, into the Akai turntable.

Let's protect the Akai Turntable too.

- Use only a household AC power source. Never use a DC power source.
- If water is spilled on the Akai turntable, disconnect it and call your dealer.
- Make sure that the Akai turntable is well ventilated and away from direct sunlight.
- To avoid damage to the internal circuits and the external surface, keep away from heat (stoves, etc.).
- Avoid using spray type insecticide near the Akai turntable. It can damage the finish and might ignite suddenly.
- To avoid damaging the finish, never use denatured alcohol, paint thinner or other similar chemicals to clean the Akai turntable.
- Place the Akai turntable on a flat and solid surface.
- To protect the insulators, always lift the Akai turntable when you move it.
- When transporting the Akai turntable over a long distance, place it in its original box wrapped in its protective wrappers.

To enjoy the Akai turntable for a long time, please read this operator's manual thoroughly.

Note: The Akai turntable is not equipped with a power switch. To turn off the Akai turntable completely, disconnect the power plug from its power supply.

IMPORTANT FOR YOUR SAFETY

The flex supplied with your machine will have either two wires or three as shown in the illustrations.

TWO CORE FLEX IMPORTANT

The wires in this mains lead are coloured in accordance with the following code:

Blue: Neutral
Brown: Live

As the colours of the wires in the mains lead of this apparatus may not correspond with the coloured markings identifying the terminals in your plug, proceed as follows: The wire which is coloured blue must be connected to the terminal which is marked with the letter N or coloured black.

The wire which is coloured brown must be connected to the terminal which is marked with the letter L or coloured red.

- Do not connect any wire to the larger pin marked E or  when wiring a plug. Ensure that all terminals are securely tightened and that no loose strands of wire exist.

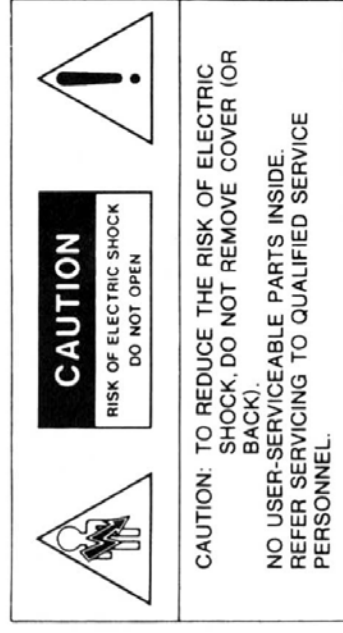
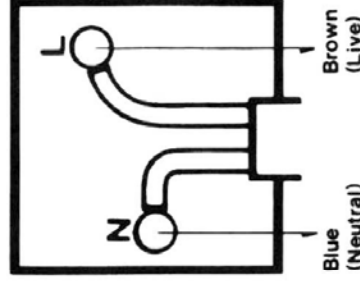

The lightning flash with the arrowhead symbol superimposed across a graphical representation of a person, within an equilateral triangle, is intended to alert the user to the presence of uninsulated "dangerous voltage" within the product's enclosure; that may be of sufficient magnitude to constitute a risk of electric shock.



The exclamation point within an equilateral triangle is intended to alert the user to the presence of important operating and maintenance (servicing) instructions in the literature accompanying the appliance.



Turntable set-up

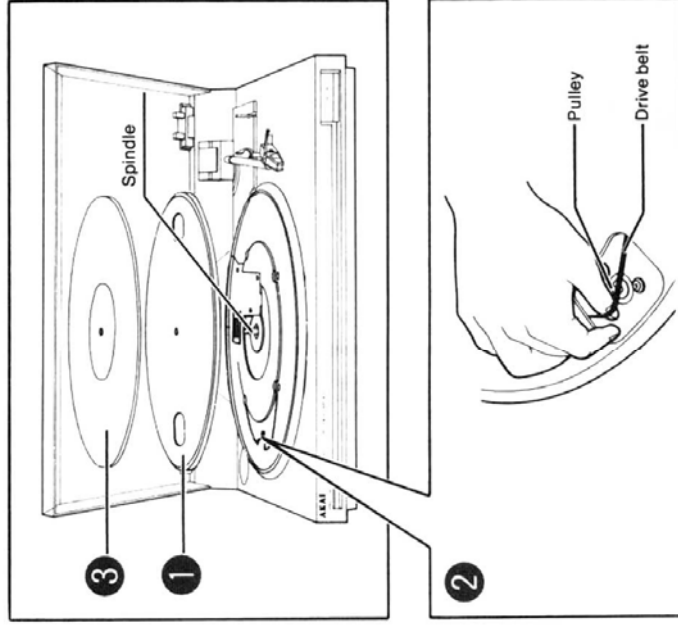

Before beginning

Remove the parts from the carton. Take off the protective packing.

- 1 Holding the metal platter by its center holes, place it over the turntable so that the small center spindle hole drops over the spindle. Rotate the platter until one of the platter's outer openings is over the pulley. (As illustrated.)
- 2 Gently stretch the drive belt which is wrapped around the platter and extend it around the pulley.
- 3 Place the rubber mat on the platter, shiny side down.

Note: Keep the plastic 45 rpm adaptor in the adaptor holder for use when you want to listen to your favorite hit singles.

Making the right connections

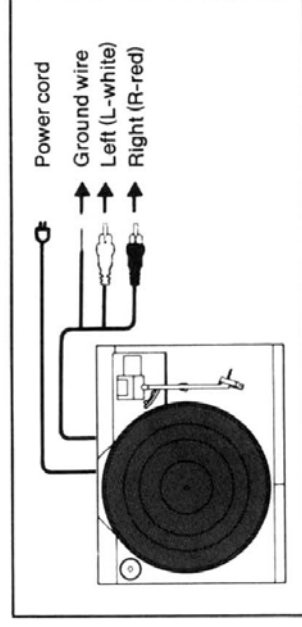

Before connection

- Turn off all the components before connection.
- Connect the power cord last.
- Make sure that you connect the white PIN-plug to the left (L-white) jack and the red PIN-plug to the right (R-red) jack.
- Connect everything securely. Loose connections can lead to distortion.

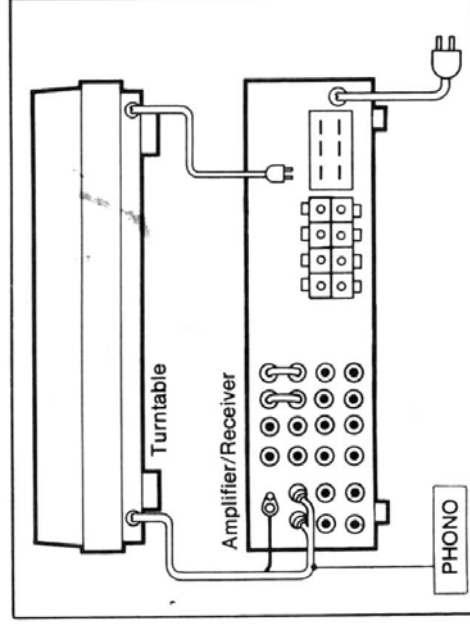

- 1 Connect the Akai turntable's output plug to the amplifier's **PHONO** jacks. (left and right)
- 2 Connect the Akai turntable's ground wire to the amplifier's ground (⚡) terminal.
- 3 **After you have connected everything;** Connect the power cord to an amplifier, timer, or household **AC** outlet.



Controls

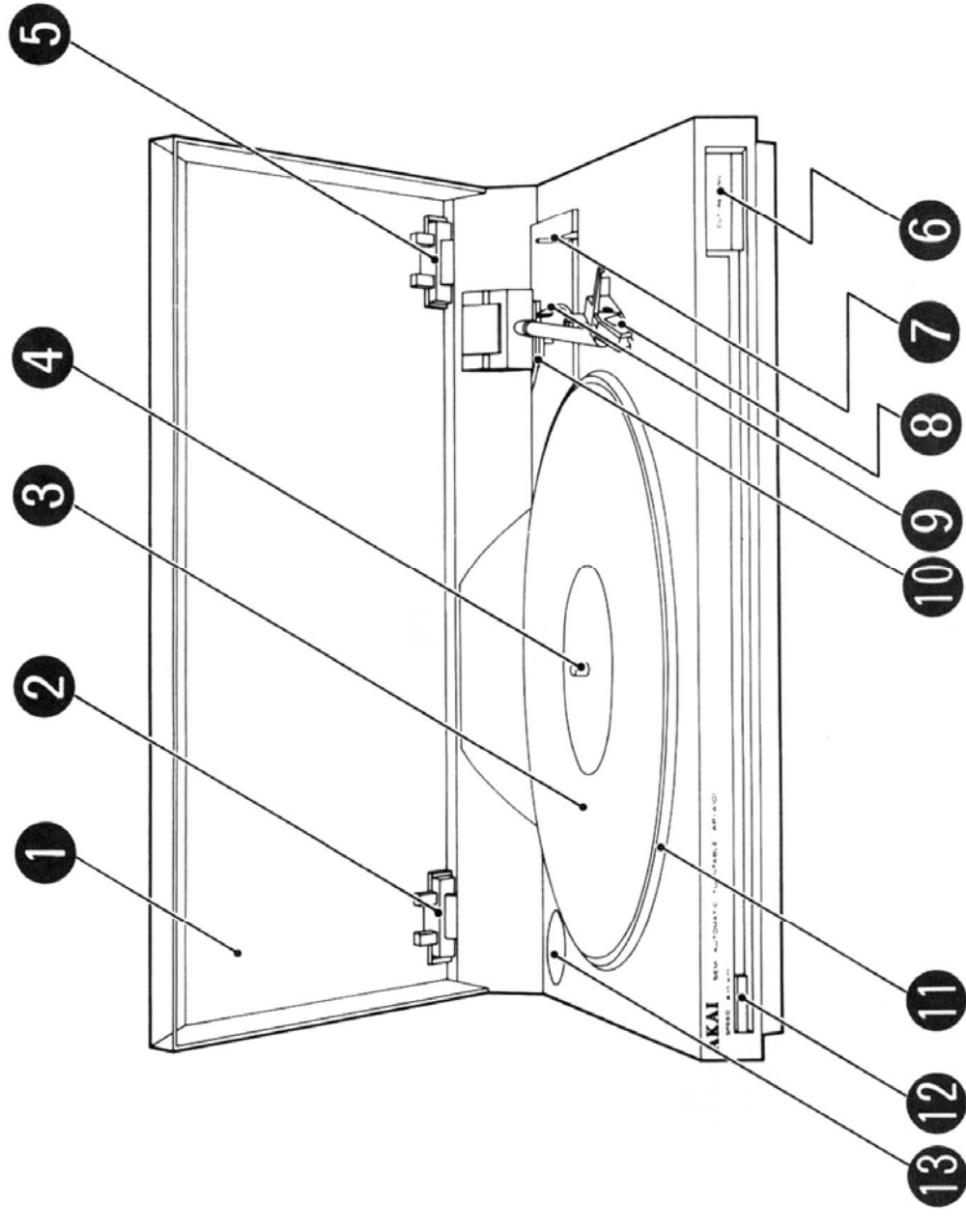

1 Dust Cover
(Not on some models.)

2 Hinge
(Not on some models.)

3 Rubber mat
Preserves your records.

4 Spindle

5 Hinge
(Not on some models.)

6 CUT/RETURN button
Use to stop playback and to move the tone arm backward.

7 ARM LIFTER control
To raise or lower the tone arm during playback.

8 Tone arm and **TAP* Cartridge**
Highly responsive for excellent sound reproduction.

9 Tone Arm rest

10 Arm Lifter

11 Turntable platter

12 SPEED (33  /45 ) selector
Use to select the record speed.

13 45 rpm adaptor holder

Note: The Akai turntable is not equipped with a power switch. To turn off the Akai turntable completely, disconnect the power cord from its supply.



Let's play back a record

Before operation

- Make certain all the components are properly connected and the Akai amplifier is turned ON.
- Set the amplifier's input selector to PHONO.
- Remove the stylus guard.

- Use the standard accessory 45 rpm adaptor when playing back 17 cm records. (Provided the center hole is a large type.)
- Gently free the tone arm from the tone arm clamp.

1 Place a record on the platter.

2 Set the record speed with the **SPEED** (33 / 45) selector.

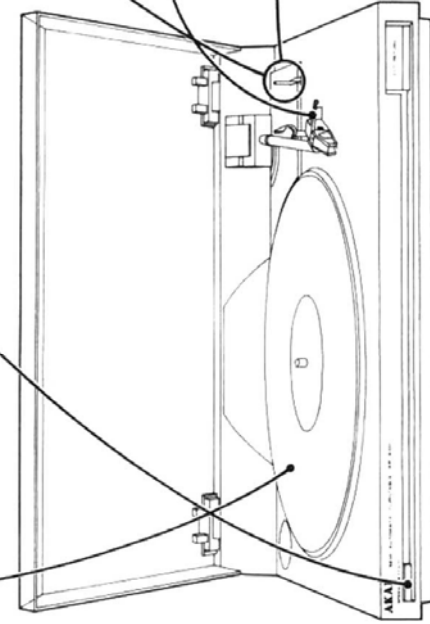

3 Set the **ARM LIFTER** control to the (**▼**) position and lift the tone arm.

4 Take hold of the finger lever and manually bring the stylus over to the point where playback will begin.

5 Set the **ARM LIFTER** control to (**▼**) and playback will begin. At the end of the record, the tone arm will automatically return to the tone arm rest and the platter will stop rotating.

Regarding the auto return system

The auto return system is set to return the tone arm at a specific point on the record. There should be no problem with regular sized records, but with

some types of records which contain music grooves beyond this set point, playback will be interrupted.

To stop playback before the end of a record

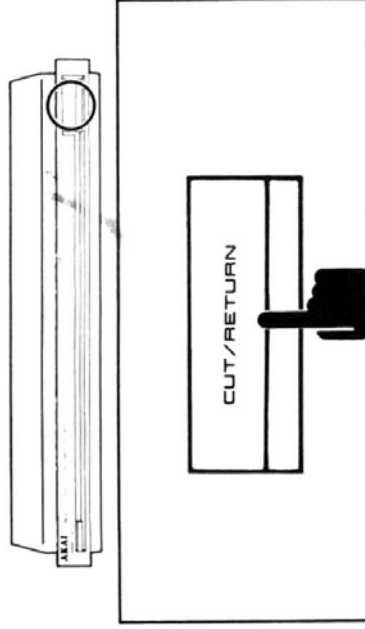

Depress the **CUT/RETURN** button.

To temporarily stop playback

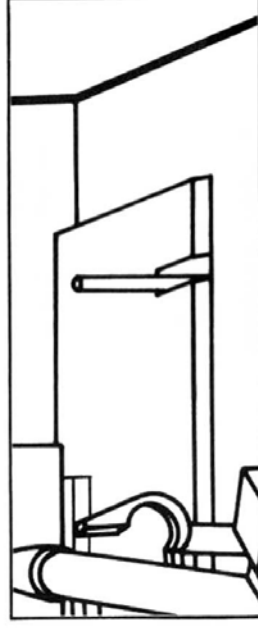

Set the **ARM LIFTER** control to (**▼**). The tone arm will rise. To resume playback, set the **ARM LIFTER** control to (**▲**).

Note: When playback has finished, before clamping the tone arm to the tone arm rest, make certain the **ARM LIFTER** control is at the (**▼**) position.



Useful facts about using the Akai turntable

- Turn off all the components before changing.
- Before changing or installing the cartridge, read the new cartridge's instructions carefully.
- Before changing or installing the cartridge, make certain that the tone arm is on the tone arm rest and clamped.
- To protect the stylus, do not remove the stylus guard until this operation is finished.
- To prevent damage, please handle all the parts carefully.

To change the stylus

Squeeze the 'grip' part of the stylus and pull it down.

Insert the new stylus by snapping it back into place. Avoid pressing on the tip of the stylus during this operation.

For good sound reproduction, change the stylus after approximately 400 hours of use. The Akai replacement stylus for the AP-A101C is the RS-33.

Note: If you have some difficulty changing the stylus with the cartridge in place, try removing the cartridge from the tone arm as shown below. Then, replace the stylus and cartridge.

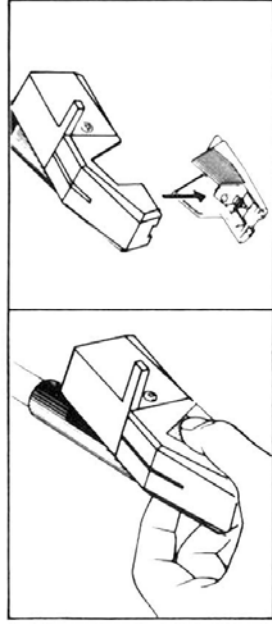

- You may want to replace the cartridge once per year to maintain a high level of performance or to upgrade your turntable. We recommend Akai PC-35 as a replacement cartridge.
- Replace the cartridge with one which has the same output voltage (2.5 mV).
- **TP** is the standard mark for plug-in cartridges. Cartridges with this mark are interchangeable. The Akai AP-A101C is equipped with a high quality **VM** moving magnet cartridge, but any cartridge with the **TP** mark can be used.

In order to enjoy the full capability of your turntable, please note the following when changing the cartridge.

To change or install the cartridge

- 1 Remove the screw on the side of the tone arm (directly behind the cartridge), using a Phillips head screwdriver.
- 2 After removing the screw, grasp the cartridge firmly and pull it forward, away from the tone arm, until it is free. Replace the new cartridge by reversing the above operation.

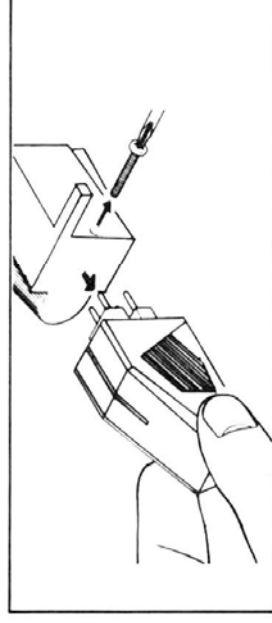

- **Be careful where you place your turntable**
Keep the turntable away from the television, speaker system, amplifier's transformer or any equipment which generates signals or vibrations that can be picked up by the stylus.
- **Keep the records and the stylus clean**
Dirty records and stylus will lead to distortion and make the stylus jump. Therefore, regularly clean the records and the stylus with the optional accessory Cleaning Kit CK-600.
- **Don't bump your turntable**
This can make the stylus jump, leading to damage of the stylus and the record.
- **Let's protect the speaker system from damage**
Set the amplifier's volume control to zero when lifting and lowering the tone arm during playback. Do not touch the stylus while the amplifier is turned on.

- **Let's protect the records**
Do not touch the grooves when handling the record. Dirty grooves will produce distortions. Store records standing in a well ventilated place, relatively free of dust.
- **Don't interrupt any movement**
Do not touch the tone arm or the platter and do not turn off the power under the following conditions:
 - During record playback
 - When the tone arm is moving automatically
 - When the platter is turning
- **To prevent damage to the tone arm:**
Make certain the **ARM LIFTER** control is set to the (**▼**) position before attempting to clamp the tone arm to the arm rest.



Problem? Let's check

No Sound
<ul style="list-style-type: none"> • Check to see if the power cord is connected securely. • The output cord is not connected properly. It should be connected securely to the PHONO jacks. • The amplifier's input selector is not set to PHONO.
Humming noise
<ul style="list-style-type: none"> • The output plug or ground wire is not connected securely. Connect them securely.
Howling or distorted sound
<ul style="list-style-type: none"> • Your turntable is too close to the speaker system. Move it away from the speaker system. • The output plug is not connected securely. Connect them securely.
Stylus jumps Scratching noise
<ul style="list-style-type: none"> • Dirty stylus or record. • Clean the stylus, record, or both. • Warped record. • Replace badly warped records.

Should a problem persist, write down the model and serial numbers and all pertinent data regarding warranty coverage as well as a clear description of the existing trouble. Then, contact your nearest authorized Akai Service Station or the Service Department of Akai Electric Company, Tokyo, Japan.

Specifications

Turntable (platter)	Aluminium alloy die-cast
Drive system	Belt drive
Motor	DC servo motor
Speed	33-1/3 & 45 rpm
Wow and flutter	0.07% WRMS
Rumble	More than 60 dB (DIN B)
Tone arm	Static balanced type
	tone arm
Effective arm length	215 mm
Arm lifter	Oil damped
Stylus pressure adj. range	1.25 g (fixed)
Applicable cartridge weight	5.9 g
Cartridge	VM type (PC-35, T4P plug-in type), included with the AP-A101C only.
Output voltage	2.5 mV
Optimal stylus pressure	1.25 g
Channel balance	Less than 2 dB
Channel separation	More than 20 dB
Power requirements	120 V, 60 Hz for USA and Canada
	220 V, 50 Hz for European countries (except UK)
	240 V, 50 Hz for UK and Australia
	110 V - 120 V/220 V - 240 V, 50 Hz/60 Hz convertible for other countries
Dimensions	440 (W) × 105 (H) × 345 (D) mm
	(17.3 × 4.7 × 13.6 inches)
Weight	3.2 kg (7.0 lbs)

Standard accessories

45 rpm Adapter	1
Screwdriver	1

* For improvement purposes, specifications and design are subject to change without notice.

AKAI

AKAI ELECTRIC CO., LTD.
12-14, Higashi-Kojima, 2-chome,
Ohita-ku, Tokyo, 144 Japan



610330B1
610430A
Printed in Korea

