

AKAI SERVICE MANUAL

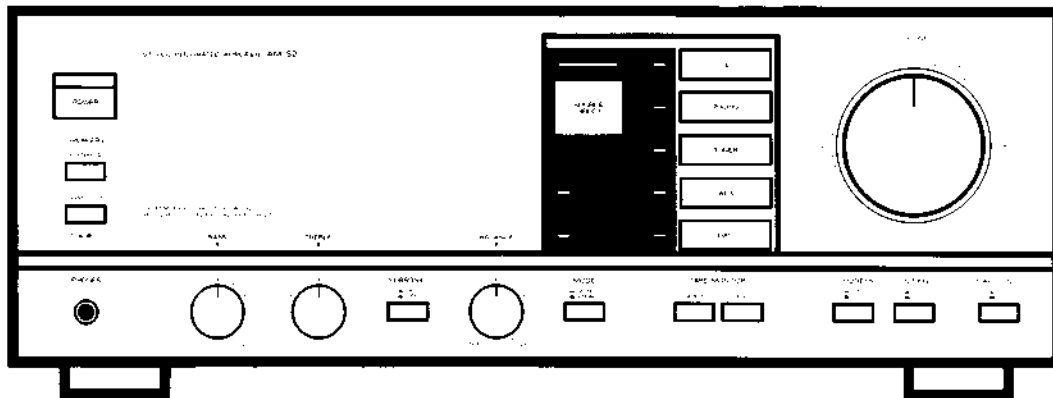

MODEL AM-52

STEREO INTEGRATED AMPLIFIER

MODEL **AM-32**
MODEL **AM-52**

I. SPECIFICATIONS

MODEL AM-32		MODEL AM-52	
Power Output	8 ohms 4 ohms	Power Output	8 ohms 4 ohms
by FTC		by FTC	
(20 Hz - 20 kHz).....	50W/0.03% 60W/0.05%	(20 Hz - 20 kHz).....	70W/0.03% 90W/0.05%
by DIN (1 kHz).....	60W/0.7% 80W/0.7%	by DIN (1 kHz).....	80W/0.7% 120W/0.7%
Music Power	100W 200W	Music Power	135W 270W
Power Bandwidth	5 Hz to 50 kHz/0.06%	Power Bandwidth	5 Hz to 50 kHz/0.06%
Total Harmonic Distortion	0.005% (at Source Direct Mode)	Total Harmonic Distortion	0.005% (at Source Direct Mode)
S/N (IHF-A)		S/N (IHF-A)	
PHONO MM.....	82dB	PHONO MM.....	84dB
PHONO MC.....	62dB	PHONO MC.....	84dB
CD, Tuner, DAT.....	97 dB (at Source Direct Mode)	CD, Tuner, DAT.....	99 dB (at Source Direct Mode)
Residual Noise	0.1 mV	Residual Noise	0.1 mV
Cross Talk (10 kHz)	60dB	Cross Talk (10 kHz)	60dB
Channel Separation (10 kHz)	50dB	Channel Separation (10 kHz)	50dB
Damping Factor (1 kHz, 8 ohms)	50	Damping Factor (1 kHz, 8 ohms)	50
Required Speaker Impedance		Required Speaker Impedance	
A or B.....	4 ohms to 16 ohms	A or B.....	4 ohms to 16 ohms
A and B.....	8 ohms to 16 ohms	A and B.....	8 ohms to 16 ohms
Input Sensitivity/Impedance		Input Sensitivity/Impedance	
PHONO MM.....	2.0 mV/47 kohms	PHONO MM.....	2.0 mV/47 kohms
PHONO MC.....	0.2 mV/100 ohms	PHONO MC.....	0.2 mV/100 ohms
CD, Tuner, Tape, DAT.....	150 mV/47 kohms	CD, Tuner, Tape, DAT.....	150 mV/47 kohms
Max. Input Level		Max. Input Level	
PHONO MM.....	160 mV	PHONO MM.....	160 mV
PHONO MC.....	16 mV	PHONO MC.....	16 mV
Output Level/Impedance		Output Level/Impedance	
Tape.....	150 mV/1 kohms	Tape.....	150 mV/1 kohms
Frequency Response		Frequency Response	
PHONO (Deviation RIAA).....	±0.5 dB	PHONO (Deviation RIAA).....	±0.5 dB
CD, Tuner, DAT.....	5 Hz to 100 kHz (-3 dB) (at Source Direct Mode)	CD, Tuner, DAT.....	5 Hz to 100 kHz (-3 dB) (at Source Direct Mode)
Tone control		Tone control	
Bass.....	±8.5 dB at 100 Hz	Bass.....	±8.5 dB at 100 Hz
Treble.....	±9.0 dB at 10 kHz	Treble.....	±9.0 dB at 10 kHz
Dimensions	425 (W) × 158 (H) × 377 (D) mm (16.7 × 6.1 × 14.8 inches)	Dimensions	425 (W) × 158 (H) × 37 (D) mm (16.7 × 6.1 × 14.8 inches)
Weight	11.2 kg (24.7 lbs)	Weight	11.4 kg (25.2 lbs)

* For improvement purposes, specifications and design are subject change without notice.

★ SAFETY INSTRUCTIONS

PRECAUTIONS DURING SERVICING

1. Parts identified by the Δ symbol parts are critical for safety. Replace only with parts number specified.
2. In addition to safety, other parts and assemblies are specified for conformance with such regulations as those applying to spurious radiation. These must also be replaced only with specified replacements.
Examples: RF converters, tuner units, antenna selector switches, RF cables, noise blocking capacitors, noise blocking filters, etc.
3. Use specified internal wiring. Note especially:
 - 1) Wires covered with PVC tubing
 - 2) Double insulated wires
 - 3) High voltage leads
4. Use specified insulating materials for hazardous live parts. Note especially:
 - 1) Insulation Tape
 - 2) PVC tubing
 - 3) Spacers (Insulating Barriers)
 - 4) Insulation sheets for transistors
 - 5) Plastic screws for fixing microswitch (especially in turntable)
5. When replacing AC primary side components (transformers, power cords, noise blocking capacitors, etc.), wrap ends of wires securely about the terminals before soldering.

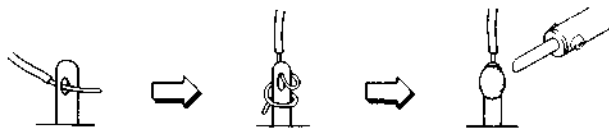

6. Observe that wires do not contact heat producing parts (heatsinks, oxide metal film resistors, fusible resistors, etc.).

7. Check that replaced wires do not contact sharp edged or pointed parts.
8. Also check areas surrounding repaired locations.
9. Use care that foreign objects (screws, solder droplets, etc.) do not remain inside the set.

SAFETY CHECK AFTER SERVICING

Confirm the specified insulation resistance between power cord plug prongs and externally exposed parts of the set is greater than 10 M ohms. but for equipment with external antenna terminals (tuner, receiver, etc.) and is intended for $\square C$ or $\square A$, specified insulation resistance should be headphone jacks line-in-out jacks etc. more than 2.2 M ohms (ground terminals, microphone jacks).

★ INFORMATION

SYMBOLS FOR PRIMARY DESTINATION

Alphabet indicates the destination of the units as listed below.

Symbols	Principal Destinations
$\square A$	USA
$\square B$	UK
$\square C$	Canada
$\square E$	Europe (except UK)
$\square J$	Japan
$\square S$	Australia
$\square V$	W. Germany only
$\square U$	Universal Area
$\square Y^*$	Custom version

VOLTAGE CONVERSION ($\square U$ Mod.1 only)

Before connecting the power cord. SET the VOLTAGE SELECTOR located on the rear panel with a screwdriver so that the correct voltage is indicated.

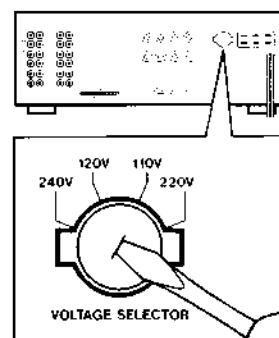

I. DISASSEMBLY

In case of trouble, etc, necessitating dismantling, please dismantle in the order shown in the photographs. Reassemble in reverse order.

* Photographs employed here are of model AM-M32.

1. REMOVAL OF UPPER COVER

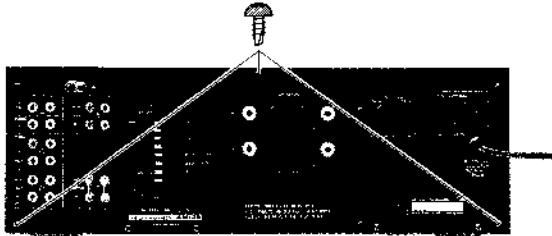

3. REMOVAL OF BOTTOM COVER

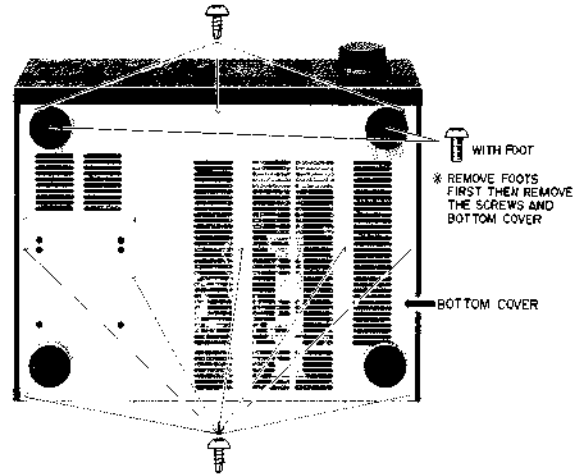

2.

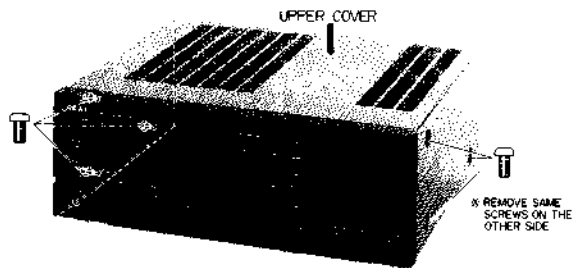

4. REMOVAL OF FRONT PANEL

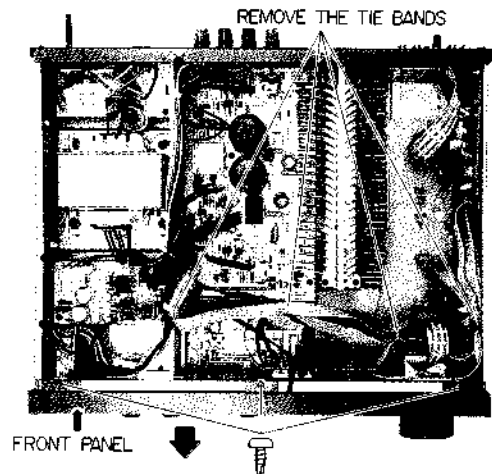

II. CONTROLS

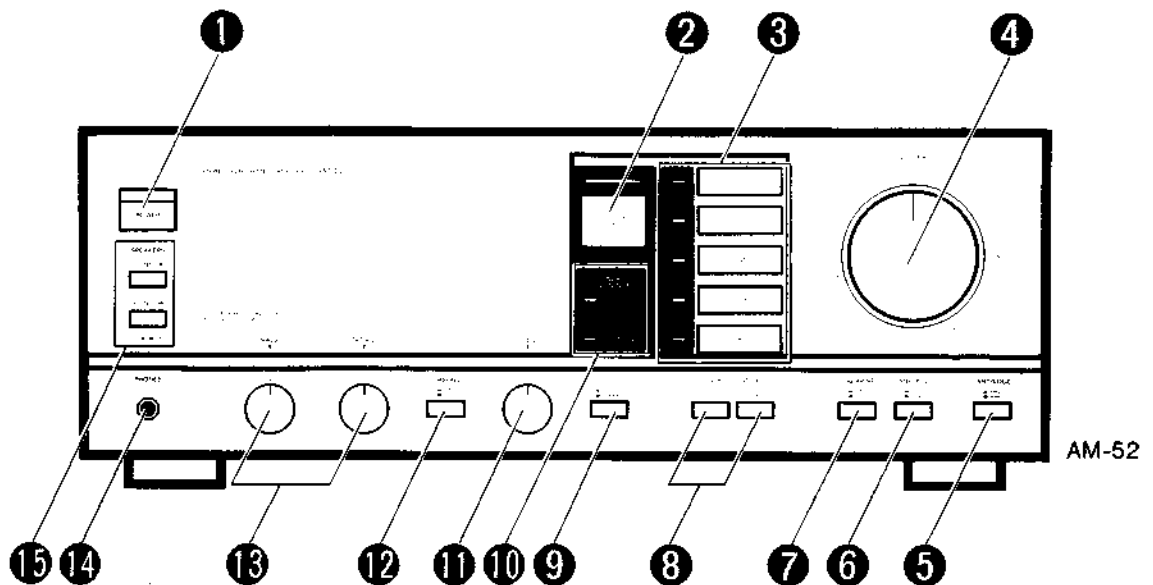

- 1 POWER switch and Indicator**
To turn on and off the amplifier. The indicator will light when the power is turned on.
- 2 SOURCE DIRECT switch and Indicator**
For clearer, low distortion playback of a compact disc, record, radio or DAT tape. The indicator will light when the switch is turned on.
* When the switch is turned on, the BASS and TREBLE tone controls and the BALANCE control are ineffective.
- 3 Input Select buttons (CD, PHONO, TUNER, AUX and DAT) and Indicators**
For selection of a playback source. The indicator of the button you choose will light up when depressed.
- 4 VOLUME control**
To increase or decrease playback volume level.
- 5 CARTRIDGE switch (— MC/ — MM)**
Adjust according to the type of cartridge you are using.
- 6 MUTING switch**
To reduce volume instantly during playback without using the VOLUME control.
- 7 LOUDNESS switch**
For instant compensation of tone setting at low volume level.
- 8 TAPE MONITOR switch (AM-52 only: TAPE 1/TAPE 2)**
For cassette tape playback or monitoring during recording operation.
- 9 MODE switch (AM-52 only: — MONO/ — STEREO)**
To select the playback mode. Normally set this switch to — STEREO.
- 10 TAPE MONITOR indicator (AM-52 only: TAPE 1/TAPE 2)**
Tells you the TAPE MONITOR switch is engaged.
- 11 BALANCE control**
To adjust the left and right channel balance.
- 12 SUBSONIC switch (— ON/ — OFF)**
To reduce unwanted ultra low frequency disturbance (less than 15 Hz) such as rumble during record playback.
- 13 BASS and TREBLE Tone Controls**
To adjust the high note (treble) and low note (BASS) levels.
- 14 PHONES jack**
For headphone listening.
- 15 SPEAKER switch (SYSTEM A/SYSTEM B, — ON/ — OFF)**
To select the speaker system.

Protection circuit

When the Akai amplifier is turned on, no signal will be output to the speakers for several seconds. This is due to the protection circuit which prevents output of noise when the Akai amplifier is turned on.

The protection circuit also functions during playback to protect the speakers from overloading, and to protect the circuit from damages. When speakers with less than rated impedance are used, the protection circuit will short-circuit the + and — speaker cords. Therefore, should the sound be cut during playback:

- 1 Turn off the Akai amplifier.
- 2 Check for and correct the cause.
- 3 Turn on the Akai amplifier.

III. PRINCIPAL PARTS LOCATION

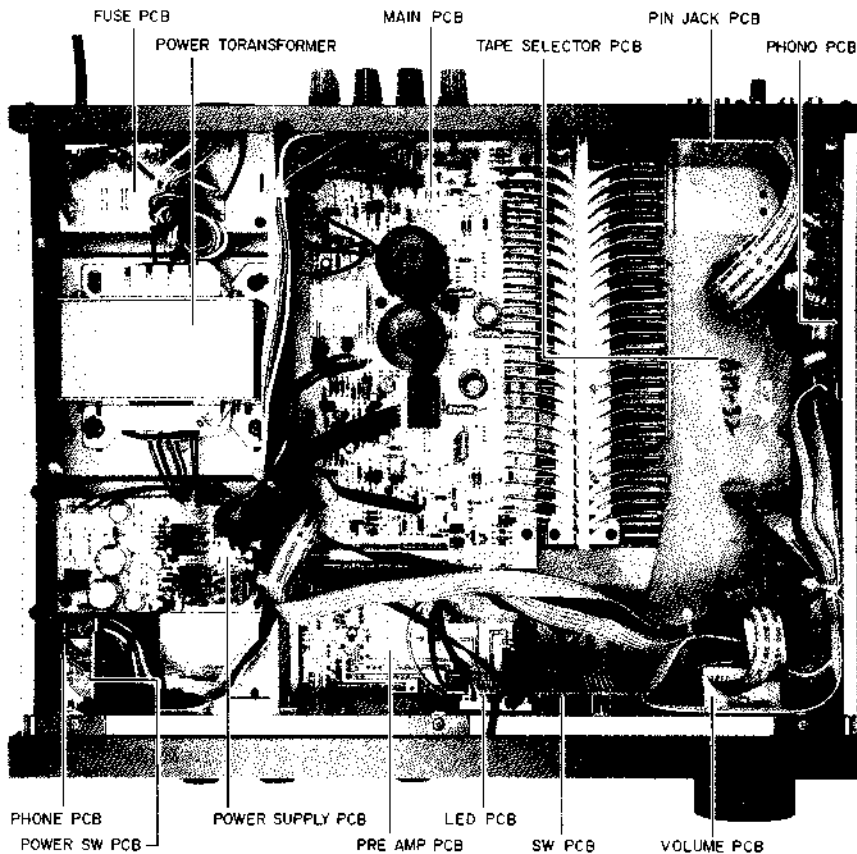

Fig. 3-1

IV. ADJUSTMENT

4-1. IDLING CURRENT ADJUSTMENT

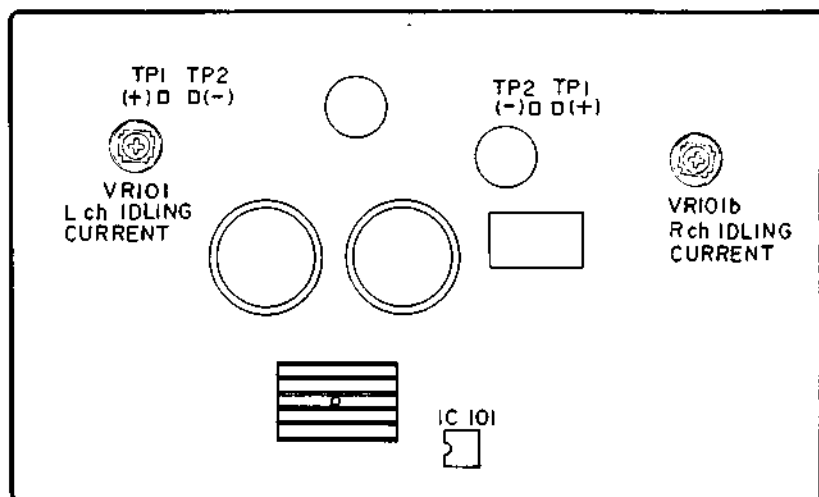

Fig. 4-1 MAIN PCB adjustment points

NOTE: This adjustment should be made after 20 minutes passed from turned on the power.

- 1) Connect a digital DC Voltmeter between TP1 (+) and TP2 (-).
- 2) Adjust VR101 (L ch) or VR101b (R ch) so that the reading on the digital DC Voltmeter is 20 mV.

V. PARTS LIST

ATTENTION

1. When placing an order for parts, be sure to list Part No., Model No. and the description of each part. Otherwise, the non-delivery of the part or the delivery of a wrong part may result.
2. Please make sure that Part No. is correct when ordering.
If not, a part different from the one you ordered may be delivered.
3. Since the parts shown in Parts List of Preliminary Service Manual may have been the subject of changes, please use this Parts List for all future reference.

HOW TO USE THIS PARTS LIST

1. This Parts List lists those parts which are considered necessary for repairs. Other common parts, such as resistors and capacitors, are listed in the "Common List for Service Parts" from which these parts should be selected and stocked.
2. The Recommended Spare Parts List shows those parts in the Parts List which are considered particularly important for service.
3. Parts not shown in the Parts List and "Common List for Service Parts" will not in principle be supplied.
4. How to read the Parts List.

a) Mechanism Block

b) PC Board

2. HEAD BASE BLOCK

REF. NO.	PART NO.	DESCRIPTION
2-1x	BH-T2023A320A	HEAD BASE BLOCK
2-2	HP-H2206A010A	HEAD R/P PR4-8FU C
2-3	ZS-477876	PAN20×03STL CMT
2-4	ZS-536488	BID20×08STL CMT
2-5	ZG-402895	SP CS ANGLE ADJUST

SP (Service Parts) Classification

A small "x" indicates that this part is not shown in the Photo or Illustration.

This number corresponds with the individual parts index number in that figure.

This number corresponds with the Figure Number.

6. MAIN PC BOARD

REF. NO.	PART NO.	DESCRIPTION
6-IC1	EI-324536	IC HD14049BP
6-IC2	EI-336801	IC MB8841-564M
6-C1A	EC-338399	C MMY V 223M 250AC [U,E,B,S]
6-C1B	EC-350949	C MMY V 223M 250DC [J]
6-C1C	EC-338397	C MMY V 223M 125AC [C,A]
6-X1	EI-318384	OSC X'TAL NC-18C

Symbols for primary destination

[A]: AAL(U.S.A.) [S]: SAA(Australia)
 [B]: BEAB(England) [U]: U/T(Universal Area)
 [C]: CSA(Canada) [V]: VDE(W. Germany)
 [E]: CEE(Europe) [Y]: Custom Version
 [J]: JPN(Japan)

SP (Service Parts) Classification

These reference symbols correspond with component symbols in the Schematic Diagrams.

The available PC Board Blocks are listed separately.

5. When Part No. is known, Parts Index at end of Parts List can be used to locate where that part is shown in Parts List by its Reference No. listed at right of Part No.

WARNING

△ (*) INDICATES SAFETY CRITICAL COMPONENTS. FOR CONTINUED SAFETY, REPLACE SAFETY CRITICAL COMPONENTS ONLY WITH MANUFACTURE'S RECOMMENDED PARTS.

AVERTISSEMENT

△ (*) IL INDIQUE LES COMPOSANTS CRITIQUES DE SÉCURITÉ. POUR MAINTENIR LE DEGRÉ DE SÉCURITÉ DE L'APPAREIL, NE REMPLACER QUE DES PIÈCES RECOMMANDÉES PAR LE FABRICANT.

MODEL AM-32

1. RECOMMENDED SPARE PARTS

Ref. No.	Part No.	Description
1	*BT-372984	TRANS POW A2053-B [B]
2	*BT-373351	TRANS POW A2053-EV [E.V]
3	*BT-373349	TRANS POW A2053-U [U]
4	ED-356424	D LED BG5525S GREEN
5	ED-373354	D LED SLP-164B RED [TAPE]
6	ED-361885	D LED SLP-384C-51 GREEN [CD]
7	*ED-330320	D SILICON DBA10C 200/1.0A
8	*ED-350748	D SILICON DBA60C-K15 200/1.0A
9	ED-348990	D SILICON H DS446
10	ED-301911	D SILICON H DS448
11	ED-367949	D ZENER H HZ16L 3 F10
12	ED-368089	D ZENER H HZ20L 2 F10
13	ED-346579	D ZENER H HZ24L 3
14	*EF-364518	FUSE BET T 250V 2.50A [B]
15	*EF-358974	FUSE BET T 250V 630MA [B]
16	*EF-623125	FUSE SEMKO T 250V 2.50A [E.V]
17	*EF-601942	FUSE SEMKO T 250V 630MA [E.V]
18	*EF-326639	FUSE TSC A 250V 3.15A [U]
19	EI-345474	IC HA12002
20	EI-349719	IC M5218P
21	EI-344764	IC M5218P-21
22	EI-362588	IC M5238P
23	EJ-337406	TERMINAL W/SCREW ANB-024-AAA8P [B,E,U] [SPEAKER]
24	EJ-342935	TERMINAL W/SCREW YKD31-0132P8P [V] [SPEAKER]
25	EQ-337159	RELAY POW G4Z-2282P 2NO 24V
26	ER-359522	R CT W R22+R22/5W
27	ER-373356	TR 2SC3381 GR.BL
28	ES-372966	SW PUSH ESB-68524 04-2 N
29	ES-372965	SW PUSH ESB-68636 5 THROW N
30	*ES-361970	SW PUSH SDDL81 01-1 [POWER]
31	ES-372962	SW PUSH SPUL12 H6.5 2-04-02N [TAPE MONITOR]
32	ES-372961	SW PUSH SPUL19 H12.5 2-02-02N [SUBSONIC]
33	ES-372963	SW PUSH SPUL19 H6.5 2-02-02N [MUTING]
34	ES-367641	SW PUSH SPUL19 H6.5 2-04-02S [CARTRIDGE]
35	ES-345476	SW PUSH SPUL23019A 2 THROW [SPEAKER A/B]
36	*ES-349070	SW SELECTOR YKS11-0002 02-4 [U] [VOLTAGE SELECTOR]
37	*ET-345626	TR 2SA1248 S.T
38	*ET-368757	TR 2SA1490 P.Y
39	ET-305463	TR 2SA970 GR.BL
40	ET-307195	TR 2SC2240 GR.BL
41	ET-338179	TR 2SC2291 F.G
42	ET-370038	TR 2SC2910 S.T
43	*ET-345625	TR 2SC3116 S.T
44	*ET-368759	TR 2SC3854 P.Y
45	*ET-366581	TR 2SD1762 E.F
46	EV-373359	VR RK16312A 10K W/EARTH LUG [VOLUME]
47	EV-355457	VR ROTARY RKDA2S 100KCX2 [BASS]
48	EV-355466	VR ROTARY RKDA20 100KCX2 [TREBLE]
49	EV-355456	VR ROTARY 16P10X1W 10S [BALANCE]

2. P.C BOARD BLOCK

Ref. No.	Part No.	Description
1A	BA-A2052A020E	PC(##) MAIN AMP BLK AM-32(U) [U]
1B	BA-A2052A020G	PC(##) MAIN AMP BLK AM-32(E,B) [B,E]
1C	BA-A2052A020H	PC(##) MAIN AMP BLK AM-32(V) [V]
2A	BA-A2052A030C	PC(##) PRE AMP BLK AM-32(U,E,B) [B,E,U]
2B	BA-A2052A030D	PC(##) PRE AMP BLK AM-32(V) [V]

PC(##) MAIN AMP BLK CONSISTS OF FOLLOWING P.C BOARD.

- * MAIN AMP P.C BOARD
- * POWER SUPPLY P.C BOARD
- * PIN JACK P.C BOARD
- * LED P.C BOARD
- * PHONE P.C BOARD
- * FUSE P.C BOARD
- * VOLUME P.C BOARD
- * POWER SW P.C BOARD
- * SOURCE DIRECT LED P.C BOARD
- * POWER LED P.C BOARD

PC(##) PRE-AMP BLK CONSISTS OF FOLLOWING P.C BOARD.

- * PRE-AMP P.C BOARD
- * TAPE SELECTOR P.C BOARD
- * PHONE AMP P.C BOARD
- * SWITCH P.C BOARD

3. MAIN P.C BOARD

Ref. No.	Part No.	Description
C108	EC-333972	C EC V F05 NP SM 3R3M 50DC
C109	EC-200948	C EC V F05 NP SM 1R0M 50DC
C110	EC-200948	C EC V F05 NP SM 1R0M 50DC
C120	EC-366358	C EC V CUT 682M 50.0DC
C121	EC-366358	C EC V CUT 682M 50.0DC
C122	EC-326583	C MMY V CUT CF921 473K 100DC
D102	ED-301911	D SILICON H DS448
D103	ED-301911	D SILICON H DS448
D104	ED-301911	D SILICON H DS448
D105	ED-301911	D SILICON H DS448
D106	ED-301911	D SILICON H DS448
D107	ED-301911	D SILICON H DS448
D108	ED-348990	D SILICON H DS446
D109	ED-348990	D SILICON H DS446
D110	ED-301911	D SILICON H DS448
D111	*ED-350748	D SILICON DBA60C-K15 200/1.0A
D112	ED-356424	D LED BG5525S GREEN
D113	ED-368089	D ZENER H HZ20L 2 F10
D114	ED-368089	D ZENER H HZ20L 2 F10
IC101	EI-349719	IC M5218P
IC102	EI-345474	IC HA12002
L101	EQ-332116	COIL FIX 2 103AK-008A 2R X
RL101	EQ-337159	RELAY POW G4Z-2282P 2NO 24 V
R107	ER-375110	R CB H S10 FS RDS 1/4W 80J
R108	ER-375110	R CB H S10 FS RDS 1/4W 80J
R115	ER-324185	R CB H S10 FS RDS 1/4W 21J
R116	ER-324186	R CB H S10 FS RDS 1/4W 81J
R120	ER-324185	R CB H S10 FS RDS 1/4W 21J
R126	ER-322591	R CB H S10 FS RDS 1/4W 11J
R127	ER-333372	R CB H S10 FS RDS 1/4W 50J
R128	ER-333372	R CB H S10 FS RDS 1/4W 50J
R129	ER-359522	R CT W R22-R22/5W
R143	ER-333023	R OMF H S20 FS 2W 100J
R144	ER-333023	R OMF H S20 FS 2W 100J
R154	ER-373378	R OMF H S15 FS 2W 272J
R157	ER-318400	R CB H S10 FS RDS 1/4W 80J

Ref. No.	Part No.	Description
R159	ER-318400	R CB H S10 FS RDS 1/4W 680J
TR101	ET-338179	TR 2SC2291 F.G
TR102	ER-373356	TR 2SC3381 GR,BL
TR103	ET-370038	TR 2SC2910 S,T
TR104	ET-305463	TR 2SA970 GR,BL
TR105	ET-305463	TR 2SA970 GR,BL
TR106	ET-370038	TR 2SC2910 S,T
TR109	*ET-345625	TR 2SC3116 S,T
TR110	*ET-345626	TR 2SA1248 S,T
TR111	ET-307195	TR 2SC2240 GR,BL
TR112	ET-305463	TR 2SA970 GR,BL
TR113	ET-305463	TR 2SA970 GR,BL
TR116	ET-305463	TR 2SA970 GR,BL
VR101	EV-330369	R S-FIX H RH1051C 0.15W 222

4. POWER SUPPLY P.C BOARD

Ref. No.	Part No.	Description
C101	EC-201639	C EC V CUT AS1 331M 80.0DC
C102	EC-201639	C EC V CUT AS1 331M 80.0DC
C109	EC-326583	C MMY V CUT CF921 473K 400DC
C110	EC-201637	C EC V CUT AS1 101M 80.0DC
C111	EC-201637	C EC V CUT AS1 101M 80.0DC
D101	ED-301911	D SILICON H DS448
D102	ED-367949	D ZENER H HZ16L 3 F10
D103	ED-367949	D ZENER H HZ16L 3 F10
D104	ED-301911	D SILICON H DS448
D105	ED-301911	D SILICON H DS448
D106	ED-346579	D ZENER H HZ24L 3
D107	*ED-330320	D SILICON DBA10C 200/1.0A
R105	ER-372988	R CB H S12 FS RDS 1/2W 102J
R110	*ER-324480	R CB H S10 FS RDS 1/4W 470J
R111	*ER-324480	R CB H S10 FS RDS 1/4W 470J
R112	ER-333372	R CB H S10 FS RDS 1/4W 150J
R113	ER-333372	R CB H S10 FS RDS 1/4W 150J
R114	ER-333372	R CB H S10 FS RDS 1/4W 150J
TR101	*ET-345625	TR 2SC3116 S,T
TR102	*ET-345626	TR 2SA1248 S,T
TR103	*ET-366581	TR 2SD1762 E.F
F3A	*EF-601942	FUSE SEMKO T 250V 630MA [E.V]
F3B	*EF-358974	FUSE BET T 250V 630MA [B]
F4A	*EF-601942	FUSE SEMKO T 250V 630MA [E.V]
F4B	*EF-358974	FUSE BET T 250V 630MA [B]

5. PIN JACK P.C BOARD

Ref. No.	Part No.	Description
J101	EJ-373358	PIN J T5765-AABA 4P [TAPE REC/PB]
J103	EJ-373358	PIN J T5765-AABA 4P [ADAPTOR IN/OUT]

6. LED P.C BOARD

Ref. No.	Part No.	Description
D101	ED-361885	D LED SLP-384C-51 GREEN [CD]
D102	ED-361885	D LED SLP-384C-51 GREEN [PHONO]
D103	ED-361885	D LED SLP-384C-51 GREEN [TUNER]
D104	ED-361885	D LED SLP-384C-51 GREEN [AUX]
D105	ED-361885	D LED SLP-384C-51 GREEN [DAT]
D106	ED-373354	D LED SLP-164B RED [TAPE]

7. PHONE P.C BOARD

Ref. No.	Part No.	Description
J101	EJ-348846	PHONE J 3P HLJ0540-010 6.3 [PHONES]
R101	ER-557583	R OMF H FS 2W 431J
SW101	ES-345476	SW PUSH SPUL23019A 2 THROW [SPEAKER A/B]

8. FUSE P.C BOARD

Ref. No.	Part No.	Description
L101	EO-338409	COIL LF FK08160MH02 250UH [V]
F1A	*EF-326639	FUSE TSC A 250V 3.15A [U]
F1B	*EF-623125	FUSE SEMKO T 250V 2.50A [E.V]
F1C	*EF-364518	FUSE BET T 250V 2.50A [B]
F2	*EF-326639	FUSE TSC A 250V 3.15A [U]

9. VOLUME P.C BOARD

Ref. No.	Part No.	Description
VR101	EV-373359	VR RK16312A 10K W/1/4PTH LUG [VOLUME]

10. POWER SW P.C BOARD

Ref. No.	Part No.	Description
C101A	*EC-320548	C CE V F 103Z 250AC [U]
C101B	*EC-338496	C CE V FZ 472P 400AC [B,E,V]
SW101	*ES-361970	SW PUSH SDDL1 01-1 [POWER]

11. SOURCE DIRECT LED P.C BOARD

Ref. No.	Part No.	Description
D101	ED-361885	D LED SLP-384C-51 GREEN [SOURCE DIRECT]
D102	ED-361885	D LED SLP-384C-51 GREEN [SOURCE DIRECT]

12. POWER LED P.C BOARD

Ref. No.	Part No.	Description
D101	ED-361885	D LED SLP-384C-51 GREEN [POWER]
D102	ED-361885	D LED SLP-384C-51 GREEN [POWER]

13. PRE-AMP P.C BOARD

Ref. No.	Part No.	Description
IC1	EI-344764	IC M5218P-21
SW1	ES-372961	SW PUSH SPUL19 H12.5 2-02-02N [SUBSONIC]
VR1	EV-355466	VR ROTARY RKDA20 100KCX2 [TREBLE]
VR2	EV-355457	VR ROTARY RKDA25 100KCX2 [BASS]
VR3	EV-355456	VR ROTARY 16P10X1W 105 [BALANCE]

14. TAPE SELECTOR P.C BOARD

Ref. No.	Part No.	Description
IC1	EI-362588	IC M5238P
SW1	ES-372962	SW PUSH SPUL12 H6.5 2-04-02N [TAPE MONITOR]
SW2	ES-372963	SW PUSH SPUL19 H6.5 2-02-02N [MUTING]
SW3	ES-372963	SW PUSH SPUL19 H6.5 2-02-02N [LOUDNESS]

15. PHONE P.C BOARD

Ref. No.	Part No.	Description
IC1	EI-344764	IC M5218P-21
J1	EJ-366336	PIN J T5857-ABBA P 4P [CD/PHONO]
J2	EJ-366336	PIN J T5857-ABBA P 4P [TUNER/AUX]
J3	EJ-366336	PIN J T5857-ABBA P 4P [DAT]
L1	EO-337884	COIL FIX 2 FL12R751E 751K [V]
SW1	ES-367641	SW PUSH SPUL19 H6.5 2-04-02S [CARTRIDGE]
TR1	ET-372959	TR FET 2SK389 V

16. SWITCH P.C BOARD

Ref. No.	Part No.	Description
R1	ER-367950	R OMF H S10 FS 1/2W 152J
R4	ER-358606	R OMF H S10 FS 1/2W 102J
SW1	ES-372965	SW PUSH ESB-68636 5 THROW N
SW2	ES-372966	SW PUSH ESB-68524 04-2 N

17. TERMINAL P.C BOARD (V ONLY)

Ref. No.	Part No.	Description
L1	EO-342936	COIL BALUM [V]
TM1	EJ-342935	TERMINAL W/SCREW YKD31-0132P8P [V] [SPEAKER]
T901D	*BT-373349	TRANS POW A2053-U
T901E	*BT-373351	TRANS POW A2053-EV
T901F	*BT-372984	TRANS POW A2053-B
1	ZS-345624	ST PAN40X08STL CMT CUP [TRANS FIX]
2D	SP-373222E	PANEL REAR AM-32(U)
2E	SP-373222G	PANEL REAR AM-32(E,V)
2F	SP-373222K	PANEL REAR AM-32(B)
3	EJ-329610	TERMINAL W/SCREW UB-0067 L 1P
4	ZS-308846	T2BR30X08STL BZN PROJECTION
TM902	EJ-337406	TERMINAL W/SCREW ANB-024-AAA8P [U.E.B] [SPEAKER]
TM1	EJ-342935	TERMINAL W/SCREW YKD31-0132P8P [V] [SPEAKER]
5A	ZS-351886	PT BR30X10STL BNI [U.E.B]
5B	ZS-332468	T2BR30X20STL NI3 GUIDE [V]
J901	*EJ-364357	SOCKET OUTLET S2T-733T162 [U]
SW901	*ES-349070	SW SELECTOR YKS11-000202-4 [U]
6A	*EW-363659	AC CORD 200 0129AVFF B010 A U [U]
6B	*EW-363672	AC CORD 200 0364 LCFL B010 A EV [E,V]
6C	*EW-363684	AC CORD 200 LCFL B070 A B [B]
7	EJ-369015	PLUG SHORT-PIN CNT31-005J
8	ZS-351886	PT BR30X10STL BNI
9	ZS-308846	T2BR30X08STL BZN PROJECTION
10	ZS-490228	T2BD30X08STL CMT [FRONT PANEL FIX]
11	ZW-231030	RV NYL30X045 BL
12	MZ-553948	WIRE BAND F-100
TR901	*ET-345625	TR 2SC3116 S.T
TR902A	*ET-368759	TR 2SC3854 P.Y
TR903A	*ET-368757	TR 2SA1490 P.Y

ASSEMBLY BLOCK

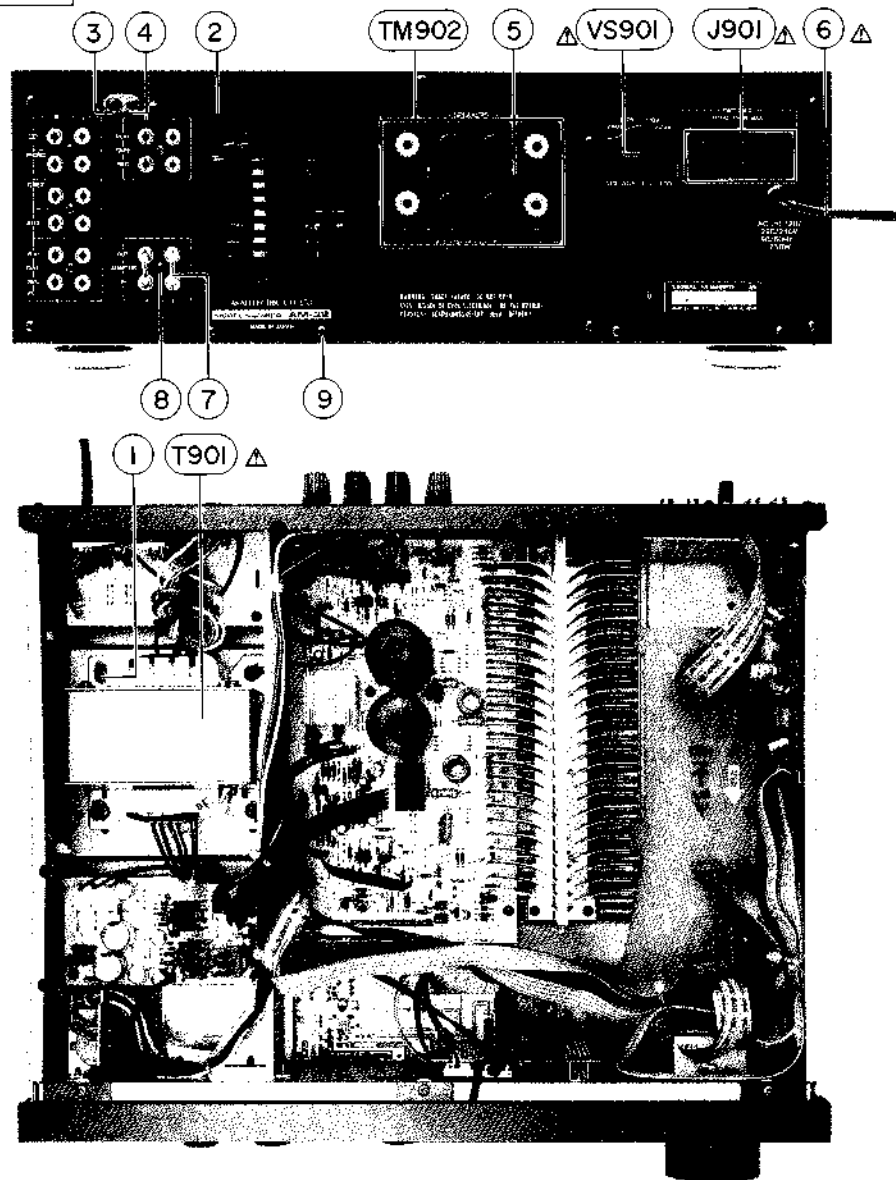

18. ASSEMBLY BLOCK

Ref. No.	Part No.	Description	Ref. No.	Part No.	Description
1B	BD-A2052A040C	PANEL FRONT BLK AM-32-G [GOLD]	8	ZS-447840	T2BR30X08STL CMT
T901A	*BT-373349	TRANS POW A2053-U [U]	5A	ZS-351886	PT BR30X10STL BNI [B,E,U]
T901B	*BT-373351	TRANS POW A2053-EV [E,V]	5B	ZS-332468	T2BR30X20STL NI3 GUIDE [V]
T901C	*BT-372984	TRANS POW A2053-B [B]	J901	*EJ-364357	SOCKET OUTLET S2T-73T162 [U]
1	ZS-345624	ST PAN40X08STL CMT CUP [TRANS FIX]	VS901	*ES-349070	SW SELECTOR YKS11-0102 02-4 [U] [VOLTAGE SELECTOR]
3	SK-373242B	KNOB MODE-BLACK [BLACK]	6A	*EW-363659	AC CORD 200 0129AVR B 070 A U [U]
4	SK-373244A	KNOB BALANCE-GOLD [GOLD]	6B	*EW-363672	AC CORD 200 0364 LCFL B 070 A EV [E,V]
4	SK-373244B	KNOB BALANCE-BLACK [BLACK]	6C	*EW-363684	AC CORD 200 LCFL B070 A B [B]
2A	SP-373222E	PANEL REAR AM-32(U) [U]	7	EJ-369015	PLUG SHORT-PIN CNT31 00 57
2B	SP-373222G	PANEL REAR AM-32(E,V) [E,V]	8	ZS-351886	PT BR30X10STL BNI
2C	SP-373222K	PANEL REAR AM-32(B) [B]	9	ZS-308846	T2BR30X08STL BZN PROJECTION
3	EJ-329610	TERMINAL W/SCREW UB-0067 L 1P	10	ZS-490228	T2BD30X08STL CMT [FRONT PANEL FIX]
4	ZS-308846	T2BR30X08STL BZN PROJECTION	11	ZW-231030	RV NYL30X045 BL
TM902	EJ-337406	TERMINAL W/SCREW ANB-024-AAA8P [B,E,U] [SPEAKER]	12	MZ-553948	WIRE BAND F-100
			TR901	*ET-345625	TR 2SC3116 S,T
			TR902	*ET-368759	TR 2SC3854 P,Y
			TR903	*ET-368757	TR 2SA1490 P,Y

PARTS LIST

FINAL ASSEMBLY BLOCK

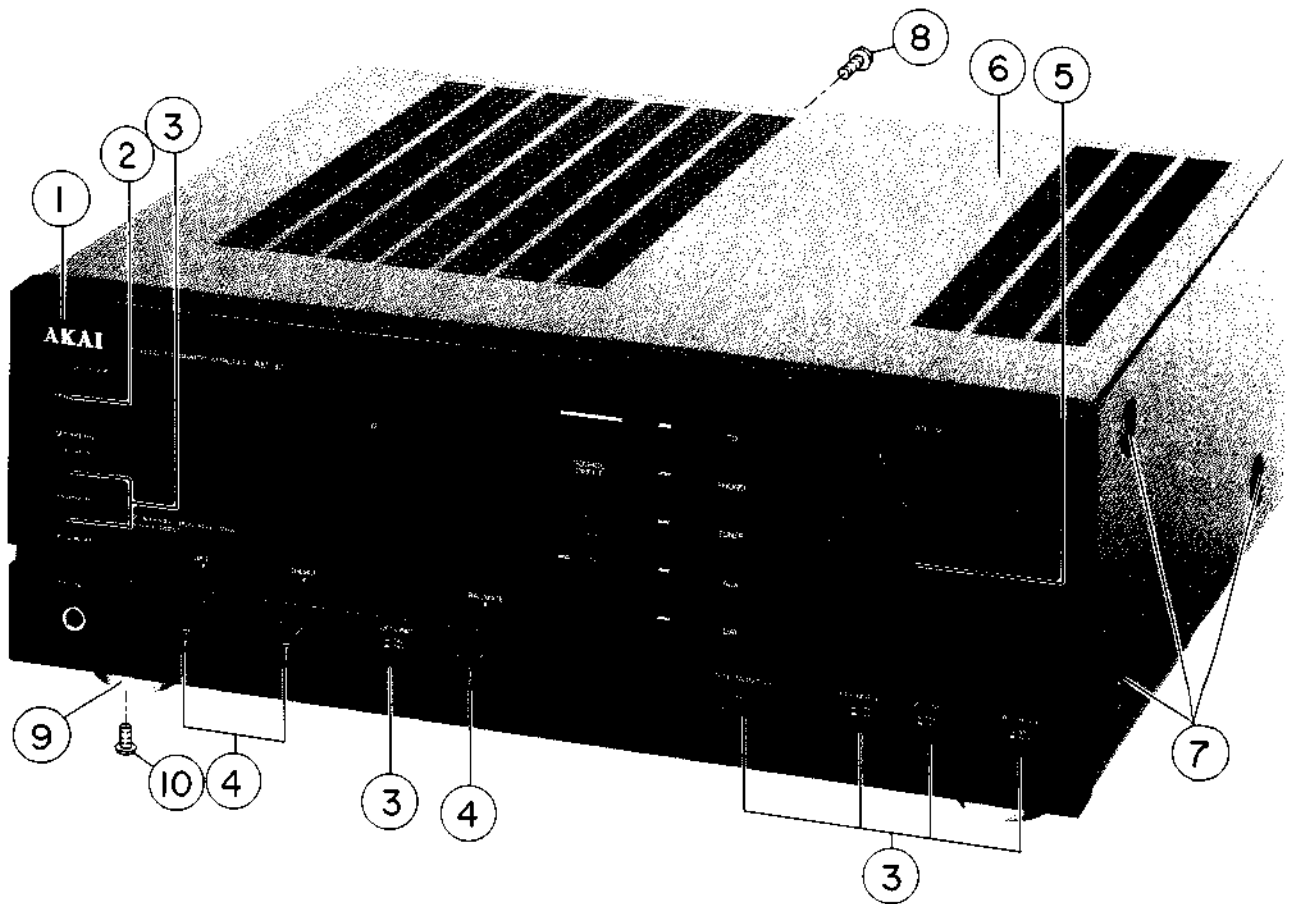

19. FINAL ASSEMBLY BLOCK

Ref. No.	Part No.	Description
1-G	BD-A2052A040C	PANEL FRONT BLK AM-32-G [GOLD]
1-B	BD-A2052A040D	PANEL FRONT BLK AM-32-B [BLACK]
2-G	SK-373236A	KNOB POWER-GOLD [GOLD]
2-B	SK-373236B	KNOB POWER-BLACK [BLACK]
3-G	SK-373242A	KNOB MODE-GOLD [GOLD]
3-B	SK-373242B	KNOB MODE-BLACK [BLACK]
4-G	SK-373244A	KNOB BALANCE-GOLD [GOLD]
4-B	SK-373244B	KNOB BALANCE-BLACK [BLACK]
5-G	SK-373243A	KNOB VOLUME-GOLD [GOLD]
5-B	SK-373243B	KNOB VOLUME-BLACK [BLACK]
6-G	SP-373246A	COVER UPPER-GOLD [GOLD]
6-B	SP-373246B	COVER UPPER-BLACK [BLACK]
7-G	ZS-341959	ST BID40X06STL N13 [GOLD]
7-B	ZS-341960	ST BID40X06STL BNI [BLACK]
8	ZS-447840	T2BR30X08STL CMT
9	SA-B369350A2	FOOT PART
10	ZS-447805	T2BR30X12STL CMT

SYMBOL FOR COLOR VARIATION

B: BLACK

G: GOLD

MODEL AM-52

1. RECOMMENDED SPARE PARTS

Ref. No.	Part No.	Description
1	*BT-372985	TRANS POW A2052-B [B]
2	*BT-372944	TRANS POW A2052-EV [E.V]
3	*BT-372942	TRANS POW A2052-U [U]
4	ED-356424	D LED BG5525S GREEN
5	ED-373354	D LED SLP-1648 RED [TAPE 1]
6	ED-375761	D LED SLP-336B-050 GREEN [CD]
7	ED-361885	D LED SLP-384C-51 GREEN [SOURCE DIRECT]
8	*ED-330320	D SILICON DBA10C 200/1.0A
9	*ED-350748	D SILICON DBA60C-K15 200/1.0A
10	ED-348990	D SILICON H DS446
11	ED-301911	D SILICON H DS448
12	ED-346550	D ZENER H HZ11L B2
13	ED-367949	D ZENER H HZ16L 3 F10
14	ED-368089	D ZENER H HZ20L 2 F10
15	ED-346579	D ZENER H HZ24L 3
16	*EF-359225	FUSE BET T 250V 3.15A [B]
17	*EF-358641	FUSE BET T 250V 800MA [B]
18	*EF-691007	FUSE SEMKO T 250V 3.15A [E.V]
19	*EF-258344	FUSE SEMKO T 250V 800MA [E.V]
20	*EF-306952	FUSE TSC A 250V 4.00A [U]
21	EI-345474	IC HA12002
22	EI-349719	IC M5218P
23	EI-344764	IC M5218P-21
24	EI-362588	IC M5238P
25	*EJ-364357	SOCKET OUTLET S2T-733T162 [U]
26	EJ-342935	TERMINAL W/SCREW YK031-0132P8P [V]
27	EQ-337159	RELAY POW G4Z-2282P 2NO 24V
28	ER-359522	R CT W R22+R22/5W
29	ES-372966	SW PUSH ESB-68524 04-2 N [SOURCE DIRECT]
30	ES-372965	SW PUSH ESB-68636 5 THROW N [FUNCTION]
31	*ES-361970	SW PUSH SDDL B1 01-1 [POWER]
32	ES-372961	SW PUSH SPUL19 H12.5 2-02-02N [SUBSONIC]
33	ES-372963	SW PUSH SPUL19 H6.5 2-02-02N [MUTING]
34	ES-367641	SW PUSH SPUL19 H6.5 2-04-02S [CARTRIDGE]
35	ES-345476	SW PUSH SPUL23019A 2 THROW [SPEAKER A/B]
36	ES-368769	SW PUSH SPUL24 2 THROW N [TAPE MONITOR]
37	*ES-349070	SW SELECTOR YKS11-0002 02-4 [U] [VOLTAGE SELECTOR]
38	ET-372959	TR FET 2SK389 V
39	*ET-345626	TR 2SA1248 S,T
40	*ET-368758	TR 2SA1491 P,Y
41	ET-305463	TR 2SA970 GR,BL
42	ET-307195	TR 2SC2240 GR,BL
43	ET-338179	TR 2SC2291 F,G
44	ET-370038	TR 2SC2910 S,T
45	*ET-345625	TR 2SC3116 S,T
46	*ET-368760	TR 2SC3855 P,Y
47	*ET-366581	TR 2SD1762 E,F
48	EV-373359	VR RK16312A 10K W/EARTH LUG [VOLUME]
49	EV-355457	VR ROTARY RKDA2S 100KCX2 [BASS]
50	EV-355466	VR ROTARY RKDA2O 100KCX2 [TREBLE]
51	EV-355458	VR ROTARY 16P10X1W 105 [BLANCE]

2. P.C BOARD BLOCK

Ref. No.	Part No.	Description
1A	BA-A2052A020A	PC(##) MAIN AMP BLK AM-52(U) [U]
1B	BA-A2052A020C	PC(##) MAIN AMP BLK AM-52(E,B) [B,E]
1C	BA-A2052A020D	PC(##) MAIN AMP BLK AM-52(V) [V]
1D	BA-A2052A020E	PC(##) MAIN AMP BLK AM-32(U)
1E	BA-A2052A020G	PC(##) MAIN AMP BLK AM-32(E,B)
1F	BA-A2052A020H	PC(##) MAIN AMP BLK AM-32(V)
2A	BA-A2052A030A	PC(##) PRE AMP BLK AM-52(U,E,B) [B,E,U]
2B	BA-A2052A030B	PC(##) PRE AMP BLK AM-52(V) [V]
2C	BA-A2052A030C	PC(##) PRE AMP BLK AM-32(U,E,B)
2D	BA-A2052A030D	PC(##) PRE AMP BLK AM-32(V)

PC (##) MAIN AMP BLK CONSISTS OF FOLLOWING P.C BOARD.

- * MAIN AMP P.C BOARD
- * POWER SUPPLY P.C BOARD
- * PIN JACK P.C BOARD
- * LED P.C BOARD
- * PHONE P.C BOARD
- * FUSE P.C BOARD
- * VOLUME P.C BOARD
- * POWER SW P.C BOARD
- * SOURCE DIRECT LED P.C BOARD
- * POWER LED P.C BOARD

PC (##) PRE-AMP BLK CONSISTS OF FOLLOWING P.C BOARD.

- * PRE-AMP P.C BOARD
- * TAPE SELECTOR P.C BOARD
- * PHONE AMP P.C BOARD
- * SWITCH P.C BOARD

3. MAIN AMP P.C BOARD

Ref. No.	Part No.	Description
C108	EC-333972	C EC V F05 NP SM 3R3N 5.0DC
C109	EC-200948	C EC V F05 NP SM 1R0N 5.0DC
C110	EC-200948	C EC V F05 NP SM 1R0N 5.0DC
C120	EC-373373	C EC V CUT 822M 56.0M
C120A	EC-366358	C EC V CUT 682M 50.0M [AM-32]
C121	EC-373373	C EC V CUT 822M 56.0M
C121A	EC-366358	C EC V CUT 682M 50.0M [AM-32]
C122	EC-326583	C MMY V CUT CF921 4/3K 400DC
D101	ED-346550	D ZENER H HZ11L B2
D102	ED-301911	D SILICON H DS448
D103	ED-301911	D SILICON H DS448
D104	ED-301911	D SILICON H DS448
D105	ED-301911	D SILICON H DS448
D106	ED-301911	D SILICON H DS448
D107	ED-301911	D SILICON H DS448
D108	ED-348990	D SILICON H DS446
D109	ED-348990	D SILICON H DS446
D110	ED-301911	D SILICON H DS448
D111	*ED-350748	D SILICON DBA60C-K15 200/1.0A
D112	ED-356424	D LED BG5525S GREEN
D113	ED-368089	D ZENER H HZ20L 2 F10
D114	ED-368089	D ZENER H HZ20L 2 F10
D115	EI-349719	IC M5218P
D116	EI-345474	IC HA12002
L101	EO-332116	COIL FIX 2 103AK-006A2F2K
RL101	EQ-337159	RELAY POW G4Z-2282P2NO 24V
R107	ER-318400	R CB H S10 FS RDS 1/4W 680J
R107A	ER-375110	R CB H S10 FS RDS 1/4W 820J [AM-32]

Ref. No.	Part No.	Description
R108	ER-318400	R CB H S10 FS RDS 1/4W 680J
R108A	ER-375110	R CB H S10 FS RDS 1/4W 820J [AM-32]
R115	ER-324185	R CB H S10 FS RDS 1/4W 221J
R116	ER-375108	R CB H S10 FS RDS 1/4W 272J
R116A	ER-324186	R CB H S10 FS RDS 1/4W 681J [AM-32]
R120	ER-324185	R CB H S10 FS RDS 1/4W 221J
R126	ER-322591	R CB H S10 FS RDS 1/4W 101J
R127	ER-333372	R CB H S10 FS RDS 1/4W 150J
R128	ER-333372	R CB H S10 FS RDS 1/4W 150J
R129	ER-359522	R CT W R22 +R22/5W
R143	ER-333023	R OMF H S20 FS 2W 100J
R144	ER-333023	R OMF H S20 FS 2W 100J
R154	ER-373378	R OMF H S15 FS 2W 272J
R157	ER-318400	R CB H S10 FS RDS 1/4W 680J
R159	ER-318400	R CB H S10 FS RDS 1/4W 680J
TR101	ET-338179	TR 2SC2291 F,G
TR102	ET-372959	TR FET 2SK389 V
TR102A	ER-373356	TR 2SC3381 GR,BL [AM-32]
TR103	ET-370038	TR 2SC2910 S,T
TR104	ET-305463	TR 2SA970 GR,BL
TR105	ET-305463	TR 2SA970 GR,BL
TR106	ET-370038	TR 2SC2910 S,T
TR109	*ET-345625	TR 2SC3116 S,T
TR110	*ET-345626	TR 2SA1248 S,T
TR111	ET-307195	TR 2SC2240 GR,BL
TR112	ET-305463	TR 2SA970 GR,BL
TR113	ET-305463	TR 2SA970 GR,BL
TR116	ET-305463	TR 2SA970 GR,BL
VR101	EV-330369	R S-FIX H RH1051C 0.15W 222

4. POWER SUPPLY P.C BOARD

Ref. No.	Part No.	Description
C101	EC-201639	C EC V CUT AS1 331M 80.0DC
C102	EC-201639	C EC V CUT AS1 331M 80.0DC
C109	EC-326583	C MMY V CUT CF921 473K 400DC
C110	EC-201637	C EC V CUT AS1 101M 80.0DC
C111	EC-201637	C EC V CUT AS1 101M 80.0DC
D101	ED-301911	D SILICON H DS448
D102	ED-367949	D ZENER H HZ16L 3 F10
D103	ED-367949	D ZENER H HZ16L 3 F10
D104	ED-301911	D SILICON H DS448
D105	ED-301911	D SILICON H DS448
D106	ED-346579	D ZENER H HZ24L 3
D107	*ED-330320	D SILICON DBA10C 200/1.0A
R105	ER-372988	R CB H S12 FS RDS 1/2W 102J
R110	*ER-324480	R CB H S10 FS RDS 1/4W 470J
R111	*ER-324480	R CB H S10 FS RDS 1/4W 470J
R112	ER-333372	R CB H S10 FS RDS 1/4W 150J
R113	ER-333372	R CB H S10 FS RDS 1/4W 150J
R114	ER-333372	R CB H S10 FS RDS 1/4W 150J
TR101	*ET-345625	TR 2SC3116 S,T
TR102	*ET-345626	TR 2SA1248 S,T
TR103	*ET-366581	TR 2SD1762 E,F
F3A	*EF-258344	FUSE SEMKO T 250V 800MA [E,V]
F3B	*EF-358641	FUSE BET T 250V 800MA [B]
F3C	*EF-601942	FUSE SEMKO T 250V 630MA [E,V][AM-32]
F3D	*EF-358974	FUSE BET T 250V 630MA [B][AM-32]
F4A	*EF-258344	FUSE SEMKO T 250V 800MA [E,V]
F4B	*EF-358641	FUSE BET T 250V 800MA [B]
F4C	*EF-601942	FUSE SEMKO T 250V 630MA [E,V][AM-32]
F4D	*EF-358974	FUSE BET T 250V 630MA [B][AM-32]

5. PIN JACK P.C BOARD

Ref. No.	Part No.	Description
J101	EJ-373358	PIN J T5765-AABA 4P [TAPE 1 REC/PB]
J102	EJ-373358	PIN J T5765-AABA 4P [ADAPTOR IN/OUT]
J103	EJ-373358	PIN J T5765-AABA 4P [TAPE 2 REC/PB]

6. LED P.C BOARD

Ref. No.	Part No.	Description
D101	ED-375761	D LED SLP-336B-050 GREEN [CD]
D102	ED-375761	D LED SLP-336B-050 GREEN [PHONO]
D103	ED-375761	D LED SLP-336B-050 GREEN [TUNER]
D104	ED-375761	D LED SLP-336B-050 GREEN [AUX]
D105	ED-375761	D LED SLP-336B-050 GREEN [DAT]
D106	ED-373354	D LED SLP-164B RED [TAPE 1]
D107	ED-373354	D LED SLP-164B RED [TAPE 2]

7. PHONE P.C BOARD

Ref. No.	Part No.	Description
J101	EJ-348846	PHONE J 3P HLJ0540-010 6J [PHONES]
R101	ER-557583	R OMF H FS 2W 431J
SW101	ES-345476	SW PUSH SPUL23019A 2 THROW [SPEAKER A/B]

8. FUSE P.C BOARD

Ref. No.	Part No.	Description
L101	EO-338409	COIL LF FKOB160MH02 250UH [V]
F1A	*EF-306952	FUSE TSC A 250V 4.00A [U]
F1B	*EF-691007	FUSE SEMKO T 250V 3.15A [E,V]
F1C	*EF-359225	FUSE BET T 250V 3.15A [B]
F1D	*EF-306951	FUSE TSC A 250V 2.50A [U][AM-32]
F1E	*EF-623125	FUSE SEMKO T 250V 2.50A [E,V][AM-32]
F1F	*EF-364518	FUSE BET T 250V 2.50A [B][AM-32]
F2	*EF-306952	FUSE TSC A 250V 4.00A [U]
F2B	*EF-306951	FUSE TSC A 250V 2.50A [U][AM-32]

9. VOLUME P.C BOARD

Ref. No.	Part No.	Description
VR101	EV-373359	VR RK16312A 10K W/EARTH LUG [VOLUME]

10. POWER SW P.C BOARD

Ref. No.	Part No.	Description
C101A	*EC-320548	C CE V F 103Z 250AC [U]
C101B	*EC-338496	C CE V FZ 472P 400AC [B.E.V]
SW101	*ES-361970	SW PUSH SDDL1 01-1 [POWER]

11. SOURCE DIRECT LED P.C BOARD

Ref. No.	Part No.	Description
D101	ED-361885	D LED SLP-384C-51 GREEN [SOURCE DIRECT]
D102	ED-361885	D LED SLP-384C-51 GREEN [SOURCE DIRECT]

12. POWER LED P.C BOARD

Ref. No.	Part No.	Description
D101	ED-361885	D LED SLP-384C-51 GREEN [POWER]
D102	ED-361885	D LED SLP-384C-51 GREEN [POWER]

13. PRE-AMP P.C BOARD

Ref. No.	Part No.	Description
IC1	EI-344764	IC M5218P-21
SW1	ES-372961	SW PUSH SPUL19 H12.5 2-02-02N [SUBSONIC]
SW2	ES-372961	SW PUSH SPUL19 H12.5 2-02-02N [MODE]
VR1	EV-355466	VR ROTARY RKDA20 100KCX2 [TREBLE]
VR2	EV-355457	VR ROTARY RKDA2S 100KCX2 [BASS]
VR3	EV-355456	VR ROTARY 16P10X1W 105 [BLANCE]

14. TAPE SELECTOR P.C BOARD

Ref. No.	Part No.	Description
IC1	EI-362588	IC M5238P
SW1	ES-368769	SW PUSH SPUL24 2 THROW N [TAPE MONITOR]
SW1A	ES-372962	SW PUSH SPUL12 H6.5 2-04-02N [TAPE MONITOR][AM-32]
SW2	ES-372963	SW PUSH SPUL19 H6.5 2-02-02N [MUTING]
SW3	ES-372963	SW PUSH SPUL19 H6.5 2-02-02N [LOUDNESS]

15. PHONE AMP P.C BOARD

Ref. No.	Part No.	Description
IC1	EI-344764	IC M5218P-21
J1	EJ-366336	PIN J T5857-ABBA P 4P [CD/PHONO]
J2	EJ-366336	PIN J T5857-ABBA P 4P [TUNER/AUX]
J3	EJ-366336	PIN J T5857-ABBA P 4P [DAT]
L1	EO-337684	COIL FIX 2 FL12R751E 751K [V]
SW1	ES-367641	SW PUSH SPUL19 H6.5 2-04-02S [CARTRIDGE]
TR1	ET-372959	TR FET 2SK389 V

16. SWITCH P.C BOARD

Ref. No.	Part No.	Description
R1	ER-367950	R OMF H S10 FS 1/2W 152J
R4	ER-358606	R OMF H S10 FS 1/2W 102J
SW1	ES-372965	SW PUSH ESB-68636 5 THROW N [FUNCTION]
SW2	ES-372966	SW PUSH ESB-68524 04-2 N [SOURCE DIRECT]

17. TERMINAL P.C BOARD (V ONLY)

Ref. No.	Part No.	Description
L1	EO-342936	COIL BALUM [V]
TM1	EJ-342935	TERMINAL W/SCREW YKD31-0132P8P [V]
T901C	*BT-372985	TRANS POW A2052-B [AM-52]
T901D	*BT-373349	TRANS POW A2053-U [AM-32]
T901E	*BT-373351	TRANS POW A2053-EV [AM-32]
T901F	*BT-372984	TRANS POW A2053-B [AM-32]
1	ZS-345624	ST PAN40X08STL CMT CUP [TRANS FIX]
2A	SP-373222A	PANEL REAR AM-52(U)
2B	SP-373222C	PANEL REAR AM-52(E.V)
2C	SP-373222J	PANEL REAR AM-52(B)
2D	SP-373222E	PANEL REAR AM-32(U)
2E	SP-373222G	PANEL REAR AM-32(E.V)
2F	SP-373222K	PANEL REAR AM-32(B)

Ref. No.	Part No.	Description
3	EJ-329610	TERMINAL W/SCREW UB-0067 L 1P
4	ZS-308846	T2BR30X08STL BZN PROJECTION
TM902	EJ-337406	TERMINAL W/SCREW ANB-024-AA8P [U.E.B][SPEAKER]
TM1	EJ-342935	TERMINAL W/SCREW YKD31-0132P8P [V][SPEAKER]
5A	ZS-351886	PT BR30X10STL BNI [U.E.B]
5B	ZS-332468	T2BR30X20STL N3 GUIDE [V]
J901	*EJ-364357	SOCKET OUTLET S2T-733T182 [U]
SW901	*ES-349070	SW SELECTOR YKS11-0002 02-4 [U]
6A	*EW-363659	AC CORD 200 0129AVFF B070 A U [U]
6B	*EW-363672	AC CORD 200 0364 LCFL B070 A EV [E.V]
6C	*EW-363684	AC CORD 200 LCFL B070 A B [B]
7	EJ-369015	PLUG SHORT-PIN CNT31-0057
8	ZS-351886	PT BR30X10STL BNI
9	ZS-308846	T2BR30X08STL BZN PROJECTION
10	ZS-490228	T2BD30X08STL CMT [FRONT PANEL FIX]
11	ZW-231030	RV NYL30X045 BL
12	MZ-553948	WIRE BAND F-100
TR901	*ET-345625	TR 2SC3116 S,T
TR902	*ET-368760	TR 2SC3855 P.Y [AM-52]
TR902A	*ET-368759	TR 2SC3854 P.Y [AM-32]
TR903	*ET-368758	TR 2SA1491 P.Y [AM-52]
TR903A	*ET-368757	TR 2SA1490 P.Y [AM-32]

ASSEMBLY BLOCK

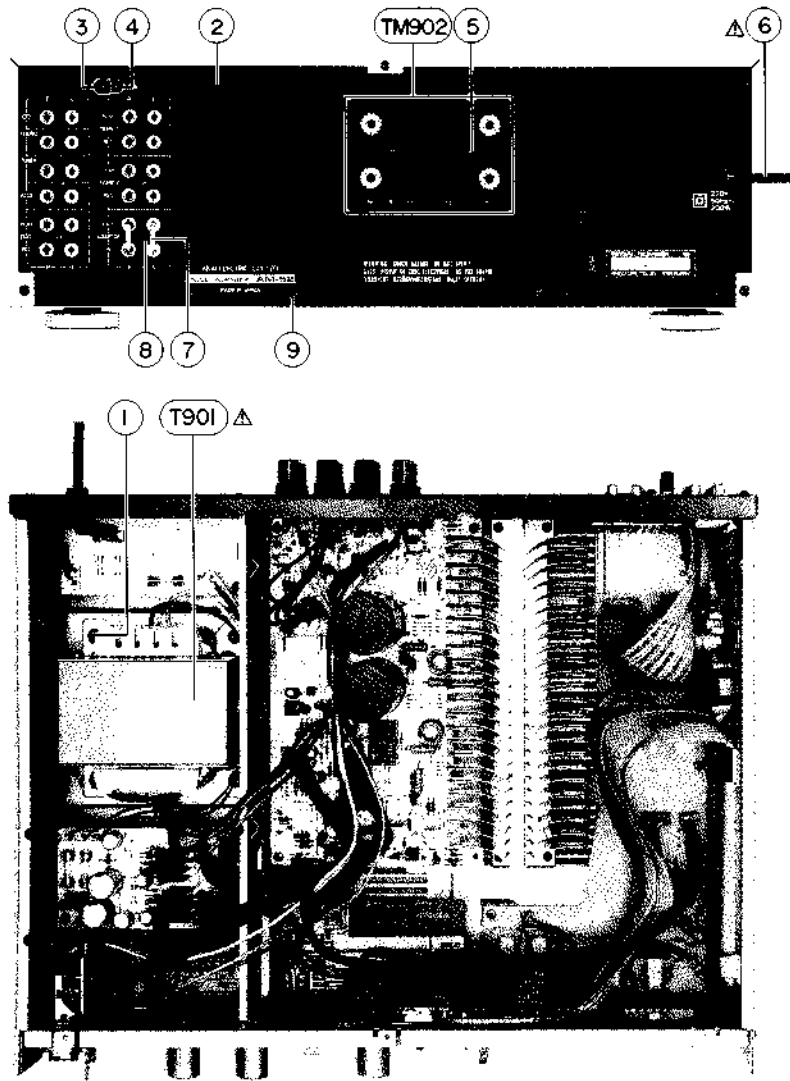

18. ASSEMBLY BLOCK

Ref. No.	Part No.	Description	Ref. No.	Part No.	Description
T901 A	*BT-372942	TRANS POW A2052-U [U]	TM902	EJ-337406	TERMINAL W/ SCREW ANB-024-AAA8P [B.E.U] [SPEAKER]
T901 B	*BT-372944	TRANS POW A2052-EV [E.V]	8	ZS-447840	T2BR30X08STL CMT
T901 C	*BT-372985	TRANS POW A2052-B [B]	5A	ZS-351886	PT BR30X10STL BNI [B.E.U]
1B	BD-A2052A040D	PANEL FRONT BLK AM-32-B [AM-32 BLACK]	5B	ZS-332468	T2BR30X20STL N13 GUNE [V]
2	SK-373236A	KNOB POWER-GOLD [GOLD]	J901	*EJ-364357	SOCKET OUTLET S2T-733 T162 [U]
2	SK-373236B	KNOB POWER-BLACK [BLACK]	VS901	*ES-349070	SW SELECTOR YKS11-010 2 02-4 [U] [VOLTAGE SELECTOR]
1	ZS-345624	ST PAN40X08STL CMT CUP [TRANS FIX]	6A	*EW-363659	AC CORD 200 0129AVFIB 070 A U [U]
2A	SP-373222A	PANEL REAR AM-52(U) [U]	6B	*EW-363672	AC CORD 200 0364 LCLFB 070 A EV [E.V]
2B	SP-373222C	PANEL REAR AM-52(E.V) [E.V]	6C	*EW-363684	AC CORD 200 LCLF B070 A B [B]
2C	SP-373222J	PANEL REAR AM-52(B) [B]	7	EJ-369015	PLUG SHORT-PIN CNT31 30 57
5	SK-373243A	KNOB VOLUME-GOLD [GOLD]	8	ZS-351886	PT BR30X10STL BNI
5	SK-373243B	KNOB VOLUME-BLACK [BLACK]	9	ZS-308846	T2BR30X08STL BZN PROJECTION
6	SP-373246A	COVER UPPER-GOLD [GOLD]	10	ZS-490228	T2BD30X08STL CMT [FRONT PANEL FIX]
3	EJ-329610	TERMINAL W/ SCREW UB-0067 L 1P	11	ZW-231030	RV NYL30X045 BL
4	ZS-308846	T2BR30X08STL BZN PROJECTION	12	MZ-553948	WIRE BAND F-100
			TR901	*ET-345625	TR 2SC3116 S,T
			TR902	*ET-368760	TR 2SC3855 P,Y
			TR903	*ET-368758	TR 2SA1491 P,Y

PARTS LIST

FINAL ASSEMBLY BLOCK

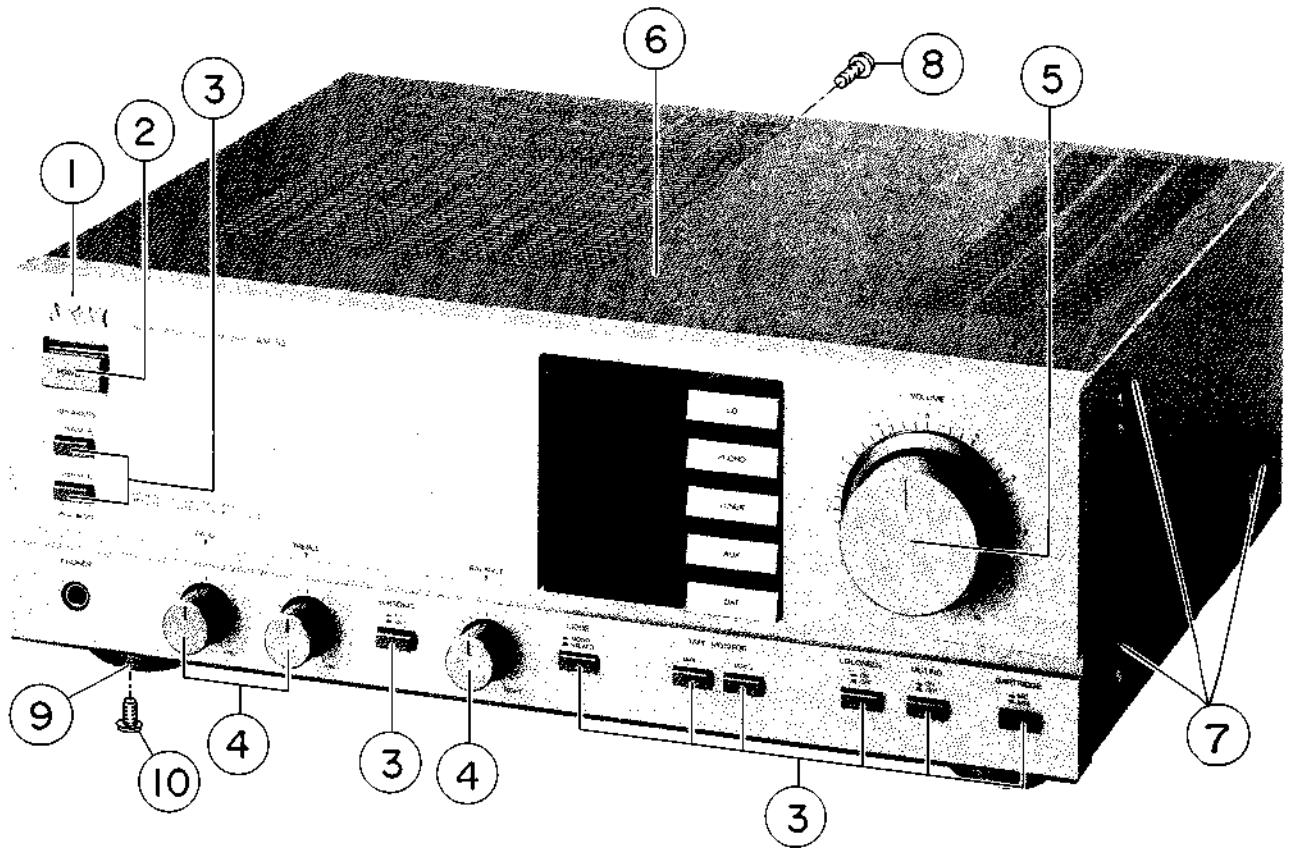

19. FINAL ASSEMBLY BLOCK

Ref. No.	Part No.	Description
1-G	BD-A2052A040A	PANEL FRONT BLK AM-52-G [GOLD]
1-B	BD-A2052A040B	PANEL FRONT BLK AM-52-B [BLACK]
2-G	SK-373236A	KNOB POWER-GOLD [GOLD]
2-B	SK-373236B	KNOB POWER-BLACK [BLACK]
3-G	SK-373242A	KNOB MODE-GOLD [GOLD]
3-B	SK-373242B	KNOB MODE-BLACK [BLACK]
4-G	SK-373244A	KNOB BALANCE-GOLD [GOLD]
4-B	SK-373244B	KNOB BALANCE-BLACK [BLACK]
5-G	SK-373243A	KNOB VOLUME-GOLD [GOLD]
5-B	SK-373243B	KNOB VOLUME-BLACK [BLACK]
6-G	SP-373246A	COVER UPPER-GOLD [GOLD]
6-B	SP-373246B	COVER UPPER-BLACK [BLACK]
7-G	ZS-341959	ST BID40X06STL N13 [GOLD]
7-B	ZS-341960	ST BID40X06STL BNI [BLACK]
8	ZS-447840	T2BR30X08STL CMT
9	SA-B369350A2	FOOT PART
10	ZS-447805	T2BR30X12STL CMT

SYMBOL FOR COLOR VARIATION
 B: BLACK
 G: GOLD

INDEX

MODEL AM-32

Part No.	Ref. No.	Part No.	Ref. No.	Part No.	Ref. No.	Part No.	Ref. No.
BA-A2052A020E	1A	EF-601942	F4A	ES-372966	28	ZS-351886	8
BA-A2052A020G	1B	EF-623125	16	ES-372966	SW2	ZS-351886	5A
BA-A2052A020H	1C	EF-623125	F1B	ET-305463	39	ZS-351886	8
BA-A2052A030C	2A	EI-344764	21	ET-305463	TR104	ZS-447805	10
BA-A2052A030D	2B	EI-344764	IC1	ET-305463	TR105	ZS-447840	8
BD-A2052A040C	1B	EI-344764	IC1	ET-305463	TR112	ZS-447840	8
BD-A2052A040C	1-G	EI-345474	19	ET-305463	TR113	ZS-490228	10
BD-A2052A040D	1-B	EI-345474	IC102	ET-305463	TR116	ZS-490228	10
BT-372984	1	EI-349719	20	ET-307195	40	ZW-231030	11
BT-372984	T901F	EI-349719	IC101	ET-307195	TR111	ZW-231030	11
BT-372984	T901C	EI-362588	22	ET-338179	41		
BT-373349	3	EI-362588	IC1	ET-338179	TR101		
BT-373349	T901D	EJ-329610	3	ET-345625	43		
BT-373349	T901A	EJ-329610	3	ET-345625	TR109		
BT-373351	2	EJ-337406	23	ET-345625	TR101		
BT-373351	T901E	EJ-337406	TM902	ET-345625	TR901		
BT-373351	T901B	EJ-337406	TM902	ET-345625	TR901		
EC-200948	C109	EJ-342935	24	ET-345626	37		
EC-200948	C110	EJ-342935	TM1	ET-345626	TR110		
EC-201637	C110	EJ-342935	TM1	ET-345626	TR102		
EC-201637	C111	EJ-348846	J101	ET-366581	45		
EC-201639	C101	EJ-364357	J901	ET-366581	TR103		
EC-201639	C102	EJ-364357	J901	ET-368757	38		
EC-320548	C101A	EJ-366336	J1	ET-368757	TR903A		
EC-326583	C122	EJ-366336	J2	ET-368757	TR903		
EC-326583	C109	EJ-366336	J3	ET-368759	44		
EC-333972	C108	EJ-369015	7	ET-368759	TR902A		
EC-338496	C101B	EJ-369015	7	ET-368759	TR902		
EC-366358	C120	EJ-373358	J101	ET-370038	42		
EC-366358	C121	EJ-373358	J103	ET-370038	TR103		
ED-301911	10	EO-332116	L101	ET-370038	TR106		
ED-301911	D102	EO-337684	L1	ET-372959	TR1		
ED-301911	D103	EO-338409	L101	EV-330369	VR101		
ED-301911	D104	EO-342936	L1	EV-355456	49		
ED-301911	D105	EQ-337159	25	EV-355456	VR3		
ED-301911	D106	EQ-337159	RL101	EV-355457	47		
ED-301911	D107	ER-318400	R157	EV-355457	VR2		
ED-301911	D110	ER-318400	R159	EV-355466	48		
ED-301911	D101	ER-322591	R126	EV-355466	VR1		
ED-301911	D104	ER-324185	R115	EV-373359	46		
ED-301911	D105	ER-324185	R120	EV-373359	VR101		
ED-330320	7	ER-324186	R116	EW-363659	6A		
ED-330320	D107	ER-324480	R110	EW-363659	6A		
ED-346579	13	ER-324480	R111	EW-363672	6B		
ED-346579	D106	ER-333023	R143	EW-363672	6B		
ED-348990	9	ER-333023	R144	EW-363684	6C		
ED-348990	D108	ER-333372	R127	EW-363684	6C		
ED-348990	D109	ER-333372	R128	MZ-553948	12		
ED-350748	8	ER-333372	R112	MZ-553948	12		
ED-350748	D111	ER-333372	R113	SA-8369350A2	9		
ED-356424	4	ER-333372	R114	SK-373236A	2-G		
ED-356424	D112	ER-358606	R4	SK-373236B	2-B		
ED-361885	6	ER-359522	26	SK-373242A	3-G		
ED-361885	D101	ER-359522	R129	SK-373242B	3		
ED-361885	D102	ER-367950	R1	SK-373242B	3-B		
ED-361885	D103	ER-372988	R105	SK-373243A	5-G		
ED-361885	D104	ER-373356	27	SK-373243B	5-B		
ED-361885	D105	ER-373356	TR102	SK-373244A	4		
ED-361885	D101	ER-373378	R154	SK-373244A	4-G		
ED-361885	D102	ER-375110	R107	SK-373244B	4		
ED-361885	D101	ER-375110	R108	SK-373244B	4-B		
ED-361885	D102	ER-557583	R101	SP-373222E	2D		
ED-367949	11	ES-345476	35	SP-373222E	2A		
ED-367949	D102	ES-345476	SW101	SP-373222G	2E		
ED-367949	D103	ES-349070	36	SP-373222G	2B		
ED-368089	12	ES-349070	SW901	SP-373222K	2F		
ED-368089	D113	ES-349070	VS901	SP-373222K	2C		
ED-368089	D114	ES-361970	30	SP-373246A	6-G		
ED-373354	5	ES-361970	SW101	SP-373246B	6-B		
ED-373354	D106	ES-367641	34	ZS-308846	4		
EF-326639	18	ES-367641	SW1	ZS-308846	9		
EF-326639	F1A	ES-372961	32	ZS-308846	4		
EF-326639	F2	ES-372961	SW1	ZS-308846	9		
EF-358974	15	ES-372962	31	ZS-332468	5B		
EF-358974	F3B	ES-372962	SW1	ZS-332468	5B		
EF-358974	F4B	ES-372963	33	ZS-341959	7-G		
EF-364518	14	ES-372963	SW2	ZS-341960	7-B		
EF-364518	F1C	ES-372963	SW3	ZS-345624	1		
EF-601942	17	ES-372965	29	ZS-345624	1		
EF-601942	F3A	ES-372965	SW1	ZS-351886	5A		

MODEL AM-52

Part No.	Ref. No.	Part No.	Ref. No.	Part No.	Ref. No.	Part No.	Ref. No.
BA-A2052A020A	1A	ED-375761	D104	ER-373378	R154	SK-373236A	2-G
BA-A2052A020C	1B	ED-375761	D105	ER-375108	R116	SK-373236B	2
BA-A2052A020D	1C	EF-258344	19	ER-375110	R107A	SK-373236B	2-B
BA-A2052A020E	1D	EF-258344	F3A	ER-375110	R108A	SK-373242A	3-G
BA-A2052A020G	1E	EF-258344	F4A	ER-557583	R101	SK-373242B	3-B
BA-A2052A020H	1F	EF-306951	F1D	ES-345476	35	SK-373243A	5
BA-A2052A030A	2A	EF-306951	F2B	ES-345476	SW101	SK-373243A	5-G
BA-A2052A030B	2B	EF-306952	20	ES-349070	37	SK-373243B	5
BA-A2052A030C	2C	EF-306952	F1A	ES-349070	SW901	SK-373243B	5-B
BA-A2052A030D	2D	EF-306952	F2	ES-349070	VS901	SK-373244A	4-G
BD-A2052A040A	1-G	EF-358641	17	ES-361970	31	SK-373244B	4-B
BD-A2052A040B	1-B	EF-358641	F3B	ES-361970	SW101	SP-373222A	2A
BD-A2052A040D	1B	EF-358641	F4B	ES-367641	34	SP-373222A	2A
BT-372942	3	EF-358974	F3D	ES-367641	SW1	SP-373222C	2B
BT-372942	T901A	EF-358974	F4D	ES-368769	36	SP-373222C	2B
BT-372944	2	EF-359225	16	ES-368769	SW1	SP-373222E	2D
BT-372944	T901B	EF-359225	F1C	ES-372961	32	SP-373222G	2E
BT-372984	T901F	EF-364518	F1F	ES-372961	SW1	SP-373222J	2C
BT-372985	1	EF-601942	F3C	ES-372961	SW2	SP-373222J	2C
BT-372985	T901C	EF-601942	F4C	ES-372962	SW1A	SP-373222K	2F
BT-372985	T901C	EF-623125	F1E	ES-372963	33	SP-373246A	6
BT-373349	T901D	EF-891007	18	ES-372963	SW2	SP-373246A	6-G
BT-373351	T901E	EF-891007	F1B	ES-372963	SW3	SP-373246B	6-B
EC-200948	C109	EI-344764	23	ES-372965	30	ZS-308846	4
EC-200948	C110	EI-344764	IC1	ES-372965	SW1	ZS-308846	9
EC-201637	C110	EI-344764	IC1	ES-372966	29	ZS-308846	4
EC-201637	C111	EI-345474	21	ES-372966	SW2	ZS-308846	9
EC-201639	C101	EI-345474	IC102	ET-305463	41	ZS-332468	5B
EC-201639	C102	EI-349719	22	ET-305463	TR104	ZS-332468	5B
EC-320548	C101A	EI-349719	IC101	ET-305463	TR105	ZS-341959	7-G
EC-326583	C122	EJ-362588	24	ET-305463	TR112	ZS-341960	7-B
EC-326583	C109	EJ-362588	IC1	ET-305463	TR113	ZS-345624	1
EC-333972	C108	EJ-329610	3	ET-305463	TR116	ZS-345624	1
EC-338496	C101B	EJ-329610	3	ET-307195	42	ZS-351886	5A
EC-366358	C120A	EJ-337406	TM902	ET-307195	TR111	ZS-351886	8
EC-366358	C121A	EJ-337406	TM902	ET-338179	43	ZS-351886	5A
EC-373373	C120	EJ-342935	26	ET-338179	TR101	ZS-351886	8
EC-373373	C121	EJ-342935	TM1	ET-345625	45	ZS-447805	10
ED-301911	11	EJ-342935	TM1	ET-345625	TR109	ZS-447840	8
ED-301911	D102	EJ-348846	J101	ET-345625	TR101	ZS-447840	8
ED-301911	D103	EJ-364357	25	ET-345625	TR901	ZS-490228	10
ED-301911	D104	EJ-364357	J901	ET-345625	TR901	ZS-490228	10
ED-301911	D105	EJ-364357	J901	ET-345626	39	ZW-231030	11
ED-301911	D106	EJ-366336	J1	ET-345626	TR110	ZW-231030	11
ED-301911	D107	EJ-366336	J2	ET-345626	TR102		
ED-301911	D110	EJ-366336	J3	ET-368581	47		
ED-301911	D101	EJ-369015	7	ET-368581	TR103		
ED-301911	D104	EJ-369015	7	ET-368757	TR903A		
ED-301911	D105	EJ-373358	J101	ET-368758	40		
ED-330320	8	EJ-373358	J102	ET-368758	TR903		
ED-330320	D107	EJ-373358	J103	ET-368758	TR903		
ED-346550	12	EO-332116	L101	ET-368759	TR902A		
ED-346550	D101	EO-337684	L1	ET-368760	46		
ED-346579	15	EO-338409	L101	ET-368760	TR902		
ED-346579	D106	EO-342936	L1	ET-368760	TR902		
ED-348990	10	EQ-337159	27	ET-370038	44		
ED-348990	D108	EQ-337159	RL101	ET-370038	TR103		
ED-348990	D109	ER-318400	R107	ET-370038	TR106		
ED-350748	9	ER-318400	R108	ET-372959	38		
ED-350748	D111	ER-318400	R157	ET-372959	TR102		
ED-356424	4	ER-318400	R159	ET-372959	TR1		
ED-356424	D112	ER-322591	R126	EV-330369	VR101		
ED-361885	7	ER-324185	R115	EV-355456	51		
ED-361885	D101	ER-324185	R120	EV-355456	VR3		
ED-361885	D102	ER-324186	R116A	EV-355457	49		
ED-361885	D101	ER-324480	R110	EV-355457	VR2		
ED-361885	D102	ER-324480	R111	EV-355466	50		
ED-367949	13	ER-333023	R143	EV-355466	VR1		
ED-367949	D102	ER-333023	R144	EV-373359	48		
ED-367949	D103	ER-333372	R127	EV-373359	VR101		
ED-368089	14	ER-333372	R128	EW-363659	6A		
ED-368089	D113	ER-333372	R112	EW-363659	6A		
ED-368089	D114	ER-333372	R113	EW-363672	6B		
ED-373354	5	ER-333372	R114	EW-363672	6B		
ED-373354	D106	ER-358606	R4	EW-363684	6C		
ED-373354	D107	ER-359522	28	EW-363684	6C		
ED-375761	6	ER-359522	R129	MZ-553948	12		
ED-375761	D101	ER-367950	R1	MZ-553948	12		
ED-375761	D102	ER-372988	R105	SA-8369350A2	9		
ED-375761	D103	ER-373356	TR102A	SK-373236A	2		

AKAI

MODEL **AM-32**

MODEL **AM-52**

SCHEMATIC DIAGRAM AND PC BOARDS

TABLE OF CONTENTS

1. AM-32 FUSE PCB, POWER SUPPLY PCB, POWER SW PCB	2
2. AM-32 LED PCB, PHONO PCB, SOURCE DIRECT LED PCB, SWITCH PCB.....	3
3. AM-32 PIN JACK PCB, TAPE SELECTOR PCB, VOLUME PCB	4
4. AM-32 PHONE PCB, PRE AMP PCB	5
5. AM-32 MAIN AMP PCB	6
6. AM-32 SCHEMATIC DIAGRAM.....	7
7. AM-52 SCHEMATIC DIAGRAM.....	8
8. AM-52 MAIN AMP PCB	9
9. AM-52 PHONE PCB, PRE AMP PCB	10
10. AM-52 PIN JACK PCB, TAPE SELECTOR PCB, VOLUME PCB	11
11. AM-52 LED PCB, PHONO PCB, SOURCE DIRECT LED PCB, SWITCH PCB.....	12
12. AM-52 FUSE PCB, POWER SUPPLY PCB, POWER SW PCB	13
13. AM-32/52 BLOCK DIAGRAM.....	14

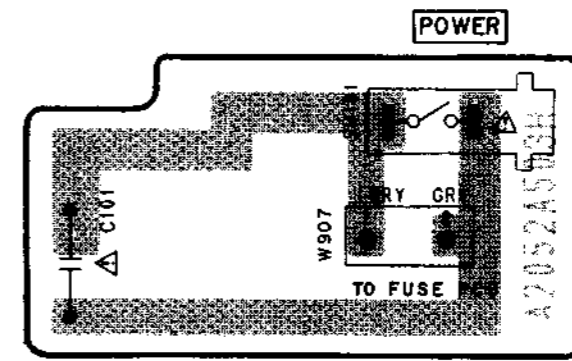
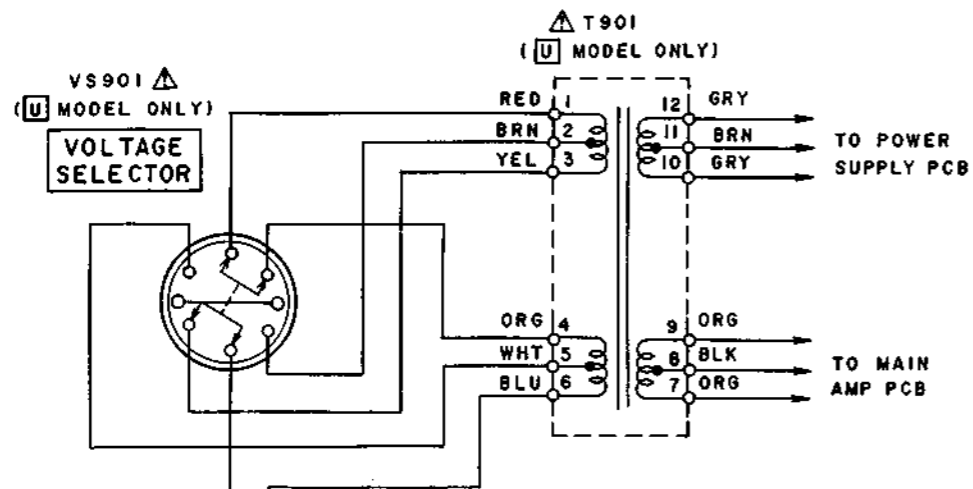

POWER SW PCB A2052A503H

WARNING: Δ INDICATES SAFETY CRITICAL COMPONENTS FOR CONTINUED SAFETY. REPLACE SAFETY CRITICAL COMPONENTS ONLY WITH MANUFACTURER'S RECOMMENDED PARTS

AVERTISSEMENT: Δ IL INDIQUE LES COMPOSANTS CRITIQUES DE SÉCURITÉ POUR MAINTENIR LE DEGRÉ DE SÉCURITÉ DE L'APPAREIL. NE REMPLACER QUE DES PIÈCES RECOMMANDÉES PAR LE FABRICANT

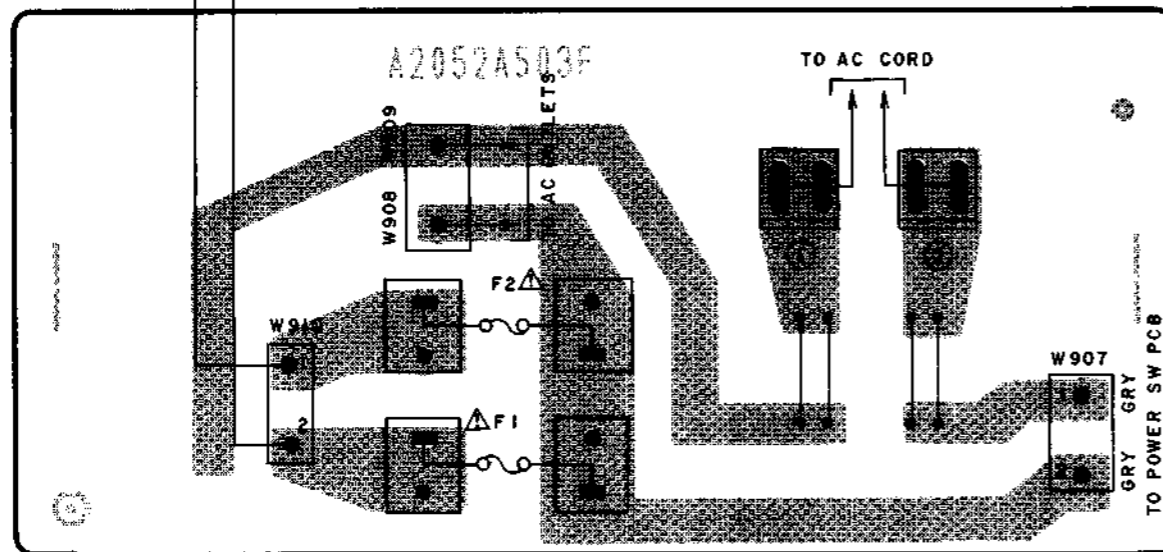

FUSE PCB (U MODEL ONLY) A2052A503F

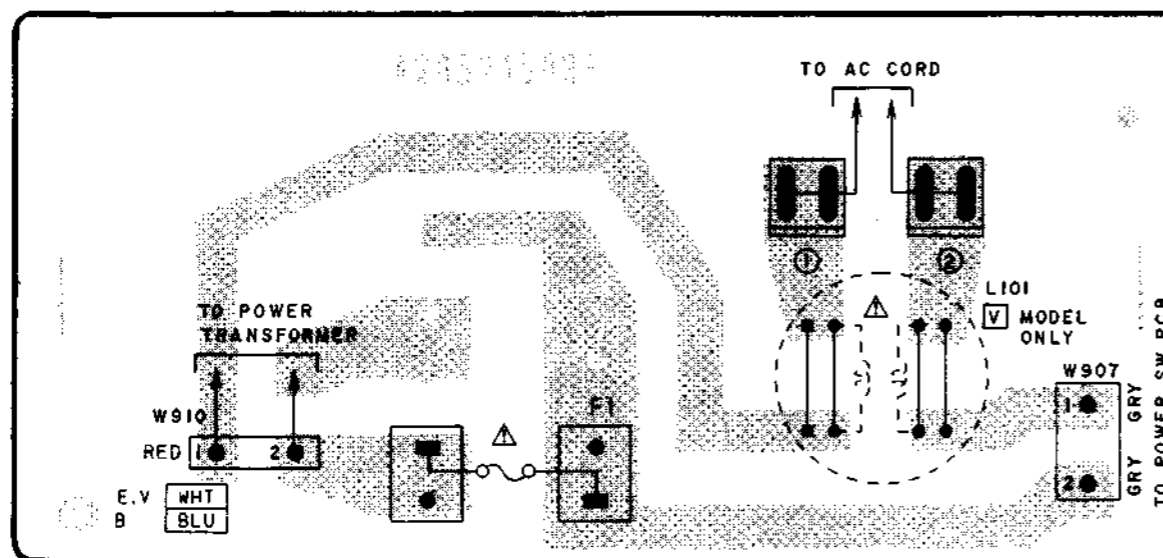

FUSE PCB (B, E, V MODEL ONLY) A2052A503F

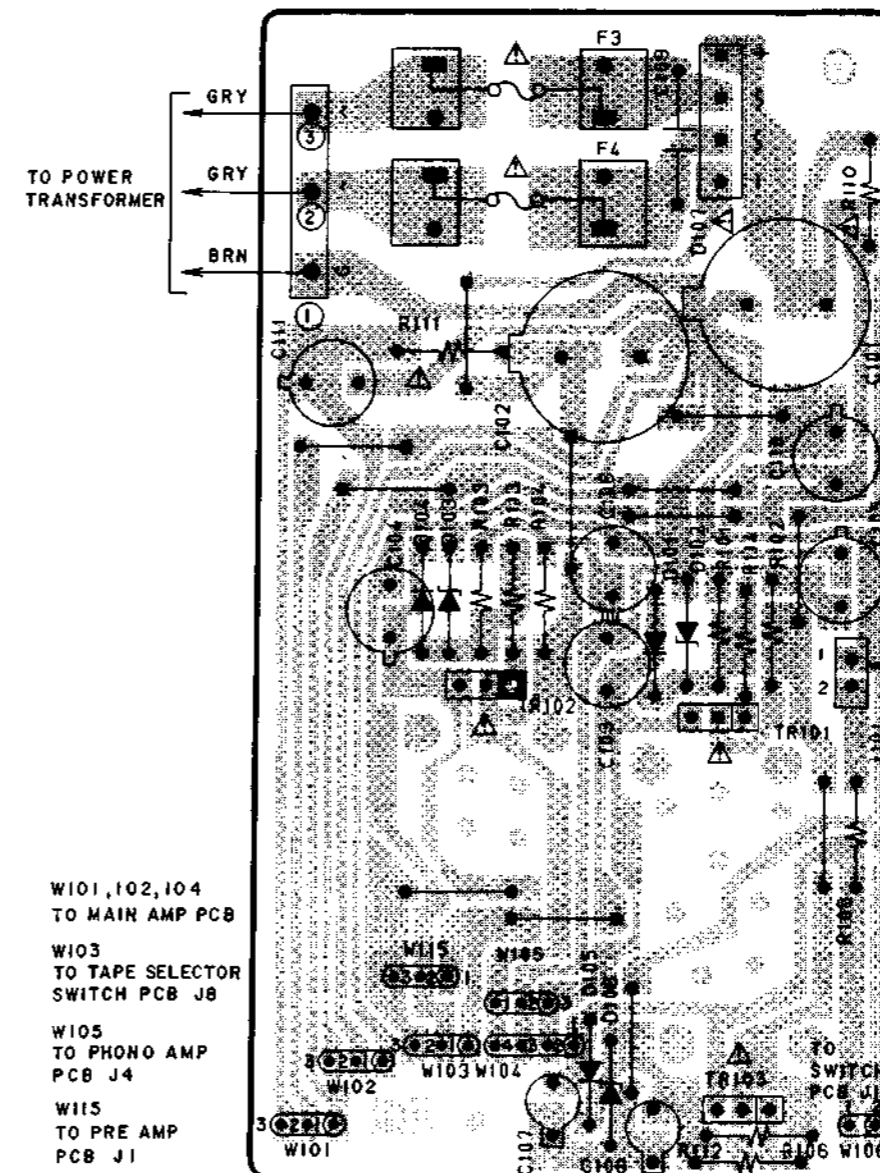

POWER SUPPLY PCB A2052A503B

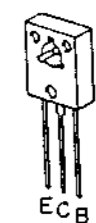

ECB
2SC3116
2SA1248

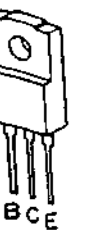

BCE
2SD1762

B
● ● ● = NPN TRANSISTOR
B
● ● ● = PNP TRANSISTOR

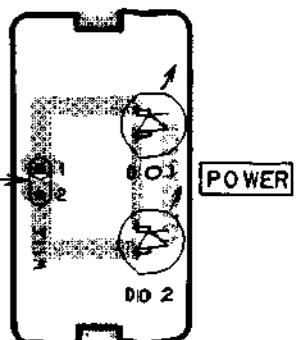

POWER LED PCB
A2052A503K

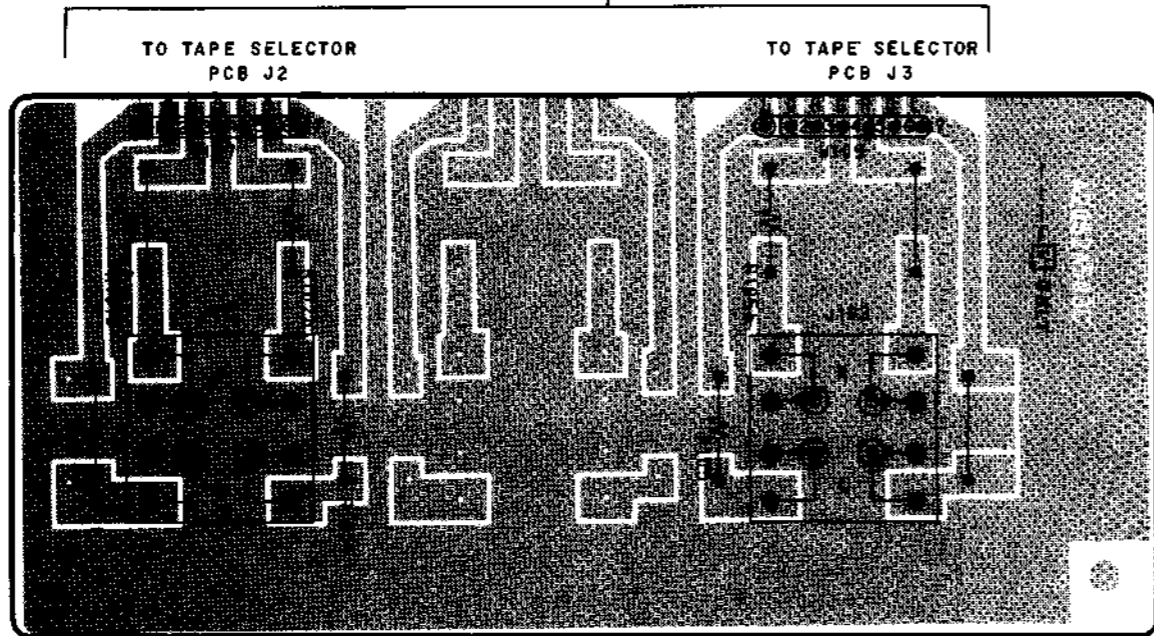

VOLUME PCB A2052A503G

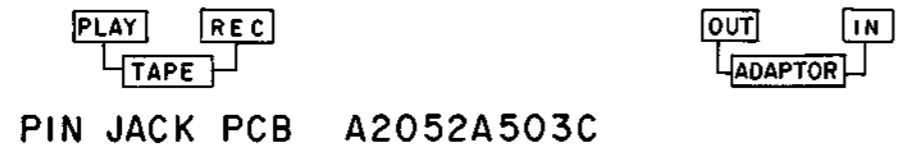
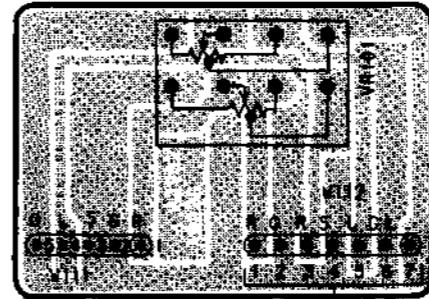

PIN JACK PCB A2052A503C

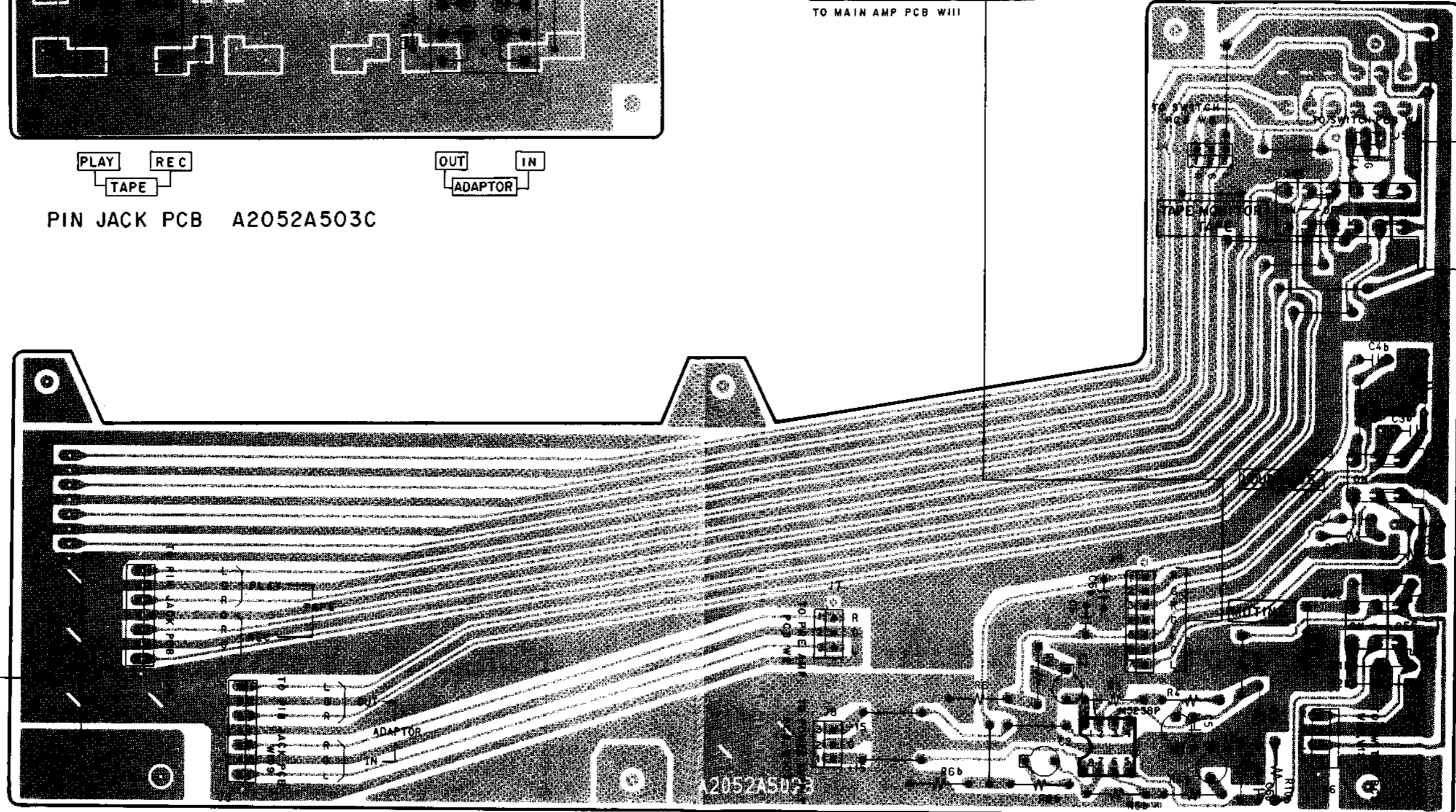

TAPE SELECTOR PCB A2052A502B

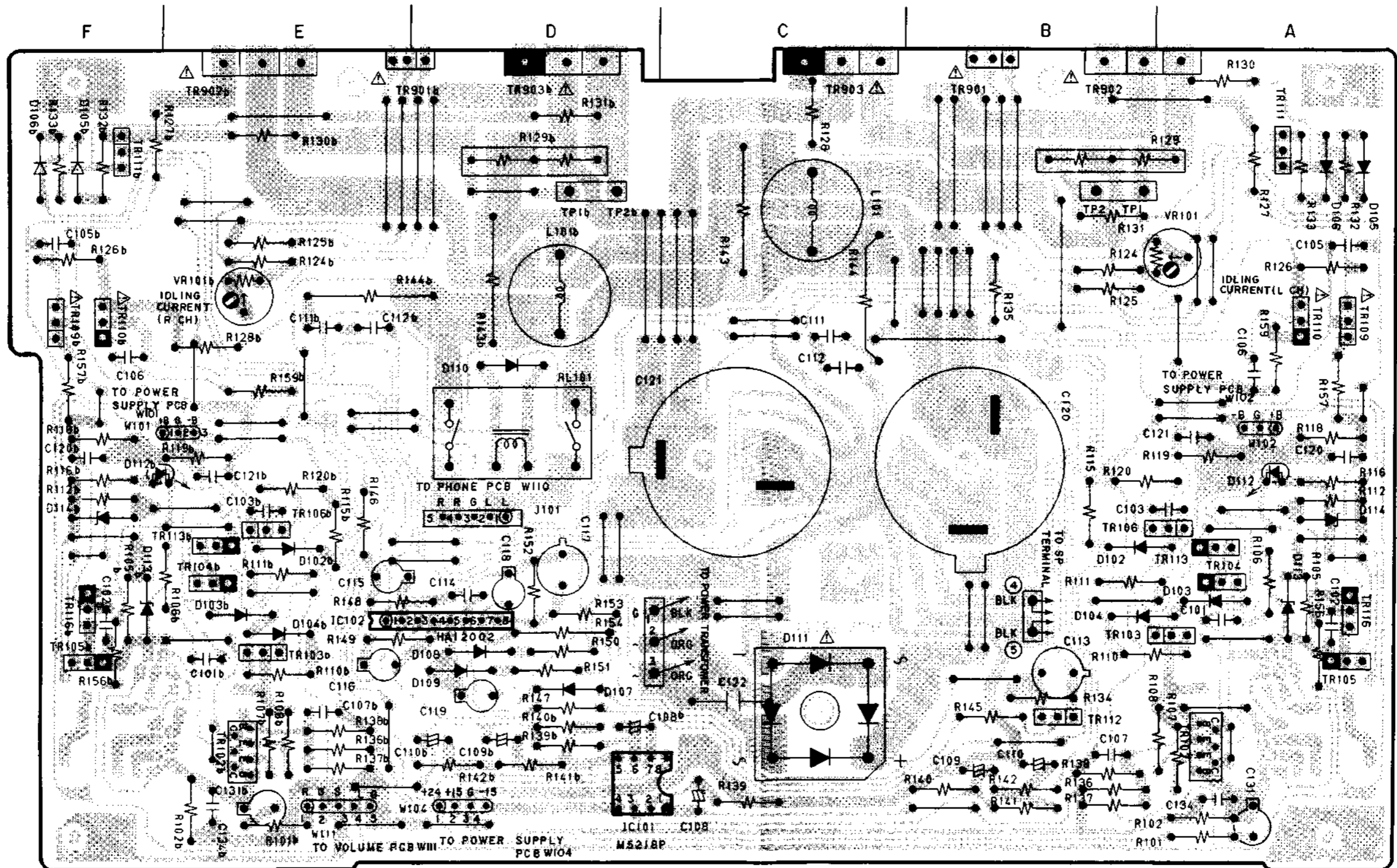

- IC
 IC101 . . . D3
 IC102 . . . D3
- TRANSISTOR
 TR102 . . . A3
 TR102b . . . E3
 TR103 . . . A3
 TR103b . . . E3
 TR104 . . . A3
 TR104b . . . E3
 TR105 . . . A3
 TR105b . . . F3
 TR106 . . . A2
 TR106b . . . E2
 TR109 . . . A2
 TR109b . . . F2
 TR110 . . . A2
 TR110b . . . F2
 TR111 . . . A1
 TR111b . . . F1
 TR112 . . . B3
 TR113 . . . A2
 TR113b . . . E3
 TR116 . . . A3
 TR116b . . . F3
 TR901 . . . B1
 TR901b . . . D1
 TR902 . . . B1
 TR902b . . . E1
 TR903 . . . C1
 TR903b . . . D1
- CONNECTOR
 J101 . . . D2
 W101 . . . E2
 W102 . . . A2
 W104 . . . D3
 W111 . . . E3

MAIN AMP PCB A2052A503A

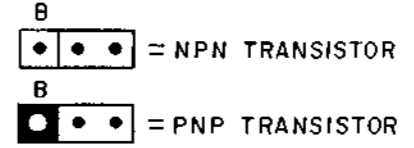
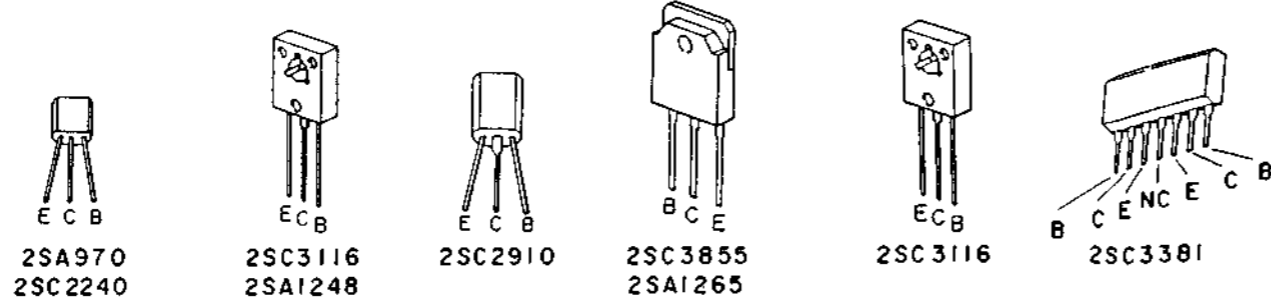

WARNING: Δ INDICATES SAFETY CRITICAL COMPONENTS FOR CONTINUED SAFETY. REPLACE SAFETY CRITICAL COMPONENTS ONLY WITH MANUFACTURER'S RECOMMENDED PARTS

AVERTISSEMENT: Δ IL INDIQUE LES COMPOSANTS CRITIQUES DE SÉCURITÉ. POUR MAINTENIR LE DEGRÉ DE SÉCURITÉ DE L'APPAREIL, NE REMPLACER QUE DES PIÈCES RECOMMANDÉES PAR LE FABRICANT

PRE AMP PCB A2052A502A

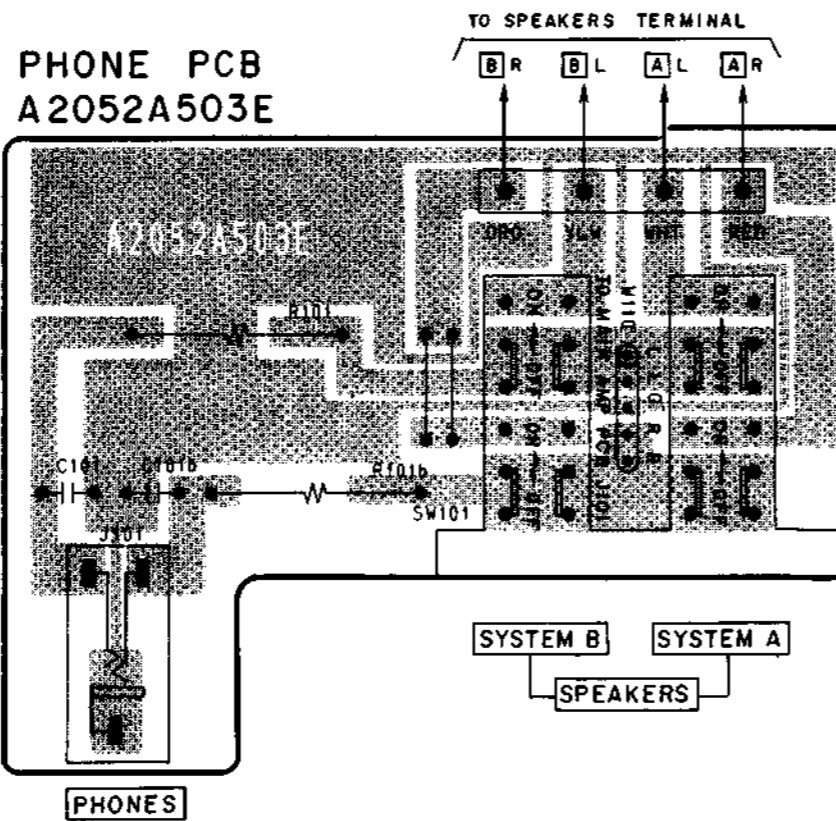
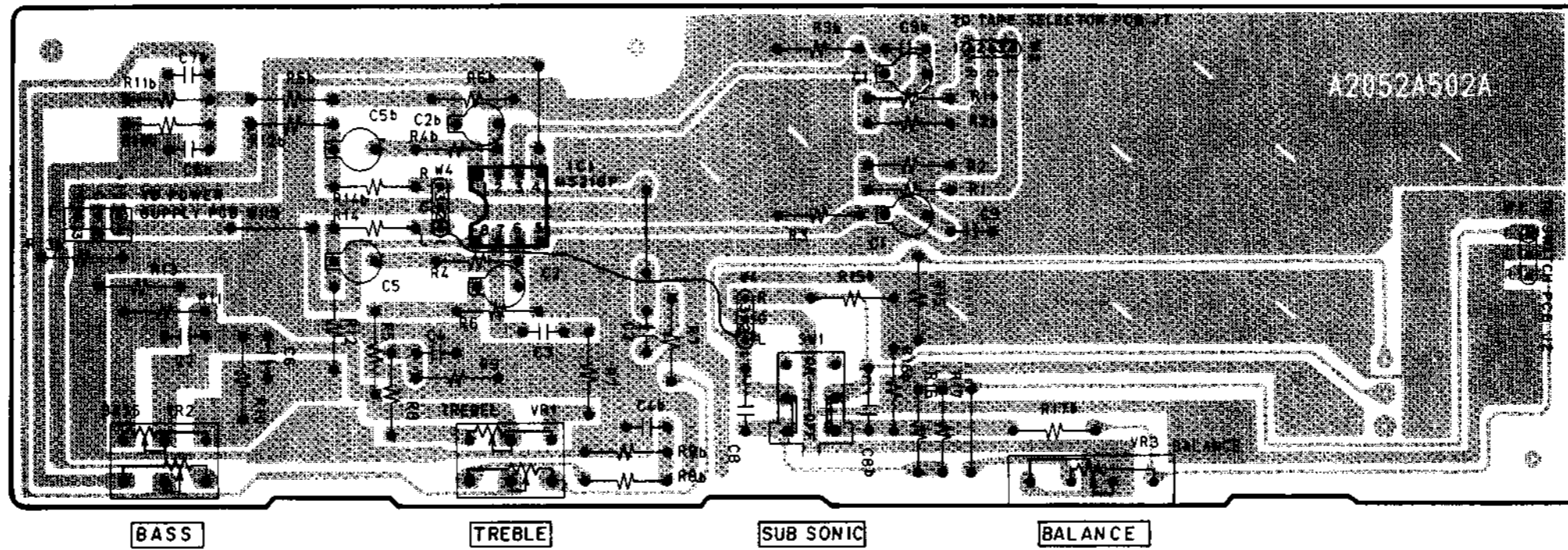

PRE AMP PCB A2052A502A

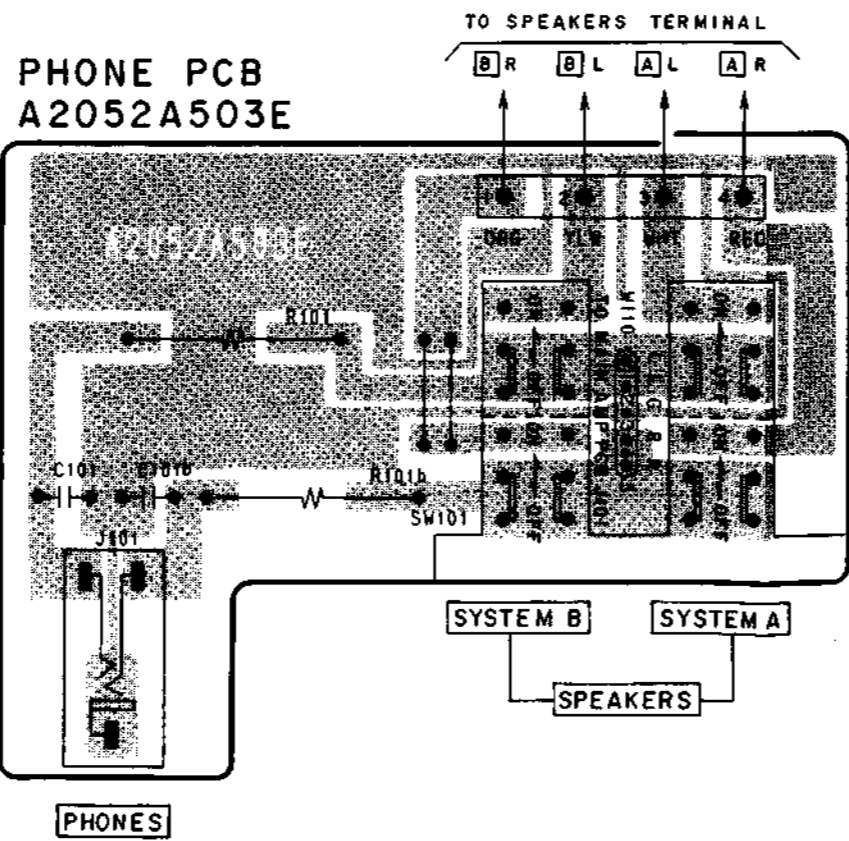
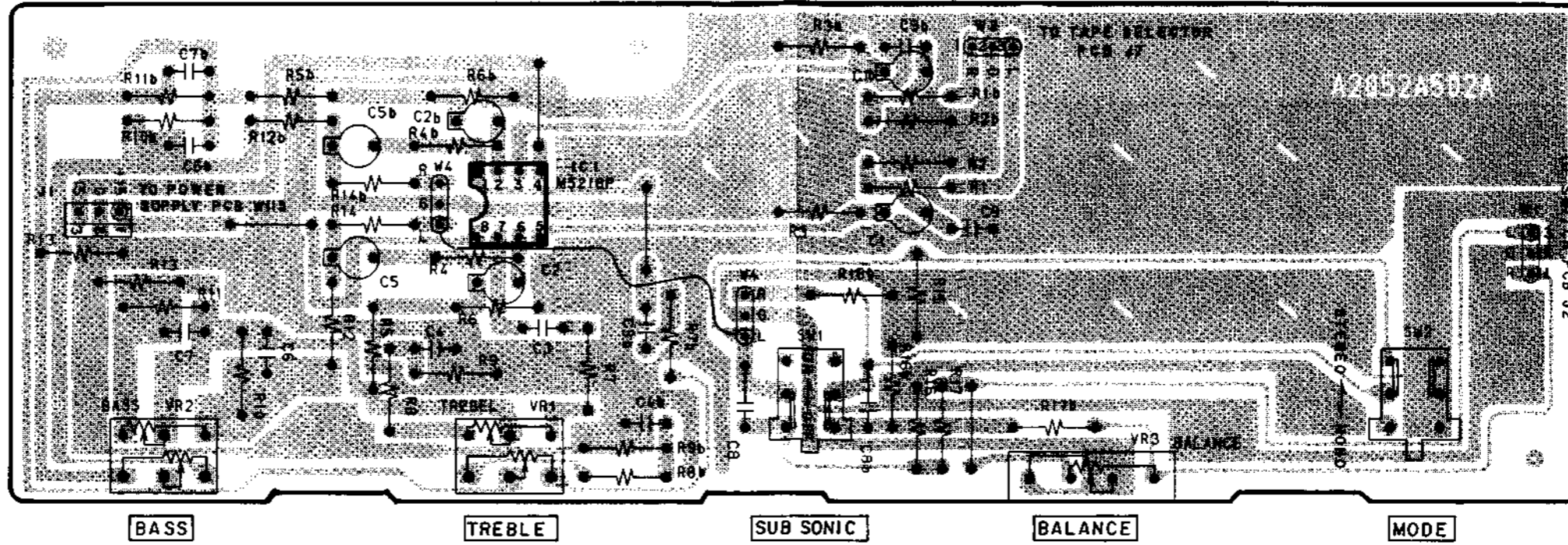

WARNING: Δ INDICATES SAFETY CRITICAL COMPONENTS FOR CONTINUED SAFETY.
REPLACE SAFETY CRITICAL COMPONENTS ONLY WITH MANUFACTURER'S
RECOMMENDED PARTS

AVERTISSEMENT: Δ IL INDIQUE LES COMPOSANTS CRITIQUES DE SÉCURITÉ.
POUR MAINTENIR LE DEGRÉ DE SÉCURITÉ DE L'APPAREIL.
NE REMPLACER QUE DES PIÈCES RECOMMANDÉES PAR LE FABRICANT

IC
IC101 . . . D3
IC102 . . . D3

TRANSISTOR
TR101 . . . A3
TR101b . . . F3
TR102 . . . A3
TR102b . . . F3
TR103 . . . A3
TR103b . . . E3
TR104 . . . A3
TR104b . . . E3
TR105 . . . A3
TR105b . . . F3
TR106 . . . A2
TR106b . . . E2
TR109 . . . A2
TR109b . . . F2
TR110 . . . A2
TR110b . . . F2
TR111 . . . A1
TR111b . . . F1
TR112 . . . B3
TR113 . . . A2
TR113b . . . E3
TR116 . . . A3
TR116b . . . F3
TR901 . . . B1
TR901b . . . D1
TR902 . . . B1
TR902b . . . E1
TR903 . . . C1
TR903b . . . D1

CONNECTOR
J101 . . . D2
W101 . . . E2
W102 . . . A2
W104 . . . D3
W111 . . . E3

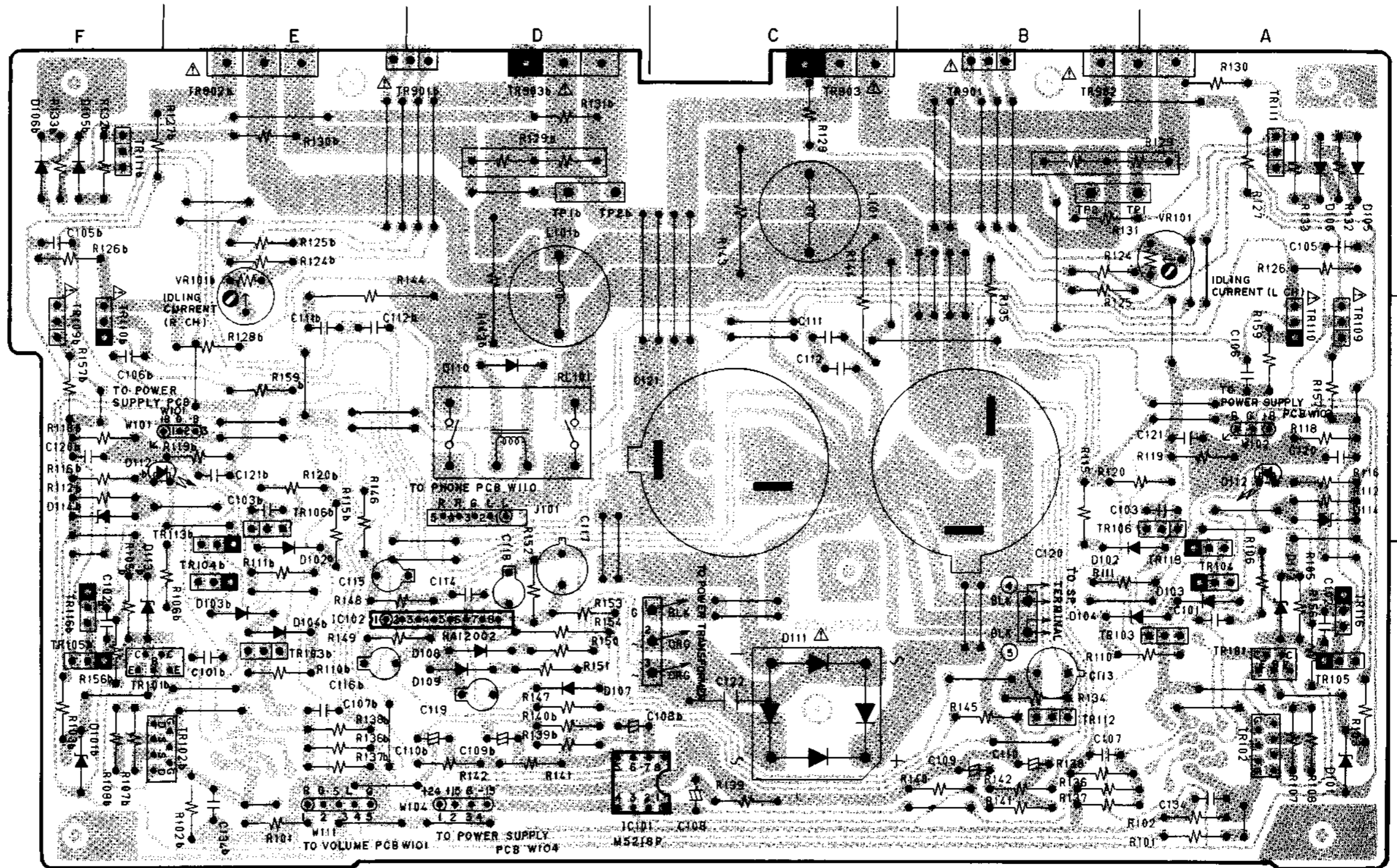

MAIN AMP PCB A2052A503A

$\begin{matrix} B \\ \bullet \bullet \bullet \end{matrix}$ = NPN TRANSISTOR
 $\begin{matrix} B \\ \bullet \bullet \bullet \end{matrix}$ = PNP TRANSISTOR



2SA970
2SC2240



2SC3116
2SA1248

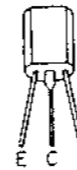

2SC2910



2SC3855
2SA1265



2SC2291

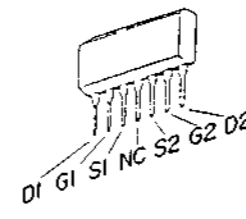

2SK389



2SC3116

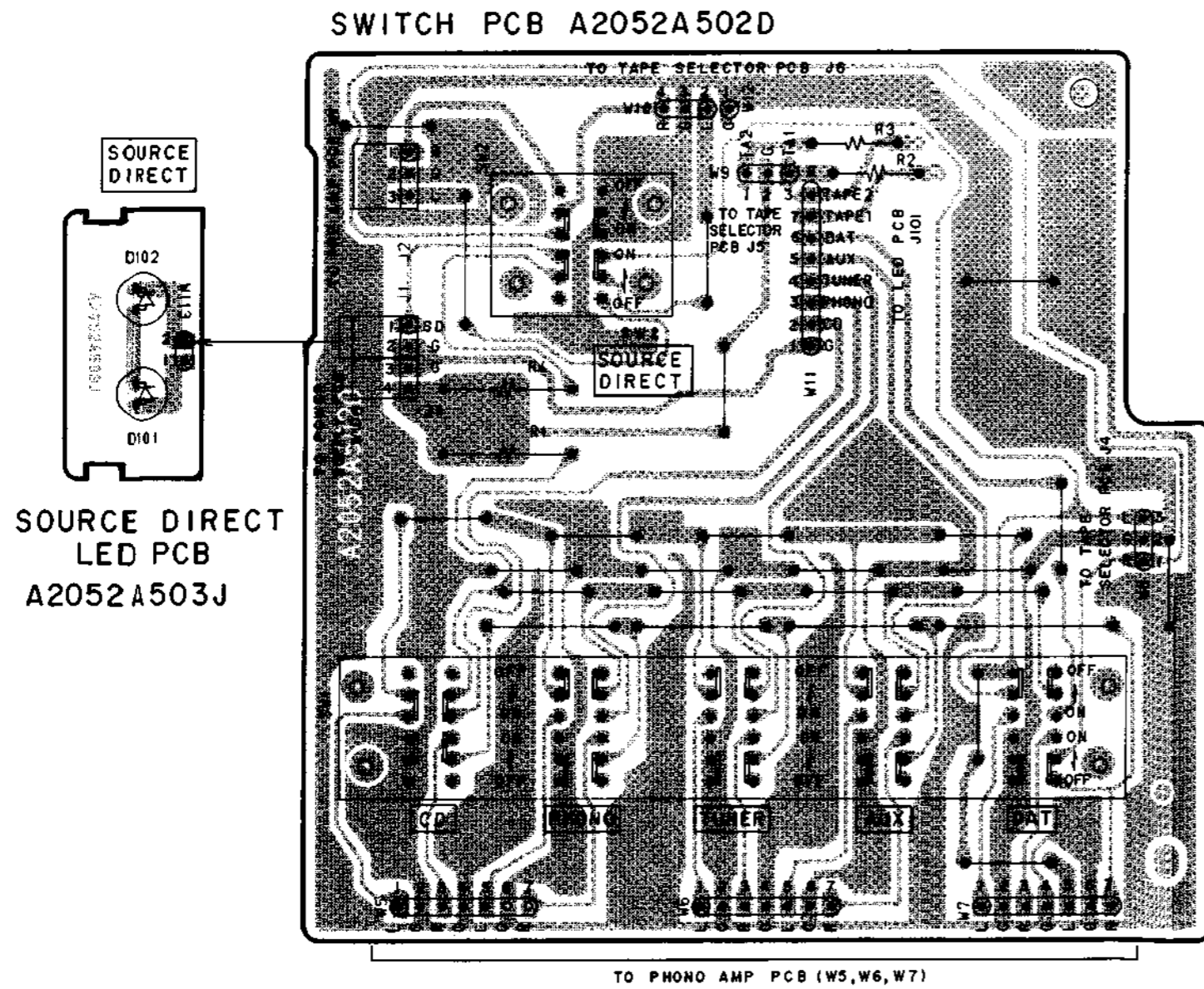
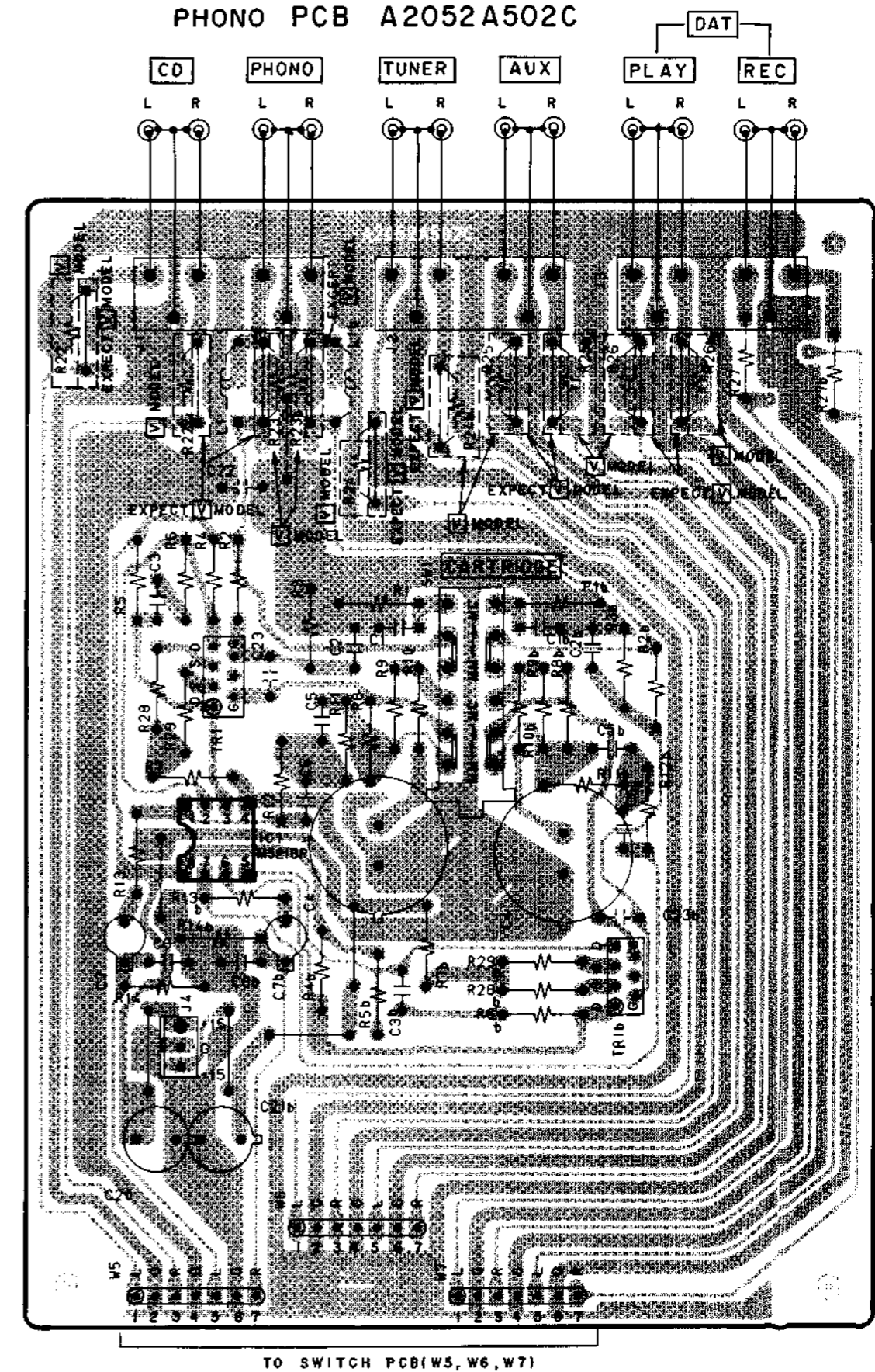
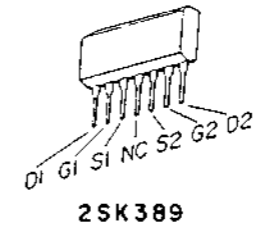
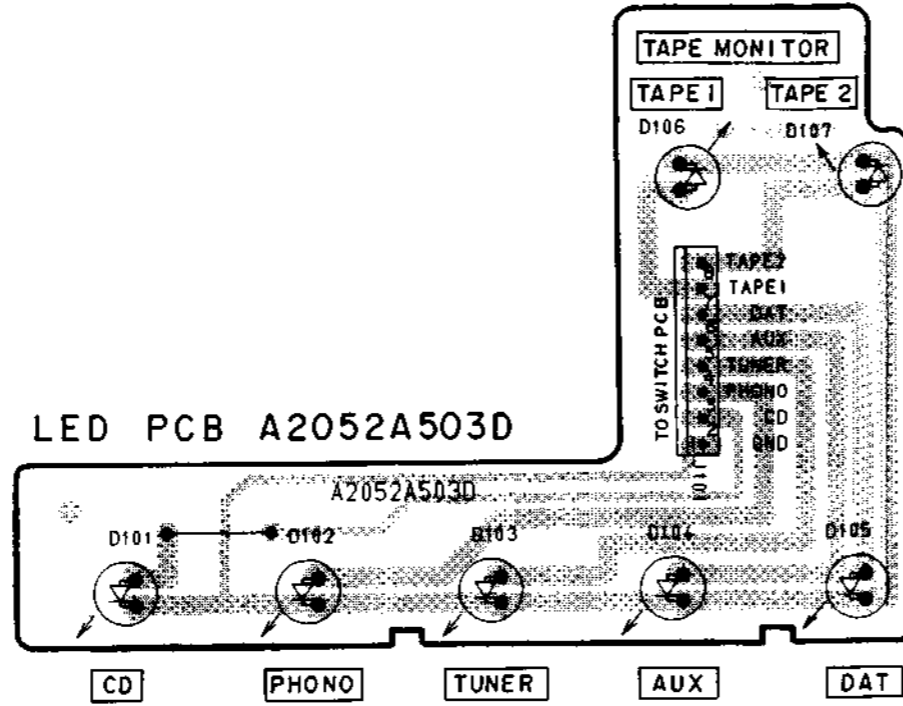

SOURCE DIRECT
LED PCB
A2052A503J

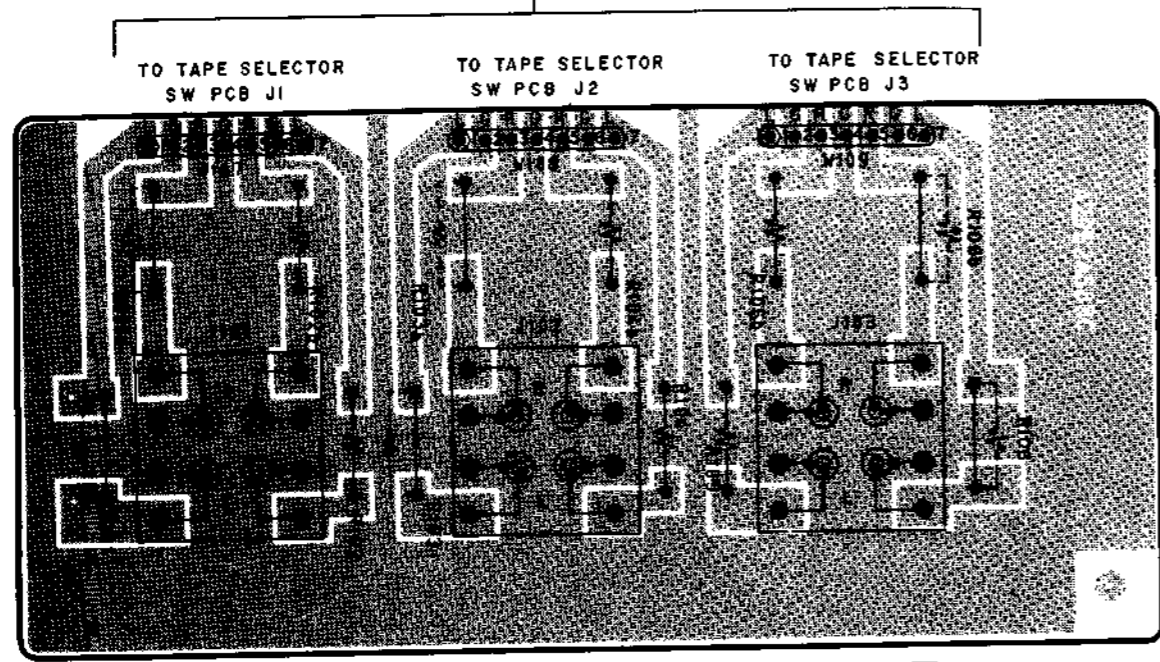

PIN JACK PCB A2052A503C

--AA-- = [V] MODEL ONLY

VOLUME PCB A2052A503G

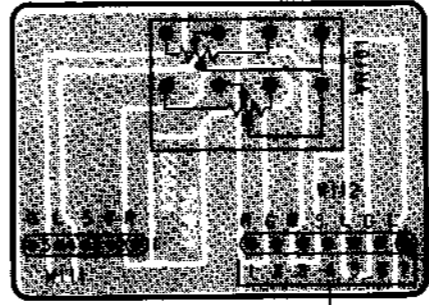

VR101
VOLUME

TO MAIN AMP PCB W111

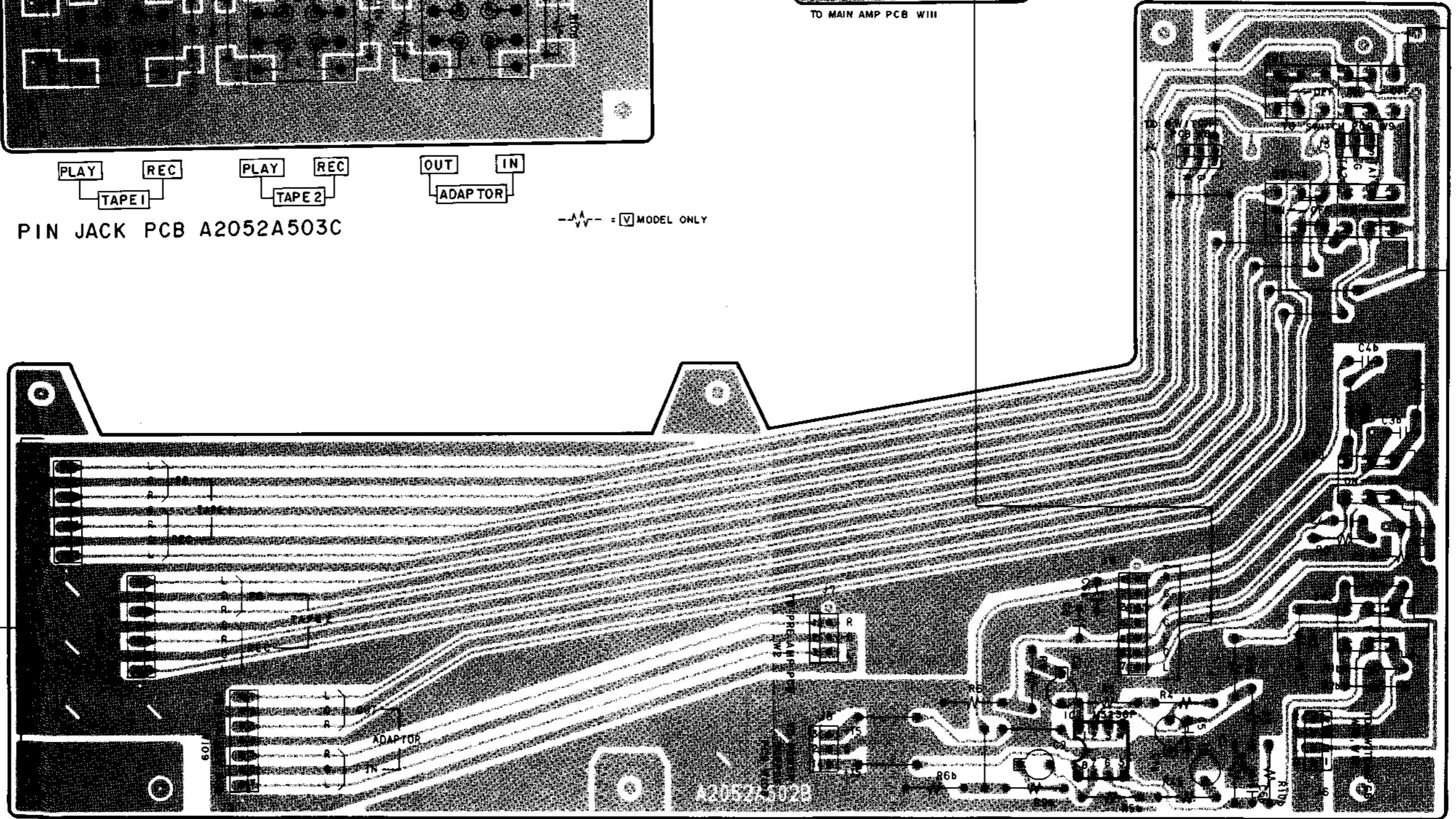

TAPE SELECTOR SW PCB A2052A502B

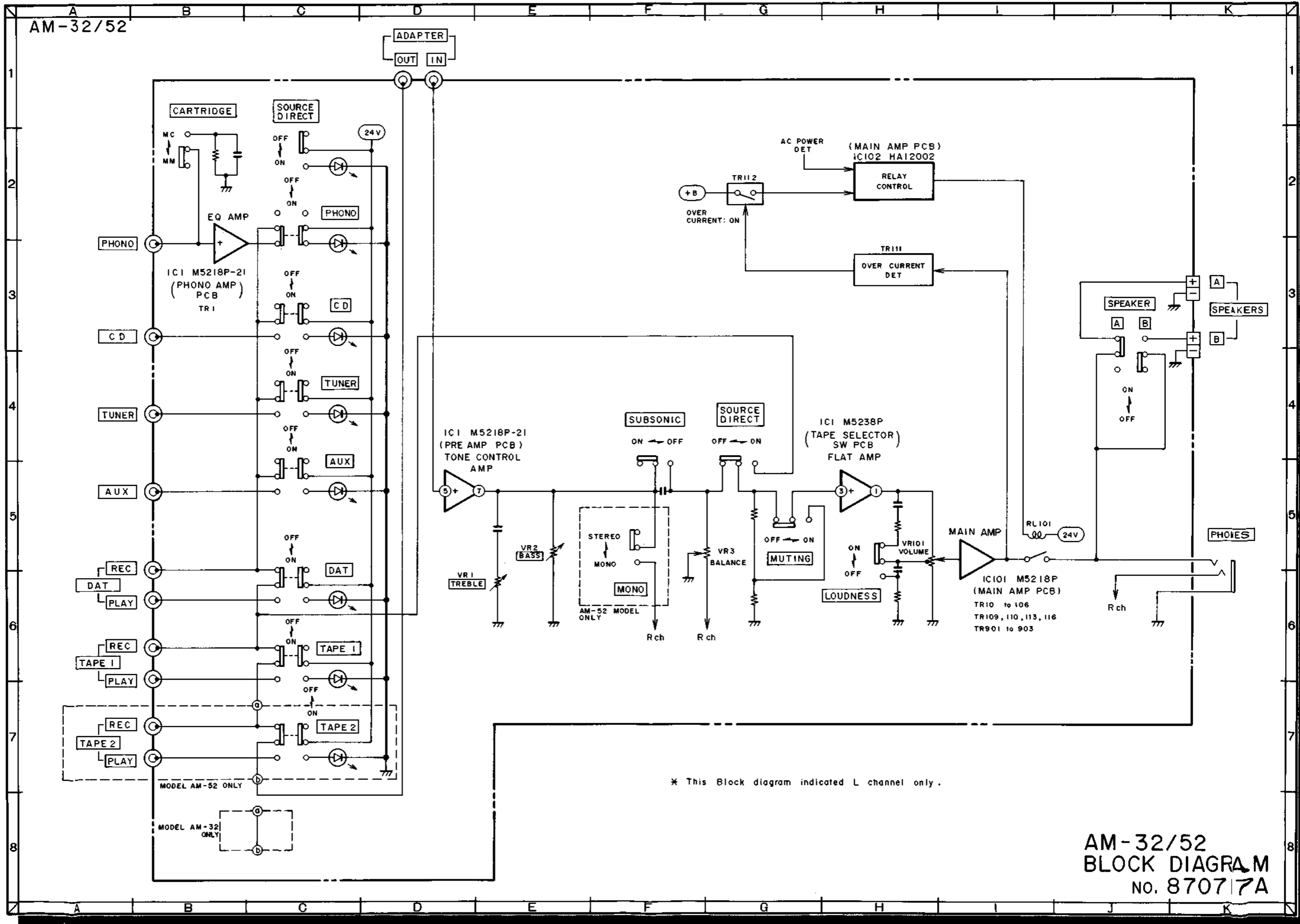

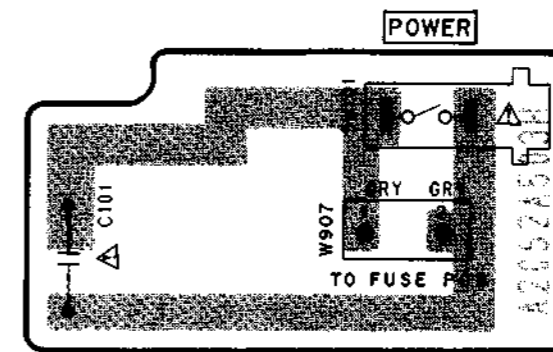
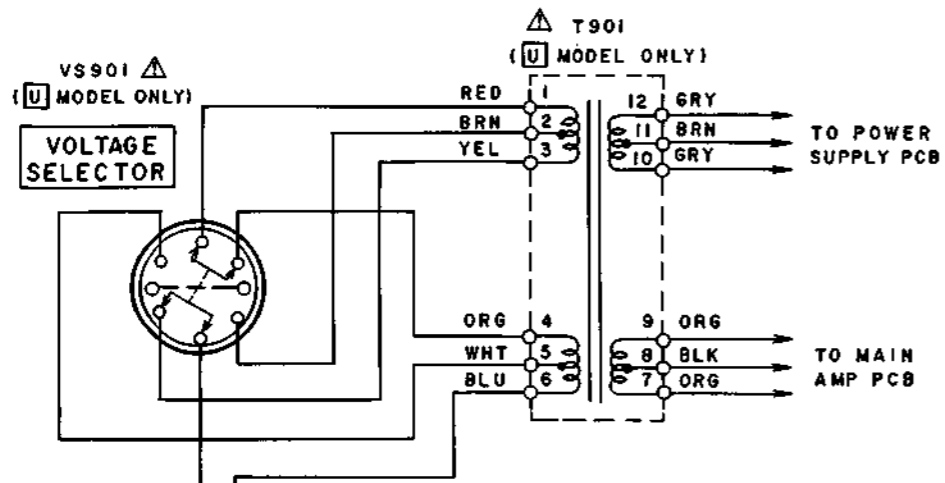

POWER SW PCB A2052A503H

WARNING: Δ INDICATES SAFETY CRITICAL COMPONENTS FOR CONTINUED SAFETY. REPLACE SAFETY CRITICAL COMPONENTS ONLY WITH MANUFACTURER'S RECOMMENDED PARTS.
 AVERTISSEMENT: Δ IL INDIQUE LES COMPOSANTS CRITIQUES DE SÉCURITÉ. POUR MAINTENIR LE DEGRÉ DE SÉCURITÉ DE L'APPAREIL, NE REMPLACER QUE DES PIÈCES RECOMMANDÉES PAR LE FABRICANT.

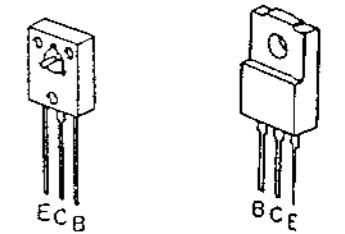

2SC3116
2SA1248
2SD1762

TR101---2SC3116
TR102---2SA1248
TR103---2SD1762

B
● ● ● = NPN TRANSISTOR
● ● ● = PNP TRANSISTOR

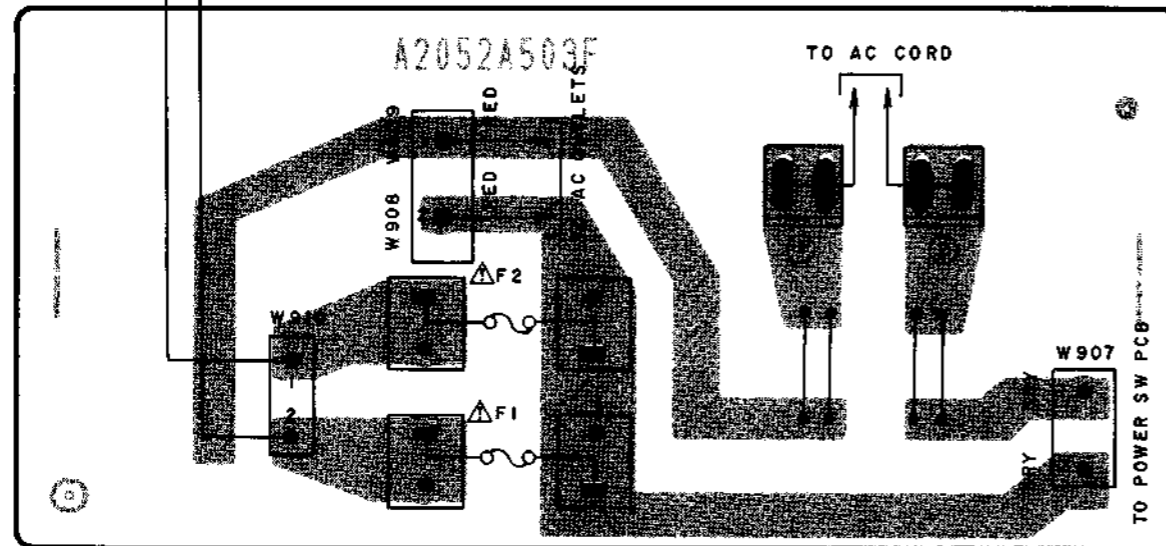

FUSE PCB (U MODEL ONLY) A2052A503F

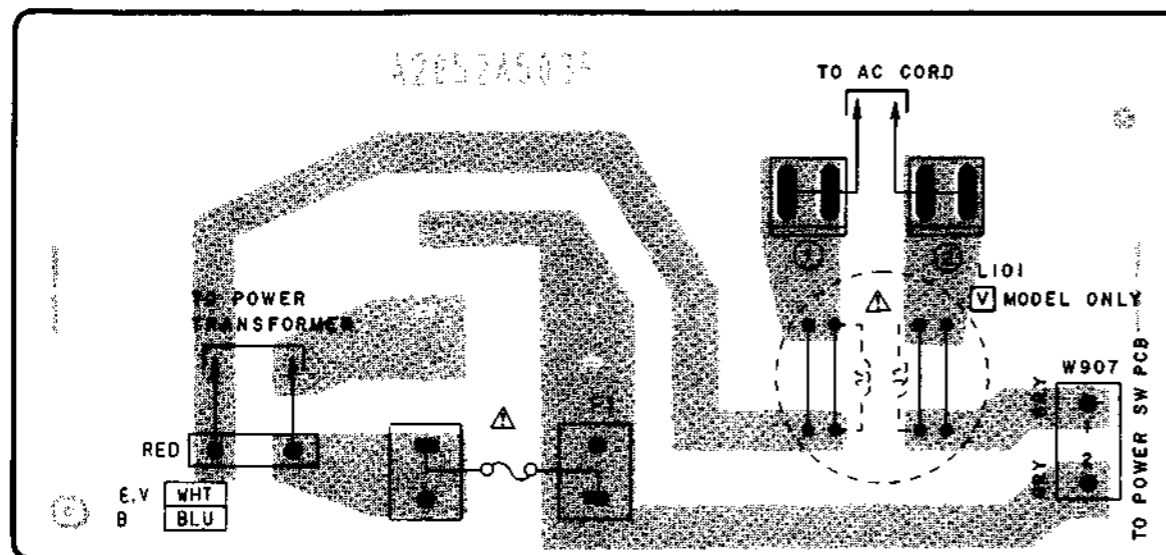

FUSE PCB (BEV MODEL ONLY)

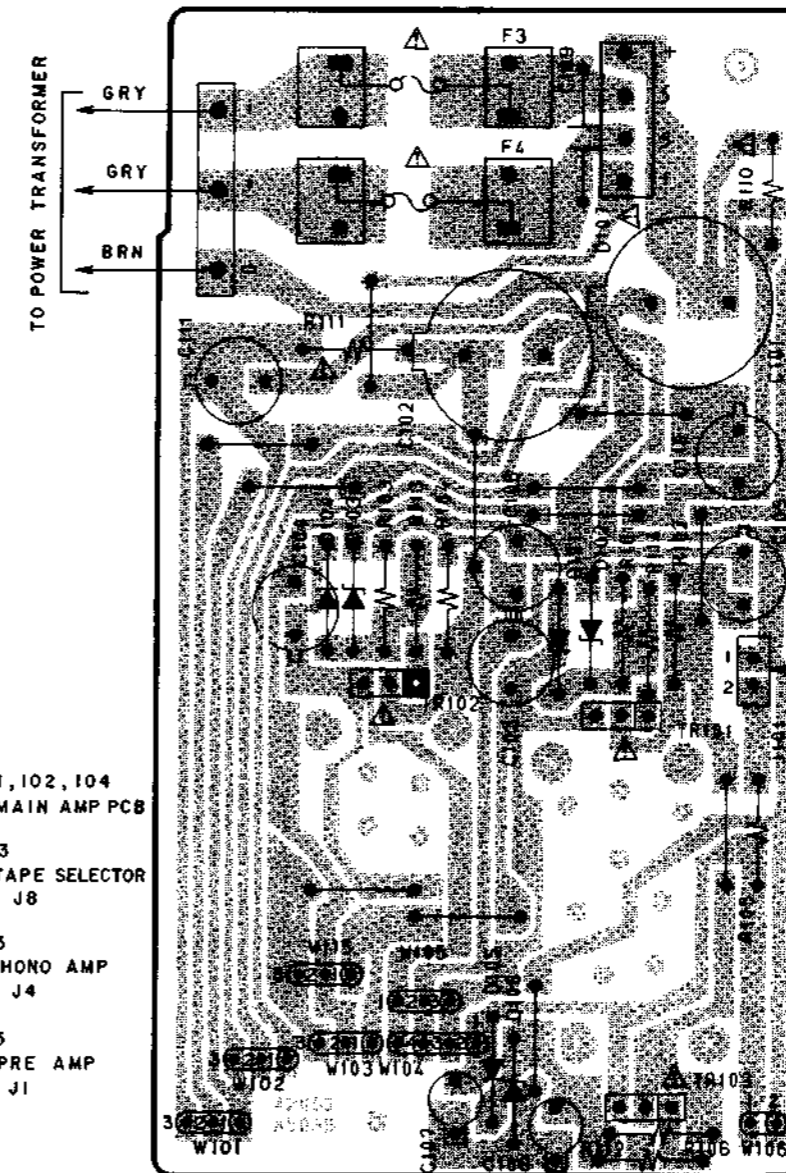

POWER SUPPLY PCB A2052A503B

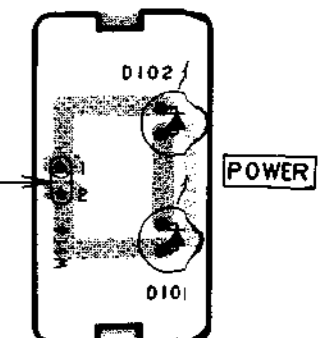

POWER LED PCB A2052A503K

- W101, 102, 104 TO MAIN AMP PCB
- W103 TO TAPE SELECTOR PCB J8
- W105 TO PHONO AMP PCB J4
- W115 TO PRE AMP PCB J1

TO SWITCH PCB J1

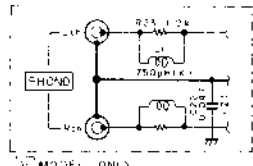

PHONO PCB A2052A502C

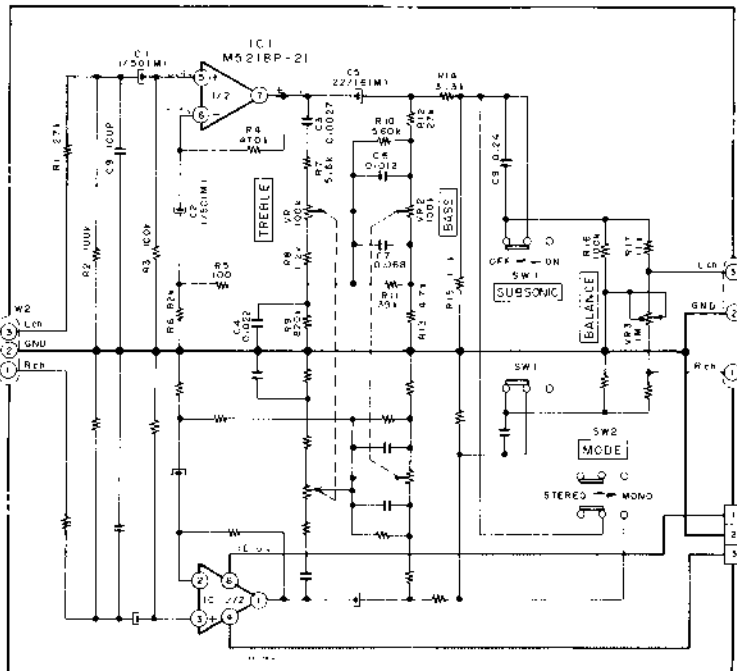

PRE AMP PCB A2052A502A

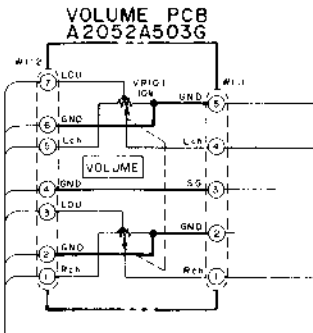

VOLUME PCB A2052A503G

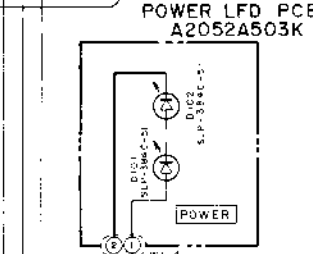

POWER LFD PCB A2052A503K

SOURCE DIRECT LED PCB A2052A503J

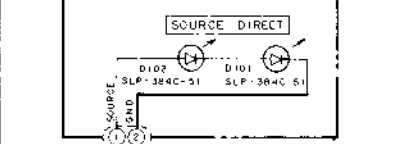

LED PCB A2052A503D

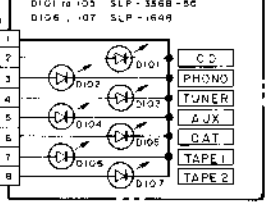

SWITCH PCB A2052A502D

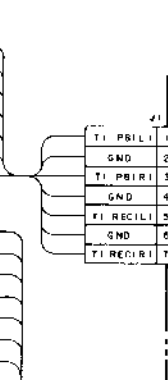

TAPE SELECTOR PCB A2052A502B

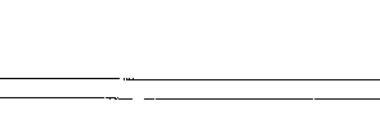

POWER SUPPLY PCB A2052A503B

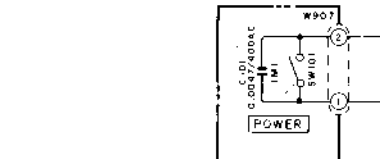

POWER SW PCB A2052A503H

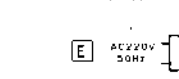

PIN JACK PCB A2052A503C

