

Dual

Service-Anleitung
Service Manual
Instructions de Service

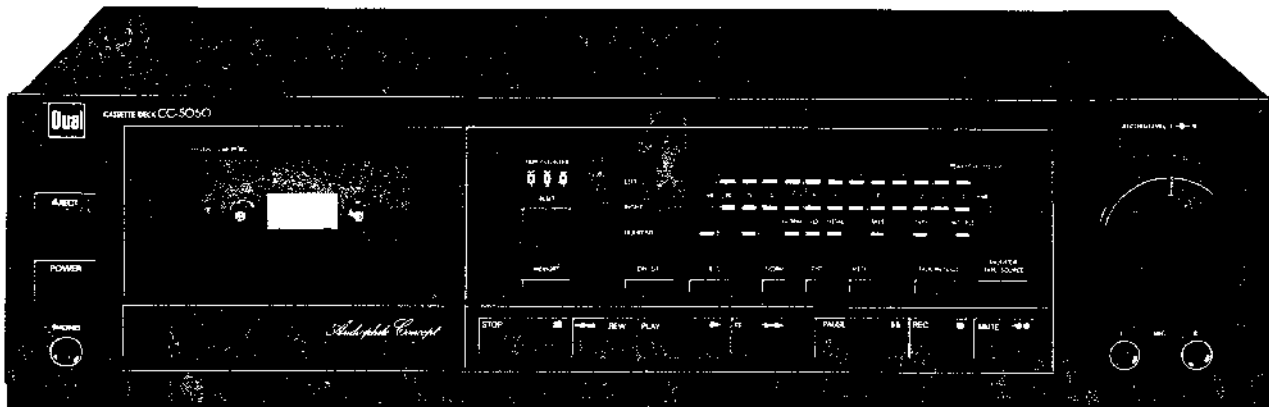



CC 5050

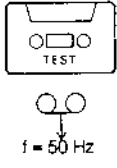
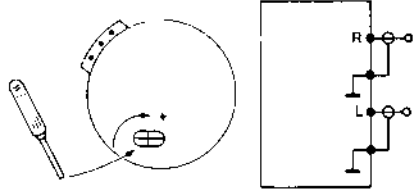
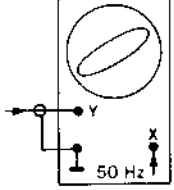
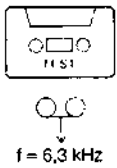
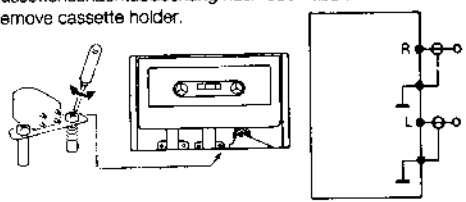
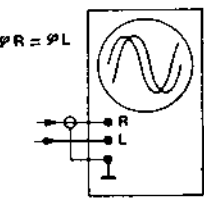

Technische Daten (typische Werte)	Technical data (typical value)	Caractéristiques techniques (valeur caractéristique)	CC 5050
Bandgeschwindigkeit	Tape speed	Vitesse de bande	4,75 cm/s (1 7/8 ips)
Kurzzeitige Geschwindigkeitsschwankungen (Tonhörschwankungen) W.R.M.S. nach DIN Aufnahme/Wiedergabe	Wow and flutter Weighted RMS to DIN for recording/playback	Fluctuations instantanées de la vitesse variations de la hauteur du son W.R.M.S. selon DIN enregistrement/lecture	$\pm 0,06\%$ $\pm 0,10\%$
Übertragungsbereich (bezogen auf DIN-Toleranzfeld) Fe-Band CrO ₂ -Band Reinisen-Band	Frequency response (ref. to DIN tolerances) Standard Fe tape CrO ₂ tape Pure metal tape	Bande passante tranchée à la page de tolérance DIN Bande Fe Bande CrO ₂ Bande fer pur	25 - 15 000 Hz 25 - 17 000 Hz 25 - 17 000 Hz
Ruhegeräuschspannungsabstand mit Dolby NR Fe-Band CrO ₂ -Band Reinisen-Band	Signal-to-noise ratio with Dolby NR Standard Fe tape CrO ₂ tape Pure metal tape	Rapport signal/bruit avec Dolby NR Bande Fe Bande CrO ₂ Bande fer pur	Dolby NR B C 65 dB 73 dB 62 dB 70 dB 66 dB 76 dB
Übersprechdämpfung (bei 1000 Hz) zwischen zustimmgehörigen Kanälen zwischen Kanälen in Gegenrichtung	Channel separation (at 1000 Hz) between stereo channels in opposite direction	Diaphonie (à 1000 Hz) en sens stéréo en sens inverse	40 dB 75 dB
Löschdämpfung bei 1000 Hz	Erasure at 1000 Hz	Atténuation d'effacement à 1000 Hz	70 dB
Eingänge (Empfindlichkeit 0,3 dB/Impedanz) Mikrofon (1/4" Koaxial-Buchse) Receiver/Verstärker (Cinch)	Inputs (sensitivity at 0 dB/impedanz) Microphone (1/4" coaxial jack) Receiver/amplifier (Cinch)	Entrées (sensibilité pour 0 dB/impedanz) Micro-phonse coaxiale de 1/4" Amp-tuner/amplificateur (Cinch)	0,40 mV/4 kOhm 100 mV/50 kOhm
Ausgänge (Spannung bei 0 dB/Impedanz) Receiver/Verstärker (Cinch) Kopfhörer (1/4" Koaxialbuchse)	Outputs Receiver/amplifier (Cinch) Headphone (1/4" coaxial jack)	Sorties Amp-tuner/amplificateur (Cinch) Casque (prise coaxiale de 1/4")	500 mV/2 kOhm 600 mV
Umspulzeit für C 60 Cassette	Fast winding time for C 60 cassettes	Temps de rebobinage pour cassette C 60	90 sec.
Netzspannung	Line voltage	Tension secteur	Model Europe 230 V Model USA/Canada 200 V
Netzfrequenz	Line frequency	Fréquence secteur	50 - 60 Hz
Leistungsaufnahme	Power requirement	Consommation	25 Watt

Dual GmbH · Postfach 1144 · 7742 St. Georgen/Schwarzwald

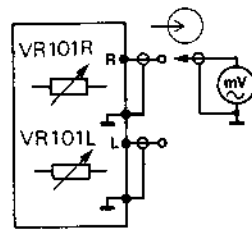
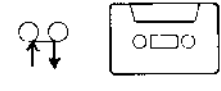
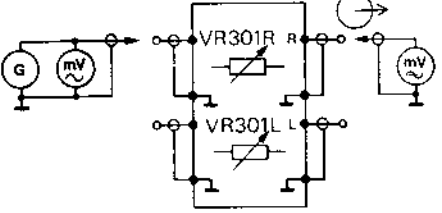
Abgleich · Alignment · Reglages

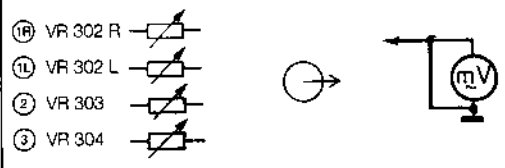
<p>1 Bandzug Tape tension Tension de bande Tensión de la cinta Tensione del nastro</p>			<p>«←→» > 40 g/cm < 60 g/cm</p> <p>«<<» «>>» > 80 g/cm < 140 g/cm</p>
<p>2 Bandgeschwindigkeit Tape speed Vitesse de défilement Velocidad de la cinta Velocità del nastro</p>	 <p>f = 50 Hz</p>		 <p>Frequenzzähler oder Wow und Flutter Meter. Frequency counter or wow and Flutter meter.</p>
<p>3 Azimuteinstellung Azimuth adjustment Réglage d'azimut Ajuste de azimut Regolazione di azimut</p>	 <p>f = 6,3 kHz</p>	<p>Cassetenschachtabdeckung nach oben abziehen. Remove cassette holder.</p>  <p>Azimut mit rechter Schraube einstellen. Adjust Azimuth with the right screw.</p>	 <p>Maximum</p>
<p>4 Wiedergabeempfindlichkeit Playback sensitivity Gain en lecture Ganancia en reproducción Sensibilità di riproduzione</p>	 <p>off</p> <p>400 Hz</p>		<p>Vs = 500 mV Δ Vu = 0 dB</p>
<p>5 Aufnahmeempfindlichkeit Record sensitivity Gain en enregistrement Ganancia en grabación Sensibilità registrazione</p>	 <p>Ve = ca. 100 mV f = 400 Hz</p>		<p>Tape/Source auf gleiche Ausgangsspannung einstellen. Adjust Tape/Source to the same output voltage.</p> <p>V = 500 mV Δ Vu = 0 dB</p>
<p>6 Vormagnetisierung Bias adjustment Courant de pré-magnétisation Corriente de pre-magnetización Corrente di pre-magnetizzazione</p>	 <p>off</p> <p>10 kHz - 20 dB</p> <p>1) Normal 2) CrO2 3) Metal</p>	 <p>TP 20 OSC Block</p> 	<p>F = 85 kHz</p> <p>Tape/Source auf gleiche Ausgangsspannung einstellen. Adjust Tape/Source to the same output voltage.</p>

BLOCK DIAGRAM

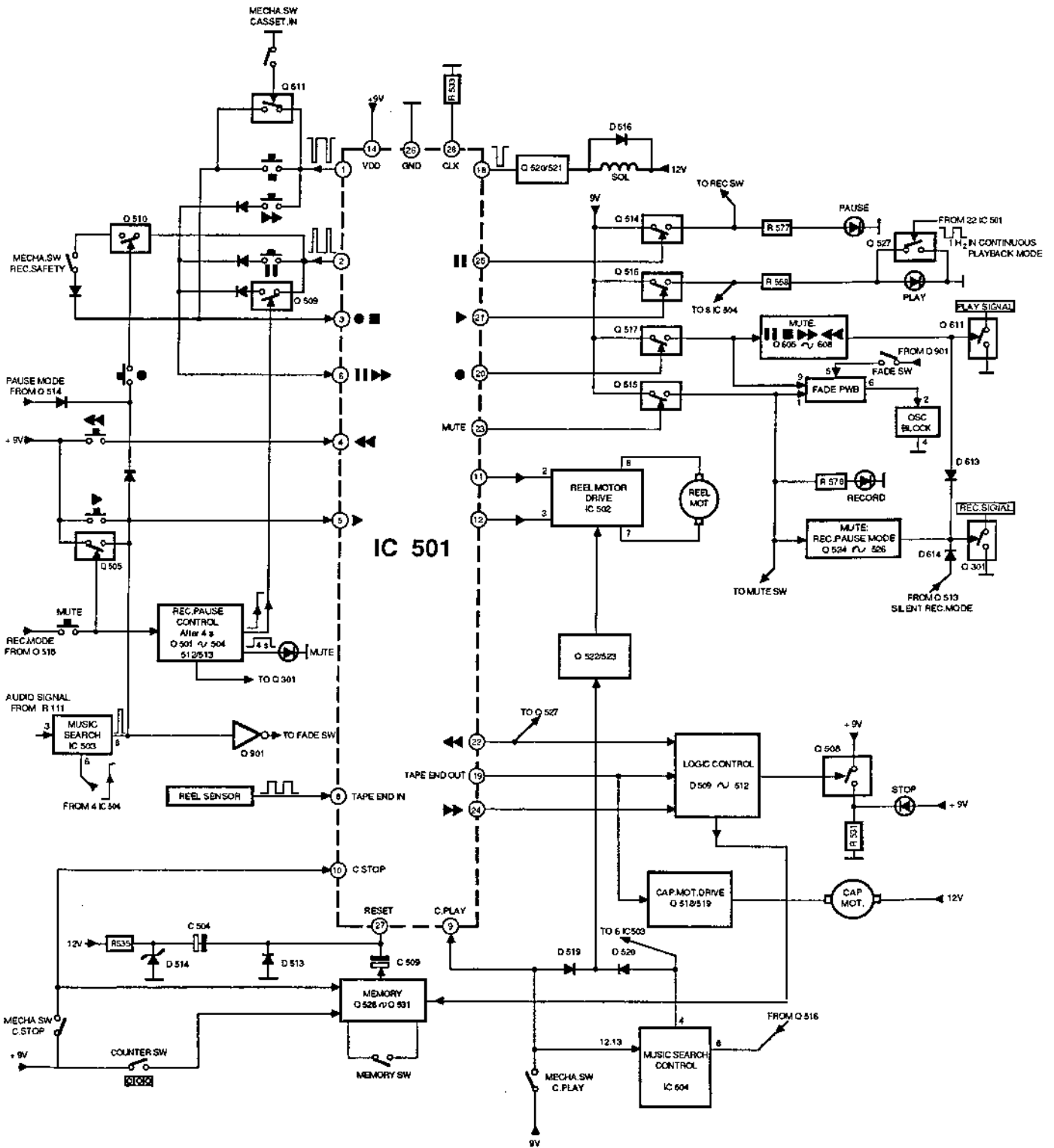

Frontplatte
PCB Indicators
Platine voyants

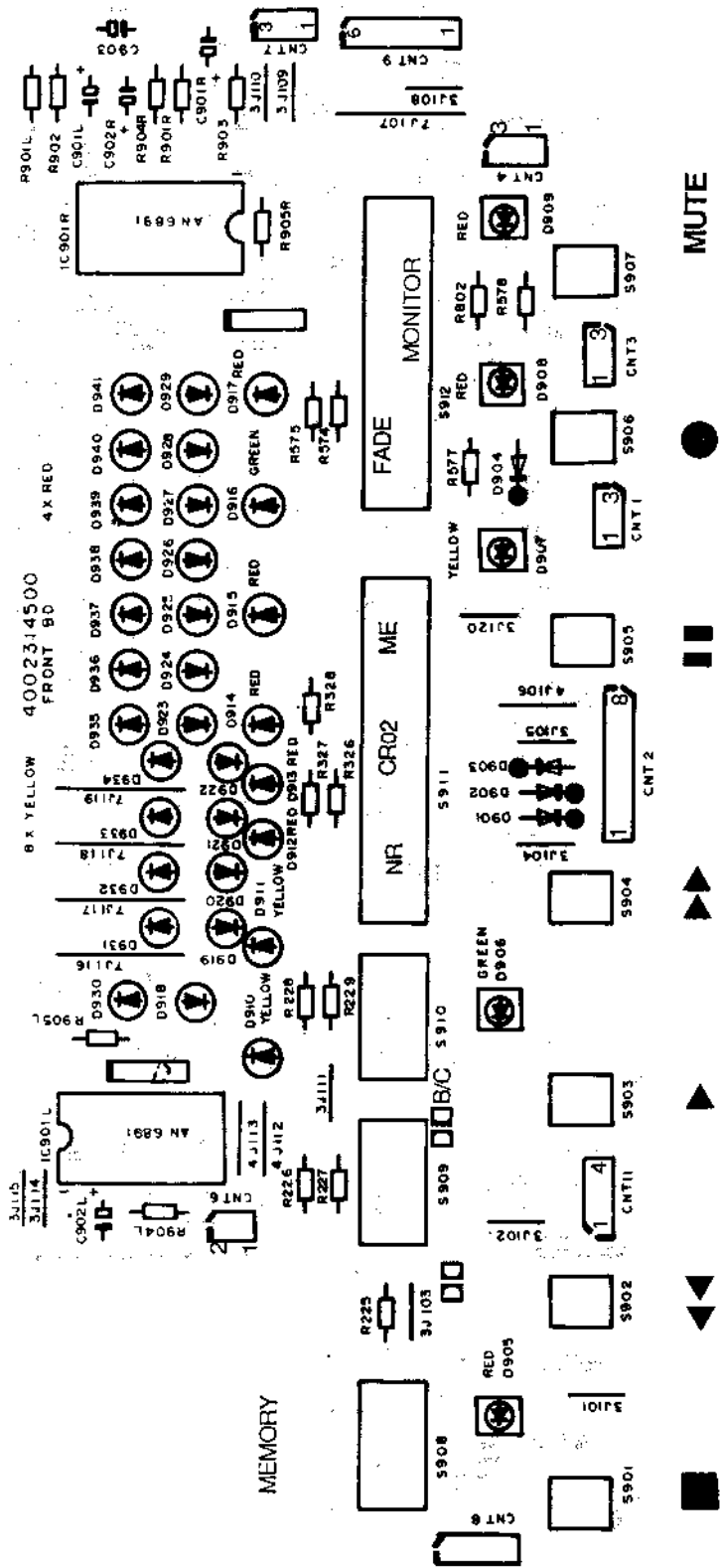

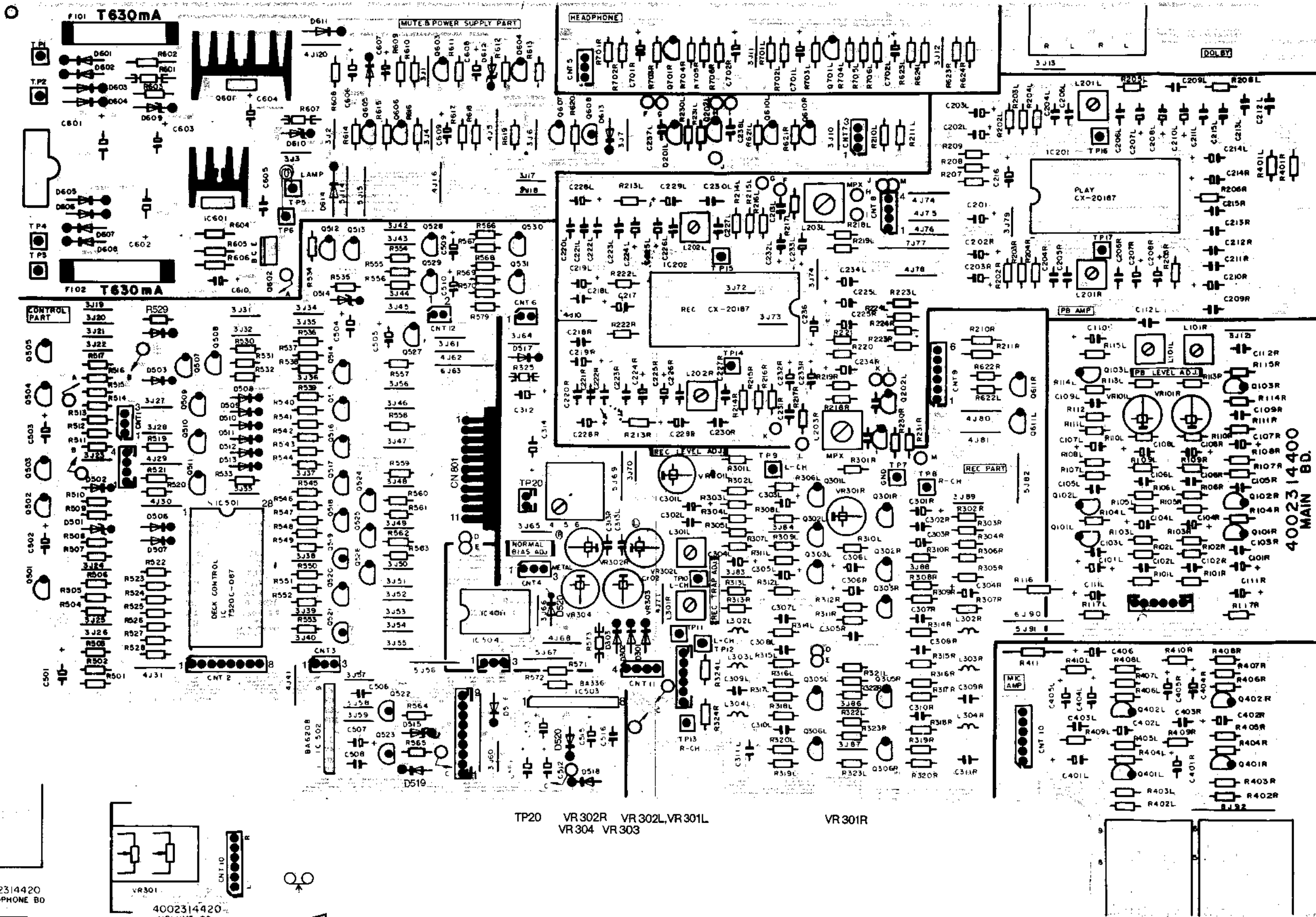

VR 101L
VR 101R

4002314400
MAIN BD.

TP20 VR 302R VR 302L, VR 301L
VR 304 VR 303

VR 301R

Bestückungsseite
Component side
Côté composants

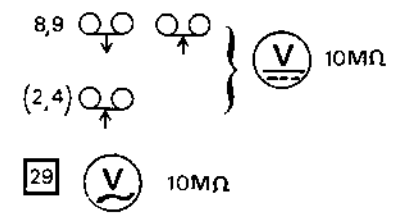
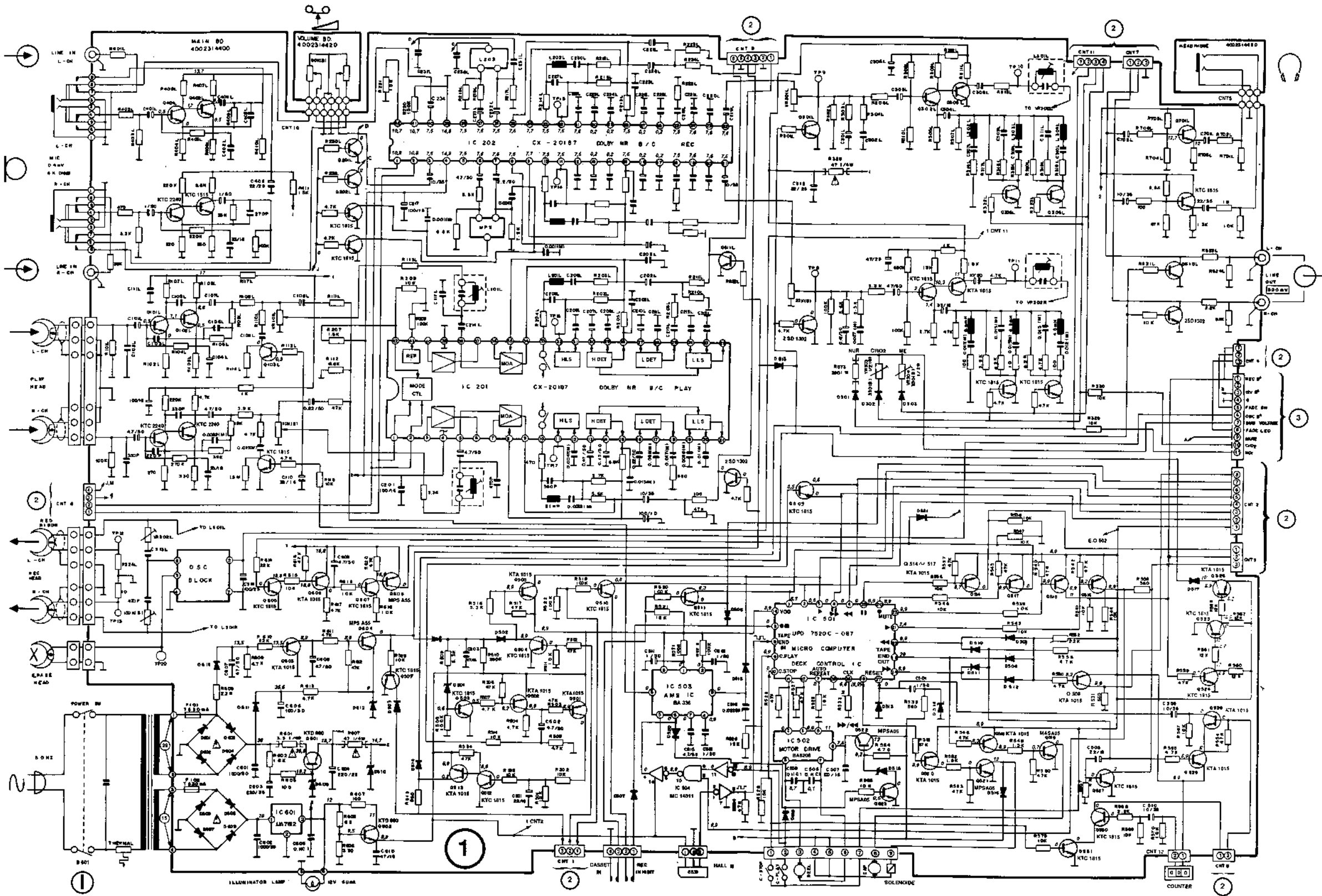

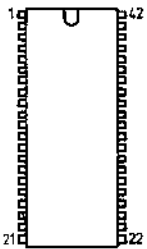
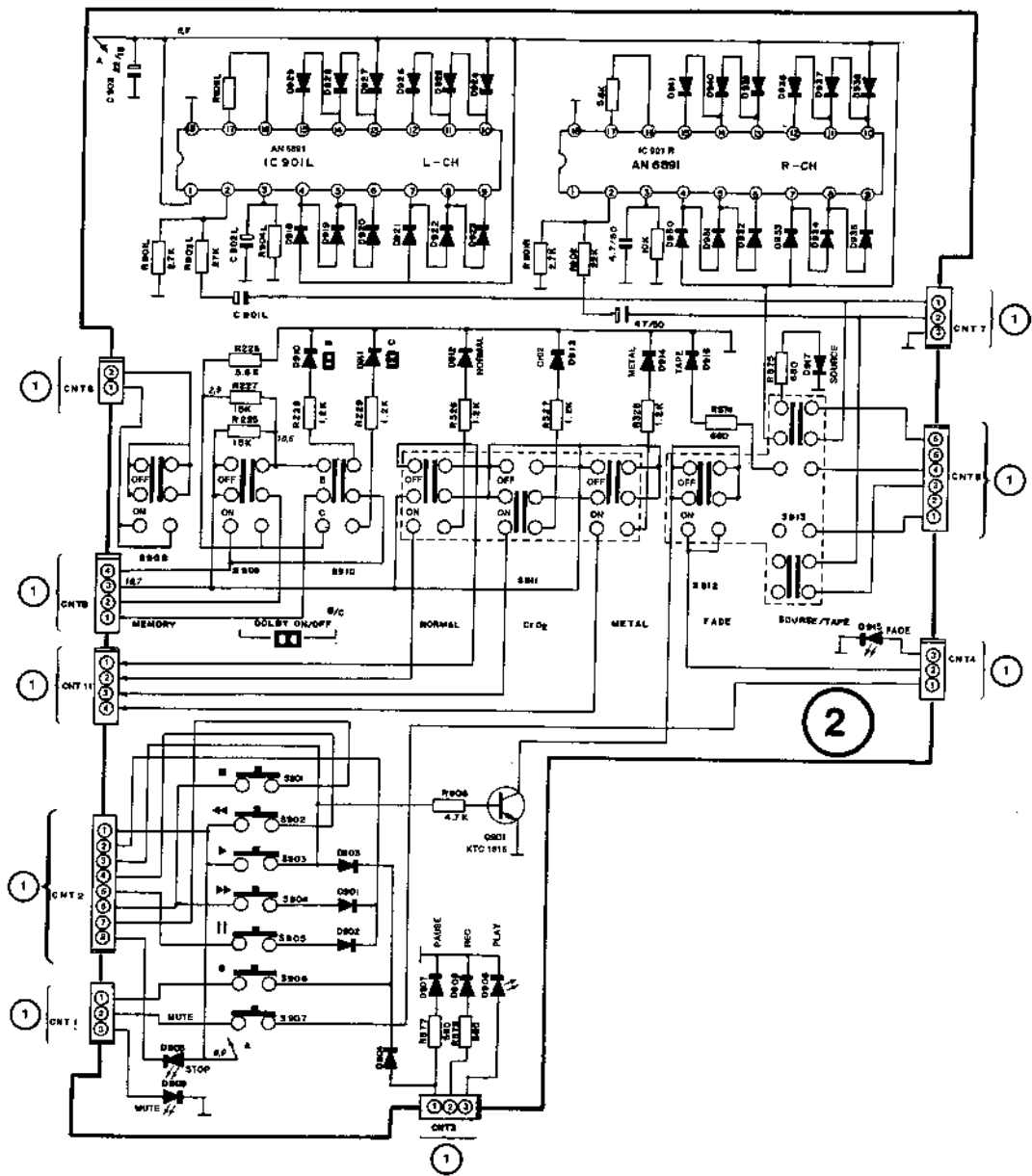

CX-20187

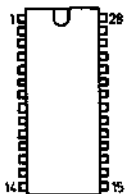

UDP7520C-087

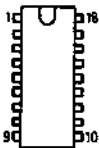

AN6891

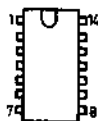

LM 324
MC 14011
MC 14066
HD 14001



MC1455

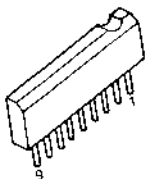

BA 336
BA 6208



UA7812

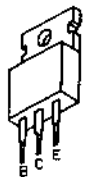

KTD880



MPSA05
MPSA55



KTA 1015Y
KTC 1815Y
KTC 2240
2SD 1302S

Fade Schaltung
 Fade PCB
 Platine Fade

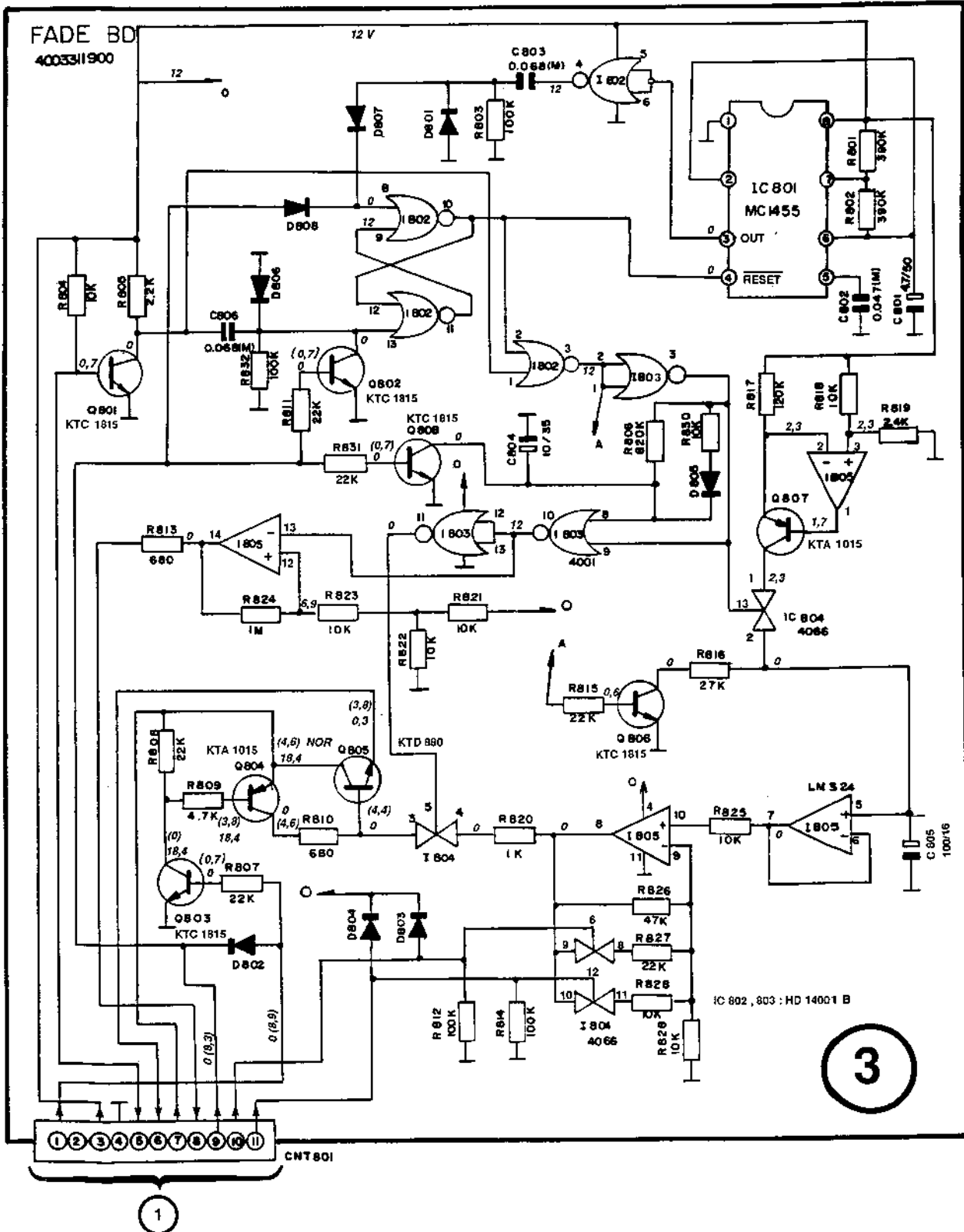

Ersatzteile · Replacement parts · Pièces détachées · CC 5050

Pos.	Art.-Nr.	Stck	Bezeichnung
1	283 053	1	Frontblende
2	282 104	1	Seitenteil L
3	282 105	1	Seitenteil R
4	283 052	1	Cassettenfenster
5	283 047	1	Cassettenblende
6	282 382	1	Cassettenzwischenplatte
7	283 064	1	Druckknopf Power
8	282 109	1	Druckfeder
9	283 045	1	Blendenträger
10	283 083	1	Taste EJECT
11	282 114	6	Druckfeder
12	282 126	1	Schalter
14	282 386	1	Tastenführung
15	282 387	1	Zählertaste
16	282 388	1	Zähler
17	282 389	1	Riemen
18	283 046	1	Anzeigeblende
19	283 055	1	Drehknopf L
20	283 054	1	Drehknopf R
21	283 048	1	Volumenblende
22	282 121	4	Fußdämpfer
23	283 049	1	Tasten Deck 4-fach
24	283 051	1	Tasten REC
25	282 396	1	Anzeige LED Stop
26	282 397	1	Anzeige LED Play
27	282 398	1	Anzeige LED REC
28	283 050	1	Tasten Deck 3-fach
29	282 400	1	Anzeige LED Pause
30	282 401	1	Anzeige LED Mute
31	282 402	4	Taste Dolby
32	282 403	1	Taste Fade
33	283 059	1	Steller 50 kx2
34	282 158	1	Druckknopf Subs/Loud
39	282 405	2	MIC-Buchse
42	282 120	2	Fuß
43	282 406	1	Schalter 3-fach
44	282 407	1	Schalter 2-fach
46	282 408	5	Halter LED
47	282 127	7	Taster
48	282 125	3	Schalter
49	283 044	1	Gehäuseblech
51	282 410	1	Transformator
56	282 412	1	Cinchbuchse 4-fach
58	243 750	1	Netzkabel Europa
59	282 413	1	Abdeckung
60	282 414	1	Bandanzeiger
61	283 058	1	Lampe 12 V 80 mA
62	282 416	1	Leuchtschild
65	282 131	1	Kopfhörerbuchse
66	282 135	4	Schraube 4x8
67	282 523	2	Schraube 3x8
70	282 385	1	Cassettenmechanik
71	282 420	2	Scheibe 2,1/4/0,5
72	280 860	1	Mitnehmer
73	282 421	1	Dämpfer
74	282 422	1	Kupplung
75	263 029	1	IC ND 6838
76	282 424	1	Schwungscheibe
77	282 425	1	A/W-Kopf
78	282 426	1	Löschkopf
79	282 427	1	Andruckrolle
80	280 394	1	Motor
81	280 399	1	Motor
82	282 428	1	Zugmagnet
83	280 393	1	Feder
85	282 429	1	Schenkelfeder
86	282 430	1	Schenkelfeder
87	282 431	1	Schenkelfeder
88	282 432	1	Schenkelfeder
89	282 433	1	Schenkelfeder
90	282 434	1	Schenkelfeder
91	282 435	1	Schenkelfeder
92	282 436	1	Schalter
93	282 437	1	Schalter
94	282 438	1	Lagerbuchse
95	280 406	1	Antriebsriemen
96	282 439	1	Antriebsrolle
97	282 440	1	Kurvenrad
98	282 441	1	Antriebsrad
100		1	Grundplatte
101		1	Frontplatte
102		1	Fade-Platte

Pos.	Art.-Nr.	Stck	Bezeichnung
103		1	Reglerplatte
104		1	Kopfhörerplatte
D 301	226 501	13	Diode 1 N 4002
bis			
D 303	226 501	13	Diode 1 N 4002
D 501	282 078	19	Diode DZ 3,3 B
D 502	223 906	19	Diode 1 N 4148
D 503	223 906	19	Diode 1 N 4148
D 505	223 906	19	Diode 1 N 4148
D 506	223 906	19	Diode 1 N 4148
D 507	223 906	19	Diode 1 N 4148
bis			
D 513	223 906	19	Diode 1 N 4148
D 514	282 062	2	Diode DZ 9,1 BM
D 516	226 501	13	Diode 1 N 4002
D 601	226 501	13	Diode 1 N 4002
bis			
D 608	226 501	13	Diode 1 N 4002
D 609	282 064	1	Diode DZ 18 BM
D 610	282 447	1	Diode DZ 13 BM
D 611	226 501	13	Diode 1 N 4002
D 612	282 062	2	Diode DZ 9,1 BM
D 613	223 906	19	Diode 1 N 4148
D 614	223 906	19	Diode 1 N 4148
D 615	223 906	19	Diode 1 N 4148
D 801	223 906	8	Diode 1 N 4148
bis			
D 808	223 906	8	Diode 1 N 4148
D 901	223 906	4	Diode 1 N 4148
bis			
D 904	223 906	4	Diode 1 N 4148
D 905	282 377	3	LED SLR 34 URC 3 (STOP)
D 906	282 378	2	LED SLR 34 MC 3 GN (PLAY)
D 907	283 056	2	LED SLR 34 YC 3 (PAUSE)
D 908	282 377	3	LED SLR 34 URC 3 (REC)
D 909	282 377	3	LED SLR 34 URC 3 (MUTE)
D 910	283 057	19	LED SLR 54 YC 3 D (DOLBY NR B)
D 911	283 057	19	LED SLR 54 YC 3 D (DOLBY NR C)
D 912	282 084	13	LED SLV 56 URC 3 (NORM, C, O ₂ , METAL)
bis			
D 915	282 084	13	LED SLV 56 URC 3 (FADE)
D 916	282 375	19	LED SLR 54 GC (TAPE)
D 917	282 084	13	LED SLV 56 URC 3 (SOURCE)
D 918	283 057	19	LED SLR 54 YC 3 D (Peak level - dB)
bis			
D 925	283 057	19	LED SLR 54 YC 3 D (Peak level - dB)
D 926	282 084	13	LED SLV 56 URC 3 (Peak level + dB)
bis			
D 929	282 084	13	LED SLV 56 URC 3 (Peak level + dB)
D 930	283 057	19	LED SLR 54 YC 3 D (Peak level - dB)
bis			
D 937	282 376	19	LED SLR 54 YC (Peak level - dB)
D 938	282 084	13	LED SLV 56 URC 3 (Peak level + dB)
bis			
D 941	282 084	13	LED SLV 56 URC 3 (Peak level + dB)
L 101	282 366	4	Spule REC
L 201	282 367	4	Spule 21 MH
L 202	282 367	4	Spule 21 MH
L 203	282 365	2	Spule MPX
L 301	282 366	4	Spule REC
L 302	282 369	2	Spule 5,5 MH
L 303	282 370	2	Spule 6,3 MH
L 304	282 368	2	Spule 4,5 MH
L 999	282 364	1	OSC Block
Q 101	282 052	6	Transistor KTC 2240 BL
Q 102	282 052	6	Transistor KTC 2240 BL
Q 103	282 076	30	Transistor KTC 1815 Y
Q 301	274 774	6	Transistor 2 SD 1302 T
Q 302	282 076	30	Transistor KTC 1815 Y
Q 303	282 077	18	Transistor KTA 1015 Y
Q 305	282 076	30	Transistor KTC 1815 Y
Q 308	282 076	30	Transistor KTC 1815 Y
Q 401	282 052	6	Transistor KTC 2240 BL
Q 402	282 076	30	Transistor KTC 1815 Y
Q 501	282 077	18	Transistor KTA 1015 Y
Q 502	282 077	18	Transistor KTA 1015 Y
Q 503	282 076	30	Transistor KTC 1815 Y
Q 504	282 076	30	Transistor KTC 1815 Y
Q 505	282 077	18	Transistor KTA 1015 Y
Q 507	282 076	30	Transistor KTC 1815 Y
Q 508	282 077	18	Transistor KTA 1015 Y
Q 509	282 076	30	Transistor KTC 1815 Y
Q 512	282 076	30	Transistor KTC 1815 Y
Q 513	282 077	18	Transistor KTA 1015 Y
Q 518	282 077	18	Transistor KTA 1015 Y

Änderungen vorbehalten! Subject to change! Sous réserve de modification!

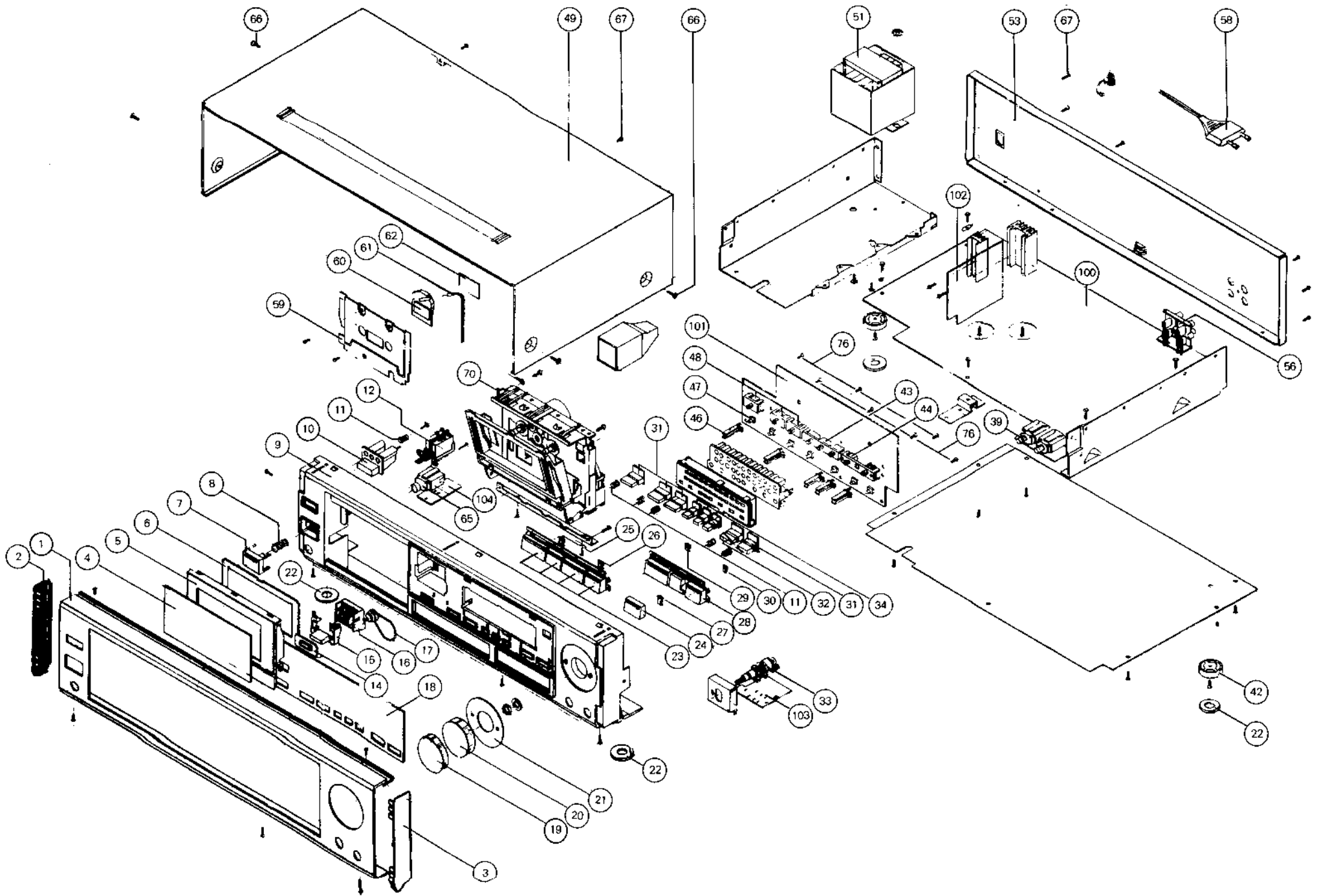

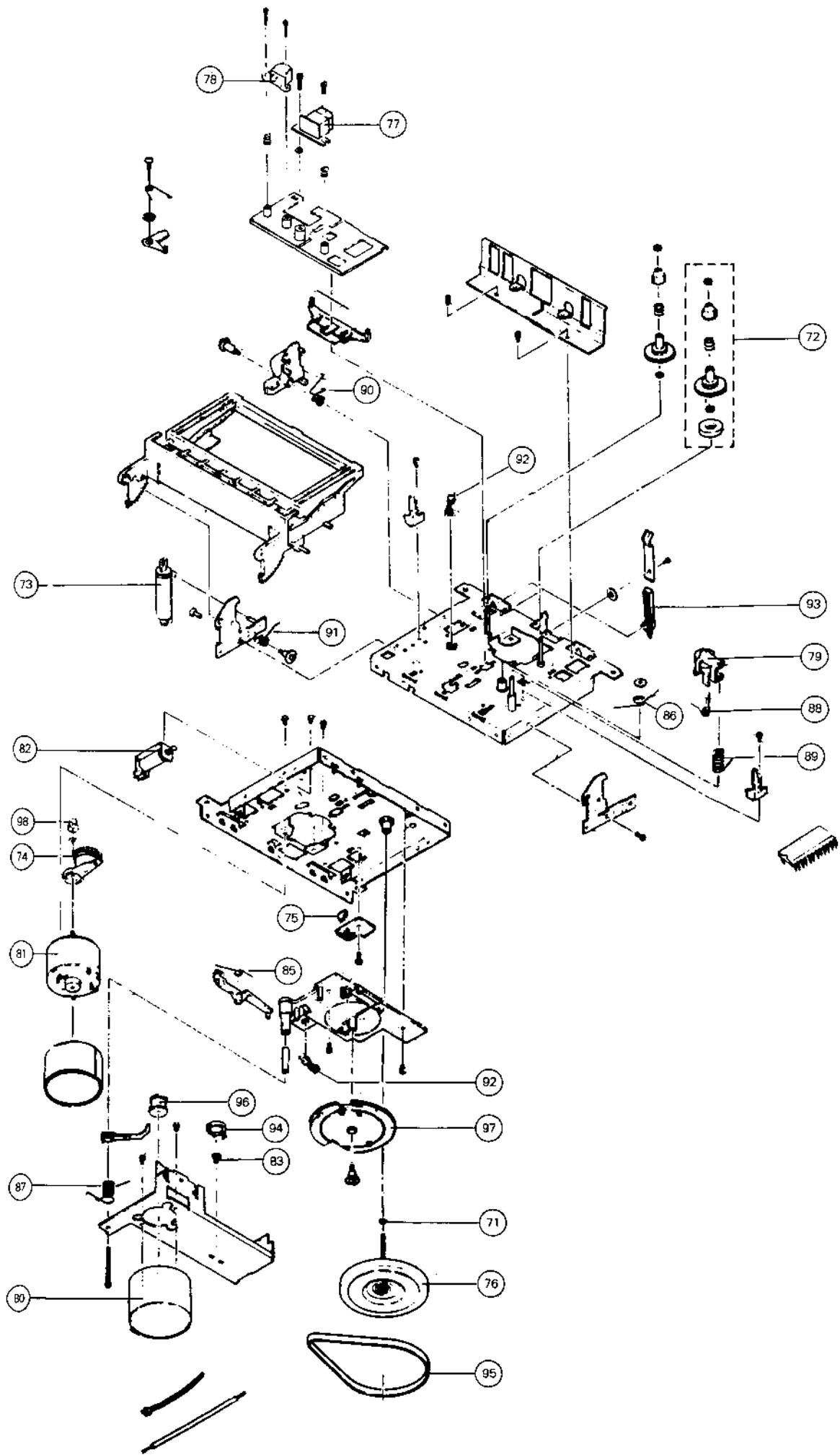

Ersatzteile · Replacement parts · Pièces détachées · CC 5050

Pos.	Art.-Nr.	Stck	Bezeichnung
Q 519	282 059	4	Transistor MPS A 05
Q 520	282 077	18	Transistor KTA 1015 Y
Q 523	282 059	4	Transistor MPS A 05
Q 524	282 076	30	Transistor KTC 1815 Y
Q 526	282 077	18	Transistor KTA 1015 Y
Q 527	282 076	30	Transistor KTC 1815 Y
Q 528	282 077	18	Transistor KTA 1015 Y
Q 529	282 077	18	Transistor KTA 1015 Y
Q 530	282 076	30	Transistor KTC 1815 Y
Q 531	282 076	30	Transistor KTC 1815 Y
Q 601	282 057	2	Transistor KTD 880 Y
Q 602	282 057	2	Transistor KTD 880 Y
Q 603	282 077	18	Transistor KTA 1015 Y
Q 604	282 060	2	Transistor MPS A 55
Q 605	282 076	30	Transistor KTC 1815 Y
Q 606	282 077	18	Transistor KTA 1015 Y
Q 607	282 076	30	Transistor KTC 1815 Y
Q 608	282 060	2	Transistor MPS A 55
Q 610	274 774	6	Transistor 2 SD 1302 T
Q 611	274 774	6	Transistor 2 SD 1302 T
Q 701	282 076	30	Transistor KTC 1815 Y
Q 801	282 076	5	Transistor KTC 1815 Y
Q 803	282 076	5	Transistor KTC 1815 Y
Q 804	282 077	2	Transistor KTA 1015 Y
Q 905	282 057	1	Transistor KTD 880 Y

Pos.	Art.-Nr.	Stck	Bezeichnung
Q 806	282 076	5	Transistor KTC 1815 Y
Q 807	282 077	2	Transistor KTA 1015 Y
Q 808	282 076	5	Transistor KTC 1815 Y
Q 901	282 076	1	Transistor KTC 1815 Y
IC 201	282 360	2	IC CX 20187
IC 202	282 360	2	IC CX 20187
IC 501	282 361	1	IC UPD 7520 C-087
IC 502	282 362	1	IC BA 6208
IC 503	282 363	1	IC BA 336
IC 504	240 843	1	IC MC 14011 BCP MOS
IC 601	247 242	1	IC MC 7812
IC 801	282 534	1	IC MC 1455
IC 802	261 872	2	IC MC 14001 BPC MOS
IC 803	261 872	2	IC MC 14001 BPC MOS
IC 804	245 220	1	IC MC 14066 B
IC 805	261 352	1	IC LM 324
IC 901	282 374	2	IC AN 6891
VR 101	283 061	4	Steller 10 kΩ
VR 301	283 061	4	Steller 10 kΩ
VR 302	283 062	2	Steller 100 k
VR 303	283 060	2	Steller 330
VR 304	283 060	2	Steller 330
	283 065	1	Bedienungsanleitung
	282 533	1	Verpackung kpl.

Änderungen vorbehalten! Subject to change! Sous réserve de modification!

	Ⓓ Zeichenerklärung	Ⓔ Legend	Ⓕ Légende	Ⓖ Leyenda	Ⓙ Leggendo
—	Ein	On	Marche	Encendido	Acceso
○	Aus	Off	Arrêt	Apagado	Spento
○	Ein-Aus	On-Off	Marche-Arrêt	Encendido-Apagado	Acceso-Spento
⌚	Bereitschaft	Stand-by	Attente (veille)	Espere	Disponibile
▲	Lautstärke	Volume	Volumen	Volumen	Volumen
⚖	Balance	Balance	Balance	Balance	Balance
🎵	Höhen	Treble	Aiguës	Agudos	Alti
🎵	Bässe	Bass	Graves	Graves	Bassi
🔊	Lautsprecher	Loudspeaker	Haut-Parleur	Altavoz	Alto parlante
🎧	Kopfhörer	Headphones	Casque	Auriculares	Cuffie
👂	Hörklapsel	Earphones	Ecouteur	Auricular	Cuffia
🔇	Stummschaltung	Muting	Silencieux	Circuito silencioso	Sintonia Silenziosa
🎛	Abstimmen	Tuning	Sintonisation	Sintonía	Sintonia
📻	Empfangsfrequenz-Regelung	Automatic frequency control	Contrôle automatique de fréquence	Control automático de frecuencia	Controllo automatico della frequenza
→	Normal-Lauf	Normal-run	Défilement normal	Velocidad normal	Sfilamento normale
→	Schnell-Lauf	Fast-run	Défilement rapide	Velocidad rapida	Sfilamento rapido
⏸	Pause	Pause	Pause	Pause	Pause
🗑	Auswurf	Eject	Ejection	Expulsión	Eiezione
⏹	Stop	Stop	Stop	Stop	Stop
🗑	Stop / Eject	Stop / Eject	Stop / Eject	Stop / Eject	Stop / Eject
🎤	Microphone	Microphone	Microphone	Micrófono	Microfono
📼	Tonbandgerät	Tape recorder	Magnétophone	Magnetófono	Magnetofono
🎙	Aufnahme	Recording	Enregistrement	Grabación	Registrazione
🎙	Wiedergabe	Play-back	Lecture	Reproducción	Riproduzione
📡	Antenne	Aerial	Antenne	Antena	Antenne
📡	Dipole	Dipole	Dipôle	Dipole	Dipole
📡	Tuner	Tuner	Radio-récepteur	Sintonizador	Tuner
📀	Plattenspieler	Pick-up	Lecteur de disques	Giradiscos	Gradischi
📀	Mono	Mono	Mono	Mono	Mono
📀	Stereo	Stereo	Stereo	Estereo	Stereo
🕒	Uhr, Timer	Clock, Timer	Horloge, minuterie	Reloj, Timer	Orologio, Timer
📡	Output	Output	Sortie d'un signal	Salida de señales	Uscita di segnale
📡	Input	Input	Entrée d'un signal	Entrada de señales	Ingresso di segnale
🎛	Trimmer	Trimmer	Trimmer	Trimmer	Trimmer
🎛	Einstellregler	Adjuster	Potentiomètre ajustable	Potenciómetro ajustable	Trimmer ohmico
🎛	Abgleichbarer Kreis	Circuit can be aligned	Circuit à aligner	Circuito ajustable	Circuito a sintoniare
💡	L E D	L E D	L E D	L E D	L E D
📡	Photodiode	Photodiode	Photodiode	Fotodiodo	Photodiodo
📡	Messpunkt	Test point	Point test	Punto de prueba	Punto di riferimento