

AKAI SERVICE MANUAL

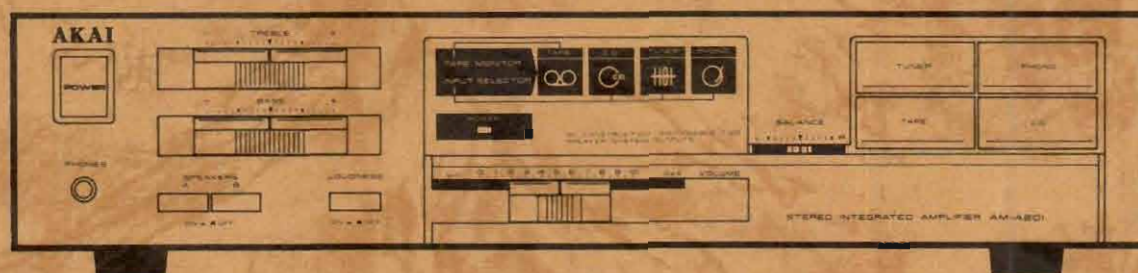

STEREO INTEGRATED AMPLIFIER

MODEL **AM-A201**



STEREO INTEGRATED AMPLIFIER

MODEL **AM-A201**

SECTION 1	SERVICE MANUAL	3
SECTION 2	PARTS LIST	9

SAFETY INSTRUCTIONS

SAFETY CHECK AFTER SERVICING

Confirm the specified insulation resistance between power cord plug prongs and externally exposed parts of the set is greater than 10 Mohms, but for equipment with external antenna terminals (tuner, receiver, etc.) and is intended for **C** or **A**, specified insulation resistance should be more than 2.2 Mohms (ground terminals, microphone jacks, headphone jacks, line-in-out jacks etc.)

PRECAUTIONS DURING SERVICING

1. Parts identified by the \triangle symbol parts are critical for safety.
Replace only with parts number specified.
2. In addition to safety, other parts and assemblies are specified for conformance with such regulations as those applying to spurious radiation. These must also be replaced only with specified replacements.
Examples: RF converters, tuner units, antenna selector switches, RF cables, noise blocking capacitors, noise blocking filters, etc.
3. Use specified internal wiring. Note especially:
 - 1) Wires covered with PVC tubing
 - 2) Double insulated wires
 - 3) High voltage leads
4. Use specified insulating materials for hazardous live parts. Note especially:
 - 1) Insulation Tape
 - 2) PVC tubing
 - 3) Spacers (Insulating Barriers)
 - 4) Insulation sheets for transistors
 - 5) Plastic screws for fixing microswitch (especially in turntable)
5. When replacing AC primary side components (transformers, power cords, noise blocking capacitors, etc.), wrap ends of wires securely about the terminals before soldering.

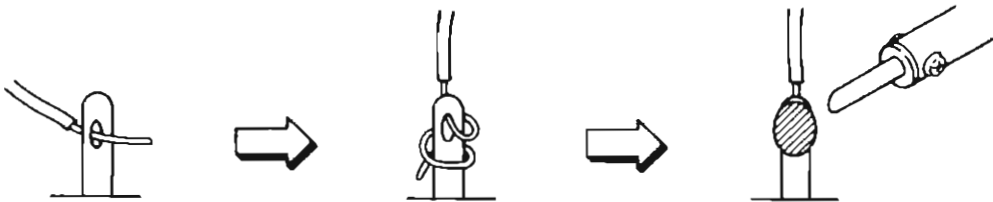

6. Observe that wires do not contact heat producing parts (heatsinks, oxide metal film resistors, fusible resistors, etc.).
7. Check that replaced wires do not contact sharp edged or pointed parts.
8. Also check areas surrounding repaired locations.
9. Use care that foreign objects (screws, solder droplets, etc.) do not remain inside the set.

VOLTAGE CONVERSION

Models for Canada, USA, Europe, UK and Australia are not equipped with this facility. Each machine is preset at the factory according to destination, but some machines can be set to 110V, 120V, 220V or 240V as required.

If your machine's voltage can be converted:

Before connecting the power cord, turn the **VOLTAGE SELECTOR** located on the rear panel with a screwdriver until the correct voltage is indicated.

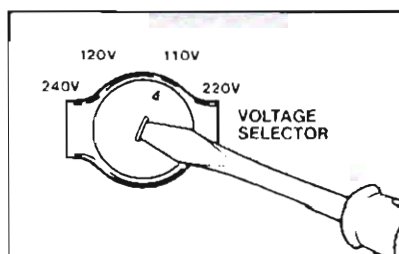

SECTION 1

SERVICE MANUAL

TABLE OF CONTENTS

I. SPECIFICATIONS	4
II. DISMANTLING OF UNIT	5
III. CONTROLS	6
IV. PRINCIPAL PART LOCATION	7
V. PC BOARD TITLES AND IDENTIFICATION NUMBERS	8

For basic adjustments, measuring methods, and operating principles, refer to GENERAL TECHNICAL MANUAL.

I. SPECIFICATIONS

POWER AMPLIFIER SECTION

RATED POWER OUTPUT 40Hz to 20kHz	8 ohms 40W/0.1%
POWER OUTPUT (BY FTC) 40Hz to 200kHz DIN 1kHz	40W/0.1% 45W/0.1%
MUSIC POWERS (BOTH CHANNEL)	200W
POWER BANDWIDTH (IHF -3dB, 8 ohms)	10Hz to 40kHz (0.3%)
S/N (IHF-A) PHONO AUX	72dB 95dB
RESIDUAL NOISE (8 ohms)	0.5mV
CHANNEL SEPARATION (IHF, 1kHz)	45dB
DAMPING FACTOR (1kHz, 8 ohms)	30
REQUIRED SPEAKER IMPEDANCE FOR WEST GERMANY, UK and AUSTRALIA FOR OTHER COUNTRIES	A or B: 4 to 16 ohms A and B: 4 to 16 ohms A or B: 6 to 16 ohms A and B: 6 to 16 ohms

PRE AMPLIFIER SECTION

INPUT SENSITIVITY/IMPEDANCE PHONO AUX TUNER TAPE	2.0mV/47 kohms 150mV/47k ohms 150mV/47k ohms 150mV/47k ohms
OUTPUT LEVEL/IMPEDANCE TAPE REC	150mV/1k ohms
FREQUENCY RESPONSE PHONO (RIAA DEVIATION) TUNER, AUX, TAPE	±0.5dB 5Hz to 100kHz (-3dB)
TONE CONTROL BASS TREBLE	±8dB ±8dB
PHONO MAX. INPUT LEVEL	120mV
POWER REQUIREMENTS	120V,60Hz for USA & Canada 220V,50Hz for Europe except UK 240V,50Hz for UK & Australia 110/120/220/240V,50/60Hz convertible for other countries
DIMENSIONS	440(W) x 100(H) x 267(D) mm (17.3 x 3.9 x 10.5 inches)
WEIGHT	5.7kg (12.6 lbs)

* For improvement purposes, specifications and design are subject to change without notice.

II. DISMANTLING OF UNIT

In case of trouble, etc. necessitating dismantling, please dismantle in the order shown in the photographs. Reassemble in reverse order.

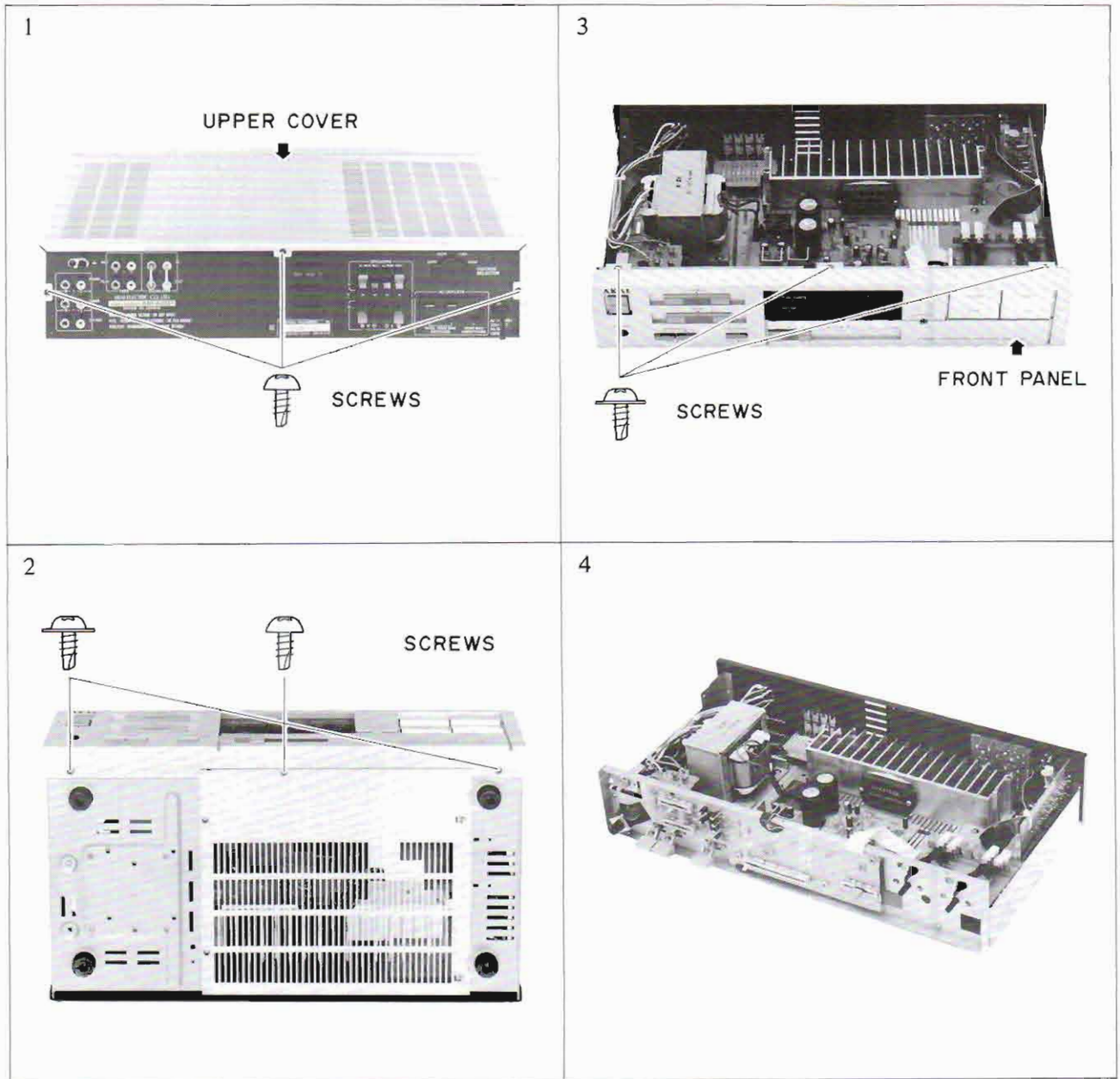

III. CONTROLS

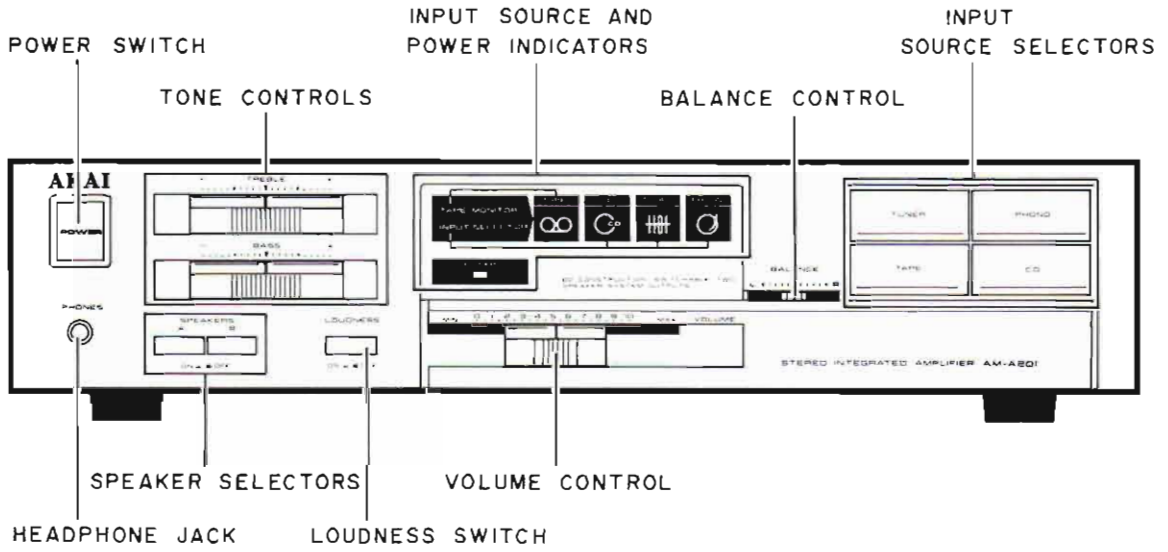

Fig. 3-1

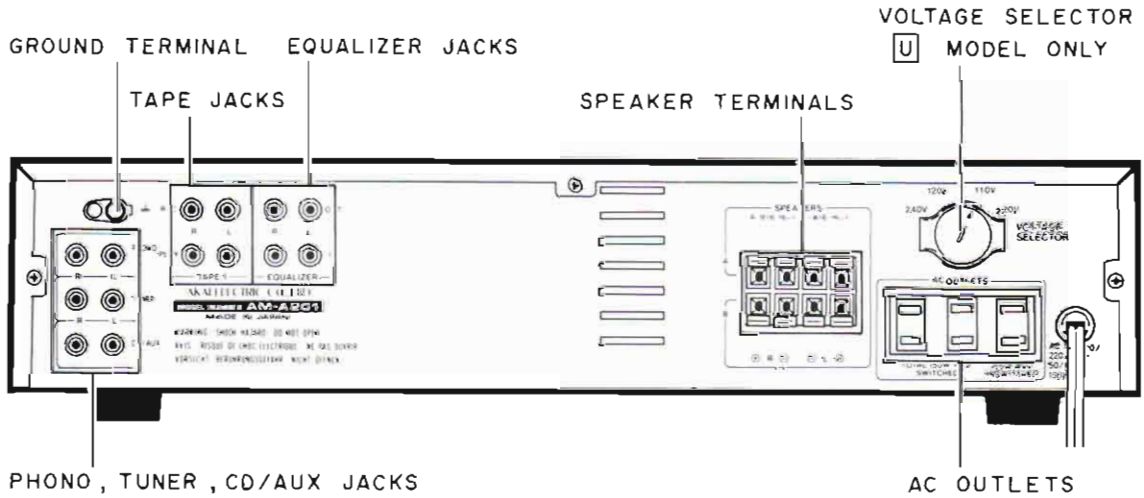

Fig. 3-2

IV. PRINCIPAL PART LOCATION

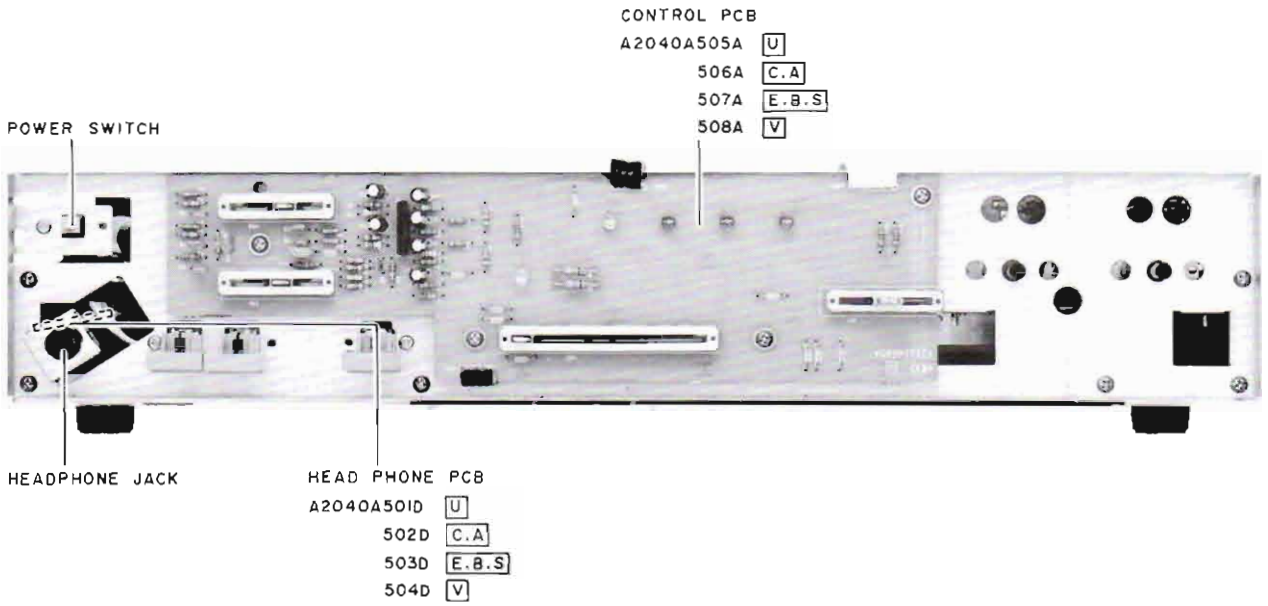

Fig. 4-1

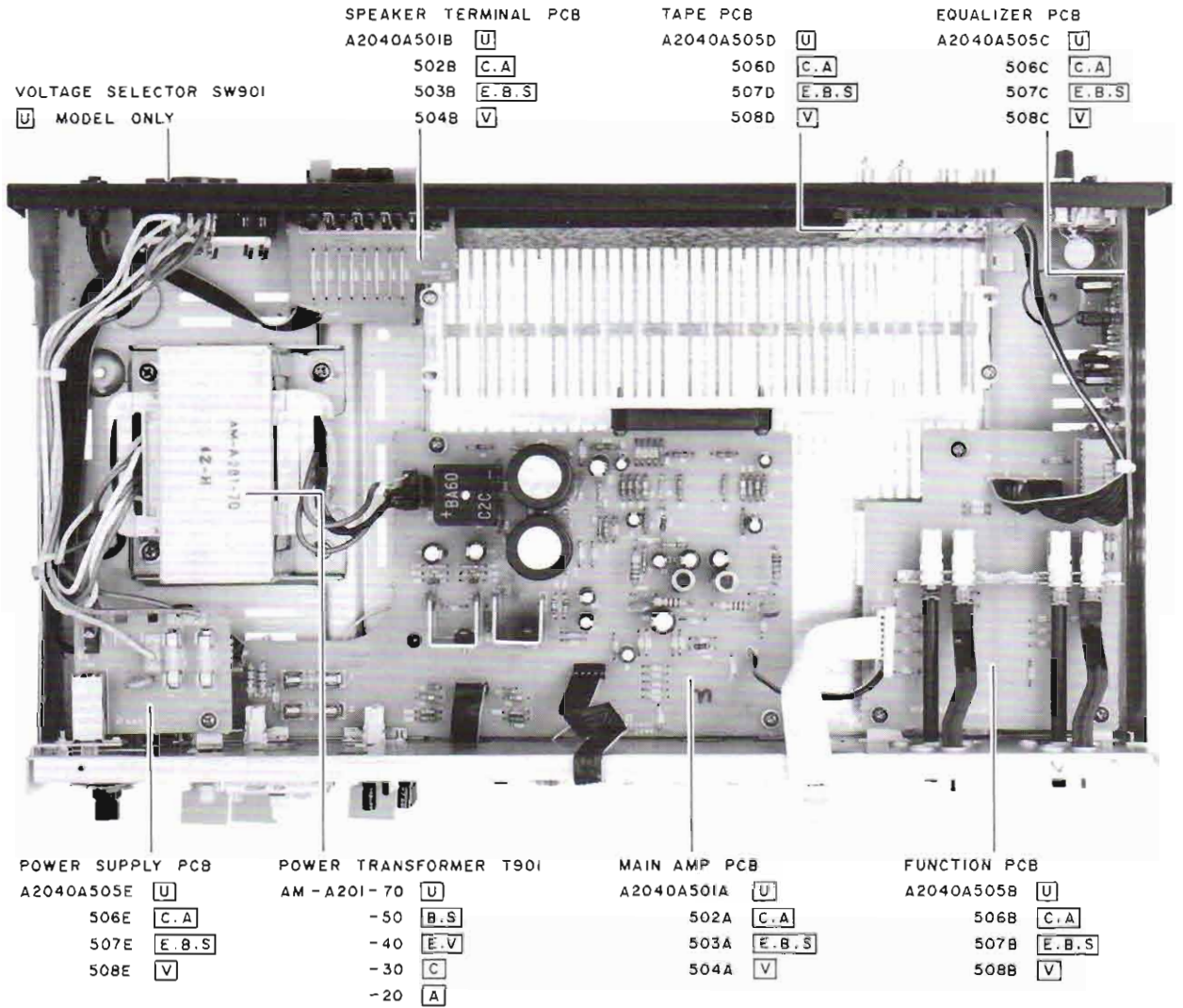

Fig. 4-2

V. PC BOARD TITLES AND IDENTIFICATION NUMBERS

PC BOARD TITLE	PC BOARD NUMBER	REMARKS	
MAIN AMP PC BOARD	A2040A501A	U	
	A2040A502A	C, A	
	A2040A503A	E, B, S	
	A2040A504A	V	
SPEAKER TERMINAL PC BOARD	A2040A501B	U	
	A2040A502B	C, A	
	A2040A503B	E, B, S	
	A2040A504B	V	
FILTER PC BOARD	A2040A504C	V	
	HEAD PHONE PC BOARD	A2040A501D	U
		A2040A502D	C, A
		A2040A503D	E, B, S
A2040A504D		V	
CONTROL PC BOARD	A2040A505A	U	
	A2040A506A	C, A	
	A2040A507A	E, B, S	
	A2040A508A	V	
FUNCTION PC BOARD	A2040A505B	U	
	A2040A506B	C, A	
	A2040A507B	E, B, S	
	A2040A508B	U	
EQUALIZER PC BOARD	A2040A505C	U	
	A2040A504C	C, A	
	A2040A505C	E, B, S	
	A2040A506C	V	
	A2040A507C	V	
TAPE PC BOARD	A2040A505D	U	
	A2040A506D	C, A	
	A2040A507D	E, B, S	
	A2040A508D	V	
POWRR SUPPLY PC BOARD	A2040A505E	U	
	A2040A506E	C, A	
	A2040A507E	E, B, S	
	A2040A508E	V	

SECTION 2

PARTS LIST

TABLE OF CONTENTS

RECOMMENDED SPARE PARTS	11
1. PC BOARD BLOCK	11
2. MAIN AMP PC BOARD	12
3. CONTROL PC BOARD	12
4. FUNCTION PC BOARD	12
5. EQUALIZER PC BOARD	12
6. TAPE PC BOARD	12
7. SPEAKER TERMINAL PC BOARD	12
8. HEAD PHONE PC BOARD	12
9. POWER SUPPLY PC BOARD	12
10. FILTER PC BOARD	12
11. ASSEMBLY BLOCK	13
12. FINAL ASSEMBLY BLOCK	14
INDEX	15

Resistor and Capacitor which is not listed in this parts list, please refer to
COMMON LIST FOR SERVICE PARTS.

ATTENTION

1. When placing an order for parts, be sure to list the parts no., model no., and description of each part. If any of this information is omitted, there are instances in which parts cannot be shipped or the wrong parts will be delivered.
2. Please be careful not to make a mistake in the parts no. If the parts no. is in error, a part different from the one ordered may be delivered.
3. Because part numbers and part definitions and supply in the Preliminary Parts List may have been the subject of changes, please use this parts list for all future reference.

HOW TO USE THIS PARTS LIST

1. This Parts List shows those parts which are considered necessary for repairs. Other parts, such as resistors and capacitors, are shown in the "Common List for Service Parts" from which these parts should be selected and parts.
2. The Recommended Spare Parts List shows those parts in the Parts List which are considered particularly important for service.
3. Parts not shown in the Parts List and "Common List for Service Parts" will not in principle be supplied.
4. How to read the parts list

a) Mechanism Block

b) P.C Board Block

2. HEAD BASE BLOCK

REF. NO.	PART NO.	DESCRIPTION
2-1x	BH-T2023A320A	HEAD BASE BLOCK GX-F66R
2-2	HP-H2206A010A	HEAD R/P PR4-8FU C
2-3	ZS-477876	PAN20×03STL CMT
2-4	ZS-536488	BID20×08STL CMT
2-5	ZG-402895	CS ANGLE ADJUST SPRING

SP (Service Parts) Classification

A small "x" indicates the inability to show that particular part in the Photo or Illustration.

This number corresponds with the individual parts index number in that figure

This number corresponds with the Figure Number

6. SYS. CON. P C BOARD BLOCK

REF. NO.	PART NO.	DESCRIPTION
6-1	BA-T2034A070A	PC SYS CON BLK GX-F44R
6-1C1	EI-324536	IC HD14049BP
6-1C2	EI-336801	IC MB8841-564M
6-1C3	EI-331661	IC SN7405N
6-1C4	EI-336725	IC M54527P
6-1R1to4	ET-200985	TR 2SC2603 F,G
6-1R5to28	ET-554657	TR 2SA733A P,Q
6-D1	ED-318292	D SILICON H 1S2473T-77 T26
6-D2to4	ED-308952	D GERMA V 1K34A-LR F07
6-D5to10	ED-318292	D SILICON H 1S2473T-77 T26
6-X1	EI-318384	OSC X'TAL NC-18C 3.579545MHZ

SP (Service Parts) Classification

These reference symbols correspond with component symbols in the Schematic Diagrams.

5. The kind of part and its installation position can both be determined by the Part Number. To determine where a part number is listed, utilize the Parts Index at the end of the Parts List. It is necessary first of all to find the Part Number. This can be accomplished by using the Reference Number listed at the right of the part number in the Parts Index.

WARNING

▲ INDICATES SAFETY CRITICAL COMPONENTS. FOR CONTINUED SAFETY, REPLACE SAFETY CRITICAL COMPONENTS ONLY WITH MANUFACTURE'S RECOMMENDED PARTS

AVERTISSEMENT

▲ IL INDIQUE LES COMPOSANTS CRITIQUES DE SÉCURITÉ. POUR MAINTENIR LE DEGRÉ DE SÉCURITÉ DE L'APPAREIL, NE REMPLACER QUE DES PIÈCES RECOMMANDÉES PAR LE FABRICANT

RECOMMENDED SPARE PARTS

Because, if the parts listed below are on hand, almost any repair can be accomplished, we suggest that you stock these Recommended Spare Parts Items.

REF. NO.	PART NO.	DESCRIPTION
1 N	BT-358519	△ TRANS POWER AM-A201-20(A) [A]
2 N	BT-358518	△ TRANS POWER AM-A201-30(C) [C]
3 N	BT-358520	△ TRANS POWER AM-A201-40(E,V) [E,V]
4 N	BT-358521	△ TRANS POWER AM-A201-50(B,S) [B,S]
5 N	BT-358517	△ TRANS POWER AM-A201-70(U) [U]
6	ED-355605	D LED AY5525S AMBER
7	ED-356424	D LED BG5525S GREEN
8	ED-356421	D LED BR5505S RED
9	ED-350748	D SILICON DBA60C-K15
10	ED-301911	D SILICON H DS448
11	ED-348205	D SILICON V MC931 DOUBLE
12	ED-360320	D ZENER H HZ15 2
13	ED-329056	D ZENER H HZ22 2
14 N	EF-359007	△ FUSE BET T 1.25A 250V [B]
15 N	EF-359225	△ FUSE BET T 3.15A 250V [B]
16	EF-602550	△ FUSE SEMKO T 1.25A 250V [E,V,S]
17	EF-691007	△ FUSE SEMKO T 3.15A 250V [E,V,S]
18	EF-326639	△ FUSE TSC A 250V 3.15A [U]
19	EF-306952	△ FUSE TSC A 250V 4.00A [U]
20	EF-323080	△ FUSE TSC 125V 3.15A [C,A]
21	EF-306957	△ FUSE TSC 125V 4.00A [C,A]
22 N	EI-358554	△ IC STK4152-2
23	EI-337228	IC M5218L0
24	EI-344764	IC M5218P-21
25	ER-318647	△ R FUSE ERD2FC S10 1/4W 4R7J
26	ER-328278	△ R FUSE ERD2FC 1/4W 10R0G
27	ER-200746	△ R FUSE ERD2FC 1/4W 1000G
28	ES-349070	△ SW SELECTOR YKS11-0002 02-4 [U]
29 N	ES-358556	SW PUSH ESB-621519 2 THROW
30 N	ES-358555	SW PUSH ESB-62672 2-02-02S
31 N	ES-358537	SW PUSH ESB-62968 4THROW
32	ES-337902	SW PUSH SDDL1P002 01-1
33	ET-322598	TR 2SB632K E,F
34	ET-310148	TR 2SD612K E,F
35 N	EV-358539	VR SLIDE 25P1SV0F W105
36 N	EV-358541	VR SLIDE 25P2SV C104
37 N	EV-358563	VR SLIDE 60P2SV0M B254

"NOTE" N: New Parts

SYMBOL FOR DESTINATION

[A]	: AAL (USA)
[B]	: UK (England)
[C]	: CSA (Canada)
[E]	: CEE (Europe)
[S]	: SAA (Australia)
[U]	: U/T (Universal Area)
[V]	: VDE (West Germany)

1. PC BOARD BLOCK

REF. NO.	PART NO.	DESCRIPTION
1-1A	BA-A2040A020A	PC MAIN BLK AM-A201(U)
1-1B	BA-A2040A020B	PC MAIN BLK AM-A201(C,A)
1-1C	BA-A2040A020C	PC MAIN BLK AM-A201(E,B,S)
1-1D	BA-A2040A020D	PC MAIN BLK AM-A201(V)
1-2A	BA-A2040A030A	PC CONTROL BLK AM-A201(U)
1-2B	BA-A2040A030B	PC CONTROL BLK AM-A201(C,A)
1-2C	BA-A2040A030C	PC CONTROL BLK AM-A201(E,B,S)
1-2D	BA-A2040A030D	PC CONTROL BLK AM-A201(V)

NOTES:

- (1) PC MAIN BLK consists of following PC BOARDS.
 - MAIN AMP PC BOARD
 - SPEAKER TERMINAL PC BOARD
 - HEAD PHONE PC BOARD
 - FILTER PC BOARD
- (2) PC CONTROL BLK consists of following PC BOARDS.
 - CONTROL PC BOARD
 - FUNCTION PC BOARD
 - EQUALIZER PC BOARD
 - TAPE PC BOARD
 - POWER SUPPLY PC BOARD

2. MAIN AMP PC BOARD

REF. NO.	PART NO.	DESCRIPTION
MAIN AMP PC BOARD		
2-TR1	ET-310148	△ TR 2SD612K E,F
2-TR2	ET-322598	△ TR 2SB632K E,F
2-D1	ED-301911	△ D SILICON H DS448
2-D2	ED-329056	△ D ZENER H HZ22 2
2-D3,D4	ED-360320	△ D ZENER H HZ15 2
2-D5	ED-350748	△ D SILICON DBA60C-K15
2-SW1	ES-358555	SW PUSH ESB-62672 2-02-02S
2-SW2	ES-358556	SW PUSH ESB-621519 2 THROW
2-L1	EO-337880	COIL FIX 2 202AK-018 2R2K
2-FR1	ER-328278	△ R FUSE ERD2FC 1/4W 10R0G
2-FR2	ER-200746	△ R RUSE ERD2FC 1/4W 1000G
2-FR3, FR4	ER-318647	△ R FUSE ERD2FC S10 1/4W 4R7J
2-R7	ER-325269	△ R CB H S10 FS RDS 1/4W 222J
2-R9	ER-333355	△ R CB H S10 FS RDS 1/4W 103J
2-R10, R11	ER-341940	△ R OMF H SNP FS 1W 100J
2-R12	ER-308028	△ R OMF H S15 FS 1W 181J
2-R15	ER-328082	△ R CB H S10 FS RDS 1/4W 332J
2-R16	ER-353214	R CB H RD 1/2W 103J
2-R17	ER-328082	△ R CB H S10 FS RDS 1/4W 332J
2-R18	ER-323074	△ R CB H S10 FS RDS 1/4W 102J
2-R19	ER-355633	△ R OMF H S15 FS 1W 331J
2-R20	ER-353214	R CB H RD 1/2W 103J
2-R21	ER-328082	△ R CB H S10 FS RDS 1/4W 332J
2-R22	ER-323074	△ R CB H S10 FS RDS 1/4W 102J
2-C13	EC-358538	C EC V CUT 472M 45.0DC
2-C16	EC-358538	C EC V CUT 472M 45.0DC
2-C19	EC-326583	CMMY V CUT CF921 473K 400DC

ASSEMBLY BLOCK

2-F3A	EF-306952	△ FUSE TSC A 250V 4.00A [U]
2-F3B	EF-306957	△ FUSE TSC 125V 4.00A [C,A]
2-F3C	EF-691107	△ FUSE SEMKO T 3.15A 250V [E,V,S]
2-F3D	EF-359225	△ FUSE BET T 3.15A 250V
2-F4A	EF-306952	△ FUSE TSC A 250V 4.00A [U]
2-F4B	EF-306957	△ FUSE TSC 125V 4.00A [C,A]
2-F4C	EF-691107	△ FUSE SEMKO T 3.15A 250V [E,V,S]
2-F4D	EF-359225	△ FUSE BET T 3.15A 250V [B]

3. CONTROL PC BOARD

REF. NO.	PART NO.	DESCRIPTION
3-IC1	EI-337228	IC M5218L0
3-D1 to D3	ED-356424	D LED BG5525S GREEN
3-D4	ED-355605	D LED AY5525S AMBER
3-D5	ED-356421	D LED BR5505S RED
3-D6	ED-348205	D SILICON V MC931 DOUBLE
3-VR1	EV-358539	VR SLIDE 25P1SVOF W105
3-VR2	EV-358563	VR SLIDE 60P2SVOM B254
3-VR3, VR4	EV-358541	VR SLIDE 25P2SV C104
3-R15 R16	ER-333598	△ R CB H S15 FS RDS 1/2W 102J

4. FUNCTION PC BOARD

REF. NO.	PART NO.	DESCRIPTION
4-SW1	ES-358537	SW PUSH ESB-62968 4THROW

5. EQUALIZER PC BOARD

REF. NO.	PART NO.	DESCRIPTION
5-IC1	EI-344764	IC M5218P-21
5-L1	EO-338420	COIL FIX 2 FLJ2R202E 202K [V]
5-L2,L3	EO-336934	COIL FIX 1 LAL03KH 2R2M [V]
5-R7	ER-355214	△ R OMF H S15 FS RSM 2W 151J
5-J1	EJ-336904	PIN J AJC-036-ACB P 6P

6. TAPE PC BOARD

REF. NO.	PART NO.	DESCRIPTION
6-L1 to L6	EO-336934	COIL FIX 1 LAL03KH 2R2M [V]
6-J1,J2	EJ-343365	PIN J YMC21-0063 P 4P

7. SPEAKER TERMINAL PC BOARD

REF. NO.	PART NO.	DESCRIPTION
7-L1	EO-342936	COIL BALUN [V]
7-TM902	EJ-349401	TERMINAL LEVER YKD21-0027 8P

8. HEAD PHONE PC BOARD

REF. NO.	PART NO.	DESCRIPTION
8-L1	EO-336934	COIL FIX 1 LAL03KH 2R2M [V]
8-J1	EJ-358535	PHONE J 3P M1669-ACCB 6.3

9. POWER SUPPLY PC BOARD

REF. NO.	PART NO.	DESCRIPTION
POWER SUPPLY PC BOARD		
9-SW1	ES-337902	△ SW PUSH SDDL1P002 01-1
9-C1A	EC-320548	△ C CE V F 103Z 250AC [U]
9-C1B	EC-338411	△ C EC V FZ 103P 400AC [C,A]
9-C1C	EC-338496	△ C CE V FZ 472P 400AC [E,V,B,S]

ASSEMBLY BLOCK

9-F1A	EF-326639	△ FUSE TSC A 250V 3.15A [U]
9-F1B	EF-323080	△ FUSE TSC 125V 3.15A [C,A]
9-F1C	EF-602550	△ FUSE SEMKO T 1.25A 250V [E,V,S]
9-F1D	EF-359007	△ FUSE BET T 1.25A 250V [B]
9-F2	EF-326639	△ FUSE TSC A 250V 3.15A [U]

10. FILTER PC BOARD

REF. NO.	PART NO.	DESCRIPTION
10-L1	EO-338409	COIL LF FKOB160MH02 250UH [V]

ASSEMBLY BLOCK

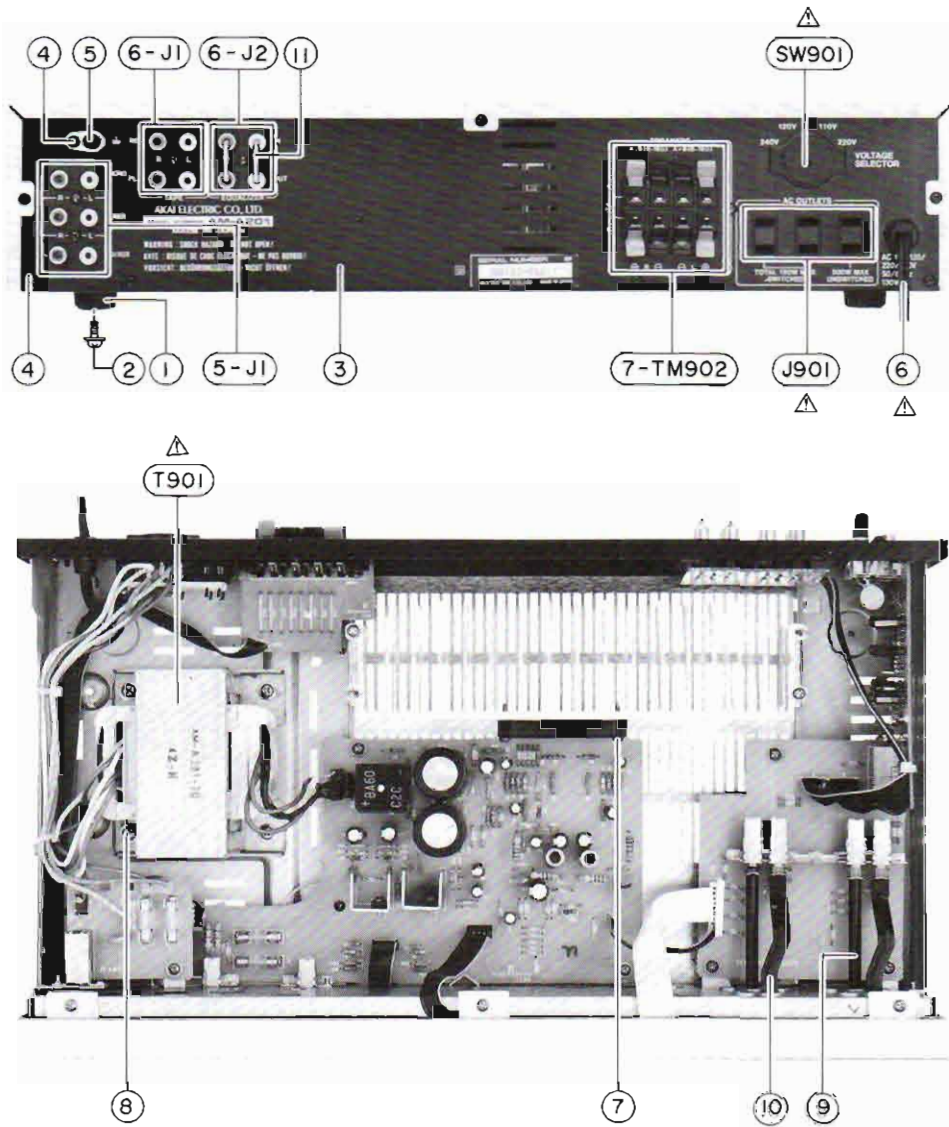

11. ASSEMBLY BLOCK

REF. NO.	PART NO.	DESCRIPTION			
		ASSEMBLY BLOCK			
11-1	SA-332850	ROUND FOOT		11-6G	EW-354514 AC CORD 2 CORES KP-560, LTSA2F-CB S [S]
11-2	ZS-331567	T2BR30x08STL CMT C080		11-7	ZS-321279 T2BR30x18STL CMT
11-3A	SP-358485E	PANEL REAE AM-A201(U)		11-8	ZS-346742 ST BID40x08STL CMT CUP
11-3B	SP-358485F	PANEL REAR AM-A201(C,A)		11-9	TA-358475 JOINT(A)
11-3C	SP-358485G	PANEL REAR AM-A201(E)		11-10	TA-358473B JOINT (B)-2
11-3D	SP-358485N	PANEL REAR AM-A201(V)		11-11	EJ-348218 PLUG SHORT PIN P2138
11-3E	SP-358485H	PANEL REAR AM-A201(B,S)		11-T901ABT-358517	△ TRANS POWER AM-A201-70 (U)
11-4	ZS-308846	T2BR30x08STL BZN PROJECTION		11-T901BBT-358518	△ TRANS POWER AM-A201-30(C)
11-5	IJ-329610	TERMINAL W/SCREW UB-0067 L 1P		11-T901CBT-358519	△ TRANS POWR AM-A201-20(A)
11-6A	EW-354515	△ AC CORD 2 CORES KP-700A, VFF-CB U/T [U]		11-T901DBT-358520	△ TRANS POWER AM-A201-40(E,V)
11-6B	EW-358513	△ AC CORD 2 CORES KD-8W, SPT-2-CB UC [C]		11-T901EBT-358521	△ TRANS POWER AM-A201-50(B,S)
11-6C	EW-358515	△ AC CORD 2 CORES KP-8W, SPT-1-CB UC [A]		11-J901A	△ SOCKET OUTLET S2T733T164 JUC 3x2P [U]
11-6D	EW-354625	△ AC CORD 2 CORES KP-419C, LTCE-2F E [E]		11-J901B	△ SOCKET OUTLET S2T733T114T [C,A]
11-6E	EW-354513	△ AC CORD 2 CORES KP-419C, LTCE-2F EV [V]		11-SW901	△ SW SELECTOR YKS11-0002 02-4 [U]
11-6F	EW-354512	△ AC CORD 2 CORES LTBS-2F-CB B [B]			EQUALIZER PC BOARD
				5-J1	EJ-336904 PIN J AJC-36 ACB P 6P
					TAPE PC BOARD
				6-J1,J2	EJ-343365 PIN J YMC21-0063 P 4P
					SPEAKER TERMINAL PC BOARD
				7-TM902	EJ-349401 TERMINAL LEVER YKD21-0027 8P

FINAL ASSEMBLY BLOCK

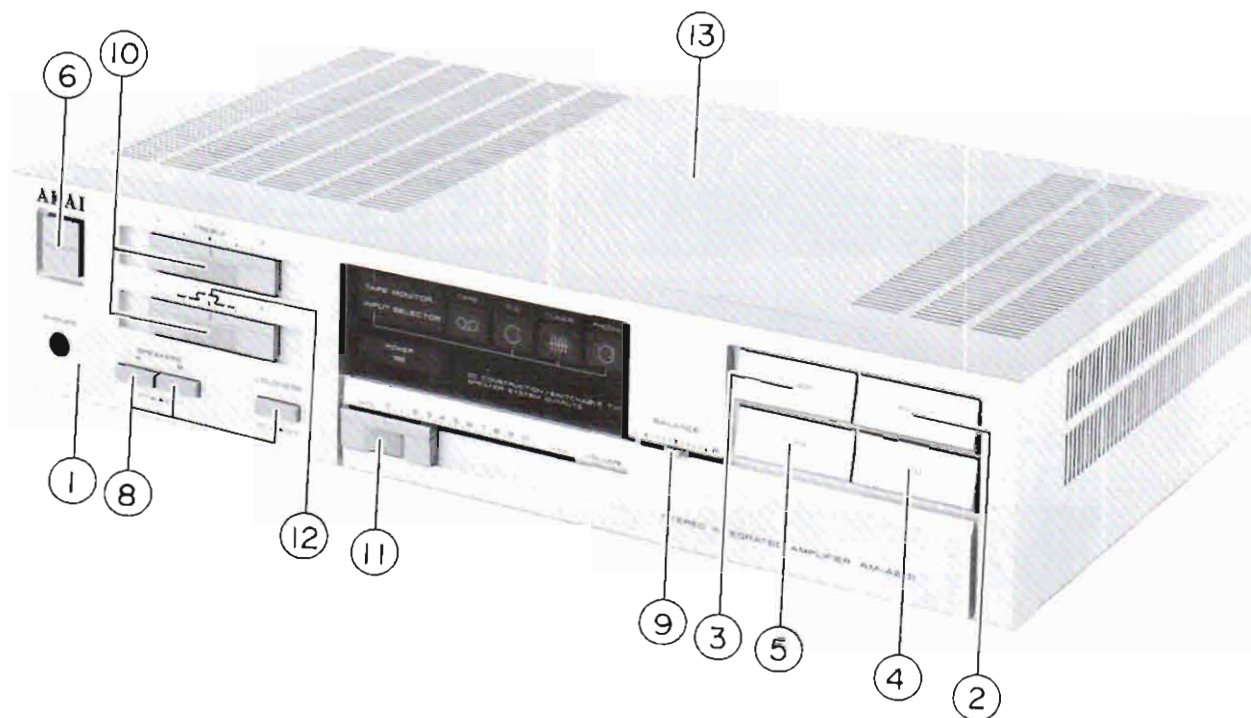

12. FINAL ASSEMBLY BLOCK

REF.

NO. PART NO. DESCRIPTION

12-1	BD-A2040A040A	PANEL FRONT BLK AM-A201
12-1B	BD-A2040A040B	PANFL FRONT BLK AM-A201-B
12-2	SK-358482E	KNOB (A) PHONO
12-2B	SK-358482A	KNOB (A)-B PHONO
12-3	SK-358482F	KNOB (A) TUNER
12-3B	SK-358482B	KNOB (A)-B TUNER
12-4	SK-358482G	KNOB (A) CD/AUX
12-4B	SK-358482C	KNOB (A)-B CD/AUX
12-5	SK-358482H	KNOB (A) TAPE
12-5B	SK-358482D	KNOB (A)-B TAPE
12-6	SK-343017C	KNOB POWER (2)
12-6B	SK-343017F	KNOB POWER -B

FINAL ASSEMBLY BLOCK

12-7x	ZS-498273	T2BR30x08STL CMT PW080 [PANEL FRONT FIX]
12-8	SK-358479B	KNOB (F-2)
12-8B	SK-358479A	KNOB (F-1)
12-9	SK-358477B	KNOB (C-2)
12-9B	SK-358477A	KNOB (C-1)
12-10	SK-358480B	KNOB (E-2)
12-10B	SK-358480A	KNOB (E-1)
12-11	SK-358474B	KNOB (D-2)
12-11B	SK-358474A	KNOB (D-1)
12-12	ZG-360943	SP TONE
12-13	SP-349925A	COVER UPPER
12-13B	SP-349925C	COVER UPPER-B

NOTE:

PANEL FRONT BLK consists of 12-2 to 12-6B.

SYMBOL FOR COLOR VARIATION

NON: STANDARD COLOR

B or BL: BLACK

INDEX

PART NO.	REF. NO.	PART NO.	REF. NO.	PART NO.	REF. NO.	PART NO.	REF. NO.	PART NO.	REF. NO.
BA-A2040A020A	1-1A	ER-328082	2-R17						
BA-A2040A020B	1-1B	ER-328082	2-R21						
BA-A2040A020C	1-1C	ER-328278	2-FR1						
BA-A2040A020D	1-1D	ER-333355	2-R9						
BA-A2040A030A	1-2A	ER-333598	3-R15						
BA-A2040A030B	1-2B	ER-333598	3-R16						
BA-A2040A030C	1-2C	ER-341940	2-R10						
BA-A2040A030D	1-2D	ER-341940	2-R11						
BD-A2040A040A	12-1	ER-353214	2-R16						
BD-A2040A040B	12-1B	ER-353214	2-R20						
BT-358517	11- T901A	ER-355214	5-R7						
BT-358518	11- T901B	ER-355633	2-R19						
BT-358519	11- T901C	ES-337902	9-SW1						
BT-358520	11- T901D	ES-349070	11- SW901						
BT-358521	11- T-901E	ES-358537	4-SW1						
		ES-358555	2-SW1						
		ES-358556	2-SW2						
		ET-310148	2-TR1						
		ET-322598	2-TR2						
EC-320548	9-C1A	EV-358539	3-VR1						
EC-326583	2-C19	EV-358541	3-VR3						
EC-338411	9-C1B	EV-358541	3-VR4						
EC-338496	9-C1C	EV-358563	3-VR2						
EC-358538	2-C13	EW-354512	1-6F						
EC-358538	2-C16	EW-354513	11-6E						
ED-301911	2-D1	EW-354514	11-6G						
ED-306320	2-D3	EW-354515	11-6A						
ED-306320	2-D4	EW-354625	11-6D						
ED-329056	2-D2	EW-358513	11-6B						
ED-348205	3-D6	EW-358515	11-6C						
ED-350748	2-D5	SA-332850	11-1						
ED-355605	3-D4	SK-343017C	12-6						
ED-356421	3-D5	SK-343017F	12-6B						
ED-356424	3-D1	SK-358474A	12-11B						
	to D3	SK-358474B	12-11						
EF-306952	2-F3A	SK-358477A	12-9B						
EF-306952	2-F4A	SK-358477B	12-9						
EF-306957	2-F3B	SK-358479A	12-8B						
EF-306957	2-F4B	SK-358479B	12-8						
EF-323080	9-F1B	SK-358480A	12-10B						
EF-326639	9-F1A	SK-358480B	12-10						
EF-326639	9-F2	SK-358482A	12-2B						
EF-359007	9-F1D	SK-358482B	12-3B						
EF-359225	2-F3D	SK-358482C	12-4B						
EF-359225	2-F4D	SK-358482D	12-5B						
EF-602550	9-F1C	SK-358482E	12-2						
EF-691007	2-F3C	SK-358482F	12-3						
EF-691007	2-F4C	SK-358482G	12-4						
EI-337228	3-IC1	SK-358482H	12-5						
EI-344764	5-IC1	SP-349925A	12-13						
EJ-329610	11-5	SP-349925C	12-13B						
EJ-336904	5-J1	SP-358485E	11-3A						
EJ-337405	11- J901A	SP-358485F	11-3B						
		SP-358485G	11-3C						
EJ-343365	6-J1	SP-358485H	11-3E						
EJ-343365	6-J2	SP-358485N	11-3D						
EJ-348218	11-11	TA-358473B	11-10						
EJ-349401	7-TM902	TA-358475	11-9						
EJ-352642	11- J901B	ZG-360943	12-12						
		ZS-308846	11-4						
EJ-358535	8-J1	ZS-321279	11-7						
EO-336934	5-L2	ZS-331567	11-2						
EO-336934	5-L3	ZS-346742	11-8						
EO-336934	6-L1 to L6	ZS-498273	12-7x						
EO-338409	10-11								
EO-338420	5-L1								
EO-342936	7-L1								
ER-200746	2-FR2								
ER-308028	2-R12								
ER-318647	2-FR3								
ER-318647	2-FR4								
ER-323074	2-R18								
ER-323074	2-R22								
ER-325269	2-R7								
ER-328082	2-R15								

AKAI

MODEL AM-A201

SCHEMATIC DIAGRAM AND PC BOARD

TABLE OF CONTENTS

1. IC'S STK4151II	1
2. AM-A201 SCHEMATIC DIAGRAM	2
3. CONTROL PCB, HEAD PHONE PCB, MAIN AMP PCB, POWER SUPPLY PCB, SPEAKER TERMINAL PCB	3
4. EQUALIZER PCB, FUNCTION PCB, TAPE PCB	4

STK4151II

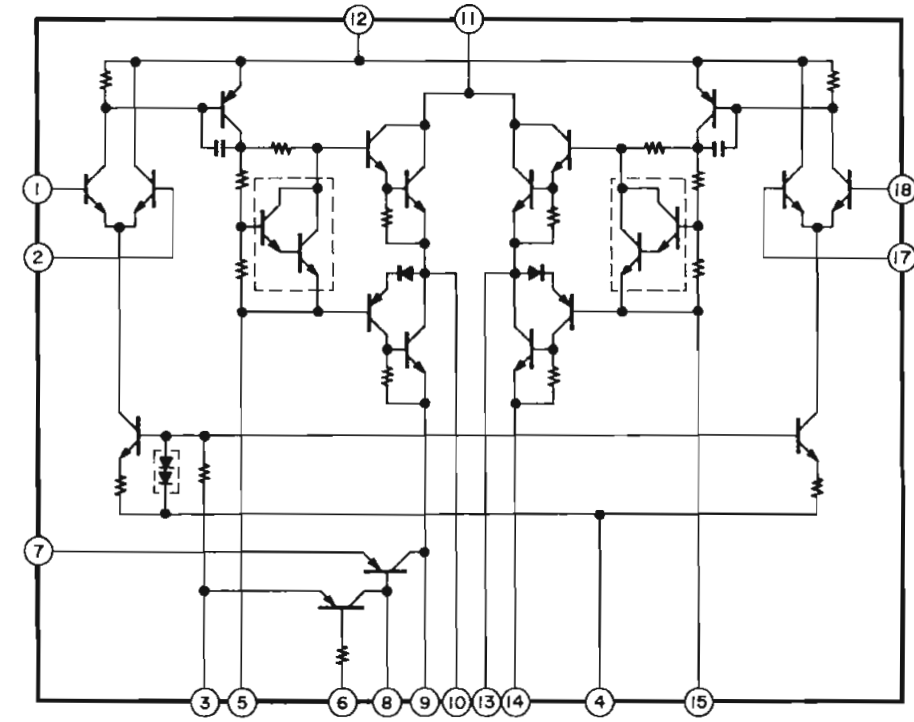

MODEL

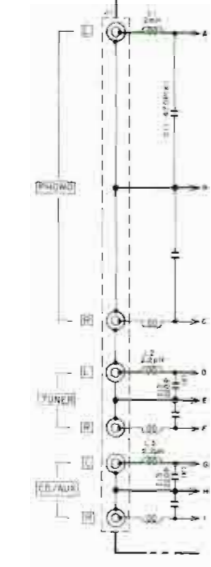

MODEL

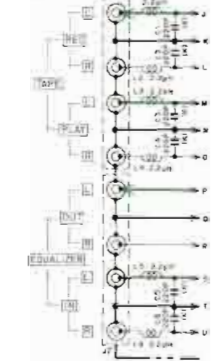

MODEL

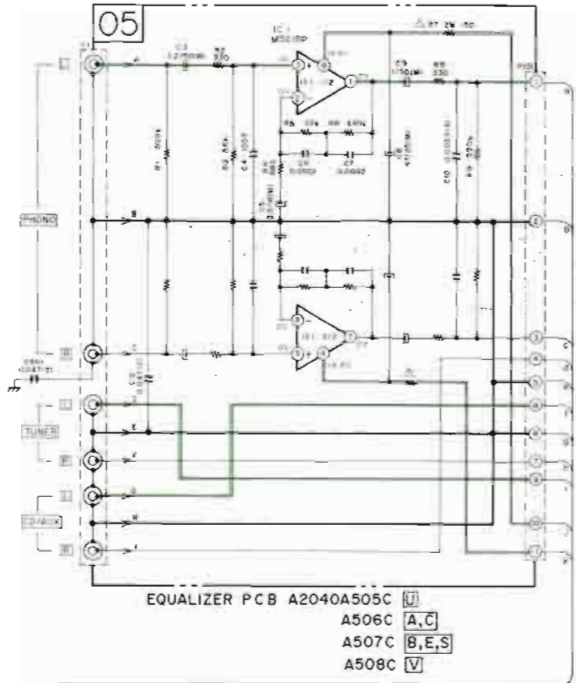
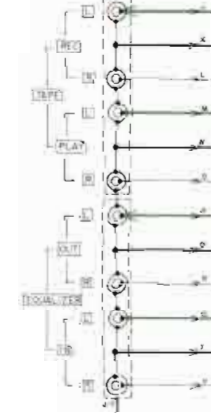

EQUALIZER PCB A2040A505C
A506C A,C
A507C B,E,S
A508C V

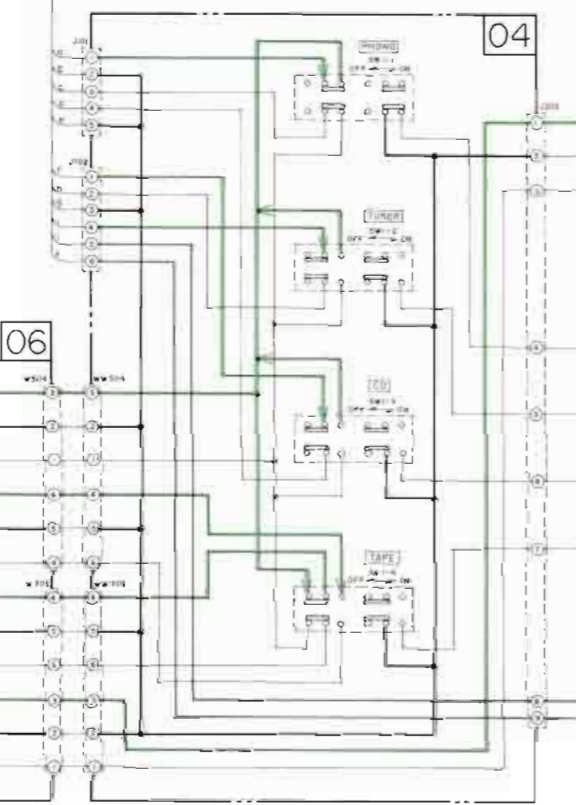

TAPE PCB A2040A505D
A506D A,C
A507D B,E,S
A508D V

FUNCTION PCB A2040A505B
A506B A,C
A507B B,E,S
A508B V

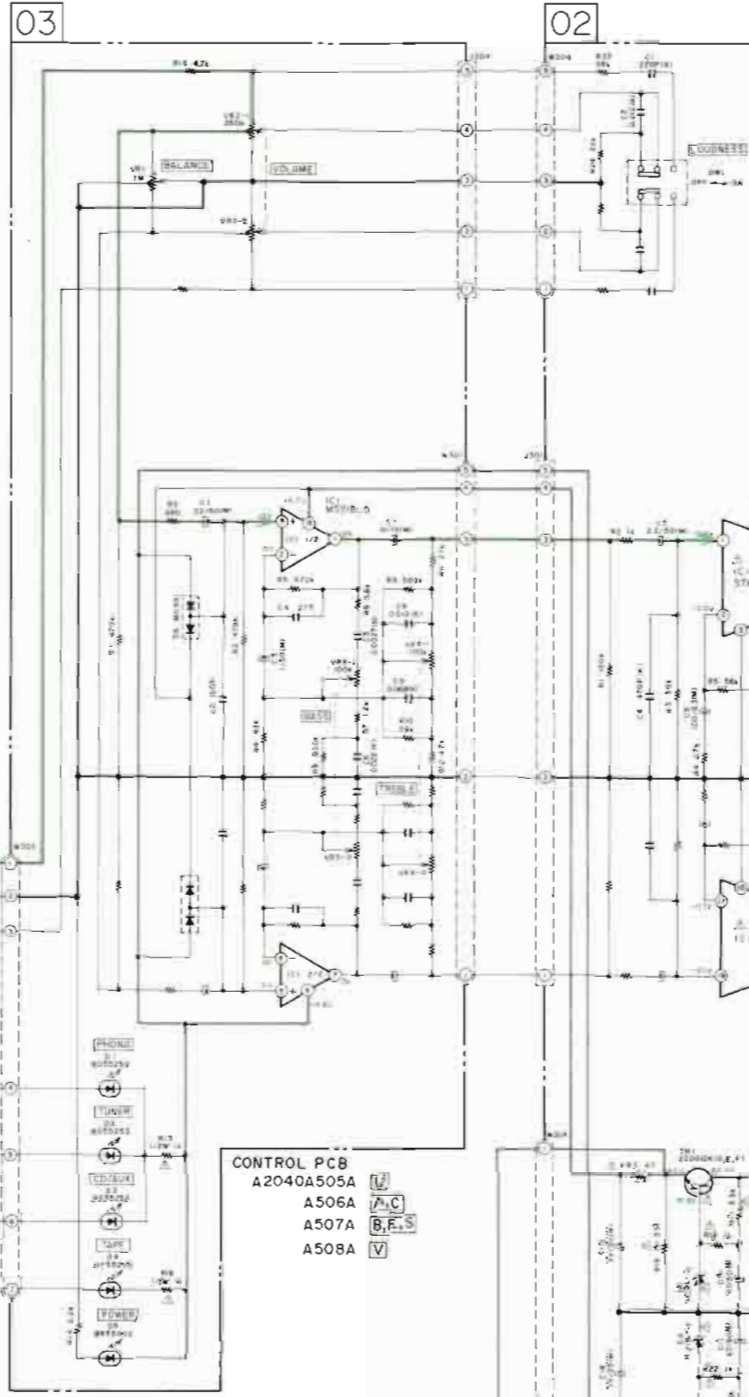

CONTROL PCB A2040A505A
A506A A,C
A507A B,E,S
A508A V

MAIN AMP PCB A2040A501A
A502A A,C
A503A B,E,S
A504A V

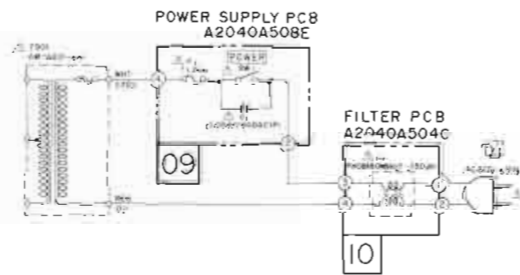

POWER SUPPLY PCB A2040A508E

FILTER PCB A2040A504C

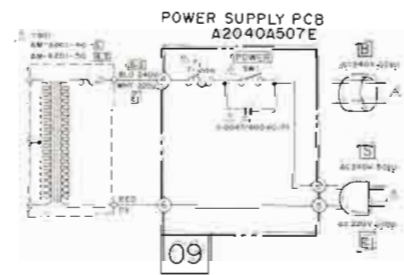

POWER SUPPLY PCB A2040A507E

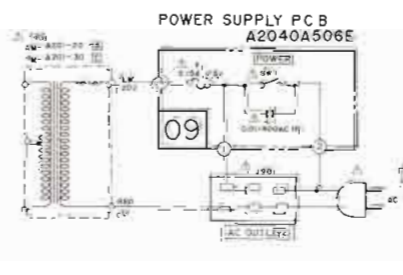

POWER SUPPLY PCB A2040A506E

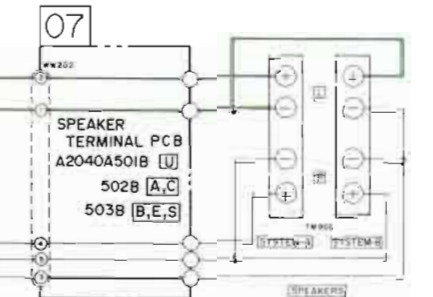

SPEAKER TERMINAL PCB A2040A501B
502B A,C
503B B,E,S

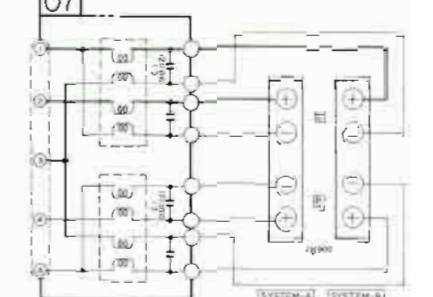

SPEAKER TERMINAL PCB A2040A504B

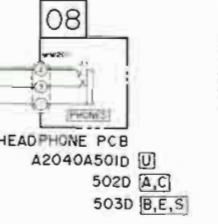

HEADPHONE PCB A2040A501D
502D A,C
503D B,E,S

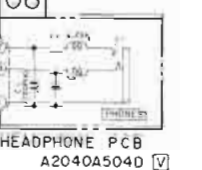

HEADPHONE PCB A2040A504D

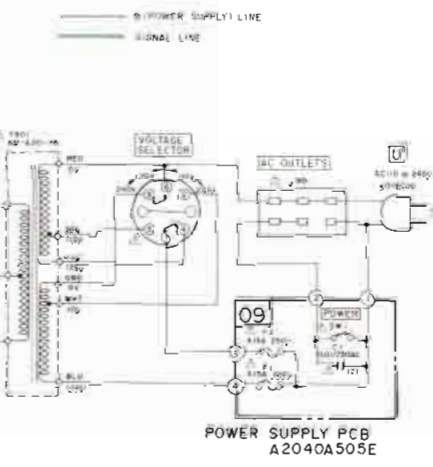

POWER SUPPLY PCB A2040A505E

NOTE: UNLESS OTHERWISE SPECIFIED:
ALL RESISTORS IN OHMS (R, K, M, Ω)
ALL CAPACITORS IN μF (μ, M, P, N, F)
POWER TRANSFORMER IS IDENTIFIED
ACCORDING TO APPR.

AM-A201
SCHEMATIC DIAGRAM
NO. 850510A

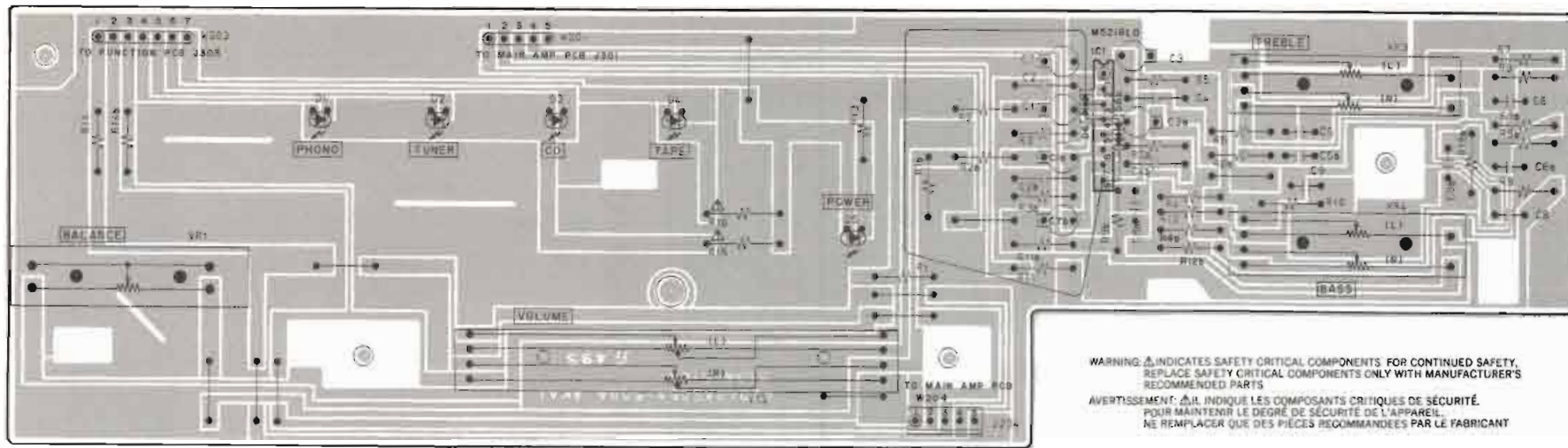

CONTROL PCB A2040A505A U
 506A C.A
 507A E.B.S
 508A V

WARNING: Δ INDICATES SAFETY CRITICAL COMPONENTS FOR CONTINUED SAFETY. REPLACE SAFETY CRITICAL COMPONENTS ONLY WITH MANUFACTURER'S RECOMMENDED PARTS.
 AVERTISSEMENT: Δ IL INDIQUE LES COMPOSANTS CRITIQUES DE SÉCURITÉ. POUR MAINTENIR LE DEGRÉ DE SÉCURITÉ DE L'APPAREIL, NE REMPLACER QUE DES PIÈCES RECOMMANDÉES PAR LE FABRICANT.

SPEAKER TERMINAL PCB A2040A501B U
 502B C.A
 503B E.B.S

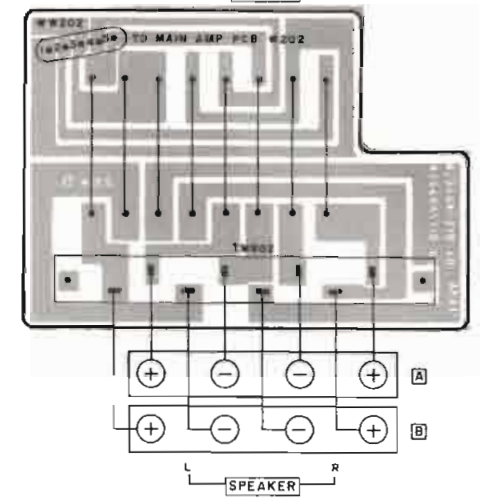

SPEAKER TERMINAL PCB A2040A504B V

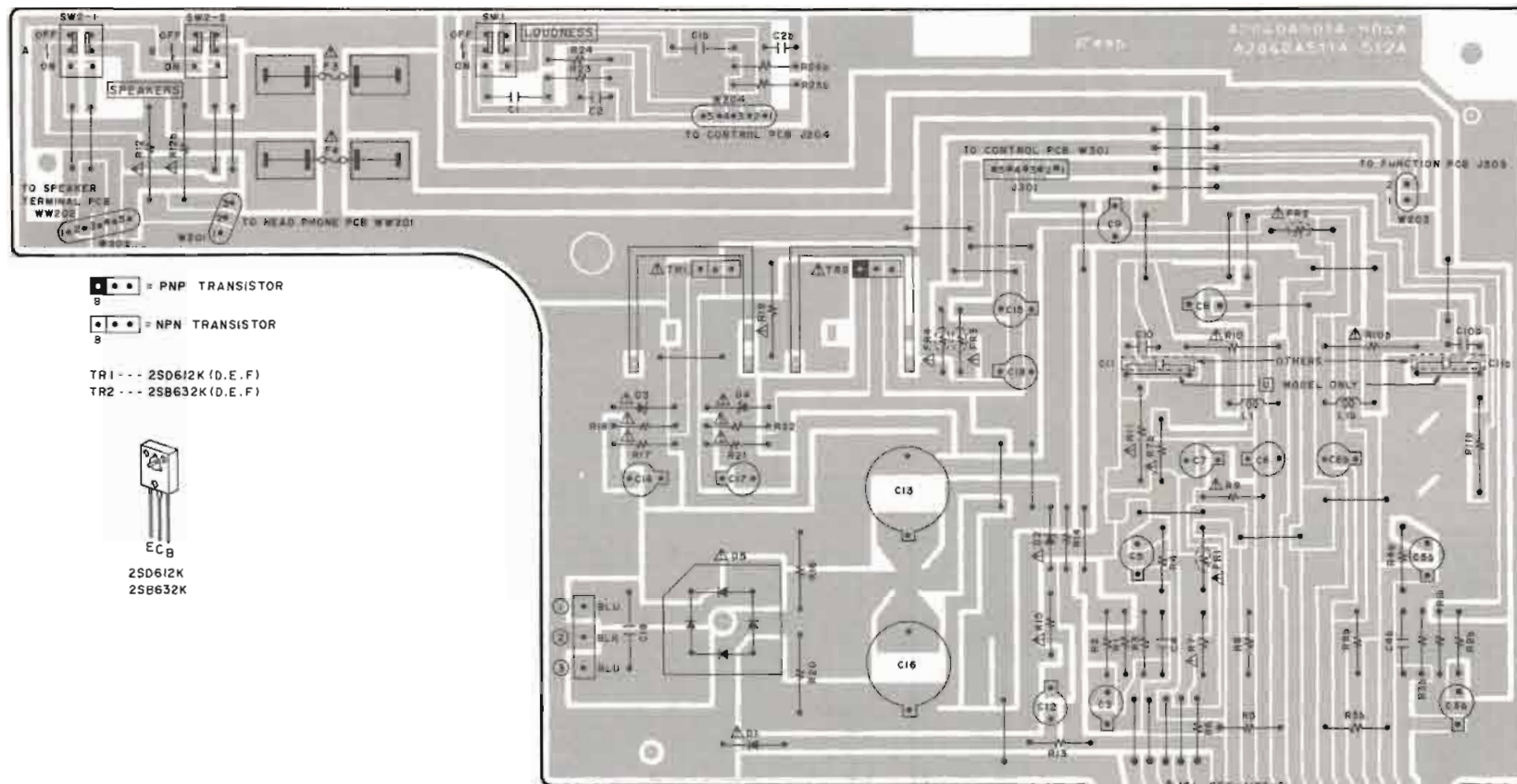
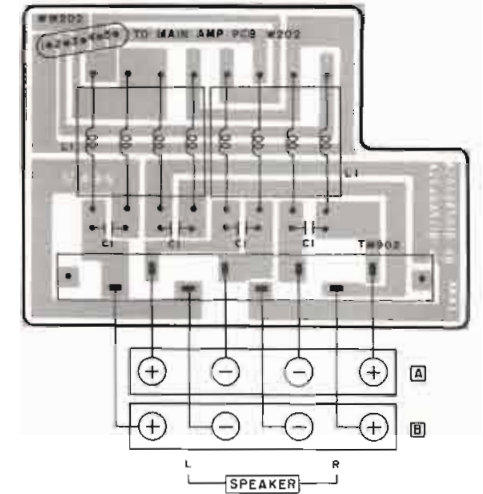

MAIN AMP PCB A2040A501A U
 502A C.A
 503A E.B.S
 504A V

Δ = PNP TRANSISTOR
 \square = NPN TRANSISTOR
 TR1 --- 2SD612K (D.E.F)
 TR2 --- 2SB632K (D.E.F)



HEADPHONE PCB A2040A501D U
 502D C.A
 503D E.B.S
 504D V

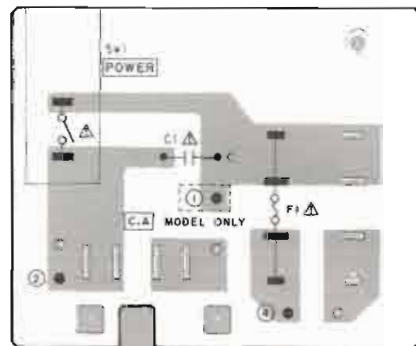

POWER SUPPLY PCB A2040A506E C.A
 508E V

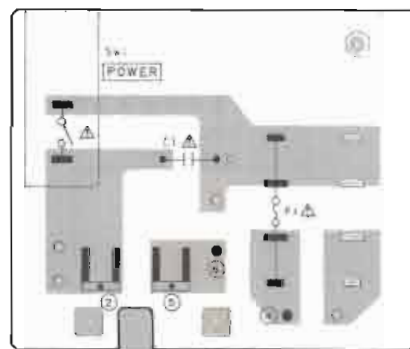

POWER SUPPLY PCB A2040A507E E.B.S

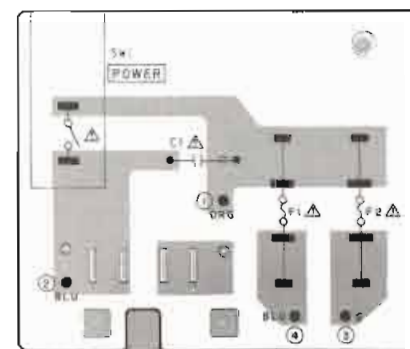

POWER SUPPLY PCB A2040A505E U

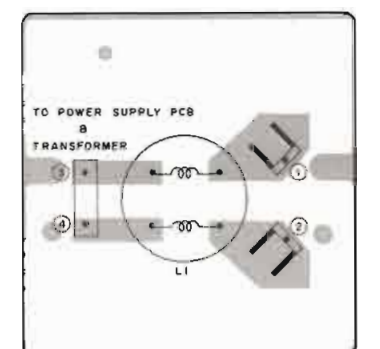

POWER SUPPLY PCB A2040A504C V MODEL ONLY

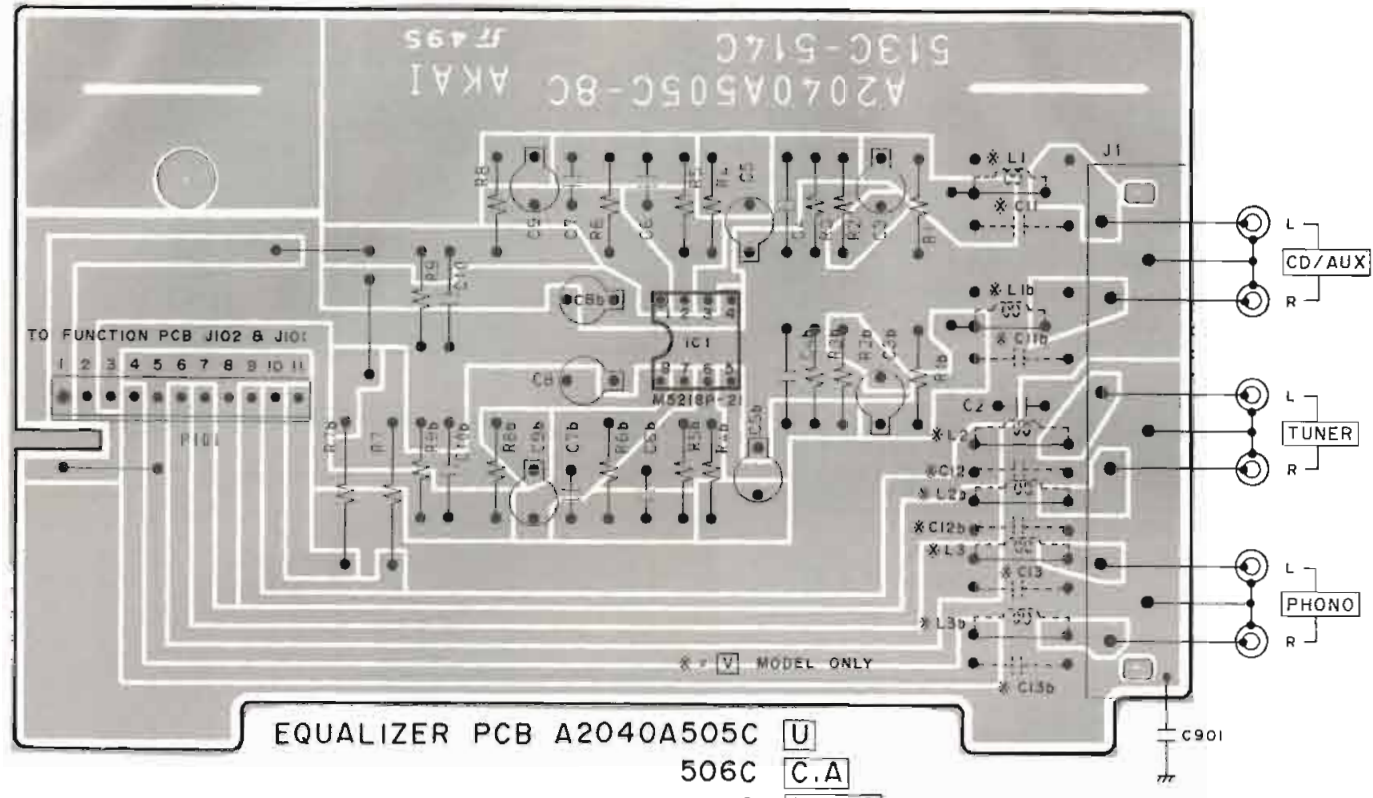

EQUALIZER PCB A2040A505C

U
506C C.A
507C E.B.S
508C V

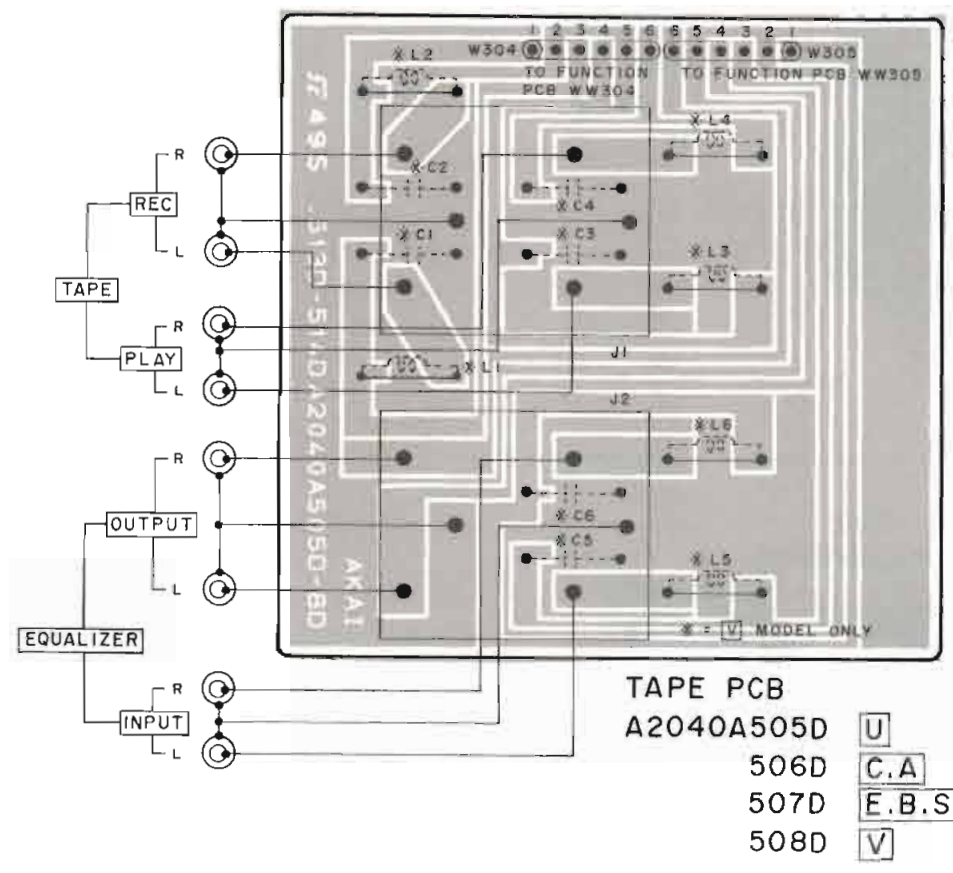

TAPE PCB A2040A505D

U
506D C.A
507D E.B.S
508D V

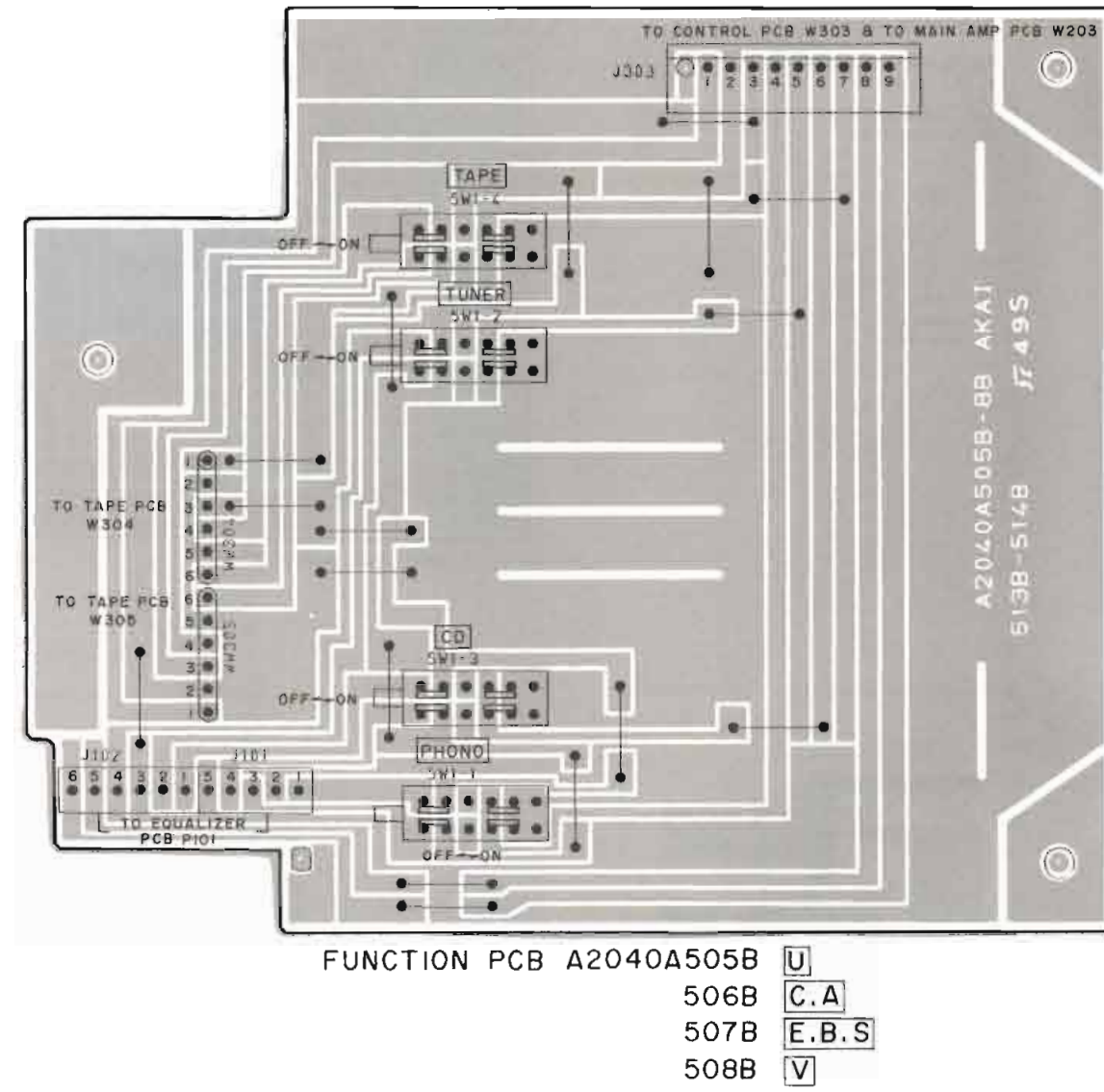

FUNCTION PCB A2040A505B

U
506B C.A
507B E.B.S
508B V

AKAI ELECTRIC CO., LTD.

12-14, 2-Chome, Higashi-Kojima, Ohta-Ku, Tokyo, Japan

TEL Tokyo (742) 5111 CABLE HIFIAKAI TOKYO TELEX J26261

Printed No. 850522-K1-3000

Printed Date June 12, 1985

350 Printed in Japan