

# AIWA®

S/M Code No. 83-001  
DATE OF ISSUE 1/1983

# SERVICE MANUAL

---

TYPE. H, HU, E, G

STEREO INTEGRATED  
AMPLIFIER

MODEL NO. **MX-70**

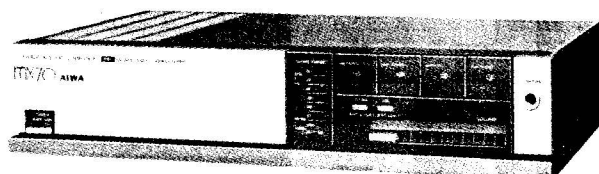

STEREO TUNER

MODEL NO. **TX-70**



Shown above is TX-70H

STEREO CASSETTE  
DECK

MODEL NO. **FX-70**



**SPECIFICATIONS = MX-70**

**Type:** Stereo integrated amplifier  
**Semiconductors:** 8 ICs, 26 transistors, 40 diodes, 13 LEDs  
**Power source:** H, HU, E model  
 AC 120/220/240V switchable, 50/60 Hz  
 G model  
 AC 240V, 50/60 Hz  
**Power consumption:** H, HU model  
 65W  
 E, G model  
 160W  
**Dimensions:** 330(W) x 71(H) x 200(D) mm  
 (12-7/8" x 2-5/8" x 7 7/8")  
**Weight:** 3.65 kg (8.04lbs.)  
 < Power amplifier >  
**Effective output power:** H,HU models  
 45W + 45W (8Ω, EIAJ 5% 1kHz)  
 E, G model  
 30W + 30W (8Ω, T.H.D. 0.05%, 40 Hz ~ 20 kHz)  
 < FTC Rule >  
 35 Watts per channel, Min. RMS at 8 ohms, from 30 Hz ~ 20 kHz, with no more than 0.2% Total Harmonic Distortion.  
**Total harmonic distortion:** Less than 0.03% (1kHz, 30W)  
**Output bandwidth:** 30 Hz to 50,000 Hz (Less than 0.5%)  
 [Both channels driven, 8 Ω]  
**Frequency response:** 40 Hz to 70,000 Hz (+0.5, -3 dB)

**Residual noise:** Less than AUX 2mV  
**Damping factor:** Less than 40  
 (1 kHz 8 Ω)  
 < Preamplifier >  
**Signal to noise ratio:** (Weighted)  
 PHONO (MM) More than 79 dB  
 TUNER, AUX More than 87 dB  
 TAPE More than 87 dB  
 (IHF A curve, short circuit)  
**Tone controls:**  
 BASS 100 Hz -10.0 ± 1.2 dB  
 +11.7 ± 1.2 dB  
 TREBLE 10 kHz -8.0 ± 1.0 dB  
 +7.4 ± 1.2 dB  
**D.S.L.:** 50 Hz +16.5 dB ± 2 dB  
 ±0.7 dB (20 Hz to 20,000 Hz)  
**Channel separation:** More than 40 dB  
**Input jacks:** PHONO (MM) 3 mV/47 kΩ  
 (Sensitivity/ TUNER 150 mV/47 kΩ  
 input impedance): TAPE 150 mV/47 kΩ  
 MIC 1 mV/5 kΩ  
**Output jacks:** TAPE 150 mV/47 kΩ  
 (Level/output impedance): HEADPHONES 1 mV/1W, 8 Ω  
 SPEAKERS 8 Ω

• The specifications and external appearance of this set are subject to change without prior notice.

**SPECIFICATIONS = TX-70**

« GENERAL »

**Semiconductors:** H, HU models  
 8 ICs, 5 FETs, 21 transistors, 36 diodes, 9 LEDs,  
 E model  
 8 ICs, 5 FETs, 26 transistors, 35 diodes, 9 LEDs  
 G model  
 8 ICs, 5 FETs, 20 transistors, 37 diodes, 9 LEDs  
**Power source:** H,HU,E models  
 AC 120V/220 ~ 240V  
 Switchable, 50/60 Hz  
 G model  
 AC 240V, 50/60 Hz  
**Power consumption:** 10W  
**Dimensions:** 330(W) x 71(H) x 200(D) mm  
 (13" x 2-3/4" x 7-7/8")  
**Weight:** 2.1 kg (4.63 lbs.)

« FM TUNER SECTION »

**Frequency ranges:** 87.5 ~ 108.0 MHz  
**Intermediate frequency:** 10.7 MHz  
**IHF sensitivity:** 8 ± 2 dB (at 87.5, 98.0, 108.0 MHz)  
 (THD 3%)  
**50 dB quieting sensitivity:** Less than 40 dB (at 98.0 MHz)  
**Image frequency interference ratio:** More than 60 dB (at 98.0 MHz)  
**Intermediate frequency interference ratio:** More than 80 dB (at 98.0 MHz)  
 (MONO)  
**SN ratio:** More than 70 dB (98.0 MHz)  
 (Weighted) (STEREO)  
 More than 63 dB (98.0 MHz)  
**Total harmonic distortion:** (MONO)  
 Less than 0.3% (at 98.0 MHz)  
 (STEREO)  
 Less than 0.4% (at 98.0 MHz)  
**AM suppression ratio:** More than 48 dB (at 98.0 dB)  
**Muting response:** 30 ± 10 dB (at 98.0 MHz)

**Effective selectivity:** More than 60 dB (at 98.0 MHz)  
 (at 400 Hz)  
**Capture ratio:** Less than 2.5 dB (at 98.0 MHz)  
**Frequency response:** 30 Hz ~ 15 kHz (0 +1, -2 dB)  
**Separation:** More than 35 dB (at 1 kHz)  
**Auto stop level:** Less than 30 +10, -5 dB (at 98.0 MHz)  
 « AM TUNER SECTION »  
**Frequency ranges:** MW (AM) 522 ~ 1611 kHz  
 LW 144 ~ 353 kHz  
 (E model only)  
**Intermediate frequency:** 450 kHz  
**Sensitivity:** MW (AM) Less than 57 dB  
 (S/N 20 dB, bar antenna) (at 603 kHz)  
 Less than 55 dB (at 999, 1404 kHz)  
 LW Less than 65 dB  
 (at 155, 200, 290 kHz)  
 (E model only)  
**Image frequency interference ratio:**  
 MW (AM) More than 40 dB  
 (at 999 kHz)  
 LW More than 45 dB  
 (at 200 kHz) (E model only)  
**Intermediate frequency interference ratio:**  
 MW (AM) More than 30 dB  
 (at 999 kHz)  
 More than 40 dB  
 (at 999 kHz)  
**Selectivity:** MW (AM) More than 40 dB  
 (±9 kHz)  
**Total harmonic distortion:** MW (AM) Less than 1.0% (at 999 kHz)  
**AGC characteristic:** MW (AM) 52 ± 10 dB (at 999 kHz)  
**SN ratio:** MW (AM) More than 48 dB  
 (74 dB input)  
**Auto stop level:** MW (AM) 60 ± 10 dB  
 LW 72 ± 8 dB (E model only)

• Specifications and external appearance are subject to change without due to product improvement.

SPECIFICATIONS = FX-70

<b>Semiconductors:</b>	111C's, 40 transistors, 25 diodes 27LED's, 1 photo interrupter
<b>Power supply:</b>	H, HU, E models AC 120V/220V/240V switchable, 50/60 Hz G model AC 240V, 50/60 Hz
<b>Power consumption:</b>	13W
<b>Dimensions:</b>	330(W) x 107(H) x 200(D) mm (13" x 4-1/4" x 7 7/8")
<b>Weight:</b>	3.5kg (7.71 lbs.)
<b>Track type:</b>	4 tracks 2 channels
<b>Tape speed:</b>	4.8 cm/s ± 1.5%
<b>Wow and flutter:</b>	Less than 0.035%(WRMS) 0.035 ± 0.07% (WPEAK)
<b>Automatic stop system:</b>	Full automatic stop
<b>Automatic shut-off action time:</b>	2 ± 2 s.
<b>Pinch roller pressure:</b>	150 ± 10g
<b>Take-up torque:</b>	40 ± 10g-cm (441 <sup>+147</sup> - 98 mN·m)
<b>FF &amp; rewind torque:</b>	160 <sup>+40</sup> - 20 g-cm (1470 ± 490 mN·m)
<b>FF &amp; rewind time:</b>	65 ± 10 s. (C-60)
<b>Play back output:</b>	280 ± 17 mV (LINE)
<b>Play back noise:</b>	Less than 1.0 mV (CrO <sub>2</sub> , DOLBY-NR ON) Less than 1.3 mV (LH DOLBY-NR OFF)
<b>Rec./PB output:</b>	0 VU ± 1.0 dB (LINE)
<b>Rec./PB distortion:</b>	Less than 2.0% (METAL) Less than 2.0% (CrO <sub>2</sub> ) Less than 2.0% (LH)
<b>Rec./PB S/N ratio:</b>	More than 44/48 dB (METAL, CrO <sub>2</sub> , DOLBY-C NR OFF/ON) More than 43/46 dB (LH, DOLBY-C NR OFF/ON)

<b>Channel separation:</b>	More than 35 dB (1 kHz, 0 VU)
<b>Cross talk:</b>	More than 56 dB (1 kHz, 0 VU)
<b>Erasing ratio:</b>	More than 60 dB (METAL 125 Hz, 0 VU, +10 dB)
<b>Output level drift:</b>	Less than 1 dB (at 10 kHz, 0 VU)
<b>Bias frequency:</b>	85 kHz
<b>Frequency response:</b>	METAL 20 ~ 18,000 Hz CrO <sub>2</sub> 20 ~ 17,000 Hz LH 20 ~ 16,000 Hz
<b>Motor:</b>	DC servo motor (capstan) DC motor (FF/REW)
<b>Head:</b>	Rec./PB DX head Erase Double gap ferrite head
<b>Inputs:</b>	LINE IN/REC Max. input sensitivity 50 mV Erase (Optimum load impedance more than 1 kΩ)
<b>Outputs:</b>	LINE OUT/PLAY Standard output level 200 mV(0 VU) (Optimum load impedance more than 50 kΩ)
<b>TEST TAPE:</b>	METAL TTA-119MX CrO <sub>2</sub> TTA-119G LH TTA-119J

- Specifications and external appearance are subject to change without due to product improvement.
- Noise reduction system manufactured under license from Dolby Laboratories Licensing Corporation.
- Dolby and the  symbol are trademarks of Dolby Laboratories Licensing Corporation.

Follow the instructions carefully, which will allow the user to optimise the products' performance and give many years of service.

- No scratch and melting shall be made to covered lead-wires of an a.c. primary circuit including mains leads.
- No illegibility shall be given to the specification plate, the caution labels, the fuse labels and others.
- When, on pattern sides of circuit boards, additional repair-parts have been made up, the parts shall be firmly glued to circuit boards or other components, unless the parts can be attached firmly.
- The following matters shall be maintained as they are, when repairing.
  - Soldering of lead-wire ends
    - \* Care should be taken of the space distance in an a.c. primary circuit as well as soldering.
  - Wiring and holding of lead-wires with wire-clips and binders
  - Materials of lead-wires
    - \* e.g.: For UL models, lead-wires to be used shall be approved or accepted by the UL.
  - Location of all kinds of insulators
  - Setting of voltage selector switch
    - \* Set the Voltage Selector Switch to 240V, 220V, or 120V, According to your Local Voltage.
- After repaired, the insulation resistance or leakage current shall be measured with 500 ± 5V D.C and shall be not less than 1MΩ.

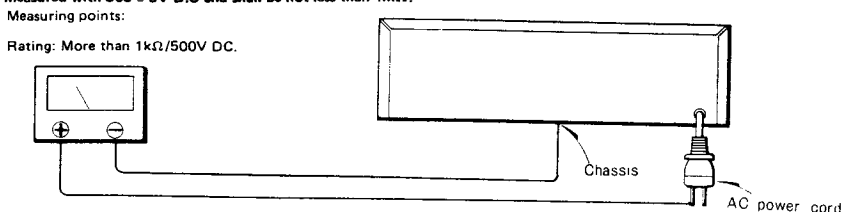

DESCRIPTION

MX-70

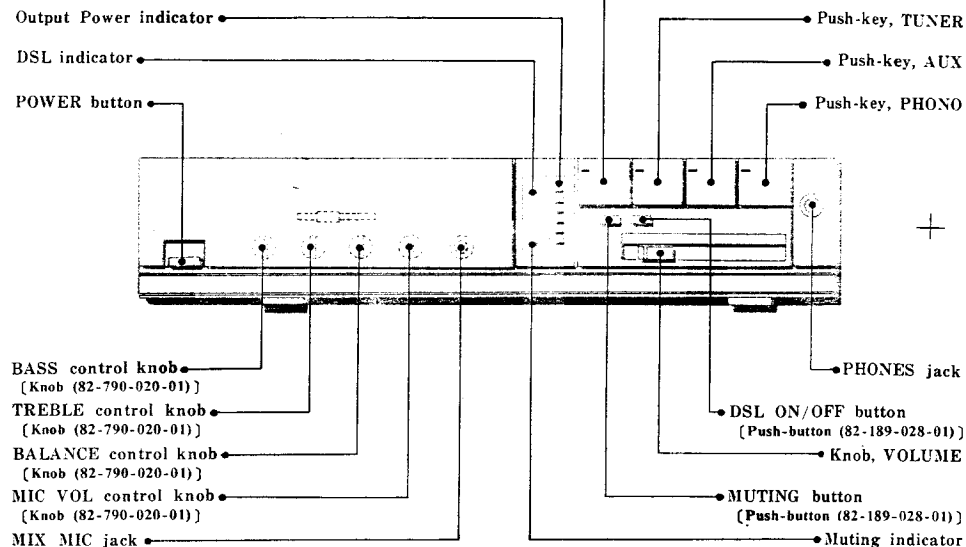

TX-70

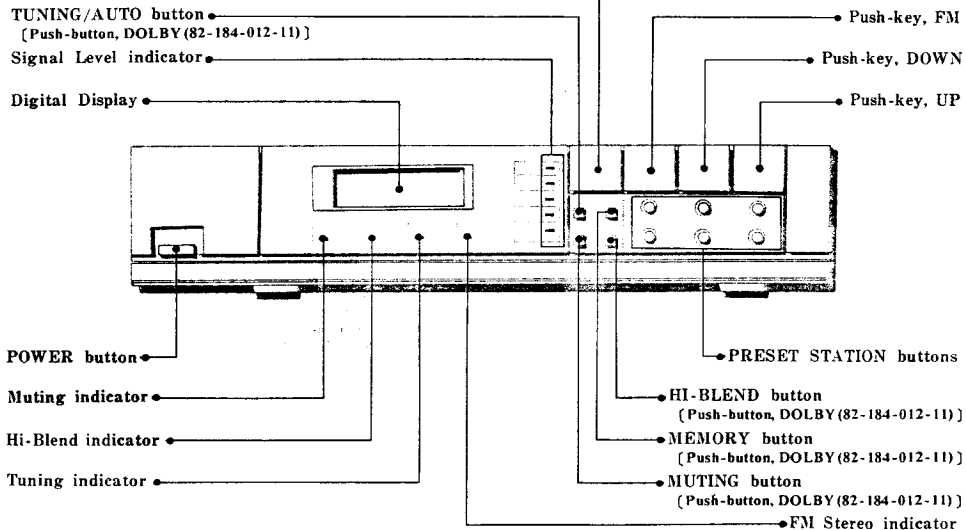

E model only (Push-key ass'y)

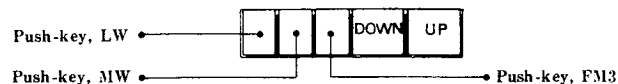

DESCRIPTION

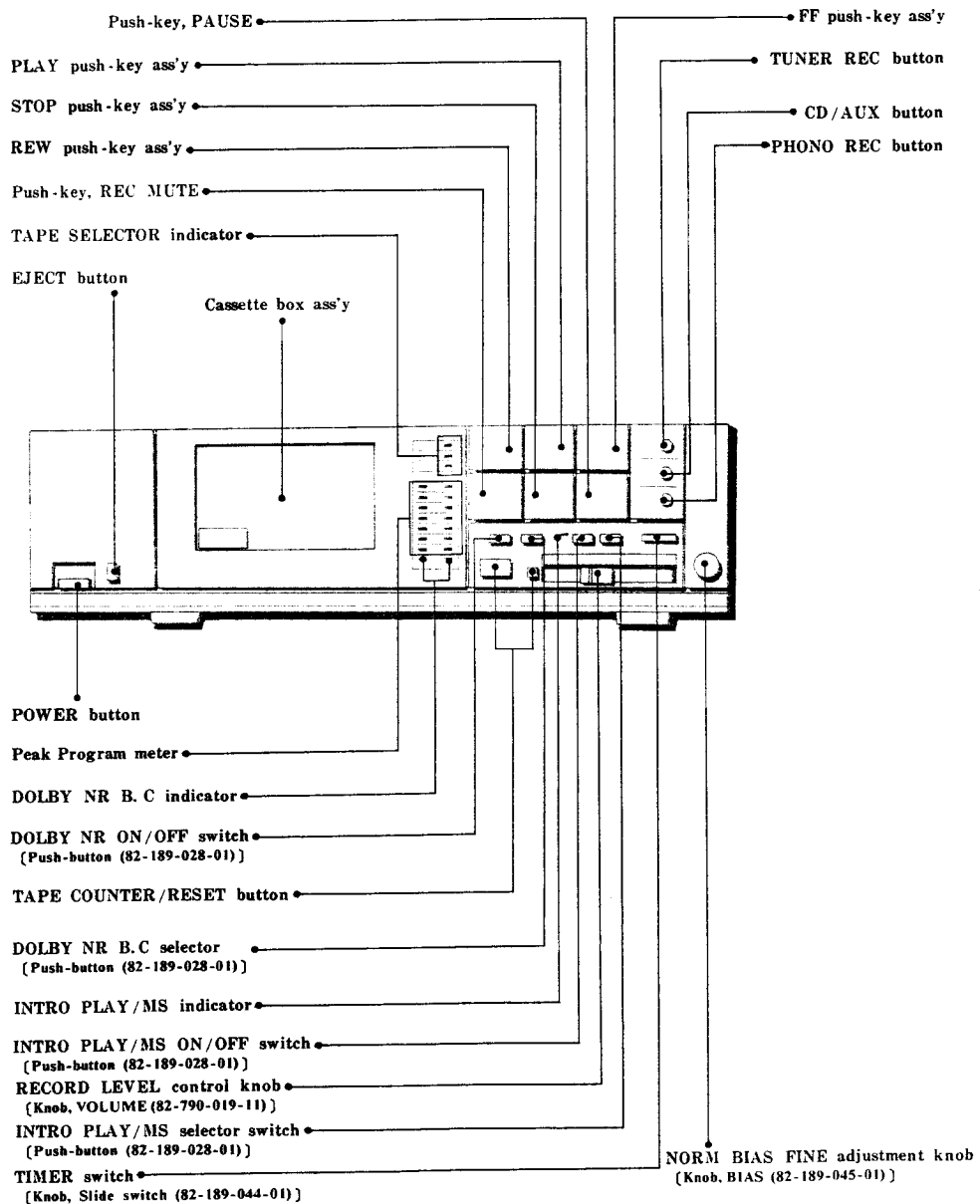

EXPLODED VIEW

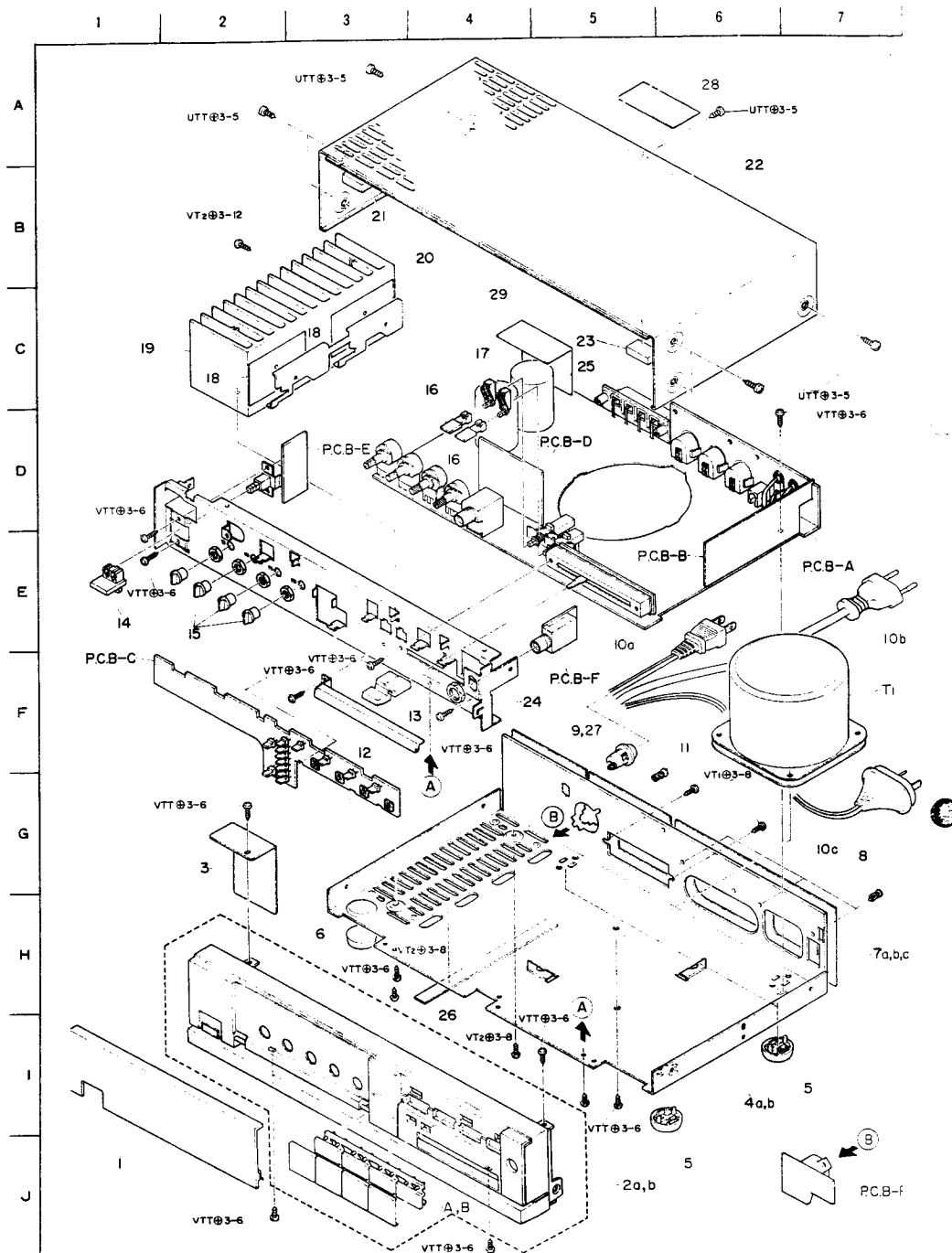

## PARTS LIST

## MECHANICAL PARTS

■ \* mark in this part list shows exclusive part

Ref. No.	Part No.	Part No. Changed to	Description	Common Model	Q'ty
1	82-790-037-01		Front panel CU ass'y F	*	1
2a	82-790-048-11		Front cabinet ass'y (H, HU models only)	*	1
A	82-790-009-01		Push-key ass'y (H, HU models only)	*	1
b	82-790-002-01		Front cabinet ass'y (E, G models only)	*	1
A'	82-790-046-01		Push-key ass'y (E, G models only)	*	1
3	82-790-220-11		Insulation sheet	*	1
4a	82-790-203-21		Amp. chassis ass'y (H, HU, E models only)	*	1
b	82-790-201-21		Amp. chassis ass'y (G model only)	*	1
5	87-085-186-01		Foot		3
6	87-085-188-01		Rubber foot		1
7a	82-790-023-01		Jack plate (H, HU models only)	*	1
b	82-790-025-01		Jack plate (E model only)	*	1
c	82-790-028-01		Jack plate (G model only)	*	1
8	87-085-102-01		Nylon rivet 3.5-5.5		3
9	87-085-184-01		Cord bushing (H, HU models only)		1
10a	87-034-962-01		AC power cord (H, HU models only)		1
b	82-788-674-01		AC power cord (E model only)	MX-100	1
c	87-034-892-01		AC power cord (G model only)		1
11	87-085-090-01		Nylon rivet 3-6.5 (H, HU, E models only)		2
12	82-790-018-01		Plate B, Volume	*	1
13	82-790-019-11		Knob, VOLUME	*	1
14	82-189-027-11		Knob, POWER	FX-70	1
15	82-790-020-01		Knob	*	4
16	82-189-028-01		Push-button	FX-70	2
17	82-790-206-01		Rod, DSL	*	2
18	82-790-624-11		Sheet, Transistor	*	2
19	82-790-601-11		Heat sink	*	1
20	82-790-225-01		Holder, TR	*	1
21	82-790-223-01		Sheet	*	1
22	82-790-037-01		Cabinet, Steel	*	1
23	82-790-224-01		Sheet	*	1
24	82-790-205-01		Chassis, Front	*	1
25	82-788-624-01		Speaker terminal, 4P	MX-100	1
26	82-790-221-01		Sheet	*	1
27	87-085-185-01		Cord bushing (E, G models only)		1
28	82-499-210-01		Insulation sheet (G model only)		1
29	82-790-650-01		Insulation sheet (E,G models only)	*	1

EXPLODED VIEW

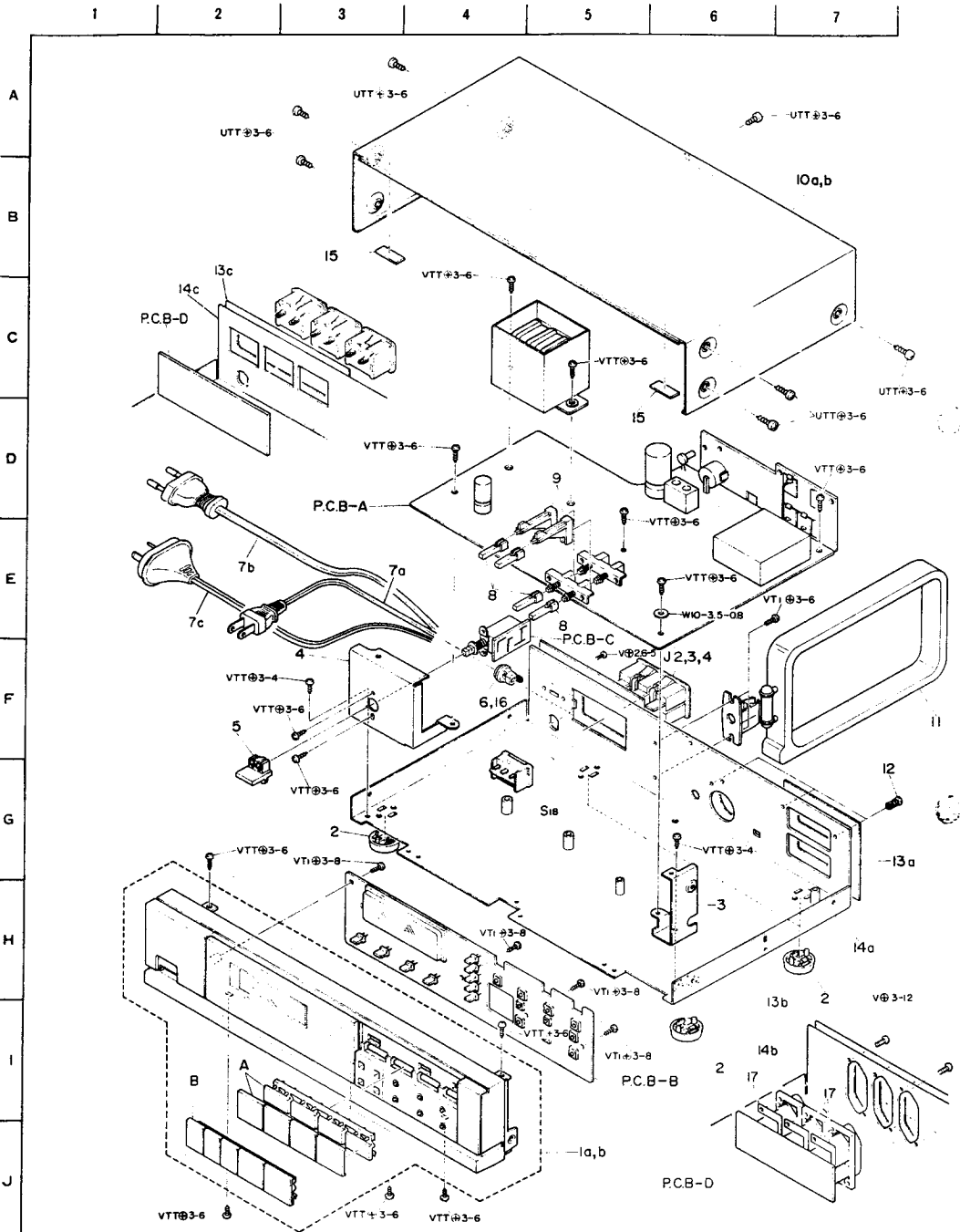

MECHANICAL PARTS

PARTS LIST

\* mark in this part list shows exclusive part

Ref. No.	Part No.	Part No. Changed to	Description	Common Model	Q'ty
1a	82-791-041-11		Front cabinet ass'y (H, HU, G models only)	*	1
A	82-791-010-01		Push-key ass'y (H, HU, G models only)	*	1
1b	82-791-002-11		Front cabinet ass'y (E model only)	*	1
B	82-791-011-01		Push-key ass'y (E model only)	*	1
2	82-085-186-01		Foot	*	4
3	82-791-212-01		Holder R	*	1
4	82-791-211-01		Holder, POWER	*	1
5	82-189-027-11		Knob, POWER	FX-70	1
6	87-085-184-01		Cord bushing (H, HU models only)	*	1
7a	87-034-956-01		AC power cord (H, HU models only)	*	1
b	87-034-877-01		AC power cord (E model only)	*	1
c	87-034-892-01		AC power cord (G model only)	*	1
8	82-184-012-11		Push-button, DOLBY	FX-100	4
9	82-791-210-01		Rod	*	2
10	82-791-023-01		Cabinet, Steel	*	1
11	82-791-652-01		Loop antenna ass'y	*	1
12	87-085-102-01		Nylon rivet 3.5-5.5	*	3
13a	82-791-026-01		Jack plate (H, HU models only)	*	1
b	82-791-029-01		Jack plate (E model only)	*	1
c	82-791-032-01		Jack plate (G model only)	*	1
14a	82-791-201-31		Amp. chassis ass'y (H, HU models only)	*	1
b	82-791-205-21		Amp. chassis ass'y (E model only)	*	1
c	82-791-223-01		Amp. chassis ass'y (G model only)	*	1
15	82-791-221-11		Sheet	*	2
16	87-085-185-01		Cord bushing (E, G models only)	*	1
17	82-773-216-01		Plate, Nut (E model only)	AT-9500	3

EXPLODED VIEW-1

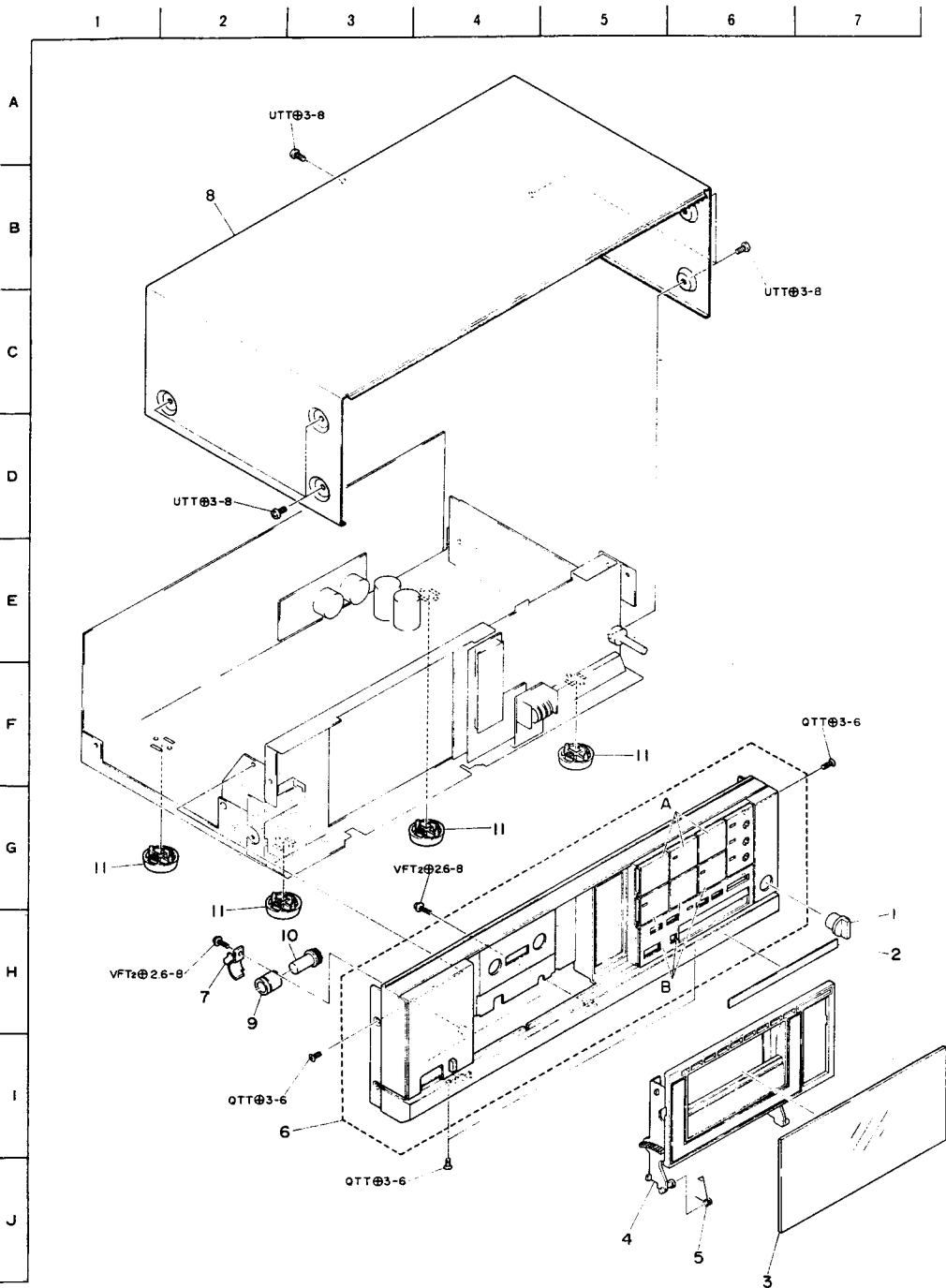

MECHANICAL PARTS

PARTS LIST

■ \* mark in this part list shows exclusive part

Ref. No.	Part No.	Part No. Changed to	Description	Common Model	Q'ty
1-1	82-189-045-01		Knob, BIAS	*	1
1-2	82-184-038-01		Sheet, BIAS instruction	FX-100	1
1-3	82-189-052-01		Window, Cassette	*	1
1-4	82-189-011-01		Cassette box ass'y F	*	1
1-5	82-189-221-01		T-spring, Cassette Open	*	1
1-6	82-189-042-11		Front cabinet ass'y	*	1
A	82-189-016-21		PLAY Push-key ass'y	*	1
B	82-189-017-21		STOP Push-key ass'y	*	1
1-7	82-175-210-11		Holder, Oil damp	AD-3500	1
1-8	82-189-003-01		Cabinet, Steel	*	1
1-9	82-185-212-01		Shaft bearing, Oil damp	AD-3250	1
1-10	82-534-264-01		Gear, Oil damp	*	1
1-11	87-085-186-01		Foot	*	4

EXPLODED VIEW-2

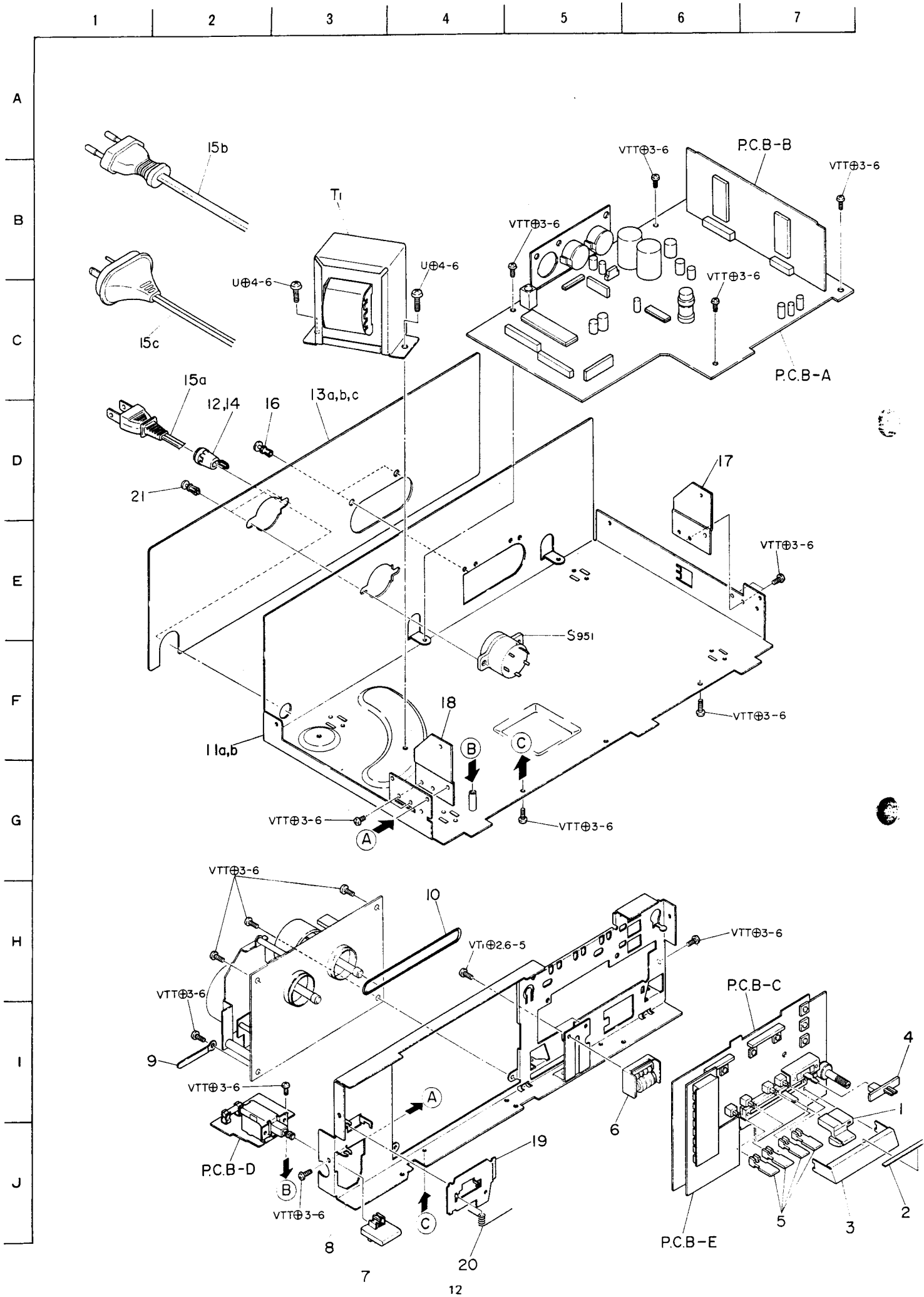



Ref. No.	Part No.	Part No. Changed to	Description	Common Model	Q'ty
2-1	82-790-019-11		Knob, VOLUME	MX-70	1
2-2	82-189-211-01		Sheet	*	1
2-3	82-189-029-01		Name plate, Blind	*	1
2-4	82-189-044-01		Knob, Slide switch	*	1
2-5	82-189-028-01		Push-button	*	4
2-6	87-040-161-01		Counter		1
2-7	82-189-027-11		Knob, POWER	*	1
2-8	82-189-206-11		Front chassis ass'y F	*	1
2-9	87-038-039-01		Wire binder		1
2-10	82-429-228-01		Belt, Relay		1
2-11a	82-189-214-01		Amp chassis ass'y (H, HU, E models only)	*	1
b	82-189-201-21		Amp chassis ass'y (G model only)	*	1
2-12	87-085-185-01		Cord bushing (E, G models only)		1
2-13a	82-189-033-01		Jack plate (H, HU models only)	*	1
b	82-189-034-01		Jack plate (E model only)	*	1
c	82-189-036-01		Jack plate (G model only)	*	1
2-14	87-085-184-01		Cord bushing (H, HU models only)		1
2-15a	87-034-935-01		AC power cord (H, HU models only)		1
b	82-788-674-01		AC power cord (E model only)	MX-100	1
c	87-034-892-01		AC power cord (G model only)		1
2-16	87-085-102-01		Nylon rivet 3.5—5.5		2
2-17	82-189-209-01		Side holder R	*	1
2-18	82-189-208-01		Side holder L	*	1
2-19	82-189-220-01		Plate, Eject	*	1
2-20	82-189-219-01		T-spring, Eject	*	1
2-21	87-085-090-01		Nylon rivet 3—6.5		2

EXPLODED VIEW-3

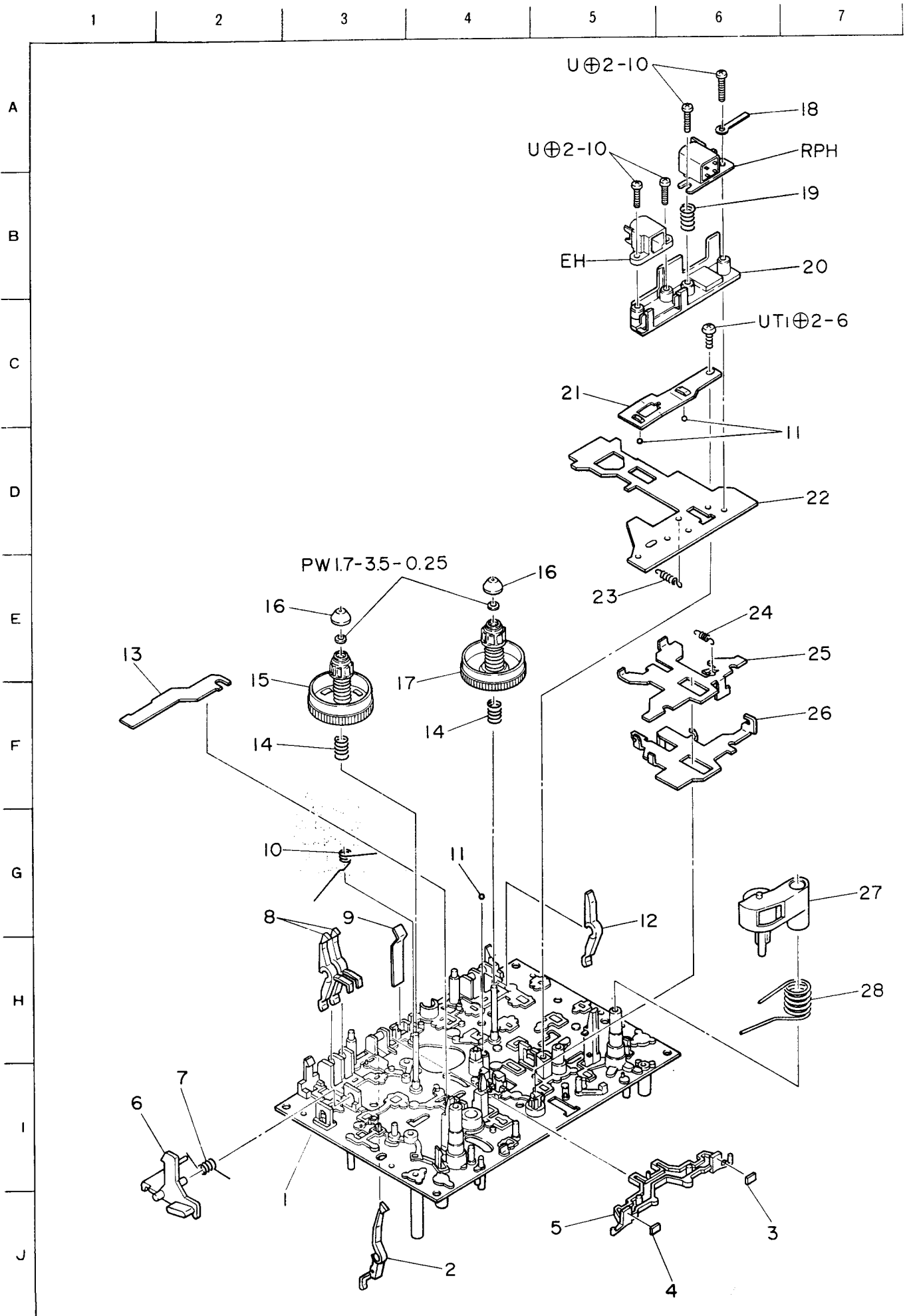

Ref. No.	Part No.	Part No. Changed to	Description	Common Model*	Q'ty
3-1	81-505-201-11		Outsert chassis ass'y		1
3-2	81-505-242-11		Lever, Metal		1
3-3	81-505-315-01		Felt 6-3-2		1
3-4	81-505-313-01		Felt 6-3-3.3		1
3-5	81-505-236-11		Lever, Slide brake		1
3-6	81-505-239-01		Lever, Eject		1
3-7	81-505-273-01		T-spring, Lid lock		1
3-8	81-505-241-21		REC blocking lever		2
3-9	81-505-260-01		P-spring, Pressure cassette		1
3-10	81-505-268-01		T-spring, Slide brake		1
3-11	87-073-005-01		Steel ball 2 $\phi$		3
3-12	81-505-240-21		Lever, Cassette sensor		1
3-13	81-505-238-01		Blocking lever, EJECT		1
3-14	81-505-274-01		C-spring, Supply reel platform		2
3-15	81-505-275-01		Supply reel platform ass'y		1
3-16	82-303-398-01		Cap, Take-up reel platform		2
3-17	81-505-226-11		Take-up reel platform ass'y		1
3-18	82-357-487-11		Holder, Lead wire		1
3-19	81-505-262-01		C-spring, RPH		1
3-20	81-505-209-01		Head base 2H		1
3-21	81-505-259-01		P-spring, Actuating chassis		1
3-22	81-505-206-11		Actuating chassis		1
3-23	81-505-265-11		E-spring, Actuating chassis		1
3-24	81-505-266-01		E-spring, PAUSE plate		1
3-25	81-505-207-01		Plate, PAUSE		1
3-26	81-505-208-01		Plate, Pinch lever		1
3-27	81-505-210-11		Pinch lever F ass'y		1
3-28	81-505-267-01		T-spring, Pinch F		1

EXPLODED VIEW-4

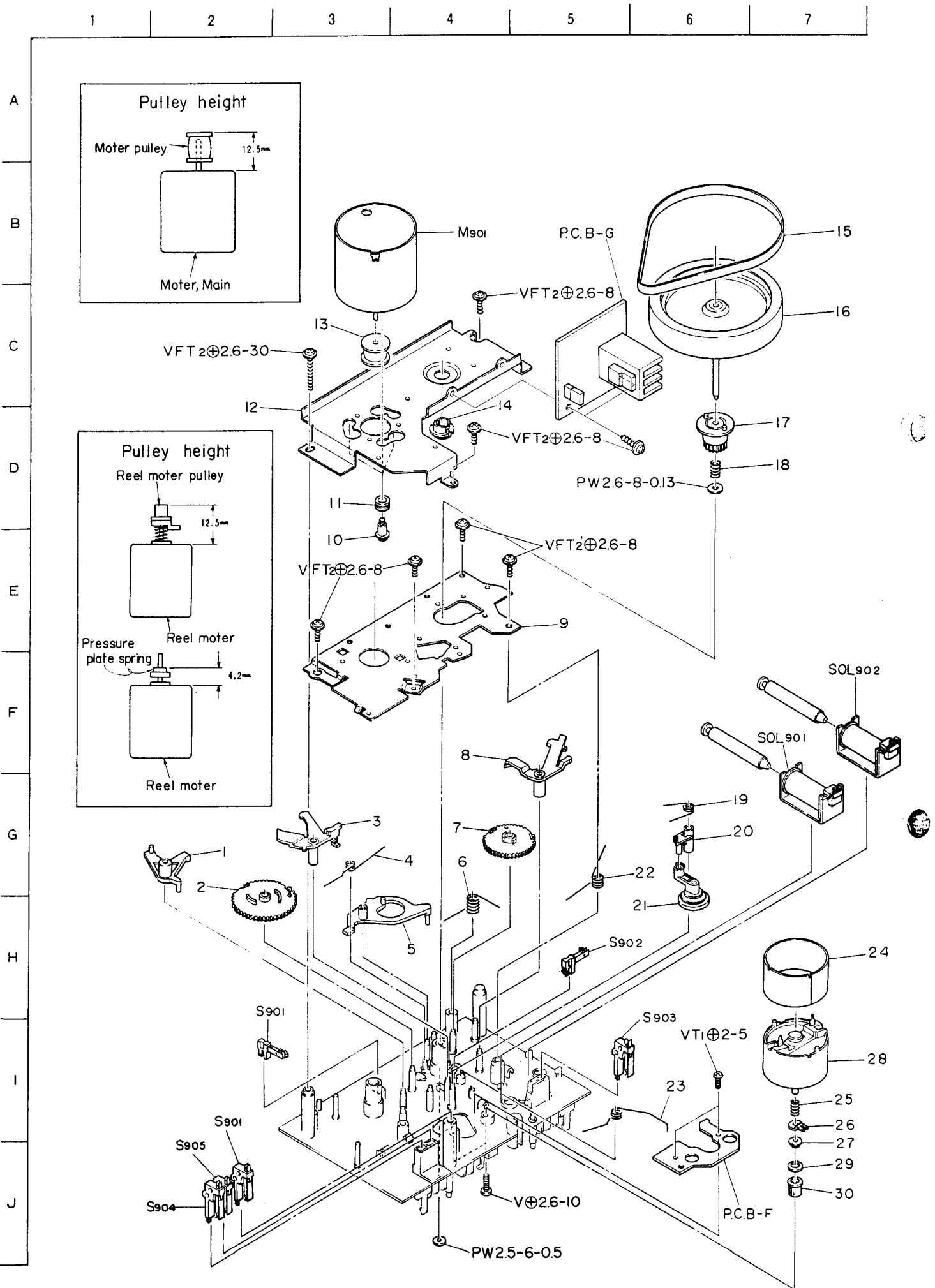

Ref. No.	Part No.	Part No. Changed to	Description	Common Model	Q'ty
4-1	81-505-230-01		Lever, PLAY		1
4-2	81-505-234-01		Gear, Play cam		1
4-3	81-505-231-01		Trigger lever, PLAY		1
4-4	81-505-272-01		T-spring, Cam		1
4-5	81-505-232-01		Lever, PAUSE		1
4-6	81-505-283-01		T-spring, PAUSE lever		1
4-7	81-505-235-01		Gear, PAUSE cam		1
4-8	81-505-233-01		Trigger lever, PAUSE		1
4-9	81-505-204-01		Chassis, Mechanism B		1
4-10	87-081-483-01		Motor screw, M2.6		3
4-11	87-087-029-01		Rubber cushion		3
4-12	81-505-205-01		Holder, Motor		1
4-13	81-505-245-01		Motor pulley 2-10-6.8		1
4-14	82-585-326-11		Thrust bearing B		1
4-15	81-505-247-01		Rubber belt, Flywheel		1
4-16	81-505-222-11		Flywheel ass'y		1
4-17	81-505-225-01		Gear, Flywheel		1
4-18	81-505-261-01		C-spring, Flywheel F		1
4-19	81-505-282-01		T-spring, FR idler		1
4-20	81-505-254-01		FR idler lever A		1
4-21	81-505-250-11		FR idler ass'y		1
4-22	81-505-271-01		T-spring, Trigger lever		1
4-23	81-505-269-01		T-spring, Pinch plate		1
24~30	09-047-198-01		Reel motor ass'y		1
4-24	81-505-606-01		Shield plate		1
4-25	81-505-290-01		C-spring, FR idler C		1
4-26	81-505-287-01		FR idler lever C		1
4-27	81-505-289-01		Pressure plate spring		1
4-28	81-505-604-11		Motor, Reel		1
4-29	81-505-292-11		Felt 4.5-7.2-0.8		1
4-30	81-505-257-01		Pulley, Reel motor		1

## SPRING APPLICATION POSITION (FX-70)

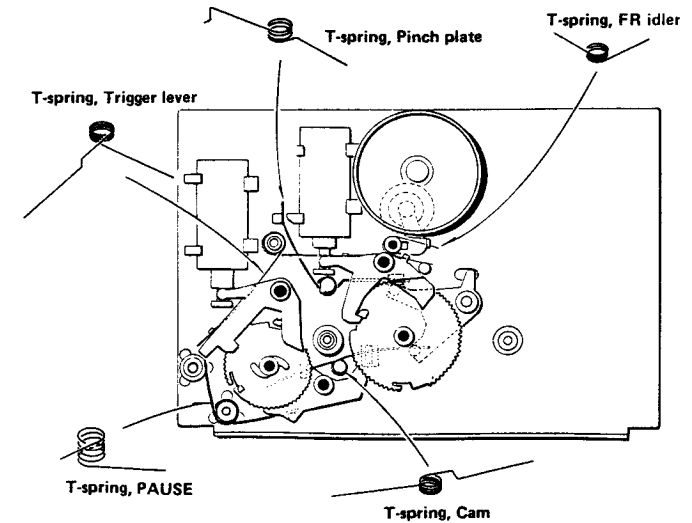
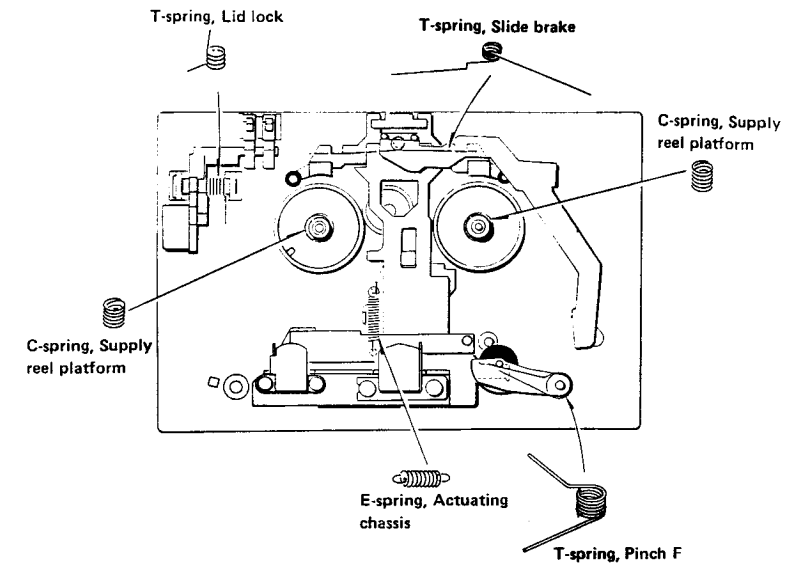

**ACCESSORIES/PACKAGE = MX-70**

Ref. No.	Part No.	Part No. Changed to	Description	Common Model	Q'ty
1	82-790-855-01		Printed indiv., Packing	*	1
2	82-790-852-01		Cushion L, Printed indiv.	*	1
3	82-790-853-01		Cushion R, Printed indiv.	*	1
4	82-790-856-01		Carton, Outer	*	¼
5	87-051-131-11		Poly-vinyl sack (H, HU models only)		1
6	87-051-135-11		Poly-vinyl sack (E, G. models only)		1
7	87-056-604-01		Poly-vinyl sack		1
8	82-790-906-01		Instructions booklet	*	1
9	87-051-155-01		Poly-vinyl sack (H model only)		1
10	87-051-171-11		Poly-vinyl sack		1
11	87-056-009-51		Distributors list (H, E, G models only)		1
12	87-056-045-01		Guarantee cord (HU model only)		1
13	87-056-057-01		Service station list (HU model only)		1
14	87-056-059-01		Guarantee card (G model only)		1

**ACCESSORIES/PACKAGE = TX-70**



























Ref. No.	Part No.	Part No. Changed to	Description	Common Model	Q'ty
1a	82-791-853-01		Printed indiv., Packing (H, HU, G models only)	*	1
1b	82-791-856-01		Printed indiv., Packing (E model only)	*	1
2	82-790-852-01		Cushion L, Printed indiv.	MX-70	1
3	82-790-853-01		Cushion R, Printed indiv.	MX-70	1
4	82-791-854-01		Carton, Outer	*	¼
5	87-051-131-11		Poly-vinyl sack (H, HU models only)		1
6	87-051-135-11		Poly-vinyl sack (E, G models only)		1
7	87-056-604-01		Poly-vinyl sack		1
8	82-791-904-01		Instructions booklet	*	1
9	87-051-171-11		Poly-vinyl sack		1
10	87-056-009-51		Distributors list (H, E, G models only)		1
11	87-056-045-01		Guarantee card (HU model only)		1
12	87-056-057-01		Service station list (HU model only)		1
13	87-056-059-01		Guarantee card (G model only)		1
14	82-791-652-01		Loop antenna ass'y	*	1
15	87-032-845-01		Siemens plug (H model only)		1
16	87-034-968-01		Connection cord CW-255GSK		1
17	87-043-065-01		FM feeder antenna		1
18	87-056-008-11		Label, AC power cord (E model only)		1
19	87-042-023-01		Antenna selector adaptor (E model only)		1

**ACCESSORIES/PACKAGE = FX-70**

Ref. No.	Part No.	Part No. Changed to	Description	Common Model	Q'ty
1	82-189-855-01		Printed indiv., Packing	*	1
2	82-189-852-11		Cushion L, Printed indiv.	*	1
3	82-189-853-11		Cushion R, Printed indiv.	*	1
4	82-189-856-01		Carton, Outer	*	¼
5	87-056-610-01		Poly-vinyl sack		1
6	82-189-904-01		Instructions booklet	*	1
7	87-051-171-11		Poly-vinyl sack		1
8	87-056-009-51		Distributors list (H, E, G models only)		1
9	87-056-045-01		Guarantee card (HU model only)		1
10	87-056-059-01		Guarantee card (G model only)		1
11	87-056-057-01		Service station list (HU model only)		1
12	87-034-969-01		Connection cord CW-255FSK		1
13	87-034-970-01		Connection cord CW-258FSK		1

**ELECTRICAL MAIN PARTS LIST**

Symbol No.	Part No.	Description
<b>« MAIN CIRCUIT BOARD SECTION »</b>		
PCB-A	*	Main circuit board
IC2	87-027-898-01	IC, TC9151P
IC3,4	87-027-895-01	IC, M5218L
IC5,6	87-027-897-01	IC, $\mu$ PC1225H
IC7	87-027-787-01	IC, $\mu$ PC1237H
Q1	89-413-023-01	Transistor, 2SD1302 (S)
Q2,3,4	89-318-156-01	Transistor, 2SC1815 (BL)
Q5,6,7,15,16, 17,18,25, 26,31,32	89-318-154-01	Transistor, 2SC1815 (Y)
Q8,41	89-110-154-01	Transistor, 2SA1015 (Y)
Q9	89-304-953-41	Transistor, 2SC495 (O, Y)
Q21,22	89-320-014-01	Transistor, 2SC2001 (K)
Q27,28	89-412-882-41	Transistor, 2SD1288 (RP)
Q29,30	89-209-652-41	Transistor, 2SB965 (RP)
Q45	89-412-653-41	Transistor, 2SD1265 (O, P)
Q46	89-209-412-31	Transistor, 2SB941 (PQ)
D1	87-027-320-01	Zener diode, HZ7C2
D5,6,7,10,17, 18,19,20,21, 22,23,24,25, 33,34,41,42, 44	87-027-219-01	Diode, MA150
D8	87-027-173-01	Zener diode, RD4.7EB
D9,43,51,52	87-027-686-01	Zener diode, HZ12A1
D15,16	87-027-475-01	Zener diode, HZ6B1
D31	87-027-633-01	Zener diode, HZ9A2
D32	87-027-219-01	Diode, MA150 (H, HU models only)
D32	87-027-365-01	Diode, S5277B (E, G models only)
D45	87-027-365-01	Diode, S5277B
D53	87-027-720-01	Diode, S4NB200
D54	87-027-376-01	Diode, 1B4B41
L1,2	87-005-158-01	Inductor coil, 1 $\mu$ H
TH1,2	82-304-722-01	Thermistor, 42D26
RY1	87-045-189-01	Relay, G4Z-24V
J1,2,3,4,5, 6,7	82-788-621-21	Pin jack ass'y (PHONO, AUX, TUNER, TAPE REC/PLAY, REMOTE CONTROL, GND)
J9	87-049-141-01	Jack, 6.3 $\phi$ w/switch (MIX MIC)
VR1	87-021-724-01	Slide volume, 100k $\Omega$ -A (VOLUME)
VR2	87-021-726-01	Volume, 10k $\Omega$ -MN (BALANCE)
VR3	87-021-727-01	Volume, 50k $\Omega$ -A, O (TREBLE)
VR4	87-021-728-01	Volume, 50k $\Omega$ -A, S (BASS)
VR6	87-021-725-01	Volume, 50k $\Omega$ -B (MIC)
S5,6	82-790-625-01	Push-switch (DSL, MUTING)
SFR1,2	87-021-740-01	Semi-fixed resistor, 3.3k $\Omega$ -B
	82-788-624-01	Speaker terminal, 4P
<b>&lt; Resistors &gt;</b>		
 R203,204,205	87-029-114-01	4.7 $\Omega$ 1/4W Fuse resistor
R157,158, 169,170	87-025-318-01	10 $\Omega$ 1W Metal film
R167,168	87-025-154-01	270 $\Omega$ 1W Metal film
R193	87-025-335-01	390 $\Omega$ 1W Metal film
R155,156	87-025-334-01	0.33 $\Omega$ 3W Cement resistor
<b>&lt; Capacitors &gt;</b>		
C159,160	87-015-956-01	6800 $\mu$ F 50V Electrolytic
C144	87-015-989-01	220 $\mu$ F 25V Electrolytic BP
<b>« PHONO AMP CIRCUIT BOARD SECTION »</b>		
PCB-B	*	Phono amp. circuit board
IC1	87-027-925-01	IC, M5220 (L)
<b>&lt; Capacitor &gt;</b>		
C3.4	87-015-643-01	2.2 $\mu$ F 50V Electrolytic LL

Symbol No.	Part No.	Description
<b>« LED CIRCUIT BOARD SECTION »</b>		
PCB-C	*	LED circuit board
IC8	87-027-879-01	IC, AN6882
D55,56,57,58, 59,60,67,78	87-027-219-01	Diode, MA-150
D61,62,63, 64,66	87-027-543-01	LED, 317GP (PHONO, TAPE MONITOR, MU)
D65,71,72,73, 74,75,76,77	87-027-542-01	LED, 217RP (DSL, OL)
S1,2,3,4	87-031-712-01	Tact switch (PHONO, TAPE MONITOR)
<b>« SWITCH-1 CIRCUIT BOARD SECTION »</b>		
PCB-D	*	Switch-1 circuit board
 S7	87-031-700-01	Push-switch (POWER) (H, HU models only)
 S7	87-031-749-01	Push-switch (POWER)
 F1	87-035-256-01	Fuse, 3.15A (H, HU models only)
 F1	87-098-045-01	Fuse label, 3.15A (H, HU models only)
 F1	87-035-139-01	Fuse, "T" 2.5A (E, G models only)
 F1	87-098-020-01	Fuse label, "T" 2.5A (E, G models only)
 F1	87-033-147-01	Fuse clamp
<b>&lt; Capacitors &gt;</b>		
 C1	87-019-110-01	0.01 $\mu$ F Spark kill (H, HU models only)
 C1	87-019-112-01	0.01 $\mu$ F Spark kill (E, G models only)
<b>« JACK CIRCUIT BOARD SECTION »</b>		
PCB-E	*	Jack circuit board
J10	87-049-142-01	Jack, 6.3 $\phi$ w/switch (H)
<b>« SWITCH-2 CIRCUIT BOARD SECTION » = "H"</b>		
 PCB-F	*	Switch-2 circuit board
 S8	87-031-700-01	Rotary switch (VOLTA)
 F2	87-035-222-01	Fuse, "T" 1A
 F2	87-098-016-01	Fuse label, "T" 1A
 F2	87-033-147-01	Fuse clamp
<b>« MISCELLANEOUS »</b>		
 T1	82-790-616-01	Power transformer (H, HU models only)
 T1	82-790-618-01	Power transformer (E models only)
 T1	82-790-620-01	Power transformer (G models only)
 S8	87-031-551-01	Rotary switch (VOLTA) (H, HU, E models only)
 S8	87-085-184-01	Cord bushing (H, HU models only)
 S8	87-085-185-01	Cord bushing (E, G models only)
 S8	87-033-140-01	Splice connector
 S8	87-034-962-01	AC power cord (H, HU models only)
 S8	82-788-674-01	AC power cord (E models only)
 S8	87-034-892-01	AC power cord (G models only)
 S8	82-790-601-01	Heat sink (H, HU models only)
 S8	82-790-646-01	Heat sink (E, G models only)
<b> Safety component symbol</b>		
This symbol is given to important parts which serve to the safety of the product, and which are made to conform to safety specifications. Therefore, when replacing a component with this symbol, make absolutely sure that you use a designated part.		

Symbol No.	Part No.	Description
<b>« LED CIRCUIT BOARD SECTION »</b>		
PCB-C	*	LED circuit board
IC8	87-027-879-01	IC, AN6882
D55,56,57,58, 59,60,67,78	87,027-219-01	Diode, MA-150
D61,62,63, 64,66	87-027-543-01	LED, 317GP (PHONO, AUX, TUNER, TAPE MONITOR, MUTING)
D65,71,72,73, 74,75,76,77	87-027-542-01	LED, 217RP (DSL, OUTPUT POWER)
S1,2,3,4	87-031-712-01	Tact switch (PHONO, AUX, TUNER TAPE MONITOR)

<b>« SWITCH-1 CIRCUIT BOARD SECTION »</b>		
PCB-D	*	Switch-1 circuit board
S7	87-031-700-01	Push-switch (POWER) (H, HU models only)
S7	87-031-749-01	Push-switch (POWER) (E, G models only)
F1	87-035-256-01	Fuse, 3.15A (H, HU models only)
F1	87-098-045-01	Fuse label, 3.15A (H, HU models only)
F1	87-035-139-01	Fuse, "T" 2.5A (E, G models only)
F1	87-098-020-01	Fuse label, "T" 2.5A (E, G models only)
F1	87-033-147-01	Fuse clamp
<b>&lt; Capacitors &gt;</b>		
CC1	87-019-110-01	0.01 $\mu$ F Spark killer (H, HU models only)
CC1	87-019-112-01	0.01 $\mu$ F Spark killer (E, G models only)

<b>« JACK CIRCUIT BOARD SECTION »</b>		
PCB-E	*	Jack circuit board
J10	87-049-142-01	Jack, 6.3 $\phi$ w/switch (HEADPHONES)

<b>« SWITCH-2 CIRCUIT BOARD SECTION » = "H, HU, E" models only</b>		
PCB-F	*	Switch-2 circuit board
S8	87-031-700-01	Rotary switch (VOLTAGE SELECTOR)
F2	87-035-222-01	Fuse, "T" 1A
F2	87-098-016-01	Fuse label, "T" 1A
F2	87-033-147-01	Fuse clamp

<b>« MISCELLANEOUS »</b>		
T1	82-790-616-01	Power transformer (H, HU models only)
T1	82-790-618-01	Power transformer (E model only)
T1	82-790-620-01	Power transformer (G model only)
S8	87-031-551-01	Rotary switch (VOLTAGE SELECTOR) (H, HU, E models only)
	87-085-184-01	Cord bushing (H, HU models only)
	87-085-185-01	Cord bushing (E, G models only)
	87-033-140-01	Splice connector
	87-034-962-01	AC power cord (H, HU models only)
	82-788-674-01	AC power cord (E model only)
	87-034-892-01	AC power cord (G model only)
	82-790-601-01	Heat sink (H, HU models only)
	82-790-646-01	Heat sink (E, G models only)

#### Note: Combination Circuit Board

The parts on the electrical parts list which are indicated by an asterisk (\*) are supplied as one single combined circuit board. Therefore, they will not be supplied separately. If this becomes necessary, please order the entire circuit board.

#### Combination circuit board 82-790-605-21

PCB-A	82-790-606-21
PCB-B	82-790-607-01
PCB-C	82-790-608-11
PCB-D	82-790-610-11
PCB-E	82-790-609-01
PCB-F	82-790-612-01

#### Safety component symbol

This symbol is given to important parts which serve to maintain the safety of the product, and which are made to conform to special safety specifications. Therefore, when replacing a component with this symbol, make absolutely sure that you use a designated part.



SCHEMATIC DIAGRAM

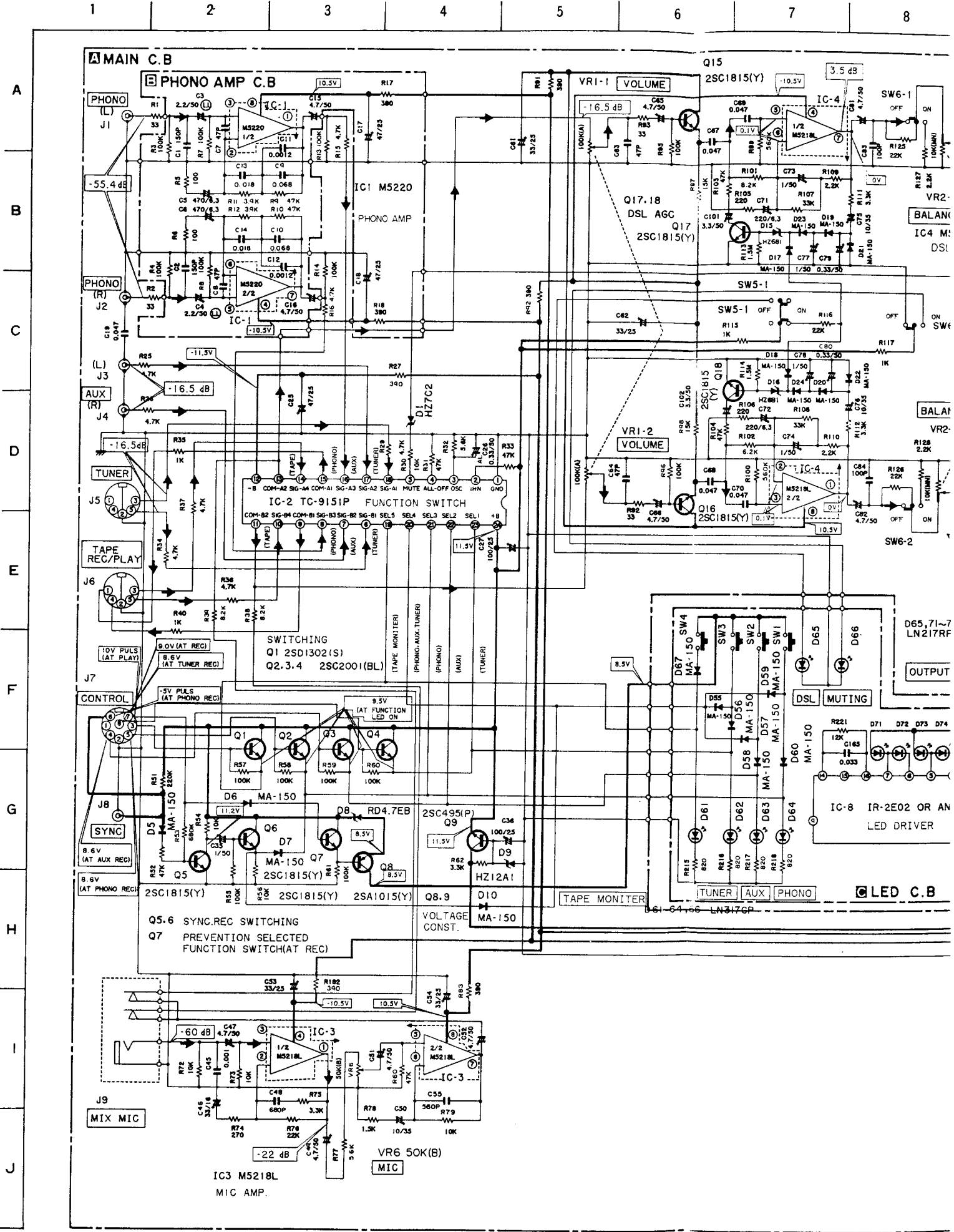

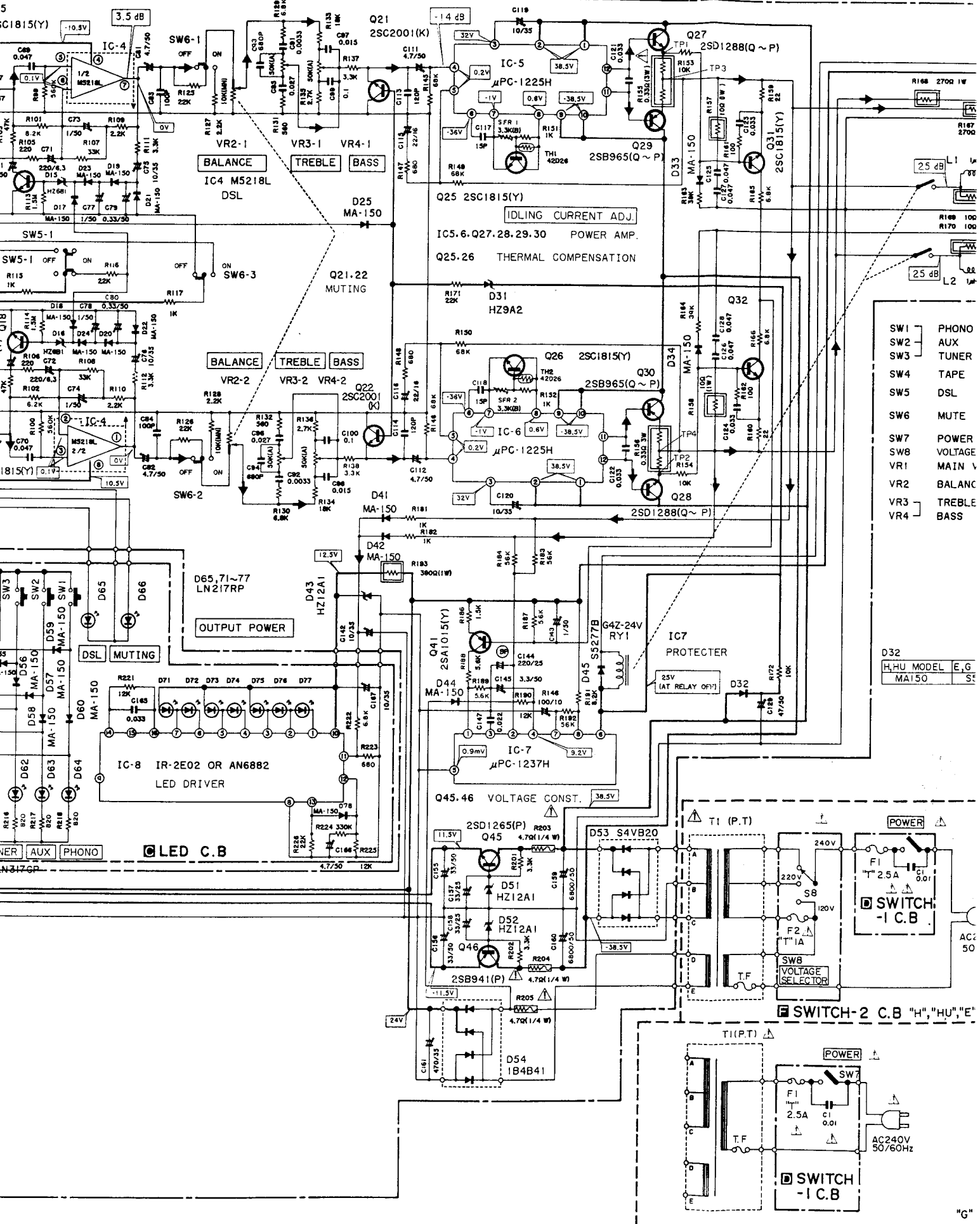



WIRING

1 2 3 4 5 6 7

A B C D E F G H I J

JACK C.B

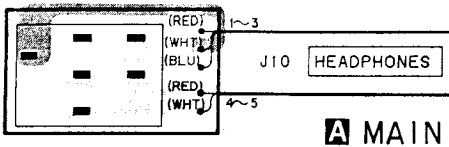

MAIN C.B

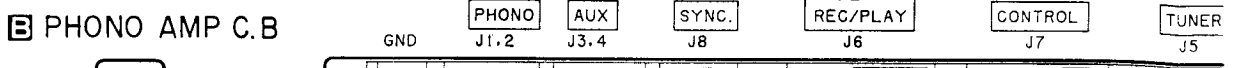

PHONO AMP C.B

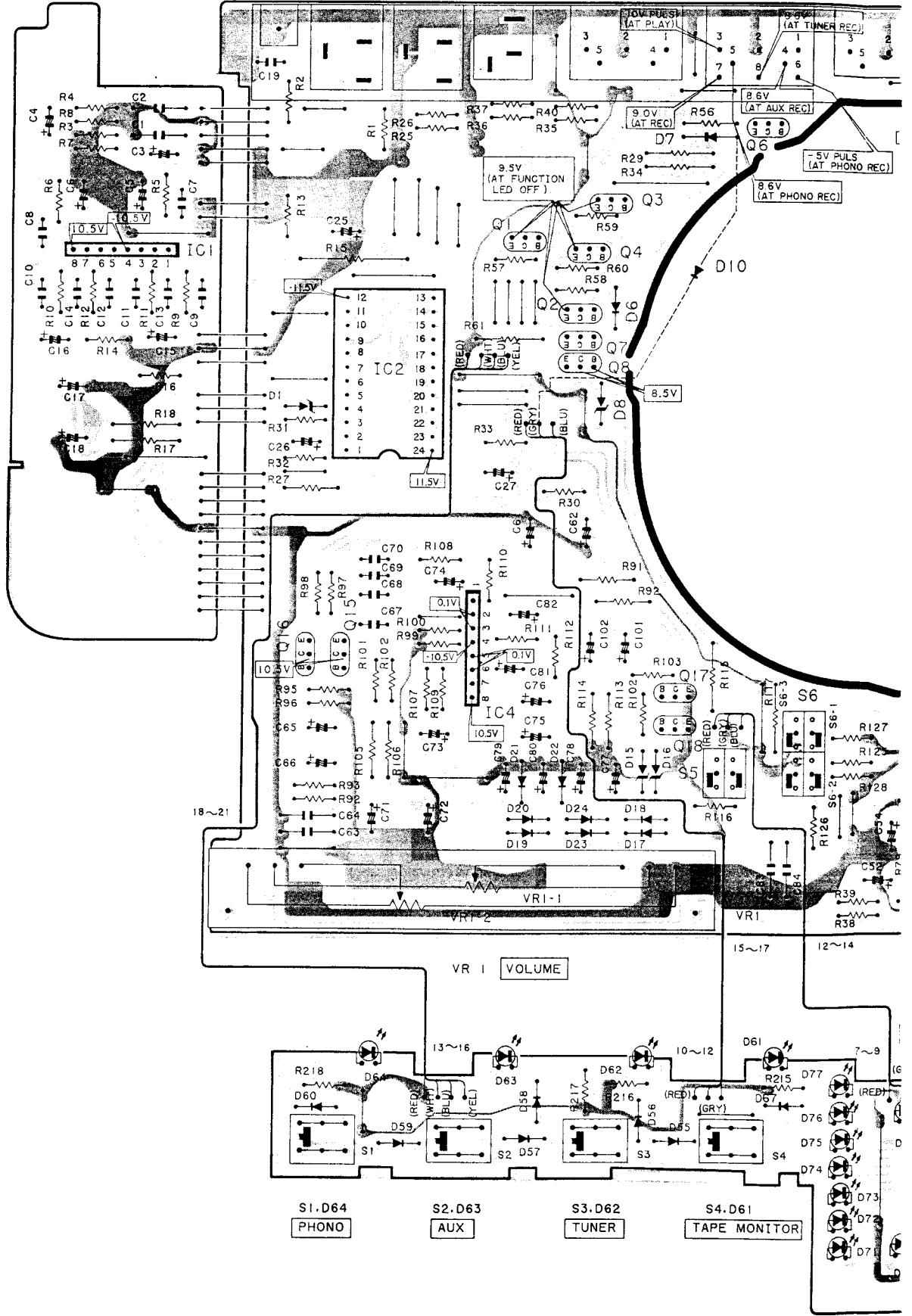

S1.D64 PHONO

S2.D63 AUX

S3.D62 TUNER

S4.D61 TAPE MONITOR

NOTES (1)      Earth pattern      Others pattern  
 (2) The voltage is the reference value measured with a tester (20 K ohms/V DC) when there are no signals.

6                      7                      8                      9                      10                      11                      12                      13

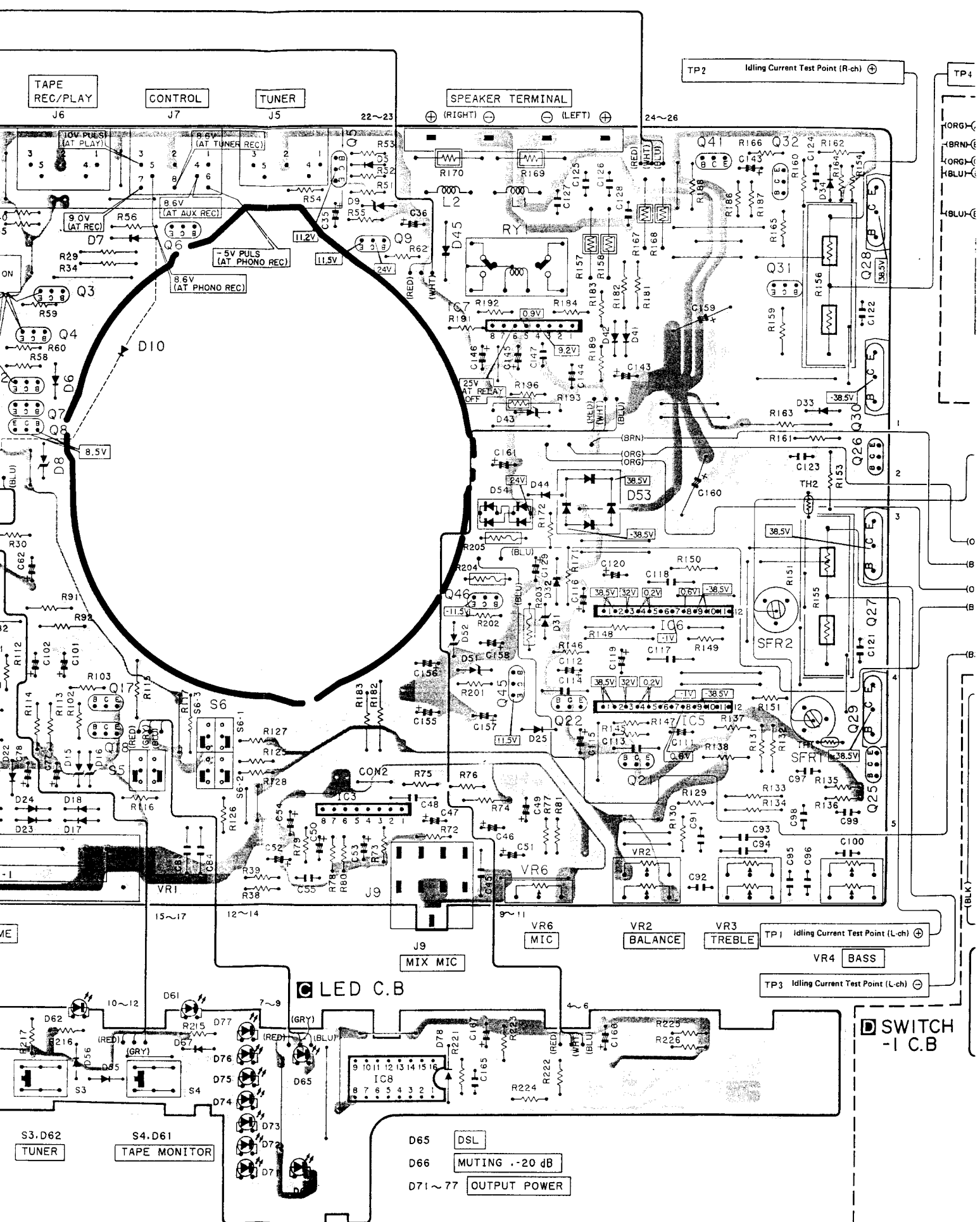

- D65 DSL
- D66 MUTING -20 dB
- D71~77 OUTPUT POWER

signals.

12

13

14

15

16

17

18

19

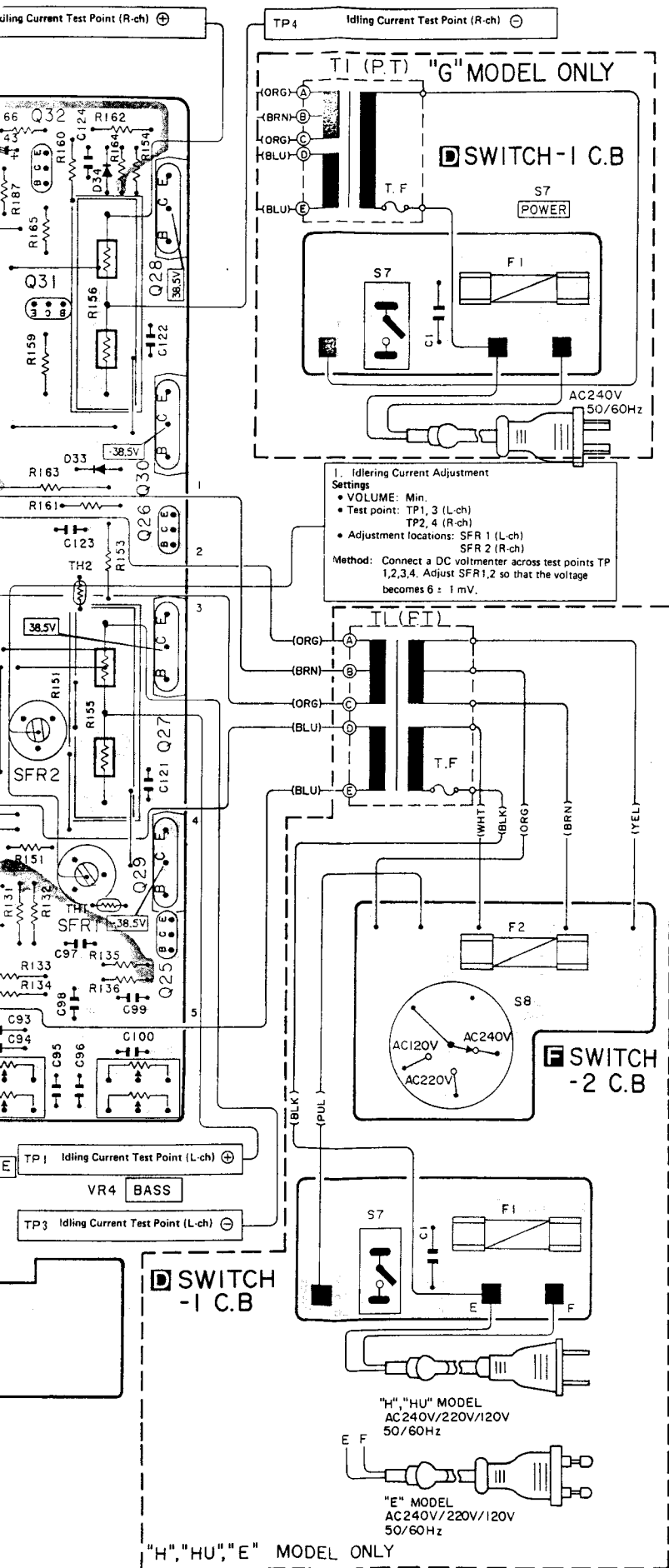

$\mu$ PC1237H

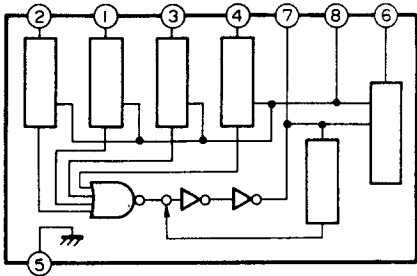

IR2E02 (AN6882)

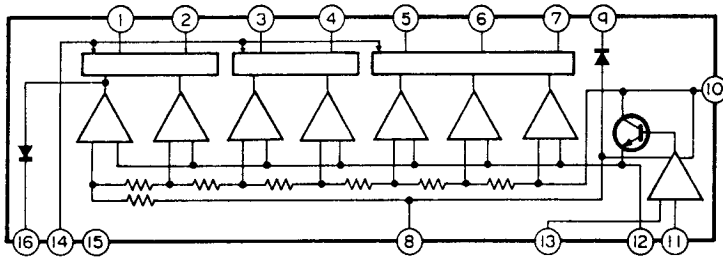

$\mu$ PC1225H

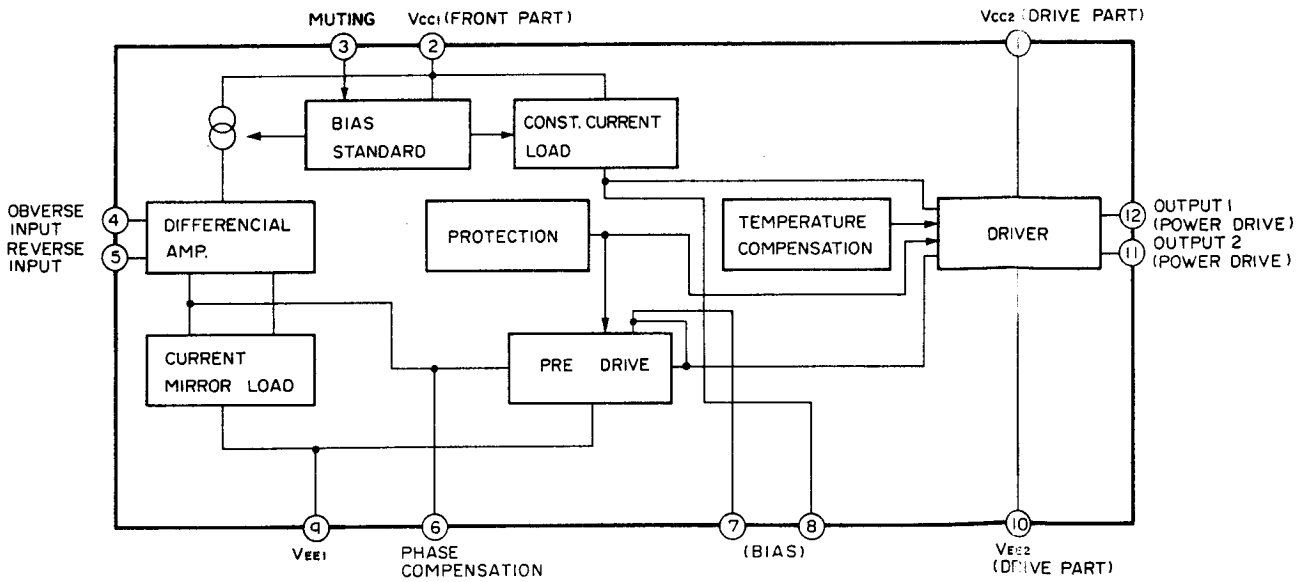

TC9151P

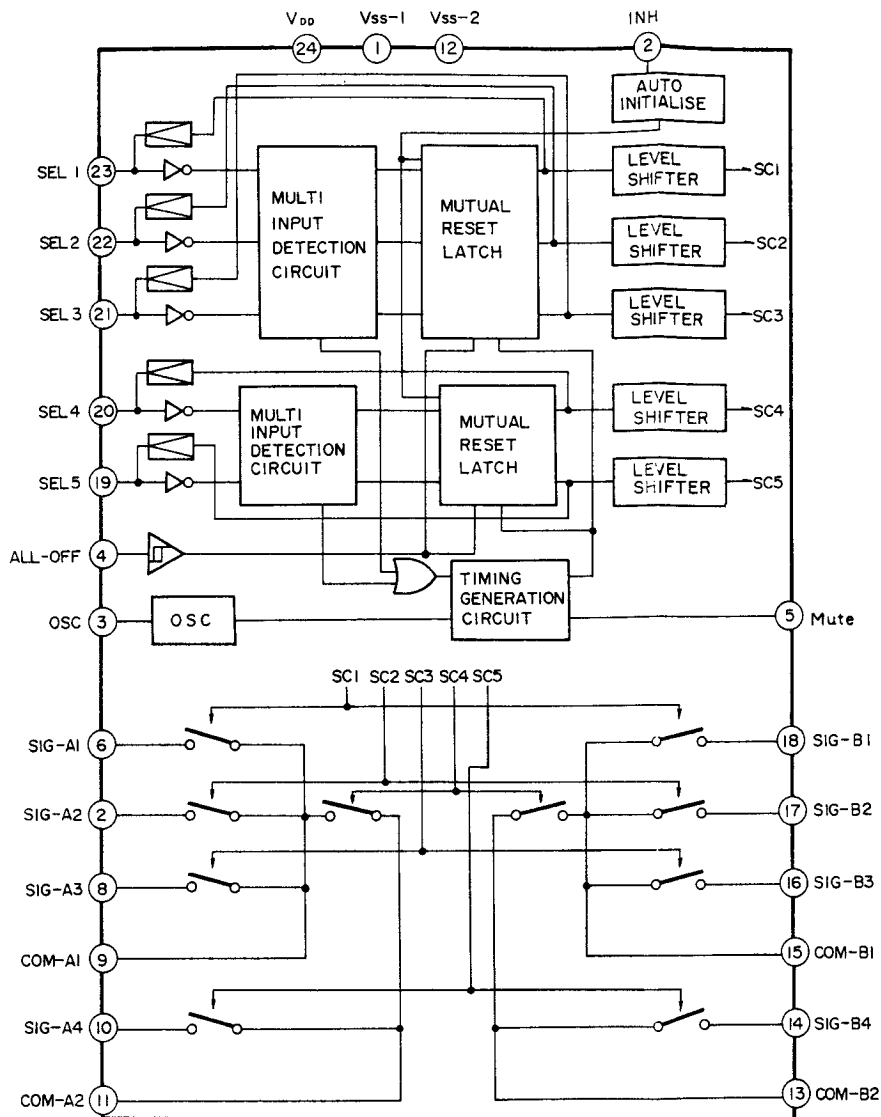

$V_{CC2}$  (DRIVE PART)

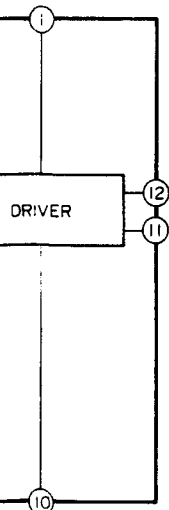

OUTPUT 1  
(POWER DRIVE)  
OUTPUT 2  
(POWER DRIVE)

$V_{EE2}$   
(DRIVE PART)



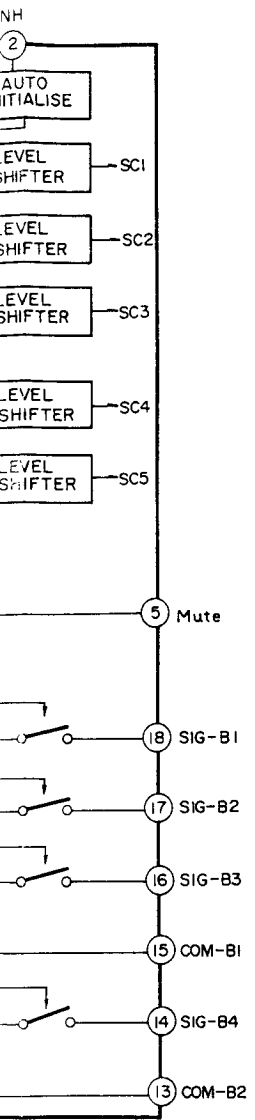

**ELECTRICAL MAIN PARTS LIST**

Symbol No.	Part No.	Description
<b>◀ TUNER CIRCUIT BOARD SECTION ▶</b>		
PCB-A	*	Tuner circuit board
IC1	87-027-752-01	IC, $\mu$ PB553AC
IC2	87-027-903-01	IC, HA1197
IC3	87-027-901-01	IC, HA1137W
⊕IC4	87-027-824-01	IC, $\mu$ PC1703C-521
IC5	87-027-902-01	IC, HA1196
IC6	87-027-895-01	IC, M5218L
Q1	87-026-165-01	FET, 3SK73 (GR)
Q2,5	89-319-233-01	Transistor, 2SC1923 (O)
Q3,4,8	89-501-615-01	FET, 2SK161 (GR)
Q6,9,10,11, 14,15,16,20, 21,26,27,28	89-318-154-01	Transistor, 2SC1815 (Y)
Q7	89-502-464-01	FET, 2SK246 (Y)
Q12,19	89-110-154-01	Transistor, 2SA1015 (Y)
Q13,24	89-318-155-01	Transistor, 2SC1815 (GR)
Q17,18	89-320-011-01	Transistor, 2SC2001 (K)
Q22,29	89-110-155-01	Transistor, 2SA1015 (GR)
Q23	89-408-363-01	Transistor, 2SD836
Q25	89-413-023-01	Transistor, 2SD1302 (S)
D1,2,4,5	87-027-900-01	Diode, ISV147
D3,8,11,12, 13,15,16,17, 18,26,27,28,	87-027-097-01	Diode, IS1555
D6,7	82-769-617-01	Diode, KV-1236Z-2
D14,24	87-027-393-01	Zener diode, HZ4C2
D19	87-027-332-01	Zener diode, HZ6B1L
D20,21,22,23	87-027-365-01	Diode, S5277B
D25	87-027-402-01	Zener diode, HZ24-2L
L1	82-791-631-01	FM antenna coil, 4 (3 $\frac{1}{2}$ T)
L2	82-791-630-01	FM antenna coil, 3 (1 $\frac{1}{2}$ T)
L3,5,6	82-791-629-01	FM antenna coil, (3 $\frac{1}{2}$ T)
L4	82-791-627-01	FM antenna coil, (3 $\frac{1}{2}$ T)
L7, 15	87-005-151-01	Coil, 2.2 $\mu$ H
L8	82-494-674-01	FM IFT
L9	82-791-633-01	FM OSC coil
L10	82-791-645-01	MW antenna coil
L11	82-791-640-01	MW OSC coil
L12	82-791-654-01	AM IFT 450 S
L13	82-791-637-01	FM DET, Coil, P
L14	82-791-638-01	FM DET, Coil, S
L16	82-791-641-01	LW antenna coil
L17	82-791-642-01	LW OSC coil
X1	82-769-613-01	Crystal, 4.5 MHz
CF1,2,3	87-008-244-01	Ceramic filter kit
CF4	87-008-225-01	Ceramic filter
LPF1	87-008-257-01	Low-pass filter
TC1,2	87-011-139-01	Trimmer, 6pF
TC3	87-011-108-01	Trimmer, 8pF
TC4	87-011-131-01	Trimmer, 30pF
J1,5,6,7,8,9	82-791-610-01	Antenna terminal ass'y (FM75 $\Omega$ , 300 $\Omega$ , AM ANT, OUTPUT)
S11,12	82-791-650-01	Push-switch (MUTING, HI-BLEND)
S13,14	82-791-651-01	Push switch (TUNING, MEMORY)
SFR1	87-021-566-01	Semi-fixed resistor, 5k $\Omega$ -B
SFR2	87-021-571-01	Semi-fixed resistor, 200k $\Omega$ -B
SFR3	87-021-689-01	Semi-fixed resistor, 47k $\Omega$ -B
⊕T1	82-791-649-01	Power transformer
	82-304-743-01	IP terminal
<b>&lt; Capacitors &gt;</b>		
C30	87-014-048-01	430pF PP
C71	87-014-046-01	360pF PP
C73,74	87-014-058-01	1100pF PP
C81,82	87-014-067-01	2700pF PP
C103,104	87-012-098-01	0.047 $\mu$ F 100V Ceramic

Symbol No.	Part No.	Description
<b>◀ SWITCH-1 CIRCUIT BOARD SECTION ▶</b>		
PCB-B	*	Switch-1 circuit board
IC1	87-027-911-01	IC, IR2E25
IC2	87-027-904-01	IC, M54580
Q1	89-110-154-01	Transistor, 2SA1015 (Y)
D1,2,3,4, 5,15	87-027-542-01	LED, LN217RP (SIGNAL FM STEREO)
D6,7,8,9,10, 11,12,13,14, 19	87-027-097-01	Diode, IS1555
D16,17,18	87-027-543-01	LED, LN317GP (AUTO HI-BLEND, MUTING)
FL1	82-791-661-01	FIP, 7G8D
S1,2,3,4,5,6, 7,8,9,10,17	87-031-712-01	Tact switch (PRESET ST MW, FM UP, DOWN, LW)
<b>&lt; Capacitors &gt;</b>		
C1	87-015-681-01	10 $\mu$ F 16V Electrolytic
C2	87-015-695-01	1 $\mu$ F 50V Electrolytic
C3,4	87-015-696-01	2.2 $\mu$ F 50V Electrolytic

<b>◀ SWITCH-2 CIRCUIT BOARD SECTION ▶</b>		
PCB-C	*	Switch-2 circuit board
⊕S15	82-791-653-01	Leaf switch (POWER)
⊕S16	87-031-748-01	Push-switch (POWER)
<b>&lt; Capacitor &gt;</b>		
⊕C106	87-019-112-01	0.01 $\mu$ F Spark killer

<b>◀ AC OUTLET CIRCUIT BOARD SECTION ▶</b>		
PCB-D	*	AC outlet circuit board
⊕J2,3,4	87-049-014-01	AC outlet
⊕F1	87-035-139-01	Fuse, "T" 2.5A
	87-098-020-01	Fuse label, "T" 2.5A
⊕	87-033-147-01	Fuse clamp

<b>◀ MISCELLANEOUS ▶</b>		
⊕S18	87-031-617-01	Slide switch (VOLTAGE)
⊕	87-034-927-01	AC power cord
⊕	87-085-185-01	Cord bushing

 Safety component symbol

This symbol is given to important parts which serve to the safety of the product, and which are made to conform safety specifications. Therefore, when replacing a component with this symbol, make absolutely sure that you use a designated part.

**Note; Combination Circuit Board**

The parts on the electrical parts list which are indicated with an asterisk (\*) are supplied as one single combined circuit board. Therefore, they will not be supplied separately. If this is necessary, please order the entire circuit board.

**Combination circuit board 82-791-621-01**

PCB-A	82-791-622-01
PCB-B	82-791-623-01
PCB-C	82-791-625-01
PCB-D	82-791-624-01

No.	Part No.	Description
-----	----------	-------------

### CH-1 CIRCUIT BOARD SECTION >>

No.	Part No.	Description
	*	Switch-1 circuit board
	87-027-911-01	IC, IR2E25
	87-027-904-01	IC, M54580
	89-110-154-01	Transistor, 2SA1015 (Y)
	87-027-542-01	LED, LN217RP (SIGNAL LEVEL, FM STEREO)
10, 13, 14,	87-027-097-01	Diode, IS1555
8	87-027-543-01	LED, LN317GP (AUTO TUNING, HI-BLEND, MUTING)
	82-791-661-01	FIP, 7G8D
5, 6, 0, 17	87-031-712-01	Tact switch (PRESET STATION 1~6, MW, FM UP, DOWN, LW)
	< Capacitors >	
	87-015-681-01	10 $\mu$ F 16V Electrolytic
	87-015-695-01	1 $\mu$ F 50V Electrolytic
	87-015-696-01	2.2 $\mu$ F 50V Electrolytic

### CH-2 CIRCUIT BOARD SECTION >>

No.	Part No.	Description
	*	Switch-2 circuit board
	82-791-653-01	Leaf switch (POWER)
	87-031-748-01	Push-switch (POWER)
	< Capacitor >	
	87-019-112-01	0.01 $\mu$ F Spark killer

### OUTLET CIRCUIT BOARD SECTION >>

No.	Part No.	Description
	*	AC outlet circuit board
	87-049-014-01	AC outlet
	87-035-139-01	Fuse, "T" 2.5A
	87-098-020-01	Fuse label, "T" 2.5A
	87-033-147-01	Fuse clamp

### ELLANEOUS >>

No.	Part No.	Description
	87-031-617-01	Slide switch (VOLTAGE SELECTOR)
	87-034-927-01	AC power cord
	87-085-185-01	Cord bushing

afety component symbol

mbol is given to important parts which serve to maintain y of the product, and which are made to conform to special eciications. Therefore, when replacing a component with bol, make absolutely sure that you use a designated part.

### ombination Circuit Board

s on the electrical parts list which are indicated by an (\* ) are supplied as one single combined circuit board. e, they will not be supplied separately. If this becomes y, please order the entire circuit board.

### ation circuit board 82-791-621-01

- 82-791-622-01
- 82-791-623-01
- 82-791-625-01
- 82-791-624-01

### • Ceramic capacitor

#### (1) 87-018-□□□-01

Capacitor	Parts code
2.2pF	002
4.7pF	005
10pF	009
13pF	011
15pF	012
56pF	026
100pF	032
1000pF	044
0.01 $\mu$ F	047

#### (2) 89-612-□□□-01

Capacitor	Parts code
10pF	105
22pF	215
27pF	235

#### (3) 89-618-□□□-01

Capacitor	Parts code
330pF	525
470pF	555

#### (4) 89-663-□□□-01

Capacitor	Parts code
0.0047 $\mu$ F	725
0.01 $\mu$ F	815

#### (5) 0.01 $\mu$ F 89-652-615-01 0.022 $\mu$ F 87-012-105-01

### C-MOS IC handling precaution

The C-MOS IC's construction makes this part susceptible to damage by static electricity and so take sufficient care in regard to following articles.

1. Need to be put on conductive sheet, to be put in a metallic box and to be wrapped by aluminium foil for transportation and deposit.
2. To use solder iron less than 40W (less than 260°C) of power consumption for soldering. But do not overheat more than 10 second.
3. Do not perform a conductivity test with a tester, etc. Refer to the circuit voltages of each part.
4. The ICs on the electrical parts which are indicated by an C-MOS IC symbol mark (  $\text{C}$  ).

SCHEMATIC DIAGRAM

1 2 3 4 5 6 7 8

A  
B  
C  
D  
E  
F  
G  
H  
I  
J

A TUNER C.B

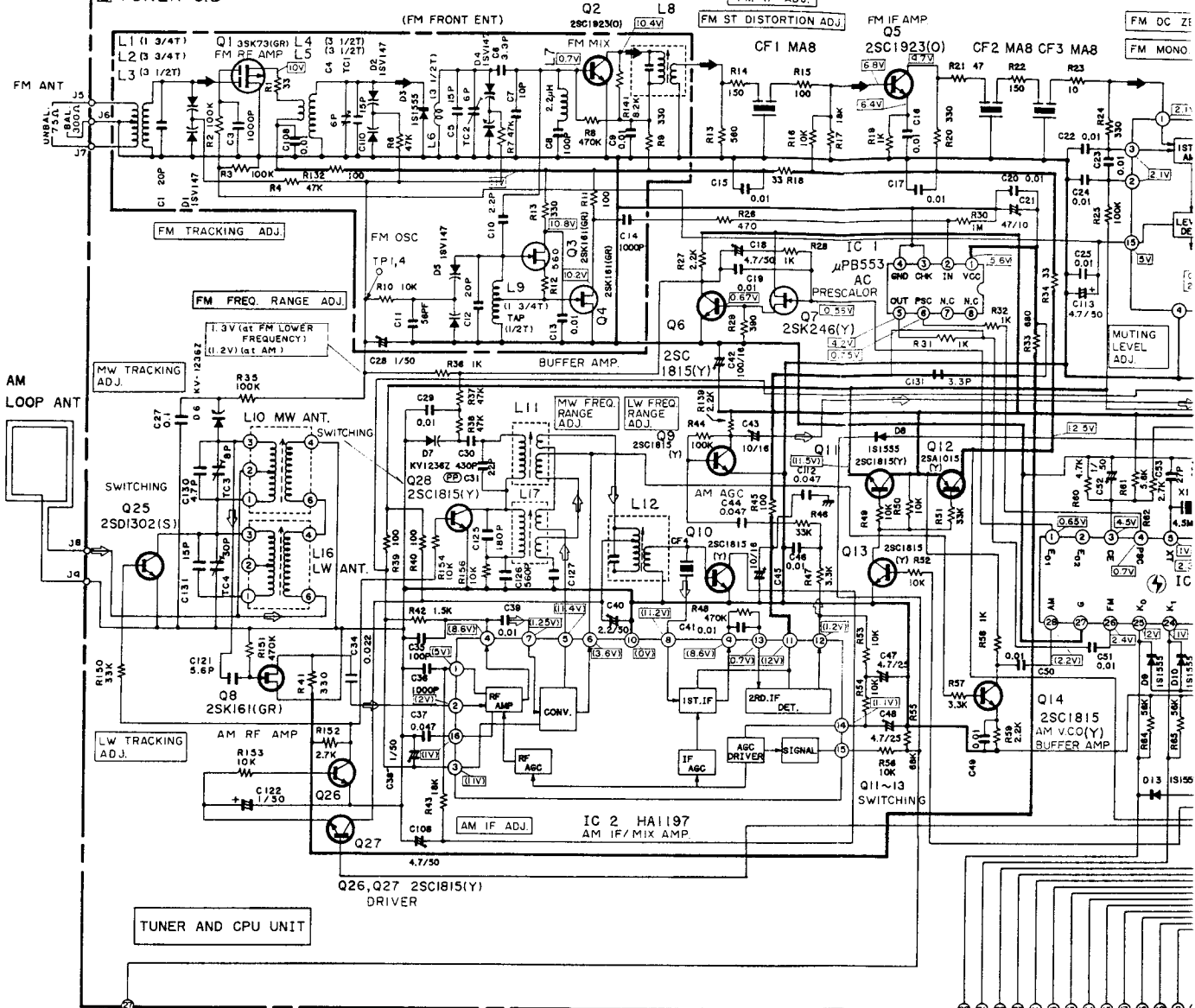

TUNER AND CPU UNIT

B SWITCH-I C.B

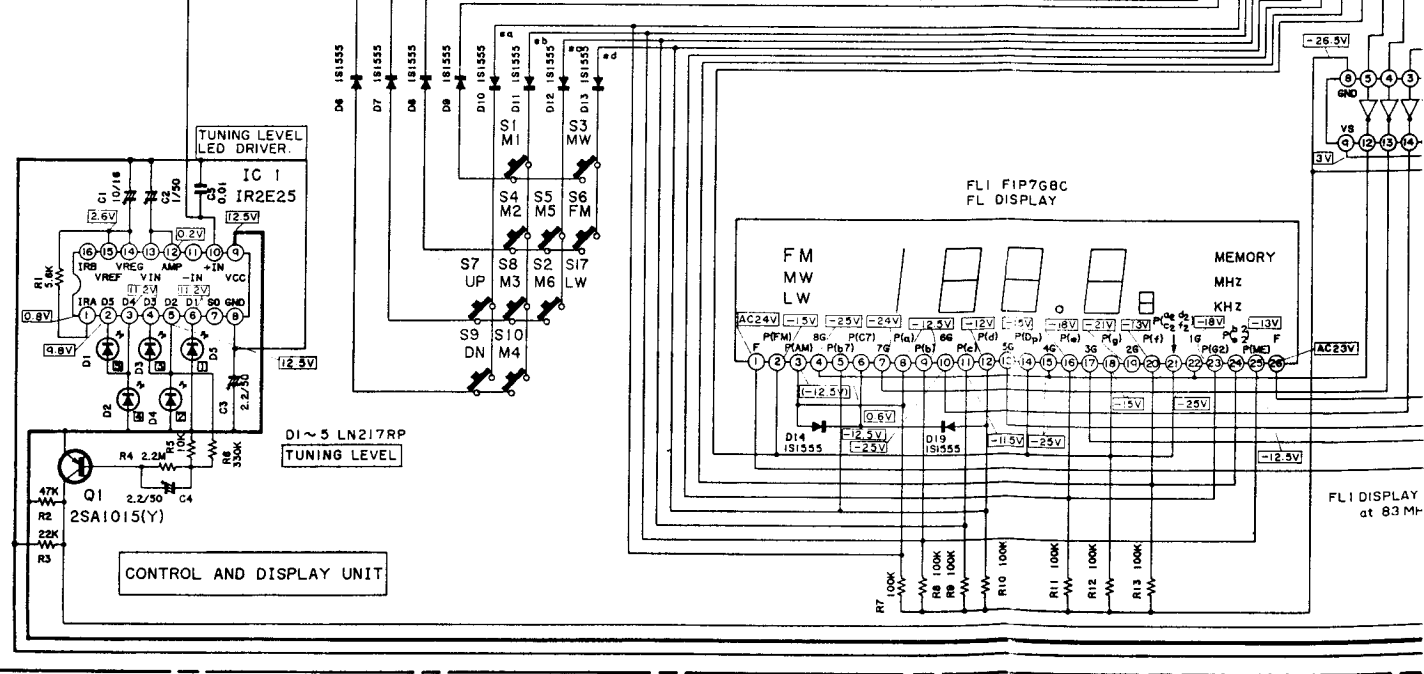

CONTROL AND DISPLAY UNIT

FL1 FIP768C

FL DISPLAY

FL1 DISPLAY at 83MHz

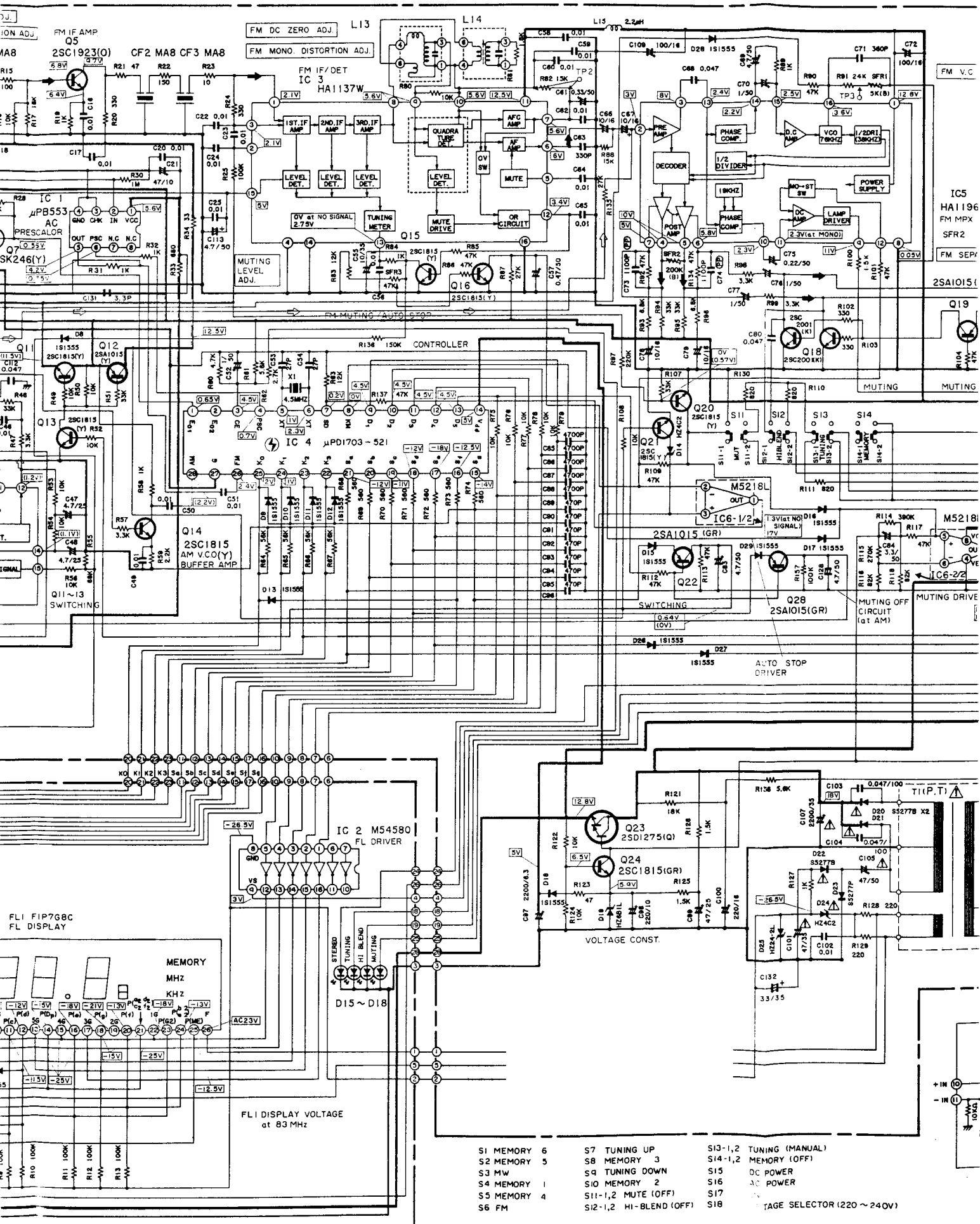

- S1 MEMORY 6
- S2 MEMORY 5
- S3 MW
- S4 MEMORY 1
- S5 MEMORY 4
- S6 FM
- S7 TUNING UP
- S8 MEMORY 3
- S9 TUNING DOWN
- S10 MEMORY 2
- S11-1,2 MUTE (OFF)
- S12-1,2 HI-BLEND (OFF)
- S13-1,2 TUNING (MANUAL)
- S14-1,2 MEMORY (OFF)
- S15 DC POWER
- S16 AC POWER
- S17
- S18 PAGE SELECTOR (220 ~ 240V)

13 14 15 16

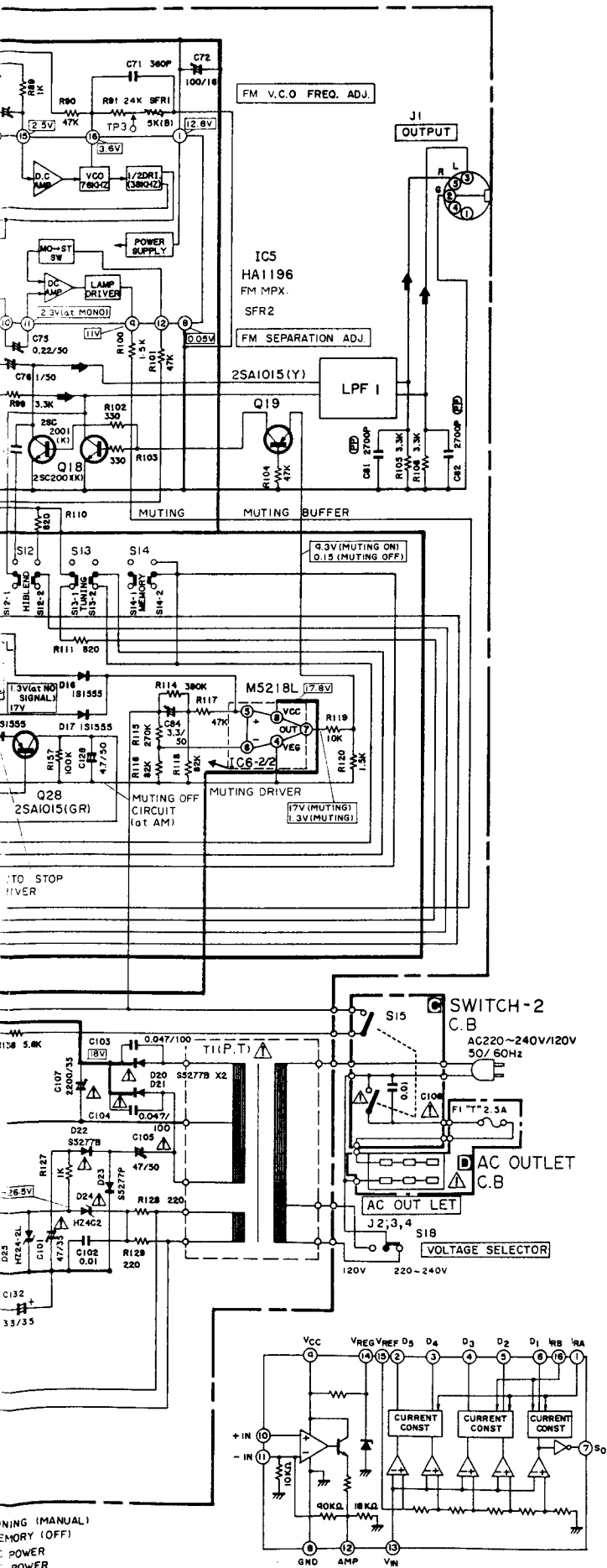

NOTES:

- 1) B (+) power supply
  - 2) Signal path  
 AM signal path.
  - 3) The voltage is the reference value measured with a tester (20 k-ohms/V DC) when there are no signals. But ( ) is with AM reception.
  - 4) Resistors with no designation have a rated power of 1/8W and a tolerance of ±5%.
  - 5) Capacitors with no designation have a dielectric strength of less than 50WV.
  - 6) The only capacitor tolerance indicated are ±5% (J) and ±10% (K).
  - 7) Ceramic capacitor symbols:  
 For temperature compensation (SL)  
 High dielectric constant system (YY)  
 High dielectric constant system (YW, YP, YZ)  
 Semiconductor ceramic  
 For temperature compensation (SH)
  - 8) Explanation of symbols  
 Mylar capacitor  
 Aluminum solid capacitor  
 Polypropylene film capacitor  
 Bi-polarized capacitor  
 Tantalum capacitor  
 Fuse resistor  
 Nonflammable resistor  
 Safety component symbol  
 This symbol is given to important parts which serve to maintain the safety of the product, and which are made to conform to special safety specifications. Therefore, when replacing a component with this symbol, make absolutely sure that you use a designated part.
- This schematic diagram is subject to change without notice in the interests of improved performance.

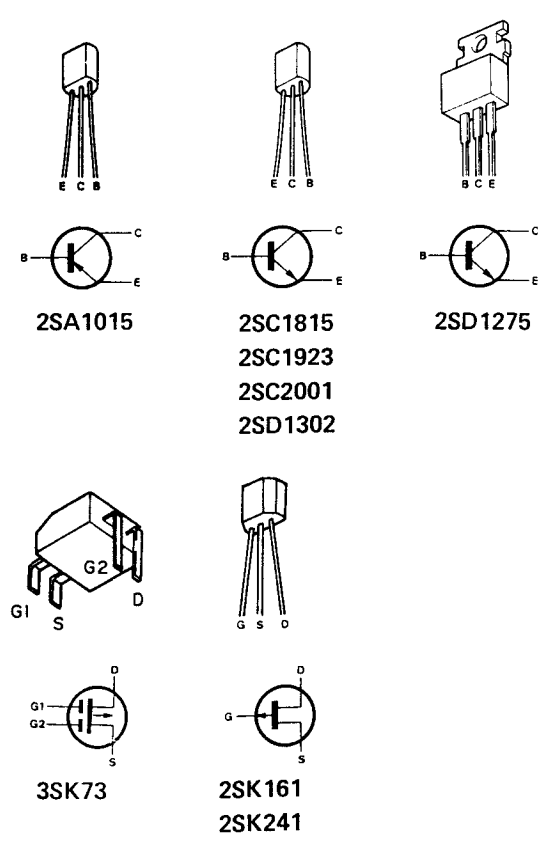

WIRING

1 2 3 4 5 6 7

A  
B  
C  
D  
E  
F  
G  
H  
I  
J

- 4. LW Tracking Adjustment  
L1, 2, 3, 4, 5, 6 ..... 108.0 MHz  
Method: Set the input of the 108.0 MHz, 20 dB and adjust L1,2,3,4,5,6 so that the distortion is reduce to minimum value.
- 13. MW Tracking Adjustment  
L10 ..... 603 kHz  
TC3 ..... 1,404 kHz
- 3. FM Frequency Range Adjustment  
L9 ..... 87.5 MHz  
Method: Adjust L9 so that the voltage of TP1 become 3V. Maximum frequency is confirmed 108.0 MHz.
- 1. FM IF Adjustment  
L8 ..... 10.7 MHz
- TP1 FM Tuning Voltage Adj. Test point
- 15. LW Tracking Adjustment  
L16 ..... 155 kHz  
TC4 ..... 353 kHz
- 12. MW Frequency Range Adjustment  
L11 ..... 531 kHz  
Method: Adjust L11 so that the voltage of TP4 become 1.2V.
- 14. LW Frequency Range Adjustment  
L17 ..... 155 kHz  
Method: Adjust L17 so that the voltage of TP4 become 1.2V
- TP3 V.C.O. Frequency Adj. Test point
- 7. FM V.C.O. Adjustment  
Settings:  
• BAND switch: FM  
• MODE switch: STEREO  
• MUTING switch: OFF  
• Test point: TP3  
• Adjustment location: SFR1  
Method:  
Adjust so that the frequency at the test points is 76kHz ± 1.5%
- 11. AM IF Adjustment  
L12 ..... 450 kHz
- TP4 AM Tuning Voltage Adj. Test point
- 5. FM DC zero Adjustment  
Settings:  
• BAND switch: FM  
• MUTING switch: OFF  
• Test point: TP2  
• Adjustment location: L13  
Method:  
Adjust L13 so that the voltage of TP2 become 0 ± 30mV.
- 6. FM Distortion (MONO) Adjustment  
Settings:  
• BAND switch: FM  
• MODE switch: MONO  
• MUTING switch: OFF  
• Input signal: 98.0 MHz, 60 dB, MOD 75 kHz  
• Adjustment location: L14  
Method:  
Adjust L14 so that the distortion is reduce to minimum value.
- TP2 FM Center Voltage Adj. Test point
- 9. FM Distortion (STEREO) Adjustment  
Settings:  
• BAND switch: FM  
• MUTING switch: OFF  
• Input signal: 98.0 MHz, 60 dB, L/R Pilot 10 kHz  
• Test point: TP2  
• Adjustment location: L8  
Method:  
Adjust L8 so that the distortion is reduce to minimum value.  
Rating:  
Less than 0.5%

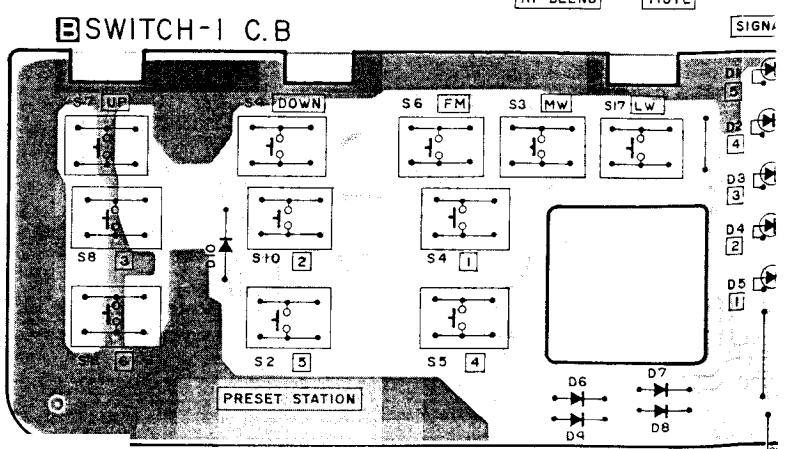
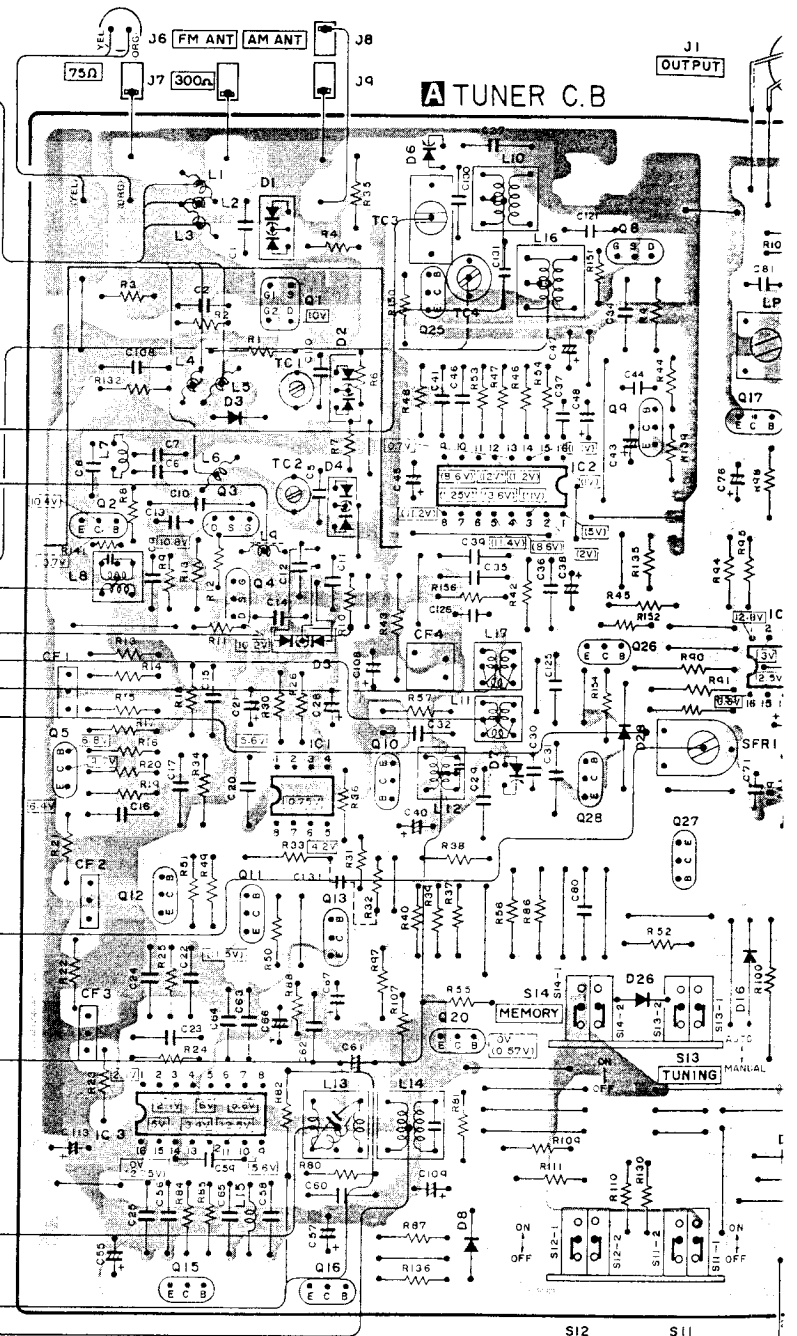

NOTES (1) Earth pattern Others pattern  
 (2) The voltage is the reference value measur  
 But ( ) is with AM reception.

6 7 8 9 10 11 12 13

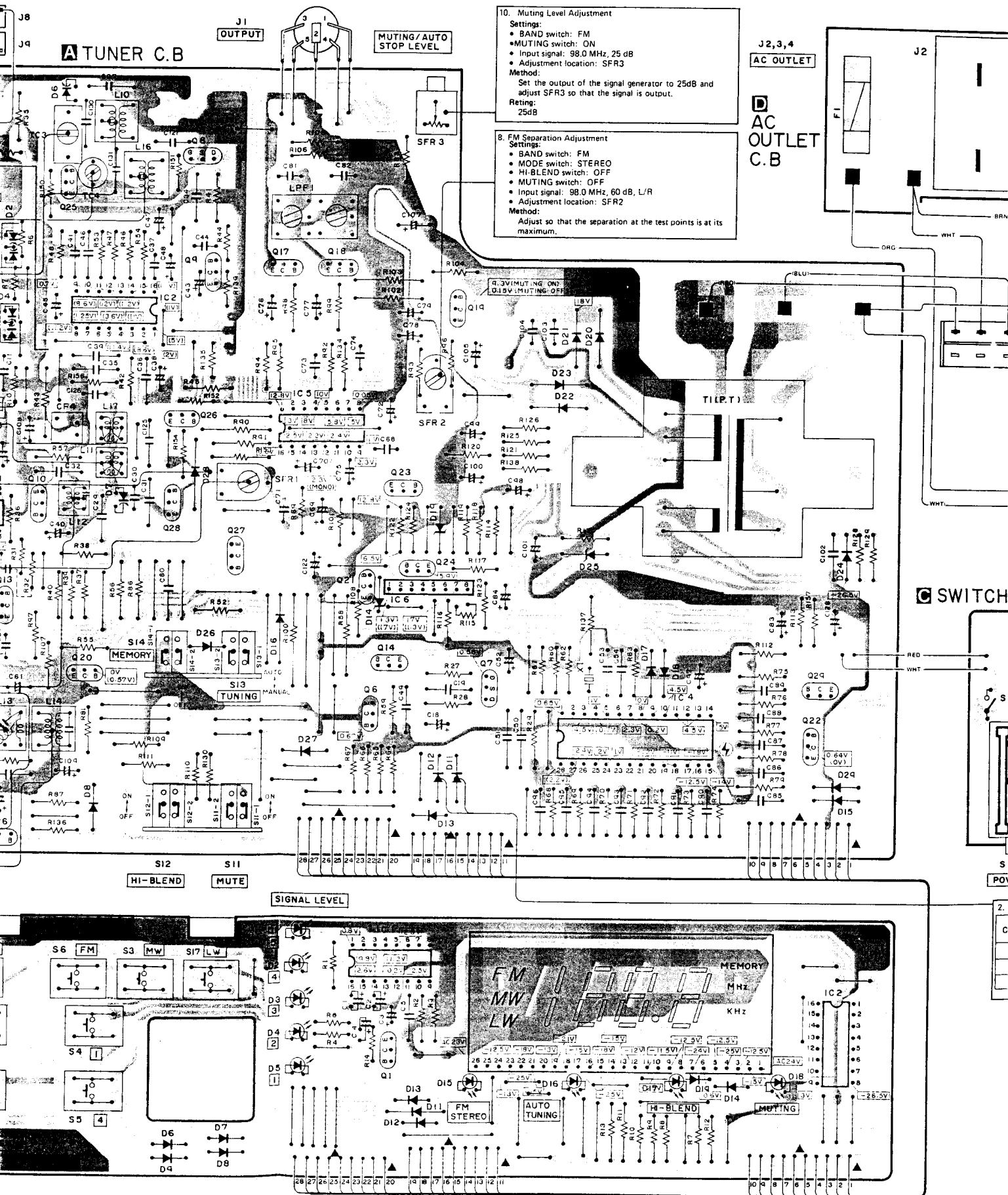

10. Muting Level Adjustment  
 Settings:  
 • BAND switch: FM  
 • MUTING switch: ON  
 • Input signal: 98.0 MHz, 25 dB  
 • Adjustment location: SFR3  
 Method:  
 Set the output of the signal generator to 25dB and adjust SFR3 so that the signal is output.  
 Rating:  
 25dB

8. FM Separation Adjustment  
 Settings:  
 • BAND switch: FM  
 • MODE switch: STEREO  
 • HI-BLEND switch: OFF  
 • MUTING switch: OFF  
 • Input signal: 98.0 MHz, 60 dB, L/R  
 • Adjustment location: SFR2  
 Method:  
 Adjust so that the separation at the test points is at its maximum.

0.3V: MUTING ON  
 0.15V: MUTING OFF

SWITCH

S12 HI-BLEND  
 S11 MUTE

SIGNAL LEVEL

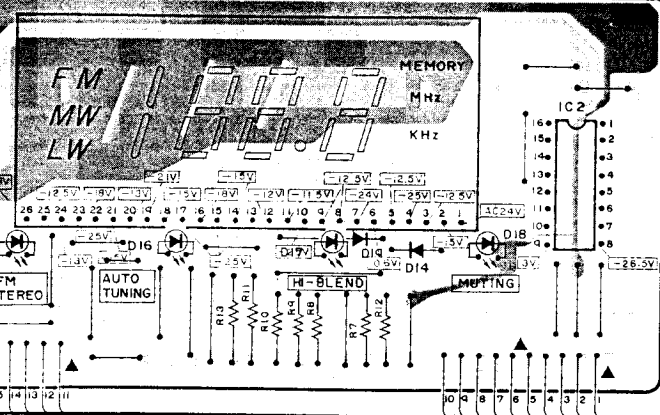
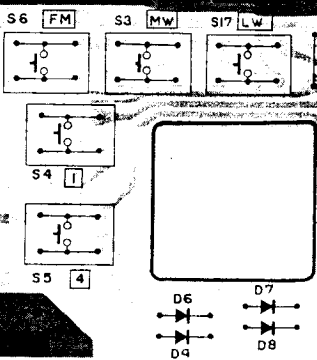



Earth pattern Others pattern

voltage is the reference value measured with a tester (20 K ohms/V DC) when there are no signals.

) is with AM reception.

12 13 14 15 16 17 18 19

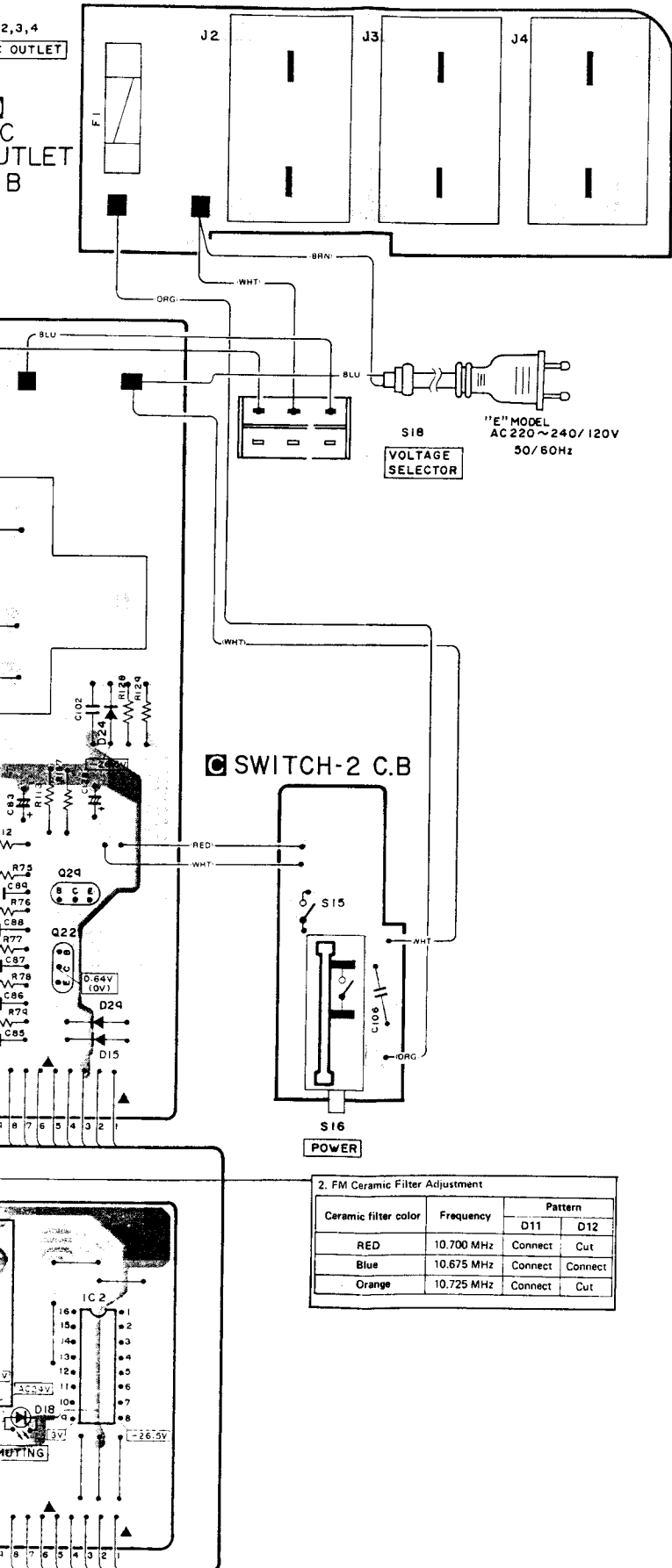

**C-MOS IC handling precaution**

The C-MOS IC's construction makes this part susceptible to damage by static electricity and so take sufficient care in regard to following articles.

1. Need to be put on conductive sheet, to be put in a metallic box and to be wrapped by aluminium foil for transportation and deposit.
2. To use solder iron less than 40W (less than 260°C) of power consumption for soldering. But do not overheat more than 10 second.
3. Do not perform a conductivity test with a tester, etc. Refer to the circuit voltages of each part.
4. The ICs on the electrical parts which are indicated by an C-MOS IC symbol mark (⚡).

2. FM Ceramic Filter Adjustment

Ceramic filter color	Frequency	Pattern	
		D11	D12
RED	10.700 MHz	Connect	Cut
Blue	10.675 MHz	Connect	Connect
Orange	10.725 MHz	Connect	Cut

LM6402A-133 Port table

Pin No.	Port	Function
①, ④②	CL $\phi$ , CLI	Clock signal
②	K-MS	Set to the MS mode when the input is at "HIGH" level.
③	K-REC	Mechanism control REC KEY input.
④	K-RWD	Mechanism control RWD KEY input. When S810 is set to ON at "HIGH" level during output of the O-T.M SW "LOW" level, timer repeat play is done.
⑤	K-PLY	Mechanism control PLAY KEY input.
⑦	RESET	MPU is reset and all the output ports are set open when inputting the "LOW" level (1.2V or less).
⑧	K-F.F	Mechanism control FF key input. When S810 is set to ON at "HIGH" level during output of the O-T.M SW "LOW" level, timer REC operation is done.
⑨	K-STOP	Mechanism control STOP KEY input. Cassette switch input.
⑩	K-PAUSE	Mechanism control PAUSE KEY input.
⑪	K-R.M	Mechanism control REC MUT KEY input.
⑫	D-PHONO REC	Outputs "LOW" level during PHONO REC.
⑬	D-TUNER REC	Outputs "LOW" level during TUNER REC.
⑭	D-AUX REC	Outputs "LOW" level during AUX REC.
⑮	D-MS	Outputs the "LOW" level for flashing during MS operation.
⑯	D-FWD	Mechanism control PLAY display.
⑰	D-PAUSE	Mechanism control PAUSE display.
⑱	D-R.M	Mechanism control REC. MUT display.
⑲	O-REC	Outputs "LOW" level during the REC mode.
⑳	V <sub>SS</sub>	V <sub>SS</sub> (power pin)
㉑	O-PMT	Set to the "HIGH" level for 2 sec. after POWER ON, and then outputs the "LOW" level.
㉒	O-LMT	LINE MUTE (LINE OUT MUT)
㉓	O-RMT	REC MUTE (REC AMP muting)
㉔	O-CRM	Set to the "HIGH" level only during CUE REVIEW.
㉕	M-RVS	Sub-motor reverse rotation output.

Pin No.	Port	Function
㉖	M-FWD	Sub-motor forward rotation output.
㉗	S-PAUSE	PAUSE level drive output.
㉘	S-PLAY	Differential chassis drive output.
㉙	I-REC ENA.	Safety switch input. "HIGH" level recording possible.
㉚	I-A.S-SIG	AUTO STOP signal input.
㉛	I-M,S-SIG	MUSIC SCAN signal input.
㉜	O-T.M SW	Set to the "LOW" level instantaneously during POWER ON, during AUTO STOP in PLAY, during AUTO STOP in RWD. Outputs the "LOW" level instantaneously.
㉝	O-PHONO-START	(30ms) when the PHONO REC key is input. Outputs the "LOW" level instantaneously.
㉞	O-P.B START	When changing over to PLAY, PLAY PAUSE from other modes.
㉟	O-P.B	Set to the "LOW" level in the ordinary mode (during PLAY) and "HIGH" level (Dolby IC record/play selection) during recording.
㊱	F-PHONO	PHONO FUNCTION KEY input. PHONO START when this input and the REC KEY input are done simultaneously.
㊲	F-TUNER	TUNER FUNCTION KEY input.
㊳	F-AUX	AUX FUNCTION KEY input.
㊴	K-SYNC	PLAY SYNC input effective only during PHONO REC.
㊵	V <sub>DD</sub>	V <sub>DD</sub> (power pin).

Function
Motor forward rotation out-
Level drive output.
ential chassis drive output.
switch input. "HIGH" recording possible.
STOP signal input.
C SCAN signal input.
the "LOW" level instantly during POWER ON, AUTO STOP in PLAY, AUTO STOP in RWD. ts the "LOW" level instantly.
when the PHONO REC input. Outputs the "LOW" instantaneously.
changing over to PLAY, PAUSE from other modes.
the "LOW" level in the try mode (during PLAY) "HIGH" level (Dolby IC relay selection) during recor-
FUNCTION KEY input. START when this input e REC KEY input are done neously.
R FUNCTION KEY input.
UNCTION KEY input.
SYNC input effective only PHONO REC.
power pin).

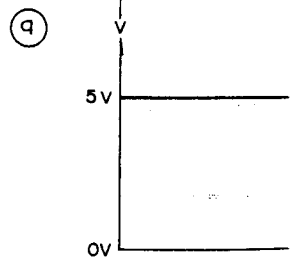
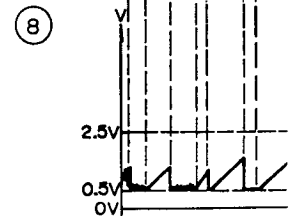
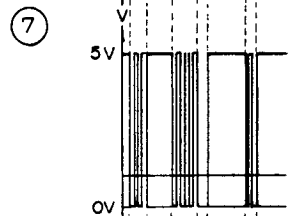
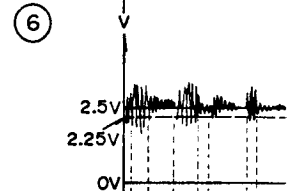
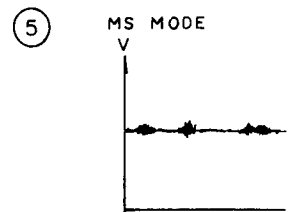
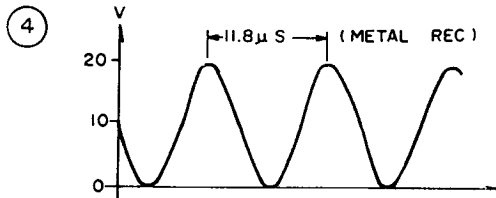
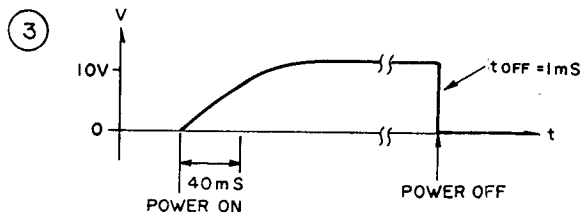
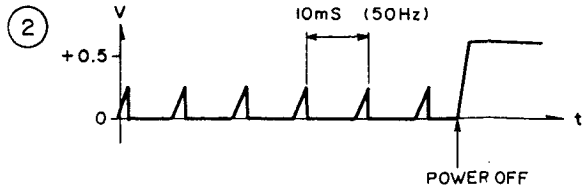
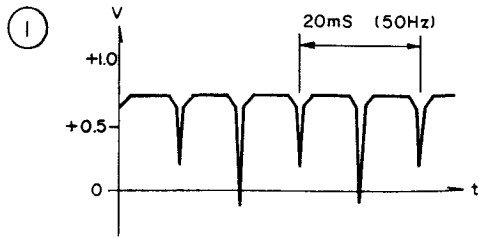

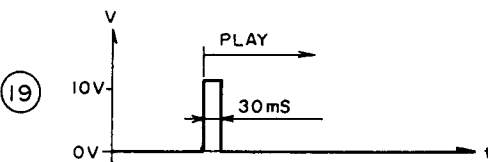
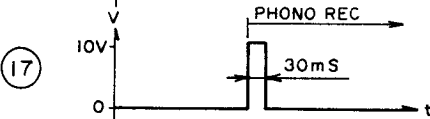
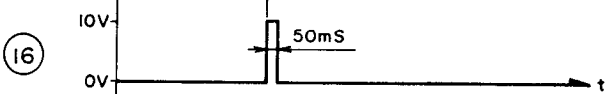
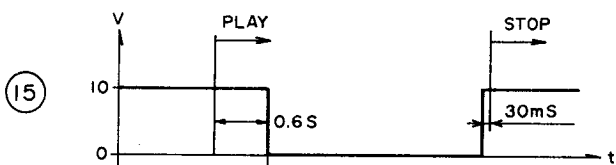
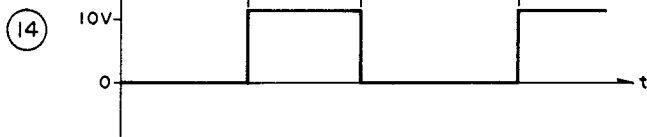
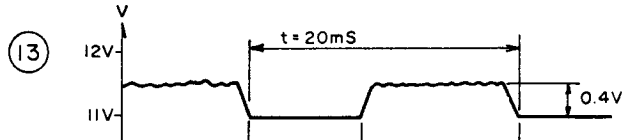
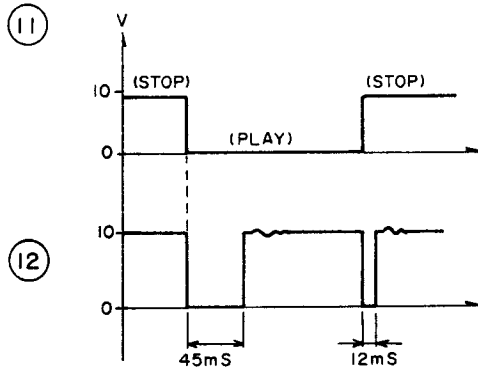
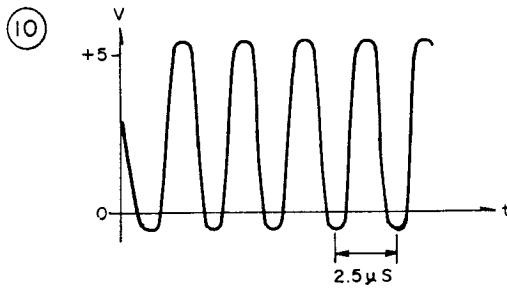
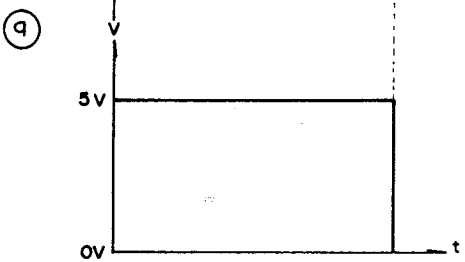
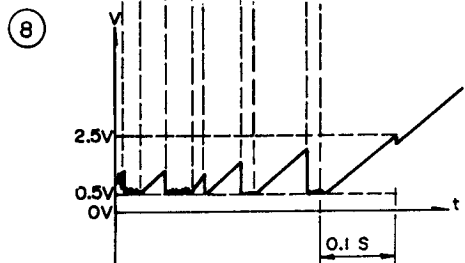
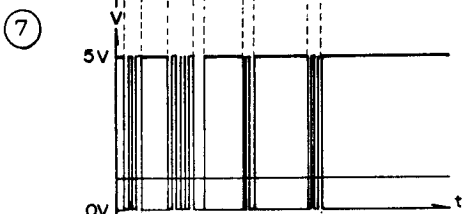
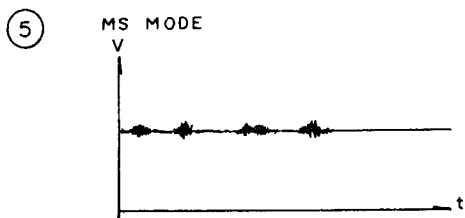

ELECTRICAL MAIN PARTS LIST

Symbol No.	Part No.	Description
<b>◀ MAIN CIRCUIT BOARD SECTION ▶</b>		
PCB-A	*	Main circuit board
IC301	87-027-910-01	IC, $\mu$ PC1228H
IC401	87-027-895-01	IC, M5218
⊕ IC601	87-027-538-01	IC, $\mu$ PD4069
IC602	87-027-909-01	IC, M54523P
⊕ IC701	82-189-640-01	IC, LM6402A-133
⊕ IC702	87-027-708-01	IC, $\mu$ PD4025
⊕ IC703	87-027-298-01	IC, CMOS4001NOR
Q101	89-106-833-41	Transistor, 2SA683NCRS
Q102, 103, 105, 106, 203, 205, 206, 207, 301, 302, 303, 304, 401, 402, 403, 404, 405, 406, 501, 502, 701, 702	89-309-456-01	Transistor, 2SC945L (P)
Q104	89-412-653-01	Transistor, 2SD1265 OP (G model only)
Q201, 202, 503, 504, 505, 506	89-328-785-61	Transistor, 2SC2878 AB
Q204, 601, 602	89-109-521-01	Transistor, 2SA952K
Q208, 209	89-320-011-01	Transistor, 2SC2001K
Q210, 507, 508	89-110-155-01	Transistor, 2SA1015 (GR)
Q603	89-412-653-41	Transistor, 2SD1265 (OP)
D101, 102, 103, 104, 109, 110	87-027-365-01	Diode, S5277B
D106, 111, 201, 202, 203, 401, 402, 503, 504, 601, 602, 701	87-027-097-01	Diode, IS1555
D107	87-027-474-01	Zener diode, HZ11A2
D108	87-027-286-01	Zener diode, HZ5C1
D205, 505	87-027-393-01	Zener diode, HZ4C2
D204, 501, 502	87-027-606-01	Zener diode, HZ7C2L
L201	82-189-643-01	Bias OSC coil
L202	82-401-661-01	Choke coil, 600 $\mu$ H
L401, 402	87-005-159-01	Trap coil, 85K
L403, 404	87-003-070-01	Choke coil, 5.6mH
L701	82-189-642-01	OSC coil, LM6400
RY201	87-045-202-01	Lead relay, RP-13A
J501, 701	82-184-668-01	Jack plate ass'y, DINX2 (REC/PLAY, CONTROL)
SFR201, 202, 301, 302	87-021-745-01	Semi-fixed resistor, 47k $\Omega$ -B
SFR303, 304	87-021-744-01	Semi-fixed resistor, 33k $\Omega$ -B
SFR401, 402	87-021-739-01	Semi-fixed resistor, 2.2k $\Omega$ -B
SFR501, 502	87-021-746-01	Semi-fixed resistor, 100k $\Omega$ -B
PIN1	87-049-151-01	Pin, 11P
PIN2	82-189-649-01	Pin, 9P
PIN3, 4	87-049-038-01	Pin, 3P
PIN5	87-049-150-01	Pin, 10P
<b>&lt; Resistors &gt;</b>		
⚠ R106	87-029-088-01	1.5 $\Omega$ $\frac{1}{4}$ W Fuse resistor (H, HU, E, models only)
⚠ R106	87-029-370-01	2.2 $\Omega$ $\frac{1}{4}$ W Fuse resistor (G model only)
⚠ R207	87-029-094-01	15 $\Omega$ $\frac{1}{4}$ W Fuse resistor
R301, 302	88-175-224-01	220k $\Omega$ $\frac{1}{4}$ W LN
<b>&lt; Capacitors &gt;</b>		
C104	87-015-981-01	220 $\mu$ F 25V Electrolytic
C108, 606	87-015-982-01	33 $\mu$ F 25V Electrolytic
C208	87-014-081-01	0.01 $\mu$ F PP
C209	87-014-077-01	6800pF PP
C303, 304	87-015-953-01	4.7 $\mu$ F 35V Electrolytic LL
C501, 502	87-015-951-01	1 $\mu$ F 50V Electrolytic LL

Symbol No.	Part No.	Description
<b>◀ DOLBY-NR CIRCUIT BOARD SECTION ▶</b>		
IC1, 2	87-027-905-01	Dolby-NR Unit, 2T
L1, 2	87-027-862-01	IC, HA12038
PIN	87-005-155-01	Coil, 36mH
PIN	87-049-117-01	Pin, 7P
PIN	87-049-119-01	Pin, 9P
<b>&lt; Resistors &gt;</b>		
R9, 10	87-025-271-01	5.1k $\Omega$ $\frac{1}{4}$ W Meta
R11, 12	87-025-295-01	15k $\Omega$ $\frac{1}{4}$ W Meta
R35, 36	87-025-296-01	56k $\Omega$ $\frac{1}{4}$ W Meta
<b>&lt; Capacitors &gt;</b>		
C15, 16	87-015-617-01	10 $\mu$ F 16V Elect
C21, 22, 23, 24, 45, 46	87-015-366-01	0.15 $\mu$ F 10V Alur
<b>◀ SWITCH CIRCUIT BOARD SECTION ▶</b>		
PCB-C	*	Switch circuit board
D801, 802, 803, 806	87-027-542-01	LED, LN217RP (T REC, PHONO REC)
D804	87-027-543-01	LED, LN317GP (P
D805	87-027-671-01	LED, LN417YP (P
D807	87-027-926-01	LED, GL-9ND2 (IF
VR801	82-189-621-01	Volume, 50k $\Omega$ -A (
VR802	82-189-622-01	Volume, 50k $\Omega$ -B (
S801, 802, 803, 804, 805, 806, 807, 808, 809	87-031-712-01	Tact switch (REC I F, FWD/CUE, PLA PHONO REC, TU REC)
S810	87-031-740-01	Slide switch (TIME
S811, 812, 813, 814	87-031-737-01	Push-switch (DOL B/C, INTRO PLAY INTRO PLAY/MS.
<b>◀ POWER CIRCUIT BOARD SECTION ▶</b>		
PCB-D	*	Power circuit board
⚠ S851	87-031-749-01	Push-switch (POW)
⚠ F851	87-035-216-01	Fuse, "T" 200mA (H, HU, E models)
⚠ F851	87-035-080-01	Fuse, "T" 160mA
⚠	87-098-008-01	Fuse label, "T" 16
⚠	87-033-147-01	Fuse clamp
⚠	82-304-743-01	IP terminal
<b>&lt; Capacitor &gt;</b>		
⚠ C801	87-019-112-01	0.01 $\mu$ F Spar
<b>◀ DISPLAY CIRCUIT BOARD SECTION ▶</b>		
	82-189-641-01	Display unit (with
<b>◀ AUTO STOP CIRCUIT BOARD SECTION ▶</b>		
PCB-F	81-505-605-01	Auto stop circuit b
CP901	87-027-644-01	Photo sensor, NJL
<b>◀ FUSE CIRCUIT BOARD SECTION ▶ = "H"</b>		
⚠ PCB-G	*	Fuse circuit board
⚠ Q104	89-412-653-41	Transistor, 2SD12
⚠ F852	87-035-190-01	Fuse, "T" 2A
⚠	87-033-147-01	Fuse clamp
⚠ PIN6	87-049-038-01	Pin, 3P

⚠ Safety component symbol  
This symbol is given to important parts which serve the safety of the product, and which are made to conform to safety specifications. Therefore, when replacing a component with this symbol, make absolutely sure that you use a design

Symbol No.	Part No.	Description
<b>DOLBY-NR CIRCUIT BOARD SECTION</b>		
	87-027-905-01	Dolby-NR Unit, 2H (W/PCB-B)
	87-027-862-01	IC, HA12038
	87-005-155-01	Coil, 36mH
	87-049-117-01	Pin, 7P
	87-049-119-01	Pin, 9P
	<b>&lt; Resistors &gt;</b>	
	87-025-271-01	5.1kΩ ¼W Metal film
	87-025-295-01	15kΩ ¼W Metal film
	87-025-296-01	56kΩ ¼W Metal film
	<b>&lt; Capacitors &gt;</b>	
	87-015-617-01	10μF 16V Electrolytic LL
	87-015-366-01	0.15μF 10V Aluminum solid

**SWITCH CIRCUIT BOARD SECTION**

Symbol No.	Part No.	Description
	*	Switch circuit board
	87-027-542-01	LED, LN217RP (TUNER REC, AUX REC, PHONO REC, REC MUTE)
	87-027-543-01	LED, LN317GP (PLAY)
	87-027-671-01	LED, LN417YP (PAUSE)
	87-027-926-01	LED, GL-9ND2 (INTRO PLAY/MS)
	82-189-621-01	Volume, 50kΩ-A (RECORD LEVEL)
	82-189-622-01	Volume, 50kΩ-B (NORMAL BIAS FINE)
	87-031-712-01	Tact switch (REC MUTE, PAUSE, STOP, F. FWD/CUE, PLAY, REW/REVIEW, PHONO REC, TUNER REC, CD/AUX REC)
	87-031-740-01	Slide switch (TIMER)
	87-031-737-01	Push-switch (DOLBY-NR, DOLBY-NR B/C, INTRO PLAY/MS ON/OFF, INTRO PLAY/MS.)

**POWER CIRCUIT BOARD SECTION**

Symbol No.	Part No.	Description
	*	Power circuit board
	87-031-749-01	Push-switch (POWER)
	87-035-216-01	Fuse, "T" 200mA (H, HU, E models only)
	87-035-080-01	Fuse, "T" 160mA (G model only)
	87-098-008-01	Fuse label, "T" 160mA (G model only)
	87-033-147-01	Fuse clamp
	82-304-743-01	IP terminal
	<b>&lt; Capacitor &gt;</b>	
	87-019-112-01	0.01μF Spark killer

**DISPLAY CIRCUIT BOARD SECTION**

82-189-641-01	Display unit (with PCB-E)
---------------	---------------------------

**AUTO STOP CIRCUIT BOARD SECTION**

81-505-605-01	Auto stop circuit board
87-027-644-01	Photo sensor, NJL-5141EA

**FUSE CIRCUIT BOARD SECTION = "H, HU, E" models only**

Symbol No.	Part No.	Description
	*	Fuse circuit board
	89-412-653-41	Transistor, 2SD1265 (OP)
	87-035-190-01	Fuse, "T" 2A
	87-033-147-01	Fuse clamp
	87-049-038-01	Pin, 3P

Safety component symbol

Symbol is given to important parts which serve to maintain safety of the product, and which are made to conform to special specifications. Therefore, when replacing a component with a symbol, make absolutely sure that you use a designated part.

Symbol No.	Part No.	Description
<b>◀ MISCELLANEOUS ▶</b>		
△T901	82-189-613-01	Power transformer (H, HU, E models only)
△T901	82-189-615-01	Power transformer (G model only)
RPH	87-046-226-01	REC/PB head
EH	87-046-196-01	Erase head
M901	87-045-135-01	Motor, DC EG (MAIN)
M902	81-505-604-11	Reel motor (SUB)
D901	87-027-944-01	LED, SLF301C (CASSETTE)
SOL901, 902	81-505-603-01	Solenoid, 9ME-A (PLAY, PAUSE)
S901, 902	81-505-601-01	Leaf switch (PLAY, PAUSE)
S903, 905	81-505-607-01	Leaf switch AU (CASSETTE, REC ENABLE)
S904, 906	81-505-602-01	Leaf switch (METAL, CrO <sub>2</sub> )
△S951	87-031-586-01	Rotary switch (VOLTAGE SELECTOR)
△	87-085-184-01	Cord bushing (H, HU models only)
△	87-034-962-01	AC power cord (H, HU models only)
△	87-788-674-01	AC power cord (E model only)
△	87-034-892-01	AC power cord (G model only)
△	87-085-185-01	Holder, AC power cord (E, G models only)
CON1	81-505-633-01	Connector ass'y, 11P
CON2	81-505-631-01	Connector ass'y, 9P
CON3	89-051-003-01	Connector ass'y, 3P
CON5	81-505-632-01	Connector ass'y, 10P
CON6	89-051-003-01	Connector ass'y, 3P (H, HU, E models only)

**Note; Combination Circuit Board**

The parts on the electrical parts list which are indicated by an asterisk (\*) are supplied as one single combined circuit board. Therefore, they will not be supplied separately. If this becomes necessary, please order the entire circuit board.

**Combination circuit board 82-189-601-21**

PCB-A	82-189-602-21
PCB-C	82-189-603-21
PCB-D	82-189-604-21
PCB-G	82-189-605-21

• Ceramic capacitor

Capacitor	Parts code
47pF	024
120pF	033
220pF	036
270pF	037
390pF	039
470pF	040
1000pF	044
0.01μF	047

**C-MOS IC handling precaution**

The C-MOS IC's construction makes this part susceptible to damage by static electricity and so take sufficient care in regard to following articles.

1. Need to be put on conductive sheet, to be put in a metallic box and to be wrapped by aluminium foil for transportation and deposit.
2. To use solder iron less than 40W (less than 260°C) of power consumption for soldering. But do not overheat more than 10 second.
3. Do not perform a conductivity test with a tester, etc. Refer to the circuit voltages of each part.
4. The ICs on the electrical parts which are indicated by an C-MOS IC symbol mark (⊕).

WIRING-1

1	2	3	4	5	6
---	---	---	---	---	---

Description

- Transformer
- (E models only)
- Transformer (G model only)
- Head
- id
- AC EG (MAIN)
- or (SUB)
- F301C (CASSETTE)
- 9ME-A (PLAY, PAUSE)
- ch (PLAY, PAUSE)
- ch AU (CASSETTE, PAUSE)
- ch (METAL, CrO<sub>2</sub>)
- Switch (VOLTAGE SELECTOR)
- hing (H, HU models only)
- cord (H, HU models only)
- cord (E model only)
- cord (G model only)
- AC power cord (E, G models only)
- or ass'y, 11P
- or ass'y, 9P
- or ass'y, 3P
- or ass'y, 10P
- or ass'y, 3P
- (E models only)

h are indicated by an  
mbined circuit board.  
ately. If this becomes  
d.

21

susceptible to damage  
re in regard to follow-

e put in a metallic box  
or transportation and

han 260°C of power  
verheat more than 10

a tester, etc. Refer to

re indicated by an C-

A  
B  
C  
D  
E  
F  
G  
H  
I  
J

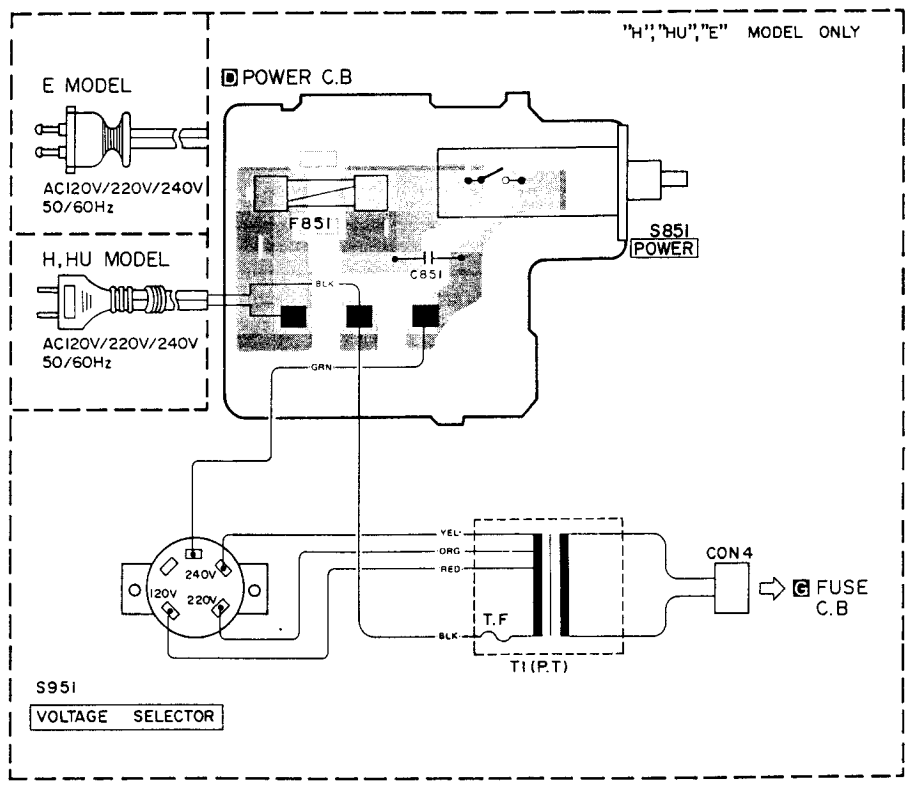
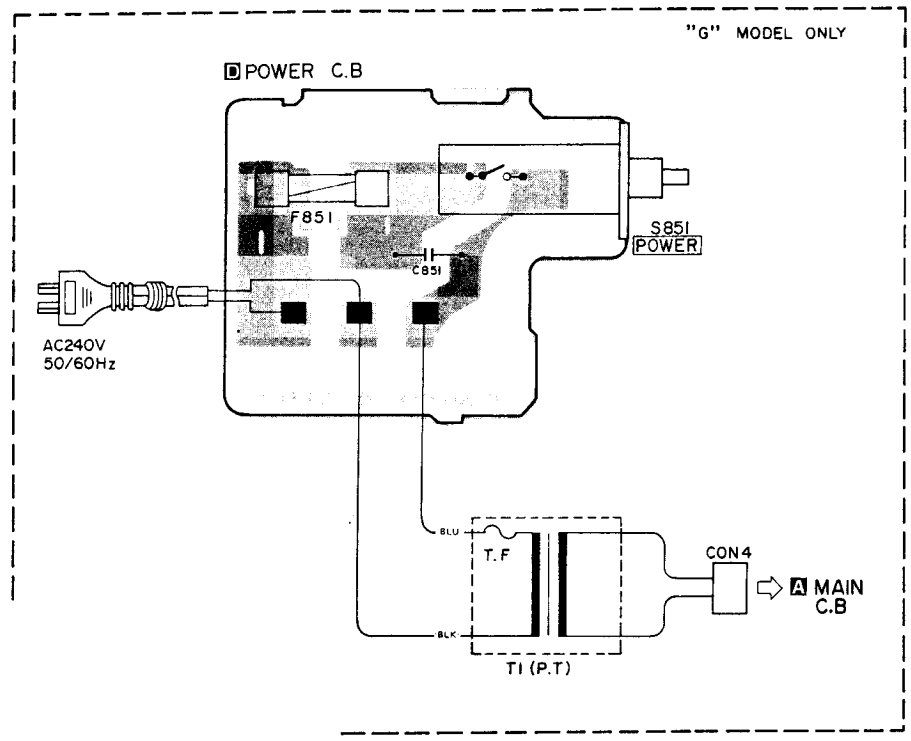





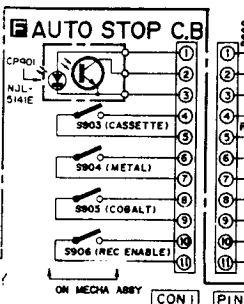
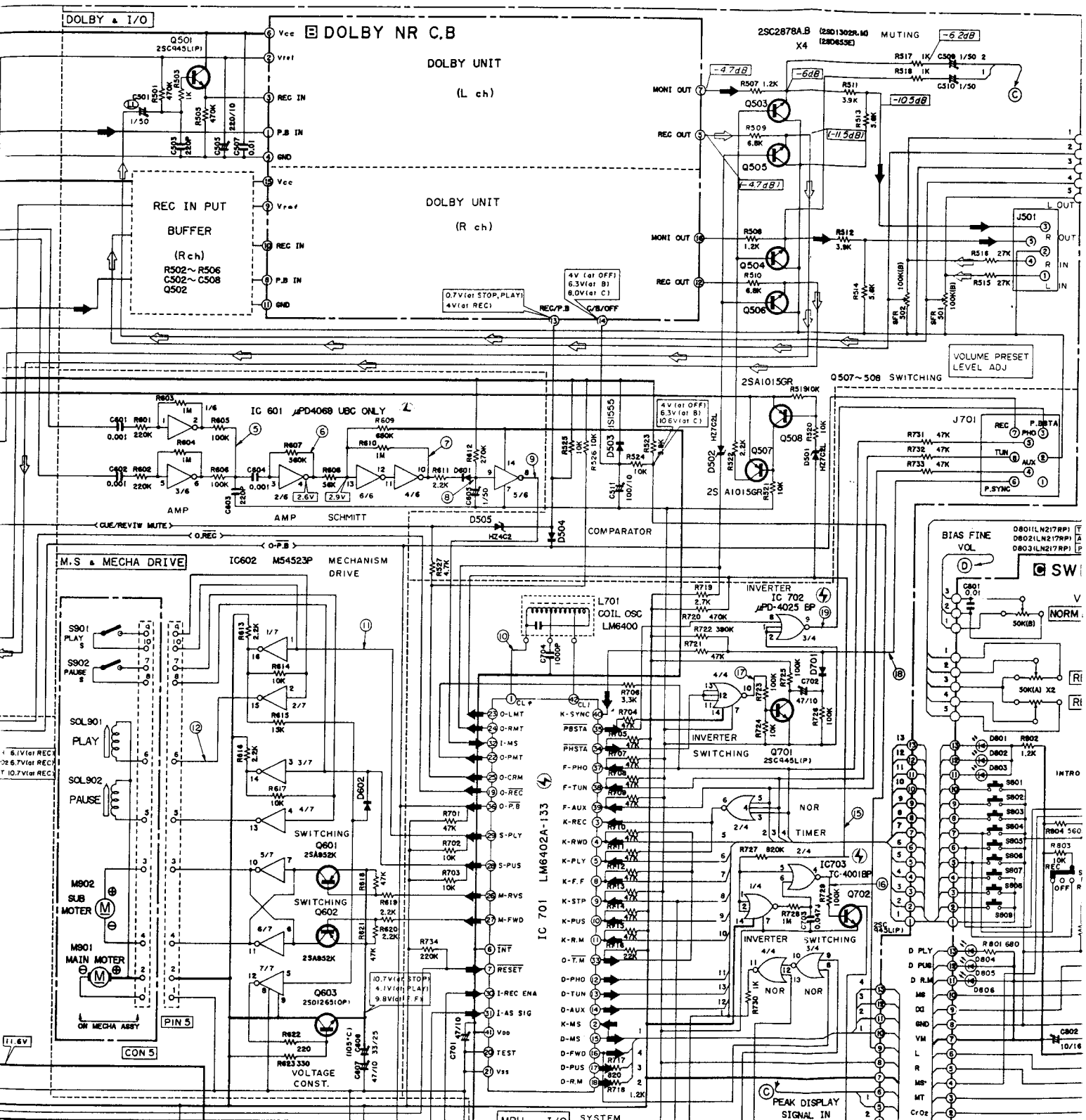

- LED CASSETTE D901 SLF301F
- LH: LH TAPE
- CrO2: COBALT TAPE
- MT: METAL TAPE
- S801 REC MUTE
- S802 PAUSE
- S803 STOP
- S804 F. FWD/CUE
- S805 PLAY
- S806 REW/REVIEW
- S807 PHONO REC
- S808 TUNER REC
- S809 CD/AUX REC
- S810 TIMER/PLAY REPEAT
- S811 DOLBY-NR (OFF)
- S812 DOLBY-NR B/C (C)
- S813 INTRO PLAY MS (OFF)
- S814 INTRO PLAY/MS (INTRO)
- S951 POWER
- S901 PLAY
- S902 PAUSE
- S903 CASSET
- S904 METAL
- S905 CrO2
- S906 REC EN
- S951 VOLTAGE (H. HU. E)

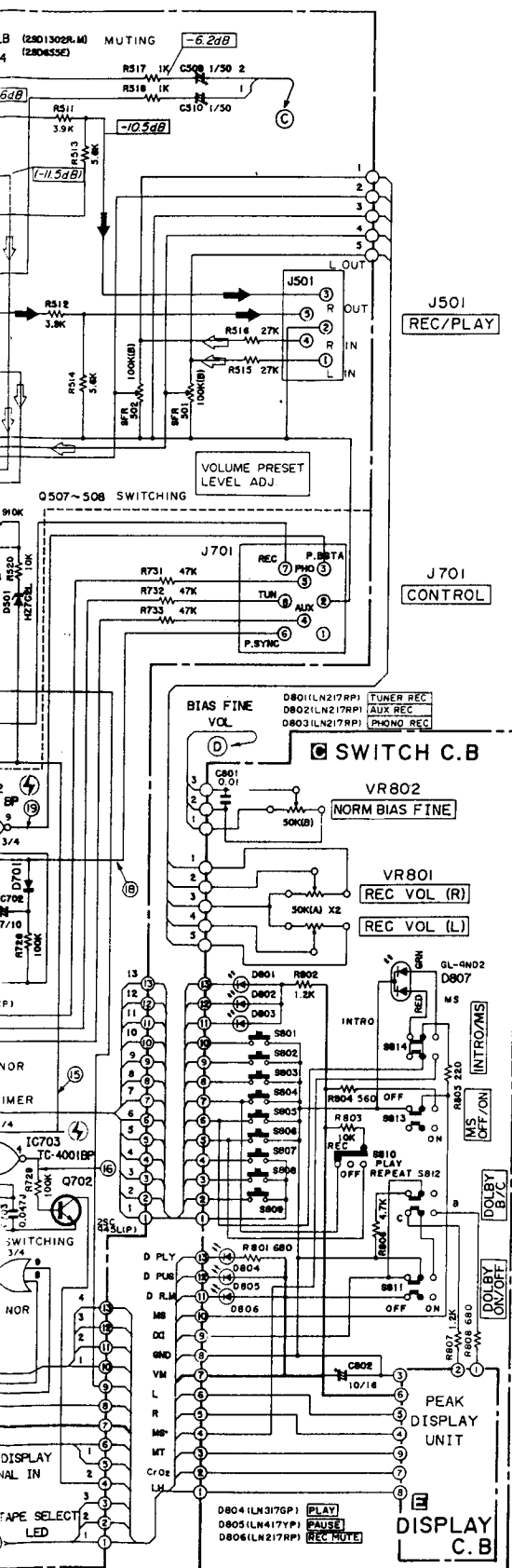

NOTES:

- 1) B (+) power supply
- 2) Signal path  
 Rec path,
- 3) The voltage is the reference value measured with a tester (20 k-ohms/V DC) when there are no signals. But ( ) is with AM reception or recording. An asterisk (\*) indicates that the value was measured with a vacuum-tube voltmeter during recording.
- 4) Resistors with no designation have a rated power of 1/8W and a tolerance of ±5%.
- 5) Capacitors with no designation have a dielectric strength of less than 50WV.
- 6) The only capacitor tolerance indicated are ±5% (J) and ±10% (K).
- 7) Ceramic capacitor symbols:  
 For temperature compensation (SL)  
 High dielectric constant system (YY)  
 High dielectric constant system (YW, YP, YZ)  
 Semiconductor ceramic
- 8) Explanation of symbols  
 Mylar capacitor  
 Aluminum solid capacitor  
 Polypropylene film capacitor  
 Bi-polarized capacitor  
 Low-leakage capacitor  
 Tantalum capacitor  
 Fuse resistor  
 Nonflammable resistor  
 Low noise resistor

Safety component symbol

This symbol is given to important parts which serve to maintain the safety of the product, and which are made to conform to special safety specifications. Therefore, when replacing a component with this symbol, make absolutely sure that you use a designated part.

• This schematic diagram is subject to change without notice in the interests of improved performance.

MECHA MODE				(REC)		M. S		
	MPU	F.FWD	REW	STOP	PLAY	PLAY PARSE	CUE	REVIEW
M-FWD	○				○	○	○	
M-RVS			○					○
S-PLY					○	○	○	○
S-PUS	○	○				○	○	○
O-REC					(○)	(○)	○	○
O-P.B	○	○	○	○	○*	○*	○	○
O-LMT					○	○	○	○
O-RMT					(○)	(○)		

○ : "LOW" level mode.

\* : OFF at REC

- |                            |                       |
|----------------------------|-----------------------|
| S808 TUNER REC             | S851 POWER (OFF)      |
| S809 CD/AUX REC            | S901 PLAY             |
| S810 TIMER/PLAY REPEAT     | S902 PAUSE            |
| S811 DOLBY-NR (OFF)        | S903 CASSETTE         |
| S812 DOLBY-NR B/C (C)      | S904 METAL            |
| S813 INTRO PLAY MS (OFF)   | S905 CrO2             |
| S814 INTRO PLAY/MS (INTRO) | S906 REC ENABL        |
|                            | S951 VOLTAGE SELECTOR |
|                            | (H.HU.E MODEL)        |

WIRING-2

1 2 3 4 5 6 7

A  
B  
C  
D  
E  
F  
G  
H  
I  
J

**9. Bias OSC Frequency Adjustment**  
**Setting:**  
 • Adjustment location: L201  
**Method:**  
 Adjust L201 so that the frequency become 85 kHz.

**7. LH REC/PB Frequency Characteristic Adjustment**  
**Settings:**  
 • Recording mode  
 • Test tape: TTA-119J  
 • Dolby-NR switch: OFF  
 • LH BIAS FINE Volume: "Center" position  
 • TAPE SELECTOR switch: LH  
 • Input signal: 1 kHz/ 10 kHz, -34 dB  
 • Adjustment locations: SFR201 (L-ch) SFR202 (R-ch)  
**Method:**  
 Supply a 1 kHz signal and adjust the recording level so that the LINE output is made 20 mV. Record and playback the 1 kHz and 10 kHz signals and adjust so that the 1 kHz outputs are set to +0.8 dB.  
**Rating:**  
 0.5 : 0 dB  
 +0.5 : 0 dB  
**Settings differ as below-METAL, CrO:**  
 • METAL Tape  
**Settings:**  
 • Test tape: TTA-119MX  
 • TAPE SELECTOR switch: METAL  
**Rating:**  
 0 ± 1 dB  
 • CrO: tape  
**Settings:**  
 • Test tape: TTA-119G  
 • TAPE SELECTOR switch: CrO:  
**Rating:**  
 0 : 1 dB

**3. Play back Frequency Characteristic Adjustment**  
**Settings:**  
 • Test tape: TTA-117E  
 • TAPE SELECTOR switch: CrO:  
 • Dolby-NR switch: OFF  
 • Adjustment locations: SFR301 (L-ch) SFR302 (R-ch)  
**Method:**  
 Play back the test tape and adjust SFR301, 302 so that the 1 kHz and 10 kHz output deviation are +1.0 ± 0.2 dB.

**4. Play back Level Adjustment**  
**Settings:**  
 • Test tape: TTA-161  
 • TAPE SELECTOR switch: LH  
 • Dolby-NR switch: OFF  
 • Adjustment locations: SFR303 (L-ch) SFR304 (R-ch)  
**Method:**  
 Play back the test tape and adjust SFR 303, 304 so that the LINE output become 300 mV ± 0.2 dB.

**8. REC/PB Sensitivity Adjustment**  
 • LH tape  
**Settings:**  
 • Recording mode  
 • Test tape: TTA-119J  
 • Input signal: 1 kHz, -34 dB  
 • Output level: 21 mV  
 • TAPE SELECTOR switch: LH  
 • Adjustment locations: SFR401 (L-ch) SFR402 (R-ch)  
**Method:**  
 Supply a 1 kHz input signal and adjust SFR401, 402 so that the LINE output become 21 mV. Record and playback the signal and adjust so that the output become 21 mV ± 0.2dB.  
**Settings differ as below METAL, CrO:**  
 • METAL Tape  
**Settings:**  
 • Test tape: TTA-119MX  
 • TAPE SELECTOR switch: METAL  
 • CrO, Tape  
**Settings:**  
 • Test tape: TTA-119G  
 • TAPE SELECTOR switch: CrO:

**5. Volume Preset Level Adjustment**  
**Settings:**  
 • REC Volume: "Center" position  
 • Input signal: -14.0 dB, 1 kHz  
 • Adjustment locations: SFR501 (L-ch) SFR502 (R-ch)  
**Method:**  
 Adjust SFR501, 502 so that the LINE output become 210 mV.

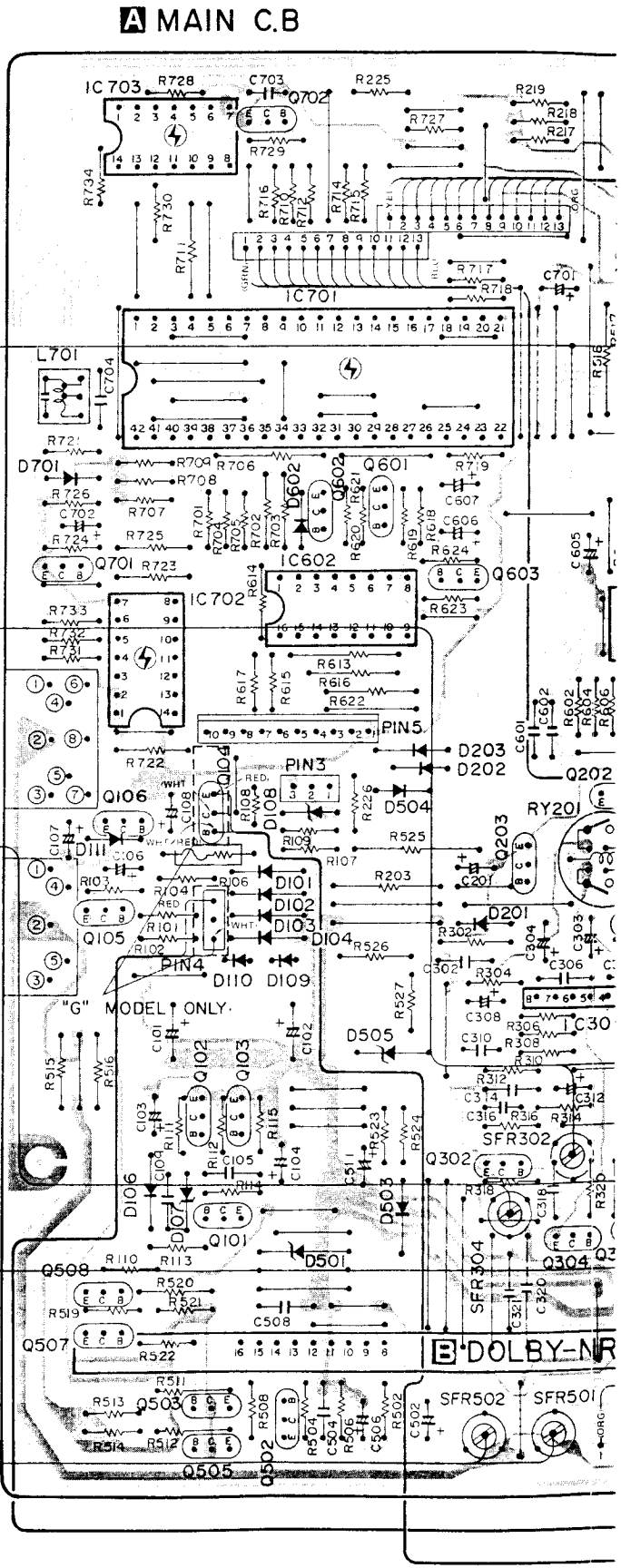

A MAIN C.B

B DOLBY-NR

J701 CONTROL

J501 REC/PLAY

"G" MODEL ONLY

SFR502 SFR501

Earth pattern Others pattern  
 The voltage is the reference value measured with a tester (20 K ohms/V DC) when there are no signals.  
 An asterisk (\*) indicates that the value was measured with a vacuum-tube voltmeter during recording.

6 7 8 9 10 11 12 13

MAIN C.B

AUTO STOP C.B

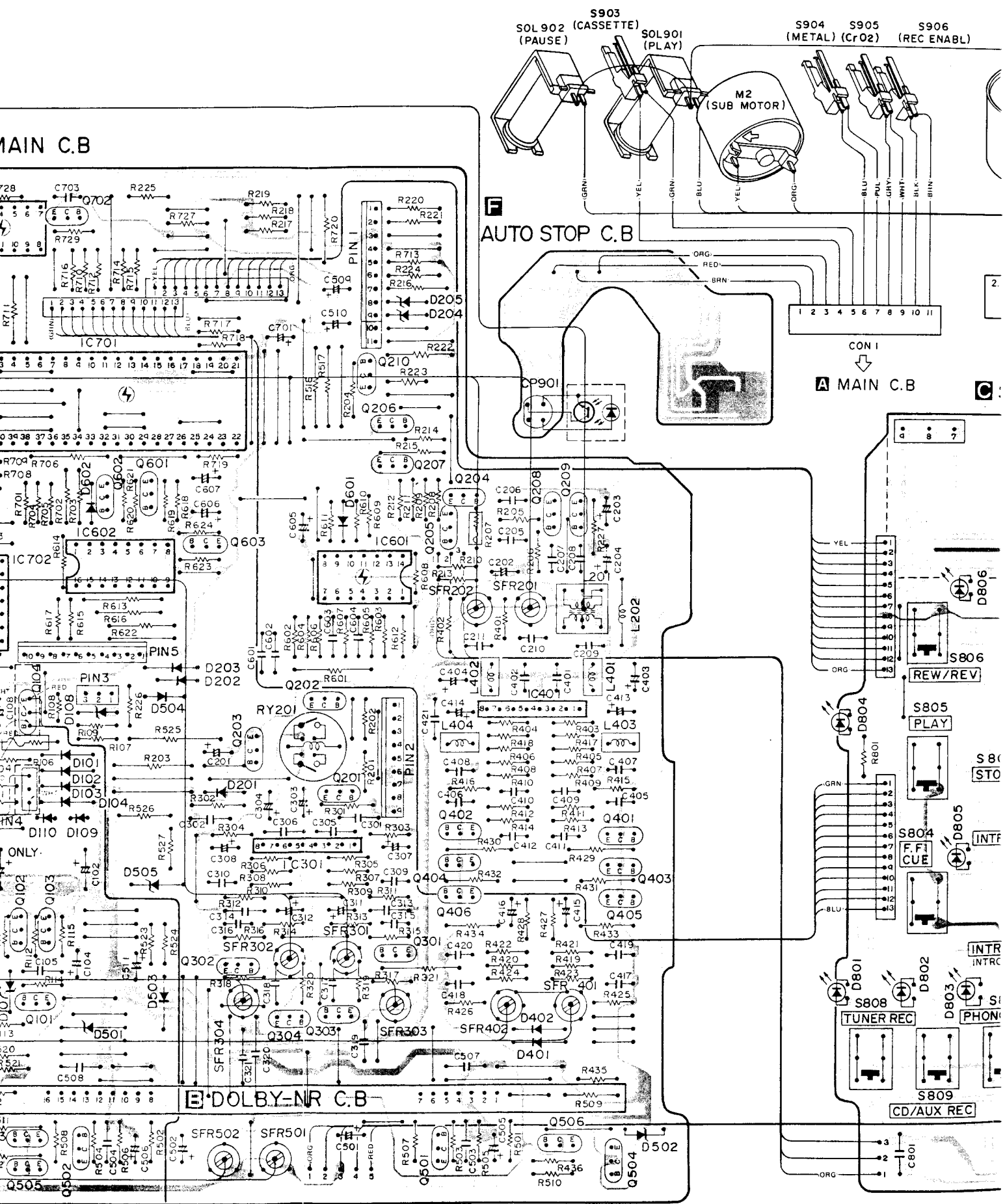

12	13	14	15	16	17	18	19
----	----	----	----	----	----	----	----

S904 S905 S906  
METAL) (CrO2) (REC ENABL)

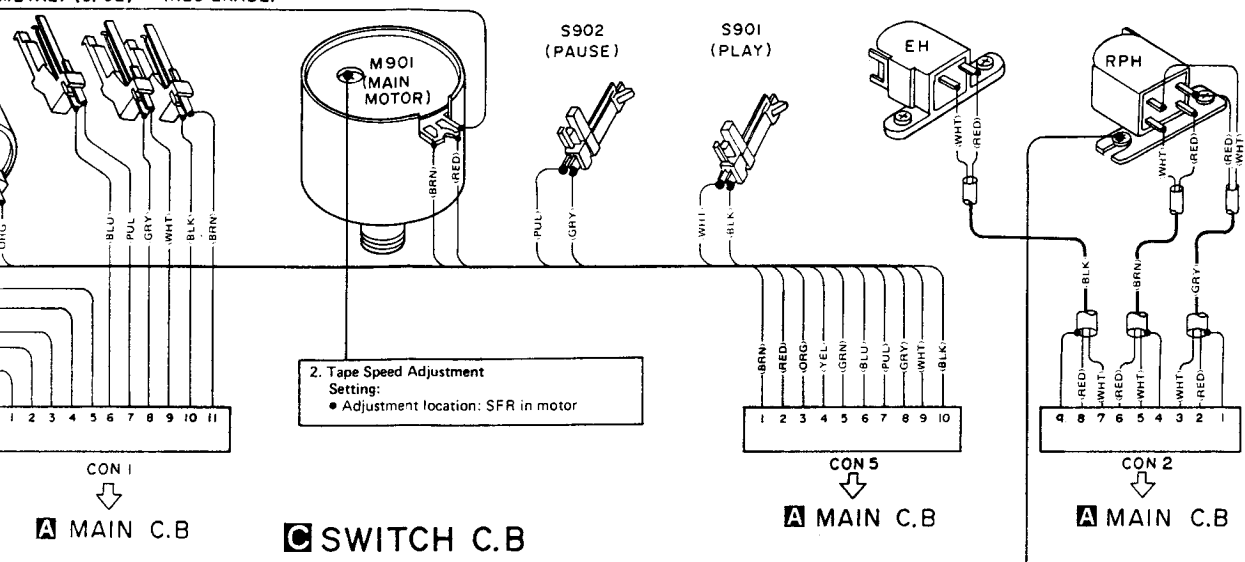

1. Azimuth Adjustment  
Settings:  
• Test point: TTA-117E  
• Adjustment location: Azimuth adjusting screw

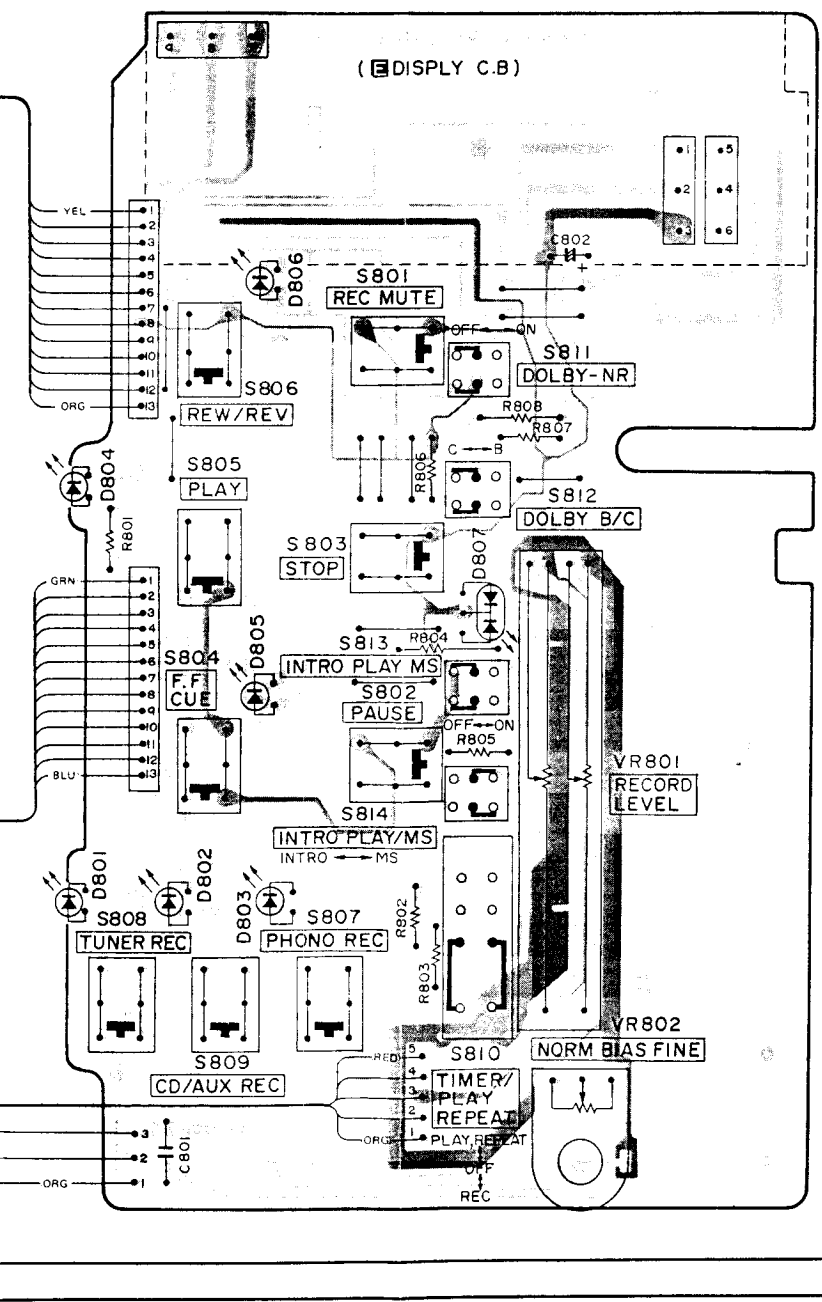

**C-MOS IC handling precaution**

The C-MOS IC's construction makes this part susceptible to damage by static electricity and so take sufficient care in regard to following articles.

1. Need to be put on conductive sheet, to be put in a metallic box and to be wrapped by aluminium foil for transportation and deposit.
2. To use solder iron less than 40W (less than 260°C) of power consumption for soldering. But do not overheat more than 10 second.
3. Do not perform a conductivity test with a tester, etc. Refer to the circuit voltages of each part.
4. The ICs on the electrical parts which are indicated by an C-MOS IC symbol mark (⚡).

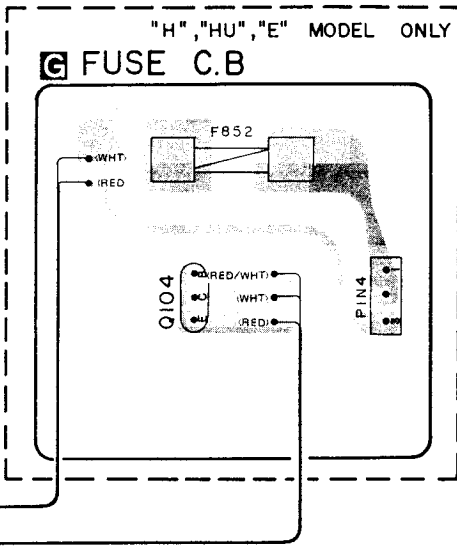



DC) when there are no signals.  
 be voltmeter during recording.

SCHEMATIC DIAGRAM-2

7 8

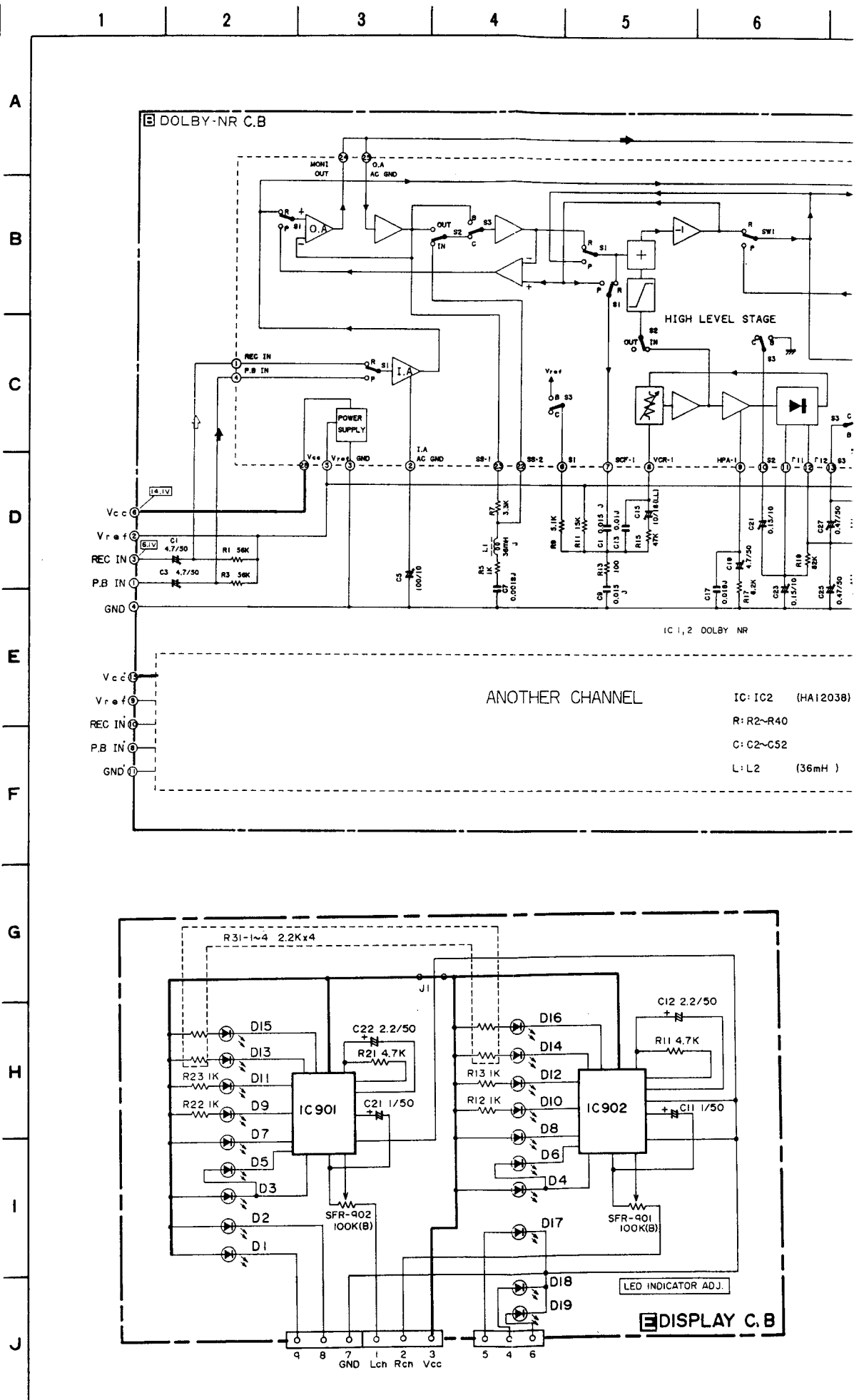

1 (L-ch)  
 2 (R-ch)  
 n adjust REDORD  
 it is 300 mV. Adjust  
 off when the input is

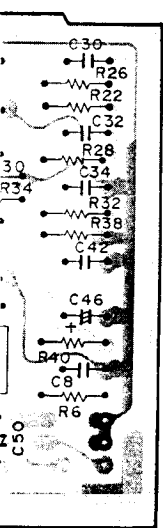

NOTES:  
 1) B (+) power supply

5 6 7 8 9 10 11

