

SERVICE

MANUAL

**1/2" CARTRIDGE TAPE RECORDER/
TUNER COMBINATIONS**

MODEL CR-81T

ALSO APPLICABLE TO MODEL CR-81, CR-81D



TABLE OF CONTENTS

I.	SPECIFICATIONS	2
II.	MEASURING METHOD	4
III.	DISMANTLING OF TAPE TRANSPORT UNIT & AMPLIFIERS	6
IV.	HEAD ADJUSTMENTS	8
V.	MECHANISM ADJUSTMENTS	9
VI.	AMPLIFIER ADJUSTMENTS	10
VII.	TUNER SECTION ADJUSTMENTS.....	12
VIII.	DISPOSITION OF EACH ADJUSTMENT PART	17
IX.	COMPOSITE VIEWS OF COMPONENTS	18
X.	SCHEMATIC DIAGRAM	

When placing order for parts,
please use separate PARTS LIST.

I. SPECIFICATIONS

An asterisk next to a figure indicates the minimum guaranteed performance.

RECORDER SECTION

RECORDING SYSTEM		In-line 8-track stereo recording system
PLAYBACK SYSTEM		In-line 8-track stereo playback system
TAPE SPEED	Playback	3-3/4 ips $\pm 1.5\%$ (* $\pm 2\%$)
	F.FWD	15 ips $\pm 10\%$
WOW AND FLUTTER		Less than 0.25% (* 0.35%)
FREQUENCY RESPONSE		50 to 16,000 Hz ± 3 dB
SIGNAL TO NOISE RATIO		Better than 47 dB (* 41 dB)
DISTORTION FACTOR		Less than 4%
CROSS-TALK		Less than 40 dB
ERASE RATIO		Less than 65 dB (* 60 dB)
OUTPUTS	Line output	1.228V ("O" VU) ± 1.5 dB using 500 Hz "O" VU recorded tape
	Din output	0.4V
	Power output	10W (* 7W)
INPUTS	Line input	50 mV Impedance 150 k Ω
	Din input	7 mV (* 10 mV)
	Mic input	0.5 mV Impedance 5 k Ω
	Phono input	3.5 mV
RECORDING/PLAYBACK HEAD		In-line 8-track stereo
	Gap	1/1000 mm
	Impedance	750 Ω $\pm 15\%$ at 1 kHz
ERASE HEAD		In-line 8-track stereo
	Gap	0.1 mm
	Impedance	210 Ω $\pm 10\%$ at 90 kHz
OSCILLATION FREQUENCY		65 kHz $\pm 5\%$
TRANSISTORS		4 ... 2SC693FU 2 ... 2SC971 (2)(3) Red 1 ... 2SC1061 (A)(B)(C) 4 ... 2SC711 (D) 1 ... 2SC968 (4)
IC		2 ... AA-072D
		2 ... STK-011A (CR-81, CR-81T)
DIODES		4 ... 1N34A 1 ... 10D4 1 ... 10DC1 Red (CR-81, CR-81T)
		4 ... 10D1 1 ... 10DC1 Black
MOTOR		Condenser starting induction two-speed (2-8 pole) motor Condenser Capacity 4 μ F (50 Hz), 2.5 μ F (60 Hz) Revolutions 2900 to 725 rpm (50 Hz) 3480 to 870 rpm (60 Hz)
INSULATION RESISTANCE		More than 50 M Ω
INSULATION DURABILITY		1,000V AC for more than one minute duration
POWER REQUIREMENTS		100 to 240V AC, 50/60 Hz
POWER CONSUMPTION		60W
DIMENSIONS	CR-81T	490 (W) \times 140 (H) \times 270 (D) mm (19.6" \times 5.6" \times 10.8")
	CR-81, CR-81D	347 (W) \times 137 (H) \times 262 (D) mm (13.6" \times 5.4" \times 10.3")
WEIGHT	CR-81T	11.4 kg (25.08 lbs.)
	CR-81	9 kg (19.8 lbs.)
	CR-81D	8 kg (17.6 lbs.)

FM TUNER SECTION

FREQUENCY RANGE		76 to 90 MHz \pm 300 kHz 88 to 108 MHz \pm 300 kHz
IF FREQUENCY		10.7 MHz
SENSITIVITY		Less than 14 dB
HARMONIC DISTORTION	Mono Stereo	Less than 1.0% Less than 1.2%
SIGNAL TO NOISE RATIO		Better than 60 dB (* 50 dB)
SELECTIVITY		Better than 40 dB
IMAGE INTERFERENCE RATIO		Better than 60 dB
IF INTERFERENCE RATIO		Better than 80 dB
CAPTURE RATIO		Better than 5 dB
MUTING SENSITIVITY		14 dB
SEPARATION		Better than 40 dB (* 35 dB)
ANTENNA INPUT IMPEDANCE		300 Ω Balanced 75 Ω Unbalanced

AM TUNER SECTION

FREQUENCY RANGE		525 to 1630 \pm 15 kHz		
IF FREQUENCY		455 kHz		
SENSITIVITY		Less than 52 dB (* 55 dB)		
HARMONIC DISTORTION		Less than 2%		
SIGNAL TO NOISE RATIO		Better than 45 dB (* 40 dB)		
SELECTIVITY		30 dB		
IMAGE INTERFERENCE RATIO		Better than 40 dB		
IF INTERFERENCE RATIO		Better than 40 dB		
TRANSISTORS		2 ... 2SC838 (E)(F)	1 ... 2SC461	1 ... 2SC1096 (K)(L)
		2 ... 2SC945 (Q)(R)	1 ... 2SC535	
FET		1 ... 2SK19		
IC		1 ... LA-1201 (B)	1 ... LA-3300	
		1 ... LA-1221	1 ... MC-4080 (3)	
DIODES		6 ... 1N60	1 ... BZ-130	
		1 ... 1S338		

II. MEASURING METHOD

1. TAPE SPEED DEVIATION

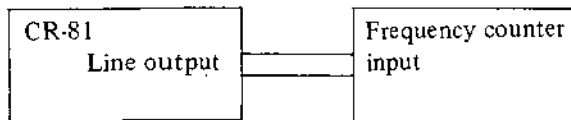

Fig. 1

As shown in Fig. 1, connect a Frequency Counter to the Line Output of Model CR-81 and take a frequency counter reading. The value of this reading will represent tape speed deviation.

2. WOW AND FLUTTER

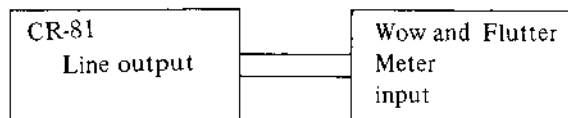

Fig. 2

Method A

As shown in Fig. 2, connect the Line Output of Model CR-81 to the Input of a Wow and Flutter Meter. Use a 3,000 Hz pre-recorded test tape and take a wow and flutter meter reading. The maximum value of this reading will represent the wow and flutter.

Method B

Supply a 3,000 Hz sine wave signal from an Audio Frequency Oscillator and make a recording on a blank tape and then play the tape. Measure wow and flutter with a Wow and Flutter Meter. (The wow and flutter value of Method B will be close to twice that of Method A.)

3. FREQUENCY RESPONSE

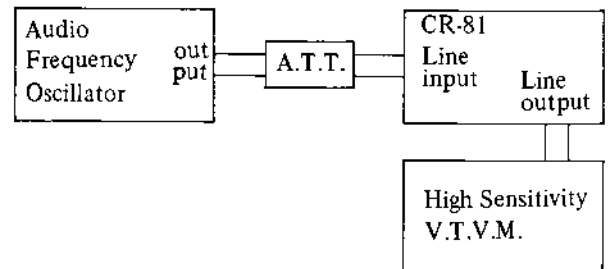

Fig. 3

For measuring frequency response, connect instruments as shown in Fig. 3 and proceed as follows.

- 1) Supply a 1,000 Hz sine wave to the Line Input of Model CR-81 from an Audio Frequency Oscillator through an Attenuator. Set recorder to recording mode and turn recording level volume control to maximum. Adjust attenuator to obtain a +4 dB V.T.V.M. reading.
- 2) Under conditions described in 1) above, re-adjust attenuator so that the Line Output is -16 dB. Record 50 to 16,000 Hz spot frequencies, and playback from the beginning. Take V.T.V.M. spot frequency readings and plot values on a graph.

Note: When measuring frequency response, new tape should be used.

4. SIGNAL TO NOISE RATIO

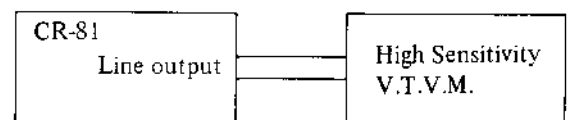

Fig. 4

As shown in Fig. 4, connect a high sensitivity V.T.V.M. to the Line output of Model CR-81. Playback a 500 Hz "0" VU pre-recorded test tape and measure the output. Then remove the tape and measure the noise level under the same condition. Convert each of the measured values into decibels.

5. TOTAL HARMONIC DISTORTION FACTOR

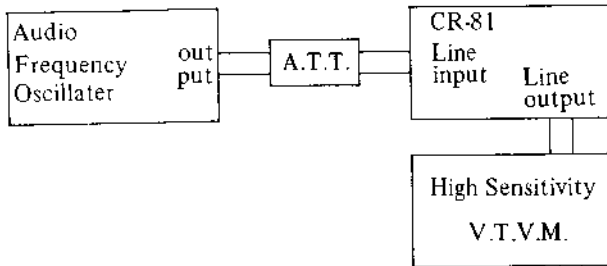

Fig. 5

Connect the measuring instruments as shown in Fig. 5 and record a 1,000 Hz sine wave signal at "0" VU. Playback the resultant signal and measure the overall distortion factor.

Measure the noise level of the tape recorder without the tape. Connect the audio frequency oscillator directly to the distortion meter for measurement of the distortion factor of the oscillator. The required distortion factor can be obtained from the results of the above measurement by the following formula:

$$d_0 = d - d_1 - d_2$$

where, d_0 = Required distortion factor
 d = Overall distortion factor
 d_1 = Noise level
 d_2 = Distortion factor of the oscillator

Note: When measuring the distortion factor, new tape should be used.

6. CROSS TALK (Cross talk between the channels)

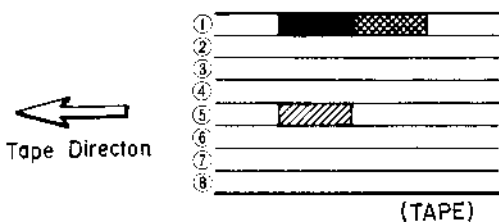

Fig. 6

As shown in Fig. 6, first record a 1,000 Hz sine wave signal on Track No. 1 at +3 VU level. Next, record under a non-input condition. Then, playback the tape on Tracks No. 1 and 5 through the B.P.F. (band pass filter sensitivity ... 1:1) and obtain a ratio between the two from the following formula:

$$C = 20 \log \frac{E_0}{E_2 - E_1} \text{ (dB)}$$

where, C = Desired cross talk ratio (dB)
 E_0 = 1,000 Hz signal output level
 E_2 = 1,000 Hz cross talk level
 E_1 = Non-input signal recorded level

7. ERASE RATIO

As shown in Fig. 4, connect a high sensitivity V.T.V.M. to the Line Output of Model CR-81. Playback a virgin tape and take a V.T.V.M. reading of the output level. Next, record a 1,000 Hz sine wave signal at +3 dB then playback this recorded signal and take a V.T.V.M. reading of the output level. Next, using this pre-recorded tape, record under a non-input condition and take a reading of the noise level output of the erased signal and obtain a ratio between the two from the following formula:

$$E_r = 20 \log \frac{E_0}{E_2 - E_1}$$

where, E_r = Desired erase ratio (dB)
 E_0 = 1,000 Hz signal output level
 E_2 = Non-Input signal recorded level
 E_1 = Virgin tape noise output level

8. POWER OUTPUT

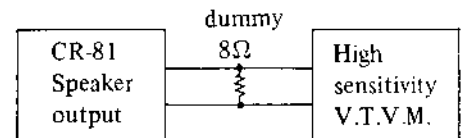

Fig. 7

As shown in Fig. 7, connect an 8Ω dummy load resistor to the speaker output of Model CR-81 and connect this terminal to a high sensitivity V.T.V.M.

Playback a 500 Hz "0" VU pre-recorded test tape and take a V.T.V.M. reading of the output level. The resultant output can be obtained from the results of the above measurement by using the following formula:

$$P = \frac{E^2}{R} \text{ (W)}$$

where, P = Desired power output (watts)
 E = Measured voltage (R.M.S.)
 $R = 8\Omega$

III. DISMANTLING OF TAPE TRANSPORT UNIT & AMPLIFIERS

In case of trouble, etc. necessitating disassembly, please disassemble in the order shown in photographs. Reassemble in reverse order.

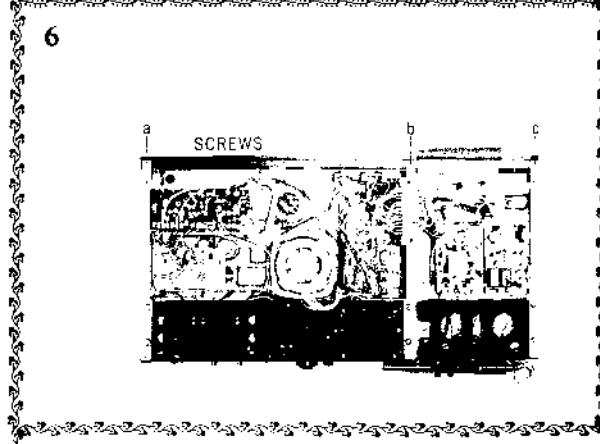
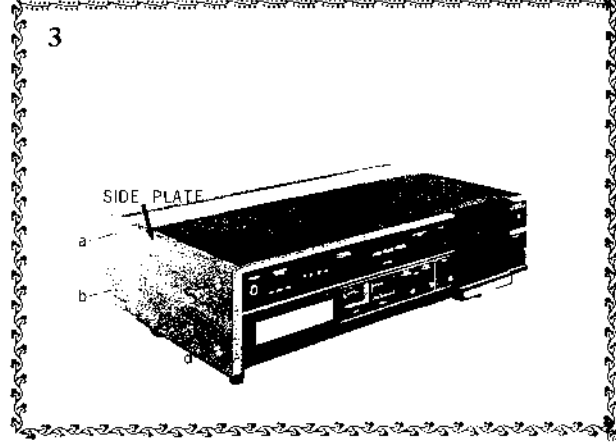
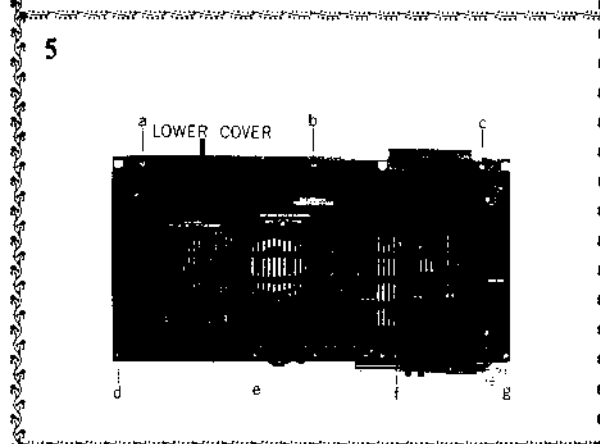
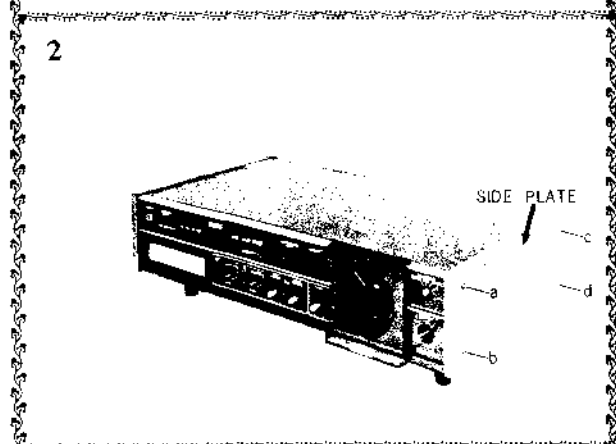
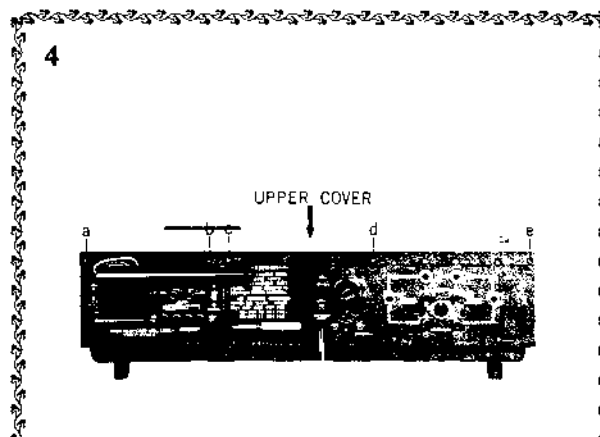
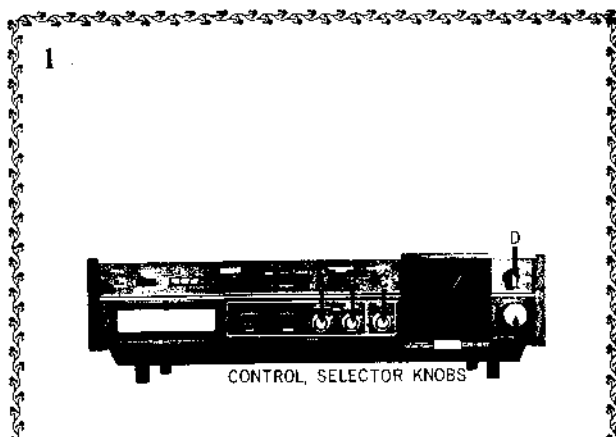

7

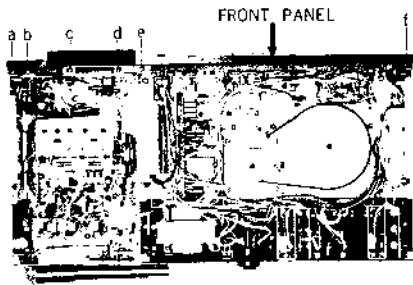

11

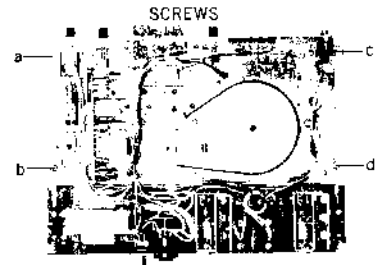

8

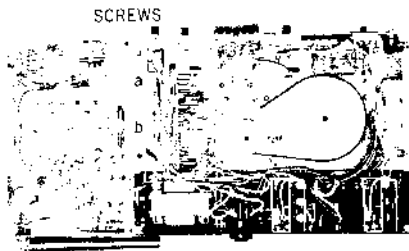

12

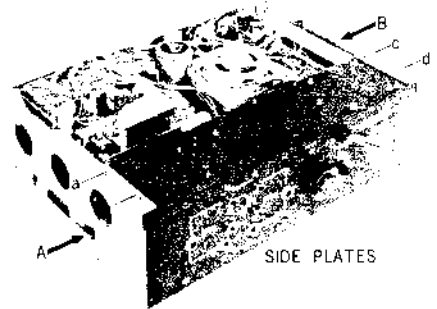

9

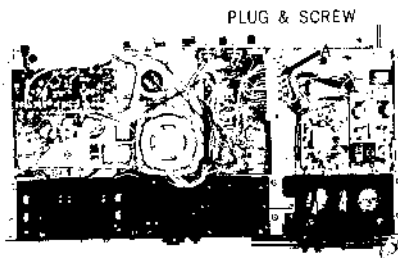

13

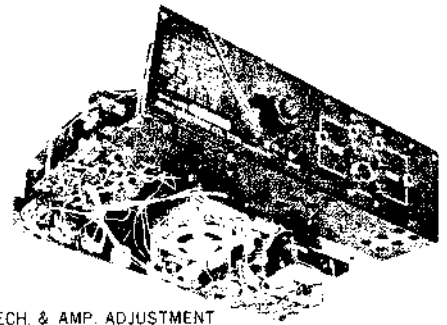

10

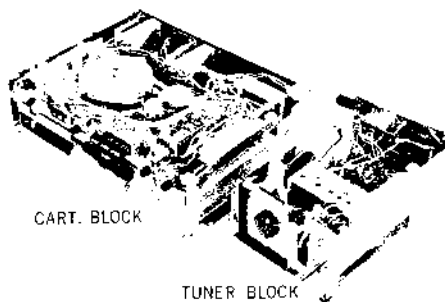

14

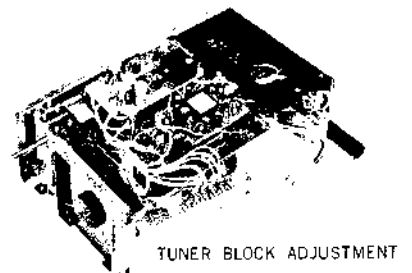

IV. HEAD ADJUSTMENTS

1. HEAD ANGLE ADJUSTMENTS

- 1) Connect a High Sensitivity V.T.V.M. (Model 161A) to the Line Output.
- 2) Playback Program 3 of an 8,000 Hz pre-recorded Tape and adjust Screw "c" shown in Fig. 8 so that the V.T.V.M. indication is maximum.

2. HEAD HEIGHT AND CROSS TALK ADJUSTMENTS

- 1) Connect a High Sensitivity V.T.V.M. (Model 161A) to the Line Output.
- 2) Playback Program 2 of *Test Tape and adjust Screw "d" shown in Fig. 8 so that the V.T.V.M.* indication is minimum.
- 3) In case of CR-81 connect speaker to speaker jack and with volume control turned to maximum, adjust Screw "d" until the sound emitted from the speaker is minimized.
- 4) The adjustments outlined in items 2) and 3) above will result in ideal head height position and minimize cross-talk.

*Test Tape

This Test Tape is a tape specially designed by AKAI for Head Height and Cross-Talk Adjustment tests.

- Program 1 ... 1,000 Hz
- Program 2 ... Blank
- Program 3 ... 1,000 Hz
- Program 4 ... 3,000 Hz

3. CONFIRMATION OF HEAD HEIGHT

- 1) Record a 1 kHz "0" VU signal on a *Blank Test Tape. Next, run the tape under a non-signal input condition. Then play back the tape.
- 2) At this time check to see whether or not the recorded sound is emitted from the speaker or line output.
- 3) If no signal or no sound is emitted, the height of the recording and erase heads are properly adjusted. If the recorded signal has not been perfectly erased and is emitted from the speaker or line output, the recording and erase head height is not properly adjusted and the following adjustment is necessary:

Turn screws "a" and "b" in the same direction and to the same degree and turn screw "c" in the opposite direction to the same degree. (see Fig. 9) This fine adjustment screw "c" should not be turned more than 10° and should equal the degree to which screws "a" and "b" have been adjusted.

- 4) After the above adjustment has been carried out, it is necessary to re-adjust Head Heights and Cross-Talk. Use a *Test Tape and make the adjustments outlined in items 2-2) and 2-3) again.

*Blank Test Tape

This is also a special tape designed by AKAI. Duration of tape is only 15 seconds.

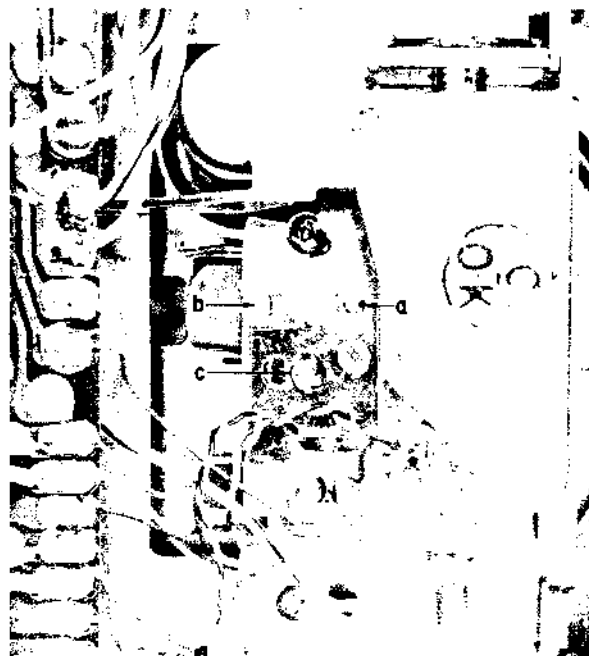

Fig. 8

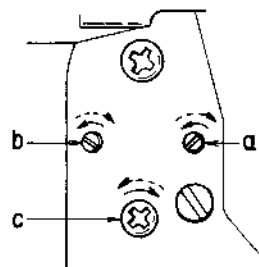

Fig. 9

V. MECHANISM ADJUSTMENTS

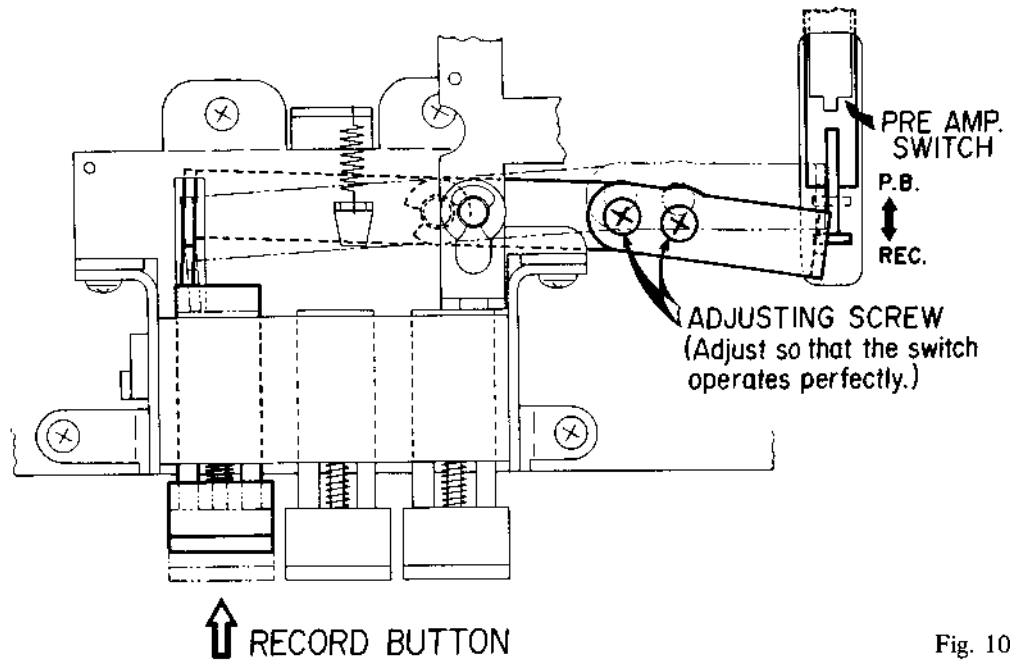

Fig. 10

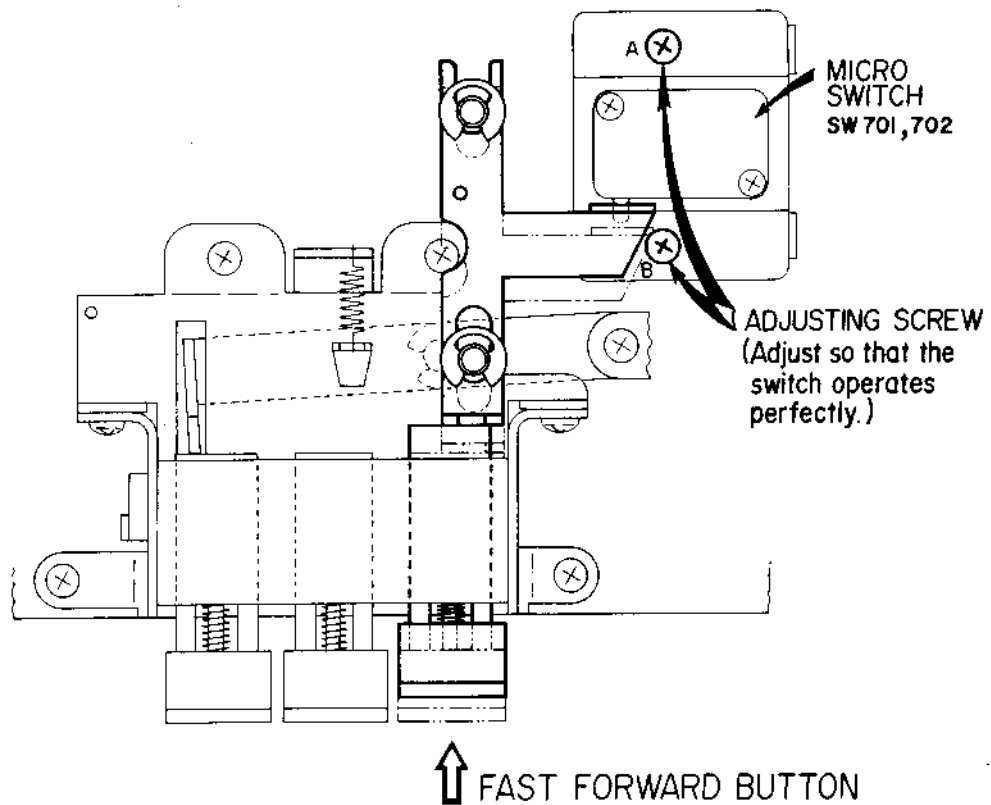

Fig. 11

1. RECORDING PLAYBACK SWITCH ADJUSTMENTS

Position Pre-Amp Print Board so that when the REC Button is depressed, the Recording Lever sets SW101A, SW101B perfectly for effecting recording mode. (SW101A, SW101B is the Rec/Play Slide Switch) (See Fig. 10)

2. POSITION ADJUSTMENT OF SWITCHES SW701 AND SW702

Position Relay Print Board and fix Screws "A" and "B" in position at which Switches 701, 702 operate perfectly when the F.FWD Button is depressed. (See Fig. 11)

VI. AMPLIFIER ADJUSTMENTS

1. RECORDING BIAS FREQUENCY ADJUSTMENTS (See Fig. 12)

- 1) Connect a Frequency Counter to points (A) and (B), and read the Frequency Counter indication.
- 2) If the Frequency Counter reading is 65 kHz $\pm 5\%$, the recording bias frequency is correct.
- 3) If the recording bias frequency is incorrect, it can be adjusted by changing the value of condenser C-404.

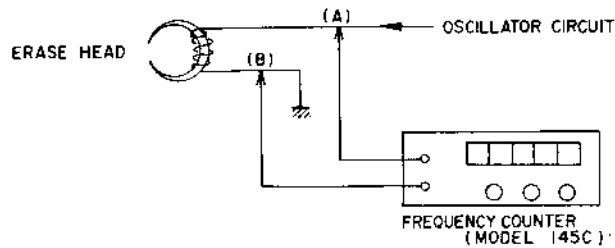

Fig. 12

2. RECORDING BIAS VOLTAGE ADJUSTMENTS (See Fig. 13)

- 1) Connect a V.T.V.M. (Model 107 A Type) to points (a) and (b), and measure the bias voltage.
- 2) Correct recording bias voltage is between 18 to 20V AC. Adjustment can be made with VR-401 and VR-402 respectively. Correct Erase Voltage is about 20V AC.

3. PLAYBACK LEVEL ADJUSTMENTS (See Figs. 14 and 15)

- 1) Connect a High-Sensitivity V.T.V.M. (Model 161A) to the Line Output.
- 2) Turn Volume Control VR-1, VR-2 (50 k Ω A) up to maximum.
- 3) Play back a test tape (500 Hz "0" VU Recorded) and turn the Potentiometer VR-101 (20k B) until the line output level reaches +4 dB (1,228V).

4. RECORDING AND PLAYBACK LEVEL ADJUSTMENTS (See Figs. 14 and 15)

- 1) Load a Blank Test Tape.
- 2) Set recorder to recording mode and turn the main volume up to maximum.
- 3) Supply a 1 kHz sine wave signal from an Audio Frequency Oscillator through the attenuator to the line input and adjust the attenuator so that the V.T.V.M. indicates +4 dB. (VU Meter needle indicates "0" VU.)
- 4) After a few seconds of recording, playback the recorded tape from the starting point and check the V.T.V.M. indication.
- 5) If the line output does not reach +4 dB, repeat recording and playback procedure from item 3) and adjust Potentiometer VR-102 (2k B) until +4 dB is obtained.

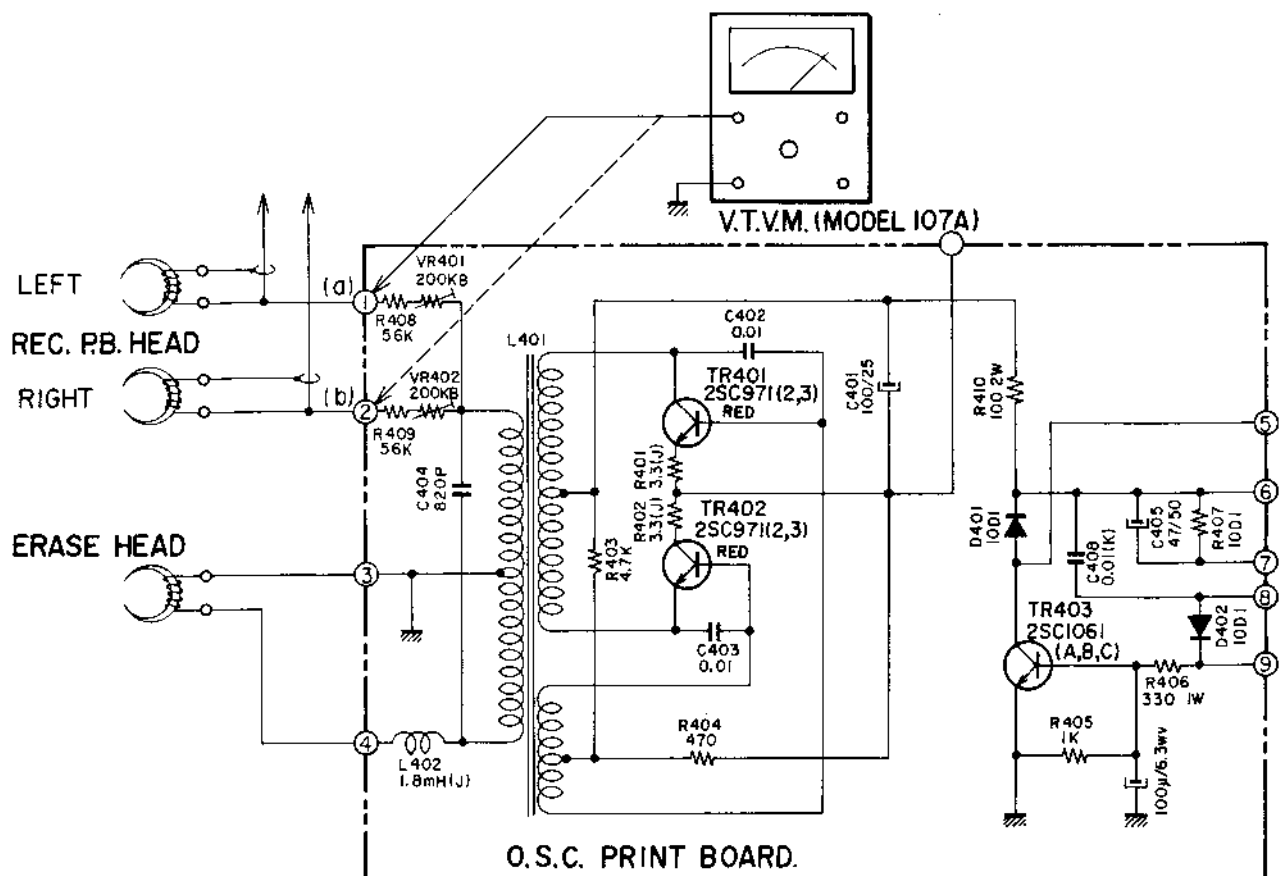

Fig. 13

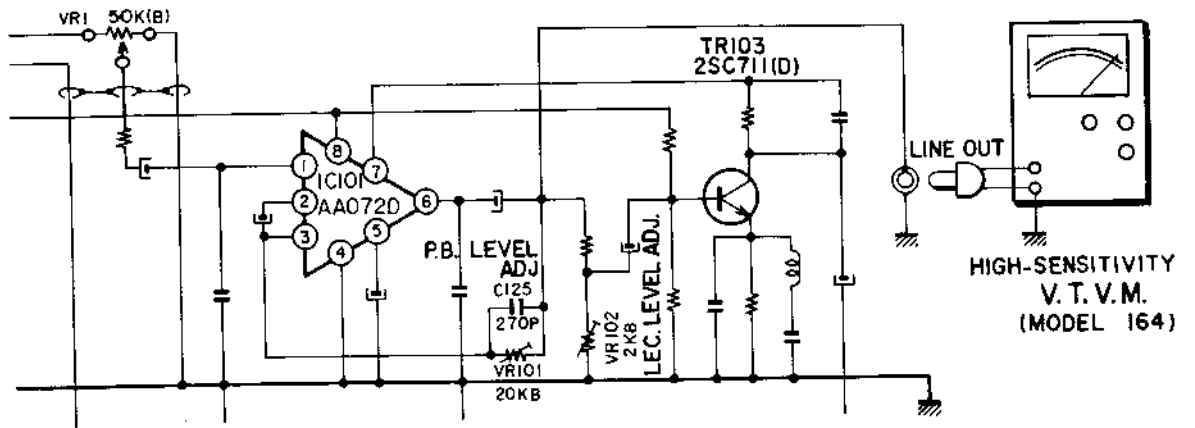

Fig. 14

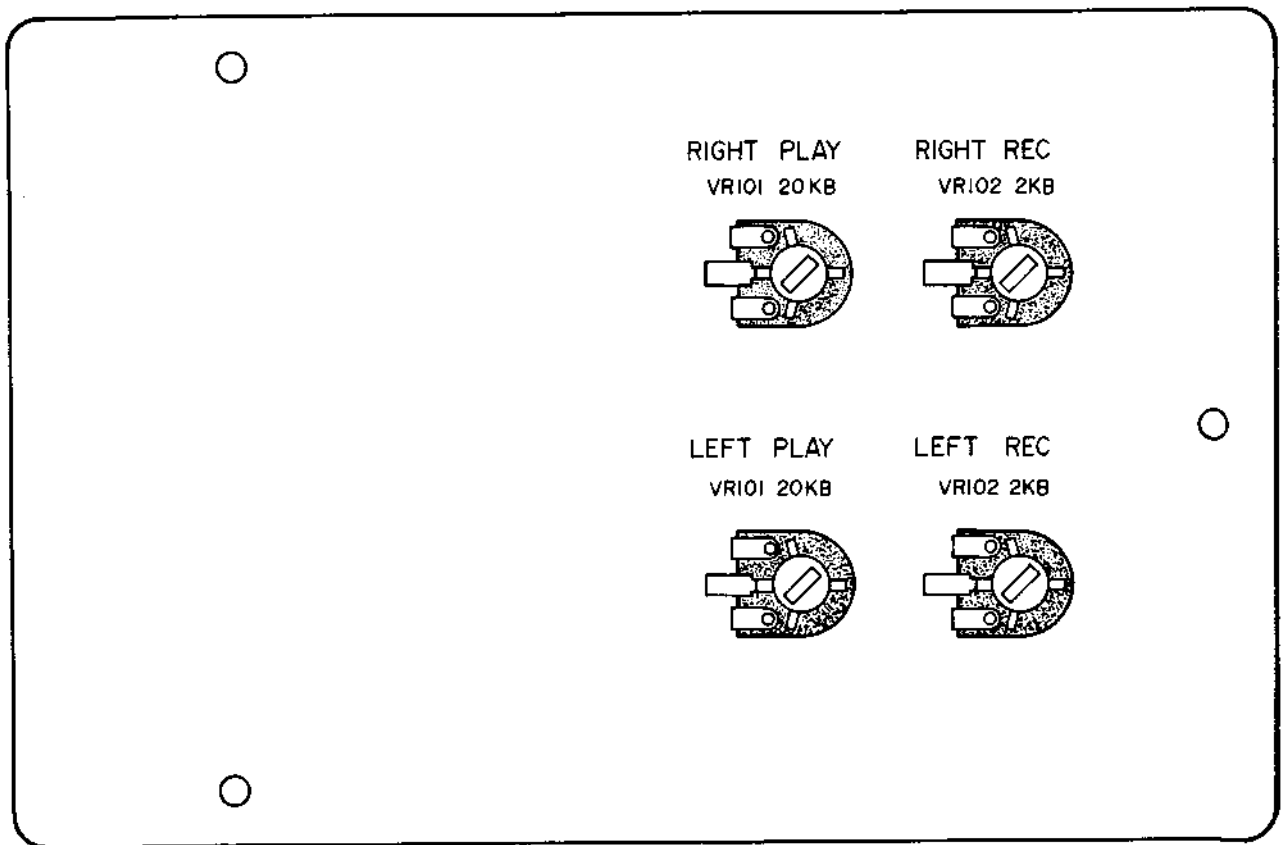

Fig. 15

VII. TUNER SECTION ADJUSTMENTS

1. FM IF CIRCUIT ADJUSTMENTS (See Figs. 16 and 17)

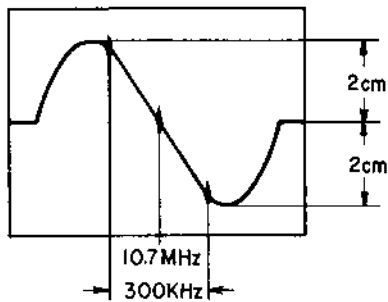
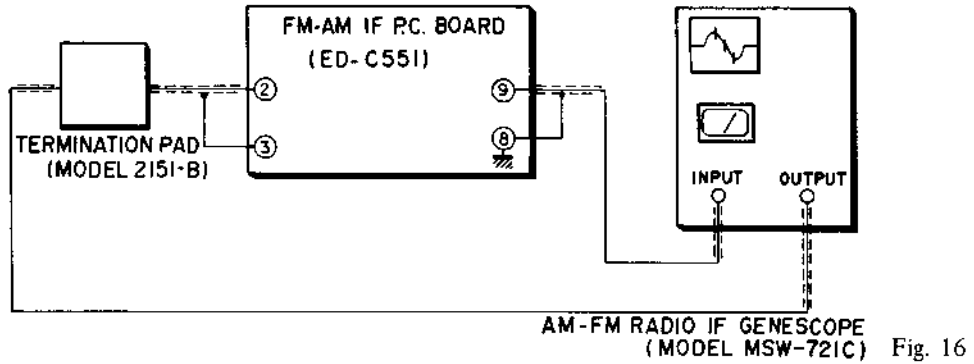

Fig. 17

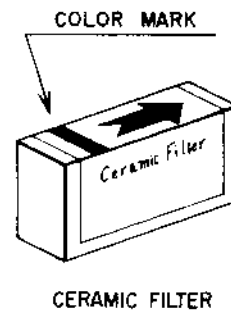

Fig. 18

- 1) Adjust V-Gain Volume to obtain a 2 cm amplitude 0.3V p-p Calibration Voltage on AM-FM Radio IF Genescope Screen, and set Genescope output to within 40 to 45 dB.
- 2) Connect Genescope output to point (2) (FM IF input point) and Genescope input to point (9) (AF output point) of FM IF P.C. Board.
- 3) Set Model CR-81T Mode Switch to "FM" and set reception frequency to about 109 μ Hz.
- 4) Adjust the cores of IFT L_5 , L_6 , L_8 , and L_9 (FM IF amp. P.C. Board) to obtain maximum S Curve output voltage and optimum S Curve linearity.
- 5) In making this adjustment, the S Curve marker point may vary depending upon the rank of the ceramic filter, but it is satisfactory, if through adjustment a margin of within ± 500 Hz can be obtained. (See Fig. 18)

L5, L6,; HEIGHT ADJUSTMENT

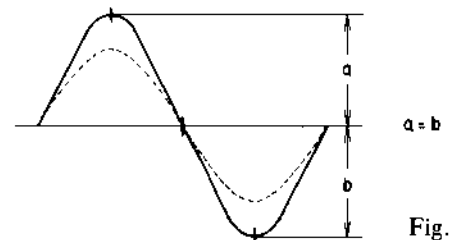

Fig. 19

L8; LINEALITY

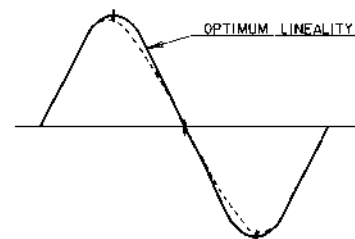

Fig. 20

L9; HEIGHT ADJUSTMENT

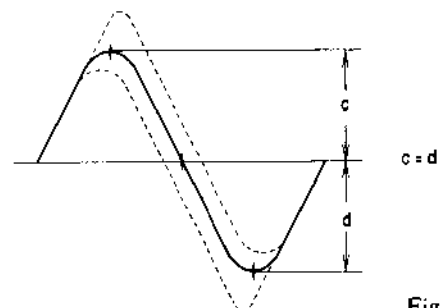

Fig. 21

Rank of Ceramic Filters

Color	Center Frequency	Error Tolerance
Green	10.60 MHz	± 30 kHz
Black	10.65 MHz	± 30 kHz
Red	10.70 MHz	± 30 kHz
White	10.75 MHz	± 30 kHz
Yellow	10.80 MHz	± 30 kHz

2. FRONT END AND FM IF MATCHING ADJUSTMENTS (See Fig. 24)

- 1) Adjust V-Gain Volume to obtain a 2 cm amplitude calibration voltage on AM-FM Radio IF Genescope Screen, and set Genescope output to within 80 to 110 dB.
- 2) Connect Genescope output to the 300Ω impedance antenna terminal and Genescope input to FM IF P.C. Board terminal (9) (AF output).
- 3) Set model CR-81T Mode Switch to "FM" and Tuning Dial Indicator to right end of dial.
- 4) Adjust the upper core of IF Adjustment Core in Front End to obtain maximum value of S Curve wave height. Then adjust lower core so that the noise element is maximum and equal upper and lower scanning line levels are obtained. (See Fig. 22, 23, and 25)
- 5) Adjust IC-1 Bias Adjustment VR-1 (50k B) in FM-IF P.C. Board obtain a further increase in value of S Curve wave height.

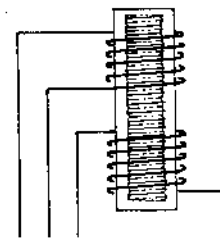

IF COIL (Front end) Fig. 22

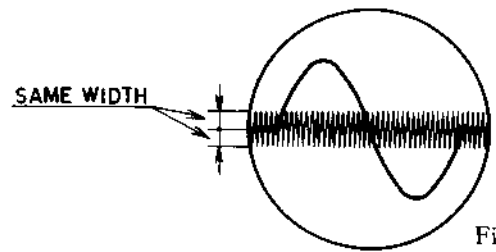
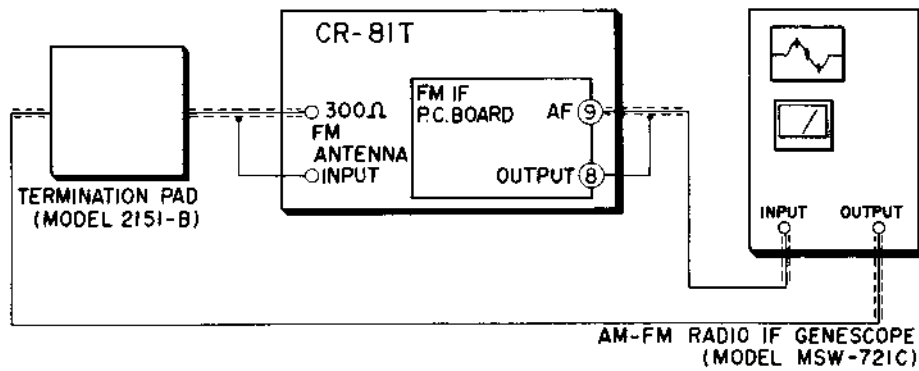

Fig. 23



AM-FM RADIO IF GENESCOPE (MODEL MSW-721C) Fig. 24

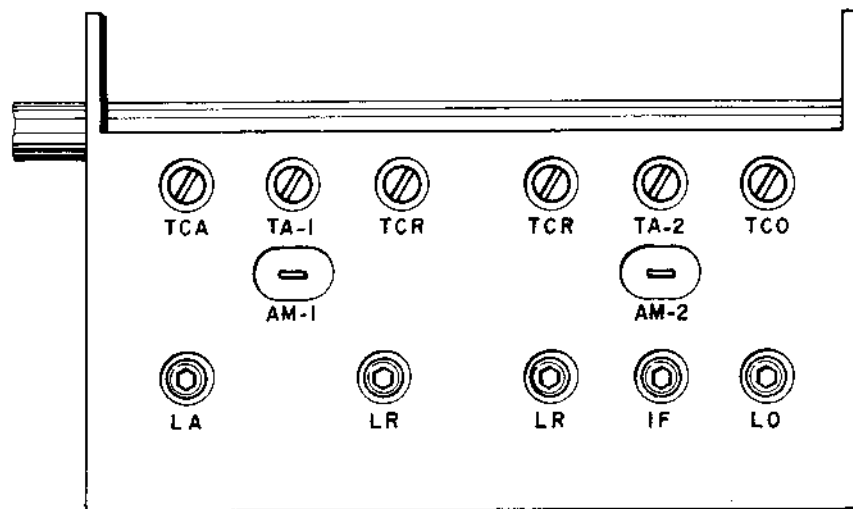

Fig. 25 Top View of Front End

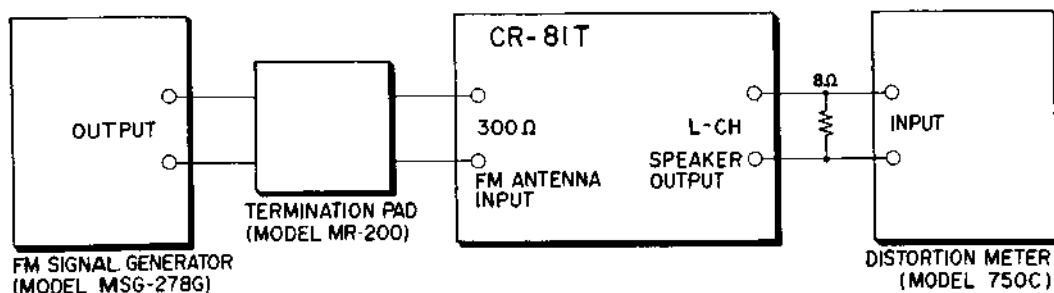

Fig. 26

3. FM RECEIVING FREQUENCY RANGE ADJUSTMENTS (See Figs. 25 and 26)

- 1) Connect FM Signal Generator output to the 300Ω impedance antenna terminal of the CR-81T through a Termination pad. Then connect an 8Ω dummy load resistor to the left channel speaker output, and connect this output to a Distortion meter. Then set the Speaker output level to 10 dB. (Or connect the Distortion meter to the Line output.)
- 2) Set the FM Signal Generator frequency to 88 MHz and the output to 56 dB.
- 3) Adjust the core of FM Local Oscillator Coil "LO" in The Front End so that the Distortion meter level is maximum and the distortion factor is minimum.
- 4) Set Tuning Dial to 108 MHz and FM Signal Generator frequency to 108 MHz.
- 5) Adjust Trimmer Condenser "TCO" in Front End so that Distortion meter level is maximum and the distortion factor is minimum.
- 6) Repeat items 2) through 5) 2 or 3 times until perfect reception is attained within the receiving frequency range of from 88 to 108 MHz.

4. FM TUNER TRACKING ADJUSTMENTS (See Figs. 25 and 26)

Use the same instruments as in item 3 (Fig. 26) and connect them in the same way.

- 1) Set the FM Signal Generator frequency to 98 MHz (internal modulation 400 Hz 75%), and the output to 20 dB.
- 2) Set the tuning dial to receive the 98 MHz signal. Adjust core "IF" of coil in Front End so that the Distortion meter level is maximum and the distortion factor is less than 1%.
- 3) Set the FM Signal Generator frequency to 106 MHz and set the tuning dial to receive the 106 MHz signal. Adjust Trimmer Condensers TCA, TCR₁, and TCR₂ in Front End so that the Distortion meter level is maximum and the distortion factor is less than 1%.
- 4) Set the FM Signal Generator frequency to 90 MHz and set the tuning dial to receive the 90 MHz signal. Adjust cores of Coils LA, LR₁ and LR₂ in Front End so that the Distortion meter level is maximum and the distortion factor is less than 1%.
- 5) Repeat items 1) through 4) 2 or 3 times until perfect tracking is accomplished at 90 MHz, 98 MHz, and 106 MHz and maximum reception sensitivity is attained.

Note: When the distortion factor is 1%, the generator output level is less than 20 dB.

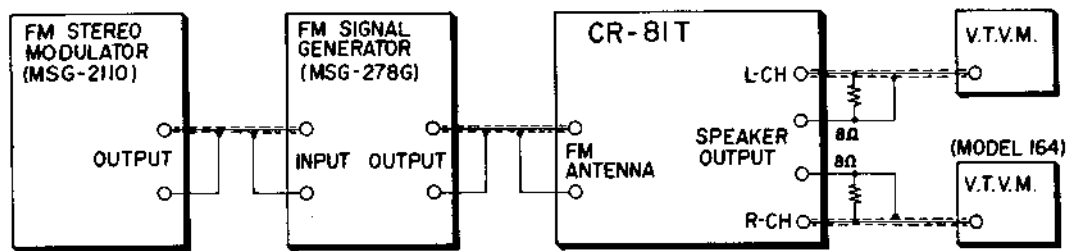

Fig. 27

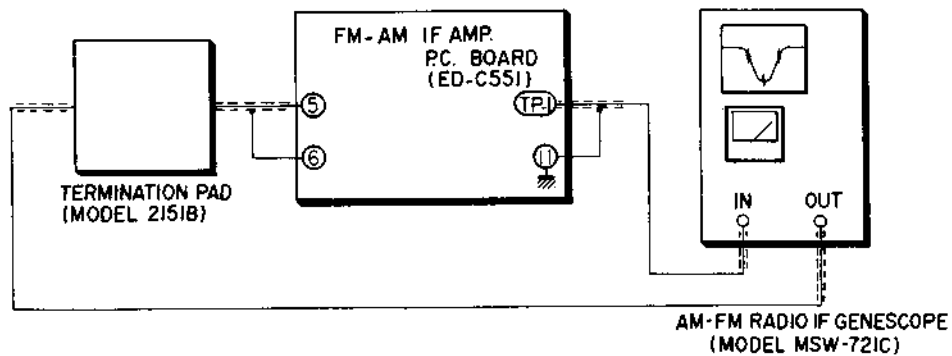

Fig. 28

5. SEPARATION ADJUSTMENTS

(See Fig. 27)

- 1) Adjust Pilot Signal 19 kHz of the FM Stereo Modulator to 10% modulation and main signal (L + R) to 400 Hz, 90% modulation. Connect this composite signal (comparative ratio 9:1) to the EXT. MOD terminal of the FM Signal Generator.
- 2) Set the FM signal frequency to 98 MHz and the output level to 66 dB, and connect this output FM antenna terminals of Model CR-81T. Connect a High Sensitivity V.T.V.M. as well as a dummy load resistor of 8Ω to the respective speaker output terminals, set Tone Control to "FLAT" position and set Speaker output to 10 dB. (Or connect High Sensitivity V.T.V.M. to the line output.) Then set tuning dial to 98 MHz.
- 3) Set the FM Signal Generator to 66 dB (mono), and set MPX, PL ADJ VR-2 to zero. Then adjust the core of Coil L₇ (GRN) of FM IF P.C. Board so that the voltage at TP-2 is from 3 to 3.5V.
- 4) Turn Separation Adjustment Volume VR-1 (1k B) fully clockwise. Set the FM Stereo Modulator to Right Channel and adjust the cores of Coils L₁ and L₂ on MPX P.C. Board so that the indication of the V.T.V.M. connected to the Left Channel is minimum. Then turn VR-1 counter-clockwise to further minimize the V.T.V.M. indication.
- 5) Set the FM Stereo Modulator to Left Channel and adjust the cores of Coils L₁ and L₂ so that the indication of the V.T.V.M. connected to Right Channel is minimum. Then adjust VR-1 for minimum V.T.V.M. indication.
- 6) Separation is not be better than 35 dB, repeat the adjustments outlined above. Avoid turning the coil cores excessively during re-adjustment.

- 7) Adjust VR-2 (50k B) so that the Stereo Indicator Lamp lights when FM Signal Generator output level reaches 21 dB.

6. AM IF CIRCUIT ADJUSTMENTS

(See Figs. 28 and 29)

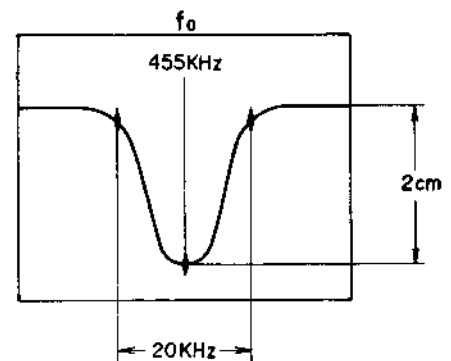

Fig. 29

- 1) Adjust V-Gain Volume to obtain a 2 cm amplitude calibration voltage on AM-FM Radio IF Genescope screen, and set Genescope output to 81 dB.
- 2) Connect Genescope output to Terminal (5) and Genescope input to TP-1 (FM-AM IF Board)
- 3) Set Model CR-81T Mode Switch to "AM" and set reception frequency to about 1630 kHz.
- 4) Adjust cores of IFT L₂, L₃, and L₄ of AM IF Amp. P.C. Board to obtain maximum waveform level (Fig. 29) and a 455 kHz center frequency. (Center frequency differs according to country. Adjust according to country's center frequency.) When center frequency is set to 455 kHz, in case sufficient Q is not attained, deviate from frequency and set to position for best Q.

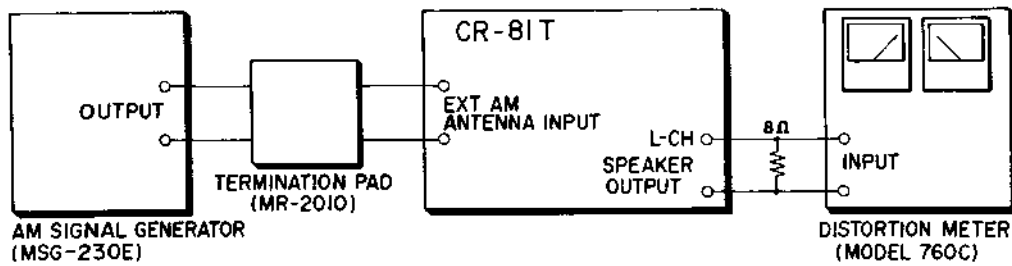

Fig. 30

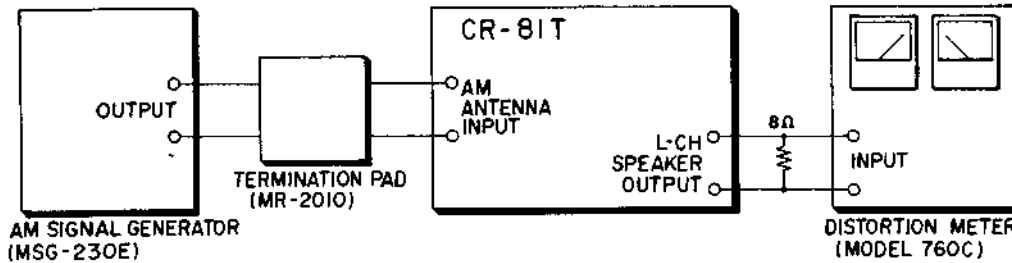

Fig. 31

7. AM RECEIVING FREQUENCY RANGE ADJUSTMENTS (See Fig. 30)

- 1) Connect AM Signal Generator output to the AM Antenna input terminals of the CR-81T through the termination pad. Connect an 8Ω dummy load resistor to the Left Channel output and connect this output to the Distortion meter. At this time, set the speaker output level to 10 dB. (Or connect the distortion meter to the Line output.)
- 2) Set the Tuning Dial Indicator to the left end of the dial and set the AM Signal Generator to 400 Hz (30% internal modulation), frequency to 515 ± 5 kHz, and the output to 61 dB.
- 3) Adjust the core of AM Local Oscillator Coil L_1 of AM IF P.C. Board so that the Distortion meter level is maximum, and the distortion factor is minimum.
- 4) Set the Tuning Dial Indicator to the right end of the dial and set the AM Signal Generator frequency to 1630 ± 5 kHz.
- 5) Adjust Trimmer Condenser TA-2 in Front End Block so that the Distortion meter level is maximum and the distortion factor is minimum.
- 6) Repeat items 2) through 5) 2 or 3 times until perfect reception is attained within the receiving frequency of 525 to 1530 kHz.

8. AM TUNER TRACKING ADJUSTMENTS

- 1) Connect the AM Signal Generator output to the AM antenna input point of Model CR-81T through the termination pad. Connect an 8Ω dummy load resistor and connect this output to the Distortion meter input. At this time, with the speaker output level at 10 dB, set Tone Control to "FLAT" position.
- 2) Set the AM Signal Generator frequency to 1400 kHz (400 Hz, 30% internal modulation), and the output to 61 dB. Then set tuning dial to receive this 1400 kHz signal.
- 3) Adjust Trimmer Condenser TA-1 in Front End so that the Distortion meter level is maximum and the distortion factor is less than 10%.
- 4) Set the AM Signal Generator frequency to 600 kHz and set the tuning dial to receive this 600 kHz signal.
- 5) Adjust core of Bar Antenna so that the Distortion meter level is maximum and the distortion factor is less than 10%.
- 6) Set the AM Signal Generator frequency to 1000 kHz and the output to 80 dB. Then set the tuning dial to receive the 1000 kHz signal.
- 7) Check to confirm that the Distortion meter level is maximum and the distortion factor is less than 2%.
- 8) Repeat items 2) through 6) 2 or 3 times until perfect tracking is obtained at these 3 frequencies.

Note: When the distortion factor is 2%, the generator output level is less than 80 dB.

VIII. DISPOSITION OF EACH ADJUSTMENT PART

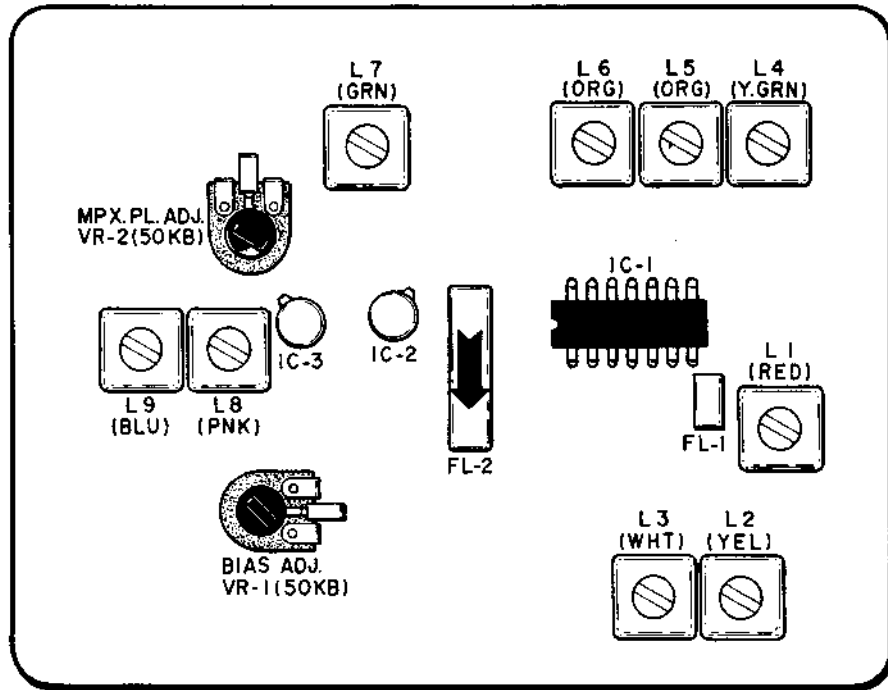

Fig. 32 FM-AM IF BOARD (ED-C551)

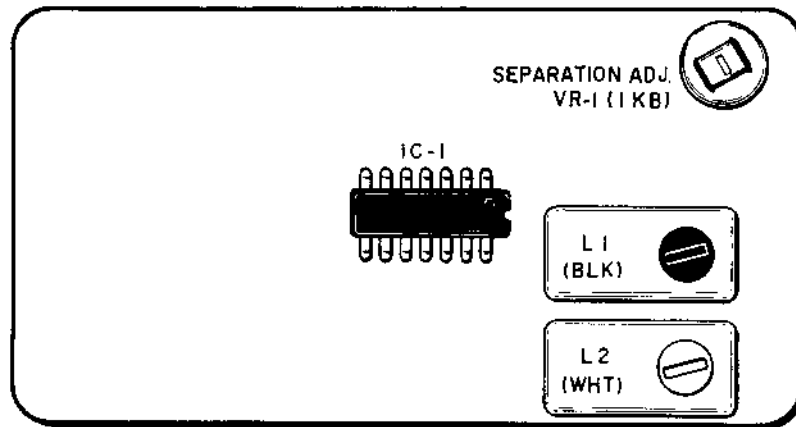
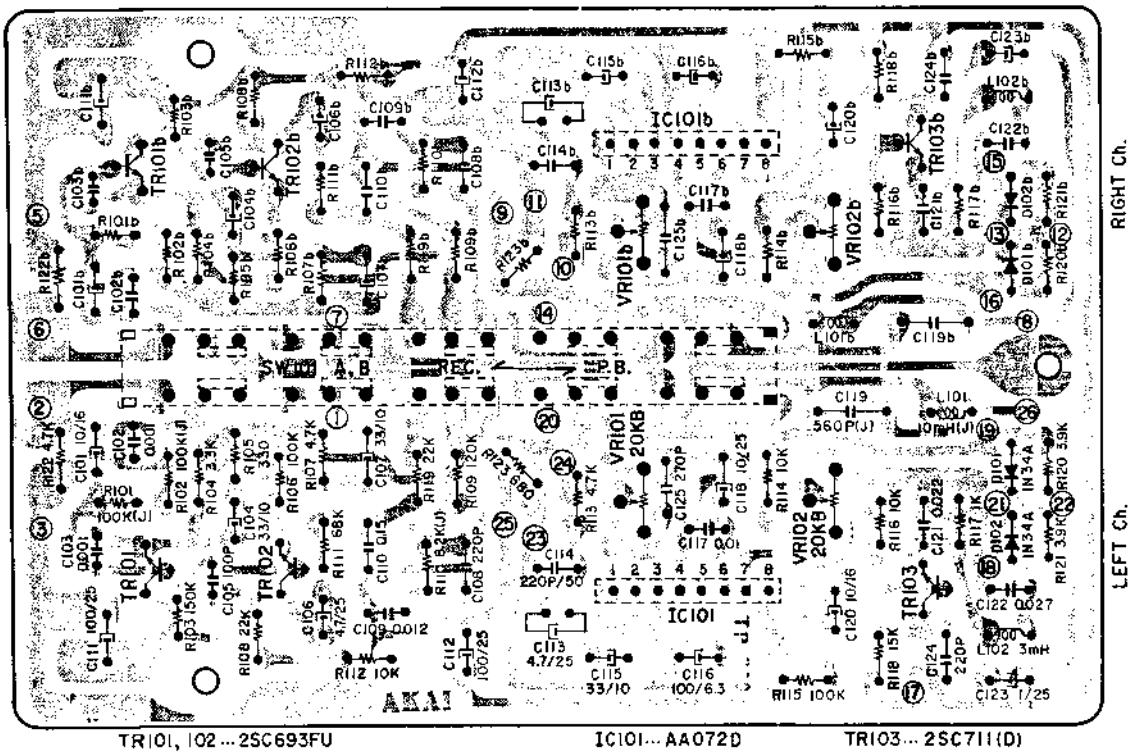

Fig. 33 FM MPX BOARD (ED-C553)

IX. COMPOSITE VIEWS OF COMPONENTS

PRE-AMP. P.C. BOARD (ED-506)



MAIN AMP. P.C. BOARD (ED-515 3ED)

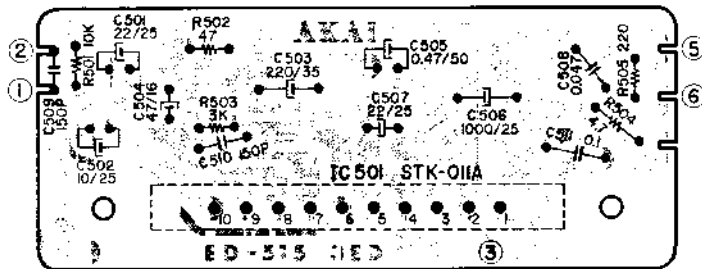

OSC. P.C. BOARD (ED-308 6ED)

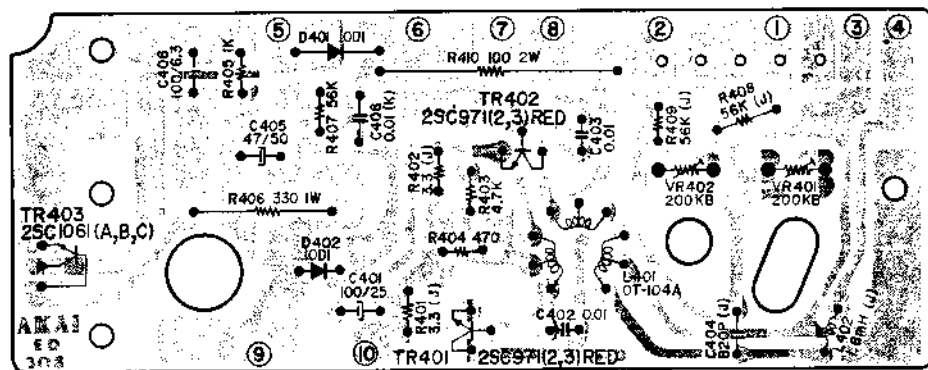

RELAY P.C. BOARD (ED-522 2ED)

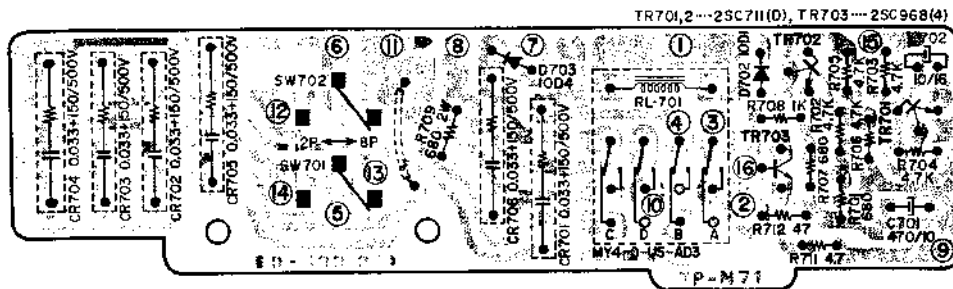

MUTE P.C. BOARD (ED-523)

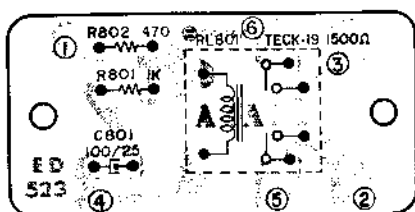

POWER SUPPLY P.C. BOARD (ED-512)

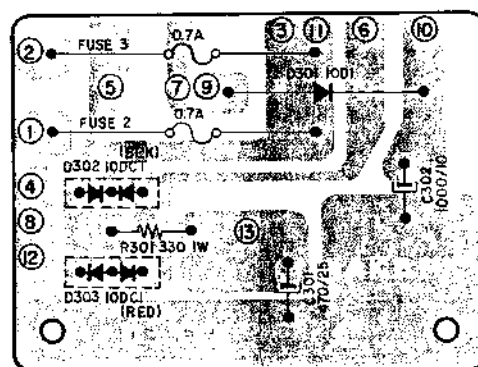

POWER SUPPLY P.C. BOARD (ED-513)

(Deck Only)

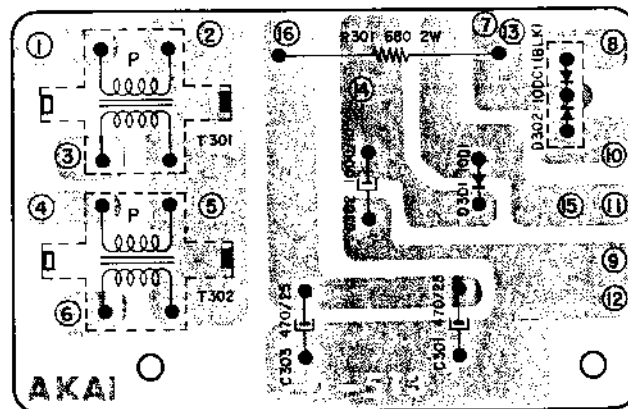

TONE CONTROL P.C. BOARD (ED-5003)

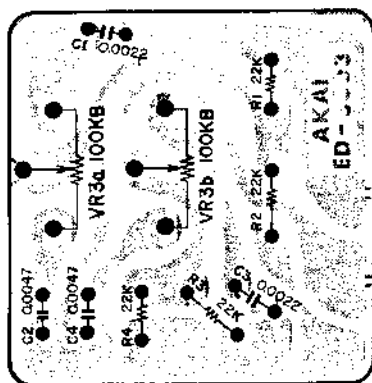

PROGRAM SWITCH P.C. BOARD (ED-309)

FUNCTION SWITCH P.C. BOARD (ED-524 4ED)

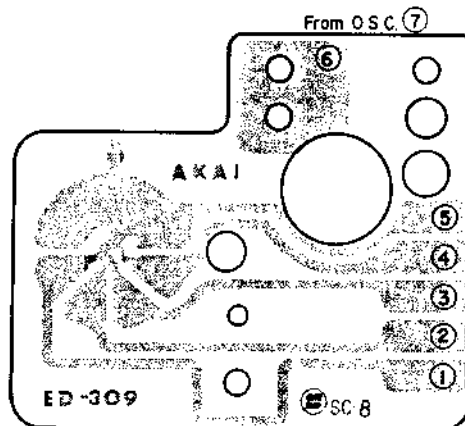
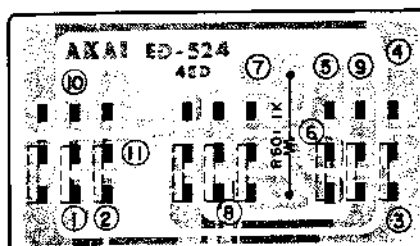

FM-AM IF P.C. BOARD (ED-C551)

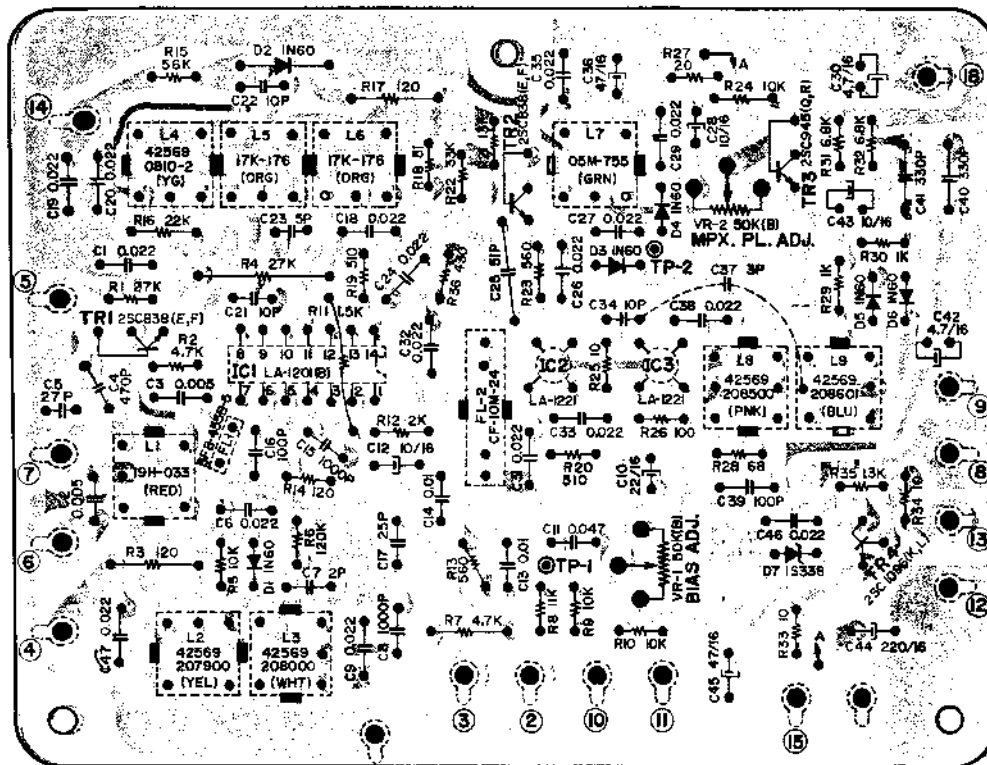

FM MPX. P.C. BOARD (ED-C553 2ED)

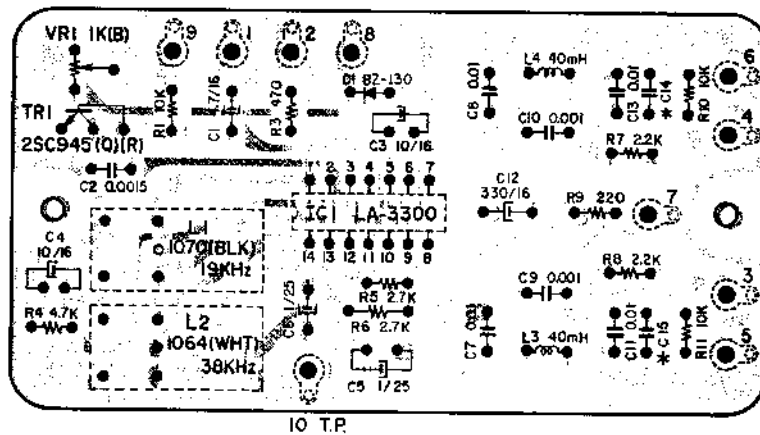

EQ. AMP. P.C. BOARD (ED-C552)

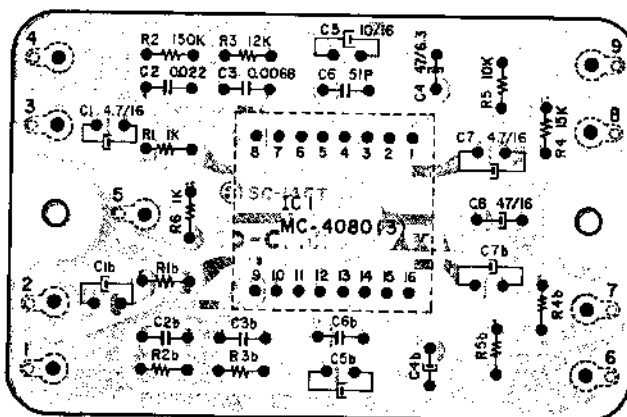

CR-8IT

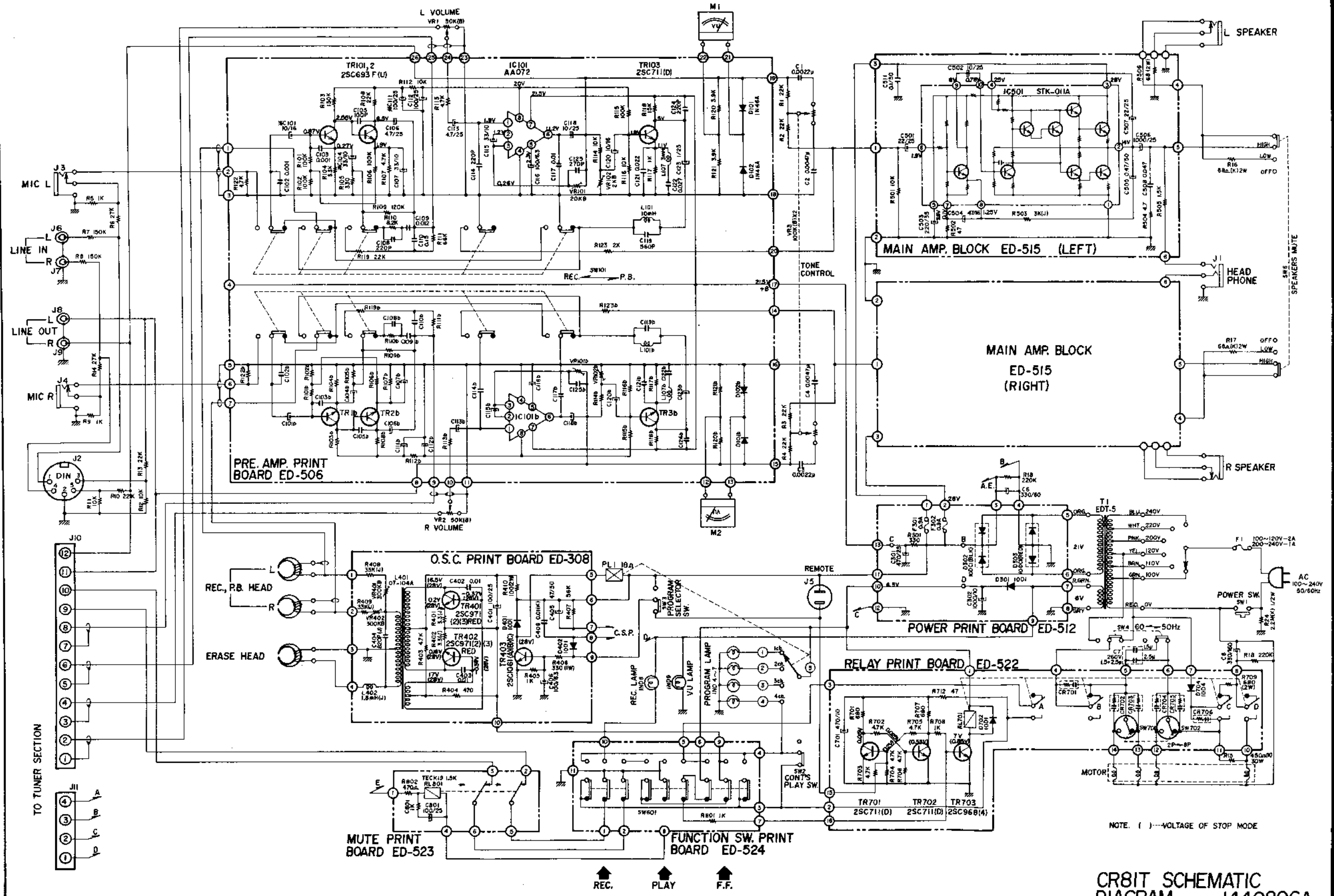

CR8IT SCHEMATIC DIAGRAM NO.2-1 1440806A

CR-8IT

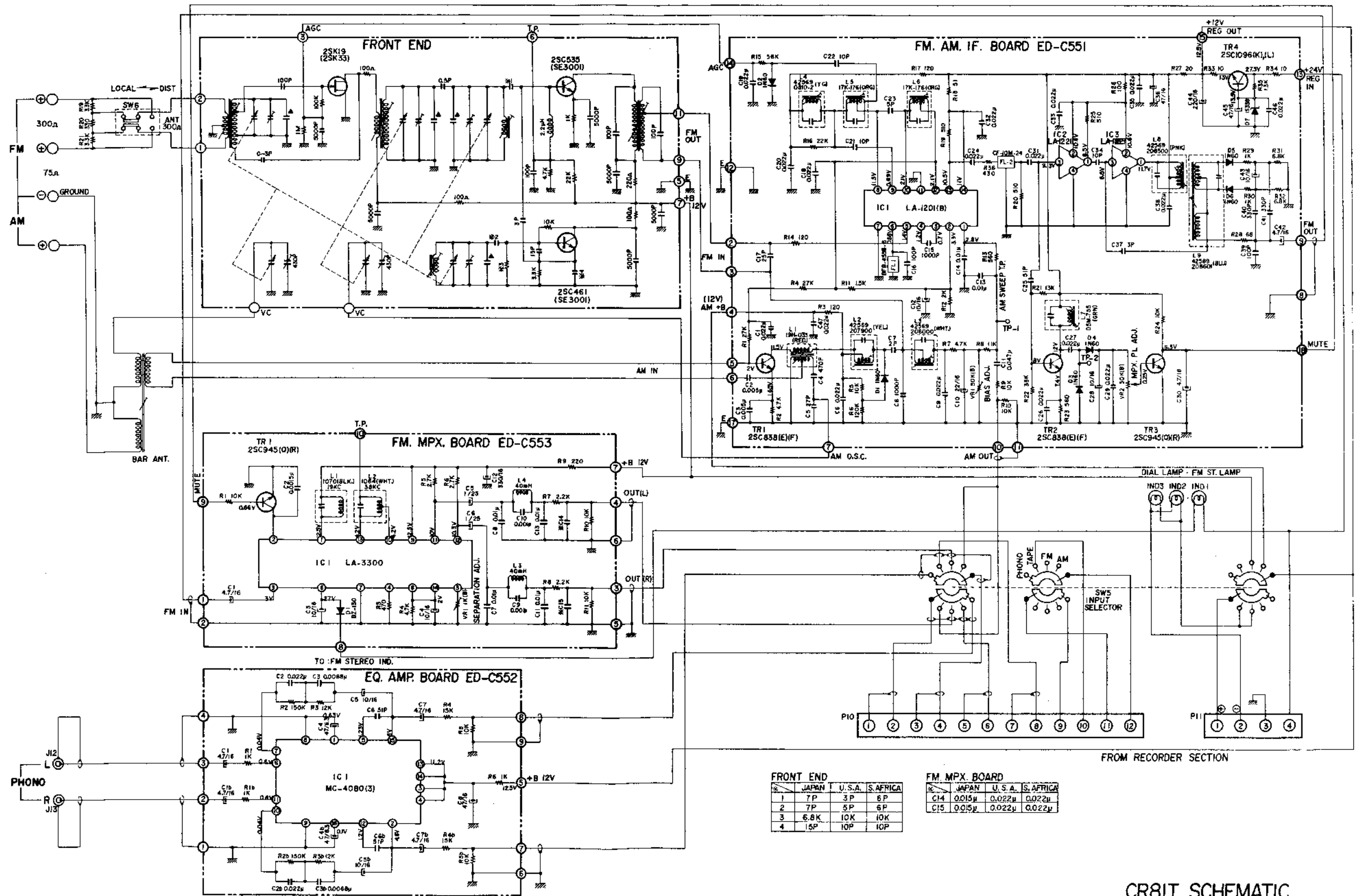

FRONT END

	JAPAN	U.S.A.	S. AFRICA
1	7P	3P	6P
2	7P	5P	6P
3	6.8K	10K	10K
4	15P	10P	10P

FM. MPX. BOARD

	JAPAN	U.S.A.	S. AFRICA
C14	0.015μ	0.022μ	0.022μ
C15	0.015μ	0.022μ	0.022μ

CR8IT SCHEMATIC
DIAGRAM No.2-2 1440808A

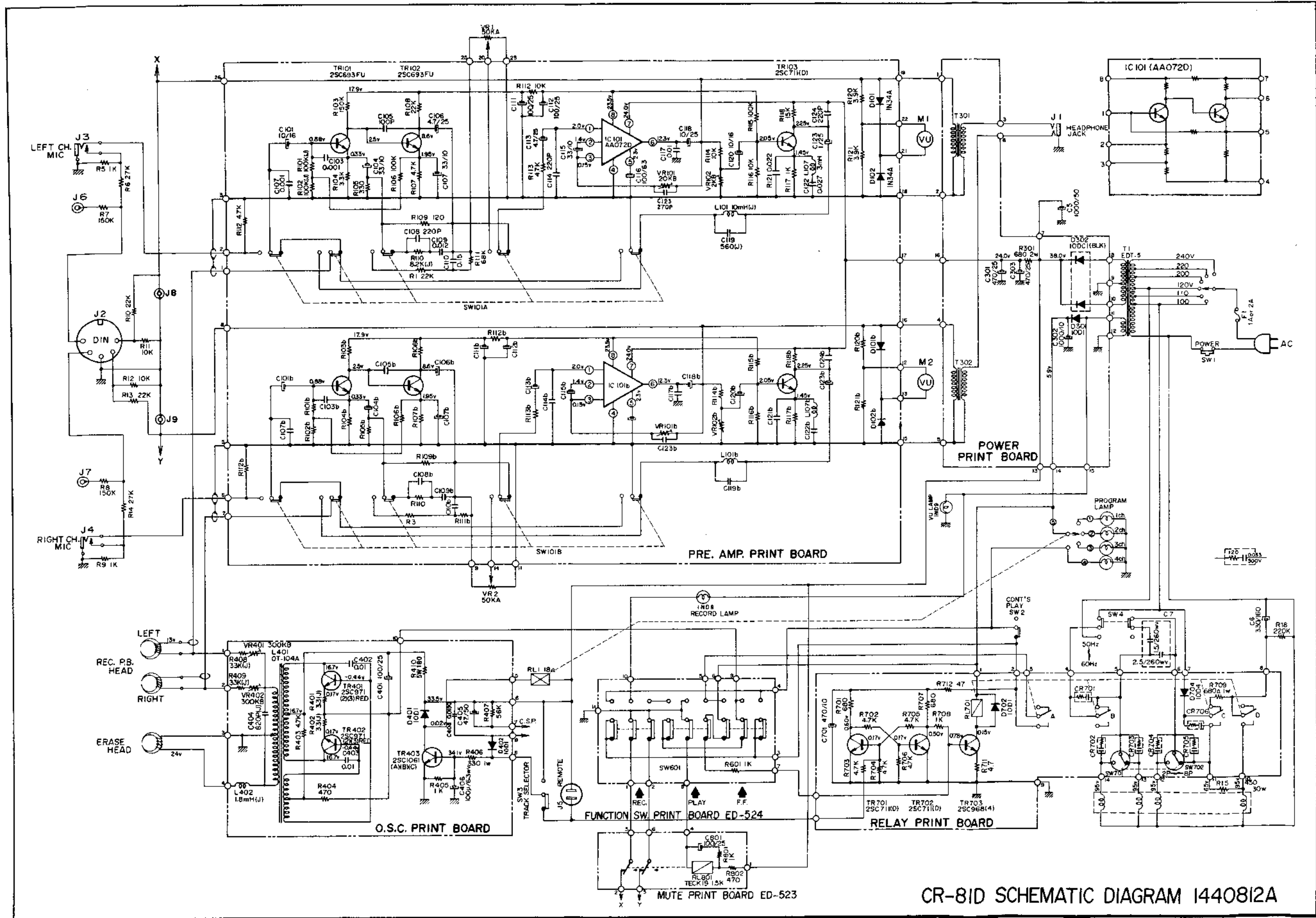

CR-8ID SCHEMATIC DIAGRAM 1440812A

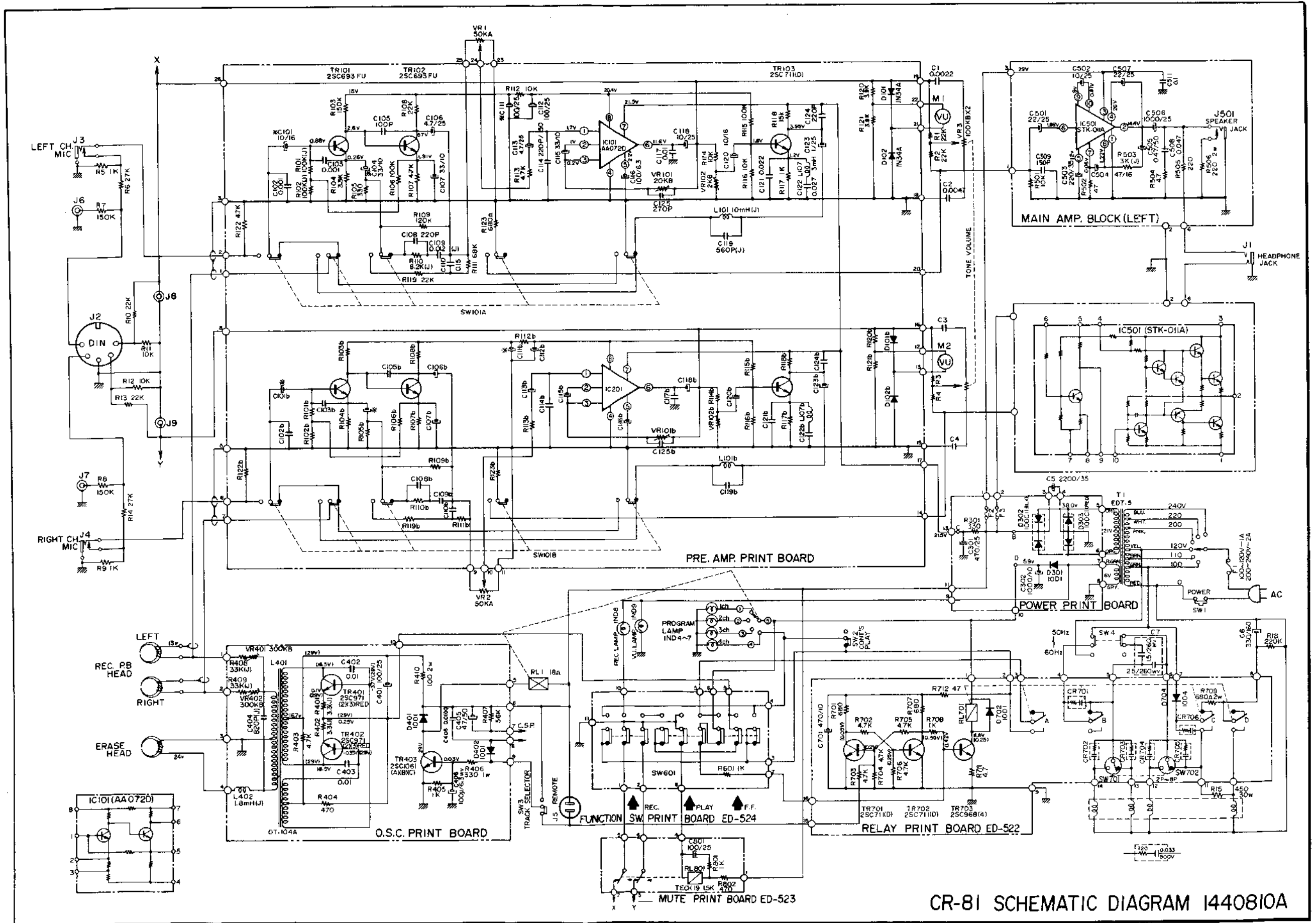

CR-81 SCHEMATIC DIAGRAM 1440810A