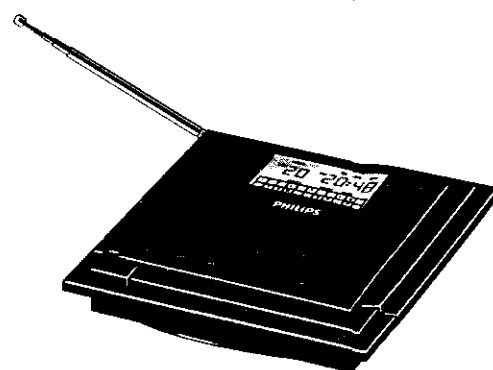


Portable compact disc player AZ6819

/00/00B/00G/01/05/17/18

Service
Service
Service



Service Manual

COMPACT
disc
DIGITAL AUDIO

Table of contents:

Specification	2
Survey of accessories	3
Shut off functions	3
Connections	3
Controls	4
Block diagram	5-7
Wiring diagram	8-9
Warnings	10
RC5-code	10
Abbreviations	11
Service tools	12
Service test program	13-15
Circuit diagram transmitter/controller part	16-18
Adjustment table transmitter part	19-20
Adjustment remarks transmitter part	20
Printed circuit board transmitter/controller part	21
Printed circuit board CD part	22
Adjustment table CD part	23-24
Adjustment remarks general/CD part	24
Circuit diagram servo control part	25-27
Printed circuit board CD part	28-30
Circuit diagram decoder/LF part	31-33
Exploded view	34
Mechanical partslist	35
Electrical partslist	35-40

*Pour votre sécurité, ces documents
doivent être utilisés par des spécia-
listes agréés, seuls habilités à réparer
votre appareil en panne*

CLASS 1
LASER PRODUCT



PHILIPS

SPECIFICATION

CD-part:

Frequency response : 20 - 20.000 Hz \pm 1dB
S/N ratio : 8 0 dB min.
THD : 0,20 % max. at 1 kHz
Line output level : 1,2 Vrms \pm 2dB at 0dB rec. level
Channel difference : 2 dB max. at 1 kHz
Channel crosstalk : - 50 dB max. at 1 kHz
Wow and flutter : none (quartz precision)
Deemphasis : 0 or 15/50 μ s switched automatically by subcode
DAC : 1 bit (BITSTREAM)

Transmitter-part:

Wave range for version : /00/01/05 /17 (USA) /18 (FRANCE)
Channel 1 (\pm 10 kHz) : 37,1 MHz 48,86 MHz 39,2 MHz
Channel 2 (\pm 10 kHz) : 36,7 MHz none 36,4 MHz
Radiated power : 10 μ W max.
Bandwidth : 180 kHz max.
S/N complete system
(3 m distance, DBB off) : > 60 dB
Antenna : Telescope 500 mm

Accessories:

RECHARGABLE BATTERY SBC 6408 (SLA)

Output voltage : 4 V nom.
Capacity : 600 mAh
Lifetime : 1,75 hours max.
Chargetime : 4 hours min.

AC/DC ADAPTOR SBC 6819 (centre positive)

Version	/00/18	/01	/05	/06	/17
Input voltage	: 220 V	120 / 230 V	240 V	100 V	120 V
	50 Hz	60 / 50 Hz	50 Hz	50 / 60 Hz	60 Hz
Input power	: 10 W max.				
Output voltage	: 6 - 6,7 V at 600 mA loaded				

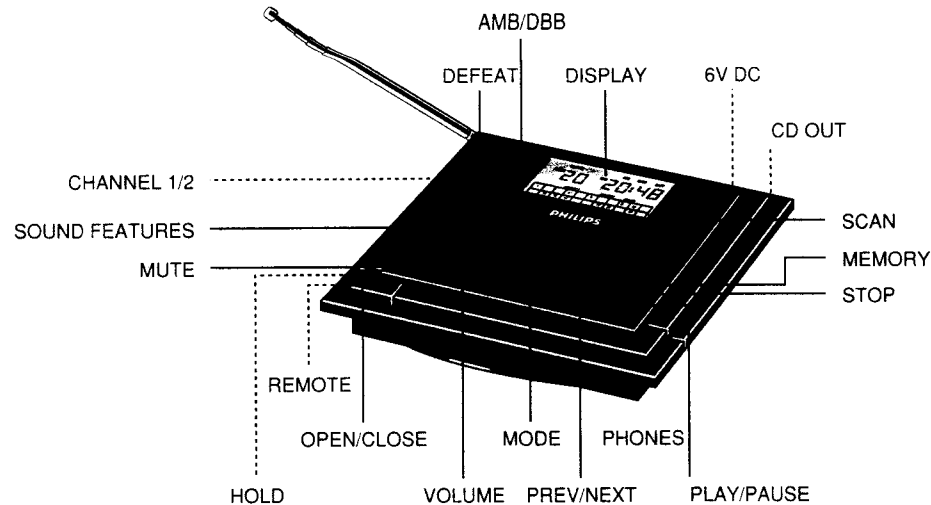
IR-REMOTE CONTROL SBC 6219

CORDLESS HEADPHONE SBC 3397 & STAND SBC 3398

RECHARGABLE BATTERY FOR CORDLESS HEADPHONE (NiCd)

Output voltage : 1,2 V nom.

SHUT OFF FUNCTIONS, CONNECTIONS



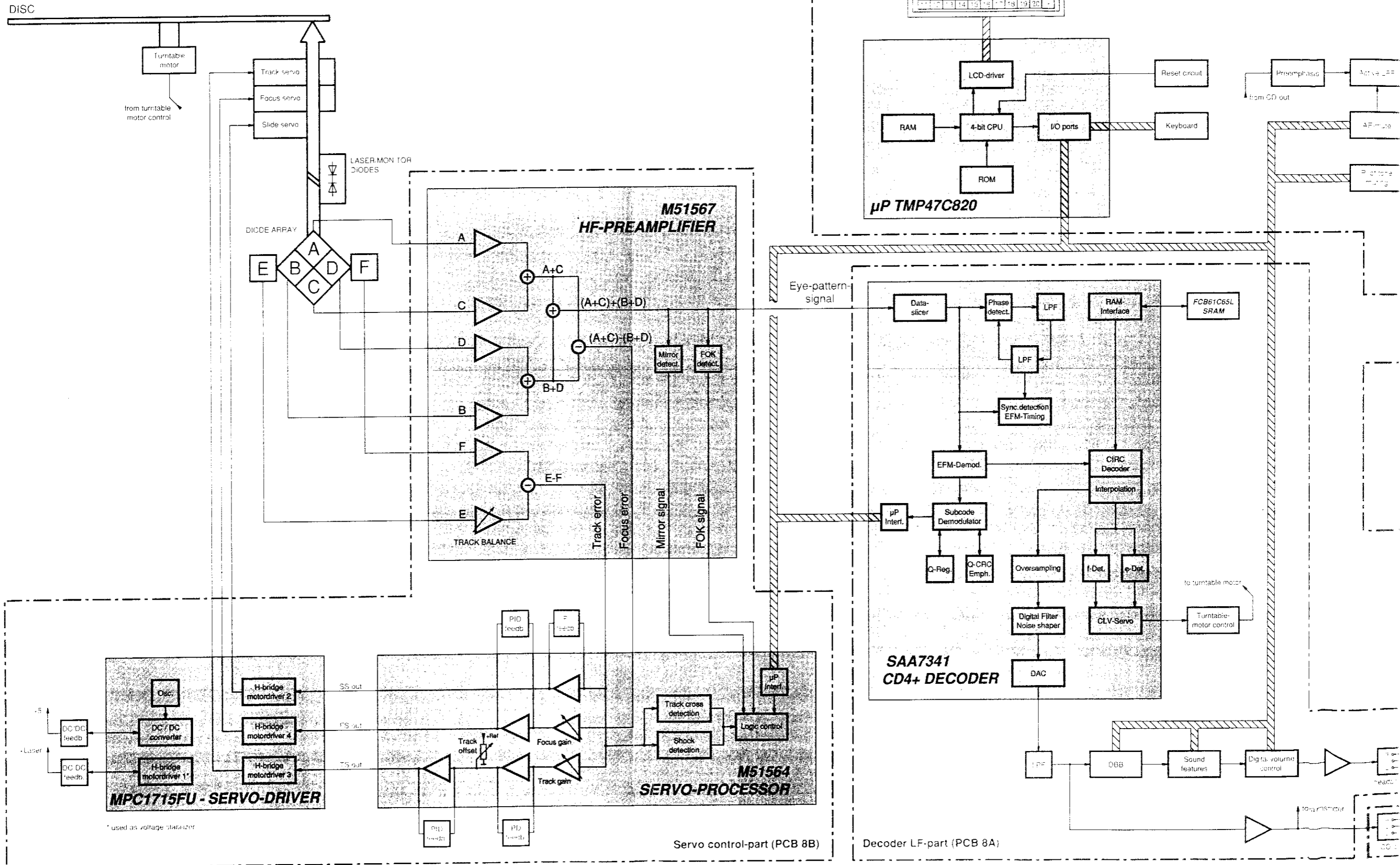
OPERATION	CONDITION	ACTION
CLOSE DOOR	POWER OFF	Power on - Start up - Read TOC - STOP - Update display-information (matrix, max. tracks on disc, length of CD)
OPEN DOOR	POWER ON/OFF	Power off - Clear display - Clear TOC - Clear program memory - Clear modes
Switch HOLD ON	POWER ON	All keys are ignored, flag hold is shown on the display. The set works normally with the wired- or the IR-remote control.
SHUT OFF	STOP	The set shuts off after approx. 30s after the last physical action. All parameters (program, volume, soundfeatures) are memorized.
BATTERY WEAK	POWER ON	Battery empty indication is flashing.
	POWER OFF	The set doesn't start up if PLAY is pressed. Flag battery empty is shown for 500ms.
BATTERY EMPTY	POWER ON	The set is switched off

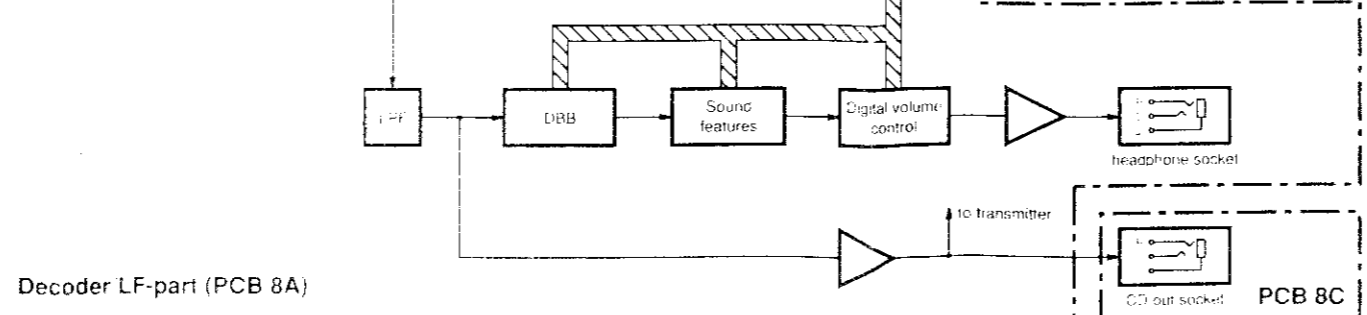
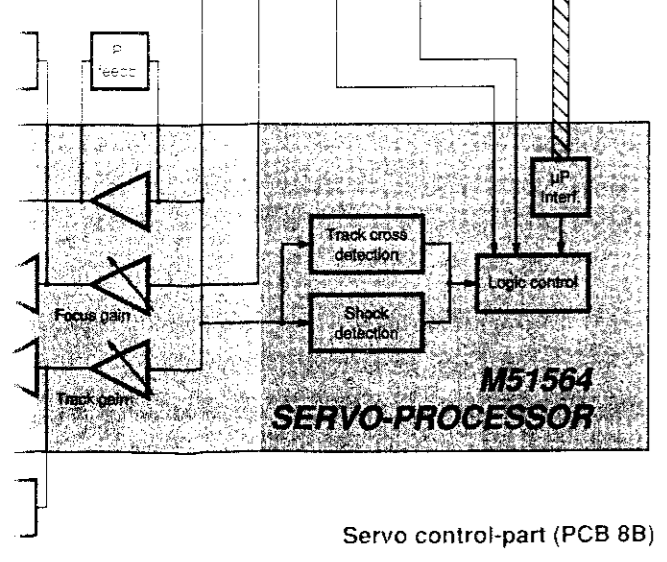
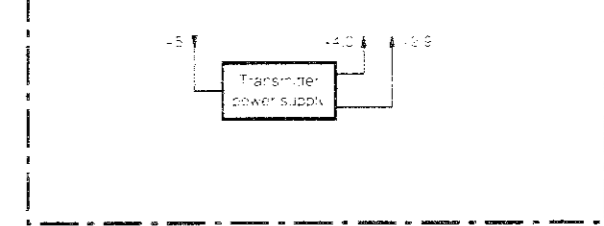
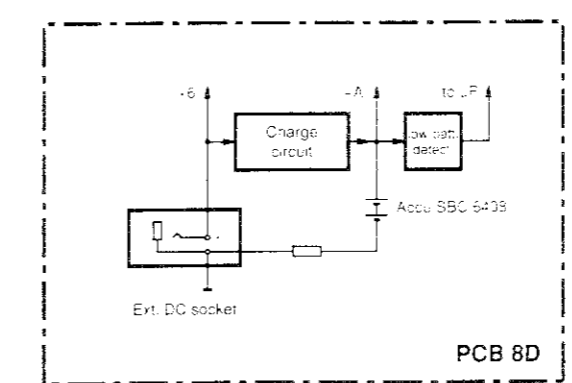
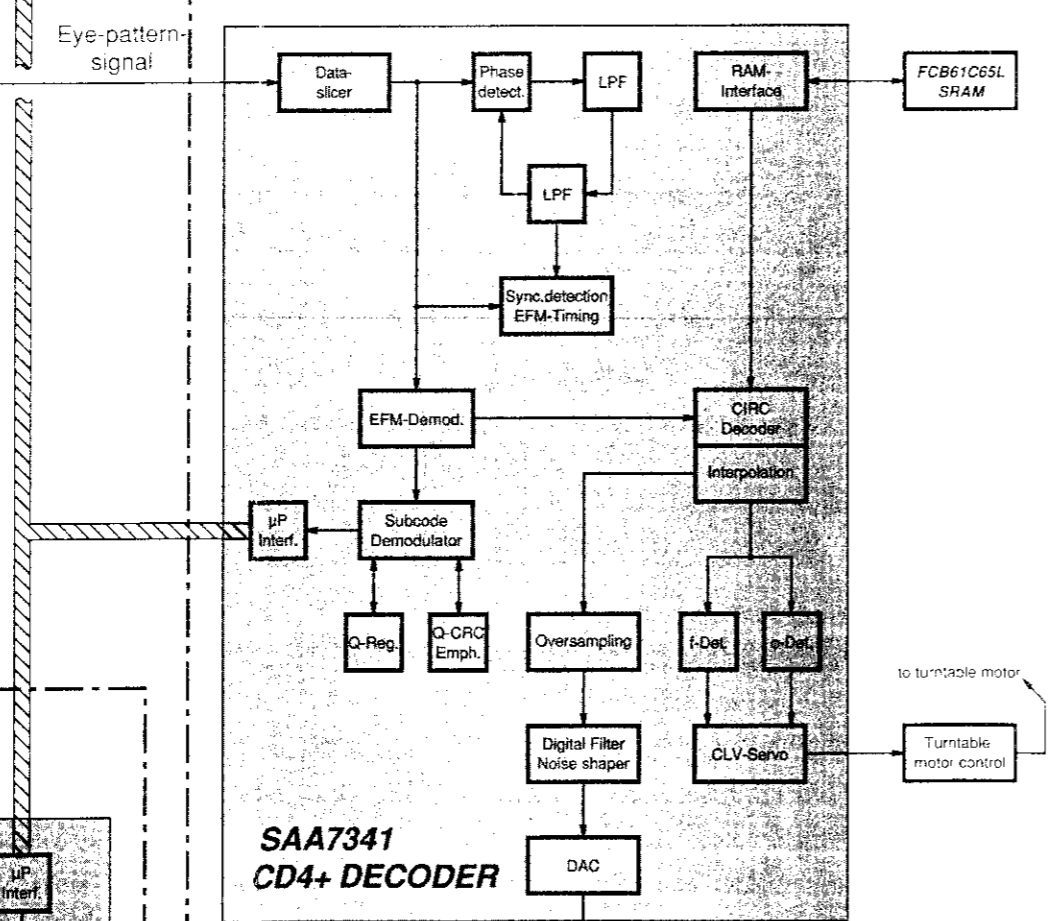
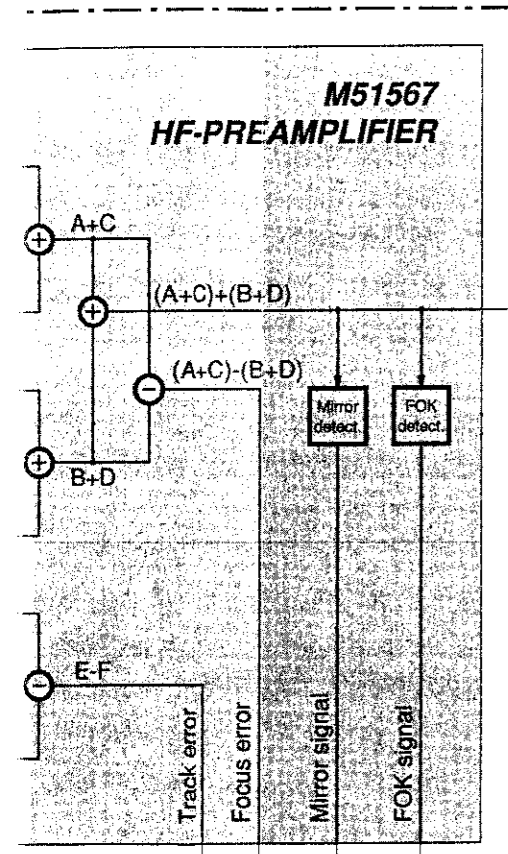
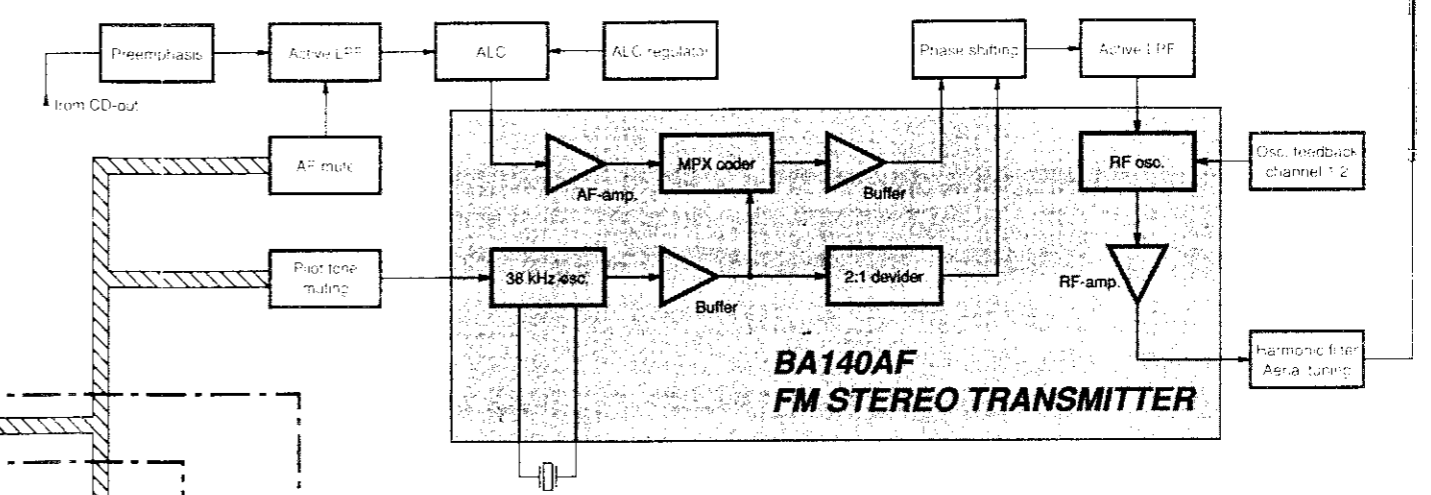
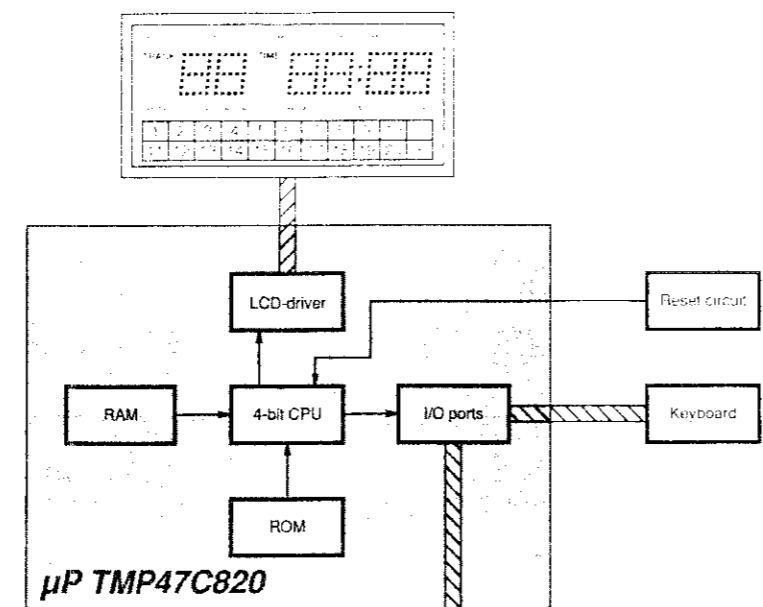
CONNECTION	
6 V DC	Socket for the mains adaptor / battery charger SBC 6619
PHONES	Headphone output
CD-OUT	Linear output for hifi-systems
REMOTE	Socket for the optional IR-transmitter SBC 6219

CONTROLS

KEY	CONDITION	ACTION
PLAY	POWER ON/OFF	Starts playing the 1st track, preselected track or 1st programmed track. The available tracks are shown on the matrix, the actual track is flashing.
	PLAY	Toggles between PLAY and PAUSE.
	STOP/TRACK STORED	The programmed tracknumbers are shown on the matrix. After starting up by pressing PLAY the actual tracknumber is flashing. An already played tracknumber will be cleared from the display.
	SCAN	Leaves the SCAN-mode and continues normal play.
	STOP/SHUFFLE	All existing (or programmed) tracknumbers are shown on the matrix. The set starts playing the first random track. An already played tracknumber will be cleared from the matrix.
STOP	PLAY	The set goes into STOP-mode, the display shows the TOC-informations.
	STOP	Clears the program-memory. "C" is shown on the display for 500ms.
NEXT	STOP	Tracknumber for playback can be selected. The selected track is flashing, all lower tracknumbers than the selected one are cleared from the matrix.
	PLAY	Skips forward to the next track.
	PLAY/MEMORY	Skips forward to the next stored track.
	PLAY/SHUFFLE	Skips forward to the next random-track. After reaching the last random-title a new sequence will be generated, the "shuffle-snake" is shown on the track-indication and all tracknumbers are flashing.
	PROGRAMMING	Skips forward to the next program-track.
	KEY DEPRESSED FOR MORE THAN 1s.	Fast forward till the key is released, high speed after 6s (except SCAN-mode).
PREV	STOP	Similar as NEXT, but opposite direction.
	PLAY	Skips backward to the previous track.
	PLAY/MEMORY	Skips backward to the previous stored track.
	PLAY/SHUFFLE	Skips backward to the previous random-track. After reaching the first shuffled title a new shuffle sequence will be started.
	PROGRAMMING	Skips backward to the previous program-track.
	KEY DEPRESSED FOR MORE THAN 1s.	Fast backward till the key is released, high speed after 6s (except SCAN-mode).
SCAN	PLAY/STOP	Scan starts from the first or selected track. The first 10s of the available tracknumbers will be audible.
PROGRAM	PLAY/STOP	PROGRAM-mode is activated. Tracks can be selected using NEXT/PREV. Pressing PROGRAM again will store the selected tracknumber - "P" is shown on the display. A maximum of 32 tracks can be stored. If the memory has been filled up "FULL" is shown on the display. To leave the PROGRAM-mode release the keys for approx. 3s.
	REVIEW	REVIEW is activated if the PROGRAM button is depressed for more than 1s. The programmed titles will be shown on the matrix.
MODE	PLAY/STOP	Scrolls the functions REPEAT 1 - REPEAT ALL - SHUFFLE - SHUFFLE REPEAT. The selected operation takes place when the current title has been changed.
VOL +	PLAY/STOP	Volume up (16 steps).
VOL -	PLAY/STOP	Volume down (16 steps).
JAZZ, POP, CLASSIC	PLAY/STOP	Soundfeatures
AMB, DBB, MUTE	PLAY/STOP	This soundfeatures can be added individually.
DEF	PLAY/STOP	Clears all soundfeatures.

BLOCKDIAGRAM





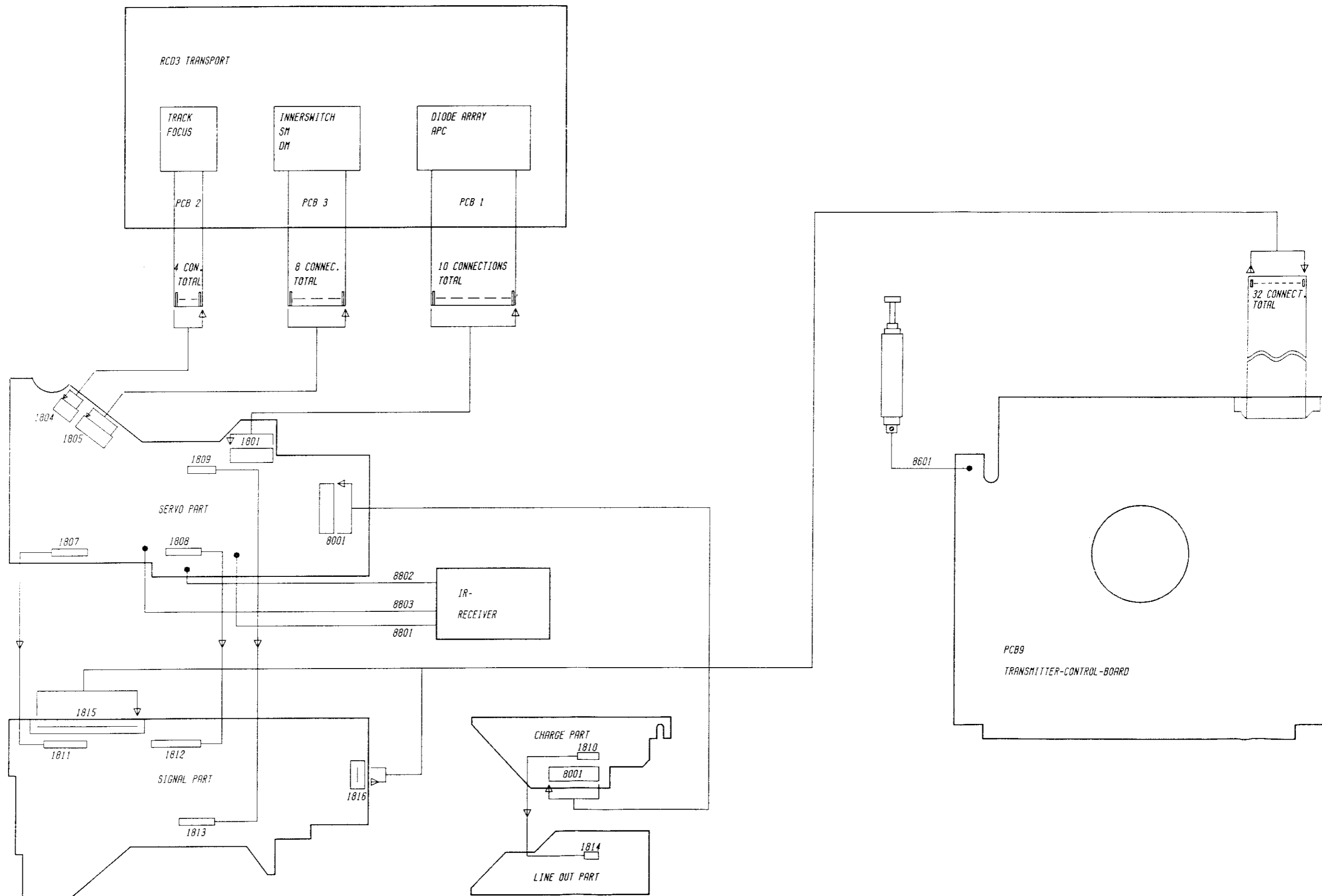
Servo control-part (PCB 8B)

Decoder LF-part (PCB 8A)

PCB 8C

PCB 8D

WIRING DIAGRAM



GB WARNING

All ICs and many other semiconductor are susceptible to electrostatic discharges (ESD). Careless handling during repair can reduce life drastically. When repairing, make sure that you are connected with the same potential as the mass of the set via a wrist wrap with resistance. Keep components and tools at this potential.

E ATTENTION

Tous les IC et beaucoup d'autres semi-conducteurs sont sensibles aux décharges statiques (ESD). Leur longévité pourrait être considérablement écourtée par le fait qu'aucune précaution n'est prise à leur manipulation. Lors de réparations, s'assurer de bien être relié au même potentiel que la masse de l'appareil et enfilez le bracelet senti d'une résistance de sécurité. Veiller à ce que les composants ainsi que les outils que l'on utilise soient également à ce potentiel.

GB

Safety regulations require that the set be restored to its original condition and that parts which are identical with those specified be used.

D

Bei jeder Reparatur sind die geltenden Sicherheitsvorschriften zu beachten. Der Originalzustand des Gerätes darf nicht verändert werden. Für Reparaturen sind Originalersatzteile zu verwenden.

S Varning !

Osynlig laserstrålning när denna del är öppnad och spårren är urkopplad. Beträkta ej strålen.

F

Pour votre sécurité, ces documents doivent être utilisés par des spécialistes agréés, seuls habilités à réparer votre appareil en panne.

ESD**D WARNUNG**

Alle ICs und viele andere Halbleiter sind empfindlich gegenüber elektrostatischen Entladungen (ESD). Unvorsichtige Behandlung im Reparaturfall kann die Lebensdauer drastisch reduzieren. Sorgen Sie dafür, daß sie im Reparaturfall über ein Pulsarmband mit Widerstand mit dem Massepotential des Gerätes verbunden sind. Halten Sie Bauteile und Hilfsmittel ebenfalls auf diesem Potential.

I

Le norme di sicurezza estigono che l'apparecchio venga rimesso nelle condizoni originali e che siano utilizzati i pezzi di ricambio identici a quelli specificati.

F

Les normes de securite exigent que l'appareil soit remis à l'état d'origine et que soient utilisées les pièces de rechange identiques à celles spécifiées.

DK Advarsel !

Usynlig laserstrålning ved åbning når sikkerhedsafbrydere er ude af funktion. Undgå udsættelse for strålning.

NL WAARSCHUWING

Alle IC's en vele andere halfgeleiders zijn gevoelig voor electrostatische ontladingen (ESD). Onzorgvuldig behandelen tijdens reparatie kan de levensduur drastisch doen verminderen. Zorg ervoor dat u tijdens reparatie via een polsband met weerstand verbonden bent met hetzelfde potentiaal als de massa van het apparaat. Houd componenten en hulpmiddelen ook op ditzelfde potentiaal.

I AVVERTIMENTO

Tutti IC e parecchi semi-conduttori sono sensibili alle scariche statiche (ESD). La loro longevità potrebbe essere fortemente ridotta in caso di non osservazione della più grande cauzione alla loro manipolazione. Durante le riparazioni occorre quindi essere collegato allo stesso potenziale che quello della massa dell'apparecchio tramite un braccialeto a resistenza. Assicurarsi che i componenti e anche gli utensili con quali si lavora siano anche a questo potenziale.

NL

Veiligheidsbepalingen vereisen, dat het apparaat in zijn oorspronkelijke toestand wordt teruggebracht en dat onderdelen, identiek aan de gespecificeerde, worden toegepast.

SF Varoitus !

Läite sisältää laserdiodin, joka lähettää näkymätöntä silmille vaarallista lasersäteilyä.

ABBREVIATIONS

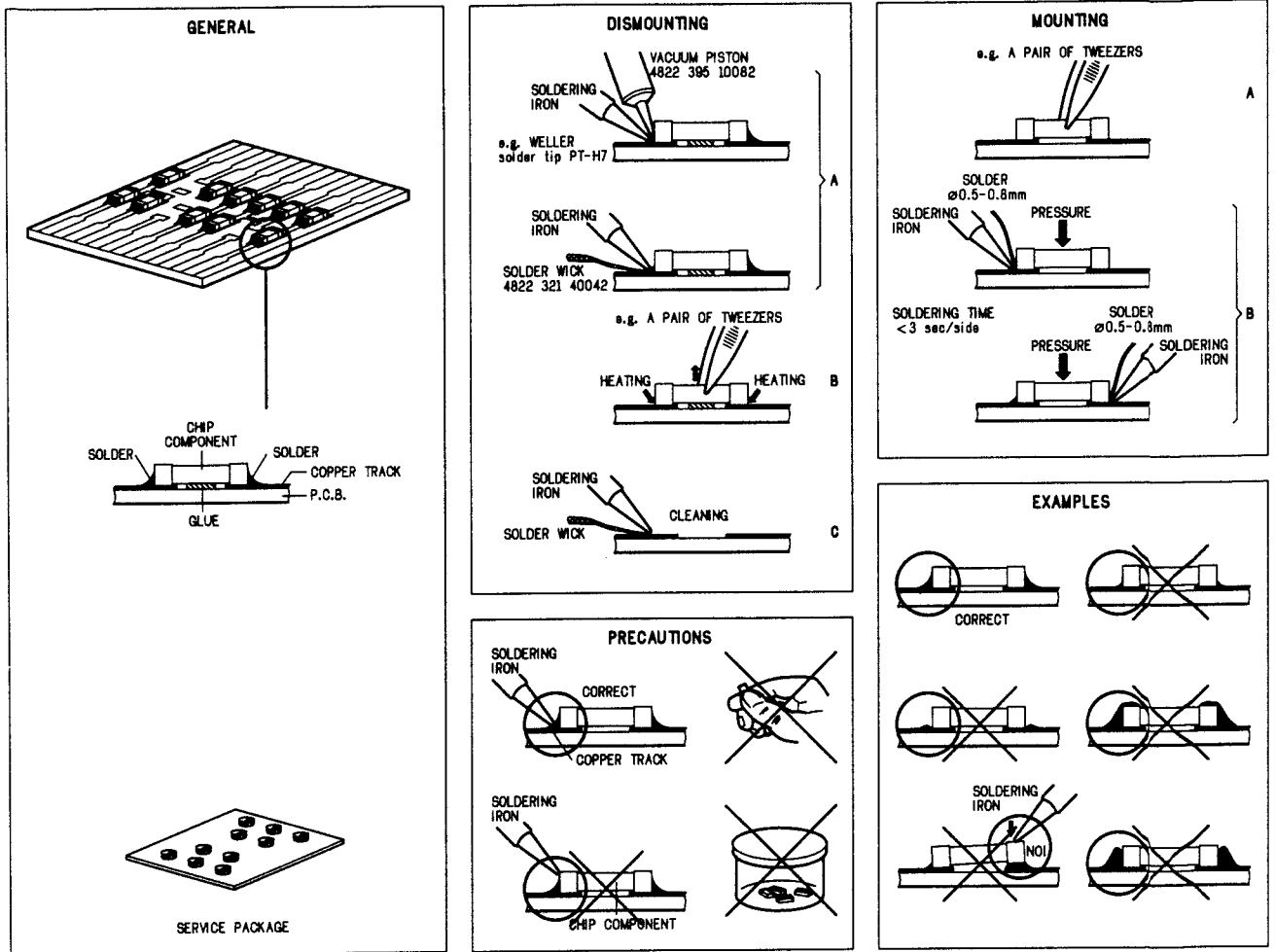
A - F	: Photodiode array outputs	SBCV	: Subcode V channel output
ACLR*	: COM interface register clear input	SBCW	: Subcode W channel output
ACLR*	: All clear input	SCCK	: Shift clock input for serial subcode data output
ACRCY	: Clock accuracy input	SCINT	: interrupt output of subcode Q
AOL	: Analog output left channel	SCOE1	: Enable input of subcode T-W channel output
AOR	: Analog output right channel	SCOE2	: Enable input of subcode P-S channel output
APTL	: DAC sampling clock left channel	SCOR	: Subcode sync. output
APTR	: DAC sampling clock right channel	SHOCK	: Shock detector signal input
BCK	: Bit clock input	SQRCK	: Subcode Q register
BIAS	: Outputs reference voltage (VCC/2 at single supply voltage)	SQRO	: Subcode Q register output
C FSR	: Connects the external capacitance for time constant of focus search	SS OUT	: Sledge servo amplifier output
C16M1	: 1/2 divider input with internal feedback resistor	SS+ / SS-	: Sledge servo amplifier positive / negative input
C423	: Clock output 4.2336MHz	SYCLK	: Frame lock status output (Lock = "H")
C846	: Clock output 8.4672MHz	TB	: Tracking balance input
C8MO	: 1/2 divider output	TC IN	: Track cross signal input
CAS*	: Column addr. strobe signal output to RAM	TE IN	: Track error signal input
COM	: Common	TE OUT	: Track error amplifier output
CRCF	: Subcode Q CRC check flag output	TE-	: Track error amplifier negative input
DASEL1-4	: Selection of DAC interface format	TEST1	: Test control input
DATA OUT	: Inner condition output changed by command modes	TG1 / TG2	: Tracking gain switch 1/2 output
DLRCK	: Left-right channel clock	TLC	: Output from slice level control
DM1 / DM2	: Turntable motor driving outputs	TRHLD	: Direct control pin of TS1 switch
DO1	: Dual DAC right channel serial data output	TS OUT	: Track servo amplifier output
DO2	: Dual DAC left channel serial data output	TS+ / TS-	: Track servo amplifier positive / negative input
DOBSEL	: Data bit select (18 bit = "H")	VCC	: Positive supply voltage
DOFK	: Frame clock output 7.35kHz (duty = 50%)	VDD	: positive power supply
DOTX	: Output of digital interface	VEE	: Negative supply voltage
DRD	: Disc rotation down signal output	VREF	: Reference voltage
DSCK	: Data shift clock to DAC	VSS	: Ground 0V
EFFK	: EFM frame clock output (duty = 50%)	WDCK	: Word clock to DAC or APTL clock
EFM	: Eight to fourteen modulation	WE*	: Write enable output to RAM
EMP	: Emphasis flag output (Emphasis = "H")	WS	: Word select input
EST1	: Error status1 (Error detected at C1-decoder)	XI	: Crystal oscillator input with internal feedback resistor
EST2	: Error status2 (Error to be interpolated detected at C2-decoder)	XO	: Crystal oscillator output
FG	: Focus gain switch output		
FS OUT	: Focus servo amplifier output		
FS+ / FS-	: Focus servo amplifier positive / negative input		
FSCK	: Clock output 44.1kHz (fs)		
FSR IN	: Focus search detector input		
GND	: Ground 0V		
HF	: High frequency signal input		
HF OK	: HF OK signal input		
HFD*	: High frequency signal detection		
HFD*	: Outputs "H", when MR = "H" and tracking servo loop cuts off		
HOUT 2A/2B	: Sledge motor driving PWM outputs		
HOUT 3A/3B	: Track servo driving PWM outputs		
HOUT 4A/4B	: Focus servo driving PWM outputs		
IREF	: Current reference		
JMP	: Outputs "H" under jump function		
JP1*, JPI*	: 1 track jump control signal input (usually "H")		
LOCK/DRD	: Lock status / Disc rotation down signal output		
LPF	: PLL loop filter		
LRCK	: Left/right channel clock to DAC or APTL clock		
MCK	: COM interface shift clock input		
MLA*	: COM interface data latch clock input		
MR	: Mirror detected signal input		
MSD	: COM interface serial data input		
NC	: No connection		
OPU	: Optical pick-up unit		
PWM _i -2	: Turntable motor driving PWM outputs		
RADO-7	: Address output 0-7 to RAM		
RAS*	: Row address strobe signal output to RAM		
RDB1-4	: Data input/output 1-4 to RAM		
SBCP	: Subcode P channel output, P - W channel serial data output		
SBCQ	: Subcode Q channel output		
SBCR	: Subcode R channel output		
SBCS	: Subcode S channel output		
SBCT	: Subcode T channel output		
SBCU	: Subcode U channel output		

* LOG. "0" ACTIVE !

RC 5 - CODE

SYSTEM-CODES 20 AND 21 ARE RECOGNICED (CD AND COMBI)			
KEY	COMMAND CODE	KEY	COMMAND CODE
MUTE	13	FAST BACKWARD	50
VOLUME UP	16	FAST FORWARD	52
VOLUME DOWN	17	PLAY	53
SHUFFLE	28	STOP / CLEAR PROGRAM	54
REPEAT ALL	29	AMBIENCE	64
SKIP FORWARD	32	JAZZ	67
SKIP BACKWARD	33	POP	68
STORE	41	CLASSIC	69
INTRO SCAN	43	DBB	70
PAUSE	48	DEFEAT	72

HANDLING CHIP COMPONENTS



SERVICE - TOOLS

- Audio signal disc 4822 397 30184
- Disc without errors (test disc 5) + disc with drop outs, black spots and fingerprints (test disc 5A) 4822 397 30096
- 3" test disc 4822 397 30229
- Tox screwdriver set 4822 395 50145
- Service extension PCB * 4822 267 31332

* This service tool has been designed to allow measurements between the PCBs during play and is only useful together with the 3" test disc.

SERVICE TEST PROGRAM

1. PRELIMINARY SETUP

To get into the service test program hold the keys PLAY & STOP depressed while turning POWER ON. The display is as shown in fig. 1. **IMPORTANT NOTES:** The door switch is ignored by software and the door can be opened during the test procedure. This might be helpful when checking the movement of the lens. **ATTENTION:** The laser beam is also kept emitting - Please take care of safety requirements !

2. SERVICE STEP 1 - SLIDE MOVEMENT

To get into the service step 1 fulfil preliminary setup. The position of slide-motor can be defined by holding NEXT resp. PREV depressed. At the inner and outer endpoints ratcheting will be audible. Stop pressing the keys at this points. To get into service step 2 press the PLAY button.

3. SERVICE STEP 2 - LENS MOVEMENT & FOCUS SEARCH

Display is as shown in fig. 2. To check movement of the lens open door and remove the disc. The lens should move up/down continuously, the focus control circuit is activated. Signal 11 can be measured on pin 29 of the servo processor 7802. To check the focus search procedure insert disc and. If a focus has been found the display is as shown in fig. 3. To get into service step 3 press the PLAY button, to return to service step 1 press STOP.

4. SERVICE STEP 3 - TURNTABLE MOTOR

Display is as shown in fig. 4. The turntable motor will start rotating, the focus control circuit is activated. To get into service step 4 press the PLAY button, to return to service step 1 press STOP.

5. SERVICE STEP 4 - TRACKING

Display is as shown in fig. 5. Focus-, track- and slide control circuits are activated, music is audible. This mode is equal to the normal play mode without soundfeatures and special functions (scan, shuffle, ...). To jump 12 tracks forward/backward press the keys NEXT resp. PREV. To get into service step 5 press the PLAY button, to return to service step 1 press STOP.

6. SERVICE STEP 5 - DISPLAY TEST 1

Display is as shown in fig. 6 - All vertical segments, all sound-feature flaggs and the hold flagg are activated. To get into service step 6 press the PLAY button, to return to service step 1 press STOP.

7. SERVICE STEP 6 - DISPLAY TEST 2

Display is as shown in fig. 7 - All horizontal segments and all mode flaggs are activated. To get into service step 6 press the PLAY button, to return to service step 1 press STOP.

8. SERVICE STEP 7 - DISPLAY TEST 3

Display is as shown in fig. 8 - All existing segments are activ. To leave the service test program disconnect the set from the power supply, to return to service step 1 press STOP.

FACTORY TEST PROGRAM

1. PRELIMINARY SETUP

To get into the factory test program hold the keys JAZZ & POP & CLASSIC depressed while turning POWER ON. The display is as shown in fig. 9. **IMPORTANT NOTES:** The door switch is ignored by software and the door can be opened during the test procedure. **ATTENTION:** The laser beam is also kept emitting - Please take care of safety requirements !

2. FACTORY STEP 1/2 - PORTTEST 1/2

To get into service step 1 fulfil preliminary setup. Porttest 1 is started immediately. Display is as shown in fig. 9. To get into porttest 2 press the NEXT button. Display is as shown in fig. 10. **NOTE:** These procedures require special test adaptors and are used during the production process only. Please ignore porttests and go on with factory step 3 - keytest.

3. FACTORY STEP 3 - KEYTEST

To get into service step 3 fulfil preliminary setup and press the NEXT button twice. The keynumber of NEXT (14) is shown on the display immediately. Please press the following buttons and check their corresponding keynumbers:

JAZZ, MEM.	01	AMBIENCE	06	DEFEAT	11
CLASSIC	02	DBB	07	MODE	12
POP	03	PREV	08	STOP	13
SCAN	04	VOL+	09	(NEXT	14)
MUTE	05	VOL-	10	PLAY	15

To get into factory step 4 press the NEXT button.

4. FACTORY STEP 4 - OSCILLATOR TEST

This test checks the quartz-oscillators 5900 (32,76 kHz) and 5901 (6 MHz). When no fault has been found the display is as shown in fig. 11 else the display shows fig. 12. To get into factory step 5 press the NEXT button.

5. FACTORY STEP 5 - DISPLAY TEST 1

Display is as shown in fig. 6. All vertical segments, all sound-feature flaggs and the hold flagg are activated. To get into factory step 6 press the NEXT button.

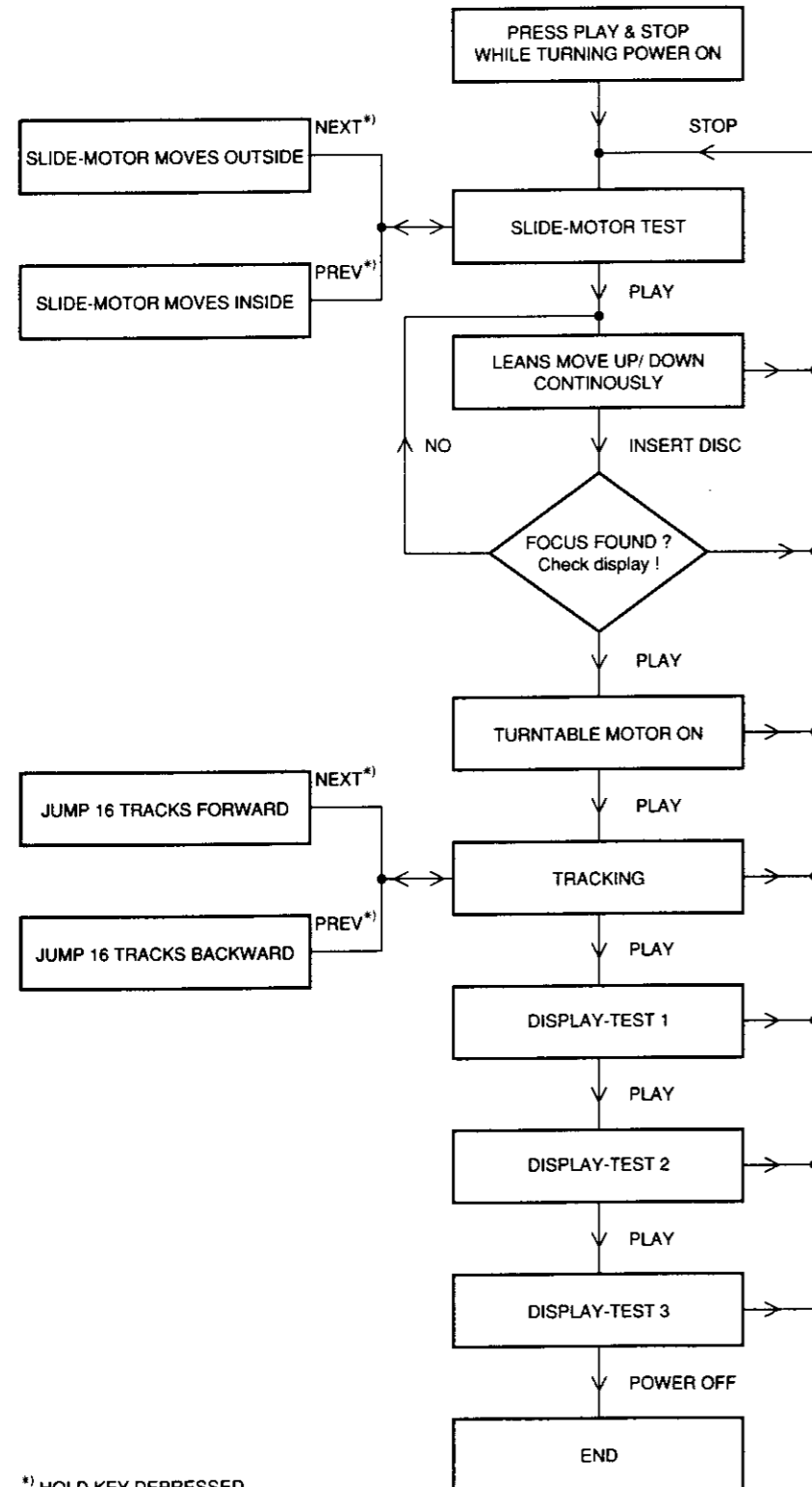
6. FACTORY STEP 6 - DISPLAY TEST 2

Display is as shown in fig. 7 - All horizontal segments and all mode flaggs are activated. To get into factory step 7 press the NEXT button.

7. FACTORY STEP 7 - DISPLAY TEST 3

Display is as shown in fig. 8 - All existing segments are activ. To leave the factory test program disconnect the set from the power supply.

SERVICE TEST PROGRAM



*1) HOLD KEY DEPRESSED

FACTORY TEST PROGRAM

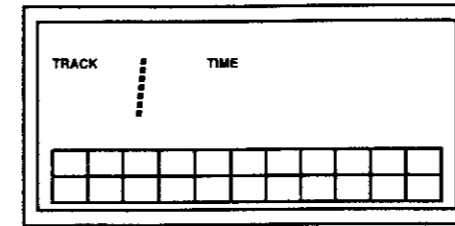
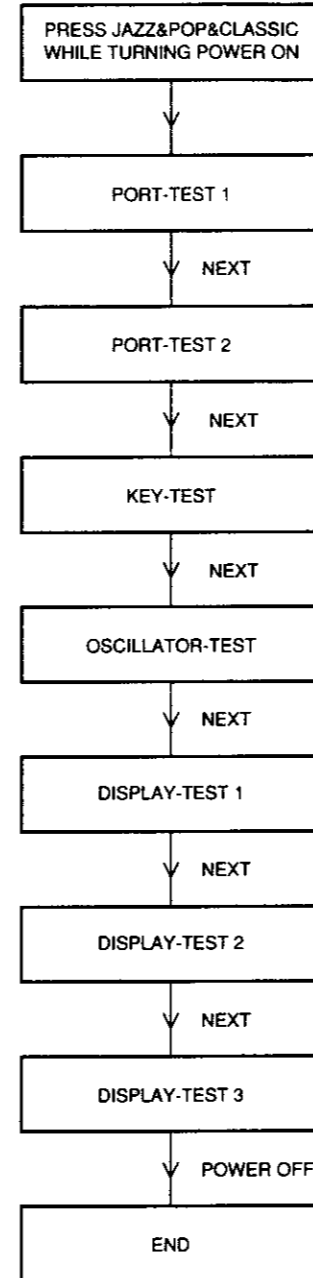


Fig. 1

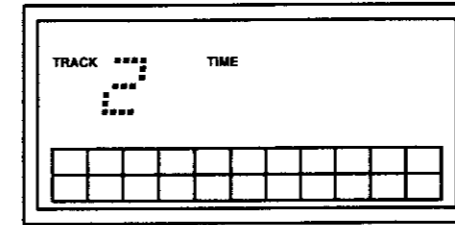


Fig. 2

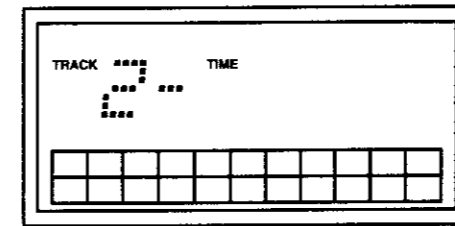


Fig. 3

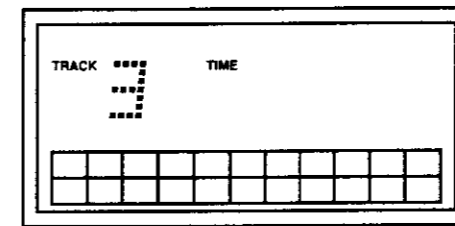


Fig. 4

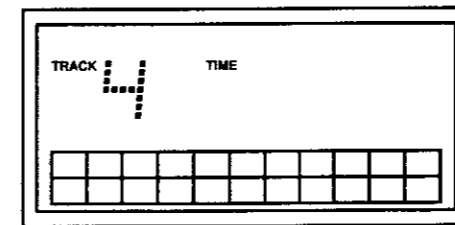


Fig. 5

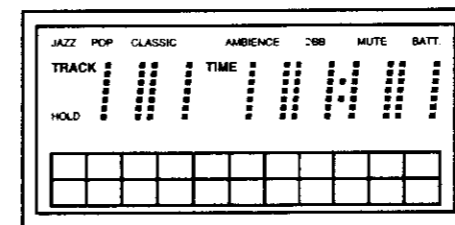


Fig. 6

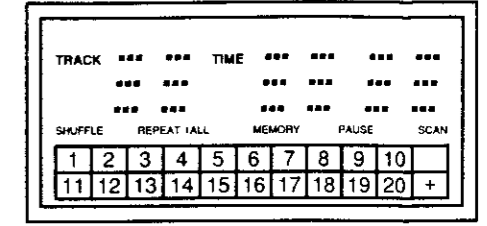


Fig. 7

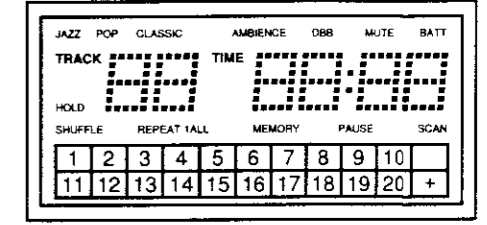


Fig. 8

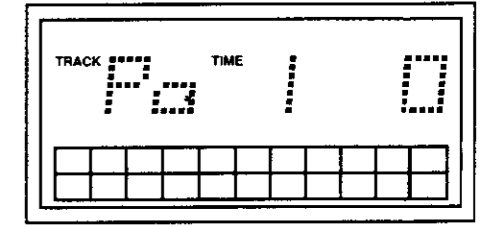


Fig. 9

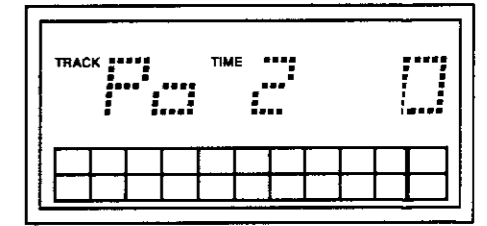


Fig. 10

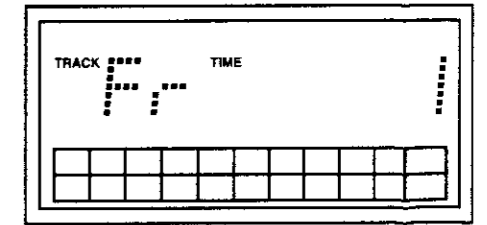


Fig. 11

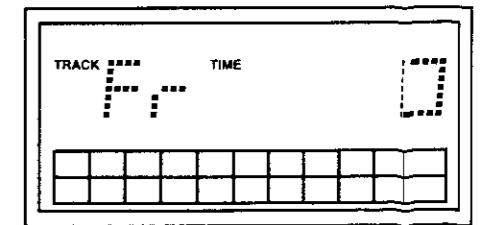
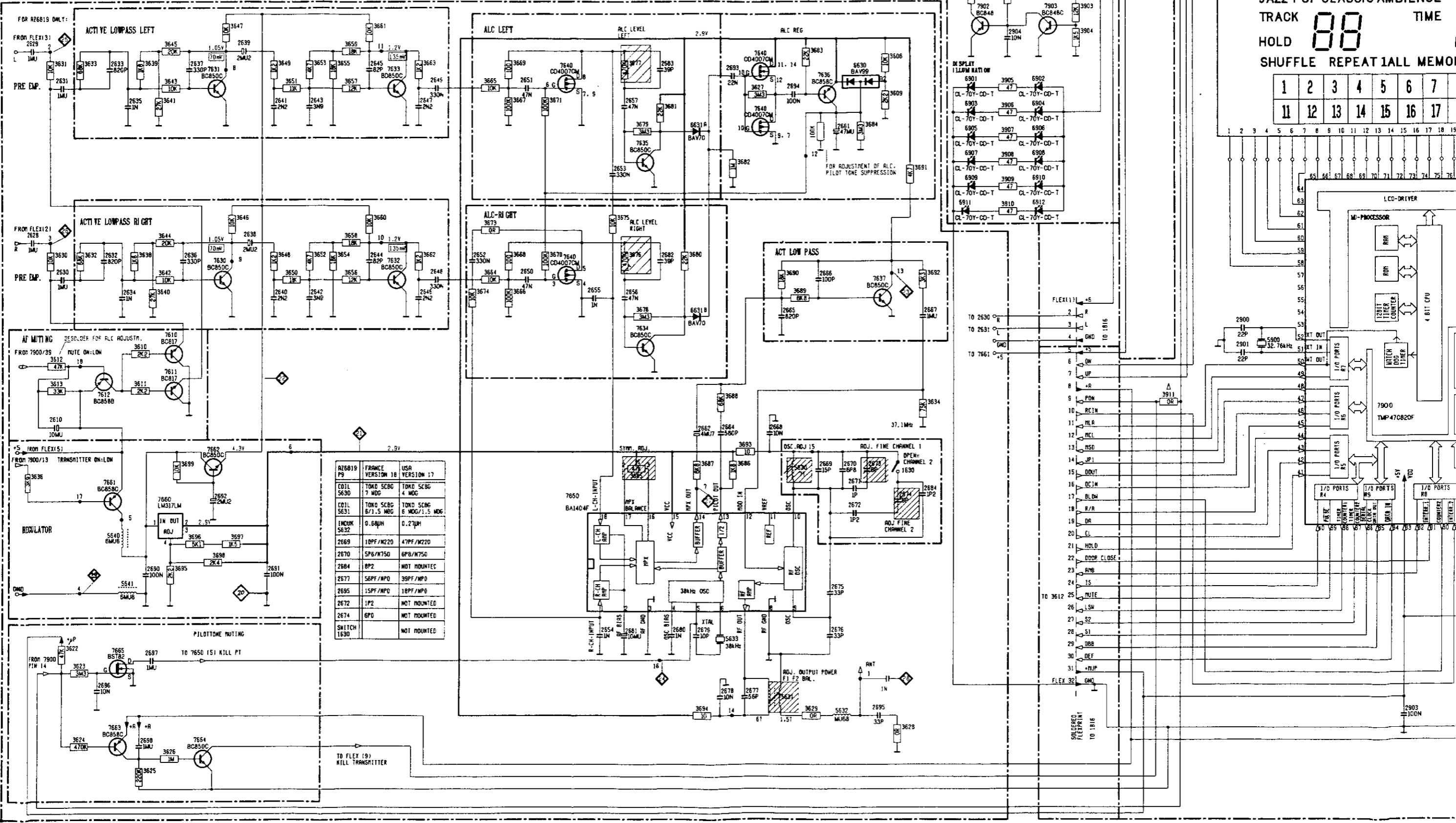


Fig. 12

TRANSMITTER/CONTROLLER BOARD

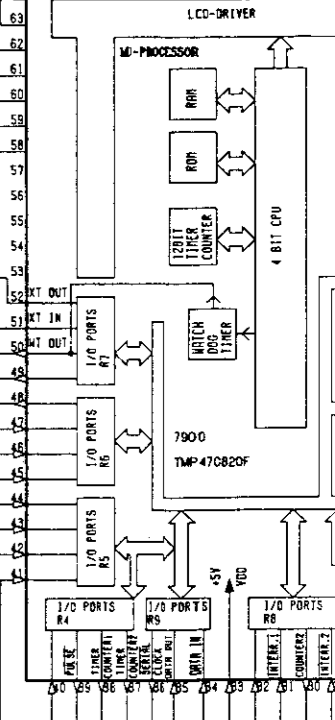
VOLTAGES MEASURED WITH 1MHz/250mV RMS SIM TEST STORL
 AC BETWEEN \diamond \diamond RESP \diamond \diamond 13612 DESOLDERED!

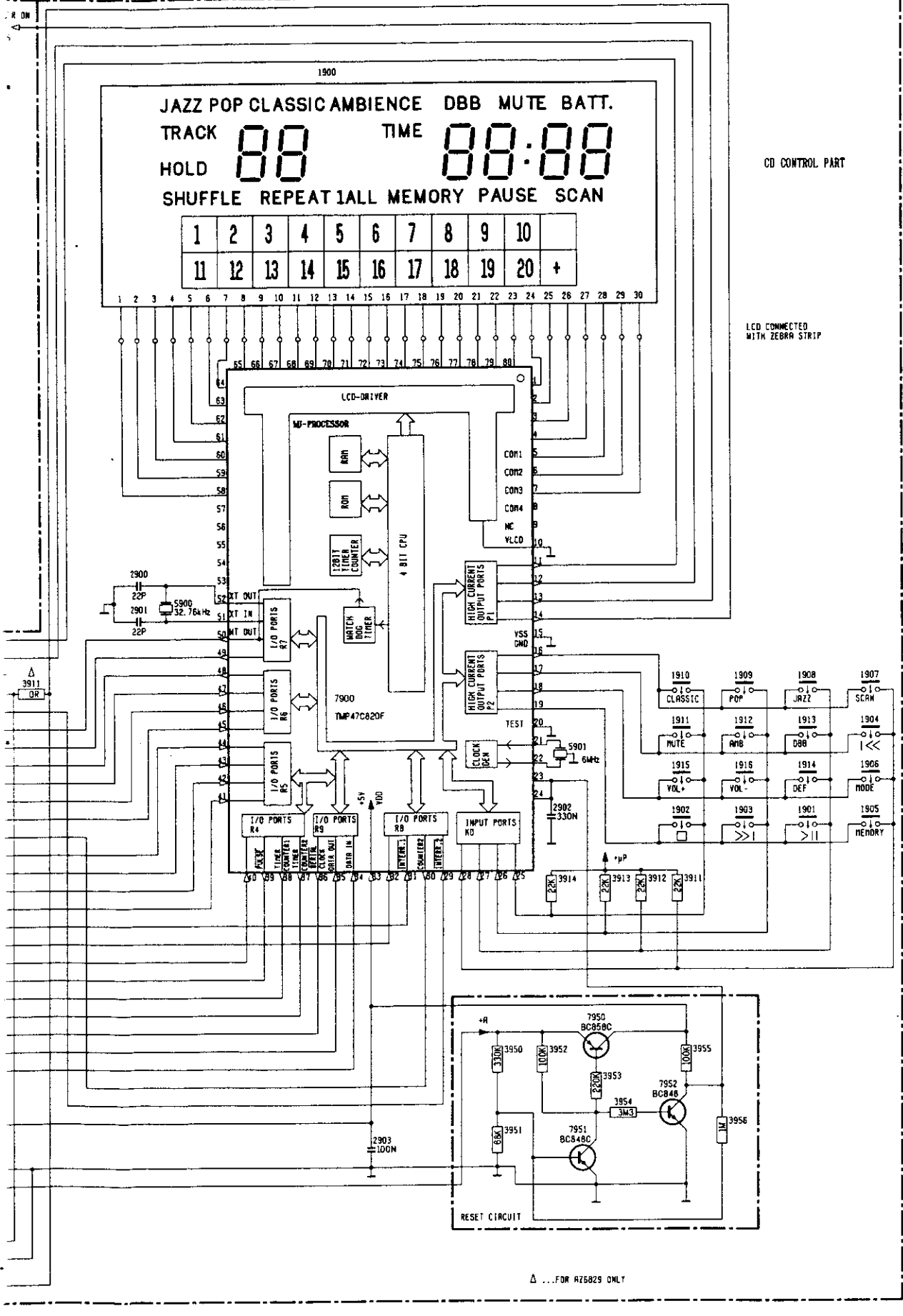


765019 P9	FRANCE VERSION 18	USA VERSION 17
5630	TOKO SC8G 7 MDC	TOKO SC8G 4 MDC
5631	TOKO SC8G 8/7.5 MDC	TOKO SC8G 6 MDC/7.5 MDC
5632	0.68uH	0.27uH
2669	10PF/M220	47PF/M220
2670	5P6/W750	6P6/W750
2684	8P2	NOT MOUNTED
2677	50PF/MP0	39PF/MP0
2695	15PF/MP0	18PF/MP0
2672	1P2	NOT MOUNTED
2674	6P0	NOT MOUNTED
SWITCH 1630		NOT MOUNTED

JAZZ POP CLASSIC AMBIENCE
 TRACK 00 TIME
 HOLD
 SHUFFLE REPEAT IALL MEMOR

1	2	3	4	5	6	7	8
11	12	13	14	15	16	17	18





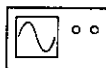


















1630	I15	3554	F 6
1900	B23	3555	C 6
1901	J26	3556	F 6
1902	J27	3557	C 6
1903	J27	3558	F 6
1904	J29	3559	C 6
1905	J29	3560	E 7
1906	J29	3561	B 7
1907	M29	3562	F 7
1908	M28	3563	C 7
1909	M27	3564	F 9
1910	M27	3565	C 9
1911	I27	3566	G 9
1912	I27	3567	D 9
1913	I28	3568	F 9
1914	I28	3569	C 9
1915	I27	3570	F10
1916	I27	3571	D10
2610	I 1	3573	F 9
2628	F 1	3574	G 8
2629	C 1	3575	E11
2630	F 2	3576	F11
2631	C 2	3577	C11
2632	F 2	3578	G11
2633	C 2	3579	D11
2634	G 2	3580	F12
2635	D 3	3581	D11
2636	F 3	3582	E13
2637	C 4	3583	C14
2638	F 4	3584	D15
2639	C 5	3585	J11
2640	D 5	3586	I13
2641	D 5	3587	I12
2642	G 6	3588	H12
2643	D 6	3589	G14
2644	F 7	3590	F13
2645	C 7	3591	E16
2646	G 7	3592	F16
2647	D 7	3593	I13
2648	F 8	3594	H12
2649	C 8	3595	K 3
2650	F 9	3596	K 4
2651	C 9	3597	K 4
2652	F 8	3598	K 4
2653	E11	3599	I 3
2654	L10	3901	B17
2655	D10	3902	B17
2656	D11	3903	B18
2657	D11	3904	B18
2661	G14	3905	C17
2662	I12	3906	D17
2664	I12	3907	D17
2665	D13	3908	D17
2666	F14	3909	E17
2687	G16	3910	E17
2688	I19	3911	K27
2689	I14	3911	H20
2690	I14	3912	K27
2691	J15	3913	K26
2692	J15	3914	K26
2693	I15	3950	L25
2694	J15	3951	M25
2695	K14	3952	L25
2696	L14	3953	M26
2697	M13	3954	M26
2698	M12	3955	L27
2699	L12	3956	M27
2680	L12	5630	J14
2681	L11	5631	H13
2682	F11	5632	M14
2683	C11	5633	L12
2684	J16	5640	K 3
2690	K 3	5641	K 3
2691	K 5	5900	G21
2692	J 4	5901	I26
2693	C13	6630	C15
2694	C14	6631	D12
2695	M15	6631	G12
2696	H 2	6901	C17
2697	H 3	6902	C18
2698	M 3	6903	D17
2900	R1	6904	D18
2901	M1	6905	D17
2902	J15	6906	D18
2903	M1	6907	D17
2904	B17	6908	D18
3608	C15	6909	E17
3609	C15	6910	E18
3610	H 3	6911	E16
3611	H 3	6912	E18
3612	H1	7510	G 3
3613	H1	7511	H 3
3622	L 2	7512	H 2
3623	M 2	7530	F 4
3624	M 2	7531	C 4
3625	M 3	7532	F 7
3626	M 3	7533	C 7
3627	C1	7534	G11
3628	M15	7535	D11
3629	M1	7536	C14
3630	F 1	7537	F15
3631	C 1	7540	C13
3632	F 2	7540	C10
3633	C 7	7540	D13
3634	M15	7540	F10
3635	J 1	7550	J10
3636	F 3	7550	J 3
3637	C 3	7551	J 2
3640	B 7	7552	I 4
3641	B 7	7553	N 2
3642	F 1	7554	N 4
3643	C 1	7555	L 3
3644	F 1	7900	I23
3645	C 1	7901	A17
3646	E 1	7902	B17
3647	B 1	7903	B18
3648	F 1	7950	L26
3649	C 1	7951	M26
3650	F 1	7952	M27
3651	C 1		
3652	F 1		
3653	C 1		

Δ ...FOR AZ5829 ONLY

ADJUSTMENT TABLE

TRANSMITTER-PART					
TRANSMITTED FREQUENCY CHANNEL 1 / CHANNEL 2					
CHANNEL 2 / SERVICE POSITION			L5630 - coarse C2673 - fine	Adj. channel 2 to 37,110MHz ± 500Hz (f-counter, see fig.1)	
CHANNEL 1 / SERVICE POSITION			C2674	Adj. channel 1 to 36,710MHz ± 500 Hz (f-counter, see fig.1)	
RADIATED POWER					
SERVICE POSITION		  (via 1nF)	L5631		Adjust channel 1 to max.
- Desolder telesc.ant.		  (via 1nF)	L5631		Adjust channel 2 to max.
ALC					
SERVICE POSITION	  1 kHz 550 mVrms	 	R3677	Adjust to 50 mVrms ± 2 mV *	
- Resolder telesc.ant. - Desolder R3612 - Solder 100k // 2661	  1 kHz 550 mVrms	 	R3676	Adjust to 50 mVrms ± 2 mV *	
PILOT TONE SUPPRESSION					
SERVICE POSITION		 	R3685	Adjust to min.	
- Resolder R3612 - Solder 100k // 2661					
- Desolder 100k					

↑ REPEAT

* USE A BAND PASS FILTER (suppression at 38 kHz > 35 dB)

ADJUSTMENT REMARKS TRANSMITTER

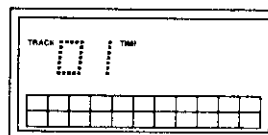
1. Service position

In service position according to fig.1 the set can not be turned on because the door switch is not closed. For adjustments it is necessary to bring the transmitter in an unmodulated condition (e.g. PAUSE in normal play). This can be reached either by actuating the door switch or entering the factory test program before dismantling the CD-lid. In the factory test program the door switch is ignored by software - the set will also work when the lid is opened. To enter the factory test mode "transmitter adjustments" hold JAZZ & POP & CLASSIC depressed while turning power on. Press the NEXT button twice, then press JAZZ. The display is as shown in fig. 2.




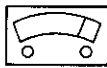











Attention: The laser beam is also kept emitting - Please take care of safety requirements !

The adjustment of the transmitter part is very critical. Due to the low radiated power (10µW) each metal aera in the immediate surroundings of the opened set will detune the transmitter. The oscillator will also be detuned when removing the CD-lid. Therefore all adjustments must be carried out with the transmitter-board in the defined position as shown in fig. 1. To compensate the detuning an "offset" of +10 kHz has been added to the adjustment frequencies.

fig.2

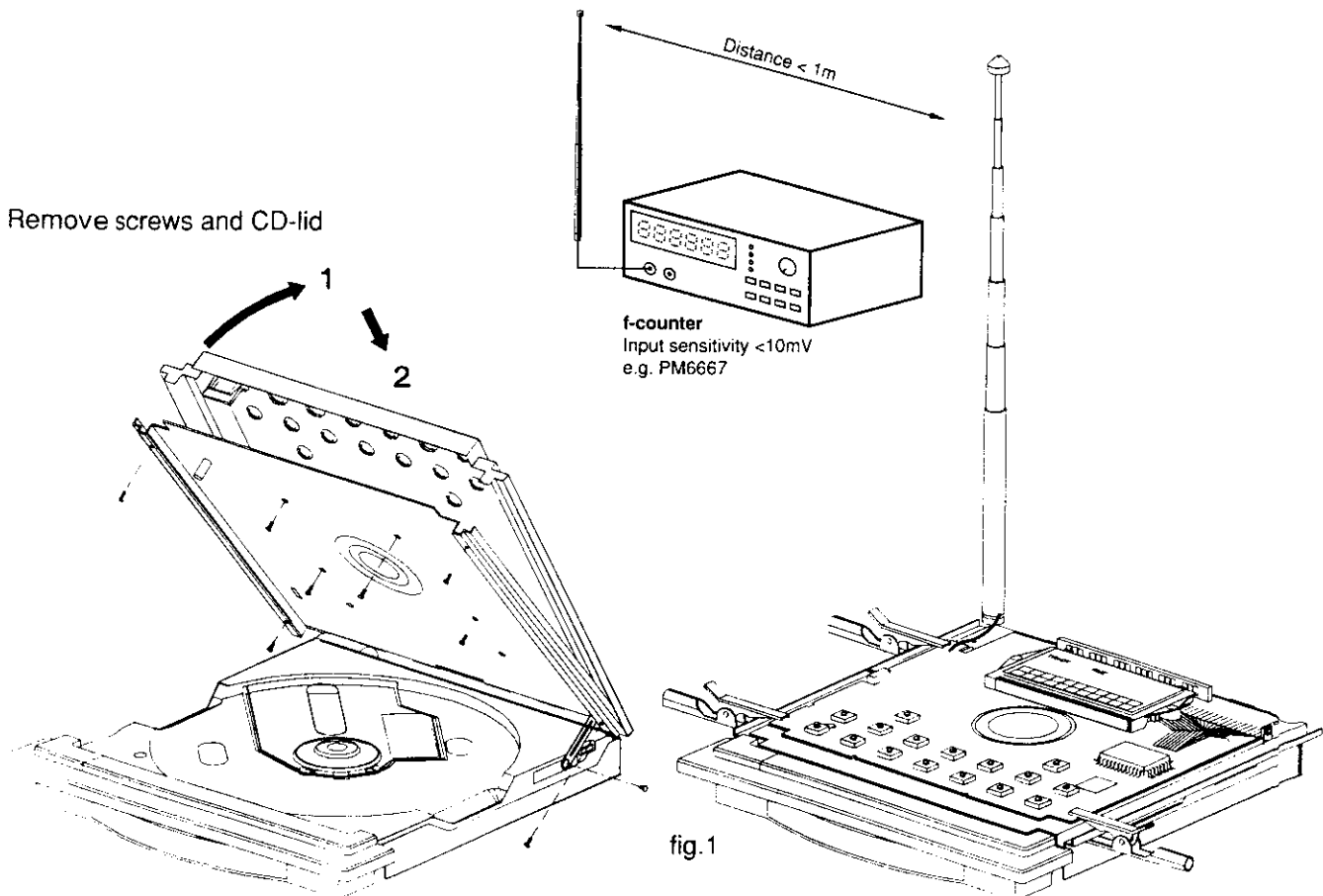


GENERAL CHECKPOINTS FOR TROUBLESHOOTING

TRANSMITTER-PART					
DC-SUPPLY VOLTAGES +2,9 V & +4,3 V					
SERVICE POSITION		 	Check only	+2,9 V DC ± 50 mV	
		 	Check only	+4,3 V DC ± 100 mV	
38 kHz PILOT TONE					
SERVICE POSITION		 	Check only	15 mV ± 1 mV	 f = 38 kHz
		 	Check only	500 mV ± 100 mV	 f = 38 kHz

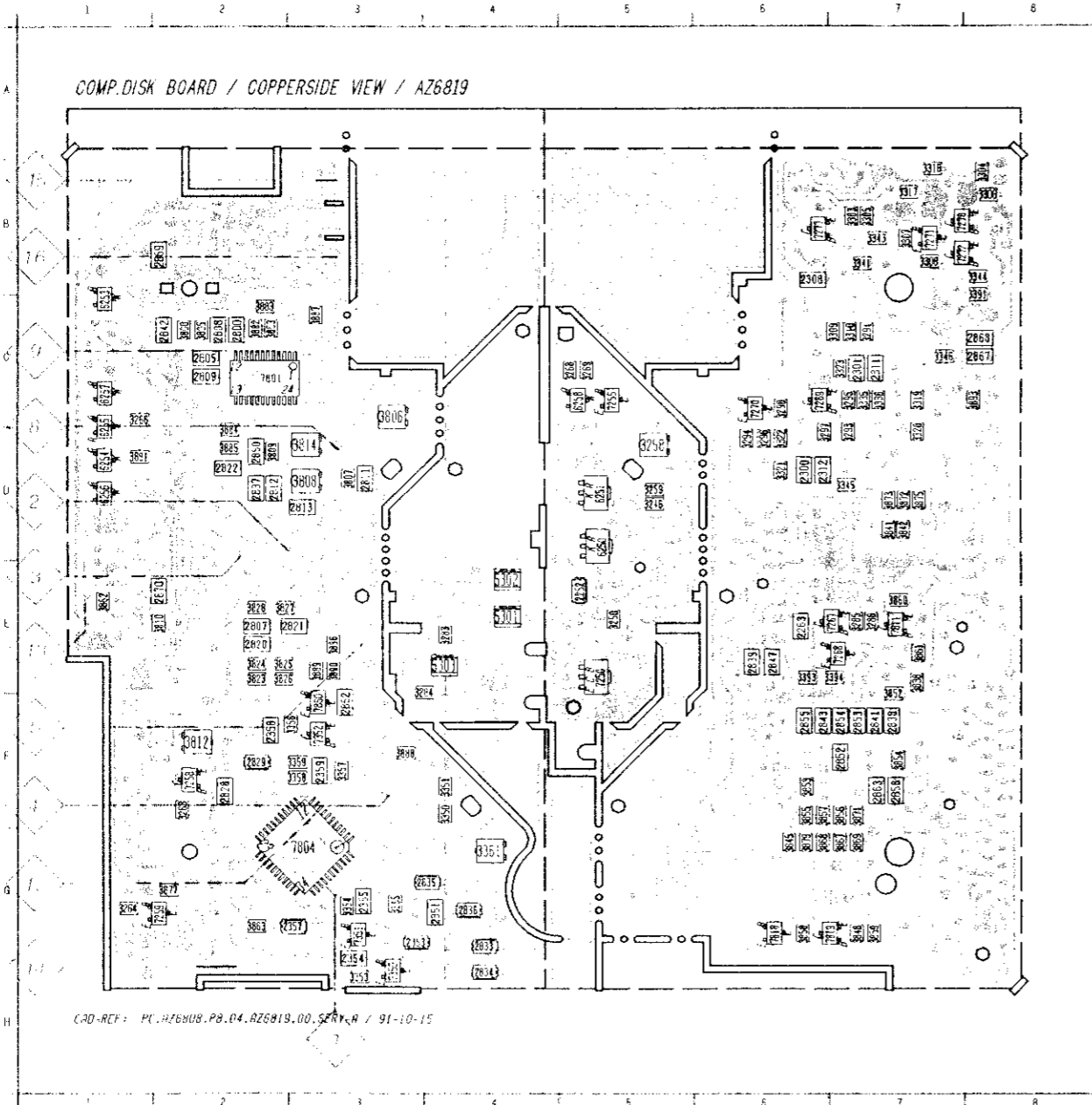
2. Troubleshooting

The transmitter will only work correct if the supply voltages are within the specified tolerances. Otherwise the radiated power, S/N ratio and distortion will deteriorate (supply voltage +4,3) or the PLL - circuit of the receiver (cordless headphone SBC3397) will work asymmetric to the radiated frequ. (supply voltage +2,9). Check also the mute circuits and the pilot tone.



2302	1	5	3867	1	1
2303	1	5	3868	1	1
2304	1	5	3869	1	1
2305	1	5	3870	1	1
2306	1	5	3871	1	1
2307	1	5	3872	1	1
2308	1	5	3873	1	1
2309	1	5	3874	1	1
2310	1	5	3875	1	1
2311	1	5	3876	1	1
2312	1	5	3877	1	1
2313	1	5	3878	1	1
2314	1	5	3879	1	1
2315	1	5	3880	1	1
2316	1	5	3881	1	1
2317	1	5	3882	1	1
2318	1	5	3883	1	1
2319	1	5	3884	1	1
2320	1	5	3885	1	1
2321	1	5	3886	1	1
2322	1	5	3887	1	1
2323	1	5	3888	1	1
2324	1	5	3889	1	1
2325	1	5	3890	1	1
2326	1	5	3891	1	1
2327	1	5	3892	1	1
2328	1	5	3893	1	1
2329	1	5	3894	1	1
2330	1	5	3895	1	1
2331	1	5	3896	1	1
2332	1	5	3897	1	1
2333	1	5	3898	1	1
2334	1	5	3899	1	1
2335	1	5	3900	1	1
2336	1	5	3901	1	1
2337	1	5	3902	1	1
2338	1	5	3903	1	1
2339	1	5	3904	1	1
2340	1	5	3905	1	1
2341	1	5	3906	1	1
2342	1	5	3907	1	1
2343	1	5	3908	1	1
2344	1	5	3909	1	1
2345	1	5	3910	1	1
2346	1	5	3911	1	1
2347	1	5	3912	1	1
2348	1	5	3913	1	1
2349	1	5	3914	1	1
2350	1	5	3915	1	1
2351	1	5	3916	1	1
2352	1	5	3917	1	1
2353	1	5	3918	1	1
2354	1	5	3919	1	1
2355	1	5	3920	1	1
2356	1	5	3921	1	1
2357	1	5	3922	1	1
2358	1	5	3923	1	1
2359	1	5	3924	1	1
2360	1	5	3925	1	1
2361	1	5	3926	1	1
2362	1	5	3927	1	1
2363	1	5	3928	1	1
2364	1	5	3929	1	1
2365	1	5	3930	1	1
2366	1	5	3931	1	1
2367	1	5	3932	1	1
2368	1	5	3933	1	1
2369	1	5	3934	1	1
2370	1	5	3935	1	1
2371	1	5	3936	1	1
2372	1	5	3937	1	1
2373	1	5	3938	1	1
2374	1	5	3939	1	1
2375	1	5	3940	1	1
2376	1	5	3941	1	1
2377	1	5	3942	1	1
2378	1	5	3943	1	1
2379	1	5	3944	1	1
2380	1	5	3945	1	1
2381	1	5	3946	1	1
2382	1	5	3947	1	1
2383	1	5	3948	1	1
2384	1	5	3949	1	1
2385	1	5	3950	1	1
2386	1	5	3951	1	1
2387	1	5	3952	1	1
2388	1	5	3953	1	1
2389	1	5	3954	1	1
2390	1	5	3955	1	1
2391	1	5	3956	1	1
2392	1	5	3957	1	1
2393	1	5	3958	1	1
2394	1	5	3959	1	1
2395	1	5	3960	1	1
2396	1	5	3961	1	1

COMP.DISK BOARD / COPPERSIDE VIEW / AZ6819



CAD-REF: PC.AZ6819.P9.04.AZ6819.00.SERV-B / 91-10-15

2397	1	5	3962	1	1
2398	1	5	3963	1	1
2399	1	5	3964	1	1
2400	1	5	3965	1	1
2401	1	5	3966	1	1
2402	1	5	3967	1	1
2403	1	5	3968	1	1
2404	1	5	3969	1	1
2405	1	5	3970	1	1
2406	1	5	3971	1	1
2407	1	5	3972	1	1
2408	1	5	3973	1	1
2409	1	5	3974	1	1
2410	1	5	3975	1	1
2411	1	5	3976	1	1
2412	1	5	3977	1	1
2413	1	5	3978	1	1
2414	1	5	3979	1	1
2415	1	5	3980	1	1
2416	1	5	3981	1	1
2417	1	5	3982	1	1
2418	1	5	3983	1	1
2419	1	5	3984	1	1
2420	1	5	3985	1	1
2421	1	5	3986	1	1
2422	1	5	3987	1	1
2423	1	5	3988	1	1
2424	1	5	3989	1	1
2425	1	5	3990	1	1
2426	1	5	3991	1	1
2427	1	5	3992	1	1
2428	1	5	3993	1	1
2429	1	5	3994	1	1
2430	1	5	3995	1	1
2431	1	5	3996	1	1
2432	1	5	3997	1	1
2433	1	5	3998	1	1
2434	1	5	3999	1	1
2435	1	5	4000	1	1
2436	1	5	4001	1	1
2437	1	5	4002	1	1
2438	1	5	4003	1	1
2439	1	5	4004	1	1
2440	1	5	4005	1	1
2441	1	5	4006	1	1
2442	1	5	4007	1	1
2443	1	5	4008	1	1
2444	1	5	4009	1	1
2445	1	5	4010	1	1
2446	1	5	4011	1	1
2447	1	5	4012	1	1
2448	1	5	4013	1	1
2449	1	5	4014	1	1
2450	1	5	4015	1	1
2451	1	5	4016	1	1
2452	1	5	4017	1	1
2453	1	5	4018	1	1
2454	1	5	4019	1	1
2455	1	5	4020	1	1
2456	1	5	4021	1	1
2457	1	5	4022	1	1
2458	1	5	4023	1	1
2459	1	5	4024	1	1
2460	1	5	4025	1	1
2461	1	5	4026	1	1
2462	1	5	4027	1	1
2463	1	5	4028	1	1
2464	1	5	4029	1	1
2465	1	5	4030	1	1
2466	1	5	4031	1	1
2467	1	5	4032	1	1
2468	1	5	4033	1	1
2469	1	5	4034	1	1
2470	1	5	4035	1	1
2471	1	5	4036	1	1
2472	1	5	4037	1	1
2473	1	5	4038	1	1
2474	1	5	4039	1	1
2475	1	5	4040	1	1
2476	1	5	4041	1	1
2477	1	5	4042	1	1
2478	1	5	4043	1	1
2479	1	5	4044	1	1
2480	1	5	4045	1	1
2481	1	5	4046	1	1
2482	1	5	4047	1	1
2483	1	5	4048	1	1
2484	1	5	4049	1	1
2485	1	5	4050	1	1
2486	1	5	4051	1	1
2487	1	5	4052	1	1
2488	1	5	4053	1	1
2489	1	5	4054	1	1
2490	1	5	4055	1	1
2491	1	5	4056	1	1
2492	1	5	4057	1	1
2493	1	5	4058	1	1
2494	1	5	4059	1	1
2495	1	5	4060	1	1
2496	1	5	4061	1	1
2497	1	5	4062	1	1
2498	1	5	4063	1	1
2499	1	5	4064	1	1
2500	1	5	4065	1	1
2501	1	5	4066	1	1
2502	1	5	4067	1	1
2503	1	5	4068	1	1
2504	1	5	4069	1	1
2505	1	5	4070	1	1
2506	1	5	4071	1	1
2507	1	5	4072	1	1
2508	1	5	4073	1	1
2509	1	5	4074	1	1
2510	1	5	4075	1	1
2511	1	5	4076	1	1
2512	1	5	4077	1	1
2513	1	5	4078	1	1
2514	1	5	4079	1	1
2515	1	5	4080	1	1
2516	1	5	4081	1	1
2517	1	5	4082	1	1
2518	1	5	4083	1	1
2519	1	5	4084	1	1
2520	1	5	4085	1	1
2521	1	5	4086	1	1
2522	1	5	4087	1	1
2523	1	5	4088	1	1
2524	1	5	4089	1	1
2525	1	5	4090	1	1
2526	1	5	4091	1	1
2527	1	5	4092	1	1
2528	1	5	4093	1	1
2529	1	5	4094	1	1
2530	1	5	4095	1	1
2531	1	5	4096	1	1
2532	1	5	4097	1	1
2533	1	5	4098	1	1
2534	1	5	4099	1	1
2535	1	5	4100	1	1
2536	1	5	4101	1	1
2537	1	5	4102	1	1
2538	1	5	4103	1	1
2539	1	5	4104	1	1
2540	1	5	4105	1	1
2541	1	5	4106	1	1
2542	1	5	4107	1	1
2543	1	5	4108	1	1
2544	1	5	4109	1	1
2545	1	5	4110	1	1
2546	1	5	4111	1	1
2547	1	5	4112	1	1
2548	1	5	4113	1	1
2549	1	5	4114	1	1
2550	1	5	4115	1	1
2551	1	5	4116	1	1
2552	1	5	4117	1	1
2553	1	5	4118	1	1
2554	1	5	4119	1	1
2555	1	5	4120	1	1
2556	1	5	4121	1	1
2557	1	5	4122	1	1

ADJUSTMENT TABLE




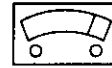
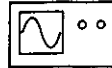










CD-PART					
TRACKING OFFSET					
Service step 1		 	3812	Adjust to 0 V DC ±15mV	
TRACKING BALANCE					
Service step 3		 	3806		CHX = 0,5 V/DIV TB = 2 ms Adjust to 0 V DC
FOCUS GAIN					
Play with Test-Disc 5	1500 Hz 2 Vrms	see Fig. 1	3814		CHX = 1 V/DIV CHY = 2 mV/DIV Adjust according to FIG.3
TRACKING GAIN					
Play with Test-Disc 5	1200 Hz 1 Vrms	see Fig. 2	3808		CHX = 0,5 V/DIV CHY = 50 mV/DIV Adjust according to FIG.3
DC / DC CONVERTER					
+5V SUPPLY VOLTAGE					
Service step 1		 	3361	Adjust to 4,95 V DC ± 10 mV	
CHARGE-CIRCUIT					
CHARGE VOLTAGE					
Service step 1		 	3258	RL = 220 Ω Adjust to 4,6 V DC ± 50 mV	
		 	Check only	RL = 33 Ω Ucharge = 5V DC ± 100 mV	

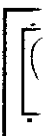
FIG

AD
 Tes
 It is
 on
 una
 dro
 In t
 wor
Me
 In t
 of t
 cas
 the
 Thi
 the
 of a
 imp
 In s
 in p
 DC
Sim
 Dur
 con
 car
 In a
 The
 "0"
 sho
Me
 Inp
 dire
 onl
Me
 Dur
 me
 cor
Sel
 It is
 pos
Cor
 Injk
 tak
 lev
 the

FIG. 1

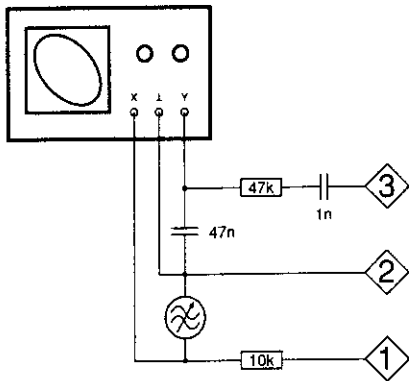


FIG. 2

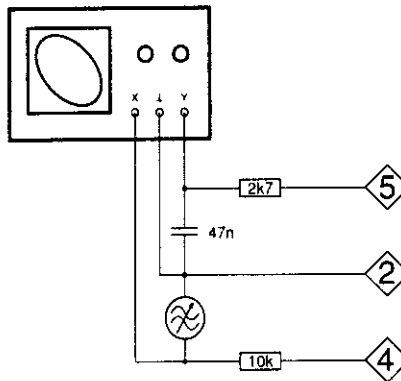
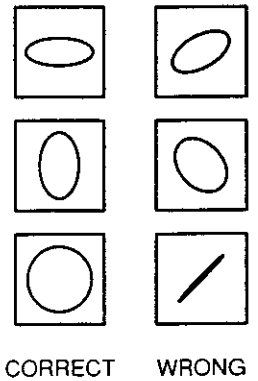


FIG. 3



ADJUSTMENT REMARKS - GENERAL

Test Discs

It is important to treat the test discs with great care. The disorders on the discs (black spots, fingerprints, etc.) are exclusive and unambiguously positioned. Damage may cause additional drop-outs, etc. rendering the intentional errors no longer exclusive. In that case it will no longer be possible to check e.g. the good working of the track detectors.

Measurements on op-amps

In the electronic circuit op-amps have been used frequently. Some of the applications are amplifiers, filters, inverters or buffers. In those cases where in one way or the other, feedback has been applied, the voltage difference at the differential inputs converges to zero. This applies to both DC and AC signals. The cause can be traced to the properties of an ideal op-amp ($Z_i = \infty$, $G = \infty$, $Z_o = 0$). If one input of an op-amp is directly connected to ground it will be virtually impossible to measure at the inverting and the non-inverting inputs. In such cases only the output signal will be measurable. That is why in most cases the AC voltages at the inputs will not be given. The DC voltages at the inputs are equal.

Simulation of "0" and "1"

During troubleshooting sometimes certain points should be connected to ground or supply voltage. As a result certain circuits can be brought in a desired state thus shortening the diagnosis time in a number of cases the related points are outputs of op-amps. These outputs are short-circuit-resistant, i.e. they can be brought to "0" or ground without problems. The output of an op-amp, however, should never be connected directly to the power supply voltage.

Measurements on microprocessors

Inputs and outputs of microprocessors should never be connected directly to the power supply voltage. The inputs and outputs should only be brought "0" or ground if this is stated explicitly.

Measurements with an oscilloscope

During measurements with an oscilloscope it is recommended to measure with a 1:10 test probe, since a 1:10 probe has a considerably smaller input capacitance than a 1:1 probe.

Selection of ground potential

It is very important to select a ground point that is as close as possible to the test point.

Conditions for injection

Injection of levels or signals from an external source should never take place if the related circuit has no supply voltage. The injected levels or signals should never be higher than the supply voltage of the related circuit.

ADJUSTMENT REMARKS - CD-PART

A completely new adjustment of the cd-part is absolutely necessary if the optical pick-up unit (OPU) or semiconductors of the servo control circuits have been replaced.

- Focus gain / Tracking gain

To adjust the focus- and track-control circuit use the measure circuit according to fig. 1 resp. fig.2. Set the oscilloscope to X-deflection. The screen will show an ellipse. Adjust the lissajou's figure to vertical and horizontal symmetry (see fig. 3).

- Track balance

Necessary to balance the different sensibilities of the track-diodes.

- +5V adjustment

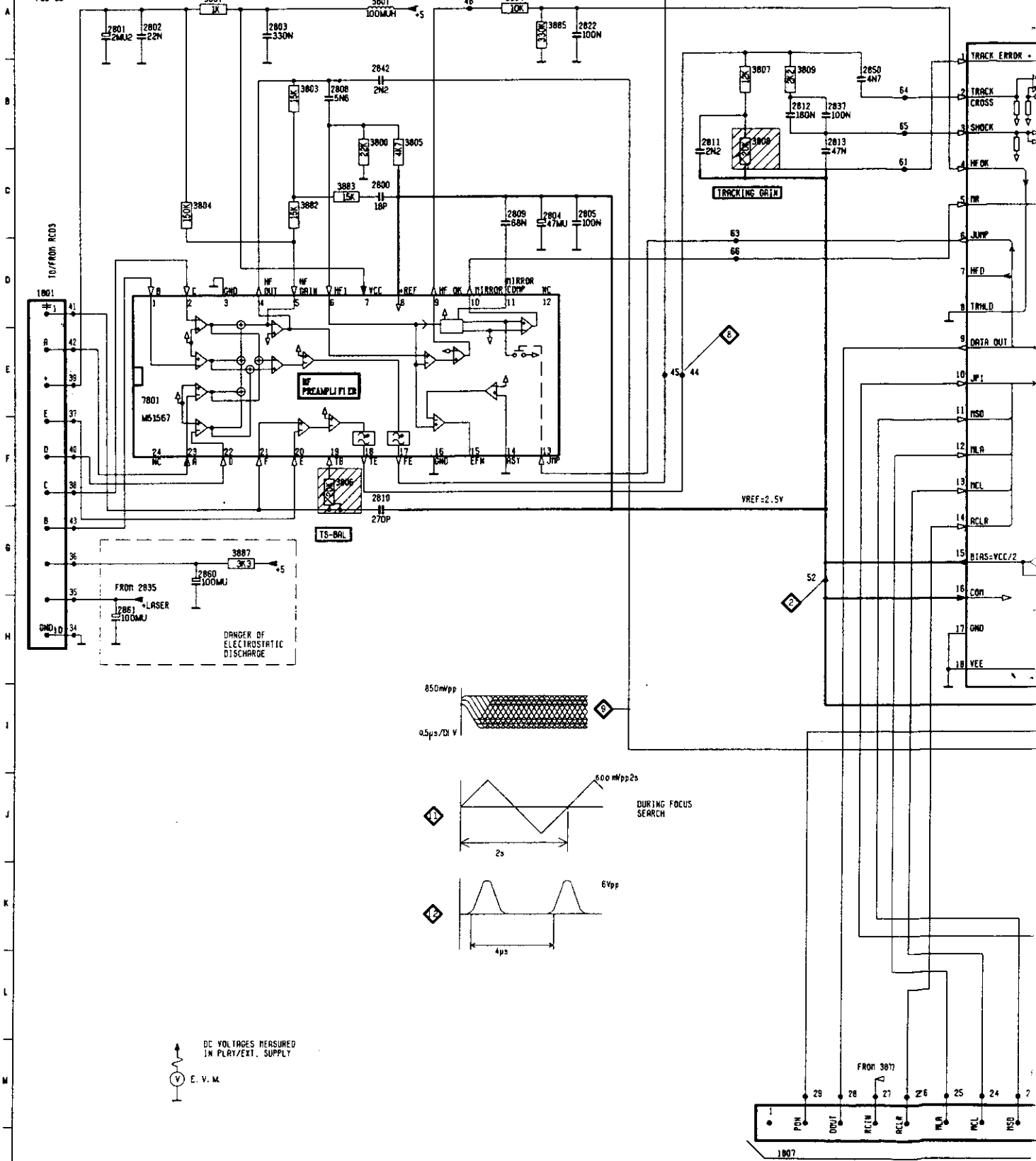
The transmitter will only work correct if the supply voltages are within the specified values.

- Adjustment of charge-circuit

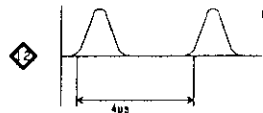
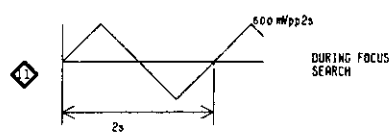
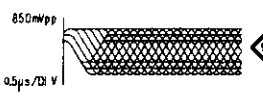
Replace the accu by a 220 Ω resistor. Adjust U_{charge} to 4,6 V \pm 50 mV via R 3258. Exchange the 220 Ω resistor by a 33 Ω and measure U_{charge} . The voltage **must not** exceed 5 V \pm 100 mV. Otherwise the charge circuit doesn't work correct and has to be checked. CAUTION: If the measured voltage was not within the specification you **must not** reduce the voltage via R 3258 ! - If done the accu could overload and explode !

SERVO CONTROL PART

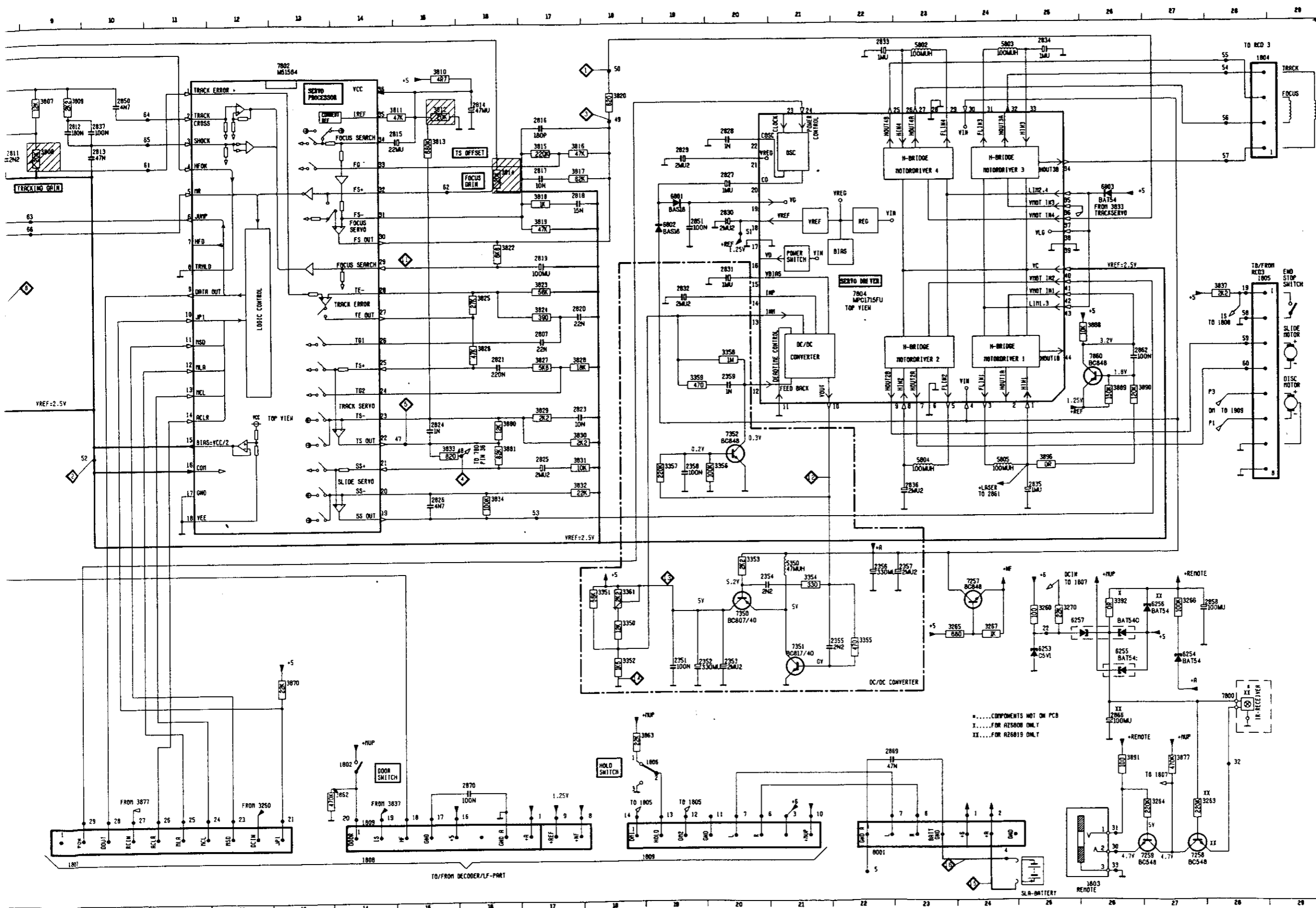
PCB 86



FROM 2835
LASER
DANGER OF ELECTROSTATIC DISCHARGE

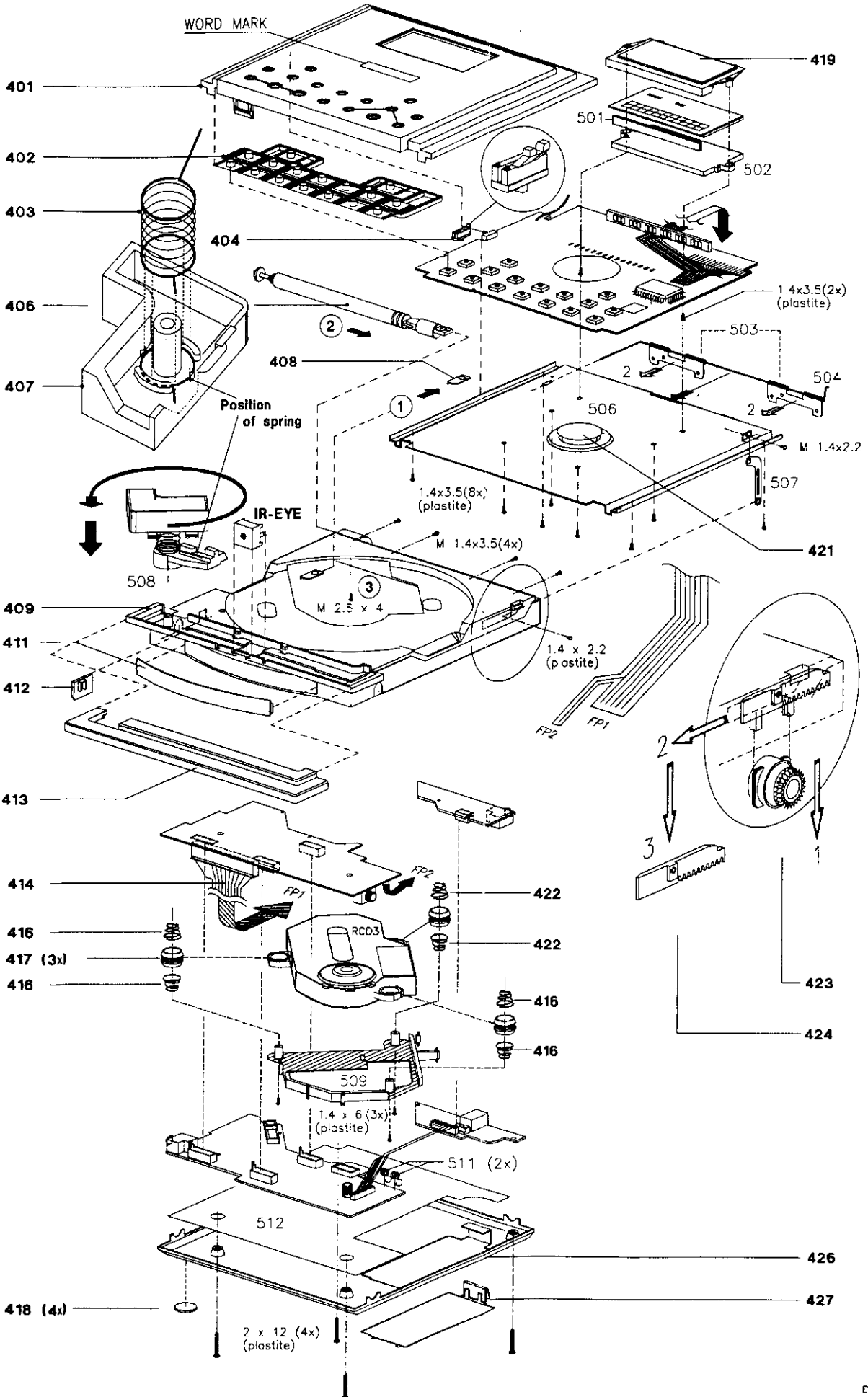


DC VOLTAGES MEASURED
IN PLAY/EXT. SUPPLY
E. V. M.



1801	D 1	3831	D17
1802	L14	3832	H17
1803	N25	3833	G15
1804	R28	3834	H16
1805	E28	3837	E28
1806	L19	3862	L13
1807	M 9	3863	L18
1808	M14	3870	K13
1809	M19	3877	L27
1809	M14	3880	D16
2351	K19	3881	D16
2352	K19	3882	C 4
2353	K20	3883	C 4
2354	I20	3884	A 6
2355	J21	3885	A 6
2356	I22	3887	D 3
2357	I22	3888	E26
2358	H19	3889	F26
2359	F20	3890	F26
2800	C 5	3891	L26
2801	A 1	3896	G25
2802	A 2	5350	I21
2803	A 3	5801	A 5
2804	C 6	5802	A23
2805	C 7	5803	A24
2807	E17	5804	G23
2808	B 4	5805	G24
2809	C 6	6253	J25
2810	F 5	6254	K27
2811	B 8	6255	K26
2812	B 9	6256	J25
2813	B10	6257	J25
2814	B16	6801	C19
2815	B15	6802	D19
2816	B17	6803	C26
2817	C17	7257	I24
2818	C17	7258	H27
2819	D17	7259	H27
2820	E17	7350	J20
2821	F16	7351	J21
2822	A 7	7352	G20
2823	G17	7800	K28
2824	B15	7801	E 2
2825	G17	7802	R13
2826	H15	7804	E22
2827	C20	7800	F26
2828	B20	8001	H22
2829	C19		
2830	D20		
2832	E19		
2833	R22		
2834	A25		
2835	H25		
2836	H23		
2837	B10		
2842	B 5		
2850	B10		
2851	D19		
2858	J27		
2860	G 2		
2861	H 2		
2862	F26		
2866	L26		
2869	L22		
2870	H16		
3260	J25		
3263	H27		
3264	H27		
3265	J23		
3266	J27		
3267	J24		
3270	J25		
3350	J18		
3351	J18		
3352	K18		
3353	L20		
J 3354	L21		
3355	J22		
3356	H20		
3357	H19		
3358	F20		
3359	F19		
3361	J18		
3392	J26		
3800	B 4		
3801	A 3		
3803	B 4		
3804	C 2		
3805	B 5		
3806	F 4		
3807	B 9		
3808	B 9		
3809	B 9		
3810	A15		
3811	B15		
3812	B15		
3813	B15		
3814	C16		
3815	B17		
3816	B17		
3817	B17		
3818	C17		
3819	D17		
3820	B18		
3822	O16		
3823	E17		
3824	E17		
3825	E16		
3826	F16		
3827	F17		
3828	F17		
3829	G17		
3830	G17		

EXPLODED VIEW



MECHANICAL PARTS

401	4822 444 60778	CD-LID LAQUERED, PRINTED
402	4822 410 61708	BUTTON SET
403	4822 492 70905	SPRING
404	4822 450 81195	FREQUENCY SLIDER
406	4822 303 30406	TELESCOPI ANTENNA
407	4822 410 61591	EJECT BUTTON LAQUERED
408	4822 290 81445	PLATE, CONTACT
409	4822 444 40489	CABINET LAQUERED
411	4822 450 61793	WINDOW PRINTED
412	4822 411 61803	KNOB, SLIDE
413	4822 444 40491	FRONT LAQUERED
414	4822 214 51944	PCB 0 (FLEXPRINT)
416	4822 492 52254	SPRING, COMPRESS
417	4822 529 10271	DAMPER
418	4822 462 41819	RUBBER FOOT
419	4822 464 50876	WINDOW (LCD)
421	4822 691 30266	MAGNET ASSY
422	4822 492 52253	SPRING, COMPRESS
423	4822 529 10272	DAMPER
424	4822 522 33078	ROD
426	4822 444 50676	BOTTOM ASSY
427	4822 444 60747	BATTERY LID ASSY
508	4822 402 50286	RELEASE LEVER
509	4822 464 50845	FRAME
511	4822 492 70906	SPRING, CONTACT
	4822 502 13866	SCREW M1,4x2,2
	4822 502 13769	SCREW (M1,4X4)
	4822 502 13865	SCREW M2,6x4
	4822 502 13768	SCREW 1,4x2,2
	4822 502 30679	SCREW 1,4x3,5 (PLASTITE)
	4822 502 13839	SCREW 1,4X6
	4822 502 30675	SCREW TORX 2X12 (PLASTITE)

ELECTRICAL PARTSLIST

MISCELLANEOUS		
	4822 218 10431	RD6833/00
	4822 138 10397	SBC6408
	4822 219 82443	SBC6619/00
	4822 272 10308	SBC6619/01
	4822 272 10307	SBC6619/05
	4822 272 10311	SBC6619/17PH
	4822 015 20444	SBC3397/00/00B/00G/01
	4822 242 50069	SBC3397/17PH
	4822 242 50071	SBC3397/18
	4822 462 10496	SBC3398
1250	4822 267 31354	SOCKET, EXT. SUPPLY
1252	4822 267 31147	SOCKET, CD-OUT
1253	4822 267 40788	SOCKET, HEADPHONES
1802	4822 277 11333	SWITCH, TUMBLER
1803	4822 267 31148	SOCKET, REMOTE CONTROL
1806	4822 276 12891	SWITCH, PUSHBUTTON
1814	5322 265 30736	SOCKET 4 POL.
1830	4822 277 21563	SWITCH, SLIDE
1900	4822 130 91039	LCD FSD-10374
1901	4822 276 13175	SWITCH
1902	4822 276 13175	SWITCH
1903	4822 276 13175	SWITCH
1904	4822 276 13175	SWITCH
1905	4822 276 13175	SWITCH
1906	4822 276 13175	SWITCH
1907	4822 276 13175	SWITCH
1908	4822 276 13175	SWITCH
1909	4822 276 13175	SWITCH
1910	4822 276 13175	SWITCH
1911	4822 276 13175	SWITCH
1912	4822 276 13175	SWITCH
1913	4822 276 13175	SWITCH
1914	4822 276 13175	SWITCH
1915	4822 276 13175	SWITCH
1916	4822 276 13175	SWITCH
7800	4822 130 82197	IR-DETECT. PAS-C0615
DIODES		
1815	4822 130 80622	BAT54
6250	4822 130 82588	SB10-05PCP
6251	4822 130 82588	SB10-05PCP
6252	4822 130 81375	BZX84-C3V9
6253	5322 130 32835	BZX84-C5V1
6254	4822 130 80622	BAT54
6255	4822 130 82594	BAT54C
6256	4822 130 80622	BAT54
6257	4822 130 82594	BAT54C
6258	5322 130 80406	BZX84-C6V8
6801	5322 130 31928	BAS16
6802	5322 130 31928	BAS16
6803	4822 130 80622	BAT54
6805	5322 130 31928	BAS16
6806	5322 130 31928	BAS16
6607	5322 130 31920	BAV99
6630	5322 130 34337	BAV99
6631	5322 130 34331	BAV70
6901	4822 130 82824	LED CL-70Y-CD-T
6902	4822 130 82824	LED CL-70Y-CD-T
6903	4822 130 82824	LED CL-70Y-CD-T
6905	4822 130 82824	LED CL-70Y-CD-T

DIODES

6906	4822 130 82824	LED CL-70Y-CD-T
6907	4822 130 82824	LED CL-70Y-CD-T
6908	4822 130 82824	LED CL-70Y-CD-T
6909	4822 130 82824	LED CL-70Y-CD-T
6910	4822 130 82824	LED CL-70Y-CD-T
6911	4822 130 82824	LED CL-70Y-CD-T
6912	4822 130 82824	LED CL-70Y-CD-T
TRANSISTORS		
7250	4822 130 61919	BCX69-25
7253	4822 130 61207	BC848 (CHIP)
7254	4822 130 61207	BC848 (CHIP)
7255	4822 130 61207	BC848 (CHIP)
7257	4822 130 61207	BC848 (CHIP)
7258	4822 130 61207	BC848 (CHIP)
7259	4822 130 61207	BC848 (CHIP)
7261	4822 130 61207	BC848 (CHIP)
7267	4822 130 42133	BC817(CHIP)
7268	4822 130 42133	BC817(CHIP)
7269	4822 130 61207	BC848 (CHIP)
7270	4822 130 61207	BC848 (CHIP)
7271	4822 130 42133	BC817(CHIP)
7272	4822 130 42133	BC817(CHIP)
7276	4822 130 61207	BC848 (CHIP)
7277	4822 130 42133	BC817(CHIP)
7278	4822 130 42133	BC817(CHIP)
7350	5322 130 60123	BC807-40 (CHIP)
7351	4822 130 42615	BC817-40(CHIP)
7352	4822 130 61207	BC848 (CHIP)
7811	4822 130 42513	BC858C
7814	5322 130 60123	BC807-40 (CHIP)
7815	5322 130 60123	BC807-40 (CHIP)
7816	4822 130 42615	BC817-40(CHIP)
7817	4822 130 42615	BC817-40(CHIP)
7818	5322 130 60123	BC807-40 (CHIP)
7819	4822 130 61207	BC848 (CHIP)
7860	4822 130 61207	BC848 (CHIP)
7610	4822 130 42133	BC817(CHIP)
7611	4822 130 42133	BC817(CHIP)
7612	5322 130 41983	BC858B(CHIP)
7630	4822 130 62539	BC850C
7631	4822 130 62539	BC850C
7632	4822 130 62539	BC850C
7633	4822 130 62539	BC850C
7634	4822 130 62539	BC850C
7635	4822 130 62539	BC850C
7636	4822 130 42513	BC858C
7637	4822 130 62539	BC850C
7661	4822 130 42513	BC858C
7662	4822 130 62539	BC850C
7663	4822 130 42513	BC858C
7664	4822 130 62539	BC850C
7665	4822 130 62897	BST82
7901	5322 130 60123	BC807-40 (CHIP)
7902	4822 130 61207	BC848 (CHIP)
7903	5322 130 42136	BC848C(CHIP)
7950	4822 130 42513	BC858C
7951	5322 130 42136	BC848C(CHIP)
7952	4822 130 61207	BC848 (CHIP)

INTEGRATED CIRCUITS

7251	4822 209 73157	NJM3415M
7262	4822 209 73157	NJM3415M

INTEGRATED CIRCUITS

7263	4822 209 63924	LC7534M
7264	4822 209 73157	NJM3415M
7273	5322 209 61482	PC74HC4066T
7274	5322 209 61482	PC74HC4066T
7275	4822 209 73157	NJM3415M
7801	4822 209 72814	M51567P
7802	4822 209 72815	M51564P
7803	4822 209 30388	SAA7341GP
7804	4822 209 62261	MPC1715FU
7805	4822 209 63925	FCB61C65L-70T
7640	4822 209 73849	HEF4007UBT
7650	4822 209 30601	BA1404F
7660	4822 209 30602	LM317LM
7900	4822 209 30598	TMP47C820F
COILS		
5301	4822 157 62216	COIL 100µH
5302	4822 157 62216	COIL 100µH
5303	4822 157 62216	COIL 100µH
5350	4822 157 63495	COIL 47µH
5801	4822 157 62216	COIL 100µH
5802	4822 157 63605	100µH 10%
5803	4822 157 63605	100µH 10%
5804	4822 157 63605	100µH 10%
5805	4822 157 63605	100µH 10%
5806	4822 242 80257	RESONATOR 16.95MHz
5630	4822 156 70067	OSC.COIL 40MHz
5630	12 NC for /17 follows	
5631	4822 156 70068	OSC.COIL 40MHz
5631	12 NC for /17 follows	
5632	4822 157 63606	0.68µH
5632	12 NC for /17 follows	
5633	4822 242 81014	QUARTZ 38kHz
5640	4822 157 63602	6.8µH
5641	4822 157 63602	6.8µH
5900	4822 242 81016	X-TAL 32.768kHz
5901	4822 242 73654	CER.RESONATOR 6MHz
CHIP RESISTORS		
3246	4822 051 20221	220R 5% 0.1W
3247	4822 051 20822	8k2 5% 0.1W
3248	4822 051 20689	68R 5% 0.1W
3249	4822 051 20339	33R 5% 0.1W
3250	4822 116 83324	0R27 10% 0.1W
3251	4822 051 20105	1M 5% 0.1W
3252	4822 051 10102	1k 2% 0.25W
3253	4822 051 20183	18k 5% 0.1W
3254	4822 051 20391	390R 5% 0.1W
3255	4822 051 20221	220R 5% 0.1W
3256	4822 051 20109	10R 5% 0.1W
3257	4822 051 20821	820R 5% 0.1W
3258	4822 100 11734	470R 25% TRIMPOT
3259	4822 051 20471	470R 5% 0.1W
3260	4822 051 20101	100R 5% 0.1W
3261	4822 051 10102	1k 2% 0.25W
3262	4822 051 20105	1M 5% 0.1W
3263	4822 051 20224	220k 5% 0.1W
3264	4822 051 20224	220k 5% 0.1W
3265	4822 051 20681	680R 5% 0.1W
3266	4822 051 20104	100k 5% 0.1W
3267	4822 051 10102	1k 2% 0.25W
3268	4822 051 20471	470R 5% 0.1W
3269	4822 051 20471	470R 5% 0.1W
3270	4822 051 20223	22k 5% 0.1W

CHIP RESISTORS

3278	4822 051 20104	100k	5%	0,1W
3279	4822 051 20473	47k	5%	0,1W
3280	4822 051 20104	100k	5%	0,1W
3281	4822 051 10102	1k	2%	0,25W
3282	4822 051 10102	1k	2%	0,25W
3283	4822 051 20104	100k	5%	0,1W
3284	4822 051 20104	100k	5%	0,1W
3285	4822 051 10102	1k	2%	0,25W
3286	4822 051 10102	1k	2%	0,25W
3287	4822 051 20333	33k	5%	0,1W
3288	4822 051 20333	33k	5%	0,1W
3289	4822 051 20104	100k	5%	0,1W
3290	4822 051 20104	100k	5%	0,1W
3291	4822 051 20273	27k	5%	0,1W
3292	4822 051 20273	27k	5%	0,1W
3293	4822 051 10102	1k	2%	0,25W
3294	4822 051 10102	1k	2%	0,25W
3295	4822 051 20272	2k7	5%	0,1W
3296	4822 051 20272	2k7	5%	0,1W
3297	4822 051 20334	330k	5%	0,1W
3298	4822 051 20334	330k	5%	0,1W
3299	4822 051 20183	18k	5%	0,1W
3300	4822 051 20183	18k	5%	0,1W
3301	4822 051 20562	5k6	5%	0,1W
3302	4822 051 20562	5k6	5%	0,1W
3303	4822 051 20478	4R7	5%	0,1W
3304	4822 051 20478	4R7	5%	0,1W
3305	4822 051 20478	4R7	5%	0,1W
3306	4822 051 20478	4R7	5%	0,1W
3307	4822 051 10102	1k	2%	0,25W
3308	4822 051 10102	1k	2%	0,25W
3309	4822 051 20104	100k	5%	0,1W
3310	4822 051 20104	100k	5%	0,1W
3311	4822 051 20471	470R	5%	0,1W
3312	4822 051 20471	470R	5%	0,1W
3315	4822 051 20182	1k8	5%	0,1W
3316	4822 051 20182	1k8	5%	0,1W
3317	4822 051 20472	4k7	5%	0,1W
3318	4822 051 20472	4k7	5%	0,1W
3319	4822 051 20473	47k	5%	0,1W
3320	4822 051 20473	47k	5%	0,1W
3321	4822 051 20682	6k8	5%	0,1W
3322	4822 051 20223	22k	5%	0,1W
3323	4822 051 20104	100k	5%	0,1W
3324	4822 051 20184	180k	5%	0,1W
3325	4822 051 20104	100k	5%	0,1W
3327	4822 051 20105	1M	5%	0,1W
3328	4822 051 20123	12k	2%	0,1W
3329	4822 051 20103	10k	5%	0,1W
3330	4822 051 20471	470R	5%	0,1W
3331	4822 051 20335	3M3	5%	0,1W
3332	4822 051 20474	470k	5%	0,1W
3333	4822 051 20472	4k7	5%	0,1W
3334	4822 051 20332	3k3	5%	0,1W
3335	4822 051 20683	68k	5%	0,1W
3336	4822 051 20683	68k	5%	0,1W
3337	4822 051 20105	1M	5%	0,1W
3338	4822 051 20105	1M	5%	0,1W
3339	4822 051 20105	1M	5%	0,1W
3340	4822 051 20105	1M	5%	0,1W
3341	4822 051 20104	100k	5%	0,1W
3343	4822 051 10102	1k	2%	0,25W
3344	4822 051 10102	1k	2%	0,25W
3345	4822 051 20332	3k3	5%	0,1W

CHIP RESISTORS

3346	4822 051 20471	470R	5%	0,1W
3350	4822 051 20823	82k	5%	0,1W
3351	4822 051 20123	12k	2%	0,1W
3352	4822 051 20152	1k5	5%	0,1W
3353	4822 051 20222	2k2	5%	0,1W
3354	4822 051 20331	330R	5%	0,1W
3355	4822 051 20471	470R	5%	0,1W
3356	4822 051 20104	100k	5%	0,1W
3357	4822 051 20224	220k	5%	0,1W
3358	4822 051 20105	1M	5%	0,1W
3359	4822 051 20471	470R	5%	0,1W
3360	4822 051 20008	CHIP JUMPER 1206		
3390	4822 051 20008	CHIP JUMPER 1206		
3391	4822 051 20008	CHIP JUMPER 1206		
3393	4822 051 20008	CHIP JUMPER 1206		
3394	4822 051 20008	CHIP JUMPER 1206		
3800	4822 051 20154	150k	5%	0,1W
3801	4822 051 10102	1k	2%	0,25W
3803	4822 051 20153	15k	5%	0,1W
3804	4822 051 20154	150k	5%	0,1W
3805	4822 051 20472	4k7	5%	0,1W
3806	4822 100 11733	20k TRIM POT SMD		
3807	4822 051 20332	3k3	5%	0,1W
3808	4822 100 11733	20k TRIM POT SMD		
3809	4822 051 20222	2k2	5%	0,1W
3810	4822 051 20478	4R7	5%	0,1W
3811	4822 051 20473	47k	5%	0,1W
3812	4822 100 11733	20k TRIM POT SMD		
3813	4822 051 20684	680k	5%	0,1W
3814	4822 100 11733	20k TRIM POT SMD		
3815	4822 051 20224	220k	5%	0,1W
3816	4822 051 20473	47k	5%	0,1W
3817	4822 051 20823	82k	5%	0,1W
3818	4822 051 10102	1k	2%	0,25W
3819	4822 051 20473	47k	5%	0,1W
3820	4822 051 20821	820R	5%	0,1W
3822	4822 051 20882	6k8	5%	0,1W
3823	4822 051 20563	56k	5%	0,1W
3824	4822 051 20391	390R	5%	0,1W
3825	4822 051 20273	27k	5%	0,1W
3826	4822 051 20823	82k	5%	0,1W
3827	4822 051 20562	5k6	5%	0,1W
3828	4822 051 20183	18k	5%	0,1W
3829	4822 051 20222	2k2	5%	0,1W
3830	4822 051 20222	2k2	5%	0,1W
3831	4822 051 20103	10k	5%	0,1W
3832	4822 051 20822	8k2	5%	0,1W
3833	4822 051 20821	820R	5%	0,1W
3834	4822 051 20393	39k	5%	0,1W
3837	4822 051 20222	2k2	5%	0,1W
3838	4822 051 20182	1k8	5%	0,1W
3841	4822 051 20478	4R7	5%	0,1W
3842	4822 051 20229	22R	5%	0,1W
3845	4822 051 20478	4R7	5%	0,1W
3848	4822 051 20103	10k	5%	0,1W
3851	4822 051 20223	22k	5%	0,1W
3852	4822 051 20223	22k	5%	0,1W
3853	4822 051 20751	750R	5%	0,1W
3854	4822 051 20105	1M	5%	0,1W
3855	4822 051 20223	22k	5%	0,1W
3856	4822 051 20223	22k	5%	0,1W
3857	4822 051 20223	22k	5%	0,1W
3858	4822 051 20471	470R	5%	0,1W

CHIP RESISTORS

3859	4822 051 20473	47k	5%	0,1W
3860	4822 051 20104	100k	5%	0,1W
3861	4822 051 20223	22k	5%	0,1W
3862	4822 051 20474	470k	5%	0,1W
3863	4822 051 20223	22k	5%	0,1W
3864	4822 051 20224	220k	5%	0,1W
3865	4822 051 20124	120k	5%	0,1W
3866	4822 051 20563	56k	5%	0,1W
3867	4822 051 20223	22k	5%	0,1W
3868	4822 051 20223	22k	5%	0,1W
3869	4822 051 20223	22k	5%	0,1W
3870	4822 051 20223	22k	5%	0,1W
3871	4822 051 20683	68k	5%	0,1W
3872	4822 051 20223	22k	5%	0,1W
3873	4822 051 20223	22k	5%	0,1W
3874	4822 051 20223	22k	5%	0,1W
3875	4822 051 20223	22k	5%	0,1W
3876	4822 051 20223	22k	5%	0,1W
3877	4822 051 20474	470k	5%	0,1W
3878	4822 051 20475	4M7	5%	0,1W
3879	4822 051 20223	22k	5%	0,1W
3880	4822 051 20123	12k	2%	0,1W
3881	4822 051 20823	82k	5%	0,1W
3882	4822 051 20153	15k	5%	0,1W
3883	4822 051 20153	15k	5%	0,1W
3884	4822 051 20103	10k	5%	0,1W
3885	4822 051 20334	330k	5%	0,1W
3886	4822 051 20223	22k	5%	0,1W
3887	4822 051 20332	3k3	5%	0,1W
3888	4822 051 20103	10k	5%	0,1W
3889	4822 051 20154	150k	5%	0,1W
3890	4822 051 20104	100k	5%	0,1W
3891	4822 051 20101	100R	5%	0,1W
3892	4822 051 20564	560k	5%	0,1W
3893	4822 051 20475	4M7	5%	0,1W
3896	4822 051 20008	CHIP JUMPER 1206		
3608	4822 051 20103	10k	5%	0,1W
3609	4822 051 20222	2k2	5%	0,1W
3610	4822 051 20222	2k2	5%	0,1W
3611	4822 051 20222	2k2	5%	0,1W
3612	4822 051 20473	47k	5%	0,1W
3613	4822 051 20104	100k	5%	0,1W
3622	4822 051 20473	47k	5%	0,1W
3623	4822 051 20335	3M3	5%	0,1W
3624	4822 051 20474	470k	5%	0,1W
3625	4822 051 20224	220k	5%	0,1W
3626	4822 051 20105	1M	5%	0,1W
3627	4822 051 20335	3M3	5%	0,1W
3628	4822 051 20008	CHIP JUMPER 1206		
3629	4822 051 20008	CHIP JUMPER 1206		
3630	4822 051 20103	10k	5%	0,1W
3631	4822 051 20103	10k	5%	0,1W
3632	4822 051 20683	68k	5%	0,1W
3633	4822 051 20683	68k	5%	0,1W
3634	4822 051 20753	75k	5%	0,1W
3636	4822 051 20392	3k9	5%	0,1W
3638	4822 051 20182	1k8	5%	0,1W
3639	4822 051 20182	1k8	5%	0,1W
3640	4822 051 20273	27k	5%	0,1W
3641	4822 051 20273	27k	5%	0,1W
3642	4822 051 20103	10k	5%	0,1W
3643	4822 051 20103	10k	5%	0,1W
3644	4822 051 20203	20k	5%	0,1W

CHIP RESISTORS

3645	4822 051 20203	20k	5%	0,1W
3646	4822 051 20103	10k	5%	0,1W
3647	4822 051 20103	10k	5%	0,1W
3648	4822 051 20122	1,2k	5%	0,1W
3649	4822 051 20122	1,2k	5%	0,1W
3650	4822 051 20113	11k	5%	0,1W
3651	4822 051 20113	11k	5%	0,1W
3652	4822 051 20472	4k7	5%	0,1W
3653	4822 051 20472	4k7	5%	0,1W
3654	4822 051 20183	18k	5%	0,1W
3655	4822 051 20183	18k	5%	0,1W
3656	4822 051 20123	12k	2%	0,1W
3657	4822 051 20123	12k	2%	0,1W
3658	4822 051 20183	18k	5%	0,1W
3659	4822 051 20183	18k	5%	0,1W
3660	4822 051 20103	10k	5%	0,1W
3661	4822 051 20103	10k	5%	0,1W
3662	4822 051 20122	1,2k	5%	0,1W
3663	4822 051 20122	1,2k	5%	0,1W
3664	4822 051 20103	10k	5%	0,1W
3665	4822 051 20103	10k	5%	0,1W
3666	4822 051 20104	100k	5%	0,1W
3667	4822 051 20104	100k	5%	0,1W
3668	4822 051 20101	100R	5%	0,1W
3669	4822 051 20101	100R	5%	0,1W
3670	4822 051 20104	100k	5%	0,1W
3671	4822 051 20104	100k	5%	0,1W
3673	4822 051 20008	CHIP JUMPER 1206		
3674	4822 051 20103	10k	5%	0,1W
3675	4822 051 20103	10k	5%	0,1W
3676	4822 100 11826	470k TRIMPOT		
3677	4822 100 11826	470k TRIMPOT		
3678	4822 051 20335	3M3	5%	0,1W
3679	4822 051 20335	3M3	5%	0,1W
3680	4822 051 20223	22k	5%	0,1W
3681	4822 051 20223	22k	5%	0,1W
3682	4822 051 20105	1M	5%	0,1W
3683	4822 051 20223	22k	5%	0,1W
3684	4822 051 20335	3M3	5%	0,1W
3685	4822 100 11825	47k	25%	0,15W
3686	4822 051 20182	1k8	5%	0,1W
3687	4822 051 20682	6k8	5%	0,1W
3688	4822 051 20683	68k	5%	0,1W
3689	4822 051 20682	6k8	5%	0,1W
3690	4822 051 20183	18k	5%	0,1W
3691	4822 051 20472	4k7	5%	0,1W
3692	4822 051 20332	3k3	5%	0,1W
3693	4822 051 20109	10R	5%	0,1W
3694	4822 051 20109	10R	5%	0,1W
3695	4822 051 20222	2k2	5%	0,1W
3696	4822 051 20512	5k1	5%	0,1W
3697	4822 051 20152	1k5	5%	0,1W
3698	4822 051 20242	2k4	5%	0,1W
3699	4822 051 20103	10k	5%	0,1W
3901	4822 051 20221	220R	5%	0,1W
3902	4822 051 20105	1M	5%	0,1W
3903	4822 051 20123	12k	2%	0,1W
3904	4822 051 20152	1k5	5%	0,1W
3905	4822 051 20479	47R	5%	0,1W
3906	4822 051 20479	47R	5%	0,1W
3907	4822 051 20479	47R	5%	0,1W
3908	4822 051 20479	47R	5%	0,1W
3909	4822 051 20479	47R	5%	0,1W

CHIP RESISTORS

3910	4822 051 20479	47R	5%	0,1W
3950	4822 051 20334	330k	5%	0,1W
3951	4822 051 20683	68k	5%	0,1W
3952	4822 051 20224	220k	5%	0,1W
3953	4822 051 20474	470k	5%	0,1W
3954	4822 051 20335	3M3	5%	0,1W
3955	4822 051 20104	100k	5%	0,1W
3956	4822 051 20105	1M	5%	0,1W
CAPACITORS				
2250	4822 124 42241	100µF	20%	6,3V
2275	5322 122 33446	3,3nF	10%	63V
2276	5322 122 33446	3,3nF	10%	63V
2283	4822 122 33064	330nF	20%	25V
2284	4822 122 33064	330nF	20%	25V
2289	4822 122 33064	330nF	20%	25V
2290	4822 122 33064	330nF	20%	25V
2291	4822 124 42241	100µF	20%	6,3V
2292	4822 124 42241	100µF	20%	6,3V
2302	4822 122 33064	330nF	20%	25V
2306	4822 124 42241	100µF	20%	6,3V
2307	4822 124 42241	100µF	20%	6,3V
2309	4822 124 42241	100µF	20%	6,3V
2312	4822 122 33064	330nF	20%	25V
2352	4822 124 42242	330µF	20%	6,3V
2356	4822 124 42242	330µF	20%	6,3V
2359	4822 122 31746	1nF	5%	50V
2803	4822 122 33064	330nF	20%	25V
2819	4822 124 42241	100µF	20%	6,3V
2828	4822 122 31746	1nF	5%	50V
2846	4822 124 42242	330µF	20%	6,3V
2856	4822 122 32444	33pF	5%	50V
2858	4822 124 42241	100µF	20%	6,3V
2860	4822 124 42241	100µF	20%	6,3V
2866	4822 124 42241	100µF	20%	6,3V
2867	4822 122 33064	330nF	20%	25V
2868	4822 122 33064	330nF	20%	25V
2634	4822 122 31746	1nF	5%	50V
2635	4822 122 31746	1nF	5%	50V
2648	4822 122 33064	330nF	20%	25V
2649	4822 122 33064	330nF	20%	25V
2652	4822 122 33064	330nF	20%	25V
2653	4822 122 33064	330nF	20%	25V
2661	4822 124 42257	47µF	20%	6,3V
2802	4822 122 33064	330nF	20%	25V
CHIP CAPACITORS				
2251	4822 122 31765	100pF	5%	50V
2263	4822 122 33496	100nF	10%	63V
2277	4822 124 10965	2,2µF	20%	6,3V
2278	4822 124 10965	2,2µF	20%	6,3V
2279	5322 122 31648	12nF	10%	50V
2280	5322 122 31648	12nF	10%	50V
2281	4822 122 31797	22nF	10%	63V
2282	4822 122 31797	22nF	10%	63V
2285	4822 122 31784	4,7nF	10%	50V
2286	4822 122 31784	4,7nF	10%	50V
2287	4722 122 32856	8,2nF	10%	63V
2288	4822 122 32856	8,2nF	10%	63V
2295	4822 122 31784	4,7nF	10%	50V
2296	4822 122 31784	4,7nF	10%	50V
2300	4822 122 32927	220nF	10%	63V
2301	4822 122 32891	68nF	10%	63V

CHIP CAPACITORS

2303	4822 122 33496	100nF	10%	63V
2304	4822 124 10965	2,2µF	20%	6,3V
2305	4822 122 31965	220pF	5%	
2308	4822 122 33496	100nF	10%	63V
2310	4822 122 32927	220nF	10%	63V
2311	4822 122 31782	15nF	10%	50V
2351	4822 122 33496	100nF	10%	63V
2353	4822 124 10965	2,2µF	20%	6,3V
2354	4822 122 31644	2,2nF	10%	63V
2355	4822 122 31644	2,2nF	10%	63V
2357	4822 124 10965	2,2µF	20%	6,3V
2358	4822 122 33496	100nF	10%	63V
2800	4822 122 31769	18pF	5%	50V
2801	4822 124 10965	2,2µF	20%	6,3V
2802	4822 122 31797	22nF	10%	63V
2805	4822 122 33496	100nF	10%	63V
2807	4822 122 32442	10nF	10%	50V
2808	4822 122 31916	5,6nF	10%	63V
2809	4822 122 32891	68nF	10%	63V
2810	4822 122 32142	270pF	5%	63V
2811	4822 122 31784	4,7nF	10%	50V
2812	4822 126 11499	180nF	20%	50V
2813	4822 122 32542	47nF	10%	63V
2816	4822 122 31768	180pF	5%	50V
2817	4822 122 32442	10nF	10%	50V
2818	4822 122 31782	15nF	10%	50V
2820	4822 122 32442	10nF	10%	50V
282				

CHIP CAPACITORS

2669	5322	122 31647	1nF	10%	63V
2610	5322	124 10802	10µF	20%	4V
2628	4822	126 11692	1µF	20%	16V
2629	4822	126 11692	1µF	20%	16V
2630	4822	126 11692	1µF	20%	16V
2631	4822	126 11692	1µF	20%	16V
2632	4822	122 32765	820pF	10%	63V
2633	4822	122 32765	820pF	10%	63V
2636	5322	122 31863	330pF	5%	50V
2637	5322	122 31863	330pF	5%	50V
2638	4822	124 10965	2,2µF	20%	6,3V
2639	4822	124 10965	2,2µF	20%	6,3V
2640	4822	122 32999	2,2nF	5%	
2641	4822	122 32999	2,2nF	5%	
2644	4822	122 33515	82pF	5%	50V
2645	4822	122 33515	82pF	5%	50V
2646	4822	122 32999	2,2nF	5%	
2647	4822	122 32999	2,2nF	5%	
2650	4822	126 11912	47nF	20%	63V
2651	4822	126 11912	47nF	20%	63V
2654	5322	122 34123	1nF	10%	50V
2655	5322	122 34123	1nF	10%	50V
2656	4822	126 11912	47nF	20%	63V
2657	4822	126 11912	47nF	20%	63V
2662	5322	124 10801	4,7µF	4V	
2664	5322	116 80853	560pF	5%	63V
2665	4822	122 32765	820pF	10%	63V
2666	5322	122 32531	100pF	5%	50V
2667	4822	126 11692	1µF	20%	16V
2668	4822	122 33177	10nF	20%	50V
2669	4822	126 11918	15pF	5%	
2669	4822	126 11908	39pF	5%	for /17
2669	4822	126 11916	100pF	5%	for /18
2670	4822	126 11911	6,8pF	5%	
2670	4822	126 11909	5,6pF	10%	for /18
2671	5322	122 32447	1pF	5%	50V
2671	12 NC	for /18 follows			
2672	5322	122 33537	1,2pF	5%	63V
2673	4822	125 50605	TRIMCAP 2,5p-6p		
2674	4822	125 50605	TRIMCAP 2,5p-6p		
2675	5322	122 32659	33pF	5%	50V
2676	5322	122 32659	33pF	5%	50V
2677	4822	126 11199	56pF	5%	50V
2677	4822	126 11907	33pF	5%	for /17
2677	4822	126 11153	47pF	5%	for /18
2678	4822	122 33177	10nF	20%	50V
2679	5322	122 32448	10pF	5%	50V
2680	5322	122 34123	1nF	10%	50V
2681	5322	124 10802	10µF	20%	4V
2682	5322	122 32966	39pF	5%	50V
2683	5322	122 32966	39pF	5%	50V
2684	5322	122 33537	1,2pF	5%	63V
2684	5322	122 33244	8,2pF	5%	for /18
2690	4822	122 33496	100nF	10%	63V
2691	4822	122 33496	100nF	10%	63V
2692	4822	124 10965	2,2µF	20%	6,3V
2693	5322	122 32654	22nF	10%	63V
2694	4822	122 33496	100nF	10%	63V
2695	4822	126 11907	33pF	5%	63V
2695	4822	126 11906	27pF	5%	for /17
2696	4822	122 33177	10nF	20%	50V
2697	4822	126 11692	1µF	20%	16V
2698	4822	126 11692	1µF	20%	16V

CHIP CAPACITORS

2900	4822	122 32482	22pF	5%	63V
2901	4822	122 32482	22pF	5%	63V
2903	4822	122 33496	100nF	10%	63V
2904	4822	122 33177	10nF	20%	50V